

PHILIPS

NeoPix 750 Smart

Digital Projector

User Manual



Register your product and get support at
www.philips.com/support

Table of contents

Introduction	3	6 Play media from USB storage devices	18
Dear customer	3	Connect a USB storage device	18
About this user manual	3	Play videos	19
What's in the box	3	Play audios	19
Customer service center	3	View images	19
1 General safety information	4	7 Wireless projection	20
Setting up the product	4	Wireless projection with Android devices/ Windows computers	20
Repairs	4	Wireless projection with iOS devices/Mac computers	20
Power supply	5	Stream videos/pictures from iOS devices	21
2 Overview	5	8 Change projector settings	21
Top view	5	Change settings using the sidebar	21
Front view	6	Change more settings	22
Rear view	6	Change settings using the settings menu	23
Bottom view	6	9 Maintenance	26
Remote control	6	Cleaning	26
3 Initial setup	7	Update software	26
Install the projector.....	7	10 Troubleshooting	27
Connect to power supply	8	11 Appendixes	29
Prepare the remote control	9	Technical data	29
Power on and set up the projector	9	CE statement	30
Set up the projector system	10	FCC statement	30
4 Use the Home screen	12	Canada regulatory compliance	30
Navigate the Home screen	12	Other notice.....	31
Open and configure apps	13		
5 Connect to other devices	14		
Connect to a USB mouse, keyboard or gamepad	14		
Connect to a playback device through HDMI™	15		
Connect to an audio system through HDMI™ ARC.....	15		
Connect to a dongle.....	15		
Connect to a playback device through USB-C	16		
Connect to a Bluetooth device.....	16		
Connect to wired speakers or headphones.....	18		

Introduction

Dear customer

Thank you for purchasing this projector.
We hope you enjoy this product and the many functions it offers!

About this user manual

The quick start guide supplied with this product allows you to start using this product quickly and easily. Detailed descriptions can be found in the following sections of this user manual.

Read the entire user manual carefully. Follow all safety instructions in order to ensure proper operation of this product (see **General safety information, page 4**). The manufacturer accepts no liability if these instructions are not followed.

Symbols used

Notice

i This symbol indicates tips that will help you use this product more effectively and easily.

DANGER!



Danger of personal injury!

This symbol gives warning of danger of personal injury. Physical injury or damage can result from improper handling.

CAUTION!



Damage to the product or loss of data!

This symbol gives warning of damage to the product and possible loss of data. Damage can result from improper handling.

What's in the box

- 1 NeoPix 750 projector
- 2 Remote control
- 3 AAA batteries x 2
- 4 Quick Start Guide with Warranty Card
- 5 AC power cables with plugs x 3

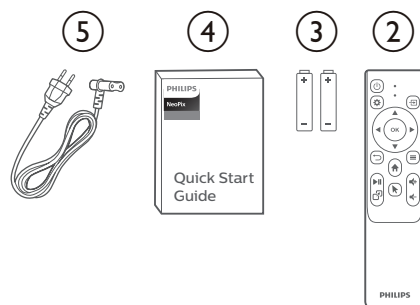
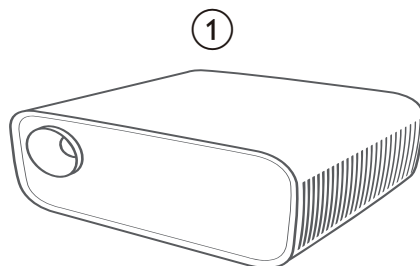

Customer service center

The Support page, warranty card, and user manuals can be found here:

Web: www.philips.com/support

Support Contacts:

International Phone: +41 215 391 665

Please ask your provider for international call costs!

Mail: philips.projector.eu@screeneo.com

Access our FAQ websites:

<https://support.philipsprojection.com>

<https://community.philipsprojection.com>

1 General safety information

Take note of all warning and safety notes indicated. Do not make any changes or settings that are not described in this user manual. Incorrect operation, and improper handling can lead to physical injury, damage to the product or loss of data.

Setting up the product

This product is for indoor use only. Place the product securely on a stable, flat surface. To help avoid possible injuries to persons or damage to the product itself, position all cables in such a way that no one will trip over them.

Do not operate the product in damp rooms. Never touch the mains cable or the mains connection with wet hands.

Never operate the product immediately after moving it from a cold location to a hot location. When the product is exposed to such a change in temperature, moisture may condense on the crucial internal parts.

The product must have sufficient ventilation and must not be covered. Do not put the product in closed cabinets, boxes, or other enclosures when in use.

Protect the product from direct sunlight, heat, intense temperature fluctuations and moisture. Do not place the product in the vicinity of heaters or air conditioners. Observe the information on temperature listed in the technical data (see **Technical data, page 29**).

Prolonged operation of the product causes the surface to become hot. In case of overheating, the product automatically switches to standby mode.

Do not allow liquids to leak into the product. Turn off the product and disconnect it from the mains supply if liquids or foreign substances leaked into the product. Have the product inspected by an authorised service center.

Always handle the product with care. Avoid touching the lens. Never place heavy or sharp objects on the product or on the power cable.

If the product gets too hot or emits smoke, shut it down immediately and unplug the power cable. Have your product checked by an authorised service center. Keep the product away from open flames (e.g. candles).

! DANGER!



Risk of explosion with incorrect type of batteries!

There is a risk of explosion if the wrong battery type is used.

Do not expose the batteries (battery pack or embedded batteries) to excessive heat such as sunshine, or open fire.

Under the following conditions, a layer of moisture can appear inside the product which can lead to malfunctions:

- if the product is moved from a cold to a warm area;
- after a cold room is heated;
- when the product is placed in a damp room.

Proceed as follows to avoid any moisture buildup:

- 1 Seal the product in a plastic bag before moving it to another room, in order for it to adapt to room conditions.
- 2 Wait one to two hours before you take the product out of the plastic bag.

The product should not be used in a very dusty environment. Dust particles and other foreign objects may damage the product.

Do not expose the product to extreme vibrations. This may damage the internal components.

Do not allow children to handle the product without supervision. The packing materials should be kept out of the hands of children.

For your own safety, do not use the product during thunderstorms with lightning.

Repairs

Do not repair the product yourself. Improper maintenance can result in injuries or damage to the product. The product must be repaired by an authorised service center.

Please find the details of authorised service centers on the warranty card supplied with this product.

Do not remove the type label from this product, as this will void the warranty.

Power supply

Use only a power adapter which is certified for this product (see **Technical data, page 29**). Check whether the mains voltage of the power supply matches the mains voltage available at the setup location. This product complies with the voltage type specified on the product.

The power outlet shall be installed near the product and shall be easily accessible.

CAUTION!



Always use the  button to turn the projector off.

Turn off the product and unplug from the power outlet before cleaning the surface (see **Cleaning, page 26**). Use a soft, lint-free cloth. Never use liquid, gaseous or easily flammable cleaners (sprays, abrasives, polishes, alcohol). Do not allow any moisture to reach the interior of the product.

DANGER!





Risk of eye irritation!

This product is equipped with a high power LED (Light Emitting Diode), which emits very bright light. Do not look directly into the projector lens during operation. This could cause eye irritation or damage.

2 Overview

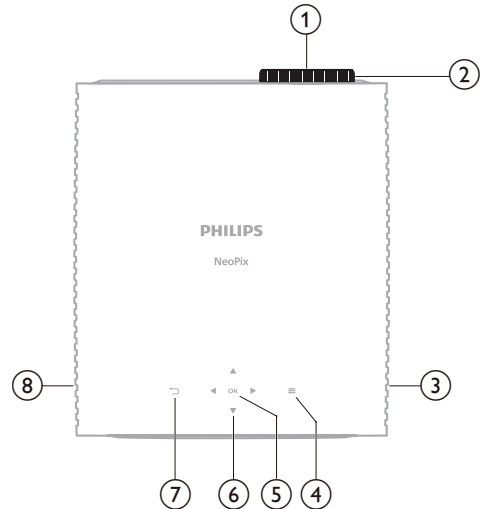
Top view



- ① **Projection lens**
- ② **Focus adjustment knob**
Adjust image sharpness.
- ③ **Right speaker**
- ④ 
- ⑤ **OK**
Open or close the settings menu.
Confirm a selection or change the value for the current setting.
- ⑥ **Navigation buttons (Up, Down, Left, Right)**
 - Navigate items on the screen.
 - Press ▲/▼ or ◀/▶ to change the value for the current setting.
- ⑦ 
- Return to the previous screen.
- Open or close the sidebar from the Home screen.
- ⑧ **Left speaker**

Front view

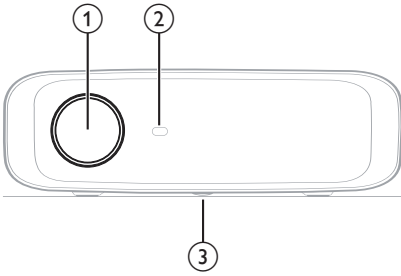

- ① **Projection lens**
- ② **Front IR sensor**
- ③ **Angle adjustment knob**
Turn the knob to adjust screen height.

Rear view

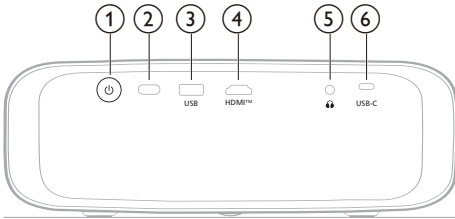

- ① **Power**
 - Switch the projector on or to standby mode.
 - When the projector is on, the LED lights up in white.
 - When the projector is in standby mode, the LED lights up in red.
- ② **Rear IR sensor**
- ③ **USB**
Connect to a USB input device, USB storage device or dongle.
- ④ **HDMI™**
Connect to an HDMI™ output port on a playback device.
- ⑤ **Audio**
3.5 mm audio output; connect to external speakers or headphones.
- ⑥ **USB-C**
Connect to a USB-C port on a playback device.

Bottom view

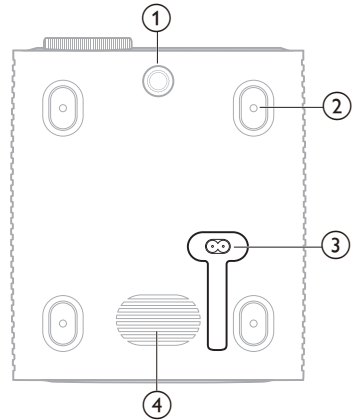

- ① **Angle adjustment knob**
Turn the knob to adjust screen height.
- ② **Screw hole for ceiling mount**
- ③ **AC power jack**
Connect to a supplied power cable.
- ④ **Subwoofer**

Remote control

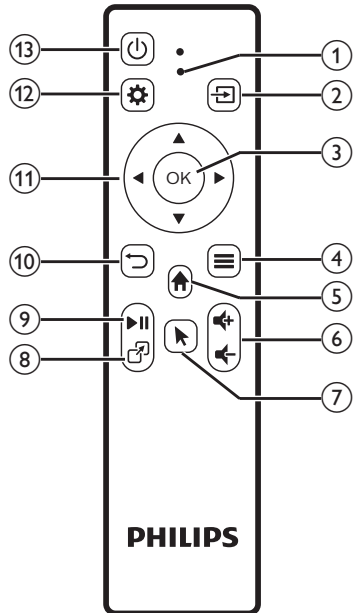

① LED indicator

Light up when you press a button on the remote control.

- Light up in red when the remote control is not connected to the projector via Bluetooth.
- Light up in blue when the remote control is connected to the projector via Bluetooth.
- Always light up in red when the projector is off.

②

Display all the input sources and allow you to switch to a different one.

③ OK

Confirm a selection or change the value for the current setting.

④

- Open the options menu when an app is selected on the Home screen.
- Open the more options menu when a video is playing.

⑤

Access the Home screen of the built-in operating system.

⑥

Increase or decrease the volume.

⑦

Enable or disable the on-screen pointer when the remote control is connected to the projector via Bluetooth.

⑧

Display the list of most recently opened apps and allow you to switch between them. The list can contain up to 8 apps.





⑨

Start, pause or resume media playback.

⑩

- Return to the previous screen.
- Open or close the sidebar from the Home screen.

⑪ Navigation buttons (Up, Down, Left, Right)

- Navigate items on the screen.
- Press / or / to change the value for the current setting.

⑫

Open or close the settings menu.

⑬

Switch the projector on or to standby mode.

3 Initial setup

Notice

 Make sure all devices are disconnected from their power supplies before establishing or changing any connections.

Install the projector

You can install the projector in four different ways. Follow the guidelines below to correctly install the projector.

Notice

 For overhead mounting on ceiling, purchase a projector mount recommended by an installation professional and follow the instructions that come with the mount.

Before mounting on the ceiling, make sure the ceiling can support the weight of the projector and mounting kit.

For ceiling installation, this product must be securely attached to the ceiling in accordance with the installation instructions. An improper ceiling installation may result in accident, injury or damage.

We recommend that you hire an installation professional to complete the mounting for you.

Front

- 1 Place the projector on a flat surface such as a table in front of the projection surface. This is the most common way to position the projector for quick setup and portability.

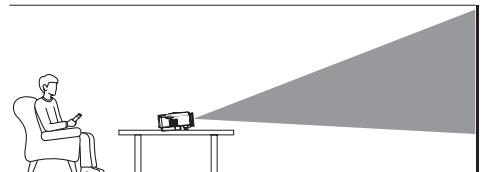

- 2 If the projection direction is incorrect, from the Home screen, open the sidebar by pressing  on the remote control. Then select *Image > Projection Direction > Front*.

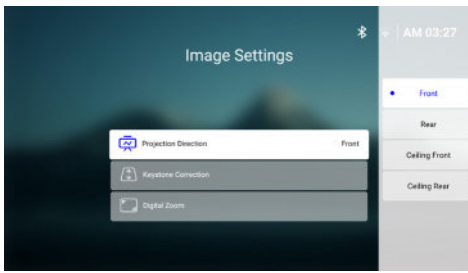

Ceiling Front

- 1 Mount the projector on the ceiling with upside up in front of the projection screen. A projector mount is required to mount the projector on ceiling.

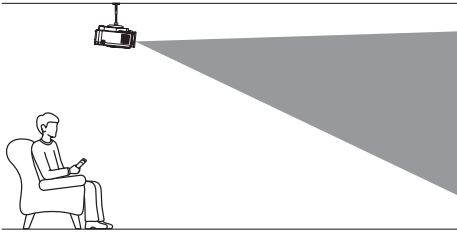

- 2 From the Home screen, open the sidebar by pressing **↵** on the remote control. Then select *Image > Projection Direction > Ceiling Front*.

Rear

- 1 Place the projector on a table behind the projection screen. A special rear projection screen is required.

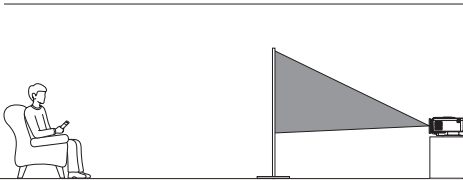

- 2 From the Home screen, open the sidebar by pressing **↵** on the remote control. Then select *Image > Projection Direction > Rear*.

Ceiling Rear

- 1 Mount the projector on ceiling with upside up behind the projection screen. To mount the projector on ceiling behind the screen, a projector mount and a special rear projection screen are required.

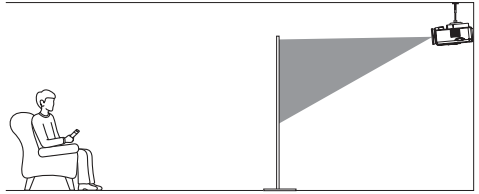

- 2 From the Home screen, open the sidebar by pressing **↵** on the remote control. Then select *Image > Projection Direction > Ceiling Rear*.

Connect to power supply

CAUTION!

- i** Always use the **⏻** button to turn the projector on and off.

- 1 Select a supplied power cable with the correct power plug (EU/UK/US).
- 2 Connect the power cable to the power jack at the bottom of the projector.
- 3 Connect the power cable to an electrical socket.
 - The power LED on the projector lights up in red.

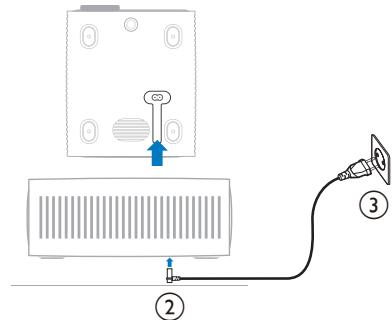

Prepare the remote control

CAUTION!

i The improper use of batteries can lead to overheating, explosion, risk of fire and injury. Leaking batteries can possibly damage the remote control.

Never expose the remote control to direct sunlight.

Avoid deforming, dismantling or charging the batteries.

Avoid exposure to open fire and water.

Replace empty batteries immediately.

Remove the batteries from the remote control if not in use for long periods of time.

- 1 Open the battery compartment.
- 2 Insert the supplied batteries (type AAA) with correct polarity (+/-) indicated.
- 3 Close the battery compartment.

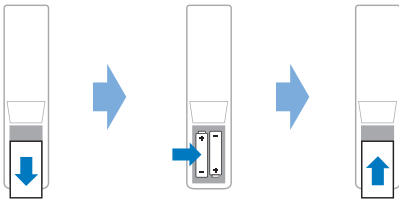

- When using a remote control with infrared signals, point the remote control at the IR sensor on the projector, and make sure there is no obstacle between the remote control and the IR sensor.

Power on and set up the projector

Power on/off the projector

- To turn on the projector, press  on the projector/remote control. The power LED on the projector turns from red to white.



- To turn off the projector, press and hold  on the projector/remote control for 2 seconds or press this button twice. The projector enters standby mode and its power LED turns from white to red.
- To fully shut down the projector, disconnect the power cable from the electrical socket.

Image focus adjustment

To adjust the image focus (sharpness), turn the focus adjustment knob attached to the projection lens.

Tip: If you change the projection distance later, you'll need to adjust the image focus again.



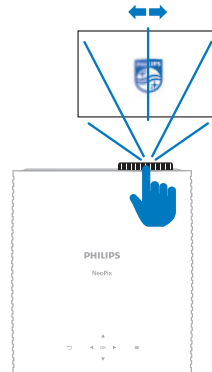

Screen size adjustment

The projection screen size (or size of images) is determined by the distance between the lens of the projector and the projection surface.

This projector has a recommended projection distance of 367 cm (144"), and thus creates a maximum screen size of 120" (305 cm). The minimum distance from the projection surface is 175 cm (69").

Digital zooming

You can use the digital zooming function to reduce the screen size.

- 1 From the Home screen, open the sidebar by pressing  on the remote control. Then select *Digital Zoom*.
- 2 Press / to adjust the screen size. You can scale down the screen to up to 60% of its full size.

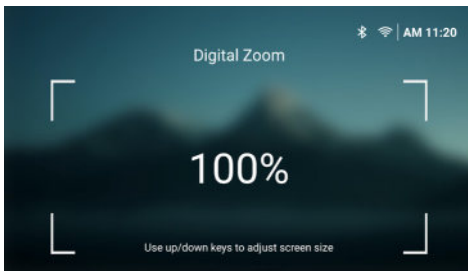

Screen height adjustment

To adjust the screen height when placing the projector on a flat surface, turn the angle adjustment knob located at the bottom of the projector.

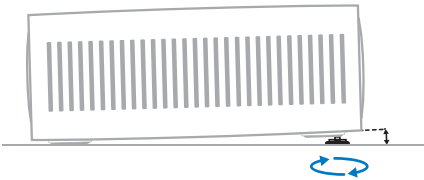
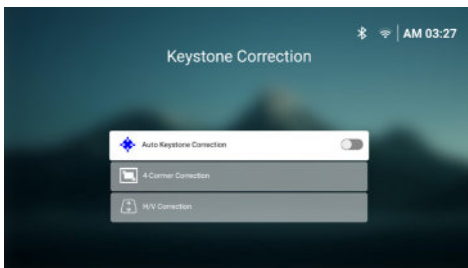

Image shape adjustment

Auto keystone correction

You can turn on auto keystone correction to let the projector automatically make the image rectangular.

- 1 From the Home screen, open the sidebar by pressing **↵** on the remote control. Then select *Keystone > Auto Keystone Correction*.
- 2 Press the **OK** button to turn auto keystone correction on or off.



H/V Correction (manual)

When auto keystone correction is off, you can manually make the image rectangular by adjusting the horizontal and vertical keystone angles.

- 1 From the Home screen, open the sidebar by pressing **↵** on the remote control. Then select *Keystone > H/V Correction*.
- 2 Follow the on-screen instructions to adjust the image shape.

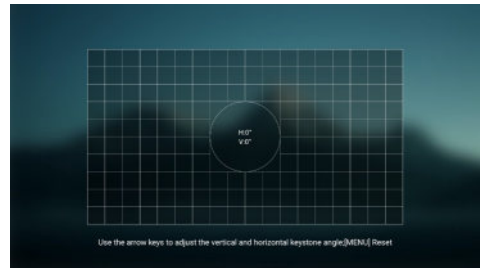

4-Corner Correction (manual)

When auto keystone correction is off, you can manually make the image rectangular by moving four corners of the image.

- 1 From the Home screen, open the sidebar by pressing **↵** on the remote control. Then select *Keystone > 4-Corner Correction*.
- 2 Follow the on-screen instructions to adjust the image shape.

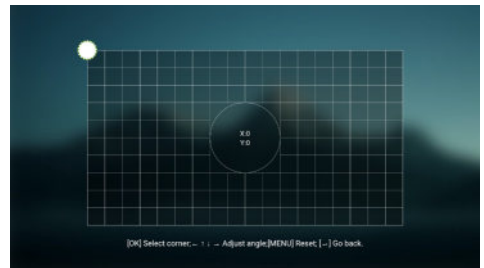

Set up the projector system

When you turn on the projector for the first time or after it was reset to its factory default settings, the projector system will start and prompt you to set it up by making some basic settings.

After the setup, you can start using the projector or continue to make other adjustments.

Step 1: Select the language and time zone

On the *Welcome* screen, press the **OK** button on the remote control. Then use the navigation buttons and **OK** button to make changes.

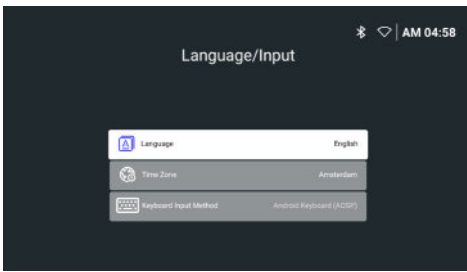

- **Language:** Select your preferred display language.
- **Time Zone:** Set the time zone used by the projector by selecting a city.
- **Keyboard Input Method:** Select your preferred on-screen keyboard or input method.

Note: The default display language is **English** and not all languages are available.

When you are done, press **↩** to return to the *Welcome* screen and press the **OK** button to go to the next step.

Step 2: Connect the remote control via Bluetooth

Follow the on-screen instructions to connect the remote control to the projector via Bluetooth. After making the connection, you can use the on-screen pointer to navigate the on-screen user interface of the projector.

Tip: To enable or disable the on-screen pointer, press **⌂** on the remote control.

When you are done, press the **OK** button to go to the next step.

Step 3: Connect to a Wi-Fi network

- 1 Press the **OK** button on the remote control to open the *Wireless Network* screen. **Tip:** Step 3 is optional. You may skip to Step 4 by selecting *Next* and pressing the **OK** button.

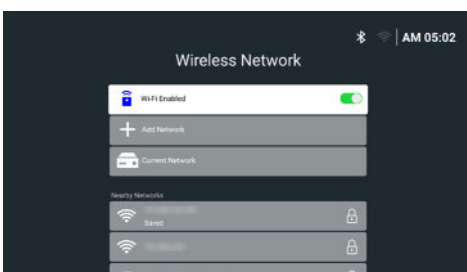

- 2 Select a network from the list under *Nearby Networks* and press the **OK** button. You are prompted to enter the password for connecting to the network using the on-screen keyboard.
- 3 Enter the password by pressing the navigation buttons and **OK** button. **Tips:** Press and hold a navigation button to move to the key you want more quickly. You can also enter the password using the on-screen pointer and **OK** button.
- 4 Select the green check mark on the keyboard and press the **OK** button.
- 5 Wait a few seconds for the connection to be established. After the connection is established, the connected Wi-Fi network's name appears after *Current Network* and the Wi-Fi icon in the upper-right corner of the screen turns bright white.

Notes:

- If you connect to an open (unsecured) Wi-Fi network, you won't be prompted to enter the password and the connection will be automatically established.
- The next time you turn on the projector, it will automatically try to reconnect to the last connected Wi-Fi network, unless you manually disconnect/forget the network or factory reset the projector.

When you are done, press **↩** to return to the previous screen and press the **OK** button to go to the next step.

Step 4: Agree to the software end user license agreement

- 1 View the software end user license agreement. Press **▲/▼** on the remote control to scroll up or down.
- 2 When you are done, press the **OK** button to agree to the agreement.

You will see the Home screen after completing the setup.

4 Use the Home screen

You will see the Home screen of the built-in operating system after setting up or turning on the projector. The Home screen is the jumping-off point for starting all activities on the projector.

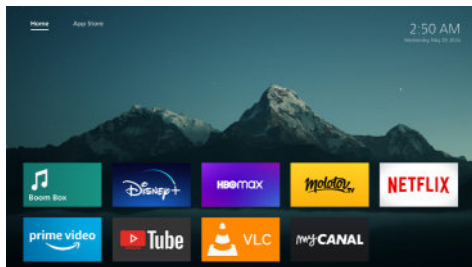

From the Home screen, you can:

- Open and configure the pre-installed apps. For more details, see **Open and configure apps, page 13**.
- Change the projector settings. For more details, see **Change projector settings, page 21**.
- View the date and time in upper-right corner. You can toggle between the 12-hour and 24-hour time formats by selecting the time and pressing the **OK** button.

Navigate the Home screen

You can navigate the Home screen using one of the following:

- The remote control. For more details, see **Navigate Home screen with the remote control, page 12**.
- A USB input device such as a USB mouse or keyboard. To learn how to connect and use a USB input device, see **Connect to a USB mouse, keyboard or gamepad, page 14**.
- A Bluetooth input device such as a Bluetooth mouse or keyboard. To learn how to connect a Bluetooth mouse or keyboard, see **Connect to a Bluetooth device, page 16**.

Navigate Home screen with the remote control

The remote control gives you immediate and easy access to everything on the Home screen.

- Press the navigation button to select an item (e.g. an app, a setting or a button) on the screen.
- Press the **OK** button to confirm a selection or change the value for the current setting.
- From the Home screen, press **↶** to open or close the sidebar.
- Press **↶** to return to the previous screen.
- Press **≡** to view more options when an app is selected.
- Press **⬆** to return to the Home screen.
Tip: If the current input source is HDMI or USB-C, pressing this button will also switch the input source back to LuminOS.

Use the on-screen pointer

The on-screen pointer gives you an alternative way to select an item (e.g. an app, a setting or a button) on the screen. It takes the place of the navigation buttons on the remote control.

Connect the remote control via Bluetooth

If you did not connect the remote control to the projector via Bluetooth during the setup (see **Set up the projector system, page 10**) or the remote control became disconnected, you must make the connection before using the on-screen pointer.

When you press **⬆** on the remote control, the projector will prompt you to connect the remote control if it is disconnected. When this happens, follow the on-screen instructions to connect the remote control to the projector.

Notes:

- You can make the connection only when Bluetooth is enabled on the projector. Bluetooth is enabled by default. If it is disabled, follow the instructions in **Connect to a Bluetooth device, page 16** to enable it.
- On the Bluetooth setting screen, the remote control appears as *Philips AirMote*.
- The LED indicator near the top of the remote control lights up when you press a button. It lights up in red when the remote control is disconnected and blue when the remote control is connected.

Enable/disable the on-screen pointer

When the remote control is connected to the

projector, press **↵** to enable the on-screen pointer. To disable it, press **↵** again.

Use the on-screen pointer

- After you enable the on-screen pointer, a circular pointer will appear on the screen.
- Point the remote control at the screen and move or swivel it. The pointer will then move on the screen.
- The faster you move or swivel the remote control, the faster the pointer moves.
- Press the **OK** button to confirm a selection or change the value for the current setting.

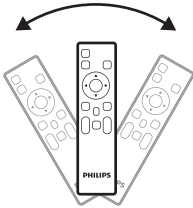
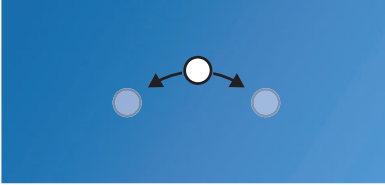

Open and configure apps

The projector has a number of frequently used apps pre-installed for your convenience. You can access these apps from the app list on the Home screen.

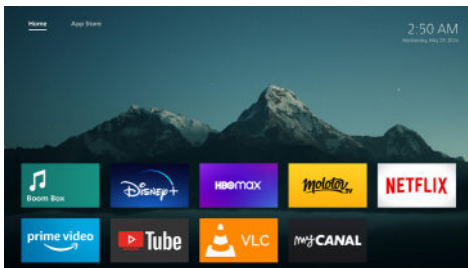

The apps on the Home screen mainly fall into the following categories:

- **Video streaming apps:** Netflix, Prime Video, SmartTube, etc.
- **File management and playback apps:** VLC, etc.
- **Setting apps:** Boom Box, etc.

An app on the Home screen can be in one of following statuses:

- **Installed:** This app has no extra symbol in upper-left corner of its icon. This app is already installed and ready to be used.
- **Installed and must be updated:** This app has a download symbol in upper-left corner of its icon. This app is already installed and must be updated before you can open it. You will be prompted to update this app when you try opening it.

Notes:

- For Netflix, use the on-screen pointer to navigate more easily.
- Before installing/updating an app or using a video streaming app to watch videos, make sure the projector can access the internet via a Wi-Fi network. To learn how to connect the projector to a Wi-Fi network, see **Step 3: Connect to a Wi-Fi network**, page 11.

Open an app

To open an app, select it on the Home screen and then press the **OK** button on the remote control.

Configure an app

If you select an app on the Home screen and press **≡** on the remote control, an options menu will appear on the right of the screen.

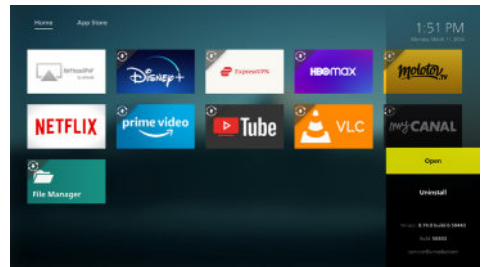

Using the options menu, you can:

- Open the app by selecting *Open*.
- Uninstall the app by selecting *Uninstall* and following the on-screen instructions.
- View the version and build numbers of the app at the bottom of the menu.

Install more apps

You can browse and install more apps on the App Store screen.

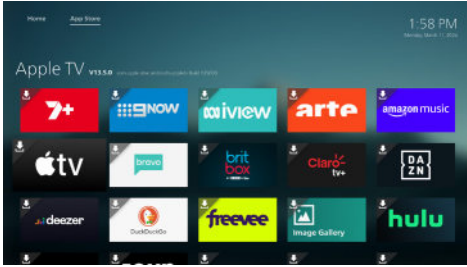

- To open the App Store screen, go to the top of the Home screen by pressing and holding **▲** on the remote control, then press **▶**.
- To return to the Home screen, go to the top of the App Store screen by pressing and holding **▲** on the remote control, then press **◀**.

To install an app, follow these steps:

- 1 Select an app on the App Store screen.
- 2 Press the **OK** button and wait for the projector to complete downloading the installation file.
- 3 When you are prompted whether to install the app, select **INSTALL** and press the **OK** button.
- 4 When the installation is complete, select **Done** to return to the App Store screen or **Open** to open the app.

Notes:

- After installing an app, you can see and open it on the Home screen.
- You may get new or updated apps by updating the projector's software. To learn how to update the projector's software, see **Update software, page 26**.

5 Connect to other devices

Connect to a USB mouse, keyboard or gamepad

You can connect a USB mouse, keyboard or gamepad to the projector to quickly and easily navigate menus, enter your passwords, search for movies and shows, play games, and so on.

Note: Not all games and apps are compatible with a mouse and keyboard.

Connect a USB mouse, keyboard or gamepad

To connect a USB mouse, keyboard, or gamepad, plug it into the **USB** port on the projector.

Tip: You can connect more than one device to a USB port using a USB hub. Connect the devices to the USB ports on the hub, then connect the hub to the projector.

Note: When using a wireless USB mouse or keyboard, the connection can be lost or slow, depending on the distance between the two devices and the signal status.

Use a USB mouse, keyboard or gamepad

Once connected, your USB mouse, keyboard or gamepad will start to work without any additional configuration.

Mouse

- Move your mouse and a circular pointer will appear on the screen.
- Move your mouse and left-click to navigation the projector's user interface like you do on a computer. The left button works like **OK** on the remote control.
- Right-click to return to the previous screen. The right button works like **↶** on the remote control.
- Rotate the wheel to scroll up or down.

Keyboard

- Your keyboard is best for entering text in text fields, allowing you to type much faster and see more of the screen by removing the need for the on-screen keyboard. **Tip:**

You may need to press **Esc** to hide the on-screen keyboard.

- Use the arrow keys and **Enter** to navigation the projector's user interface. They work like the navigation buttons and **OK** on the remote control respectively.
- Press **Tab** or **Shift+Tab** to move to next or previous item. Press the menu key to access more options when an app is selected or a video is playing.
- Press **Windows+Backspace** to return to the previous screen. Press **Home** or **Alt+Esc** to return to the Home screen.
- Many keyboard shortcuts work like they do on a computer, including **Alt+Tab** for switching between recent apps and **Ctrl+X/C/V** for Cut/Copy/Paste.

Gamepad

- You can use your gamepad with games that support controllers.
- Your gamepad can also be used to navigate the projector's user interface and open apps.

Connect to a playback device through HDMI™

You can connect a playback device (e.g. a Blu-ray player, gaming console, camcorder, digital camera or PC) to the projector through HDMI™ connection. With this connection, images are shown on the projection screen, and audio is played on the projector.

- 1 Using an HDMI™ cable, connect the **HDMI™** port on the projector to an HDMI™ output port on a playback device.

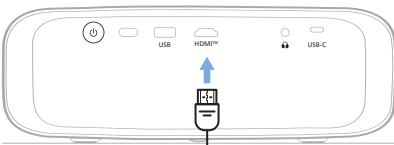

- Phones
- Smart Sticks
- Tablets
- Game consoles
- Computers
- DVD/VCR

- 2 The projector should automatically switch to the correct input source. If not, press

 on the remote control and then select **HDMI**.

Connect to an audio system through HDMI™ ARC

The **HDMI™** port on the projector supports Audio Return Channel (ARC). You can connect a compatible audio system (e.g. a home cinema system, AV receiver or sound bar) to the projector through HDMI™ ARC connection. With this connection, audio is streamed to the connected audio system.

Tip: To get 5.1 surround sound, you typically need to connect the projector to a 5.1 home cinema system.

- 1 Using an HDMI™ cable, connect the **HDMI™** port on the projector to the HDMI™ ARC port on a compatible audio system.
 - The HDMI™ ARC port on your audio system might be labeled differently. See the documentation supplied with the device for more information.
- 2 To activate the HDMI™ ARC function on the projector, press  on the remote control and then select **Sound > Output > ARC**.

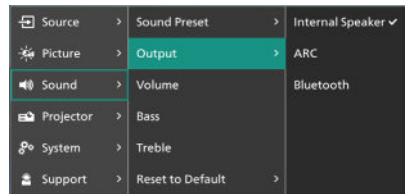

Connect to a dongle

You can connect a dongle (e.g. Amazon Fire Stick, Roku Stick and Chromecast) to the projector to easily watch videos over the internet. With this connection, images are shown on the projection screen, and audio is played on the projector.

- 1 Connect the dongle to the projector's **HDMI™** port directly or using an HDMI™ cable.
- 2 Connect the dongle to the projector's **USB** port using a USB cable. **Note:** The maximum current supplied by this port is 5V2A.

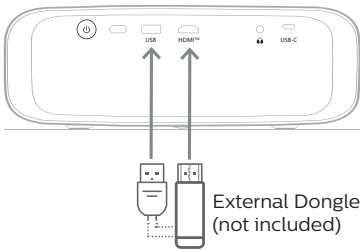



- The projector should automatically switch to the correct input source. If not, press  on the remote control and then select **HDMI**.

Connect to a playback device through USB-C

You can connect a playback device (e.g. a mobile phone or PC) to the projector through USB-C connection. With this connection, images are shown on the projection screen, and audio is played on the projector.

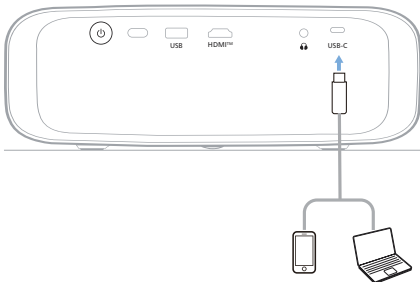
- Using a USB-C cable, connect the **USB-C** port on the projector to the USB-C port on a playback device.



- The projector should automatically switch to the correct input source. If not, press  on the remote control and then select **USB-C**.

Connect to a Bluetooth device

The projector is equipped with Bluetooth 4.2 technology, allowing you to connect it to Bluetooth devices such as Bluetooth gamepads, speakers, mice and keyboards.

Before you can use the projector with a Bluetooth device for the first time, you must

pair the projector with it. The projector will automatically connect to a device as soon as they are paired.

Notice

i Be sure that the Bluetooth device is no farther than 10 m (33 ft) from the projector when connecting the two.

Even when connecting within the specified communication distance, connections can be lost due to the signal status.

You can pair the projector with multiple Bluetooth devices, but can only connect the projector to one of them at a time.

Enable/Disable Bluetooth on the projector

Bluetooth is enabled on the projector by default. You can manually enable or disable it.

- From the projector's Home screen, open the sidebar by pressing  on the remote control. Then select **Bluetooth**.
- Press the **OK** button to enable or disable Bluetooth on the projector. When Bluetooth is enabled, a white Bluetooth icon appears near the upper-right corner of the Bluetooth setting screen.

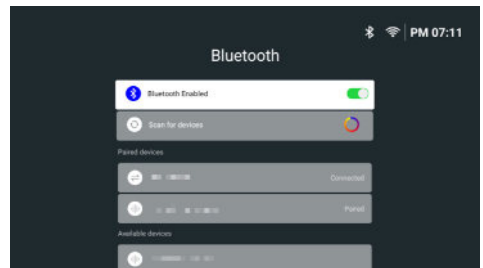

Pair a Bluetooth device

- Turn on your Bluetooth device and make sure it is in pairing mode. Press the pairing button on the device, if needed. See the documentation supplied with the device for more information.
- From the projector's Home screen, open the sidebar by pressing  on the remote control. Then select **Bluetooth**.
- If Bluetooth is disabled on the projector, press the **OK** button to enable it. The projector will automatically scan for available devices and display them under **Available devices**.

Tip: To manually rescan for available devices, select *Scan for devices* and press the **OK** button.

- 4 Select your Bluetooth device from the list of available devices and press the **OK** button to start the pairing.

When the pairing is complete, your Bluetooth device moves to the list under *Paired devices* and its status becomes *Connected*.

Disconnect a Bluetooth device

Use one of the following methods to disconnect a Bluetooth device from the projector but leave it paired.

- Terminate the Bluetooth connection from the Bluetooth device, or turn off the Bluetooth device. The Bluetooth device's status will become *Paired*.
- Disable Bluetooth on the projector.
- Turn off the projector.

Reconnect a Bluetooth device

Once you pair and connect a Bluetooth device to the projector using the steps above, the projector will automatically try to reconnect unless the Bluetooth device gets unpaired or its Bluetooth is off.

You can manually reconnect a paired Bluetooth device on the Bluetooth setting screen.

- 1 Select the Bluetooth device from the list of paired devices and then press the **OK** button.
- 2 Select *Connect* and then press the **OK** button.

Unpair a Bluetooth device

You can unpair a Bluetooth device on the Bluetooth setting screen. This will remove the Bluetooth device from the projector's memory. You'll need to pair and connect this device to use it again.

- To unpair a Bluetooth device connected to the projector, select it from the list of paired devices and then press the **OK** button.
- To unpair a Bluetooth device not connected to the projector, select it from the list of paired devices and then press the **OK** button twice.

Tips for connecting audio output devices

The following are the tips for connecting Bluetooth audio output devices such as Bluetooth speakers and headphones.

- After connecting a Bluetooth audio output device, the projector will automatically switch its audio output type to *Bluetooth*.
- After disconnecting a Bluetooth audio output device, the projector will automatically switch its audio output type back to *Internal Speaker*.
- If you switch the projector's audio output type to *Internal Speaker* while a Bluetooth audio output device is connected, the projector automatically disconnects that device.
- If you switch the projector's audio output type to *Bluetooth*, the projector automatically tries to reconnect to the last connected Bluetooth audio output device.
- If you switch the projector's audio output type to *Bluetooth*, the Bluetooth setting screen automatically opens if Bluetooth is disabled, or Bluetooth is enabled but the projector cannot reconnect to a Bluetooth audio output device.
- You can pair the projector with multiple audio output devices, but can only connect the projector to one of them at a time.

Connect to wired speakers or headphones

You can connect wired speakers or headphones to the projector. With this connection, audio from the projector is played through the external speakers or headphones.

- The internal speakers of the projector are deactivated automatically when external speakers or headphones are connected to the projector.



DANGER!



Danger of hearing damage!

Before connecting the headphones, turn down the volume on the projector.

Do not use the projector over a longer time at high volume – especially when using headphones. This could lead to hearing damage.

- 1 Using a 3.5 mm audio cable, connect the  jack on the projector to the analogue audio input (3.5 mm jack, or red and white jacks) on external speakers. Or connect the  jack on the projector to headphones.



- 2 After connecting the speakers or headphones, press  on the remote control to adjust the volume to the desired level.

6 Play media from USB storage devices

Using the pre-installed **VLC** app, you can play/view videos, audios or images stored on a USB storage device.

Supported file formats

The **VLC** app supports the following file formats.

- Video formats: MP4, RMVB, AVI, RM, MKV
- Audio formats: MP3, WMA, OGG, AAC, FLAC, APE, WAV
- Image formats: BMP, PNG, JPEG

Connect a USB storage device

Notice



The projector supports a USB storage device that is formatted for FAT16 or FAT32 file system.

- 1 Make sure your USB storage device contains media files supported by the **VLC** app.
- 2 Connect your USB storage device to the **USB** port on the projector.

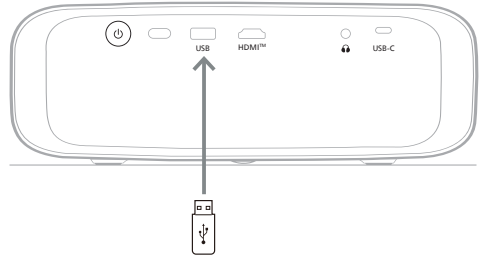

Play videos

- 1 From the projector's Home screen, open the **VLC** app.
- 2 Select **Browsing** from the left navigation pane, and then select and open the folder for the USB storage device, which is to the right of the **Internal memory** folder.
- 3 Select a media file. **Note:** Only supported media files are displayed on the screen. All folders and files are ordered alphabetically by name.
- 4 Press the **OK** button to start playing the selected media file.
- 5 During the playback, you can perform the following actions using the remote control:
 - Press the **OK** button to pause the playback and bring up the control bar at the bottom of the screen. Press the **OK** button again to resume the playback and hide the control bar.
 - Press ◀▶ to go 10 seconds backward or forward.
 - Press 🔊/🔊 to adjust the volume.
 - Press ▼ to temporarily bring up the control bar at the bottom of the screen. You can also press ▲ to bring up the more options menu on the right of the screen. To instantly hide the control bar or more option menu, press ↶.
 - While the control bar is visible, press the navigation buttons to select an option and then press the **OK** button to confirm the option or change the value. To close the dialog box of an option, press ↶.

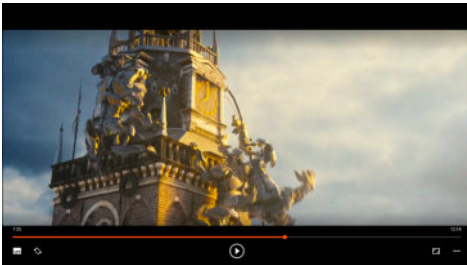

- 6 To stop the playback and return to the list of files in the current folder, press ↶.

Play audios

You can play audios in a similar way as you play videos. The major differences are:

- When an audio is playing, its filename and the control bar are always visible on the screen.
- When an audio is playing, the list of media files in the current folder is always visible on the right of the screen. There is a changing sound wave icon next to the audio file being played.
- To quickly start playing another media file, press the navigation buttons to highlight it on the list and then press the **OK** button.
- When an audio is playing, pressing ↶ will not stop the playback. The audio will continue to play even if you return to the Home screen. To return to the previous playback screen, reopen the **VLC** app and press the **OK** button twice.

View images

You can view images in a similar way as you play videos. The major differences are:

- The app displays each image in the current folder for 10 seconds.
- To skip to the next image in the current folder, press ▶.

7 Wireless projection

This projector can wirelessly mirror the screens of the following devices to the projection screen.

- Android devices
- Windows computers
- iOS devices (iPhone, iPad and iPod touch)
- Mac computers

Notice



For better streaming performance, use a 5 GHz Wi-Fi network.

Copyright-protected content from Netflix, Amazon Prime Video, Hulu, etc. cannot be streamed.

The steps below might vary slightly depending on the version of your operating system and your device.

Wireless projection with Android devices/Windows computers

What you need

- An Android device or Windows computer that supports Miracast. **Note:** This feature is also called Screen Cast, Screen Sharing, Wireless Display, Wireless projection, etc. Not all devices have this feature. Refer to your device user manual for details.
- 1 Make sure you have turned on Wi-Fi on the projector and your Android device or Windows computer. **Tip:** You do not need to connect these devices to Wi-Fi networks to use screen mirroring.
 - 2 From the projector's Home screen, open the sidebar by pressing on the remote control. Then select **ScreenCast**.
 - The projector displays its device name and the status of the ScreenCast connection on the screen.
 - 3 On your Android device, access the "Settings" menu and then select the setting for wireless display or projection.
Or on your Windows 10 computer, select the **action center** icon in the lower-right corner of the screen and then select **Connect**.

Your device will automatically scan for and display the available display devices.

- 4 On your Android device or Windows computer, select the projector to make a connection and start mirroring your device's screen. **Note:** You may need to wait a few seconds for the screen mirroring to start.

Wireless projection with iOS devices/Mac computers

What you need

- An iOS device such as an iPhone or a Mac computer.
- 1 Make sure you have connected the projector and your iOS device or Mac computer to the same Wi-Fi network.
 - 2 Make sure you have enabled AirPlay on the projector. **Tip:** AirPlay is enabled by default. You can use the method below to enable it.
 - From the projector's Home screen, open the sidebar by pressing on the remote control. Then select **AirPlay™** to open the settings screen. If the box next to **AirPlay** is not checked, press the **OK** button to check it.

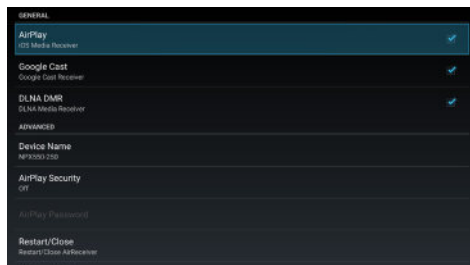





- 3 On your iOS device, open Control Center.
 - On iPhone X or later or iPad with iPadOS 13 or later: Swipe down from the upper-right corner of the screen.
 - On iPhone 8 or earlier or iOS 11 or earlier: Swipe up from the bottom edge of the screen.
- Or on your Mac computer, select the AirPlay status icon in the menu bar, which is near the upper-right corner of the screen.
- 4 On your iOS device, tap Screen Mirroring in Control Center and select the projector to start mirroring your iOS device's screen.
Or on your Mac computer, select the projector to start mirroring your Mac

computer's screen.

Note: You may need to wait a few seconds for the screen mirroring to start.

Stream videos/pictures from iOS devices



What you need

- An iOS device such as an iPhone or an iPad.
- 1 Make sure you have connected the projector and your iOS device to the same Wi-Fi network.
 - 2 Make sure you have enabled AirPlay on the projector. **Tip:** AirPlay is enabled by default. You can use the method below to enable it.
 - From the projector's Home screen, open the sidebar by pressing  on the remote control. Then select *AirPlay™* to open the settings screen. If the box next to *AirPlay* is not checked, press the **OK** button to check it.
 - 3 On your iOS device, while playing a video or viewing a picture in a supported app such Safari or Photos, tap the screen to show the controls if they are invisible.
 - 4 On your iOS device, tap AirPlay . In some apps, you might need to tap a different button first. For example, in the Photos app, tap Share , then tap AirPlay .
 - 5 On your iOS device, select the projector to start streaming the video or picture. **Note:** You may need to wait a few seconds for the streaming to start.

8 Change projector settings

This section helps you change the projector settings using the sidebar and settings menu.

Change settings using the sidebar

- 1 From the projector's Home screen, open the sidebar by pressing  on the remote control.
- 2 Select a setting on the sidebar using the navigation buttons and the **OK** button.
- 3 Make changes using the navigation buttons and the **OK** button.
- 4 Press  one or more times or  to return to the Home screen.

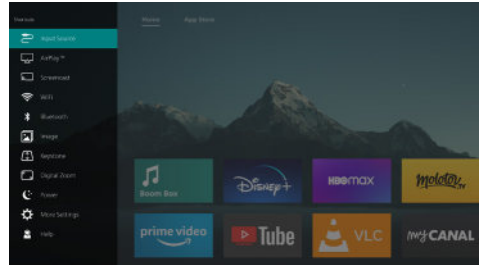

The following settings are available on the sidebar:

- *Input Source:* Toggle the input source between *LuminOS*, *HDMI* and *USB-C*.
- *AirPlay™:* View and change the settings for AirPlay. To learn how to wirelessly mirror the screen of an iOS device or Mac computer using AirPlay, see **Wireless projection with iOS devices/Mac computers, page 20**.
- *Screencast:* Wirelessly mirror the screen of an Android device or Windows computer. For more details, see **Wireless projection with Android devices/Windows computers, page 20**.
- *WiFi:* Access the *Wireless Network* screen. To learn how to connect the projector to a Wi-Fi network, see **Step 3: Connect to a Wi-Fi network, page 11**.
- *Bluetooth:* Access the *Bluetooth* screen. To learn how to connect a Bluetooth device, see **Connect to a Bluetooth device, page 16**.

- *Image*: Access the *Image Settings* screen. The following settings are available:
 - *Projection Direction*: Adjust the projection to the correct direction based on how the projector is installed.
 - *Keystone Correction*: See *Keystone* below for details.
 - *Digital Zoom*: See *Digital Zoom* below for details.
- *Keystone*: Access the *Keystone Correction* screen. The following settings are available:
 - *Auto Keystone Correction*: Turn auto keystone correction on or off by pressing the **OK** button.
 - *4-Corner Correction*: Select this to manually make the image rectangular by moving four corners of the image. This setting is visible only when auto keystone correction is off.
 - *H/V Correction*: Select this to manually make the image rectangular by adjusting the horizontal and vertical keystone angles. This setting is visible only when auto keystone correction is off.
- *Digital Zoom*: Scale down the screen to up to 60% of its full size. The default value is 100% (no scale-down).
- *Power*: Access the *Power* screen. The following settings are available:
 - *Shutdown*: Select this to turn off the projector immediately.
 - *Timed Shutdown*: Select this to turn off the projector after a specific period of time.
- *More Settings*: See the subsection below for details.
- *Help*: View the website addresses, QR code and email address for getting help information on the projector.

Change more settings

If you open *More Settings* from the sidebar, you will see the following screen.

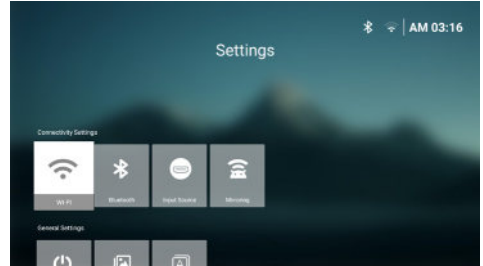

The following settings are available on this screen:

Connectivity Settings

- *Wi-Fi*: Access the *Wireless Network* screen. To learn how to connect the projector to a Wi-Fi network, see **Step 3: Connect to a Wi-Fi network, page 11**.
- *Bluetooth*: Access the *Bluetooth* screen. To learn how to connect a Bluetooth device, see **Connect to a Bluetooth device, page 16**.
- *Input Source*: Toggle the input source between *LuminOS*, *HDMI* and *USB-C*.
- *Mirroring*: Access the *Screen Mirroring* screen. The following settings are available:
 - *Android*: Wirelessly mirror the screen of an Android device or Windows computer. For more details, see **Wireless projection with Android devices/Windows computers, page 20**.
 - *iOS*: View and change the settings for AirPlay. To learn how to wirelessly mirror the screen of an iOS device or Mac computer using AirPlay, see **Wireless projection with iOS devices/Mac computers, page 20**.

General Settings

- *Power*: Access the *Power* screen. The following settings are available:
 - *Shutdown*: Select this to turn off the projector immediately.
 - *Timed Shutdown*: Select this to turn off the projector after a specific period of time.
- *Image Settings*: Access the *Image Settings* screen. The following settings are available:

- *Projection Direction*: Adjust the projection to the correct direction based on how the projector is installed.
- *Auto Keystone Correction*: Turn auto keystone correction on or off by pressing the **OK** button.
- *4-Corner Correction*: Select this to manually make the image rectangular by moving four corners of the image. This setting is visible only when auto keystone correction is off.
- *H/V Correction*: Select this to manually make the image rectangular by adjusting the horizontal and vertical keystone angles. This setting is visible only when auto keystone correction is off.
- *Digital Zoom*: Scale down the screen to up to 60% of its full size. The default value is 100% (no scale-down).
- *Language/Input*: Access the *Language/Input* screen. The following settings are available:
 - *Language*: Select your preferred display language.
 - *Time Zone*: Set the time zone used by the projector by selecting a city.
 - *Keyboard Input Method*: Select your preferred on-screen keyboard or input method.

System Settings

- *System Clean*: Optimize the operating system by automatically clearing junk files and the system cache.
- *Software Update*: Update the projector's software or factory reset the projector.
 - *Online Upgrade*: For more details, see **Update software online, page 26**.
 - *Offline Upgrade*: For more details, see **Update software offline, page 26**.
 - *Factory Reset*: Restore the product to its factory default settings. After the factory reset, the projector will restart and allow you to set it up as new.
- *About*: View the model, software version, MAC address, serial number, launcher version and built-in storage of this product.

Change settings using the settings menu

- 1 Press  on the remote control to access the projector's settings menu.
- 2 Use the navigation buttons and the **OK** button to select a menu item.
- 3 Press **▲/▼** or **◀/▶** to select a value for the menu item.
- 4 Press the **OK** button to make the change. **Note**: For some menu items such as Digital Zoom, the change takes effect once you select a different value.
- 5 Press **↶** one or more times to exit the projector's settings menu.

Input source settings

You can view and change the following input source settings.

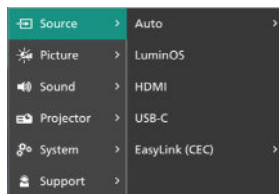

- *Auto*: Choose whether to let the projector automatically switch to the correct input source. The default value is *On*.
- *LuminOS*: Select this to use the internal LuminOS as the input source. This is the default input source.
- *HDMI*: Select this to use the device connected to the projector's **HDMI™** port as the input source.
- *USB-C*: Select this to use the device connected to the projector's **USB-C** port as the input source.
- *EasyLink (CEC)*: Choose to enable or disable **HDMI™ CEC** (Consumer Electronics Control). The default value is *Enabled*.

Picture settings

You can view and change the following picture settings.

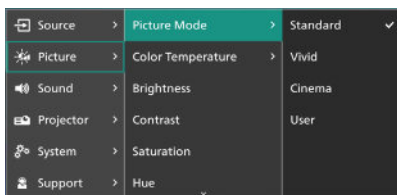

- **Picture Mode:** You can set the projector to use the following picture modes, depending on your viewing environment or preferences. After selecting a picture mode, you can modify its settings.
 - **Standard:** Display the picture with normal brightness, contrast, saturation, hue and sharpness levels.
 - **Vivid:** Sharpen the image by increasing the contrast, saturation and sharpness.
 - **Cinema:** Optimize the settings for movies.
 - **User:** Define your own settings.
- **Color Temperature:** You can set the projector to use the following color temperature types. After selecting a color temperature type, you can modify its settings.
 - **Cool:** Make the picture more bluish.
 - **Standard:** Use a moderate color temperature.
 - **Warm:** Make the picture more reddish.
 - **User:** Define your own settings.
- **Brightness:** Adjust the screen's overall brightness.
- **Contrast:** Adjust the contrast of the bright and dark areas of the image.
- **Saturation:** Adjust the intensity of the colors.
- **Hue:** Adjust the hue of the colors.
- **Sharpness:** Adjust the sharpness of the image.
- **Red Gain:** Adjust the gain for red.
- **Green Gain:** Adjust the gain for green.
- **Blue Gain:** Adjust the gain for blue.
- **Reset to Default:** Select **Yes** to reset all the picture settings above.

Sound settings

You can view and change the following sound settings.

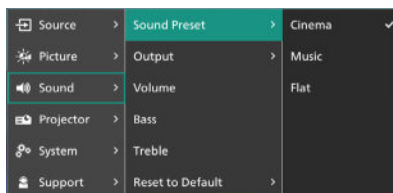

- **Sound Preset:** You can set the projector to use the following sound presets, depending on your environment, audio type or preferences.
 - **Cinema:** Optimize the settings for movies.
 - **Music:** Optimize the settings for music.
 - **Flat:** Set both the bass and treble levels to medium levels.
- **Output:** Select the projector's audio output type.
 - **Internal Speaker:** Use the projector's internal speaker to output audio.
 - **ARC:** Use an HDMI™ ARC compatible device to output audio. **Note:** You can select this only when a compatible device is connected. To learn how to connect such a device, see **Connect to an audio system through HDMI™ ARC, page 15**.
 - **Bluetooth:** Use a Bluetooth device paired with the projector to output audio. To learn how to connect a Bluetooth device, see **Connect to a Bluetooth device, page 16**.
- **Volume:** Adjust the volume of the projector.
- **Bass:** Set the bass level.
- **Treble:** Set the treble level.
- **Reset to Default:** Select **Yes** to reset all the sound settings above.

Image settings

You can view and change the following image settings.

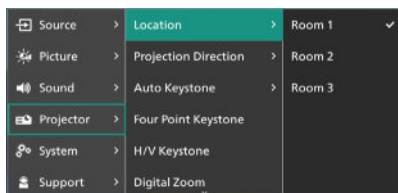

- **Location:** You can select a location and then modify the image settings. All the modified image settings will be associated with the selected (current) location. You can create up to 3 different sets of image settings this way and quickly switch between them by selecting a location. **Tip:** The projector always selects the last used location after being restarted.
 - **Room 1:** Select this to use or modify the image settings for Room 1.
 - **Room 2:** Select this to use or modify the image settings for Room 2.
 - **Room 3:** Select this to use or modify the image settings for Room 3.
- **Projection Direction:** Adjust the projection to the correct direction based on how the projector is installed.
- **Auto Keystone:** Turn auto keystone correction on or off by selecting *Yes* or *No*.
- **Four Point Keystone:** Select this to manually make the image rectangular by moving four corners of the image. This menu item is visible only when auto keystone correction is off.
- **H/V Keystone:** Select this to manually make the image rectangular by adjusting the horizontal and vertical keystone angles. This menu item is visible only when auto keystone correction is off.
- **Digital Zoom:** Scale down the screen to up to 60% of its full size. The default value is 100% (no scale-down).
- **Reset to Default:** Select *Yes* to reset all the image settings above for the current location (Room 1/2/3). The other two locations will not be affected.

Other settings

You can view and change the following additional settings.

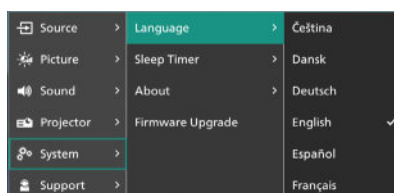

- **Language:** Select your preferred display language.
- **Sleep Timer:** Select a period of time after which the projector turns off automatically. The default value is *Disabled*.
- **About:** View the hardware version, firmware version, serial number and MAC address of this product.
- **Firmware Upgrade:** Update the projector's software or factory reset the projector.
 - **Online Upgrade:** For more details, see **Update software online, page 26**.
 - **Offline Upgrade:** For more details, see **Update software offline, page 26**.
 - **Factory Reset:** Restore the product to its factory default settings. After the factory reset, the projector will restart and allow you to set it up as new.
- **Support:** View the website addresses, QR code and email address for getting help information on the projector.

9 Maintenance

Cleaning

DANGER!



Follow the following instructions when cleaning the projector:

Use a soft, lint-free cloth. Never use liquid or easily flammable cleansers (sprays, abrasives, polishes, alcohol, etc.). Do not allow any moisture to reach the interior of the projector. Do not spray the projector with any cleaning fluids.

Wipe over the surfaces gently. Be careful that you do not scratch the surfaces.

Cleaning the lens

Use a soft brush or lens cleaning paper for cleaning the lens of the projector.

DANGER!



Do not use any liquid cleaning agents!

Do not use any liquid cleaning agents for cleaning the lens, to avoid damaging the coating film on the lens.

Update software

You can update the projector software online or offline to get the best features and support from the projector.

CAUTION!



Do not turn off the projector or remove the USB flash drive during a software update.

Update software online

Updating the projector software online is quick and easy.

- 1 Make sure the projector can access the internet via a Wi-Fi network. To learn how to connect the projector to a Wi-Fi network, see **Step 3: Connect to a Wi-Fi network, page 11**.
- 2 Press  on the remote control and then select **System > Firmware Upgrade > Online Upgrade**. The projector will automatically

check for a new version of projector software. If a new version is found, the projector will prompt you to start the update.

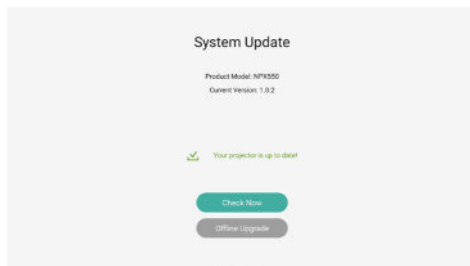

- 3 If a new version is found, follow the on-screen instructions to complete the update.

Tip: When the projector is connected to the internet, it will check for a new version of projector software every time you turn it on. If a new version is found, the projector will prompt you to start the update. If this happens, you can choose to start or cancel the update.

Update software offline

If your projector has no access to the internet, you can manually update its software offline.

- 1 Visit www.philips.com/support, find your product (model number: **NPX750/INT**), open its support page and locate "**Software & drivers**". Then check the latest software version there.
- 2 Check the current software version by pressing  on the remote control and selecting **System > About**. Proceed to the next step if the latest software version is greater than the current software version.
- 3 Select **System > Firmware Upgrade > Offline Upgrade** from the settings menu.

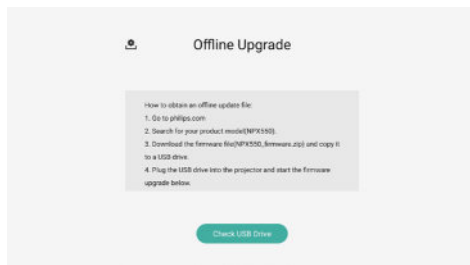

- 4 Follow the on-screen instructions to complete the update.

10 Troubleshooting

Power cycling

If a problem occurs and you cannot resolve it using the instructions in this user manual, try the following steps to resolve the problem.

- 1 Turn the projector off by pressing \odot twice.
- 2 Wait at least 10 seconds.
- 3 Turn the projector on by pressing \odot .
- 4 If the problem persists, contact one of our customer service centers or your dealer.

Problem	Solution
The projector cannot be turned on.	<ul style="list-style-type: none">• Disconnect and reconnect the power cable, and try to turn the projector on again.
The projector cannot be turned off.	<ul style="list-style-type: none">• Press and hold \odot longer than ten seconds. If this does not work, disconnect the power cable.
No image from the external HDMI™ device.	<ol style="list-style-type: none">1. Check if you have switched the input source to <i>HDMI</i>.2. Disconnect the HDMI™ cable or switch off the HDMI™ device.3. Wait three seconds.4. Reconnect the HDMI™ cable or switch on the HDMI™ device again.
No sound from the external connected device.	<ul style="list-style-type: none">• Check the cables to the external device.• Check that the sound is activated on the external device.• Only the original cables from the device manufacturer may function.
No sound from external HDMI™ output device.	<ul style="list-style-type: none">• On the HDMI™ output device, set the audio setting to Multichannel (Raw data) & Stereo (PCM).
No sound when you connect your computer using an HDMI™ cable.	<ul style="list-style-type: none">• Check that the sound is activated on the computer.
Only the home menu appears and not the image from the external device.	<ul style="list-style-type: none">• Check if the cables are connected to the correct sockets.• Check that the external device is turned on.• Check if the video output of the external device is turned on.
Only the home menu appears and not the image from the connected computer.	<ul style="list-style-type: none">• Check that the HDMI™ output of the computer is turned on.• Check if the resolution of the computer is set to 1920*1080.
The projector turns itself off.	<ul style="list-style-type: none">• When the projector is running for a long period of time, the surface becomes hot.• Check that the power cable is connected correctly.
The projector cannot read the USB storage device.	<ul style="list-style-type: none">• The projector does not support the exFAT file system.• Format the USB storage device in FAT32 or NTFS format, then use it.

Problem	Solution
The projector does not react to remote control commands.	<ul style="list-style-type: none"> • Check the batteries of the remote control.
The temperature of the projector's surface is warm.	<ul style="list-style-type: none"> • For this projector it is normal to generate moderate heat during operation.
The projector does not work after I connect it to a laptop.	<ul style="list-style-type: none"> • Check that the HDMI™ cable is plugged in correctly. • Make sure that the laptop has been switched to projector display.
I cannot pair the projector with a Bluetooth device.	<ul style="list-style-type: none"> • Turn on the Bluetooth device and make sure it is in pairing mode. • Position the Bluetooth device so that it is less than 10 m (33 ft) from the projector. • To connect a Bluetooth device to the projector, follow the instructions in Connect to a Bluetooth device, page 16. • If another Bluetooth device is already connected to the projector, disconnect it. • Move the projector farther away from other devices (microwave oven, wireless router, etc.) that are emitting radio frequency signals.
After a Bluetooth device is connected, there is no sound from the projector or the Bluetooth device.	<ul style="list-style-type: none"> • Check if the Bluetooth device's volume is at the minimum. • Check if projector's volume is at the minimum. • Check if the playback has started. • Try playing another video/audio file. • Try reconnecting the two devices.
Black / White Pixels	<p>An LCD display may contain a small number of pixels that do not function normally (also known as “dead pixels” or “black pixels”). Your display has been inspected and is in compliance with the manufacturer's specifications, meaning that any pixel defects do not affect the operation or use of your display. Without prejudice to generality of the foregoing, dead pixels or black pixels not exceeding 5 dots meet the factory specifications and are not considered a defect under this warranty.</p> <p>Concerning dust: Dust may appear during the use of a projector. Without prejudice to generality of the foregoing, dust spots not exceeding 3 dots meet the factory specifications and are not considered a defect under this warranty. Please clean the lens with a gentle specific glass tissue. You can also push dry air into the product by the side holes in order to clean the optical engine inside.</p>

11 Appendixes

Technical data

Technology/optical

Display technology	LCD
Light source	single LED W
Lumens.....	700
Resolution	1920 x 1080 pixels
LED lifetime	over 30,000 hours
Contrast ratio	3000:1
Aspect ratio	16:9
Throw ratio.....	1.65:1
Screen size (diagonal).....	up to 120"
Screen distance....	367 cm / 144" for 120" screen
Projection modes	4
Focus adjustment.....	manual
Keystone correction	digital
4 corner correction.....	yes
Digital zoom	yes (60-100%)
Sleep timer.....	yes

Operating system

LuminOS with pre-loaded apps:
Netflix, MyCanal, Disney+, VLC, SmartTube, etc.
(Apps may vary depending on availability)

Sound

Built-in speakers.....	2 x 7 W
Speaker type.....	stereo
Equalization.....	yes

Connection

HDMI™ in.....	x1
USB-C (video in).....	x1
USB-A (5 V/2 A out + external drive).....	x1
3.5 mm audio out	x1
Wi-Fi.....	802.11a/b/g/n/ac, 2.4 + 5 GHz
Wi-Fi screen mirroring.....	yes
Bluetooth.....	To connect gamepad, speaker, mouse, keyboard, etc.

Power source

Power consumption	operating: 143 W
.....	standby: 0.3 W
Input: AC 100-240 V, 50/60 Hz	

Multimedia player

Supported video formats: MP4, RMVB, AVI, RM, MKV

Supported audio formats: MP3, WMA, OGG, AAC, FLAC, APE, WAV

Supported photos formats: BMP, PNG, JPEG

Dimensions and weights

Unpacked (W x D x H).....	305 x 319 x 119.5 mm
Packed (W x D x H)	362.5 x 360 x 172 mm
Net weight.....	3.9 kg / 8.6 lb
Gross weight.....	5.3 kg / 11.6 lb

Temperature requirements

Operating temperature.....	5 °C - 35 °C
Storage temperature	< 60 °C

Package contents

1. NeoPix 750 projector
2. Remote control
3. Power cables (EU, UK, US)
4. AAA batteries for remote control
5. Quick Start Guide with Warranty Card

Model

NPX750/INT
EAN: 7640186962414
UPC: 667619993040

CE statement

- The product shall only be connected to a USB interface of version USB 2.0 or higher.
- Adapter shall be installed near the equipment and shall be easily accessible.
- The operating temperature of the EUT can't exceed 35°C and shouldn't be lower than 5°C.
- The plug is considered as disconnect device of adapter.
- The UNII Band 5150-5250 MHz is for indoor use only.
- The device complies with RF specifications when the device is used at 20 cm from your body.

Hereby, Screeeno Innovation SA declares that this product is in compliance with essential requirements and other relevant provisions of Directive 2014/53/EU.



The Declaration of Compliance can be consulted on the site www.philips.com.

Frequency bands	Maximum output power
BT EDR (EIRP)	9.09 dBm
BT BLE (EIRP)	4.85 dBm
Wi-Fi 2.4GHz (EIRP)	17.88 dBm
Wi-Fi 5GHZ (EIRP)	17.89 dBm

FCC statement

15.19 Labeling requirements.

This device complies with part 15 of the FCC Rules. Operation is subject to the following two conditions: (1) This device may not cause harmful interference, and (2) this device must accept any interference received, including interference that may cause undesired operation.

15.21 Information to the user.

Any changes or modifications not expressly approved by the party responsible for compliance could void the user's authority to operate the equipment.

15.105 Information to user.

This equipment has been tested and found to comply with the limits for a Class B digital device, pursuant to Part 15 of the FCC Rules. These limits are designed to provide reasonable protection against harmful interference in a residential installation. This equipment generates, uses and can radiate radio frequency energy and, if not installed and used in accordance with the instructions, may cause harmful interference to radio communications. However, there is no guarantee that interference will not occur in a particular installation. If this equipment does cause harmful interference to radio or television reception, which can be determined by turning the equipment off and on, the user is encouraged to try to correct the interference by one or more of the following measures:

- Reorient or relocate the receiving antenna.
- Increase the separation between the equipment and receiver.
- Connect the equipment into an outlet on a circuit different from that to which the receiver is connected.
- Consult the dealer or an experienced radio/TV technician for help.

During operation, the separation distance between the user and the antenna shall be at least 20 cm. This separation distance will ensure that there is sufficient distance from a properly installed externally-mounted antenna to satisfy the RF exposure requirements.

FCC ID: 2ASRT-NPX750

Canada regulatory compliance

This device complies with Industry Canada CAN ICES-3 (B)/NMB-3(B)

RSS-Gen & RSS-247 statement: This device complies with Industry Canada RSS standard(s).

Operation is subject to the following two conditions:

- 1 This device may not cause interference, and
- 2 This device must accept any interference, including interference that may cause undesired operation of the device.

RF Radiation Exposure statement: The device meets the exemption from the routine evaluation limits in section 2.5 of RSS102 and users can obtain Canadian information on RF exposure and compliance.

This device should be installed and operated with a minimum distance of 7.8 inches (20 centimetres) between the device and your body.

Other notice

Preservation of the environment as part of a sustainable development plan is an essential concern of Screeneo Innovation SA. The desire of Screeneo Innovation SA is to operate systems respecting the environment and consequently it has decided to integrate environmental performances in the life cycle of these products, from manufacturing to commissioning use and elimination.

Batteries: If your product contains batteries, they must be disposed of at an appropriate collection point.



Product: The crossed-out waste bin symbol on the product means that the product belongs to the family of electrical and electronic equipment. In this respect, the European regulations ask you to dispose of it selectively:

- At sales points in the event of the purchase of similar equipment.
- At the collection points made available to you locally (drop-off center, selective collection, etc.).

In this way you can participate in the reuse and upgrading of Electrical and Electronic Equipment Waste, which can have an effect on the environment and human health.

The paper and cardboard packaging used can be disposed of as recyclable paper. Have the plastic wrapping recycled or dispose of it in the non-recyclable waste, depending on the requirements in your country.

Trademarks: The mentioned references in this manual are trademarks of the respective companies. The lack of the trademarks ® and ™ does not justify the assumption that these dedicated terminologies are free trademarks. Other product names used herein are for identification purposes only and may

be trademarks of their respective owners. Screeneo Innovation SA disclaims any and all rights in those marks.

Neither Screeneo Innovation SA nor its affiliates shall be liable to the purchaser of this product or third parties for damages, losses, costs, or expenses incurred by the purchaser or third parties as a result of accident, misuse, or abuse of this product or unauthorised modifications, repairs, or alterations to this product, or failure to strictly comply with Screeneo Innovation SA operating and maintenance instructions.

Screeneo Innovation SA shall not be liable for any damages or problems arising from the use of any options or any consumable materials other than those designated as original Screeneo Innovation SA/PHILIPS products or Screeneo Innovation SA/PHILIPS approved products.

Screeneo Innovation SA shall not be held liable for any damage resulting from electromagnetic interference that occurs from the use of any interface cables other than those designated as Screeneo Innovation SA/PHILIPS products.

All rights reserved. No part of this publication may be reproduced, stored in a retrieval system or transmitted in any form or by any means, electronic, mechanical, photocopying, recording, or otherwise, without the prior written permission of Screeneo Innovation SA. The information contained herein is designed only for use with this product. Screeneo Innovation SA is not responsible for any use of this information as applied to other devices.

This user manual is a document that does not represent a contract.

Errors, printing errors and changes are reserved.

HDMI™
HIGH-DEFINITION MULTIMEDIA INTERFACE

The terms HDMI, HDMI High-Definition Multimedia Interface, HDMI Trade Dress and the HDMI Logos are trademarks or registered trademarks of HDMI Licensing Administrator, Inc.



Screeneo Innovation SA

Route de Lully 5c - 1131 Tolochenaz - Switzerland

Philips and the Philips Shield Emblem are registered trademarks of Koninklijke Philips N.V. and are used under license. Screeneo Innovation SA is the warrantor in relation to the product with which this booklet was packaged.