



TEST REPORT

For FCC Part15B

Report No.: **CHEW22100112** Report verification: 

Project No.: **SHT2210074601EW**

FCC ID.....: **2ASRT-NPX520**

Applicant's name.....: **Screeneo Innovation SA**

Address.....: Route de Lully 5C, 1131 Tolochenaz, Switzerland

Product Name: **Digital Projector**

Trade Mark: PHILIPS

Model No.: NeoPix 520

Listed Model(s): NPX520

Standard: **47 CFR FCC Part 15 Subpart B**

Date of receipt of test sample.....: Oct.26, 2022

Date of testing.....: Oct.26, 2022- Oct.27, 2022

Date of issue.....: Oct.27, 2022

Result.....: **Pass**

Compiled by
 (position+printed name+signature)...: File administrators Fanghui Zhu

Fanghui Zhu

Supervised by
 (position+printed name+signature)...: Project Engineer Weiyang.Xiang

Weiyang.Xiang

Approved by
 (position+printed name+signature)...: RF Manager Hans Hu

Hans Hu

Testing Laboratory Name: **Shenzhen Huatongwei International Inspection Co., Ltd.**

Address.....: 1/F, Bldg 3, Hongfa Hi-tech Industrial Park, Genyu Road, Tianliao, Gongming, Shenzhen, China

Shenzhen Huatongwei International Inspection Co., Ltd. All rights reserved.

This publication may be reproduced in whole or in part for non-commercial purposes as long as the Shenzhen Huatongwei International Inspection Co., Ltd. is acknowledged as copyright owner and source of the material. Shenzhen Huatongwei International Inspection Co., Ltd. takes no responsibility for and will not assume liability for damages resulting from the reader's interpretation of the reproduced material due to its placement and context.

The test report merely corresponds to the test sample.

Contents

1.	<u>TEST STANDARDS AND REPORT VERSION</u>	<u>3</u>
1.1.	Test Standards	3
1.2.	Report version information	3
2.	<u>TEST DESCRIPTION</u>	<u>4</u>
3.	<u>SUMMARY.....</u>	<u>5</u>
3.1.	Client Information	5
3.2.	Product Description	5
3.3.	Testing Laboratory Information	5
4.	<u>TEST CONFIGURATION.....</u>	<u>6</u>
4.1.	Descriptions of test mode	6
4.2.	Configuration of Tested System	6
4.3.	Support unit used in test configuration and system	7
4.4.	Environmental conditions	7
4.5.	Statement of the measurement uncertainty	7
4.6.	Equipments Used during the Test	8
5.	<u>TEST CONDITIONS AND RESULTS.....</u>	<u>9</u>
5.1.	Conducted Emissions	9
5.2.	Radiated Emissions	11
6.	<u>TEST SETUP PHOTOS</u>	<u>15</u>
7.	<u>EXTERNAL AND INTERNAL PHOTOS</u>	<u>16</u>

1. TEST STANDARDS AND REPORT VERSION

1.1. Test Standards

The tests were performed according to following standards:

[47 CFR FCC Part 15 Subpart B](#) - Unintentional Radiators

[ANSI C63.4: 2014](#) – American National Standard for Methods of Measurement of Radio-Noise Emissions from Low-Voltage Electrical and Electronic Equipment in the Range of 9 kHz to 40GHz

1.2. Report version information

Revision No.	Date of issue	Description
N/A	2022-10-27	Original

2. TEST DESCRIPTION

Section	Test Item	Section in CFR 47	Result #1	Test Engineer
5.1	Conducted Emissions	15.107(a)	PASS	Hongtao Meng
5.2	Radiated Emissions	15.109(a)	PASS	Dongyang Wu

Note:

#1: The test result does not include measurement uncertainty value

3. SUMMARY

3.1. Client Information

Applicant:	Screeneo Innovation SA
Address:	Route de Lully 5C, 1131 Tolochenaz, Switzerland
Manufacturer:	Screeneo Innovation SA
Address:	Route de Lully 5C, 1131 Tolochenaz, Switzerland

3.2. Product Description

Main unit information:	
Product Name:	Digital Projector
Trade Mark:	PHILIPS
Model No.:	NeoPix 520
Listed Model(s):	NPX520
Power supply:	AC 100-240V
Hardware version:	PJ53WV662
Software version:	1.1.6

3.3. Testing Laboratory Information

Laboratory Name	Shenzhen Huatongwei International Inspection Co., Ltd.	
Laboratory Location	1/F, Bldg 3, Hongfa Hi-tech Industrial Park, Genyu Road, Tianliao, Gongming, Shenzhen, China	
Connect information:	Tel: 86-755-26715499 E-mail: cs@szhtw.com.cn http://www.szhtw.com.cn	
Qualifications	Type	Accreditation Number
	FCC	762235

4. TEST CONFIGURATION

4.1. Descriptions of test mode

Test mode	Description
Video Playing mode	Keep the EUT in Video Playing status
Data exchange mode	Keep the EUT in Data exchange with PC status

Pre-scan above all test mode, found below test mode which it was worse case mode, so only show the test data for worse case mode on the test report

Test Item	Test mode for worse case
Conducted Emissions	Video Playing mode
Radiated Emissions	Video Playing mode

Test voltage: AC 120V/60Hz

4.2. Configuration of Tested System

Test mode	Configuration
Data exchange mode	<pre> graph TD PC[PC] --- Printer[Printer] PC --- EUT[EUT] PC --- Monitor[Monitor] PC --- Keyboard[Keyboard] PC --- Mouse[Mouse] </pre>
Video Playing mode	<pre> graph LR AC[AC Adapter] --- EUT[EUT] </pre>

4.3. Support unit used in test configuration and system

The EUT has been associated with peripherals and configuration operated in a manner tended to maximize its emission characteristics in a typical application.

Item	Equipment	Manufacturer	Model No.	FCC ID / FCC SDoC	Data Cable	Power Cord
1	Notebook PC	Lenovo	82FD	FCC SDoC	N/A	Unshielded 1.8m

4.4. Environmental conditions

During the measurement the environmental conditions were within the listed ranges:

Temperature:	15~35°C
Relative Humidity:	30~60 %
Air Pressure:	950~1050mba

4.5. Statement of the measurement uncertainty

Test Items	Measurement Uncertainty
Conducted emission	3.21dB
Radiated emission	<1GHz: 4.54dB >1GHz: 5.10 dB

This uncertainty represents an expanded uncertainty expressed at approximately the 95% confidence level using a coverage factor of $k=1.96$.

4.6. Equipments Used during the Test

● Conducted Emission							
Used	Test Equipment	Manufacturer	Equipment No.	Model No.	Serial No.	Last Cal. Date (YY-MM-DD)	Next Cal. Date (YY-MM-DD)
●	Shielded Room	Albatross projects	HTWE0114	N/A	N/A	2018/09/28	2023/09/27
●	EMI Test Receiver	R&S	HTWE0111	ESCI	101247	2022/08/30	2023/08/29
●	Artificial Mains	SCHWARZBECK	HTWE0113	NNLK 8121	573	2022/08/29	2023/08/28
●	Pulse Limiter	R&S	HTWE0193	ESH3-Z2	101447	2022/08/29	2023/08/28
●	RF Connection Cable	HUBER+SUHNER	HTWE0113-02	ENVIROFLEX_142	EF-NM-BNCM-2M	2022/09/17	2023/09/16
●	Test Software	R&S	N/A	ES-K1	N/A	N/A	N/A

● Radiated Emission-6th test site							
Used	Test Equipment	Manufacturer	Equipment No.	Model No.	Serial No.	Last Cal. Date (YY-MM-DD)	Next Cal. Date (YY-MM-DD)
●	Semi-Anechoic Chamber	Albatross projects	HTWE0127	SAC-3m-02	C11121	2018/09/30	2023/09/29
●	EMI Test Receiver	R&S	HTWE0099	ESCI	100900	2022/08/30	2023/08/29
●	Ultra-Broadband Antenna	SCHWARZBECK	HTWE0119	VULB9163	546	2020/04/28	2023/04/27
●	Pre-Amplifier	SCHWARZBECK	HTWE0295	BBV 9742	N/A	2021/11/05	2022/11/04
●	RF Connection Cable	HUBER+SUHNER	HTWE0062-01	N/A	N/A	2022/02/25	2023/02/24
●	RF Connection Cable	HUBER+SUHNER	HTWE0062-02	SUCOFLEX104	501184/4	2022/02/25	2023/02/24
●	Test Software	R&S	N/A	ES-K1	N/A	N/A	N/A

● Radiated emission-7th test site							
Used	Test Equipment	Manufacturer	Equipment No.	Model No.	Serial No.	Last Cal. Date (YY-MM-DD)	Next Cal. Date (YY-MM-DD)
●	Semi-Anechoic Chamber	Albatross projects	HTWE0122	SAC-3m-01	C11121	2018/09/27	2023/09/26
●	Spectrum Analyzer	R&S	HTWE0098	FSP40	100597	2022/08/25	2023/08/24
●	Horn Antenna	SCHWARZBECK	HTWE0126	9120D	1011	2020/04/01	2023/03/31
●	Broadband Pre-amplifier	SCHWARZBECK	HTWE0201	BBV 9718	9718-248	2022/02/28	2023/02/27
●	RF Connection Cable	HUBER+SUHNER	HTWE0126-01	RE-7-FH	N/A	2022/03/04	2023/03/03
●	Test Software	Audix	N/A	E3	N/A	N/A	N/A

5. TEST CONDITIONS AND RESULTS

5.1. Conducted Emissions

LIMIT

FCC CFR Title 47 Part 15 Subpart B Section 15.107:

Frequency range (MHz)	Limit (dBuV)	
	Quasi-peak	Average
0.15-0.5	66 to 56*	56 to 46*
0.5-5	56	46
5-30	60	50

* Decreases with the logarithm of the frequency.

TEST CONFIGURATION

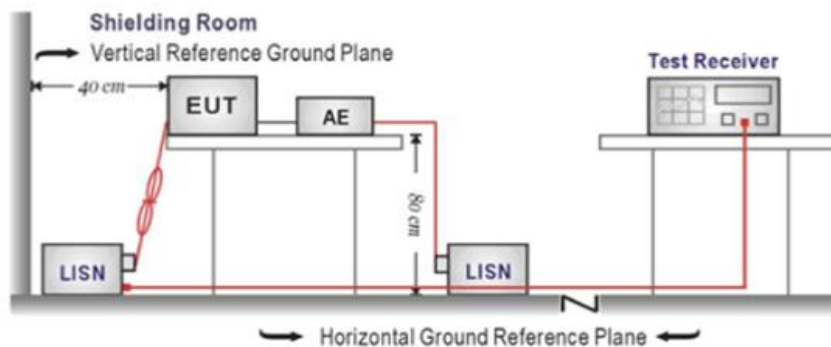

TEST PROCEDURE

1. The EUT was setup according to ANSI C63.4:2014
2. The EUT was placed on a plat form of nominal size, 1 m by 1.5 m, raised 80 cm above the conducting ground plane. The vertical conducting plane was located 40 cm to the rear of the EUT. All other surfaces of EUT were at least 80 cm from any other grounded conducting surface.
3. The EUT and simulators are connected to the main power through a line impedance stabilization network (LISN). The LISN provides a 50ohm / 50uH coupling impedance for the measuring equipment.
4. The peripheral devices are also connected to the main power through a LISN. (Please refer to the block diagram of the test setup and photographs)
5. Each current-carrying conductor of the EUT power cord, except the ground (safety) conductor, was individually connected through a LISN to the input power source.
6. The excess length of the power cord between the EUT and the LISN receptacle were folded back and forth at the center of the lead to form a bundle not exceeding 40 cm in length.
7. Conducted emissions were investigated over the frequency range from 0.15MHz to 30MHz using a receiver bandwidth of 9 kHz.
8. During the above scans, the emissions were maximized by cable manipulation.

TEST MODE:

Please refer to the clause 3.3

TEST RESULTS

Passed Not Applicable

Test Line:

L

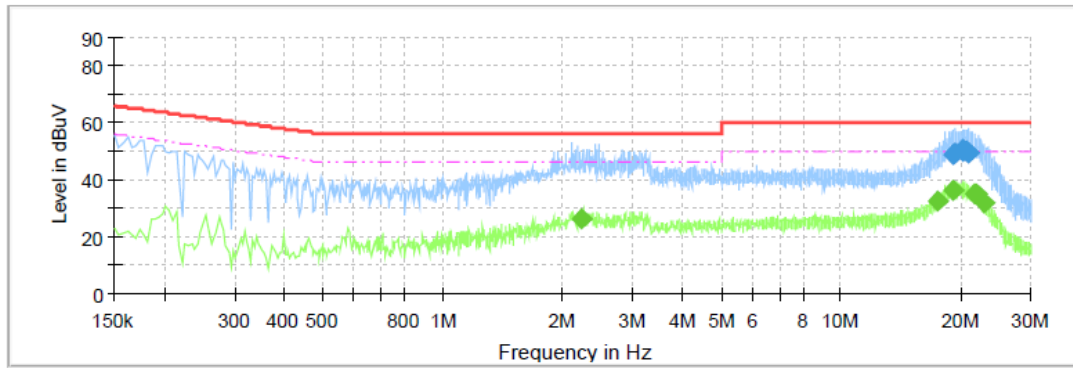

Final Result

Frequency (MHz)	QuasiPeak (dBuV)	CAverage (dBuV)	Limit (dBuV)	Margin (dB)	Line	Corr. (dB)
2.235500	---	26.47	46.00	19.53	L1	10.2
17.488500	---	32.54	50.00	17.46	L1	10.7
19.099500	---	36.46	50.00	13.54	L1	10.8
19.199500	48.90	---	60.00	11.10	L1	10.8
19.399500	49.36	---	60.00	10.64	L1	10.8
20.207500	50.06	---	60.00	9.94	L1	10.8
20.343500	50.40	---	60.00	9.60	L1	10.8
20.616500	50.29	---	60.00	9.71	L1	10.8
20.879500	49.54	---	60.00	10.46	L1	10.8
21.683500	---	35.10	50.00	14.90	L1	10.9
21.827500	---	34.88	50.00	15.12	L1	10.9
22.795500	---	32.13	50.00	17.87	L1	10.9

Test Line:

N

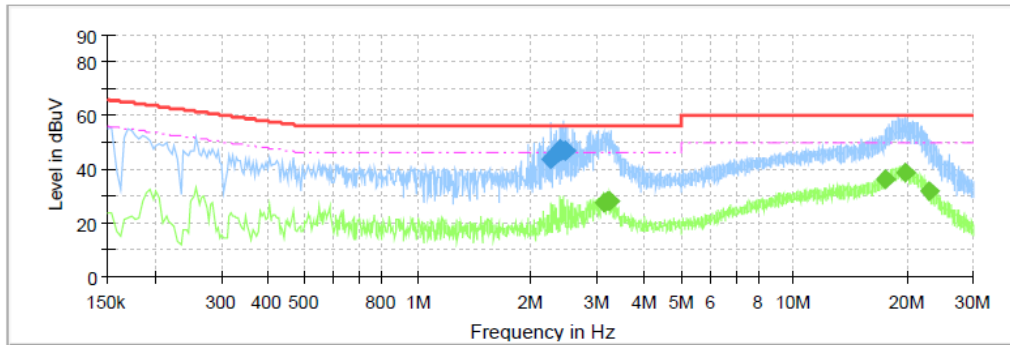

Final Result

Frequency (MHz)	QuasiPeak (dBuV)	CAverage (dBuV)	Limit (dBuV)	Margin (dB)	Line	Corr. (dB)
2.267500	43.82	---	56.00	12.18	N	10.1
2.367500	46.23	---	56.00	9.77	N	10.1
2.395500	47.63	---	56.00	8.37	N	10.1
2.415500	47.07	---	56.00	8.93	N	10.1
2.459500	46.63	---	56.00	9.37	N	10.1
2.467500	47.06	---	56.00	8.94	N	10.1
3.120500	---	27.67	46.00	18.33	N	10.2
3.183500	---	28.37	46.00	17.63	N	10.2
3.235500	---	28.13	46.00	17.87	N	10.2
17.543500	---	36.37	50.00	13.63	N	10.6
19.727500	---	38.78	50.00	11.22	N	10.7
22.839500	---	31.74	50.00	18.26	N	10.8

5.2. Radiated Emissions

LIMIT

FCC CFR Title 47 Part 15 Subpart B Section 15.109

Frequency	Limit (dBuV/m @3m)	Value
30MHz-88MHz	40.00	Quasi-peak
88MHz-216MHz	43.50	Quasi-peak
216MHz-960MHz	46.00	Quasi-peak
960MHz-1GHz	54.00	Quasi-peak
Above 1GHz	54.00	Average
	74.00	Peak

TEST CONFIGURATION

➤ 30MHz ~ 1GHz

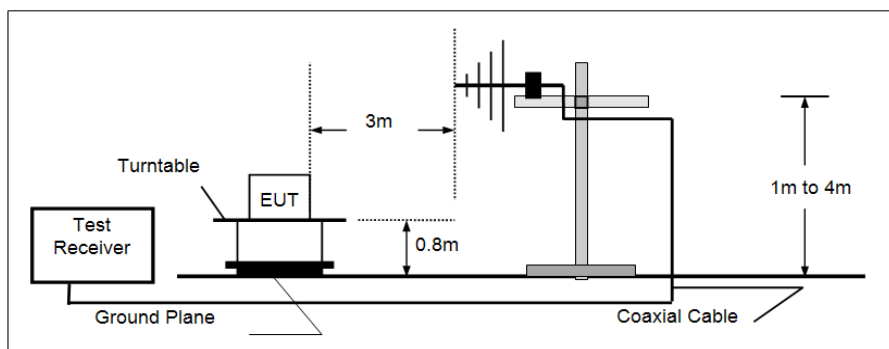

➤ Above 1GHz

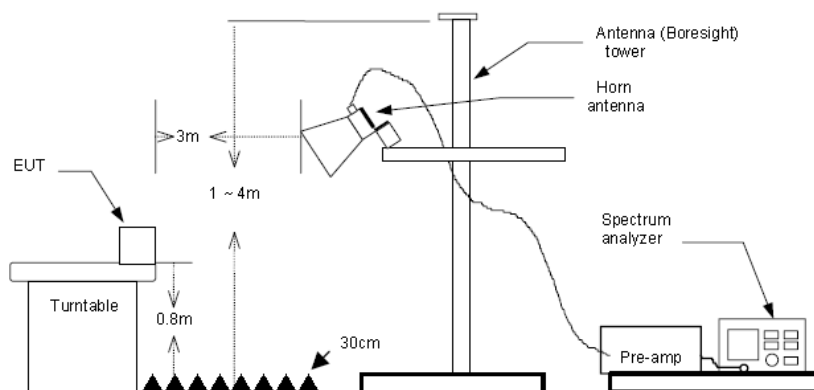

TEST PROCEDURE

1. The EUT was tested according to ANSI C63.4:2014.
2. The EUT is placed on a turn table which is 0.8 meter above ground.
3. The turn table is rotated 360 degrees to determine the position of the maximum emission level.
4. The EUT was positioned such that the distance from antenna to the EUT was 3 meters.
5. The antenna is scanned from 1 meter to 4 meters to find out the maximum emission level. This is repeated for both horizontal and vertical polarization of the antenna.
6. Use the following spectrum analyzer settings
 - (1) Span shall wide enough to fully capture the emission being measured;
 - (2) Below 1GHz,
RBW=120KHz, VBW=300KHz, Sweep=auto, Detector function=peak, Trace=max hold;
If the emission level of the EUT measured by the peak detector is 3 dB lower than the applicable limit, the peak emission level will be reported. Otherwise, the emission measurement will be repeated using the quasi-peak detector and reported.
 - (3) From 1GHz to 5th harmonic, RBW=1MHz, VBW=3MHz

TEST MODE:

Please refer to the clause 3.3

TEST RESULTS

Passed **Not Applicable**

Note: Final Level = Receiver Read level + Antenna Factor + Cable Loss – Preamplifier Factor
The emission levels of frequency above 6GHz are very lower than limit and not show in test report.

Polarization:

Horizontal

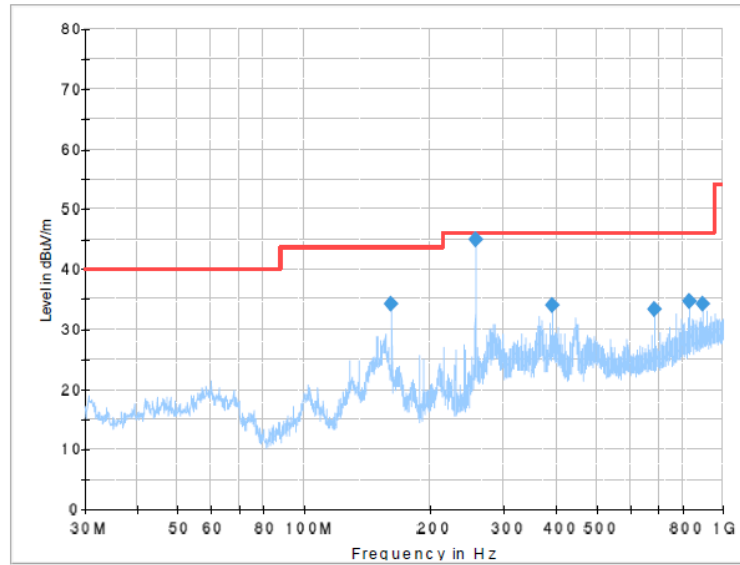

Final Result

Frequency (MHz)	MaxPeak (dBuV/m)	Limit (dBuV/m)	Margin (dB)	Height (cm)	Pol	Azimuth (deg)	Corr. (dB/m)
161.920000	34.19	43.50	9.31	100.0	H	262.0	-13.5
256.495000	44.85	46.00	1.15	100.0	H	50.0	-8.9
391.446250	34.00	46.00	12.00	100.0	H	61.0	-4.6
688.508750	33.22	46.00	12.78	100.0	H	321.0	2.0
833.766250	34.68	46.00	11.32	100.0	H	298.0	5.0
897.786250	34.19	46.00	11.81	100.0	H	0.0	6.5

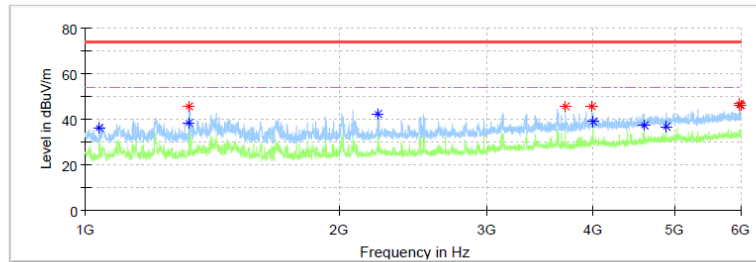

Critical Freqs

Frequency (MHz)	MaxPeak (dBuV/m)	Average (dBuV/m)	Limit (dBuV/m)	Margin (dB)	Height (cm)	Pol	Azimuth (deg)	Corr. (dB/m)
1039.375000	---	36.15	54.00	17.85	150.0	H	0.0	-10.0
4009.375000	---	38.72	54.00	15.28	150.0	H	15.0	-1.7
4900.625000	---	36.61	54.00	17.39	150.0	H	29.0	2.6
3997.500000	45.69	---	74.00	28.31	150.0	H	114.0	-1.7
4603.750000	---	37.15	54.00	16.85	150.0	H	114.0	0.9
1328.125000	---	38.12	54.00	15.88	150.0	H	141.0	-8.2
5973.125000	46.46	---	74.00	27.54	150.0	H	197.0	5.5
5986.250000	45.85	---	74.00	28.15	150.0	H	197.0	5.5
5996.250000	45.88	---	74.00	28.12	150.0	H	197.0	5.6
1328.750000	45.45	---	74.00	28.55	150.0	H	238.0	-8.2
3712.500000	45.55	---	74.00	28.45	150.0	H	308.0	-3.2
2227.500000	---	42.34	54.00	11.66	150.0	H	322.0	-6.6

Polarization:

Vertical

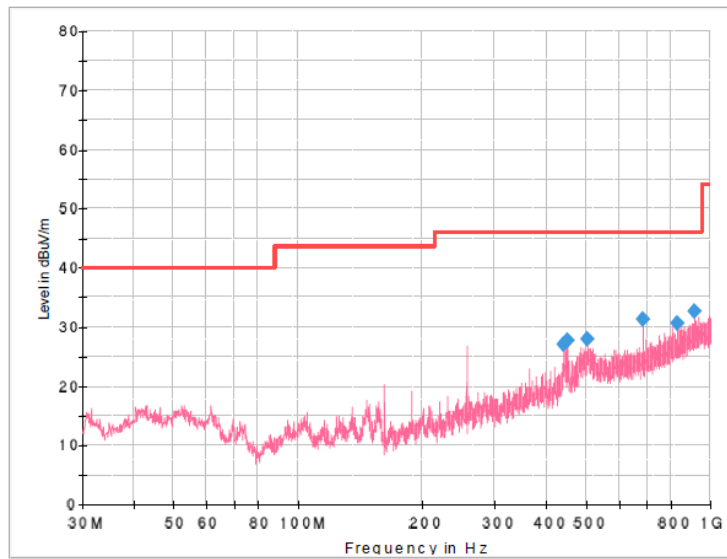

Final Result

Frequency (MHz)	MaxPeak (dBuV/m)	Limit (dBuV/m)	Margin (dB)	Height (cm)	Pol	Azimuth (deg)	Corr. (dB/m)
441.401250	27.09	46.00	18.91	100.0	V	178.0	-3.4
448.918750	27.64	46.00	18.36	100.0	V	160.0	-3.2
502.753750	27.88	46.00	18.12	100.0	V	196.0	-2.0
688.508750	31.37	46.00	14.63	100.0	V	248.0	2.0
833.645000	30.72	46.00	15.28	100.0	V	309.0	5.0
918.035000	32.53	46.00	13.47	100.0	V	0.0	6.8

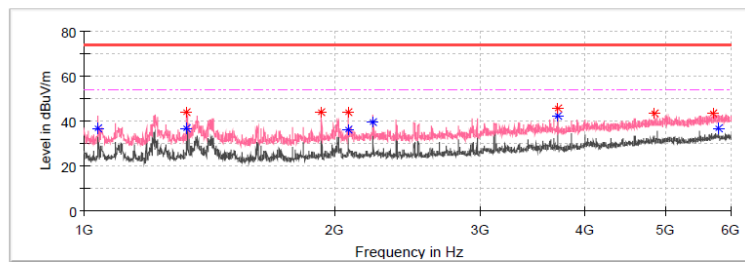

Critical Freqs

Frequency (MHz)	MaxPeak (dBuV/m)	Average (dBuV/m)	Limit (dBuV/m)	Margin (dB)	Height (cm)	Pol	Azimuth (deg)	Corr. (dB/m)
3712.500000	45.50	---	74.00	28.50	150.0	V	0.0	-3.2
3712.500000	---	42.47	54.00	11.53	150.0	V	0.0	-3.2
1327.500000	---	36.53	54.00	17.47	150.0	V	22.0	-8.2
1328.750000	43.93	---	74.00	30.07	150.0	V	22.0	-8.2
1930.625000	44.02	---	74.00	29.98	150.0	V	36.0	-8.6
1039.375000	---	36.76	54.00	17.24	150.0	V	205.0	-10.0
2078.750000	---	36.36	54.00	17.64	150.0	V	329.0	-7.6
2079.375000	43.89	---	74.00	30.11	150.0	V	329.0	-7.6
5718.125000	43.51	---	74.00	30.49	150.0	V	329.0	4.6
4854.375000	43.28	---	74.00	30.72	150.0	V	348.0	2.3
2227.500000	---	39.43	54.00	14.57	150.0	V	359.0	-6.6
5791.875000	---	36.52	54.00	17.48	150.0	V	359.0	5.1

6. TEST SETUP PHOTOS

Conducted Emissions (AC Mains)



Radiated Emissions (30MHz-1GHz)



Radiated Emissions (Above 1GHz)

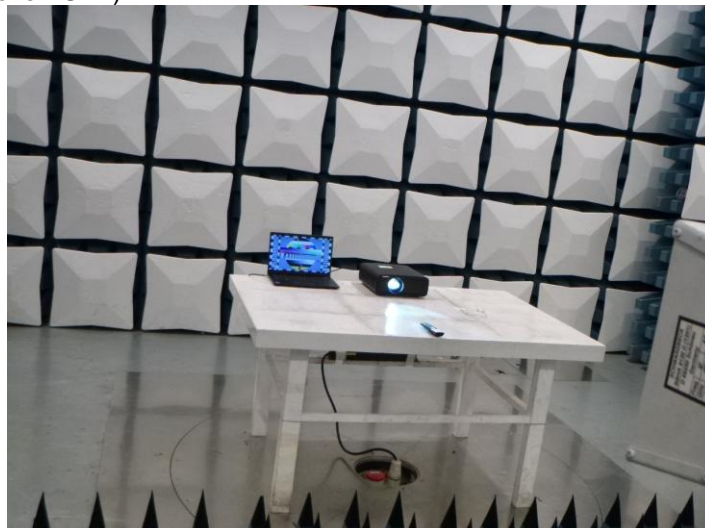

7. EXTERNAL AND INTERNAL PHOTOS

External Photos





Internal Photos

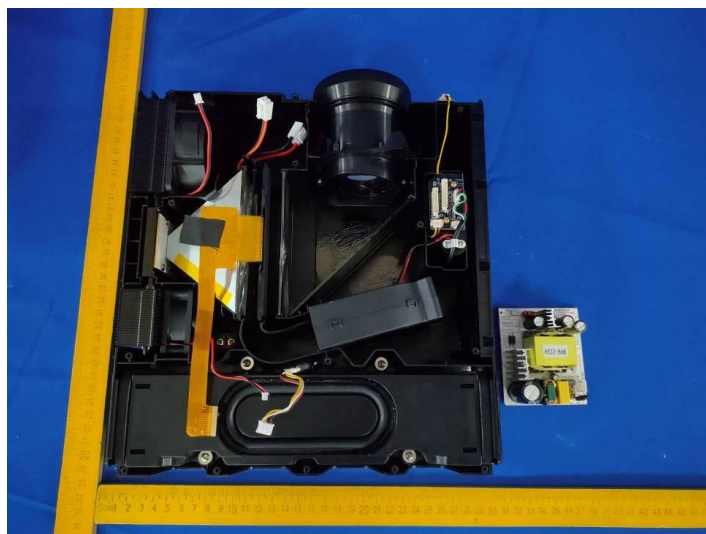

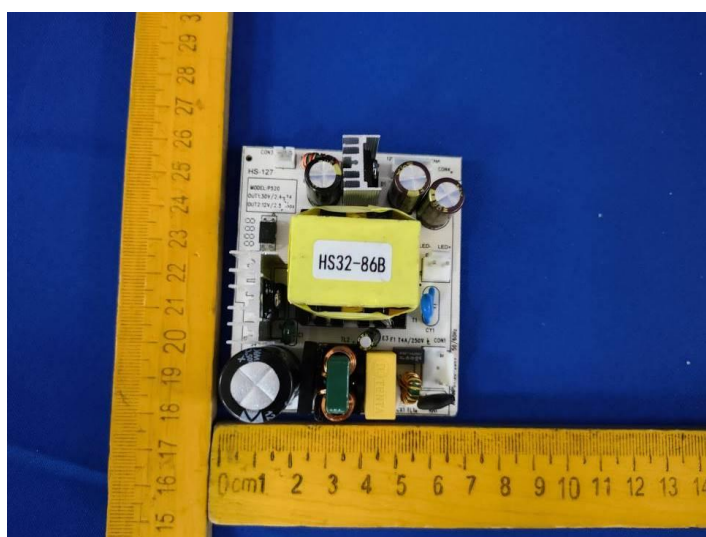
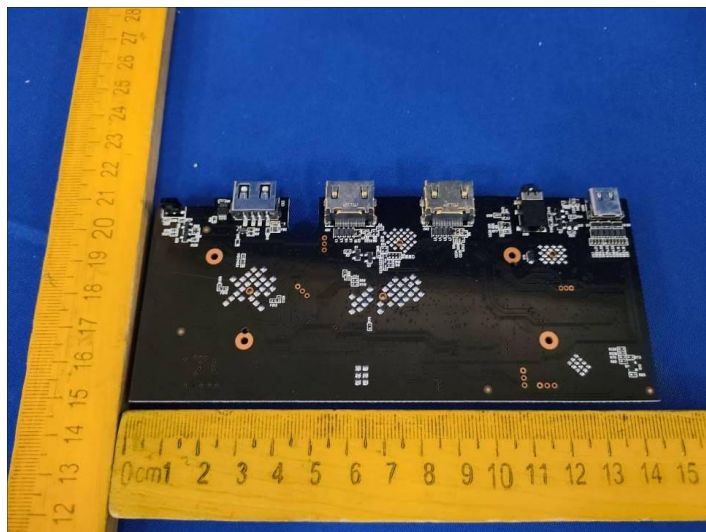
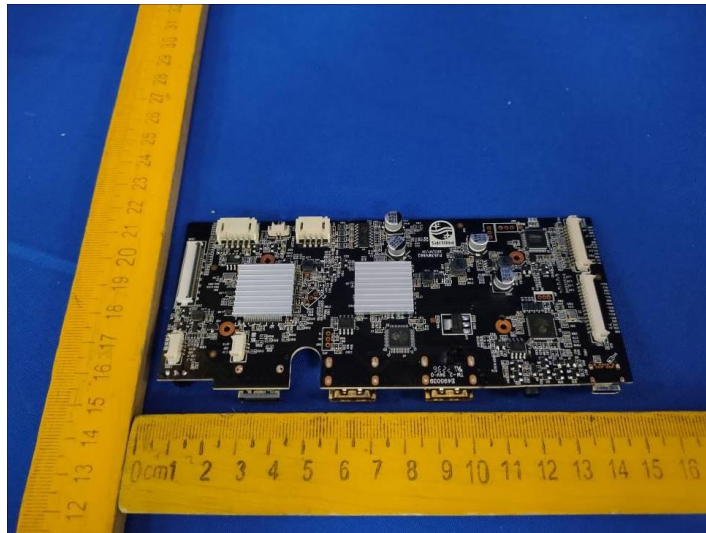

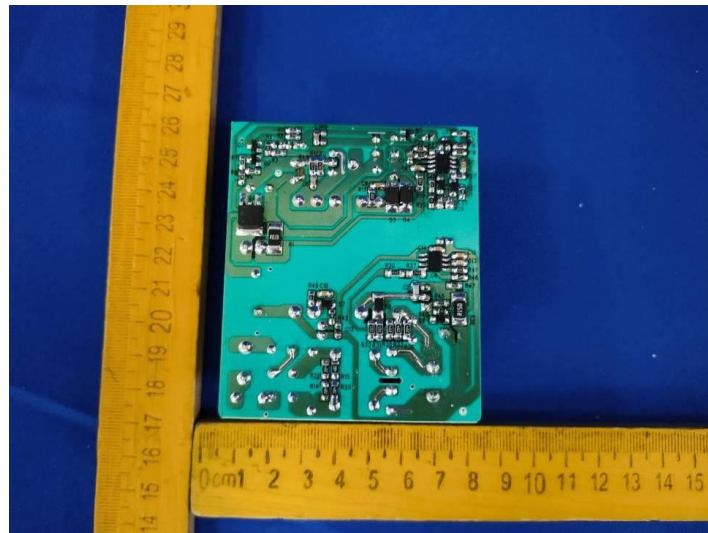

-----End of Report-----