



FCC RADIO TEST REPORT

Applicant : SHENZHEN XFANIC TECHNOLOGY CO.,LTD
Address : 1-4/F, Block 2, Longcheng Industrial Area, Dalang
Subdistrict, Longhua District, Shenzhen,China
Equipment : Audio Dock
Model No. : JCDS335, XF-A3101B
Trade Name : N/A
FCC ID : 2ASRI-A3101B
Standard : FCC part 15 Subpart C §15.247

I HEREBY CERTIFY THAT :

The sample was received on Apr. 19, 2023 and the testing was completed on May 05, 2023 at CerpPASS Technology Corp. The test result refers exclusively to the test presented test model / sample. Without written approval of CerpPASS Technology Corp., the test report shall not be reproduced except in full.

Approved by:

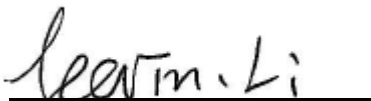
Leevin Li /Supervisor



Contents

1. Report of Measurements and Examinations	5
1.1 List of Measurements and Examinations	5
2. Test Configuration of Equipment under Test	6
2.1 Feature of Equipment under Test	6
2.2 Carrier Frequency of Channels	7
2.3 Test Mode & Test Software	8
2.5 Description of Test System	9
2.6 General Information of Test	10
2.7 Measurement Uncertainty	11
3. Test Equipment and Ancillaries Used for Tests	12
4. Antenna Requirements	14
4.1 Standard Applicable	14
4.2 Antenna Construction and Directional Gain	14
5. Test of Conducted Emission	15
5.1 Test Limit	15
5.2 Test Procedures	15
5.3 Typical Test Setup	16
5.4 Test Result and Data	17
6. Test of Radiated Emission	19
6.1 Test Limit	19
6.2 Test Procedures	20
6.3 Typical Test Setup	21
6.4 Test Result and Data (9kHz ~ 30MHz)	22
6.5 Test Result and Data (30MHz ~ 1GHz)	22
6.6 Test Result and Data (1GHz ~ 25GHz)	24
6.7 Restricted Bands of Operation	42
7. Test of Conducted Spurious Emission	43
7.1 Test Limit	43
7.2 Test Procedure	43
7.3 Test Setup Layout	43
7.4 Test Result and Data	43
8. 20dB Bandwidth Measurement Data	49
8.1 Test Limit	49
8.2 Test Procedures	49
8.3 Test Setup Layout	49
8.4 Test Result and Data	49
9. Frequencies Separation	52
9.1 Test Limit	52
9.2 Test Procedures	52
9.3 Test Setup Layout	52
9.4 Test Result and Data	52
10. Dwell Time on each channel	55



10.1	Test Limit	55
10.2	Test Procedures	55
10.3	Test Setup Layout	55
10.4	Test Result and Data	55
11.	Number of Hopping Channels	59
11.1	Test Limit	59
11.2	Test Procedures	59
11.3	Test Setup Layout	59
11.4	Test Result and Data	59
12.	Maximum Peak Output Power	61
12.1	Test Limit	61
12.2	Test Procedures	61
12.3	Test Setup Layout	61
12.4	Test Result and Data	61



History of this test report

Version No.	Report No	Date	Description
Rev.01	DEFB2302145	May 05, 2023	Initial Issue



1. Report of Measurements and Examinations

1.1 List of Measurements and Examinations

ANSI C63.10: 2013

KDB 558074 D01 DTS Meas Guidance v05r02

FCC Rules and Regulations Part 15 Subpart C §15.247

FCC Rule	Description of Test	Result
§ 15.203	. Antenna Requirement	Pass
§ 15.207(a)	. Conducted Emission	Pass
§ 15.209(a)	. Radiated Emission	Pass
§ 15.247(a)(1)	. Channel Carrier Frequencies Separation	Pass
§ 15.247(a)(1)	. 20dB Bandwidth Measurement	Pass
§ 15.247(a)(1)	. Dwell Time	Pass
§ 15.247(b)	. Number of Hopping Channels	Pass
§ 15.247(b)	. Peak Output Power Measurement Data	Pass
§ 15.247(d)	. Band Edges Measurement Data	Pass

Note: Deviations Yes No ■

*The lab has reduced the uncertainty risk factor from test equipment, environment and staff technicians which according to the standard on contract. Therefore, the test result will only be determined by standard requirement.



2. Test Configuration of Equipment under Test

2.1 Feature of Equipment under Test

Equipment	Audio Dock
Model Name	JCDS335, XF-A3101B
Model Discrepancy	The rest of the circuit design, layout, components used, and internal wiring are the same, only keyboard and model number is different.
Frequency Range	2402MHz~2480MHz
Modulation Type	GFSK, $\pi/4$ -DQPSK, 8DPSK
Data Rate	GFSK: 1Mbps, $\pi/4$ -DQPSK: 2Mbps, 8DPSK: 3Mbps
Operating Voltage	Input: 20V 5A
Antenna Gain.	-0.68dBi
Antenna Type	PCB Antenna
Working Temperature	0°C to +40°C

Note: For a more detailed features description, please refer to the manufacturer's specifications or the User's Manual.



2.2 Carrier Frequency of Channels

Channel	Frequency (MHz)	Channel	Frequency (MHz)	Channel	Frequency (MHz)	Channel	Frequency (MHz)
00	2402	20	2422	40	2442	60	2462
01	2403	21	2423	41	2443	61	2463
02	2404	22	2424	42	2444	62	2464
03	2405	23	2425	43	2445	63	2465
04	2406	24	2426	44	2446	64	2466
05	2407	25	2427	45	2447	65	2467
06	2408	26	2428	46	2448	66	2468
07	2409	27	2429	47	2449	67	2469
08	2410	28	2430	48	2450	68	2470
09	2411	29	2431	49	2451	69	2471
10	2412	30	2432	50	2452	70	2472
11	2413	31	2433	51	2453	71	2473
12	2414	32	2434	52	2454	72	2474
13	2415	33	2435	53	2455	73	2475
14	2416	34	2436	54	2456	74	2476
15	2417	35	2437	55	2457	75	2477
16	2418	36	2438	56	2458	76	2478
17	2419	37	2439	57	2459	77	2479
18	2420	38	2440	58	2460	78	2480
19	2421	39	2441	59	2461	---	---



2.3 Test Mode & Test Software

- a. During testing, the interface cables and equipment positions were varied according to ANSI C63.10
- b. The complete test system included Notebook, adapter and EUT for RF test.
- c. Run the test software “BK32xx RF Test.exe (Ver.: 1.8.2)” under WIN10 System was executed to transmit and receive data via Bluetooth.
- d. The following test modes were performed for the test:

Conducted Emissions from the AC mains power ports	
Test Mode	Operating Description
Mode 1	GFSK (1Mbps) for JCDS335 (AC 120V)
Mode 2	$\pi/4$ -DQPSK (2Mbps) for JCDS335 (AC 120V)
Mode 3	8DPSK (3Mbps) for JCDS335 (AC 120V)
Mode 4	8DPSK (3Mbps) for JCDS335 (AC 240V)
Mode 5	8DPSK (3Mbps) for XF-A3101B (AC 120V)
caused “Test Mode 3 at CH78:2480” generated the worst case, it was reported as the final data.	
Radiation Emissions (Below GHz)	
Test Mode	Operating Description
1	GFSK (1Mbps) for JCDS335
2	$\pi/4$ -DQPSK (2Mbps) for JCDS335
3	8DPSK (3Mbps) for JCDS335
4	8DPSK (3Mbps) for XF-A3101B
caused “Test Mode 3 at CH78:2480” generated the worst case, it was reported as the final data.	
Radiation Emissions (1GHz ~ 25GHz)	
Test Mode	Operating Description
1	GFSK (1Mbps) for JCDS335
2	$\pi/4$ -DQPSK (2Mbps) for JCDS335
3	8DPSK (3Mbps) for JCDS335
caused “Test Mode 1,2, 3” generated the worst case, it was reported as the final data.	



2.4 Power Parameter Value of the test software

Mode	Frequency (MHz)	Power Setting
GFSK (1Mbps)	2402	3
	2441	3
	2480	3
$\pi/4$ -DQPSK (2Mbps)	2402	3
	2441	3
	2480	3
8DPSK (3Mbps)	2402	3
	2441	3
	2480	3

2.5 Description of Test System

Product	Manufacturer	Model No.	Power Cord
1 Notebook	SONY	EMC NB-002	Non-Shielded, 1.8m
2 Adapter	OTTERBOX	OBFTC-0067-A	N/A

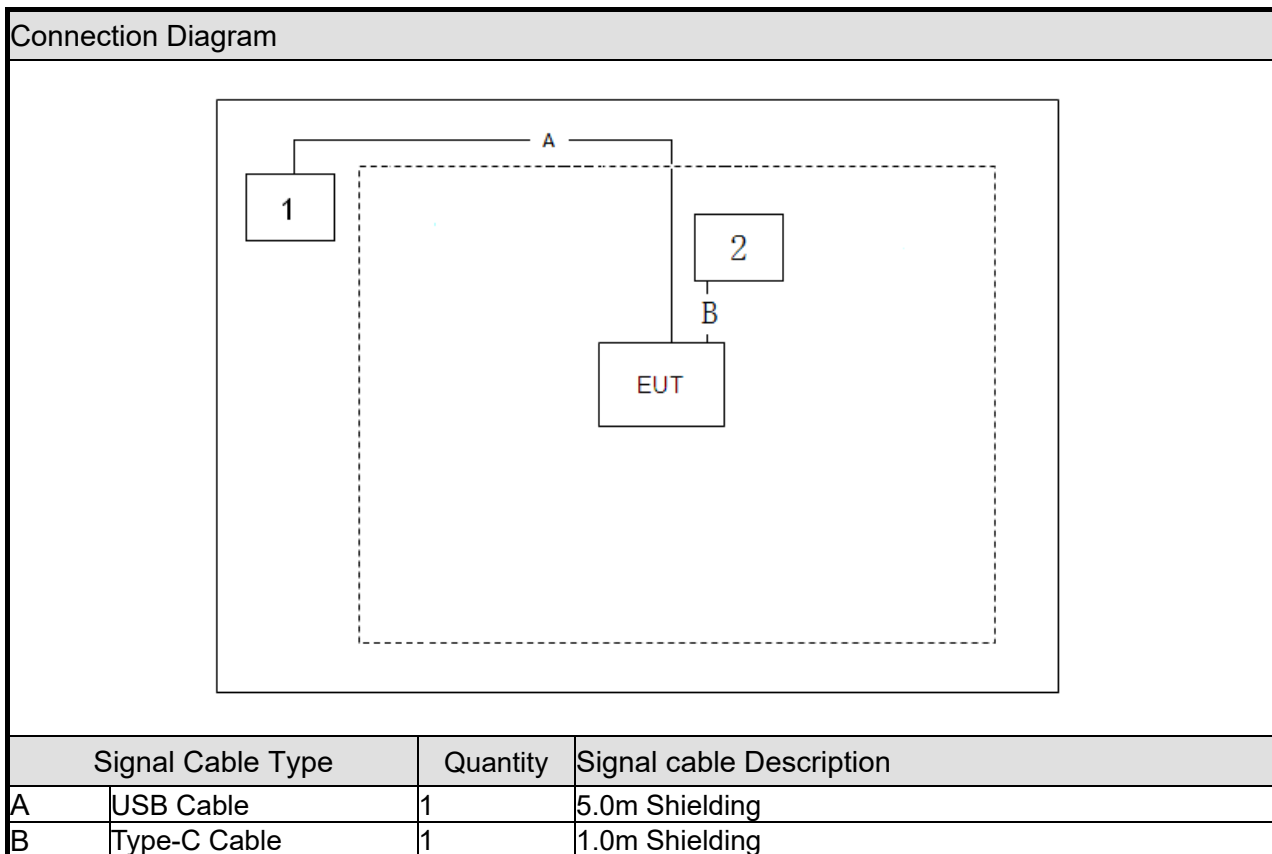



2.6 General Information of Test

Test Site	CerpPASS Technology Corporation(CerpPASS Laboratory) Address: Room 102, No. 5, Xing'an Road, Chang'an Town, Dongguan City, Guangdong Province Tel: +86-769-8547-1212 Fax: +86-769-8547-1912
FCC Designation No.:	CN1288
Frequency Range Investigated:	Conducted: from 150kHz to 30 MHz Radiation: from 30 MHz to 25,000MHz
Test Distance:	The test distance of radiated emission from antenna to EUT is 3 M.

Test Item	Test Site	Test period	Environmental Conditions	Tested By
RF Conducted	RFCON01-DG	2023/04/20~2023/05/05	23~24°C / 54~55%	Amos Zhang
Radiated Emissions	3M01-DG	2023/04/23~2023/04/26	23~25°C / 55~57%	Amos Zhang
AC Power Line Conducted Emission	CON01-DG	2023/4/25	23°C / 57%	Amos Zhang



2.7 Measurement Uncertainty

ISO/IEC 17025 requires that an estimate of the measurement uncertainties associated with the emissions test results be included in the report. The measurement uncertainties given below are based on a 95% confidence level (based on a coverage factor (k=2)).

Measurement Item	Uncertainty
AC Power Line Conduction(150K~30MHz)	±2.60dB
Radiated Spurious Emission(9KHz~30MHz)	±4.99dB
Radiated Spurious Emission(30MHz~1GHz)	±4.39dB
Radiated Spurious Emission(1GHz~18GHz)	±5.36dB
Radiated Spurious Emission(18GHz~40GHz)	±5.43dB
6dB Bandwidth&20dB Bandwidth	±4.4%
Occupied Bandwidth	±4.4%
Peak Output Power(Conducted Power Meter)	±0.57 dB
Power Spectral Density	±1.01 dB
Dwell Time / Deactivation Time	±1.1%



3. Test Equipment and Ancillaries Used for Tests

AC Power Line Conducted Emission					
Test Site	CON01-DG				
Instrument/Ancillary	Manufacturer	Model No.	Serial No.	Calibration Date	Valid Date.
Test Receiver	R&S	ESCI	100564	2023.01.06	2024.01.05
LISN	SCHWARZBECK	NSLK 8127	8127748	2023.01.06	2024.01.05
LISN	R&S	ENV216	100024	2023.01.06	2024.01.05
ISN	TESEQ	ISN T800	42809	2022.05.07	2023.05.06
Pulse Limiter with 10dB Attenuation	SCHWARZBECK	VTSD 9561-F	9561-F106	2023.01.06	2024.01.05
Temperature/ Humidity Meter	GEMLEAD	STH200A	N/A	2022.08.05	2023.08.04

Radiated Emissions					
Test Site	3M01-DG				
Instrument	Manufacturer	Model No.	Serial No.	Calibration Date	Valid Date
EMI Test Receiver	R&S	ESCI	100565	2022.05.07	2023.05.06
Amplifier	EMCI	EMC330	980082	2022.05.07	2023.05.06
Loop Antenna	R&S	HFH2-Z2	100150	2022.05.11	2024.05.10
Bilog Antenna	Sunol Science	JB6	A111218	2023.01.12	2025.01.11
Preamplifier	Agilent	8449B	3008A02342	2023.01.06	2024.01.05
Preamplifier	COM-POWER	PA-840	711885	2022.05.07	2023.05.06
Broad-Band Horn Antenna	Schwarzbeck	BBHA9120D	9120D-619	2022.05.22	2024.05.21
Standard Gain Horn Antenna	TRC	HA-2640	18050	2022.05.09	2024.05.08
Standard Gain Horn Antenna	TRC	HA-1726	18051	2022.05.09	2024.05.08
FSQ Signal Analyzer	R&S	FSQ40	200012	2022.05.07	2023.05.06
Temperature/ Humidity Meter	GEMLEAD	STH200A	N/A	2022.08.05	2023.08.04



RF Conducted					
Test Site	RFCON01-DG				
Instrument	Manufacturer	Model No.	Serial No.	Calibration Date	Valid Date
MXA Signal Analyzer	KEYSIGHT	N9020A	US46220290	2022.05.07	2023.05.06
EXA Signal Analyzer	KEYSIGHT	N9010A	MY53400169	2022.05.07	2023.05.06
ESG VECTOR SIGNAL GENERATOR	Agilent	E4438C	MY45092582	2022.05.07	2023.05.06
MXG VECTOR SIGNAL GENERATOR	Agilent	N5182B	MY53050127	2022.05.07	2023.05.06
USB Wideband Power Sensor	Boonton	55006	9778	2023.01.06	2024.01.05
Temperature/ Humidity Meter	mingle	ETH529	N/A	2023.01.06	2024.01.05



4. Antenna Requirements

4.1 Standard Applicable

For intentional device, according to FCC 47 CFR Section 15.203, an intentional radiator shall be designed to ensure that no antenna other than that furnished by the responsible party shall be used with the device.

And according to FCC 47 CFR Section 15.247 (b), if transmitting antennas of directional gain greater than 6dBi are used, the power shall be reduced by the amount in dB that the directional gain of the antenna exceeds 6dBi.

4.2 Antenna Construction and Directional Gain

Antenna Type	PCB Antenna
Antenna Gain	-0.68dBi



5. Test of Conducted Emission

5.1 Test Limit

Conducted Emissions were measured from 150 kHz to 30 MHz with a bandwidth of 9 KHz on the 120 VAC power and return leads of the EUT according to the methods defined in ANSI C63.10-2013. The EUT was placed on a nonmetallic stand in a shielded room 0.8 meters above the ground plane as shown in section 6.2.2. The interface cables and equipment positioning were varied within limits of reasonable applications to determine the position produced maximum conducted emissions

Frequency (MHz)	Quasi Peak (dB μ V)	Average (dB μ V)
0.15 – 0.5	66-56*	56-46*
0.5 – 5.0	56	46
5.0 – 30.0	60	50

*Decreases with the logarithm of the frequency.

5.2 Test Procedures

- The EUT was placed 0.4 meter from the conducting wall of the shielding room was kept at least 80 centimeters from any other grounded conducting surface.
- Connect EUT to the power mains through a line impedance stabilization network (LISN).
- All the support units are connecting to the other LISN.
- The LISN provides 50 ohm coupling impedance for the measuring instrument.
- The FCC states that a 50 ohm, 50 micro-Henry LISN should be used.
- Both sides of AC line were checked for maximum conducted interference.
- The frequency range from 150 kHz to 30 MHz was searched.
- Set the test-receiver system to Peak Detect Function and Specified Bandwidth with Maximum Hold Mode.



5.3 Typical Test Setup

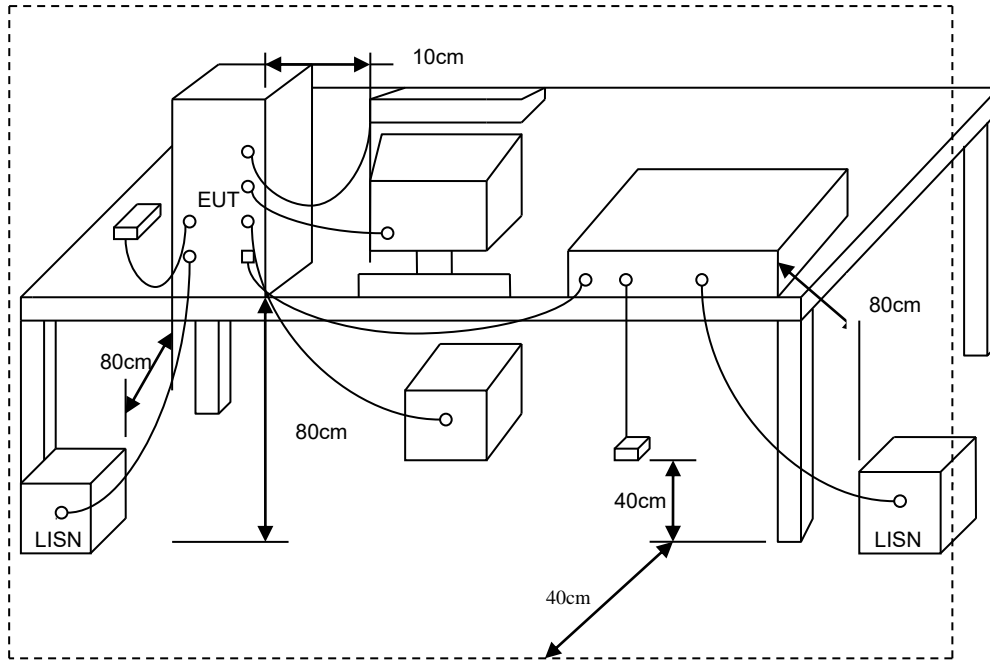



5.4 Test Result and Data

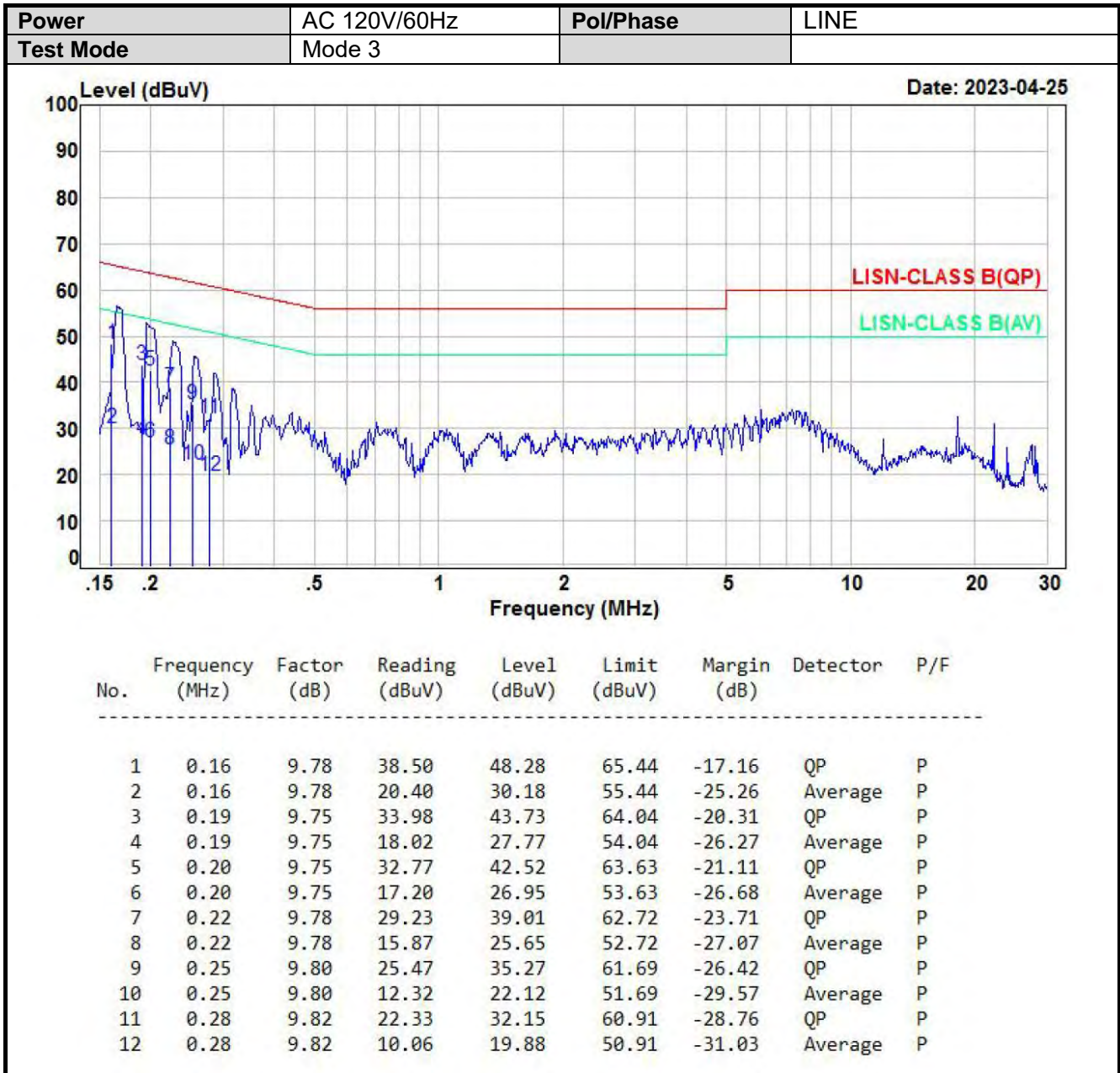

Note: Measurement Level = Reading Level + Correct Factor



Power	AC 120V/60Hz	Pol/Phase	NEUTRAL
Test Mode	Mode 3		

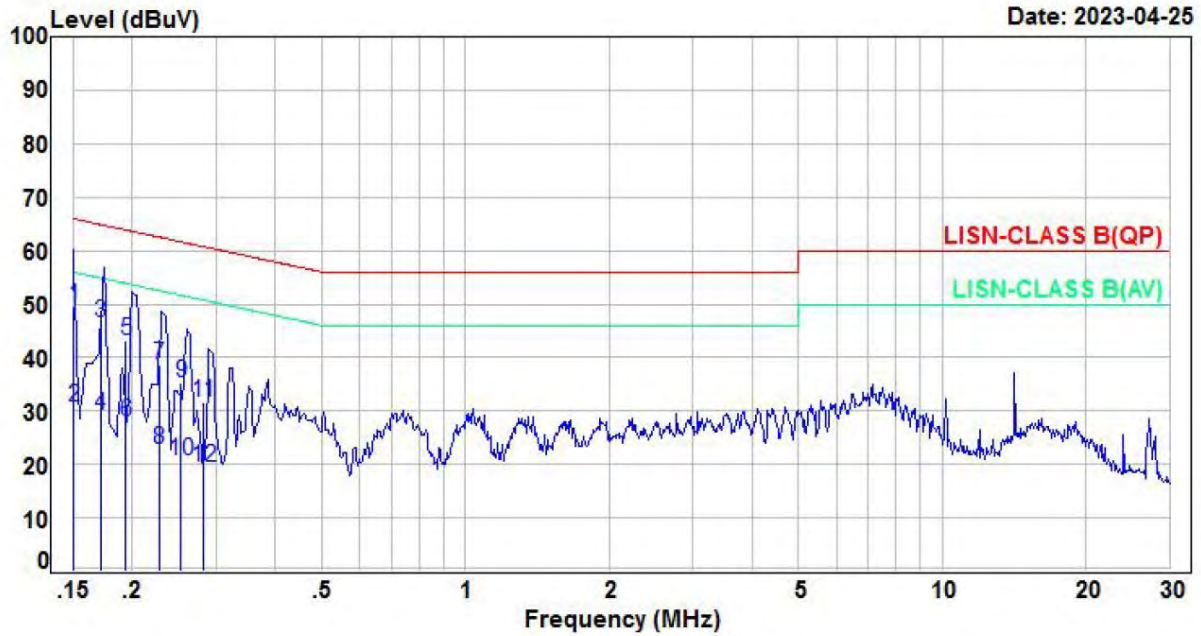

No.	Frequency (MHz)	Factor (dB)	Reading (dBuV)	Level (dBuV)	Limit (dBuV)	Margin (dB)	Detector	P/F
1	0.15	9.74	39.79	49.53	65.96	-16.43	QP	P
2	0.15	9.74	21.04	30.78	55.96	-25.18	Average	P
3	0.17	9.74	36.72	46.46	64.88	-18.42	QP	P
4	0.17	9.74	19.52	29.26	54.88	-25.62	Average	P
5	0.19	9.76	33.48	43.24	63.86	-20.62	QP	P
6	0.19	9.76	18.13	27.89	53.86	-25.97	Average	P
7	0.23	9.76	28.86	38.62	62.54	-23.92	QP	P
8	0.23	9.76	13.14	22.90	52.54	-29.64	Average	P
9	0.25	9.75	25.54	35.29	61.65	-26.36	QP	P
10	0.25	9.75	10.78	20.53	51.65	-31.12	Average	P
11	0.28	9.75	21.88	31.63	60.77	-29.14	QP	P
12	0.28	9.75	9.81	19.56	50.77	-31.21	Average	P

Note: Measurement Level = Reading Level + Correct Factor



6. Test of Radiated Emission

6.1 Test Limit

In any 100kHz bandwidth outside the frequency band in which the spread spectrum or digitally modulated intentional radiator is operating, the radio frequency power that is produced by the intentional radiator shall be at least 20dB below that in the 100kHz bandwidth within the band that contains the highest level of the desired power, based on either an RF conducted or a radiated measurement. If the transmitter measurement is based on the maximum conducted output power, the attenuation required under this paragraph shall be 30dB instead of 20dB. In addition, radiated emissions which fall in section 15.205(a) the restricted bands must also comply with the radiated emission limit specified in section 15.209(a).

FREQUENCIES(MHz)	FIELD STRENGTH(microvolts/meter)	MEASUREMENT DISTANCE(meters)
0.009~0.490	2400/F(kHz)	300
0.490~1.705	24000/F(kHz)	30
1.705~30.0	30	30
30~88	100	3
88~216	150	3
216~960	200	3
Above 960	500	3



6.2 Test Procedures

- a. The EUT was placed on a rotatable table top 0.8 meter above ground; above 1GHz, the height was 1.5m.
- b. The EUT was set 3 meters from the interference receiving antenna which was mounted on the top of a variable height antenna tower.
- c. The table was rotated 360 degrees to determine the position of the highest radiation.
- d. The antenna is a broadband antenna and its height is varied between one meter and four meters above ground to find the maximum value of the field strength both horizontal polarization and vertical polarization of the antenna are set to make the measurement.
- e. For each suspected emission the EUT was arranged to its worst case and then tune the antenna tower (from 1 M to 4 M) and turn table (from 0 degree to 360 degrees) to find the maximum reading.
- f. Set the test-receiver system to Peak or CISPR quasi-peak Detect Function and specified bandwidth with Maximum Hold Mode.
- g. If the emission level of the EUT in peak mode was 3 dB lower than the limit specified, then testing will be stopped and peak values of EUT will be reported, otherwise, the emissions which do not have 3 dB margin will be repeated one by one using the quasi-peak method and reported.
- h. For testing above 1GHz, the emission level of the EUT in peak mode was 20dB lower than average limit (that means the emission level in peak mode also complies with the limit in average mode), then testing will be stopped and peak values of EUT will be reported, otherwise, the emissions will be measured in average mode again and reported.
- i. "Cone of radiation" has been considered to be 3dB bandwidth of the measurement antenna.

Note: The supporting fixture shall permit orientation of the EUT in each of three orthogonal axis positions such that emissions from the EUT are maximized.

(X AXIS is the worst.)



6.3 Typical Test Setup

Below 30MHz test setup

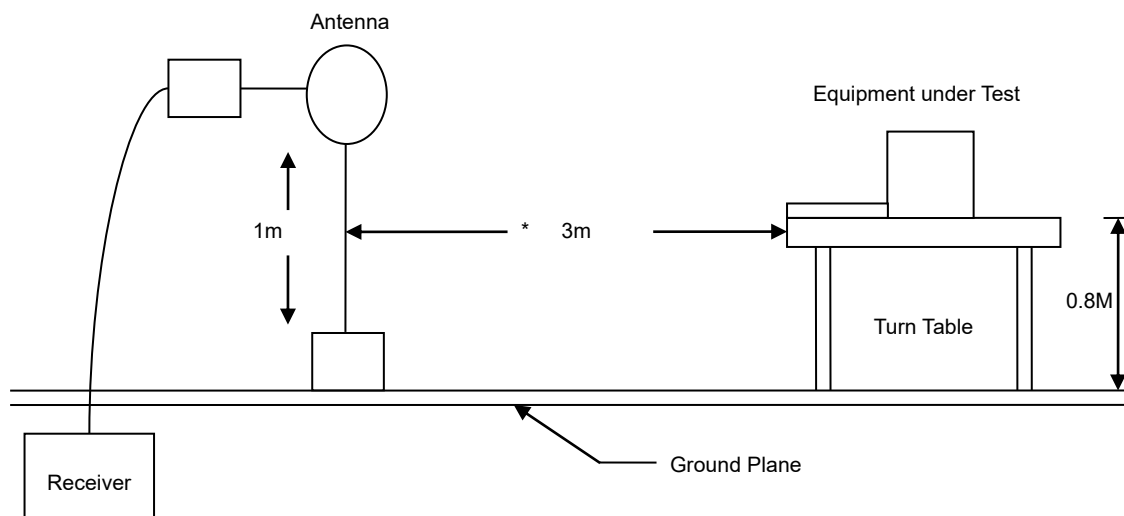

30MHz- 1GHz Test Setup

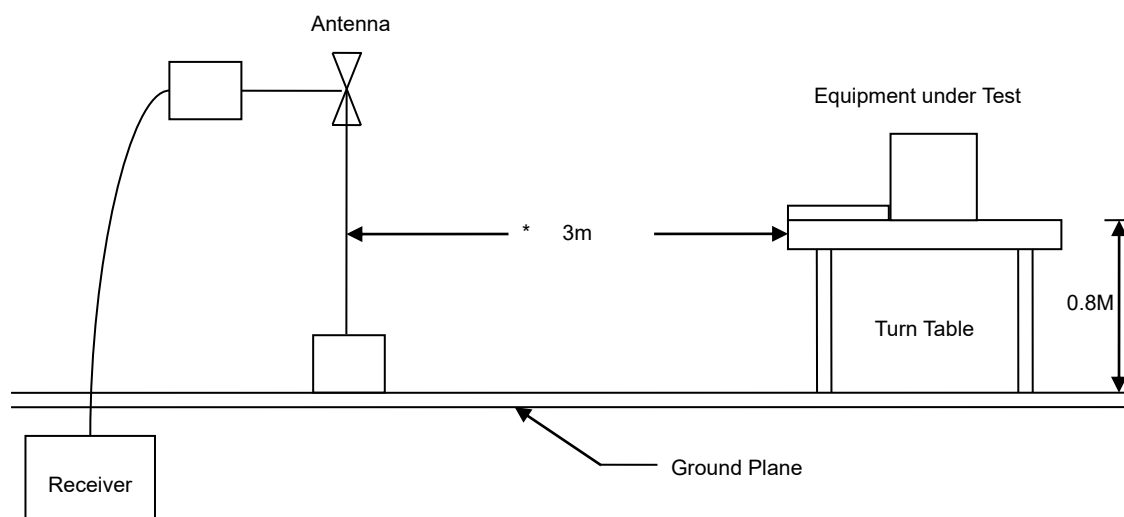

Above 1GHz Test Setup

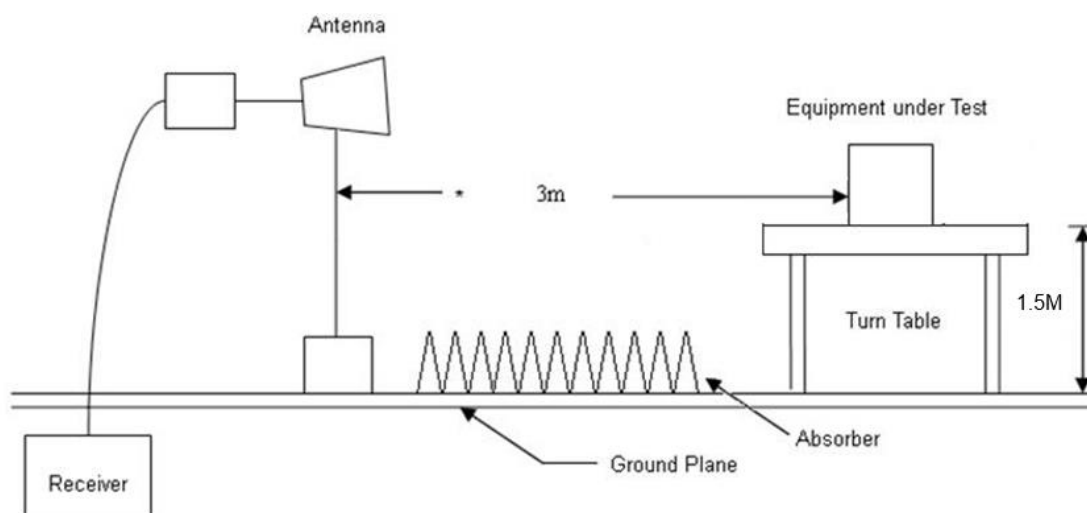



6.4 Test Result and Data (9kHz ~ 30MHz)

The 9kHz-30MHz spurious emission is under limit 20dB more.

6.5 Test Result and Data (30MHz ~ 1GHz)

Power	AC 120V/60Hz	Pol/Phase	VERTICAL
Test Mode	Mode 3		

Note : Level = Reading + Factor

Margin = Level – Limit

Factor = Antenna Factor + Cable Loss – Amplifier Factor

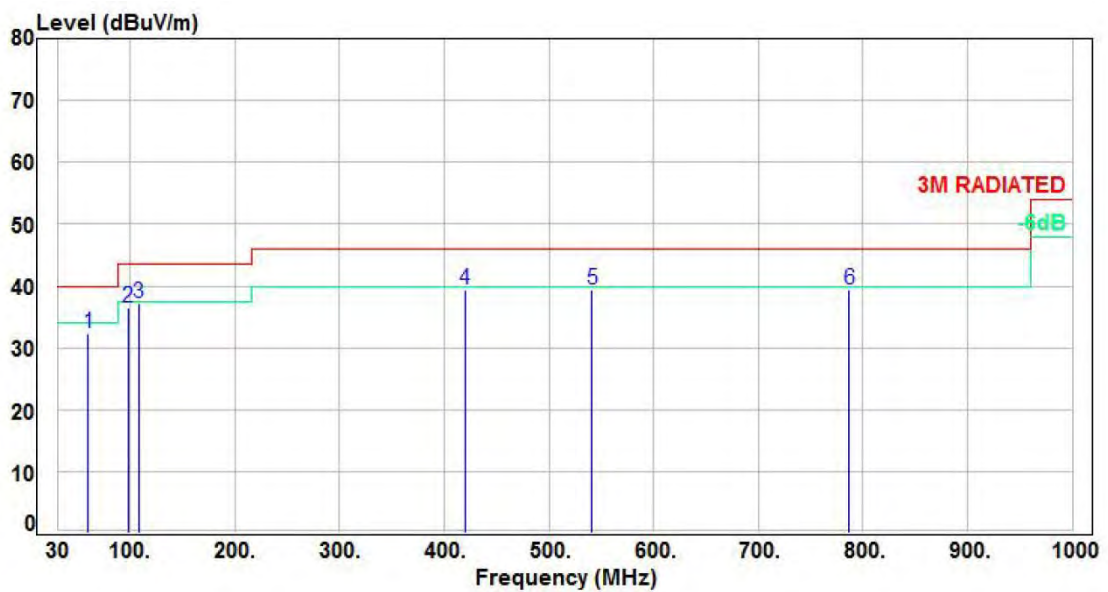

No.	Frequency (MHz)	Factor (dB/m)	Reading (dBuV)	Level (dBuV/m)	Limit (dBuV/m)	Margin (dB)	Detector	P/F
1	60.07	-17.02	49.43	32.41	40.00	-7.59	Peak	P
2	97.90	-14.17	50.57	36.40	43.50	-7.10	Peak	P
3	107.60	-11.63	48.90	37.27	43.50	-6.23	Peak	P
4	419.94	-5.80	45.18	39.38	46.00	-6.62	Peak	P
5	541.19	-3.42	42.93	39.51	46.00	-6.49	Peak	P
6	786.60	0.58	38.72	39.30	46.00	-6.70	Peak	P

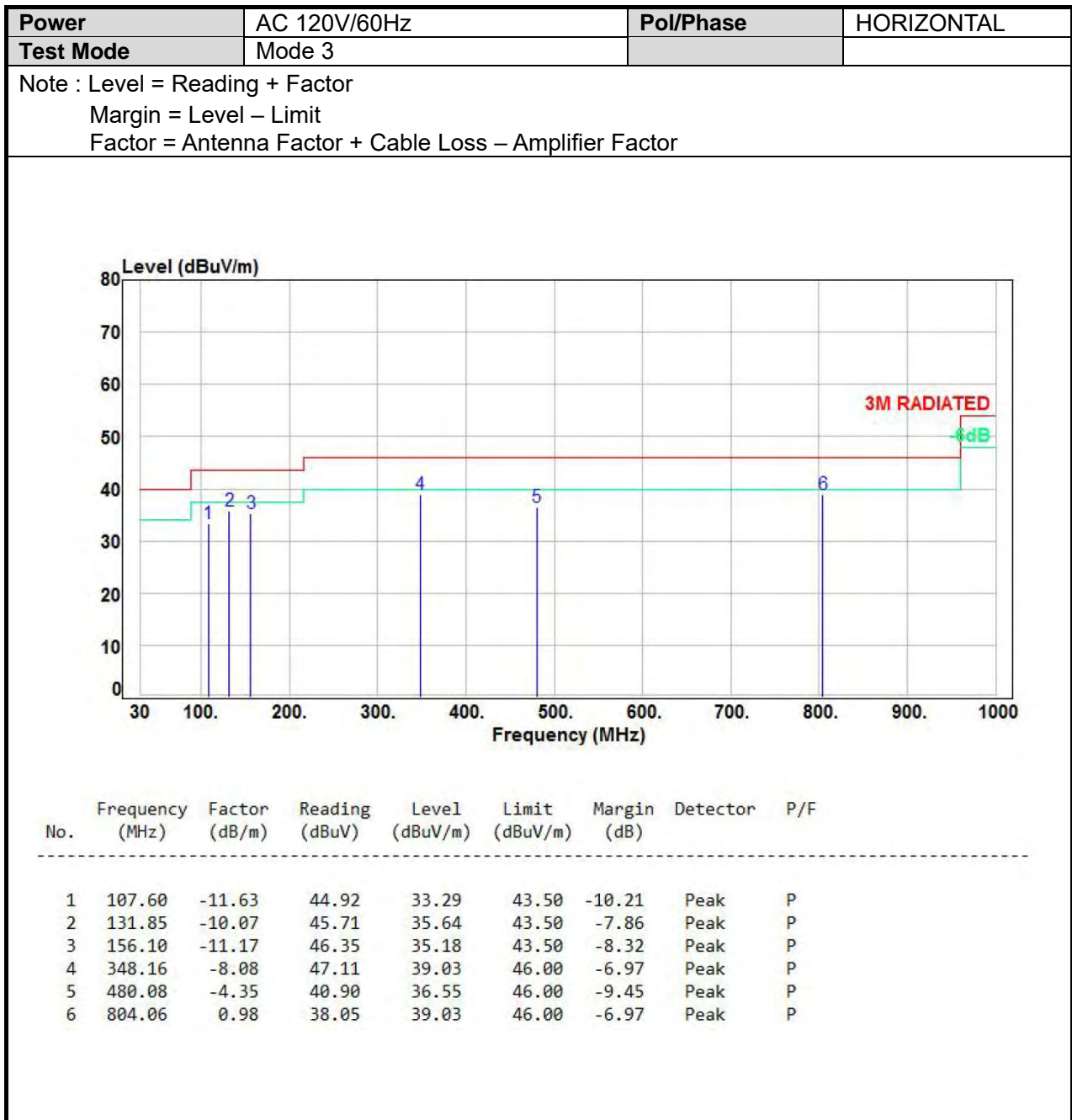



6.6 Test Result and Data (1GHz ~ 25GHz)

Power	AC 120V/60Hz	Pol/Phase	VERTICAL
Test Mode	Mode 1, CH 00	Operation mode	TX

Note : Level = Reading + Factor

Margin = Level – Limit

Factor = Antenna Factor + Cable Loss – Amplifier Factor

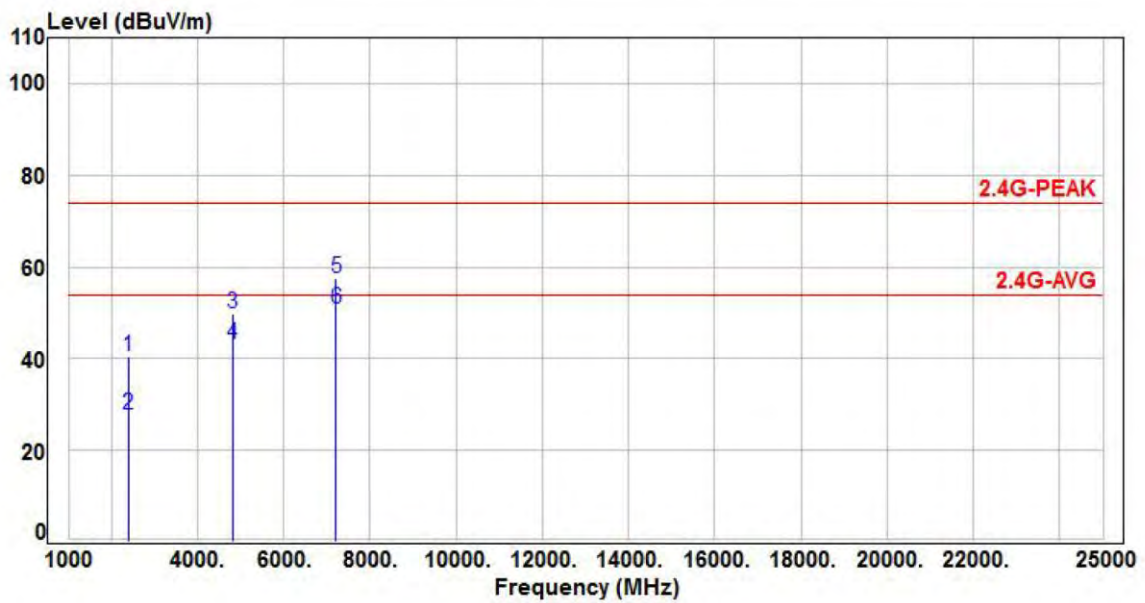

No.	Frequency (MHz)	Factor (dB/m)	Reading (dBuV)	Level (dBuV/m)	Limit (dBuV/m)	Margin (dB)	Detector	P/F
1	2390.00	-4.35	44.70	40.35	74.00	-33.65	Peak	P
2	2390.00	-4.35	32.15	27.80	54.00	-26.20	Average	P
3	4804.00	2.64	47.32	49.96	74.00	-24.04	Peak	P
4	4804.00	2.64	40.49	43.13	54.00	-10.87	Average	P
5	7206.00	8.57	48.92	57.49	74.00	-16.51	Peak	P
6	7206.00	8.57	42.36	50.93	54.00	-3.07	Average	P



Power	AC 120V/60Hz	Pol/Phase	HORIZONTAL
Test Mode	Mode 1, CH 00	Operation mode	TX

Note : Level = Reading + Factor
 Margin = Level – Limit
 Factor = Antenna Factor + Cable Loss – Amplifier Factor

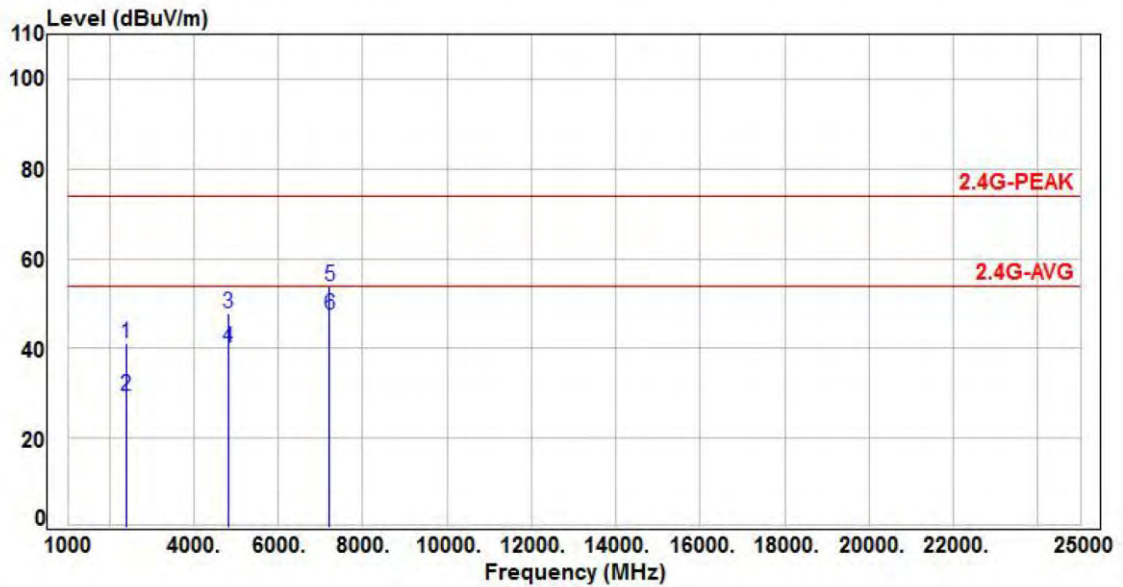

No.	Frequency (MHz)	Factor (dB/m)	Reading (dBuV)	Level (dBuV/m)	Limit (dBuV/m)	Margin (dB)	Detector	P/F
1	2390.00	-4.35	45.49	41.14	74.00	-32.86	Peak	P
2	2390.00	-4.35	33.83	29.48	54.00	-24.52	Average	P
3	4804.00	2.64	45.23	47.87	74.00	-26.13	Peak	P
4	4804.00	2.64	37.63	40.27	54.00	-13.73	Average	P
5	7206.00	8.57	45.20	53.77	74.00	-20.23	Peak	P
6	7206.00	8.57	38.98	47.55	54.00	-6.45	Average	P



Power	AC 120V/60Hz	Pol/Phase	VERTICAL
Test Mode	Mode 1, CH 39	Operation mode	TX

Note : Level = Reading + Factor
 Margin = Level – Limit
 Factor = Antenna Factor + Cable Loss – Amplifier Factor

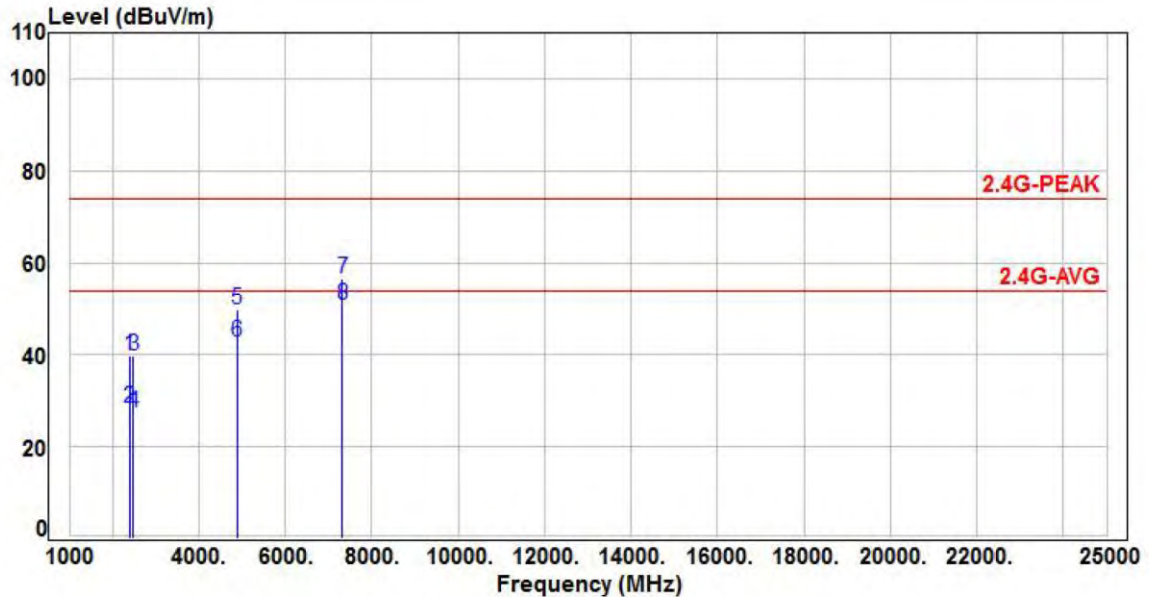

No.	Frequency (MHz)	Factor (dB/m)	Reading (dBuV)	Level (dBuV/m)	Limit (dBuV/m)	Margin (dB)	Detector	P/F
1	2390.00	-4.35	44.31	39.96	74.00	-34.04	Peak	P
2	2390.00	-4.35	32.66	28.31	54.00	-25.69	Average	P
3	2483.50	-3.98	43.94	39.96	74.00	-34.04	Peak	P
4	2483.50	-3.98	31.30	27.32	54.00	-26.68	Average	P
5	4882.00	2.59	47.08	49.67	74.00	-24.33	Peak	P
6	4882.00	2.59	40.18	42.77	54.00	-11.23	Average	P
7	7323.00	8.64	47.91	56.55	74.00	-17.45	Peak	P
8	7323.00	8.64	42.11	50.75	54.00	-3.25	Average	P



Power	AC 120V/60Hz	Pol/Phase	HORIZONTAL
Test Mode	Mode 1, CH 39	Operation mode	TX

Note : Level = Reading + Factor

Margin = Level – Limit

Factor = Antenna Factor + Cable Loss – Amplifier Factor

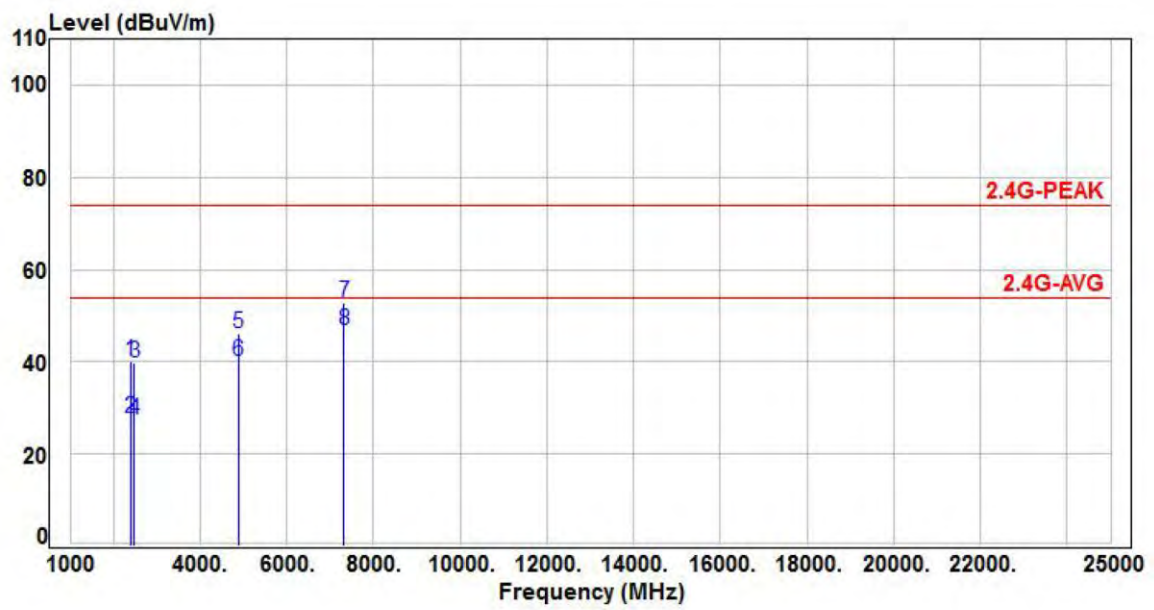

No.	Frequency (MHz)	Factor (dB/m)	Reading (dBuV)	Level (dBuV/m)	Limit (dBuV/m)	Margin (dB)	Detector	P/F
1	2390.00	-4.35	44.47	40.12	74.00	-33.88	Peak	P
2	2390.00	-4.35	32.09	27.74	54.00	-26.26	Average	P
3	2483.50	-3.98	43.64	39.66	74.00	-34.34	Peak	P
4	2483.50	-3.98	31.55	27.57	54.00	-26.43	Average	P
5	4882.00	2.59	43.63	46.22	74.00	-27.78	Peak	P
6	4882.00	2.59	37.67	40.26	54.00	-13.74	Average	P
7	7323.00	8.64	44.23	52.87	74.00	-21.13	Peak	P
8	7323.00	8.64	38.05	46.69	54.00	-7.31	Average	P



Power	AC 120V/60Hz	Pol/Phase	VERTICAL
Test Mode	Mode 1, CH 78	Operation mode	TX

Note : Level = Reading + Factor
Margin = Level – Limit
Factor = Antenna Factor + Cable Loss – Amplifier Factor

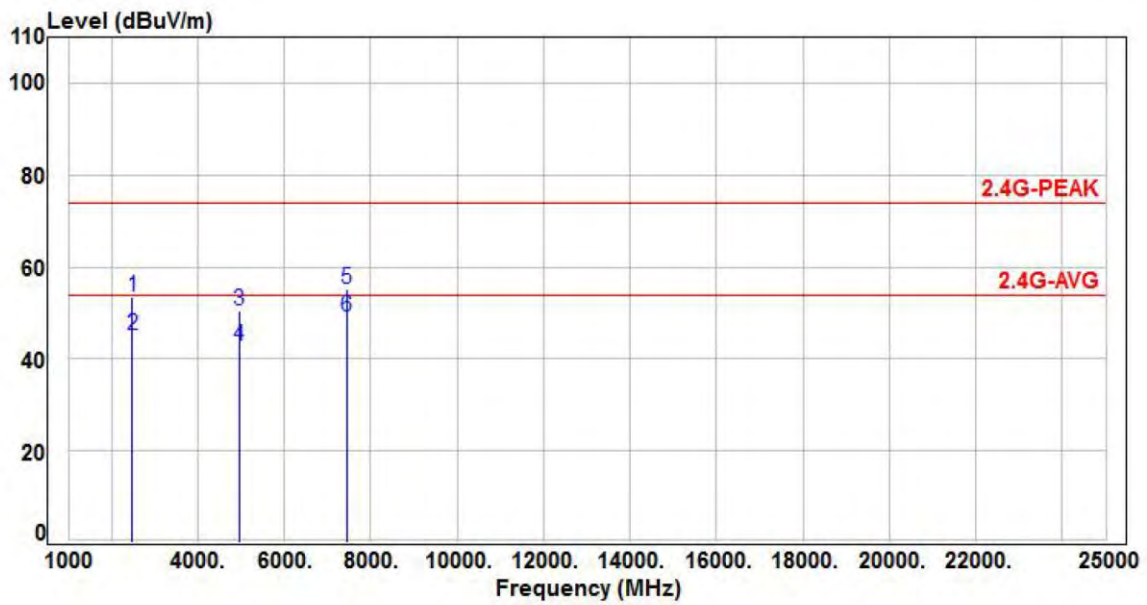

No.	Frequency (MHz)	Factor (dB/m)	Reading (dBuV)	Level (dBuV/m)	Limit (dBuV/m)	Margin (dB)	Detector	P/F
1	2483.50	-3.98	57.51	53.53	74.00	-20.47	Peak	P
2	2483.50	-3.98	49.11	45.13	54.00	-8.87	Average	P
3	4960.00	2.53	48.03	50.56	74.00	-23.44	Peak	P
4	4960.00	2.53	40.44	42.97	54.00	-11.03	Average	P
5	7440.00	8.72	46.30	55.02	74.00	-18.98	Peak	P
6	7440.00	8.72	40.46	49.18	54.00	-4.82	Average	P



Power	AC 120V/60Hz	Pol/Phase	HORIZONTAL
Test Mode	Mode 1, CH 78	Operation mode	TX

Note : Level = Reading + Factor
 Margin = Level – Limit
 Factor = Antenna Factor + Cable Loss – Amplifier Factor

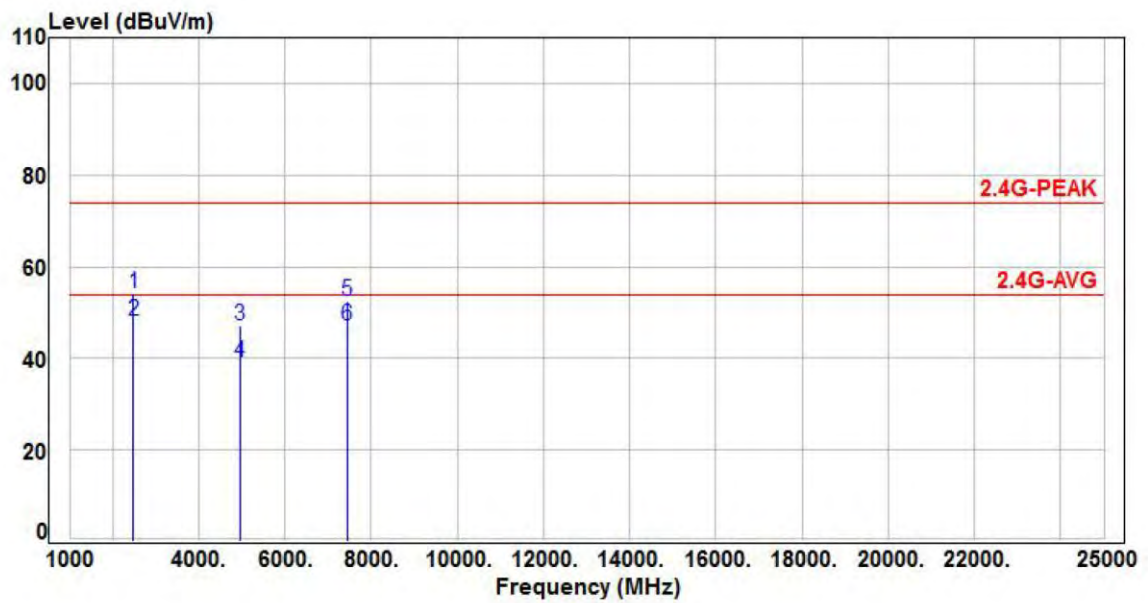

No.	Frequency (MHz)	Factor (dB/m)	Reading (dBuV)	Level (dBuV/m)	Limit (dBuV/m)	Margin (dB)	Detector	P/F
1	2483.50	-3.98	58.01	54.03	74.00	-19.97	Peak	P
2	2483.50	-3.98	52.03	48.05	54.00	-5.95	Average	P
3	4960.00	2.53	44.47	47.00	74.00	-27.00	Peak	P
4	4960.00	2.53	36.73	39.26	54.00	-14.74	Average	P
5	7440.00	8.72	43.78	52.50	74.00	-21.50	Peak	P
6	7440.00	8.72	38.29	47.01	54.00	-6.99	Average	P



Power	AC 120V/60Hz	Pol/Phase	VERTICAL
Test Mode	Mode 2, CH 00	Operation mode	TX

Note : Level = Reading + Factor
Margin = Level – Limit
Factor = Antenna Factor + Cable Loss – Amplifier Factor

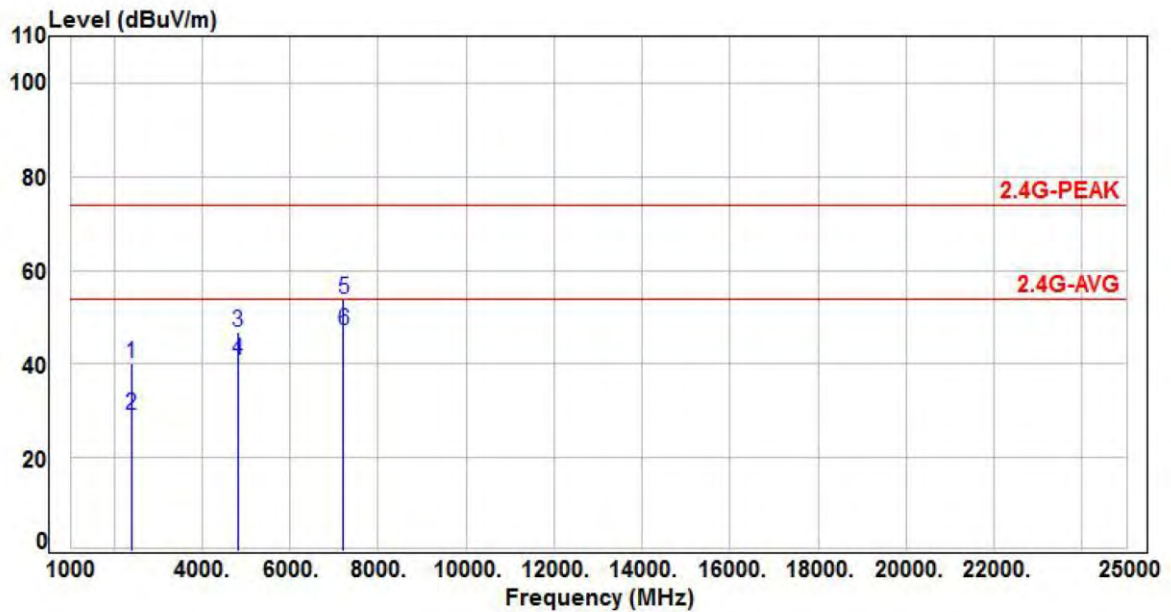

No.	Frequency (MHz)	Factor (dB/m)	Reading (dBuV)	Level (dBuV/m)	Limit (dBuV/m)	Margin (dB)	Detector	P/F
1	2390.00	-4.35	44.56	40.21	74.00	-33.79	Peak	P
2	2390.00	-4.35	33.45	29.10	54.00	-24.90	Average	P
3	4804.00	2.64	44.23	46.87	74.00	-27.13	Peak	P
4	4804.00	2.64	38.09	40.73	54.00	-13.27	Average	P
5	7206.00	8.57	45.37	53.94	74.00	-20.06	Peak	P
6	7206.00	8.57	38.69	47.26	54.00	-6.74	Average	P



Power	AC 120V/60Hz	Pol/Phase	HORIZONTAL
Test Mode	Mode 2, CH 00	Operation mode	TX

Note : Level = Reading + Factor
Margin = Level – Limit
Factor = Antenna Factor + Cable Loss – Amplifier Factor

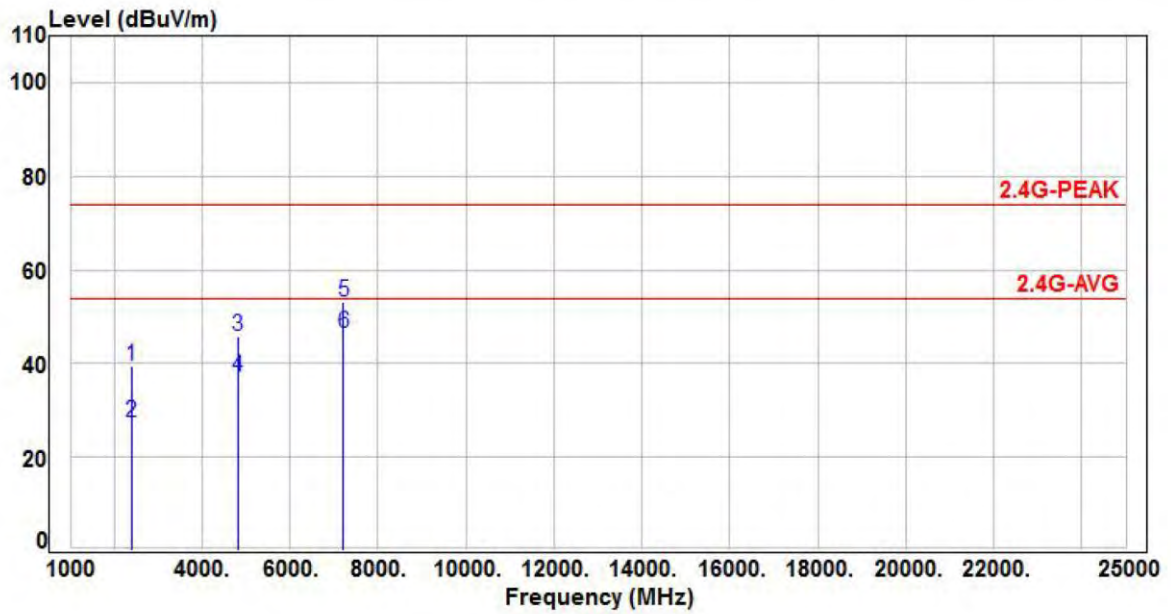

No.	Frequency (MHz)	Factor (dB/m)	Reading (dBuV)	Level (dBuV/m)	Limit (dBuV/m)	Margin (dB)	Detector	P/F
1	2390.00	-4.35	43.77	39.42	74.00	-34.58	Peak	P
2	2390.00	-4.35	31.89	27.54	54.00	-26.46	Average	P
3	4804.00	2.64	43.17	45.81	74.00	-28.19	Peak	P
4	4804.00	2.64	34.50	37.14	54.00	-16.86	Average	P
5	7206.00	8.57	44.56	53.13	74.00	-20.87	Peak	P
6	7206.00	8.57	37.94	46.51	54.00	-7.49	Average	P



Power	AC 120V/60Hz	Pol/Phase	VERTICAL
Test Mode	Mode 2, CH 39	Operation mode	TX

Note : Level = Reading + Factor

Margin = Level – Limit

Factor = Antenna Factor + Cable Loss – Amplifier Factor

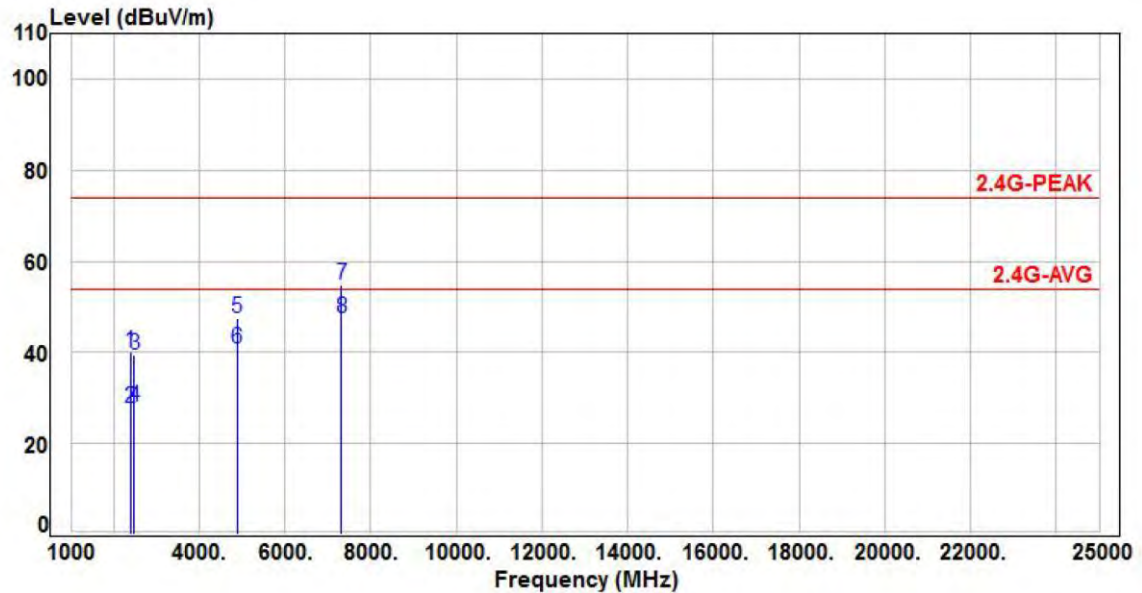

No.	Frequency (MHz)	Factor (dB/m)	Reading (dBuV)	Level (dBuV/m)	Limit (dBuV/m)	Margin (dB)	Detector	P/F
1	2390.00	-4.35	44.59	40.24	74.00	-33.76	Peak	P
2	2390.00	-4.35	32.00	27.65	54.00	-26.35	Average	P
3	2483.50	-3.98	43.54	39.56	74.00	-34.44	Peak	P
4	2483.50	-3.98	32.19	28.21	54.00	-25.79	Average	P
5	4882.00	2.59	45.03	47.62	74.00	-26.38	Peak	P
6	4882.00	2.59	38.30	40.89	54.00	-13.11	Average	P
7	7323.00	8.64	46.20	54.84	74.00	-19.16	Peak	P
8	7323.00	8.64	38.95	47.59	54.00	-6.41	Average	P



Power	AC 120V/60Hz	Pol/Phase	HORIZONTAL
Test Mode	Mode 2, CH 39	Operation mode	TX

Note : Level = Reading + Factor

Margin = Level – Limit

Factor = Antenna Factor + Cable Loss – Amplifier Factor

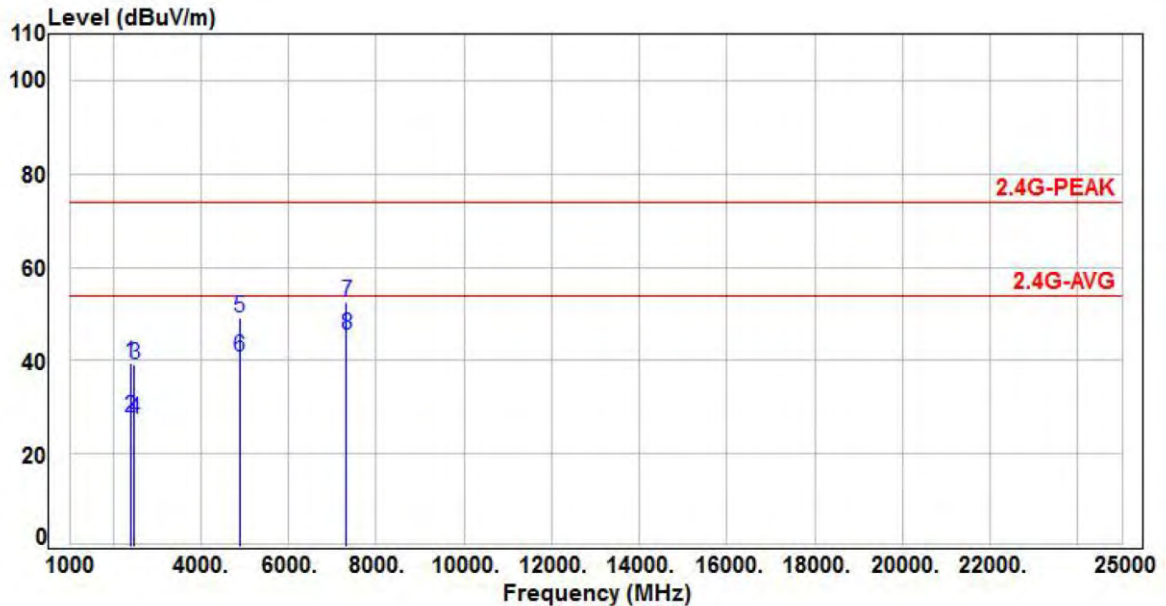

No.	Frequency (MHz)	Factor (dB/m)	Reading (dBuV)	Level (dBuV/m)	Limit (dBuV/m)	Margin (dB)	Detector	P/F
1	2390.00	-4.35	43.89	39.54	74.00	-34.46	Peak	P
2	2390.00	-4.35	32.21	27.86	54.00	-26.14	Average	P
3	2483.50	-3.98	43.22	39.24	74.00	-34.76	Peak	P
4	2483.50	-3.98	31.29	27.31	54.00	-26.69	Average	P
5	4882.00	2.59	46.53	49.12	74.00	-24.88	Peak	P
6	4882.00	2.59	38.32	40.91	54.00	-13.09	Average	P
7	7323.00	8.64	43.98	52.62	74.00	-21.38	Peak	P
8	7323.00	8.64	36.99	45.63	54.00	-8.37	Average	P



Power	AC 120V/60Hz	Pol/Phase	VERTICAL
Test Mode	Mode 2, CH 78		

Note : Level = Reading + Factor
 Margin = Level – Limit
 Factor = Antenna Factor + Cable Loss – Amplifier Factor

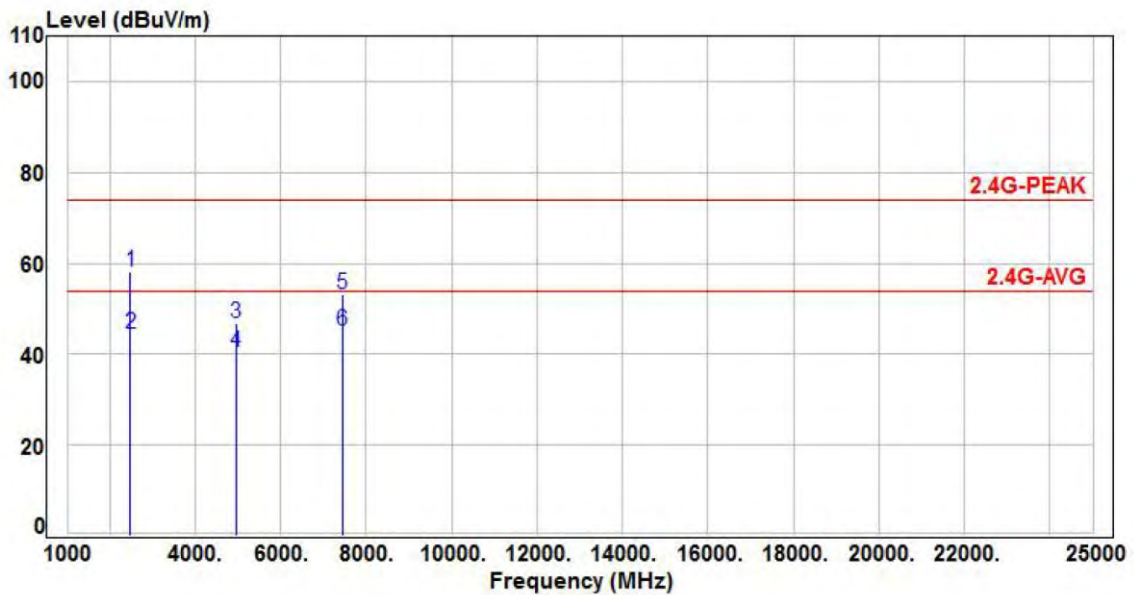

No.	Frequency (MHz)	Factor (dB/m)	Reading (dBuV)	Level (dBuV/m)	Limit (dBuV/m)	Margin (dB)	Detector	P/F
1	2483.50	-3.98	62.30	58.32	74.00	-15.68	Peak	P
2	2483.50	-3.98	48.39	44.41	54.00	-9.59	Average	P
3	4960.00	2.53	44.31	46.84	74.00	-27.16	Peak	P
4	4960.00	2.53	37.81	40.34	54.00	-13.66	Average	P
5	7440.00	8.72	44.42	53.14	74.00	-20.86	Peak	P
6	7440.00	8.72	36.51	45.23	54.00	-8.77	Average	P



Power	AC 120V/60Hz	Pol/Phase	HORIZONTAL
Test Mode	Mode 2, CH 78	Operation mode	TX

Note : Level = Reading + Factor
Margin = Level – Limit
Factor = Antenna Factor + Cable Loss – Amplifier Factor

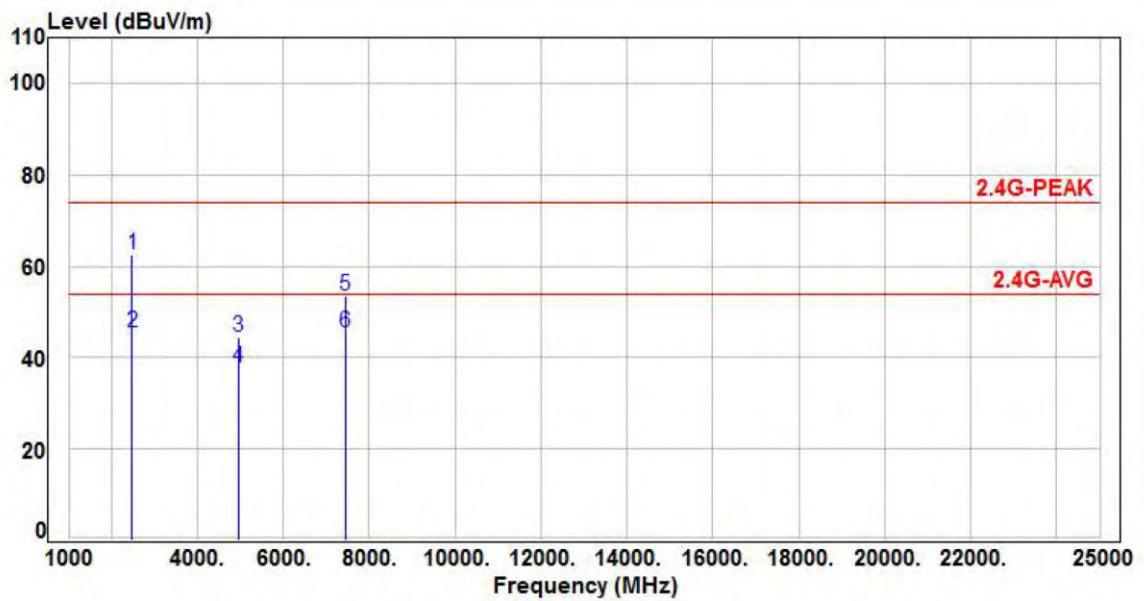

No.	Frequency (MHz)	Factor (dB/m)	Reading (dBuV)	Level (dBuV/m)	Limit (dBuV/m)	Margin (dB)	Detector	P/F
1	2483.50	-3.98	66.51	62.53	74.00	-11.47	Peak	P
2	2483.50	-3.98	49.59	45.61	54.00	-8.39	Average	P
3	4960.00	2.53	41.86	44.39	74.00	-29.61	Peak	P
4	4960.00	2.53	35.39	37.92	54.00	-16.08	Average	P
5	7440.00	8.72	44.75	53.47	74.00	-20.53	Peak	P
6	7440.00	8.72	36.64	45.36	54.00	-8.64	Average	P



Power	AC 120V/60Hz	Pol/Phase	VERTICAL
Test Mode	Mode 3, CH 00	Operation mode	TX

Note : Level = Reading + Factor
Margin = Level – Limit
Factor = Antenna Factor + Cable Loss – Amplifier Factor

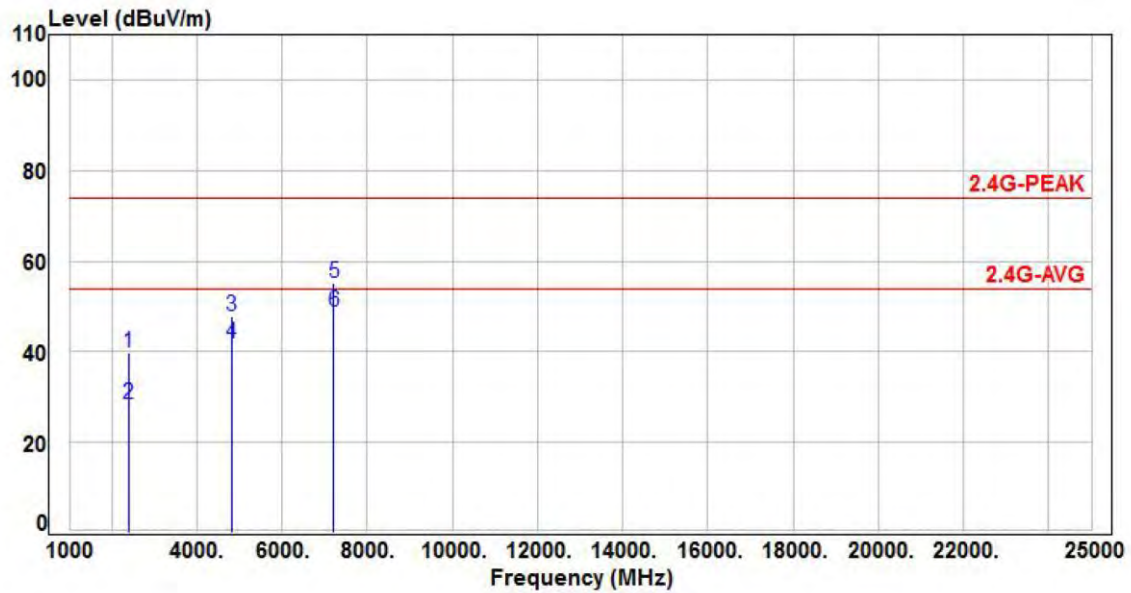

No.	Frequency (MHz)	Factor (dB/m)	Reading (dBuV)	Level (dBuV/m)	Limit (dBuV/m)	Margin (dB)	Detector	P/F
1	2390.00	-4.35	44.29	39.94	74.00	-34.06	Peak	P
2	2390.00	-4.35	32.93	28.58	54.00	-25.42	Average	P
3	4804.00	2.64	45.05	47.69	74.00	-26.31	Peak	P
4	4804.00	2.64	39.01	41.65	54.00	-12.35	Average	P
5	7206.00	8.57	46.52	55.09	74.00	-18.91	Peak	P
6	7206.00	8.57	40.33	48.90	54.00	-5.10	Average	P



Power	AC 120V/60Hz	Pol/Phase	HORIZONTAL
Test Mode	Mode 3, CH 00	Operation mode	TX

Note : Level = Reading + Factor
Margin = Level – Limit
Factor = Antenna Factor + Cable Loss – Amplifier Factor

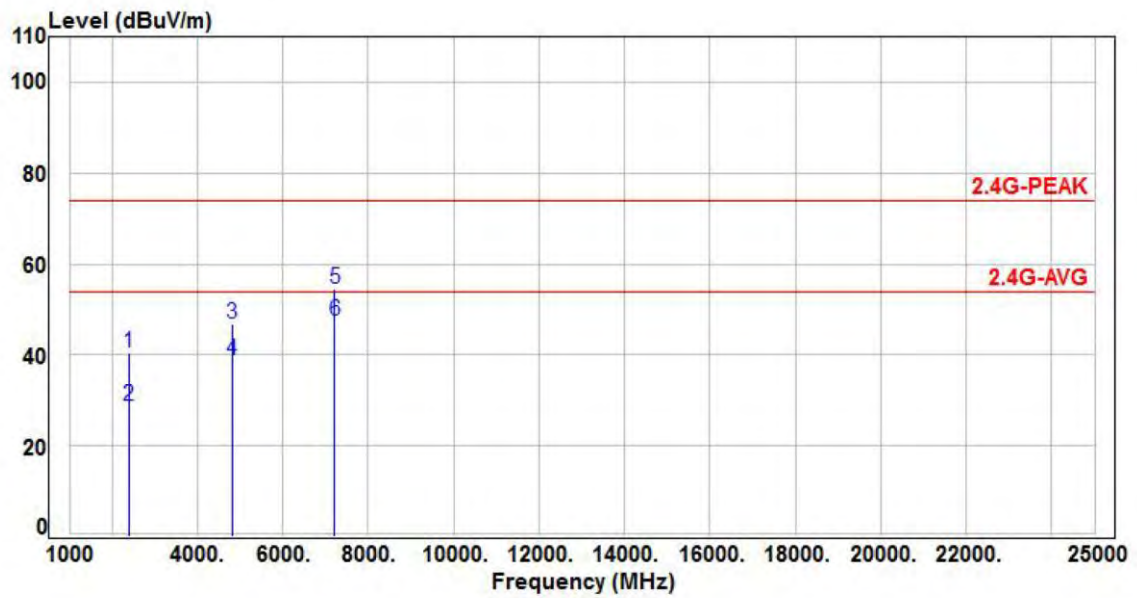

No.	Frequency (MHz)	Factor (dB/m)	Reading (dBuV)	Level (dBuV/m)	Limit (dBuV/m)	Margin (dB)	Detector	P/F
1	2390.00	-4.35	44.66	40.31	74.00	-33.69	Peak	P
2	2390.00	-4.35	33.13	28.78	54.00	-25.22	Average	P
3	4804.00	2.64	44.16	46.80	74.00	-27.20	Peak	P
4	4804.00	2.64	36.11	38.75	54.00	-15.25	Average	P
5	7206.00	8.57	46.09	54.66	74.00	-19.34	Peak	P
6	7206.00	8.57	38.84	47.41	54.00	-6.59	Average	P



Power	AC 120V/60Hz	Pol/Phase	VERTICAL
Test Mode	Mode 3, CH 39	Operation mode	TX

Note : Level = Reading + Factor
 Margin = Level – Limit
 Factor = Antenna Factor + Cable Loss – Amplifier Factor

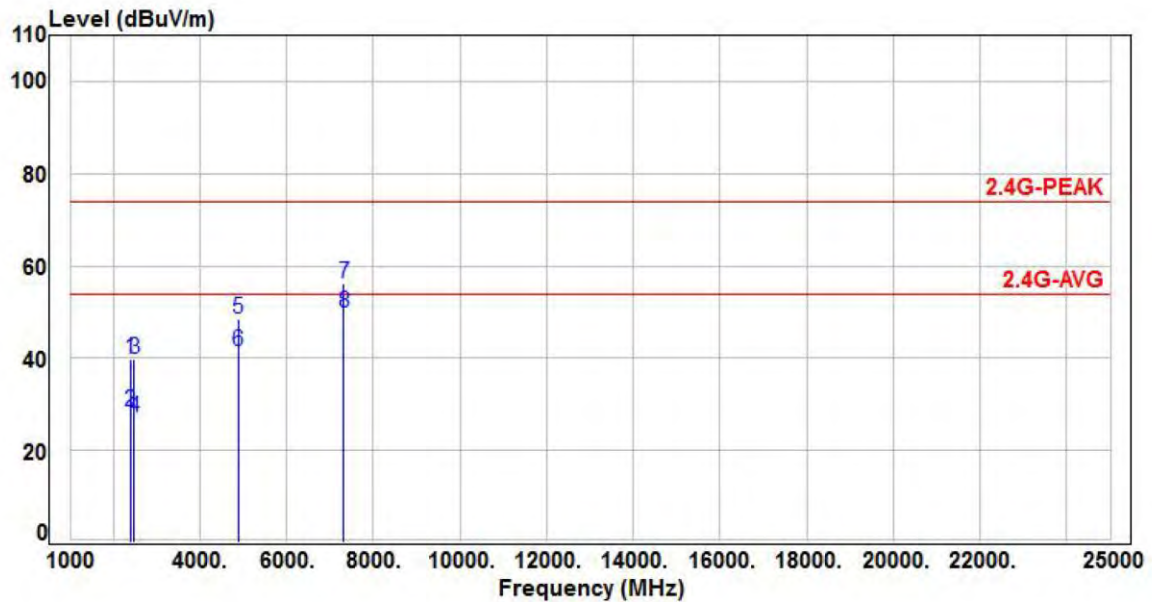

No.	Frequency (MHz)	Factor (dB/m)	Reading (dBuV)	Level (dBuV/m)	Limit (dBuV/m)	Margin (dB)	Detector	P/F
1	2390.00	-4.35	44.01	39.66	74.00	-34.34	Peak	P
2	2390.00	-4.35	32.79	28.44	54.00	-25.56	Average	P
3	2483.50	-3.98	43.69	39.71	74.00	-34.29	Peak	P
4	2483.50	-3.98	31.21	27.23	54.00	-26.77	Average	P
5	4882.00	2.59	45.77	48.36	74.00	-25.64	Peak	P
6	4882.00	2.59	39.00	41.59	54.00	-12.41	Average	P
7	7323.00	8.64	47.66	56.30	74.00	-17.70	Peak	P
8	7323.00	8.64	41.27	49.91	54.00	-4.09	Average	P



Power	AC 120V/60Hz	Pol/Phase	HORIZONTAL
Test Mode	Mode 3, CH 39	Operation mode	TX

Note : Level = Reading + Factor

Margin = Level – Limit

Factor = Antenna Factor + Cable Loss – Amplifier Factor

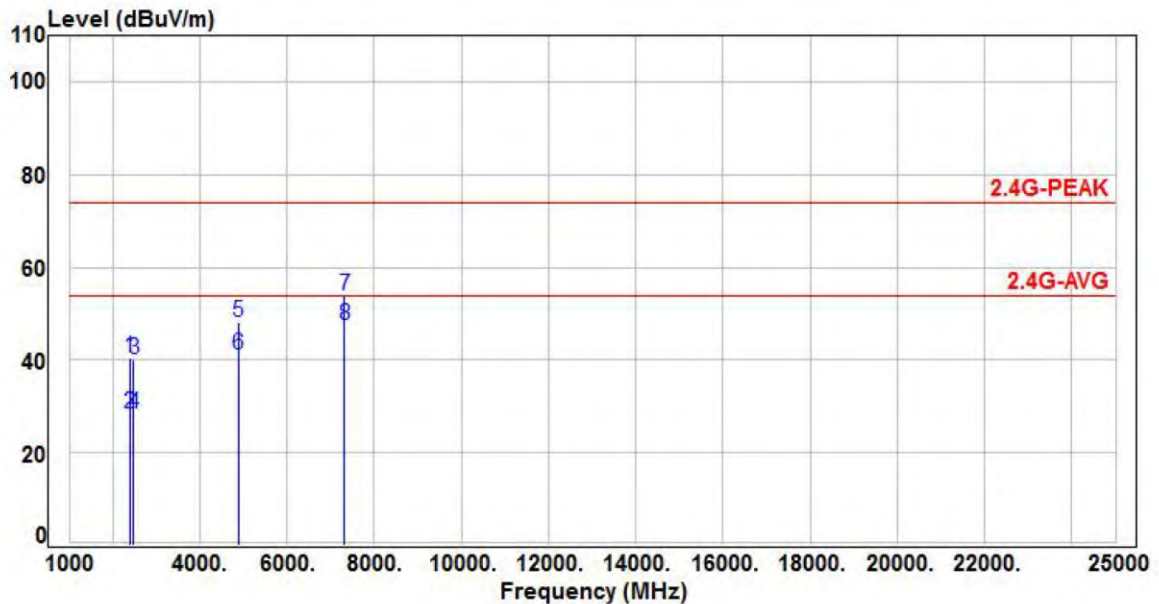

No.	Frequency (MHz)	Factor (dB/m)	Reading (dBuV)	Level (dBuV/m)	Limit (dBuV/m)	Margin (dB)	Detector	P/F
1	2390.00	-4.35	44.80	40.45	74.00	-33.55	Peak	P
2	2390.00	-4.35	32.80	28.45	54.00	-25.55	Average	P
3	2483.50	-3.98	44.02	40.04	74.00	-33.96	Peak	P
4	2483.50	-3.98	32.37	28.39	54.00	-25.61	Average	P
5	4882.00	2.59	45.72	48.31	74.00	-25.69	Peak	P
6	4882.00	2.59	38.54	41.13	54.00	-12.87	Average	P
7	7323.00	8.64	45.36	54.00	74.00	-20.00	Peak	P
8	7323.00	8.64	38.87	47.51	54.00	-6.49	Average	P



Power	AC 120V/60Hz	Pol/Phase	VERTICAL
Test Mode	Mode 3, CH 78		

Note : Level = Reading + Factor
 Margin = Level – Limit
 Factor = Antenna Factor + Cable Loss – Amplifier Factor

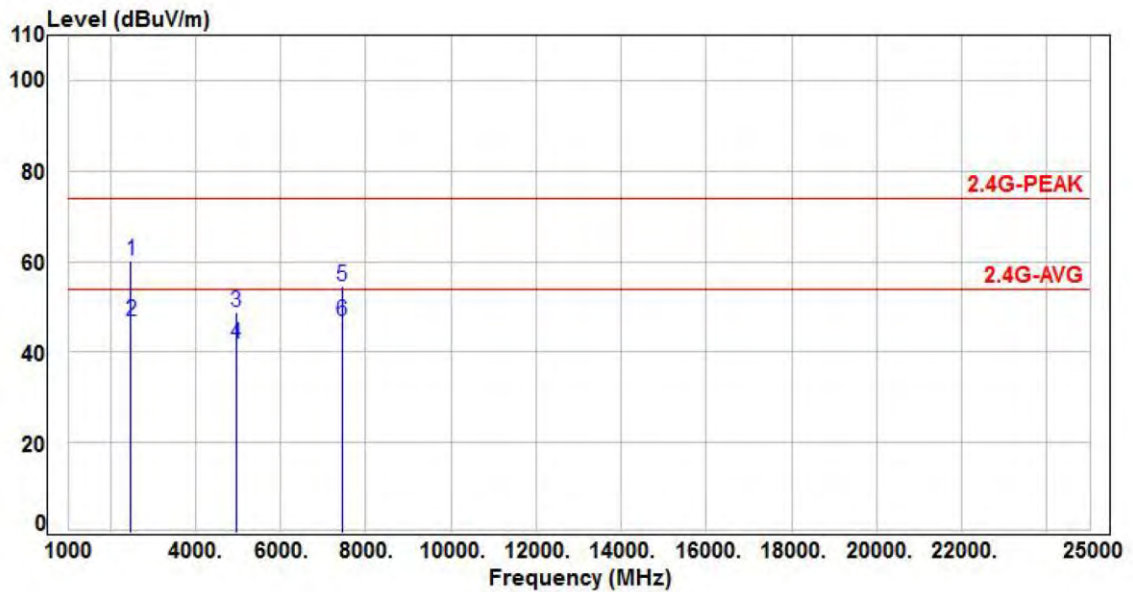

No.	Frequency (MHz)	Factor (dB/m)	Reading (dBuV)	Level (dBuV/m)	Limit (dBuV/m)	Margin (dB)	Detector	P/F
1	2483.50	-3.98	64.26	60.28	74.00	-13.72	Peak	P
2	2483.50	-3.98	50.83	46.85	54.00	-7.15	Average	P
3	4960.00	2.53	46.34	48.87	74.00	-25.13	Peak	P
4	4960.00	2.53	39.39	41.92	54.00	-12.08	Average	P
5	7440.00	8.72	45.90	54.62	74.00	-19.38	Peak	P
6	7440.00	8.72	37.95	46.67	54.00	-7.33	Average	P



Power	AC 120V/60Hz	Pol/Phase	HORIZONTAL
Test Mode	Mode 3, CH 78	Operation mode	TX

Note : Level = Reading + Factor
 Margin = Level – Limit
 Factor = Antenna Factor + Cable Loss – Amplifier Factor
 The 18000MHz - 25000MHz spurious emission is under limit 20dB more.

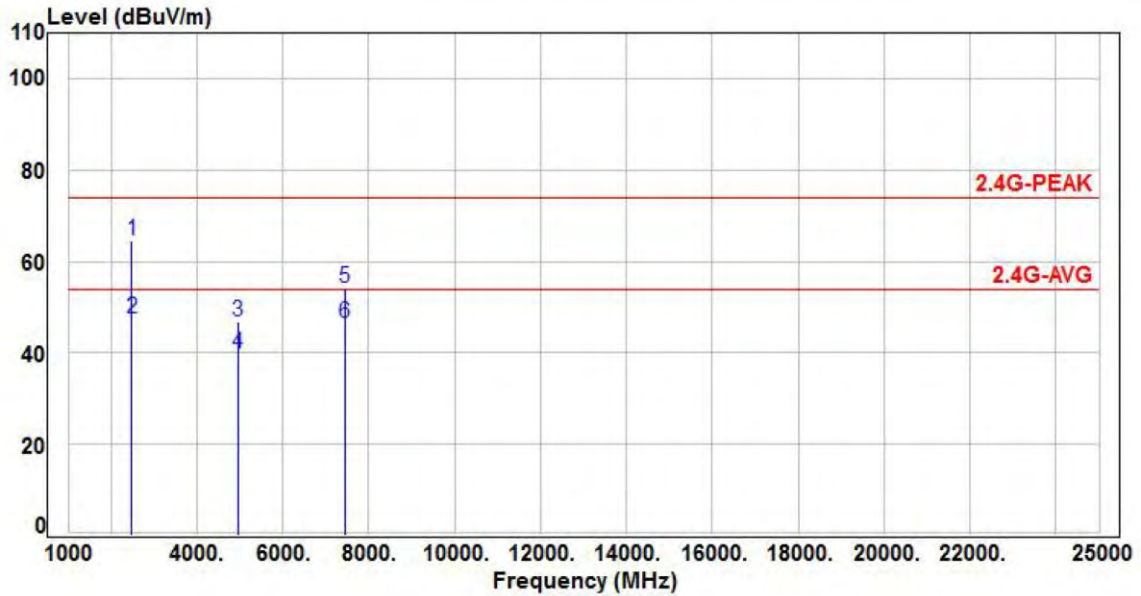

No.	Frequency (MHz)	Factor (dB/m)	Reading (dBuV)	Level (dBuV/m)	Limit (dBuV/m)	Margin (dB)	Detector	P/F
1	2483.50	-3.98	68.45	64.47	74.00	-9.53	Peak	P
2	2483.50	-3.98	51.42	47.44	54.00	-6.56	Average	P
3	4960.00	2.53	44.45	46.98	74.00	-27.02	Peak	P
4	4960.00	2.53	37.27	39.80	54.00	-14.20	Average	P
5	7440.00	8.72	45.53	54.25	74.00	-19.75	Peak	P
6	7440.00	8.72	37.78	46.50	54.00	-7.50	Average	P



6.7 Restricted Bands of Operation

Only spurious emissions are permitted in any of the frequency bands listed below:

MHz	MHz	MHz	GHz
0.09000 – 0.11000	16.42000 – 16.42300	399.9 – 410.0	4.500 – 5.250
0.49500 – 0.505**	16.69475 – 16.69525	608.0 – 614.0	5.350 – 5.460
2.17350 – 2.19050	16.80425 – 16.80475	960.0 – 1240.0	7.250 – 7.750
4.12500 – 4.12800	25.50000 – 25.67000	1300.0 – 1427.0	8.025 – 8.500
4.17725 – 4.17775	37.50000 – 38.25000	1435.0 – 1626.5	9.000 – 9.200
4.20725 – 4.20775	73.00000 – 74.60000	1645.5 – 1646.5	9.300 – 9.500
6.21500 – 6.21800	74.80000 – 75.20000	1660.0 – 1710.0	10.600 – 12.700
6.26775 – 6.26825	108.00000 – 121.94000	1718.8 – 1722.2	13.250 – 13.400
6.31175 – 6.31225	123.00000 – 138.00000	2200.0 – 2300.0	14.470 – 14.500
8.29100 – 8.29400	149.90000 – 150.05000	2310.0 – 2390.0	15.350 – 16.200
8.36200 – 8.36600	156.52475 – 156.52525	2483.5 – 2500.0	17.700 – 21.400
8.37625 – 8.38675	156.70000 – 156.90000	2655.0 – 2900.0	22.010 – 23.120
8.41425 – 8.41475	162.01250 – 167.17000	3260.0 – 3267.0	23.600 – 24.000
12.29000 – 12.29300	167.72000 – 173.20000	3332.0 – 3339.0	31.200 – 31.800
12.51975 – 12.52025	240.00000 – 285.00000	3345.8 – 3358.0	36.430 – 36.500
12.57675 – 12.57725	322.00000 – 335.40000	3600.0 – 4400.0	Above 38.6
13.36000 – 13.41000			

** : Until February 1, 1999, this restricted band shall be 0.490-0.510 MHz



7. Test of Conducted Spurious Emission

7.1 Test Limit

Below -20dB of the highest emission level of operating band (in 100kHz Resolution Bandwidth).

7.2 Test Procedure

- The transmitter output was connected to the spectrum analyzer via a low loss cable.
- Set RBW of spectrum analyzer to 100 KHz and VBW of spectrum analyzer to 300 KHz with convenient frequency span including 100 KHz bandwidth from band edge.
- The band edges was measured and recorded.

7.3 Test Setup Layout

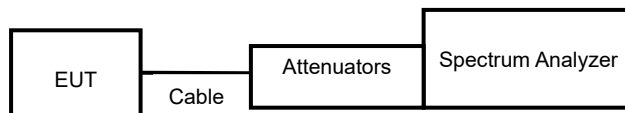

7.4 Test Result and Data

Note: Test plots refer to the following pages.



Single test

Modulation Standard: GFSK (1Mbps)

Channel: 00

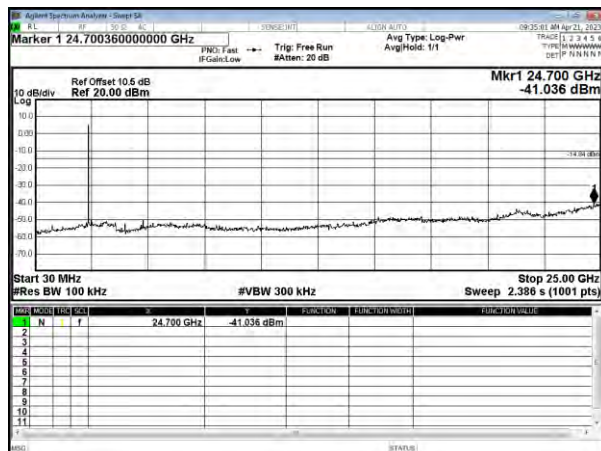
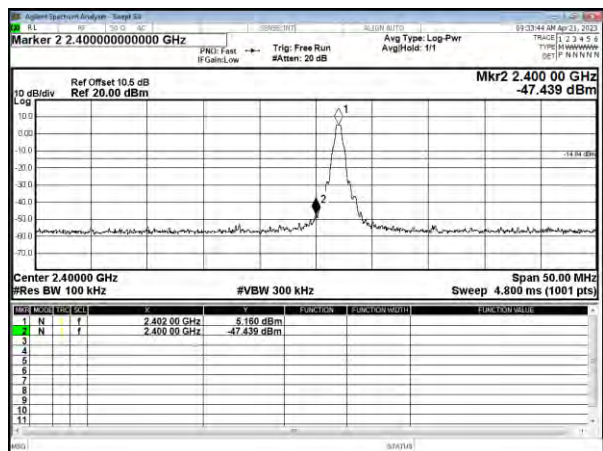

Modulation Standard: GFSK (1Mbps)

Channel: 39

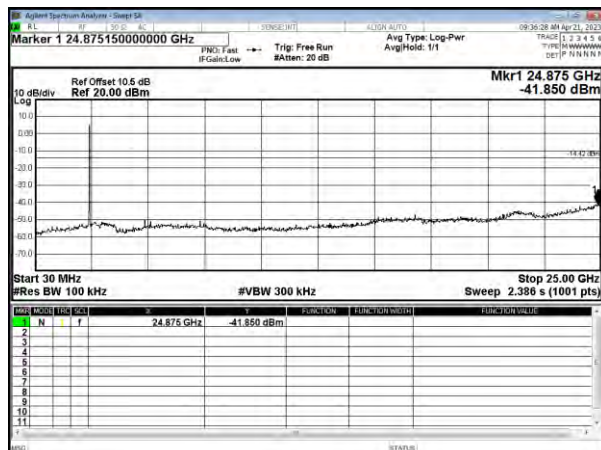
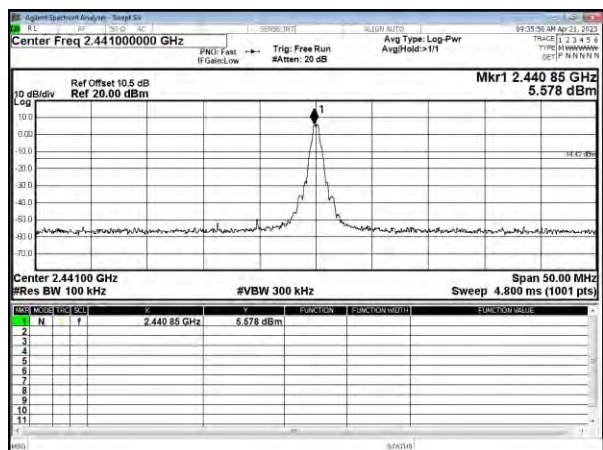

Modulation Standard: GFSK (1Mbps)

Channel: 78

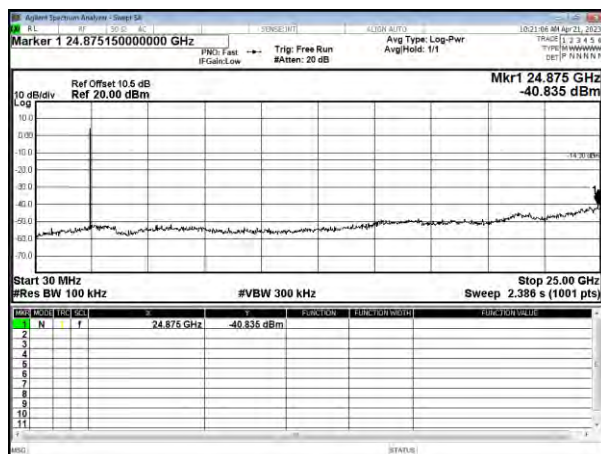
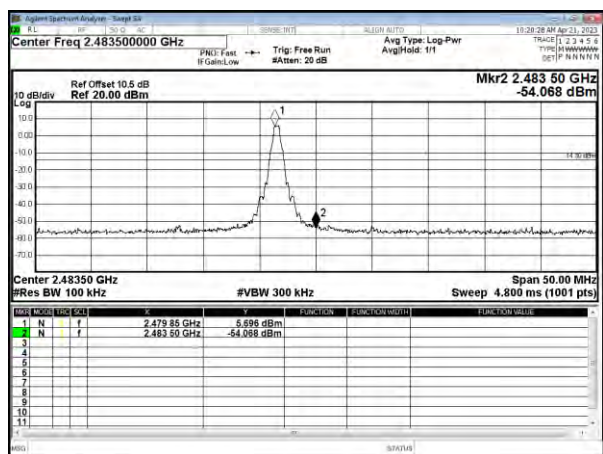



Modulation Standard: $\pi/4$ DQPSK (2Mbps)
Channel: 00

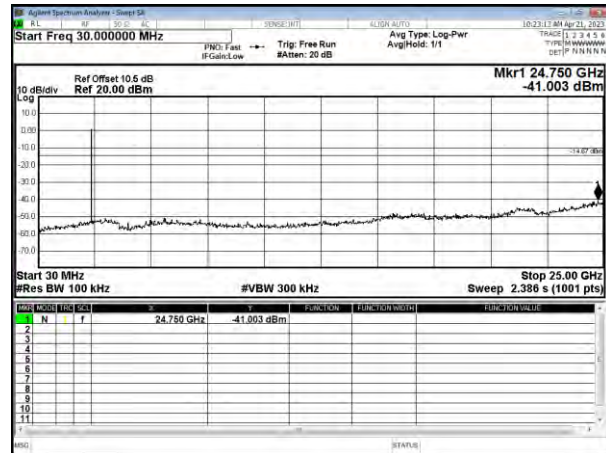
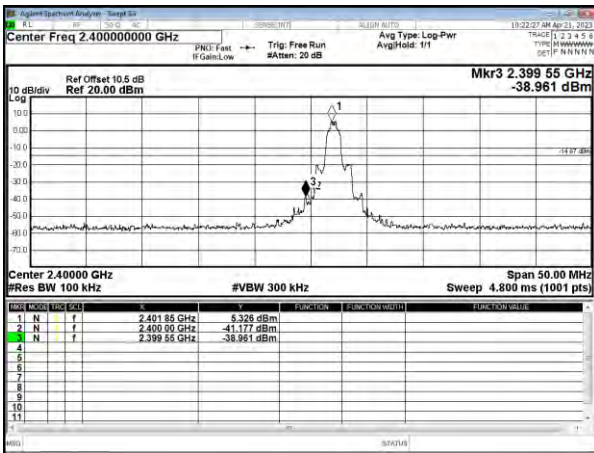

Modulation Standard: $\pi/4$ DQPSK (2Mbps)
Channel: 39

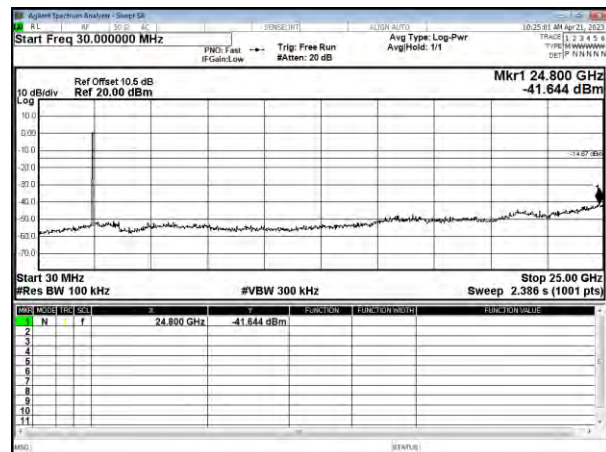
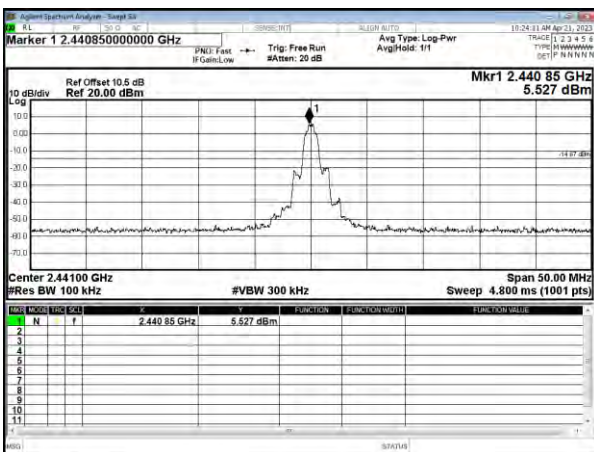

Modulation Standard: $\pi/4$ DQPSK (2Mbps)
Channel: 78

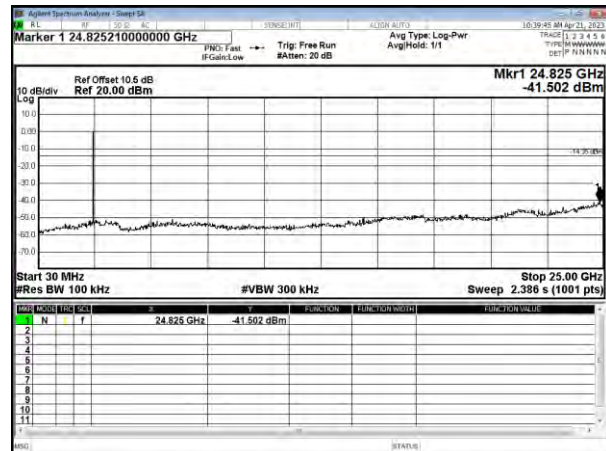
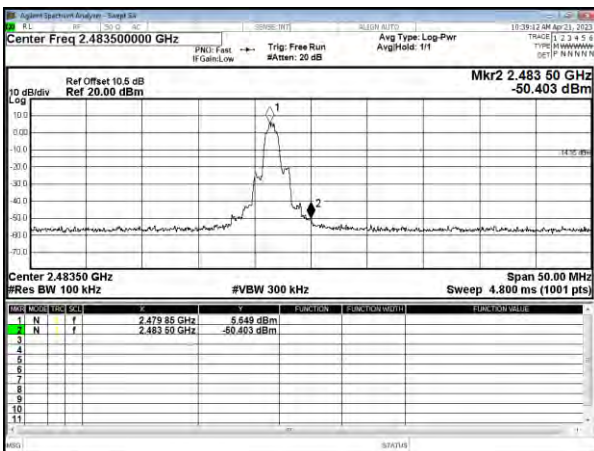



Modulation Standard: 8DPSK (3Mbps)
Channel: 00

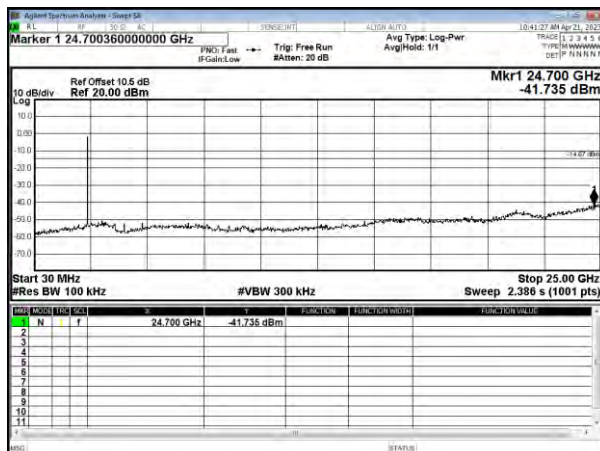
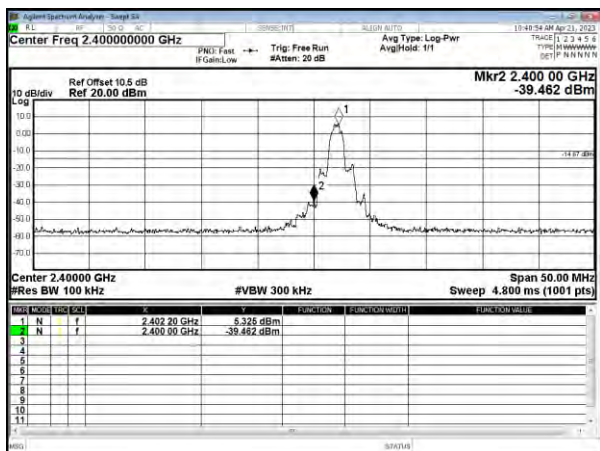

Modulation Standard: 8DPSK (3Mbps)
Channel: 39

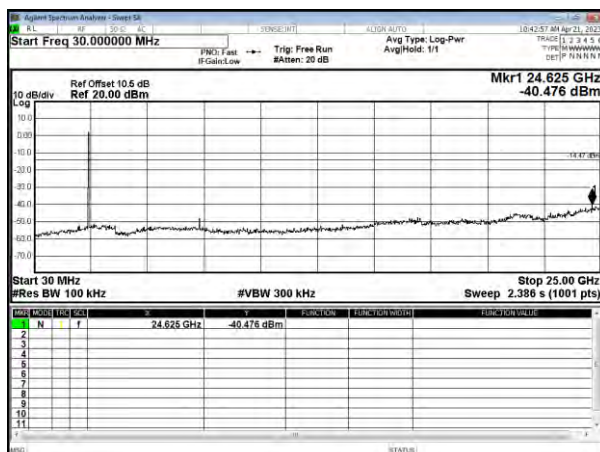
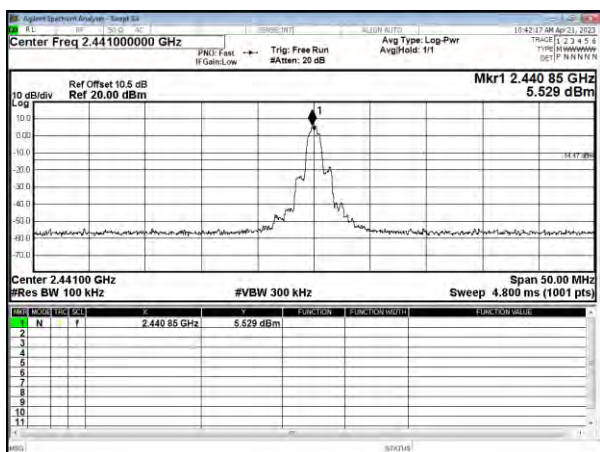

Modulation Standard: 8DPSK (3Mbps)
Channel: 78

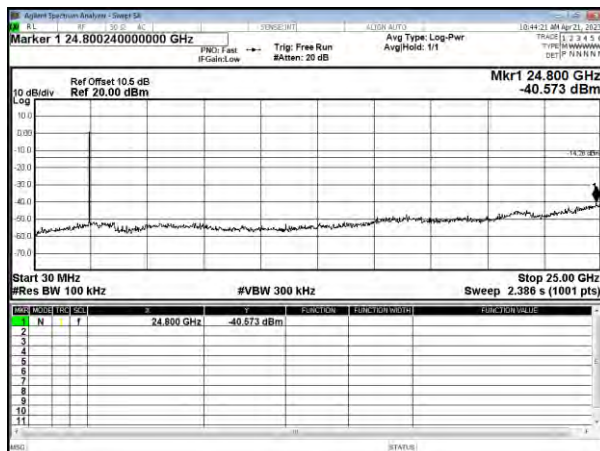
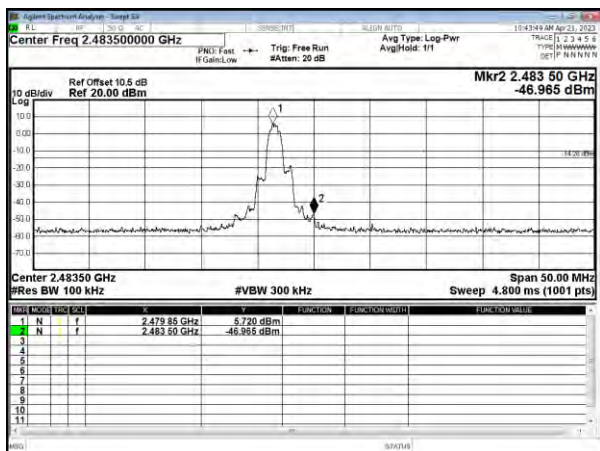



Hopping test

Modulation Standard: GFSK (1Mbps)

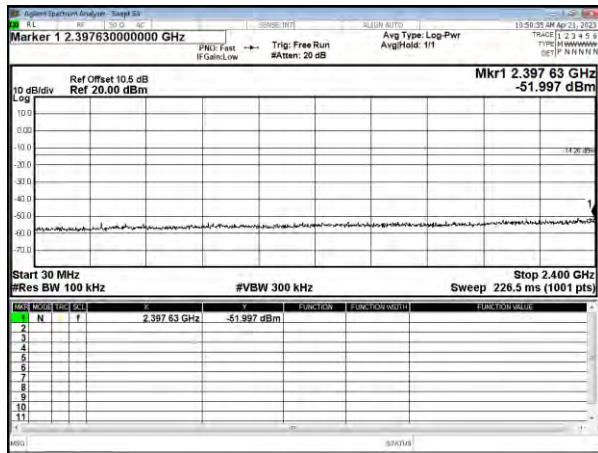

Modulation Standard: GFSK (1Mbps)

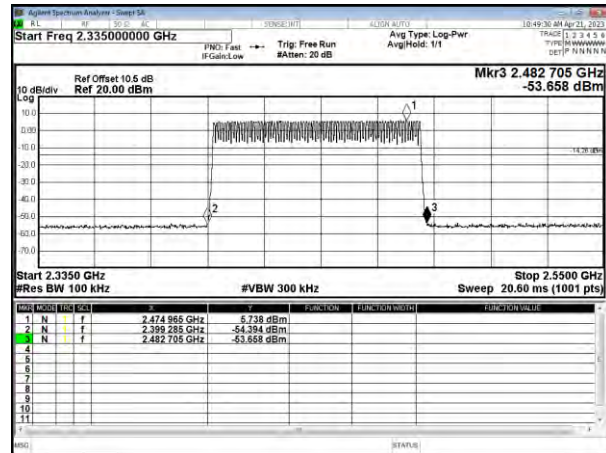

Modulation Standard: GFSK (1Mbps)

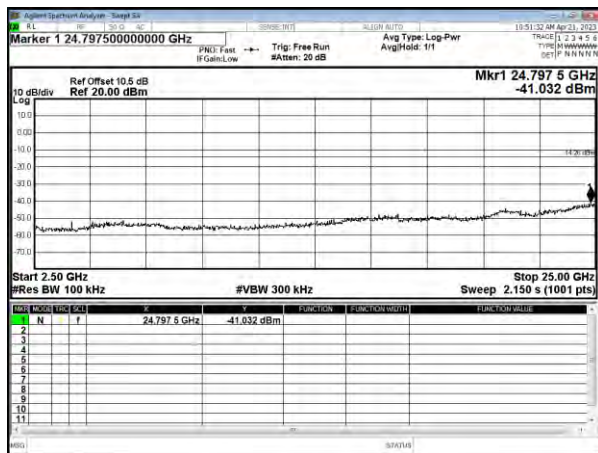

Modulation Standard: $\pi/4$ DQPSK (2Mbps)

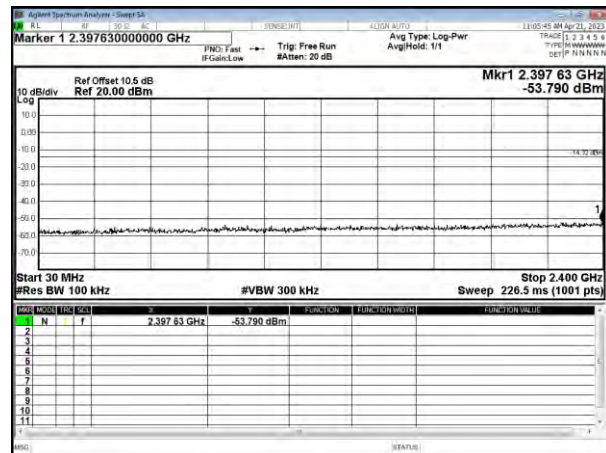

Modulation Standard: $\pi/4$ DQPSK (2Mbps)

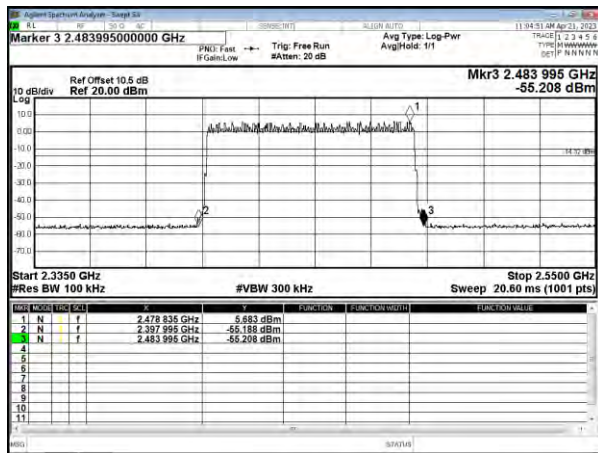

Modulation Standard: $\pi/4$ DQPSK (2Mbps)

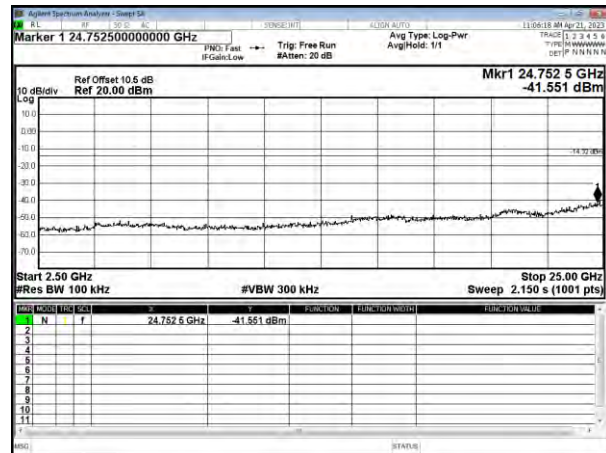



Modulation Standard: 8DPSK (3Mbps)

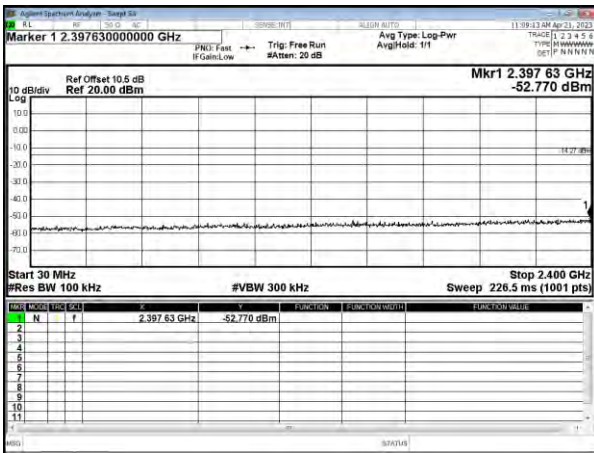

Modulation Standard: 8DPSK (3Mbps)

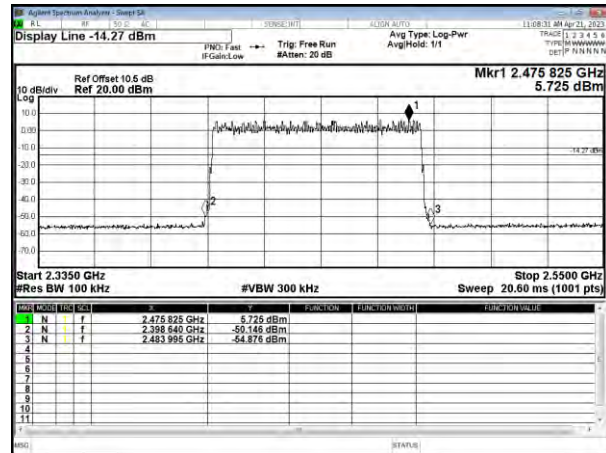

Modulation Standard: 8DPSK (3Mbps)

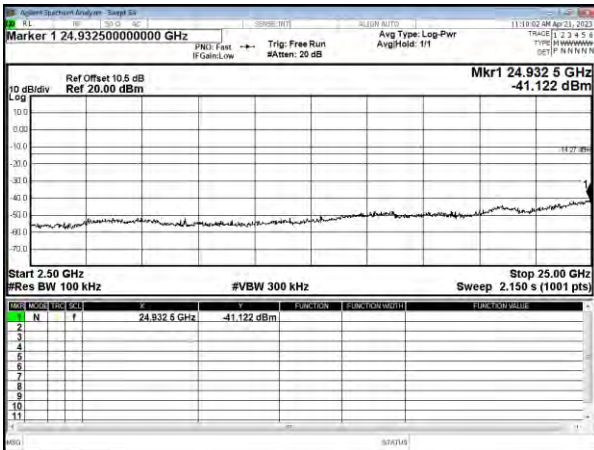



8. 20dB Bandwidth Measurement Data

8.1 Test Limit

Frequency hopping systems shall have hopping channel carrier frequencies separated by a minimum of 25 kHz or the 20 dB bandwidth of the hopping channel, whichever is greater. Alternatively, frequency hopping systems operating in the 2400–2483.5 MHz band may have hopping channel carrier frequencies that are separated by 25 kHz or two-thirds of the 20 dB bandwidth of the hopping channel, whichever is greater, provided the systems operate with an output power no greater than 125 mW.

8.2 Test Procedures

- The transmitter output was connected to the spectrum analyzer.
- Set RBW of spectrum analyzer to 30 KHz and VBW to 100 KHz.
- The 20 dB bandwidth is defined as the total spectrum the power of which is higher than peak power minus 20 dB.

8.3 Test Setup Layout

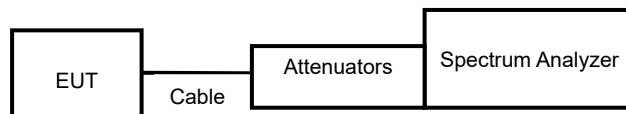

8.4 Test Result and Data

Modulation Type	Channel	Frequency (MHz)	20dB Bandwidth (MHz)	2/3 20dB Bandwidth(MHz)
GFSK (1Mbps)	00	2402	1.039	0.693
	39	2441	1.041	0.694
	78	2480	1.056	0.704
$\pi/4$ -DQPSK (2Mbps)	00	2402	1.278	0.852
	39	2441	1.277	0.851
	78	2480	1.280	0.853
8DPSK (3Mbps)	00	2402	1.297	0.865
	39	2441	1.297	0.865
	78	2480	1.292	0.861
Note	2/3*20dB Bandwidth=20dB Bandwidth x 2/3			



Modulation Type: GFSK (1Mbps)
Channel: 00

Modulation Type: $\pi/4$ -DQPSK (2Mbps)
Channel: 00

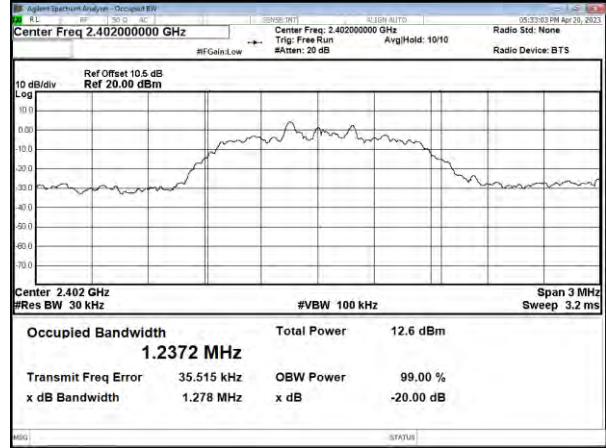
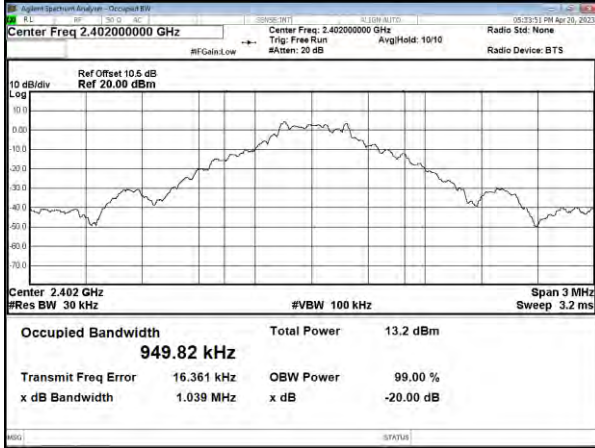

CH39

CH39

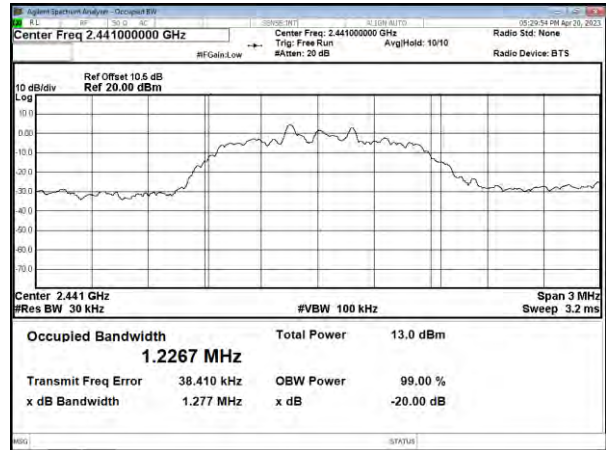
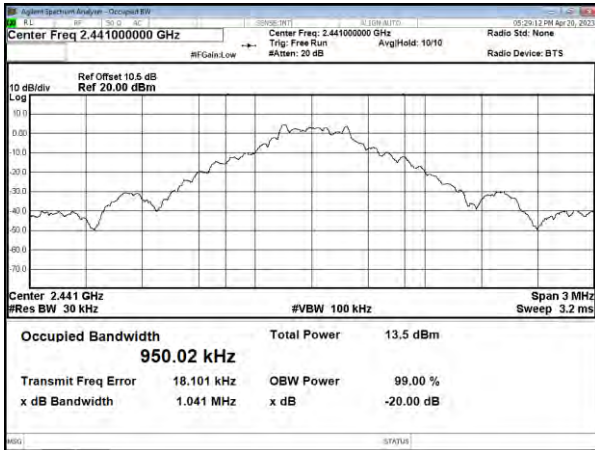

CH78

CH78

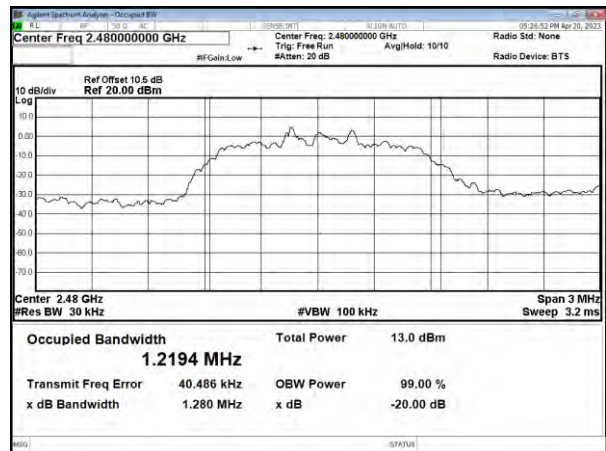



Modulation Type: 8DPSK (3Mbps)
Channel: 00

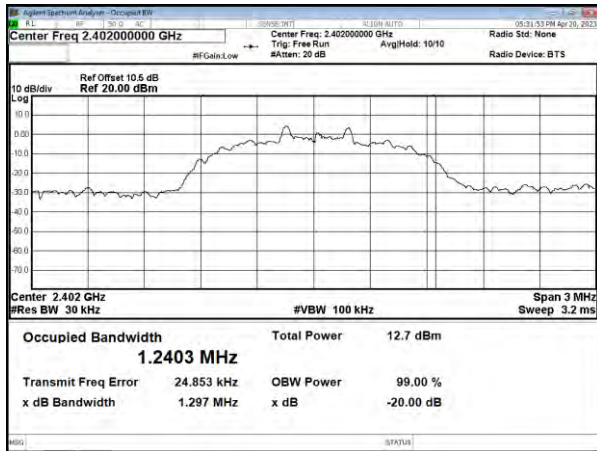

CH39

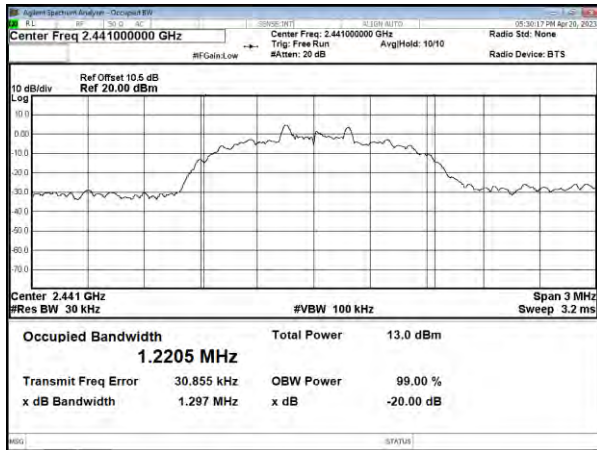

CH78

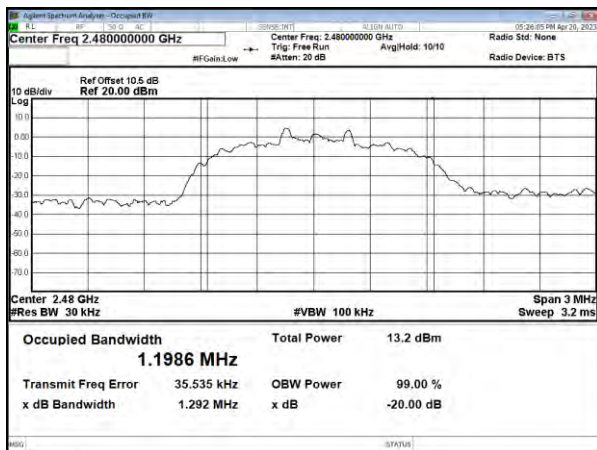



9. Frequencies Separation

9.1 Test Limit

Frequency hopping systems shall have hopping channel carrier frequencies separated by a minimum of 25 kHz or the 20 dB bandwidth of the hopping channel, whichever is greater.

9.2 Test Procedures

- a. The transmitter output was connected to the spectrum analyzer.
- b. Set RBW of spectrum analyzer to 30 KHz and VBW to 100 KHz.
- c. By using the MaxHold function record the separation of two adjacent channels.
- d. Measure the frequency difference of these two adjacent channels.

9.3 Test Setup Layout

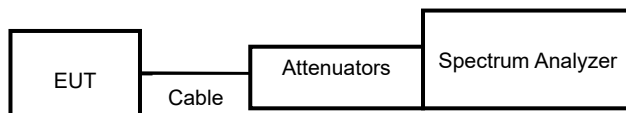

9.4 Test Result and Data

Modulation Type	Channel	Frequency (MHz)	Channel Separation (MHz)	Limit (MHz)
GFSK	0	2402	1.000	0.693
	39	2441	1.000	0.694
	78	2480	1.000	0.704
$\pi/4$ -DQPSK	0	2402	1.000	0.852
	39	2441	1.000	0.851
	78	2480	1.000	0.853
8DPSK	0	2402	1.000	0.865
	39	2441	1.000	0.865
	78	2480	1.000	0.861



Modulation Type: GFSK (1Mbps)
Channel: 00

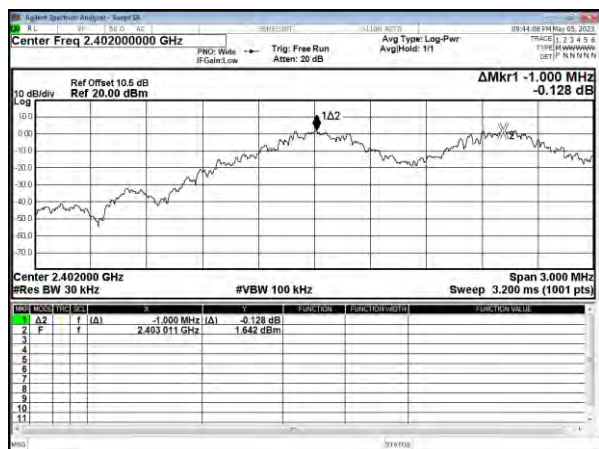

Modulation Type: $\pi/4$ -DQPSK (2Mbps)
Channel: 00

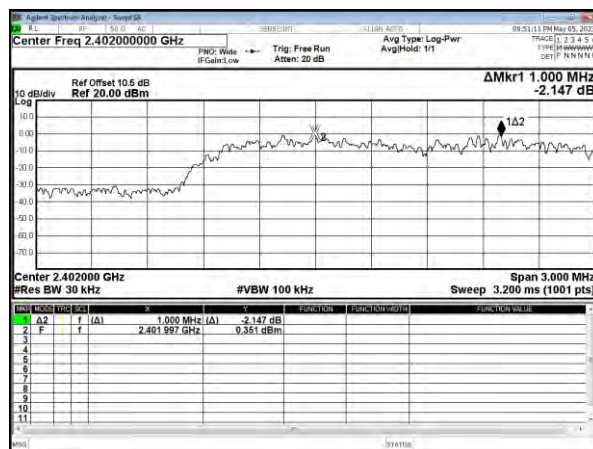

CH39

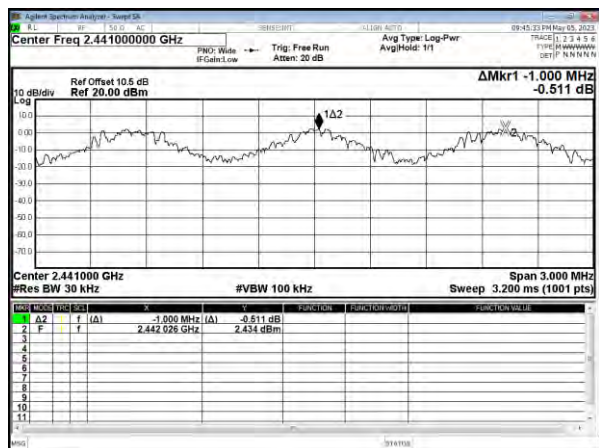

CH39

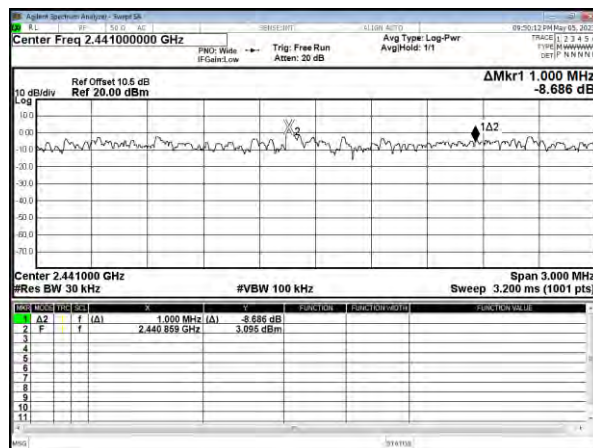

CH78

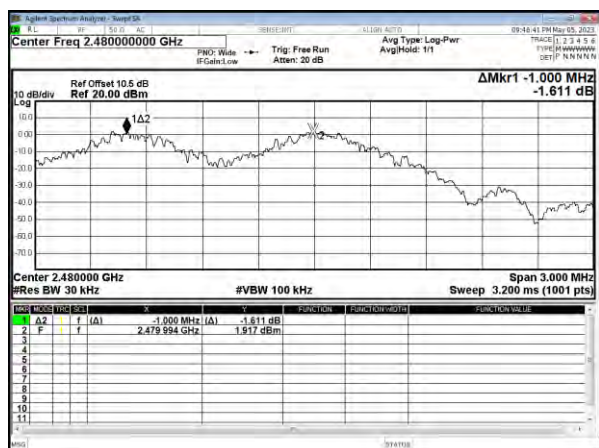

CH78

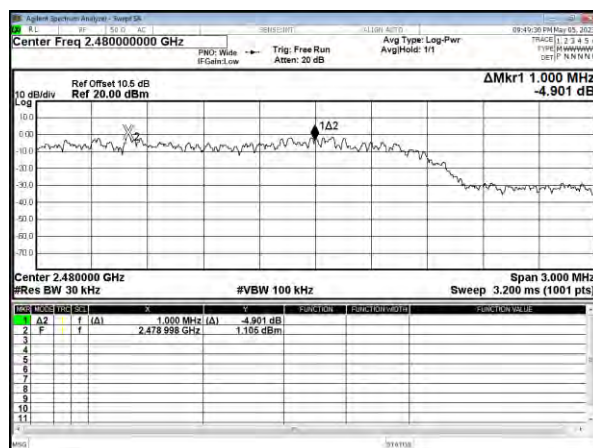



Modulation Type: 8DPSK (3Mbps)
Channel: 00

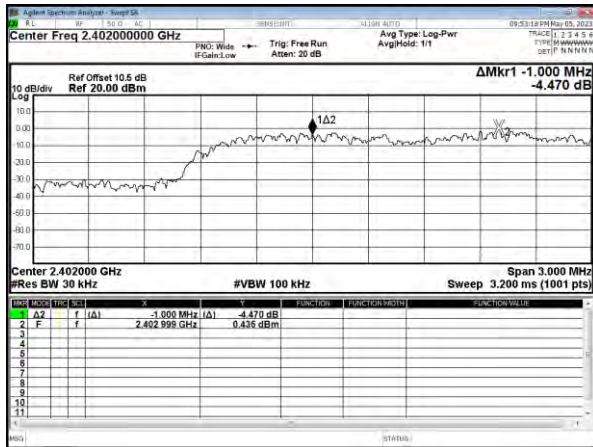

CH39

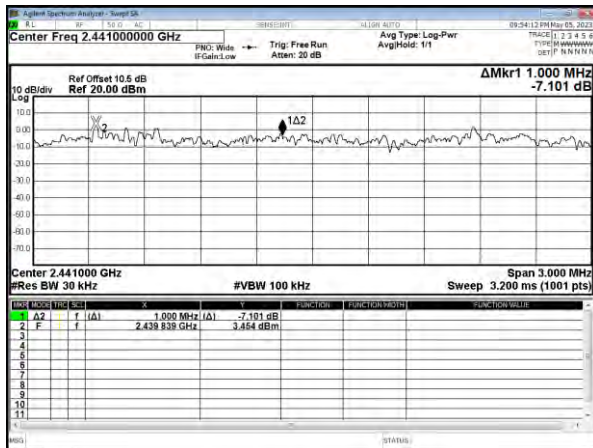

CH78

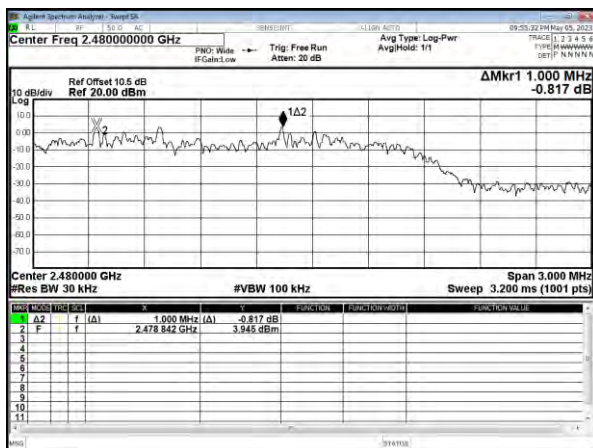



10. Dwell Time on each channel

10.1 Test Limit

The average time of occupancy on any channel shall not be greater than 0.4 seconds within a period of 0.4 seconds multiplied by the number of hopping channels employed.

10.2 Test Procedures

1. The transmitter output was connected to the spectrum analyzer.
2. Adjust the center frequency to measure frequency, then set zero span mode.
2. Set RBW of spectrum analyzer to 1 MHz and VBW to 1 MHz.
4. Measure the time duration of one transmission on the measured frequency.

10.3 Test Setup Layout

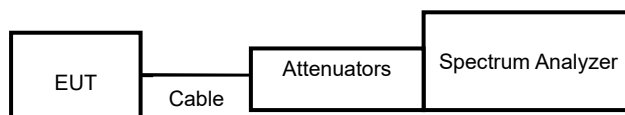

10.4 Test Result and Data

Test Period = 0.4 (second/ channel) x 79 Channel = 31.6 sec

Modulation Type	Frequency (MHz)	Length of transmission time (ms)	Number of transmission in a 31.6 (79 Hopping*0.4)	Dwell Time (ms)	Limit (ms)
GFSK (DH1)	2402	0.404	320.00	129.28	400
GFSK (DH3)	2402	1.665	160.00	266.40	400
GFSK (DH5)	2402	2.915	106.67	310.93	400
$\pi/4$ -DQPSK (DH1)	2402	0.401	320.00	128.32	400
$\pi/4$ -DQPSK (DH3)	2402	1.662	160.00	265.92	400
$\pi/4$ -DQPSK (DH5)	2402	2.910	106.67	310.40	400
8DPSK (DH1)	2402	0.400	320.00	128.00	400
8DPSK (DH3)	2402	1.662	160.00	265.92	400
8DPSK (DH5)	2402	2.910	106.67	310.40	400



Modulation Type: GFSK (1Mbps)
DH1

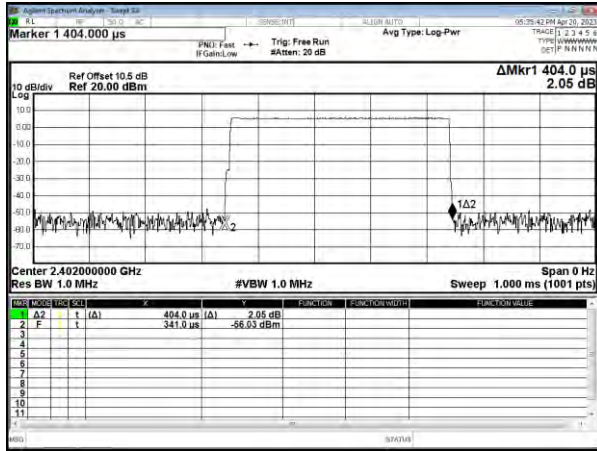

Modulation Type: $\pi/4$ -DQPSK (2Mbps)
DH1

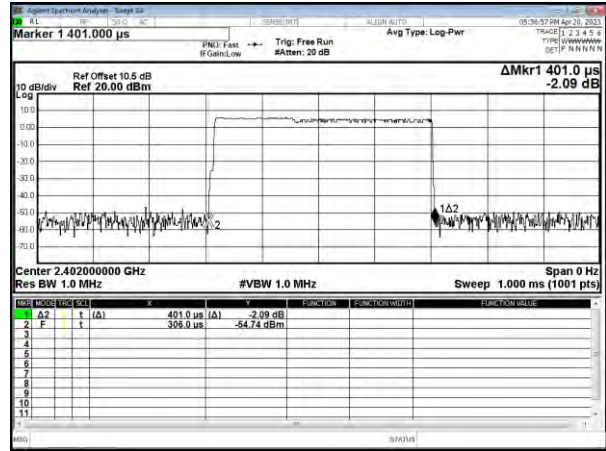

DH3

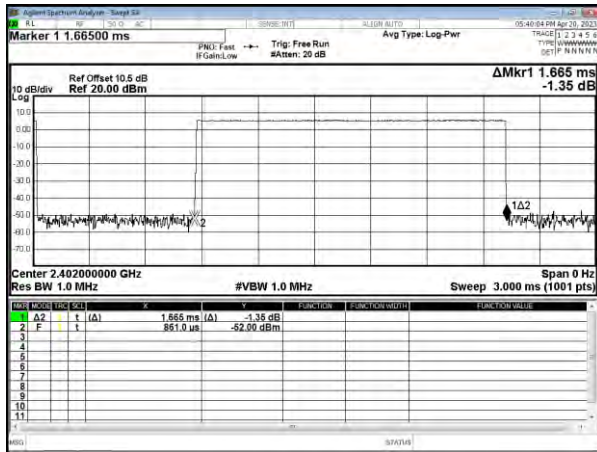

DH3

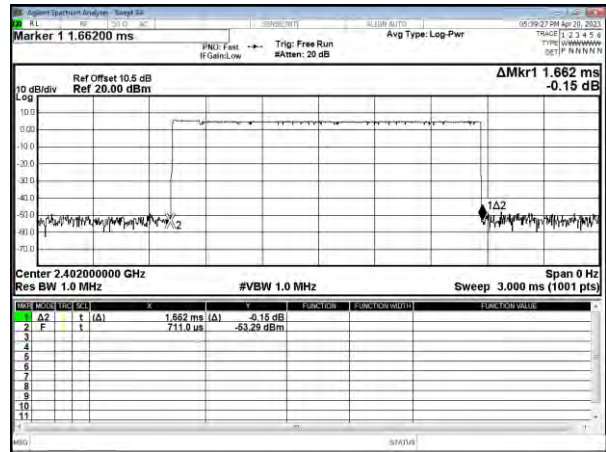

DH5

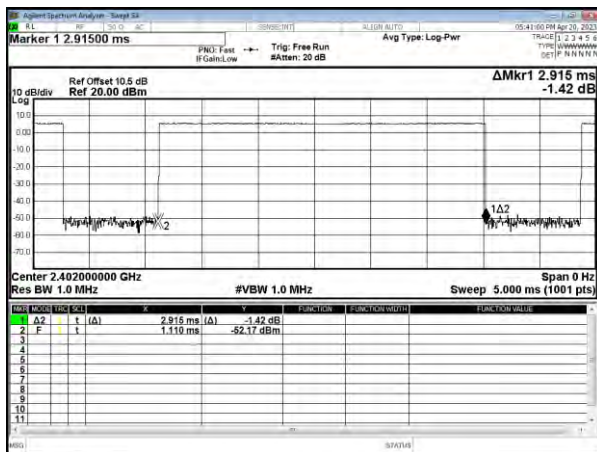

DH5

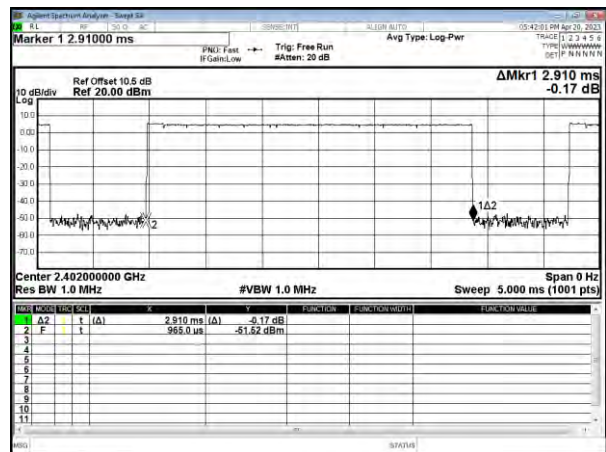



Modulation Type: 8DPSK (3Mbps)
DH1

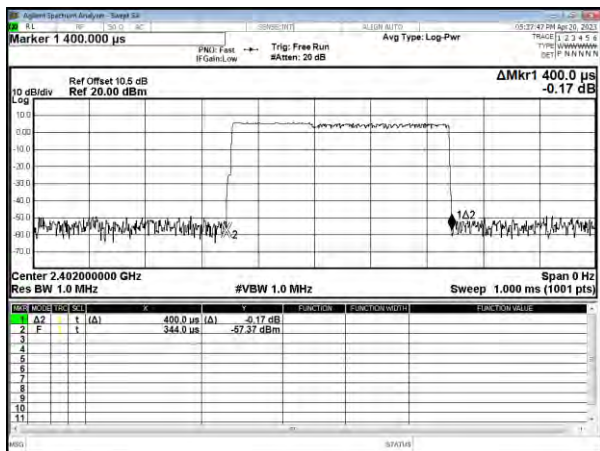

DH3

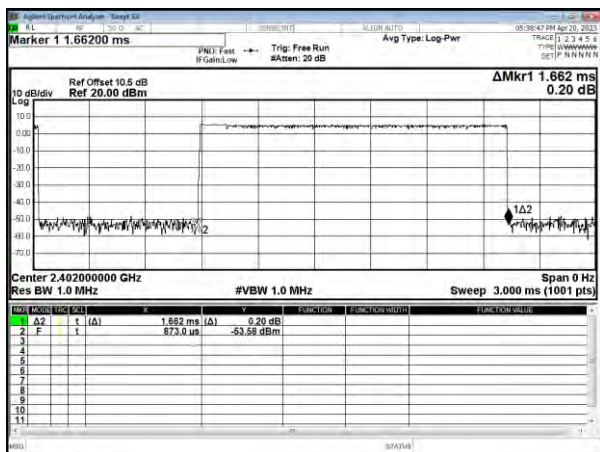

DH5

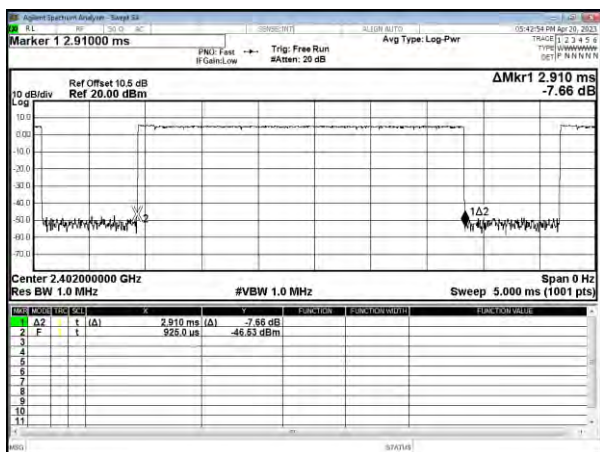



Test Period = 0.4 (second/ channel) x 20 Channel = 8 sec

Modulation Type	Frequency (MHz)	Length of transmission time (ms)	Number of transmission in a 8 (20 Hopping*0.4)	Dwell Time (ms)	Limit (ms)
AFH (DH1)	2402-2421	0.418	160	66.88	400
AFH (DH3)	2402-2421	1.674	80	133.92	400
AFH (DH5)	2402-2421	2.925	53.33	155.99	400

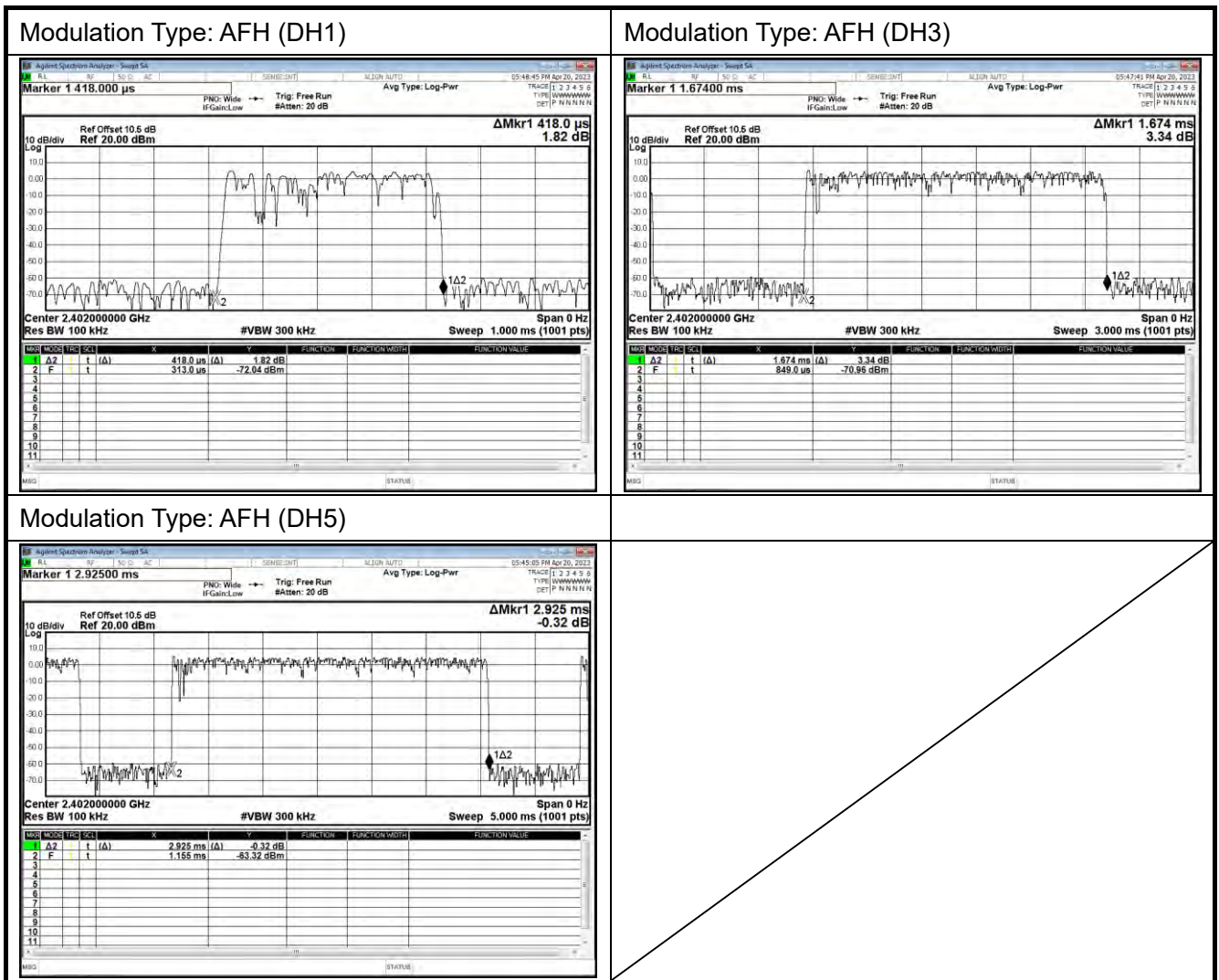



11. Number of Hopping Channels

11.1 Test Limit

Frequency hopping systems in the 2400 ~ 2483.5 MHz band shall use at least 15 channels.

11.2 Test Procedures

- a. The transmitter output was connected to the spectrum analyzer.
- b. Set RBW of spectrum analyzer to 300 KHz and VBW to 300 KHz.
- c. Set the MaxHold function, and then keep the EUT in hopping mode. Record all the signals from each channel until each one has been record.

11.3 Test Setup Layout

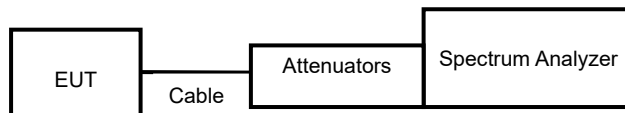

11.4 Test Result and Data

Modulation Type	Number of hopping channels
GFSK	79
$\pi/4$ -DQPSK	79
8DPSK	79



Modulation Standard: GFSK (1Mbps)

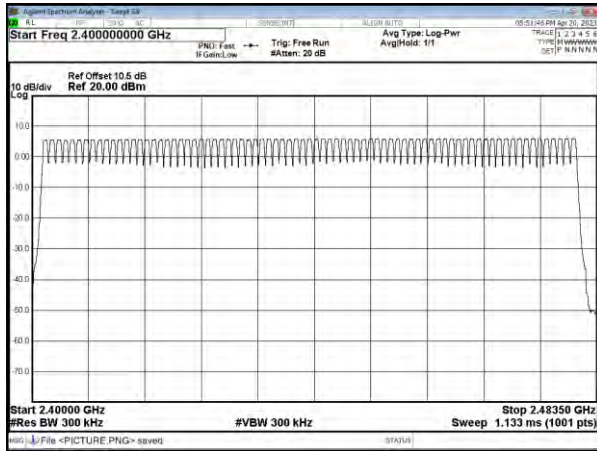

Modulation Standard: $\pi/4$ -DQPSK (2Mbps)

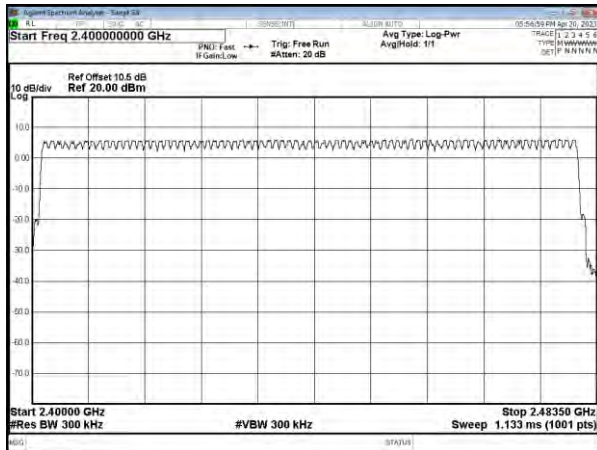

Modulation Standard: 8DPSK (3Mbps)

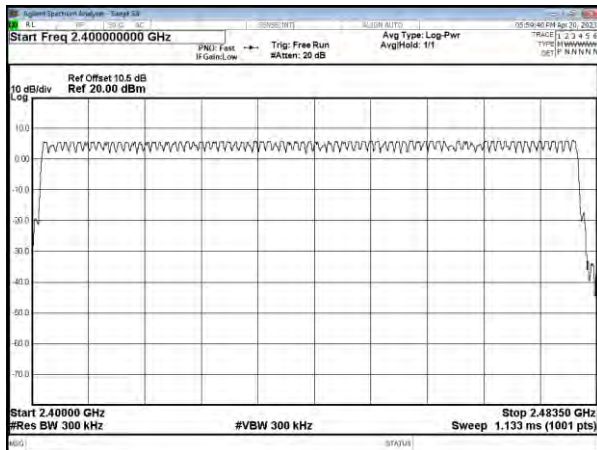



12. Maximum Peak Output Power

12.1 Test Limit

The Maximum Peak Output Power Measurement is 21dBm.

12.2 Test Procedures

The antenna port(RF output)of the EUT was connected to the input(RF input)of a power meter. Power was read directly from the meter and cable loss connection was added to the reading to obtain power at the EUT antenna terminal. The EUT Output Power was set to maximum to produce the worse case test result.

12.3 Test Setup Layout

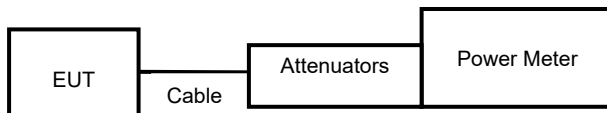

12.4 Test Result and Data

Modulation Type	Channel	Frequency (MHz)	Peak Power Output (dBm)	Peak Power Output (mW)
GFSK (1Mbps)	00	2402	5.516	3.561
	39	2441	5.746	3.755
	78	2480	5.901	3.891
$\pi/4$ DQPSK (2Mbps)	00	2402	5.513	3.559
	39	2441	5.732	3.743
	78	2480	5.924	3.912
8DPSK (3Mbps)	00	2402	5.497	3.546
	39	2441	5.737	3.747
	78	2480	5.952	3.937

----- End of the report -----