



Test Report

Report No.: MTi210930003-04E1

Date of issue: Nov. 02, 2021

Applicant: Zhuhai Quin Technology Co., Ltd.

Product name: Wireless Label Maker

Model(s): P12 Pro, P12N, P12S, P12, P13, P10,
P12 ProN, P12DN, P12D, P12L, P12C,
P12CN, P14, P15, P12A, P12SN,
CP-P12, CP-P12 Pro

FCC ID: 2ASRB-P12PRO

Shenzhen Microtest Co., Ltd.
<http://www.mtitest.com>

Instructions

1. The report shall not be partially reproduced without the written consent of the laboratory;
2. The test results of this report are only responsible for the samples submitted;
3. This report is invalid without the seal and signature of the laboratory;
4. This report is invalid if transferred, altered or tampered with in any form without authorization;
5. Any objection to this report shall be submitted to the laboratory within 15 days from the date of receipt of the report.

Table of Contents

1	GENERAL INFORMATION	6
1.1	DESCRIPTION OF EUT	6
1.2	OPERATION CHANNEL LIST	6
1.3	TEST CHANNEL LIST	7
1.4	ANCILLARY EQUIPMENT LIST	7
1.5	DESCRIPTION OF SUPPORT UNITS	7
2	SUMMARY OF TEST RESULTS	8
3	TEST FACILITIES AND ACCREDITATIONS	9
3.1	TEST LABORATORY	9
3.2	ENVIRONMENTAL CONDITIONS	9
3.3	MEASUREMENT UNCERTAINTY	9
3.4	TEST SOFTWARE	9
4	EQUIPMENT LIST	10
5	TEST RESULT	11
5.1	ANTENNA REQUIREMENT	11
5.1.1	<i>Standard requirement</i>	11
5.1.2	<i>EUT antenna</i>	11
5.2	PEAK OUTPUT POWER	12
5.2.1	<i>Limit</i>	12
5.2.2	<i>Test setup</i>	12
5.2.3	<i>Test procedure</i>	12
5.2.4	<i>Test results</i>	12
5.3	CONDUCTED EMISSION	17
5.3.1	<i>Limits</i>	17
5.3.2	<i>Test setup</i>	17
5.3.3	<i>Test procedure</i>	18
5.3.4	<i>Test results</i>	18
5.4	RADIATED SPURIOUS EMISSION	23
5.4.1	<i>Limits</i>	23
5.4.2	<i>Test setup</i>	24
5.4.3	<i>Test procedure</i>	25
5.4.4	<i>Test results</i>	26
5.4.5	<i>Band edge – radiated</i>	30
5.5	20dB OCCUPIED CHANNEL BANDWIDTH	31
5.5.1	<i>Limit</i>	31
5.5.2	<i>Test setup</i>	31
5.5.3	<i>Test procedure</i>	31
5.5.4	<i>Test results</i>	31
5.6	CARRIER FREQUENCY SEPARATION	36
5.6.1	<i>Limit</i>	36
5.6.2	<i>Test setup</i>	36
5.6.3	<i>Test procedure</i>	36
5.6.4	<i>Test results</i>	36
5.7	HOPPING CHANNEL	41
5.7.1	<i>Limit</i>	41
5.7.2	<i>Test setup</i>	41
5.7.3	<i>Test procedure</i>	41
5.7.4	<i>Test results</i>	41
5.8	DWELL TIME	43



5.8.1	Limit	43
5.8.2	Test setup	43
5.8.3	Test procedure	43
5.8.4	Test results	43
5.9	CONDUCTED BAND EDGE	48
5.9.1	Limit	48
5.9.2	Test setup	48
5.9.3	Test procedure	48
5.9.4	Test results	48
5.10	SPURIOUS RF CONDUCTED EMISSIONS	53
5.10.1	Limit	53
5.10.2	Measuring instruments	53
5.10.3	Test setup	53
5.10.4	Test procedure	53
5.10.5	Test results	53
PHOTOGRAPHS OF THE TEST SETUP		56
PHOTOGRAPHS OF THE EUT		58



TEST RESULT CERTIFICATION	
Applicant's name.....	Zhuhai Quin Technology Co., Ltd.
Address.....	ROOM 201 2ND FLOOR, 3RD FLOOR, BLOCK 2, NO.1 CUIZHU 4TH STREET, QIANSHAN, XIANGZHOU DISTRICT, ZHUHAI CITY
Manufacturer's Name	Zhuhai Quin Technology Co., Ltd.
Address.....	ROOM 201 2ND FLOOR, 3RD FLOOR, BLOCK 2, NO.1 CUIZHU 4TH STREET, QIANSHAN, XIANGZHOU DISTRICT, ZHUHAI CITY
Product description	
Product name.....	Wireless Label Maker
Trademark	N/A
Model Name	P12 Pro
Serial Model	P12N, P12S, P12, P13, P10, P12 ProN, P12DN, P12D, P12L, P12C, P12CN, P14, P15, P12A, P12SN, CP-P12, CP-P12 Pro
Standards.....	FCC Part 15.247
Test procedure	ANSI C63.10-2013
Date of Test	
Date (s) of performance of tests..... :	2021-10-20 ~2021-10-28
Test Result	Pass
This device described above has been tested by Shenzhen Microtest Co., Ltd. and the test results show that the equipment under test (EUT) is in compliance with the FCC requirements. And it is applicable only to the tested sample identified in the report.	

Testing Engineer : *Cindy Qin*
(Cindy Qin)

Technical Manager : *Leon Chen*
(Leon Chen)

Authorized Signatory : *Tom Xue*
(Tom Xue)

1 General Information

1.1 Description of EUT

Product name:	Wireless Label Maker
Model name:	P12 Pro
Serial model:	P12N, P12S, P12, P13, P10, P12 ProN, P12DN, P12D, P12L, P12C, P12CN, P14, P15, P12A, P12SN, CP-P12, CP-P12 Pro
Difference in series models:	All the models are the same circuit and RF module, except the appearance color, appearance of silk screen pattern and model name.
Operation frequency:	2402-2480MHz
Modulation type:	GFSK, $\pi/4$ -DQPSK
Bit Rate of transmitter:	1 Mbps, 2Mbps
Antenna type:	PCB Antenna
Antenna gain:	-0.58dBi
Max. output power:	6.298dBm
Hardware version:	Q113_A
Software version:	V0.2.5
Power source:	DC 5V from adapter AC 120V/60Hz or DC 7.4V from battery
Adapter information:	N/A
Battery:	N/A
Serial number:	MTi210930003-04-S0001

1.2 Operation channel list

Channel	Frequency (MHz)	Channel	Frequency (MHz)	Channel	Frequency (MHz)
00	2402	27	2429	54	2456
01	2403	28	2430	55	2457
02	2404	29	2431	56	2458
03	2405	30	2432	57	2459
04	2406	31	2433	58	2460
05	2407	32	2434	59	2461
06	2408	33	2435	60	2462



07	2409	34	2436	61	2463
08	2410	35	2437	62	2464
09	2411	36	2438	63	2465
10	2412	37	2439	64	2466
11	2413	38	2440	65	2467
12	2414	39	2441	66	2468
13	2415	40	2442	67	2469
14	2416	41	2443	68	2470
15	2417	42	2444	69	2471
16	2418	43	2445	70	2472
17	2419	44	2446	71	2473
18	2420	45	2447	72	2474
19	2421	46	2448	73	2475
20	2422	47	2449	74	2476
21	2423	48	2450	75	2477
22	2424	49	2451	76	2478
23	2425	50	2452	77	2479
24	2426	51	2453	78	2480
25	2427	52	2454	--	--
26	2428	53	2455	--	--

1.3 Test channel list

Channel	Channel	Frequency (MHz)
Low	00	2402
Middle	39	2441
High	78	2480

1.4 Ancillary equipment list

Equipment	Model	S/N	Manufacturer	Certificate type
Adapter	HW-090200 CH0	/	Huizhou BYD Electronics Co., Ltd.	/

1.5 Description of Support Units

The EUT has been tested as an independent unit together with other necessary accessories or support units. The following support units or accessories were used to form a representative test configuration during the tests.

Item	Equipment	Brand	Model/Type No.	Series No.	Note
/	/	/	/	/	/

Note:

- (1) The support equipment was authorized by Declaration of Confirmation.
- (2) For detachable type I/O cable should be specified the length in cm in 『Length』 column.

2 Summary of Test Results

Test procedures according to the technical standards:

No.	Standard Section	Test Item	Result	Remark
1	15.203	Antenna requirement	Pass	
2	15.247(b)(1)	Peak output power	Pass	
3	15.207	Conducted emission	Pass	
4	15.247(d)	Band edge	Pass	
5	15.205/15.209	Spurious emission	Pass	
6	15.247(a)(1)	20dB occupied bandwidth	Pass	
7	15.247(a)(1)	Carrier Frequencies Separation	Pass	
8	15.247(a)(1)	Hopping channel number	Pass	
9	15.247(a)(1)	Dwell time	Pass	
10	15.247(d)	Spurious RF Conducted Emissions	Pass	

3 Test Facilities and Accreditations

3.1 Test laboratory

Test Laboratory	Shenzhen Microtest Co., Ltd.
Location	101, No. 7, Zone 2, Xinxing Industrial Park, Fuhai Avenue, Xinhe Community, Fuhai Street, Bao' an District, Shenzhen, Guangdong, China.
FCC Registration No.:	448573

3.2 Environmental conditions

Temperature:	15°C~35°C
Humidity	20%~75%
Atmospheric pressure	98kPa~101kPa

3.3 Measurement uncertainty

The reported uncertainty of measurement $y \pm U$ where expanded uncertainty U is based on a standard uncertainty multiplied by a coverage factor of $k=2$ providing a level of confidence of approximately 95 %

No.	Item	Uncertainty
1	Conducted Emission Test	$\pm 1.38\text{dB}$
2	RF power, conducted	$\pm 0.16\text{dB}$
3	Spurious emissions, conducted	$\pm 0.21\text{dB}$
4	All emissions, radiated(<1G)	$\pm 4.68\text{dB}$
5	All emissions, radiated(>1G)	$\pm 4.89\text{dB}$
6	Temperature	$\pm 0.5^\circ\text{C}$
7	Humidity	$\pm 2\%$

3.4 Test software

Software Name	Manufacturer	Model	Version
Bluetooth and WiFi Test System	Shenzhen JS tonskend co., ltd	JS1120-3	2.5.77.0418

4 Equipment List

Equipment No.	Equipment Name	Manufacturer	Model	Serial No.	Calibration date	Due date
MTI-E043	EMI Test Receiver	Rohde&schwarz	ESCI7	101166	2021/06/02	2022/06/01
MTI-E044	TRILOG Broadband Antenna	schwarabeck	VULB 9163	9163-1338	2021/05/30	2023/05/29
MTI-E047	Amplifier	Hewlett-Packard	8447F	3113A06150	2021/06/02	2022/06/01
MTI-E089	ESG Vector Signal Generator	Agilent	N5182A	MY49060455	2021/06/02	2022/06/01
MTI-E058	ESG Series Analog Ssignal Generator	Agilent	E4421B	GB40051240	2021/06/02	2022/06/01
MTI-E062	PXA Signal Analyzer	Agilent	N9030A	MY51350296	2021/06/02	2022/06/01
MTI-E066	MXA Signal Analyzer	Agilent	N9020A	MY50143483	2021/06/02	2022/06/01
MTI-E078	Synthesized Sweeper	Agilent	83752A	3610A01957	2021/06/02	2022/06/01
MTI-E079	DC Power Supply	Agilent	E3632A	MY40027695	2021/06/02	2022/06/01
MTI-E045	Double Ridged Broadband Horn Antenna	schwarabeck	BBHA 9120 D	9120D-2278	2021/05/30	2023/05/29
MTI-E021	EMI Test Receiver	Rohde&schwarz	ESCS30	100210	2021/06/02	2022/06/01
MTI-E022	Pulse Limiter	Schwarzbeck	VSTD 9561-F	00679	2021/06/02	2022/06/01
MTI-E023	Artificial mains network	Schwarzbeck	NSLK 8127	NSLK 8127 #841	2021/06/02	2022/06/01
MTI-E046	Active Loop Antenna	Schwarzbeck	FMZB 1519 B	00044	2021/05/30	2023/05/29
MTI-E048	Amplifier	Agilent	8449B	3008A02400	2021/06/02	2022/06/01
MTI-E072	Thermometer Clock Humidity Monitor	-	HTC-1	/	2021/06/02	2022/06/01

Note: the calibration interval of the above test instruments is 12 or 24 months and the calibrations are traceable to international system unit (SI).

5 Test Result

5.1 Antenna requirement

5.1.1 Standard requirement

15.203 requirement: For intentional device, according to 15.203: an intentional radiator shall be designed to ensure that no antenna other than that furnished by the responsible party shall be used with the device

5.1.2 EUT antenna

The EUT antenna is PCB antenna (-0.58dBi). It comply with the standard requirement. In case of replacement of broken antenna the same antenna type must be used.

5.2 Peak output power

5.2.1 Limit

FCC Part15 Subpart C			
Section	Test Item	Limit	Frequency Range (MHz)
15.247(b)(1)	Peak output power	Power<125mW (20.97dBm)	2400-2483.5

5.2.2 Test setup

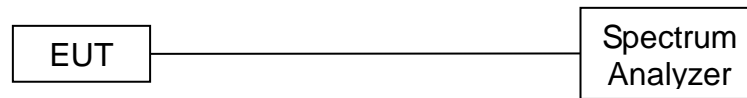

5.2.3 Test procedure

- (1) The EUT was directly connected to the spectrum analyzer and antenna output port as show in the block diagram above.
- (2) Spectrum Setting:
 RBW=1MHz, VBW=3MHz, Detector=Peak (If 20dB BW ≤1 MHz)
 RBW=3MHz, VBW=8MHz, Detector=Peak (If 20dB BW > 1 MHz)
- (3) The EUT was set to continuously transmitting in the max power during the test.

5.2.4 Test results



Test data

EUT:	Wireless Label Maker	Model Name:	P12 Pro
Pressure:	1012 hPa	Test Voltage:	DC 7.4V from battery

GFSK

Test Channel	Frequency (MHz)	Maximum Peak Output Power(dBm)	Limit (dBm)
CH00	2402	5.762	20.97
CH39	2441	5.751	20.97
CH78	2480	5.331	20.97

$\pi/4$ -DQPSK

Test Channel	Frequency (MHz)	Maximum Peak Output Power(dBm)	Limit (dBm)
CH00	2402	6.298	20.97
CH39	2441	6.293	20.97
CH78	2480	5.842	20.97



Test plots

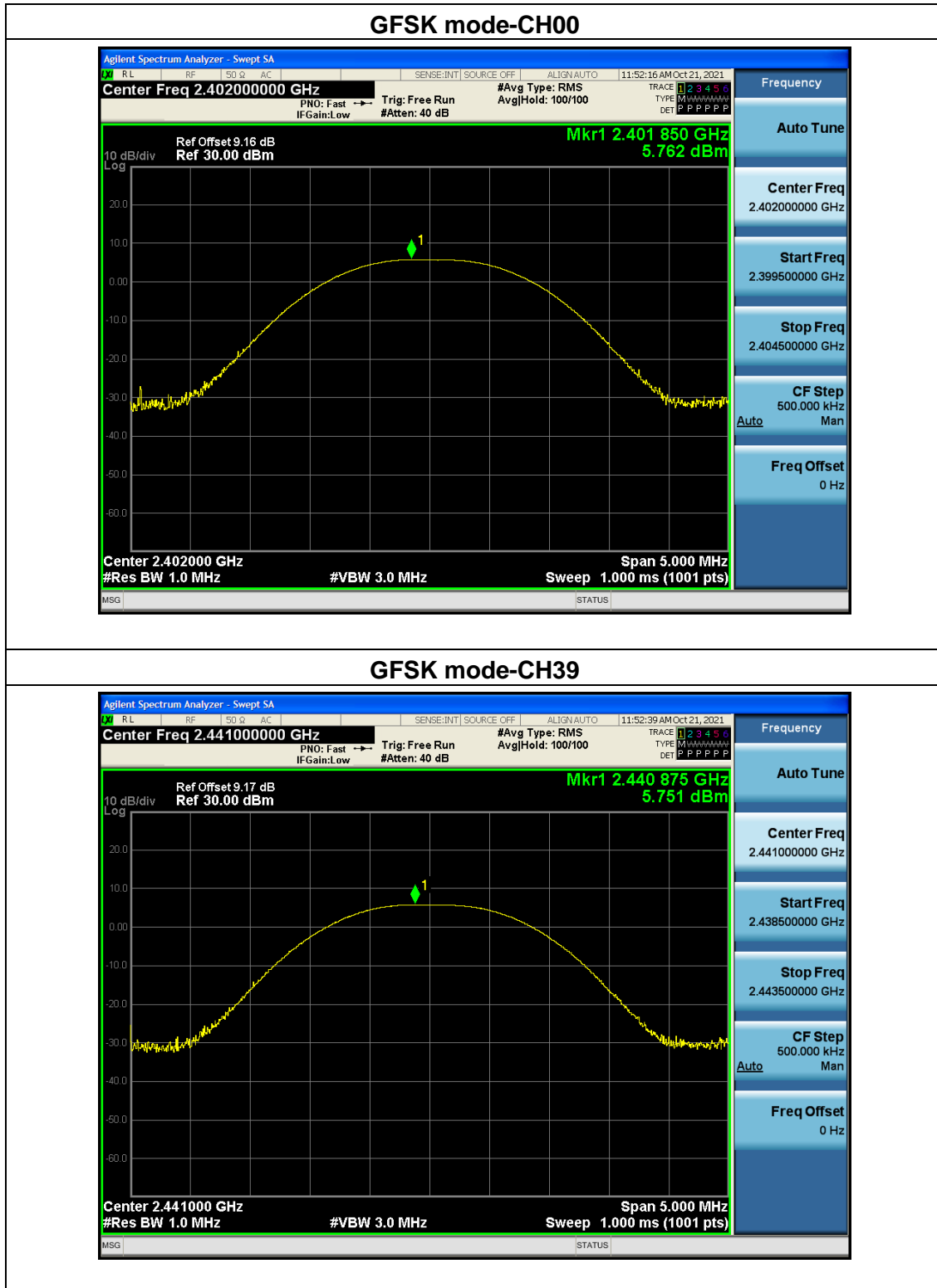



GFSK mode-CH78

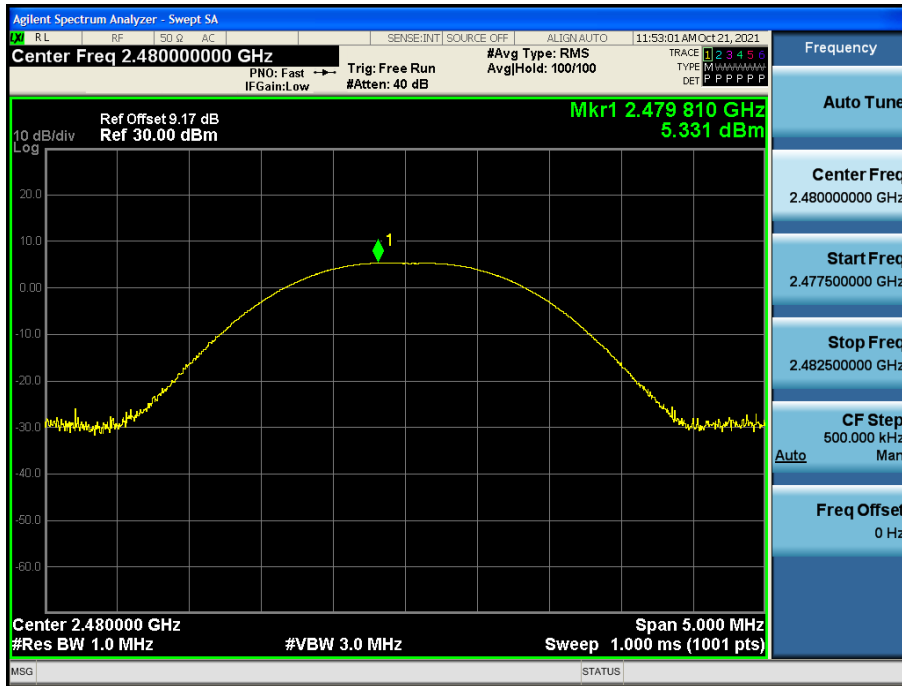

$\pi/4$ -DQPSK mode-CH00





$\pi/4$ -DQPSK mode-CH39



$\pi/4$ -DQPSK mode-CH78

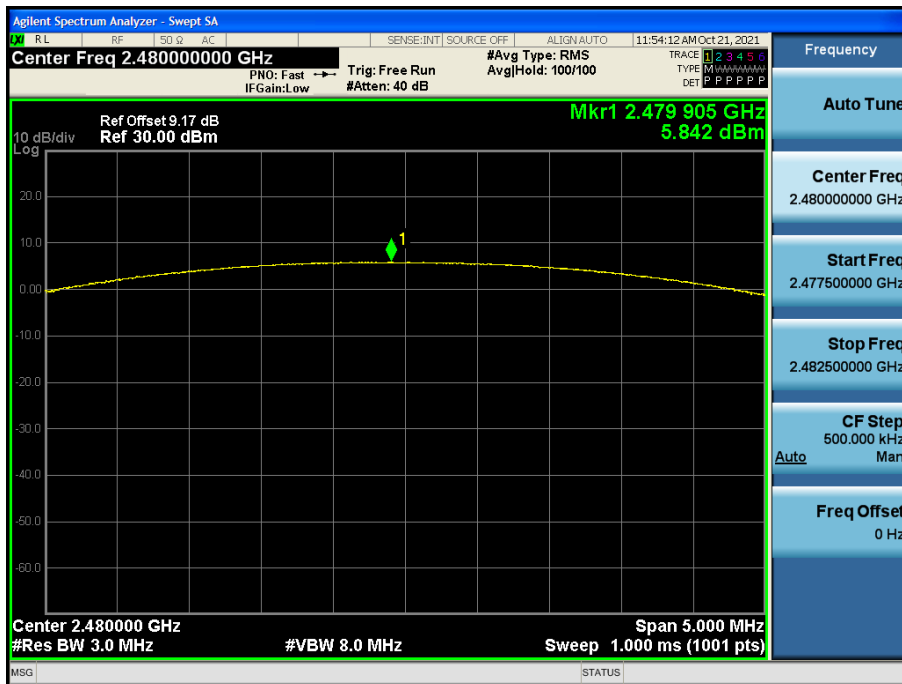

5.3 Conducted emission

5.3.1 Limits

FREQUENCY (MHz)	Class B (dBuV)	
	Quasi-peak	Average
0.15 -0.5	66 - 56 *	56 - 46 *
0.50 -5.0	56.00	46.00
5.0 -30.0	60.00	50.00

Note: *Decreases with the logarithm of the frequency.

5.3.2 Test setup

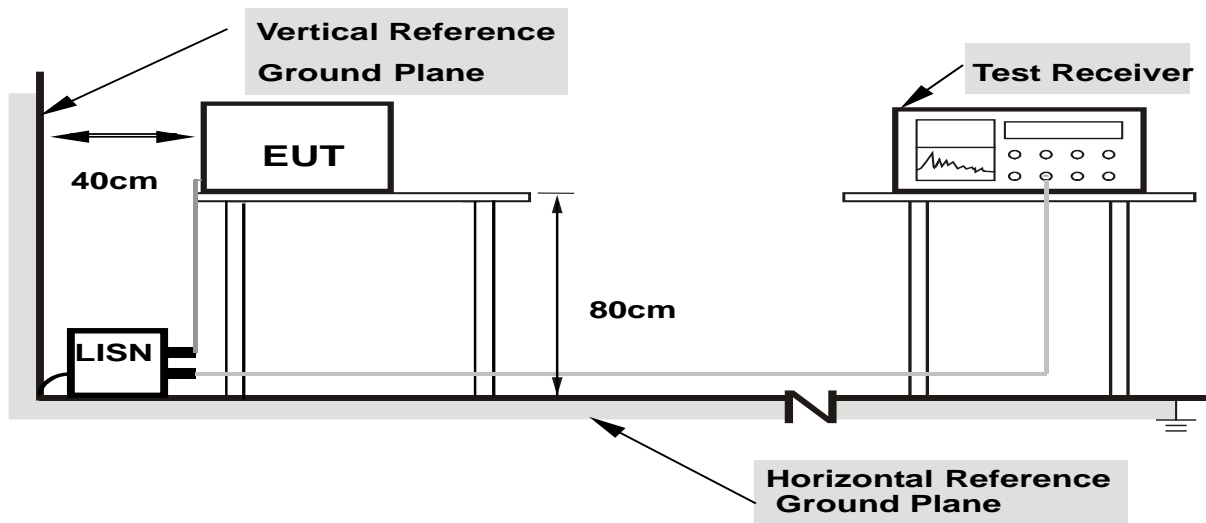

- Note:**
- 1.Support units were connected to second LISN.
 - 2.Both of LISNs (AMN) are 80 cm from EUT and at least 80 from other units and other metal planes

5.3.3 Test procedure

a. EUT Operating Conditions

The EUT was configured for testing in a typical fashion (as a customer would normally use it). The EUT has been programmed to continuously transmit during test. This operating condition was tested and used to collect the included data.

b. The following table is the setting of the receiver

Receiver Parameters	Setting
Attenuation	10 dB
Start Frequency	0.15 MHz
Stop Frequency	30 MHz
IF Bandwidth	9 kHz

- c. The EUT was placed 0.8 meters from the horizontal ground plane with EUT being connected to the power mains through a line impedance stabilization network (LISN). All other support equipments powered from additional LISN(s). The LISN provide 50 Ohm/ 50uH of coupling impedance for the measuring instrument.
- d. Interconnecting cables that hang closer than 40 cm to the ground plane shall be folded back and forth in the center forming a bundle 30 to 40 cm long.
- e. I/O cables that are not connected to a peripheral shall be bundled in the center. The end of the cable may be terminated, if required, using the correct terminating impedance. The overall length shall not exceed 1 m.
- f. LISN at least 80 cm from nearest part of EUT chassis.

For the actual test configuration, please refer to the related Item –EUT Test Photos.

5.3.4 Test results

Note:

1. The three modulated high, medium and low channels have been tested. The report only shows the worst mode. The worst mode is $\pi/4$ -DQPSK CH00.
2. Emission Level = Reading Level + Factor, Margin = Emission Level - Limit, Factor = LISN modulus + Cable Loss



EUT:	Wireless Label Maker	Model Name:	P12 Pro
Pressure:	1010hPa	Phase::	L
Test Voltage:	DC 5V from adapter AC 120V/60Hz	Test Mode:	Charging+TX

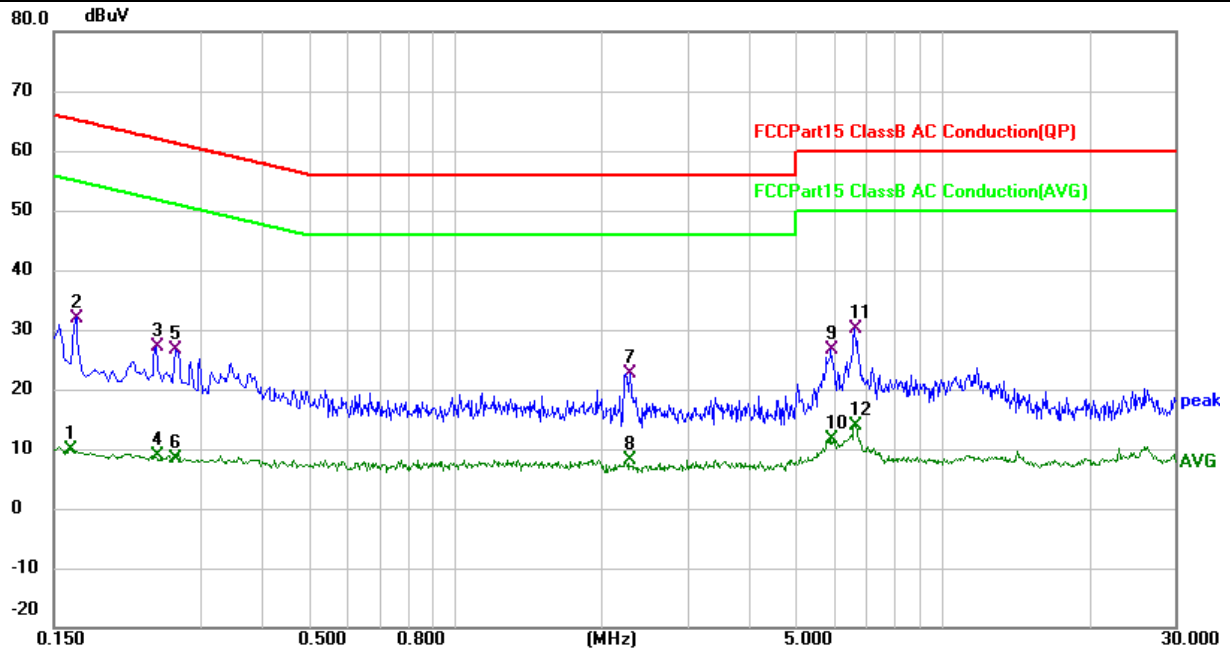

No.	Mk.	Freq. MHz	Reading Level dBuV	Correct Factor dB	Measure- ment dBuV	Limit dBuV	Over dB	Detector
1		0.1620	-1.14	10.99	9.85	55.36	-45.51	AVG
2		0.1660	21.01	10.99	32.00	65.16	-33.16	QP
3		0.2420	16.03	10.99	27.02	62.03	-35.01	QP
4		0.2420	-2.10	10.99	8.89	52.03	-43.14	AVG
5		0.2660	15.52	11.00	26.52	61.24	-34.72	QP
6		0.2660	-2.65	11.00	8.35	51.24	-42.89	AVG
7		2.2900	6.67	15.97	22.64	56.00	-33.36	QP
8		2.2900	-7.81	15.97	8.16	46.00	-37.84	AVG
9		5.9260	15.02	11.55	26.57	60.00	-33.43	QP
10		5.9260	0.02	11.55	11.57	50.00	-38.43	AVG
11	*	6.6180	18.60	11.61	30.21	60.00	-29.79	QP
12		6.6180	2.39	11.61	14.00	50.00	-36.00	AVG



EUT:	Wireless Label Maker	Model Name:	P12 Pro
Pressure:	1010hPa	Phase::	N
Test Voltage:	DC 5V from adapter AC 120V/60Hz	Test Mode:	Charging+TX

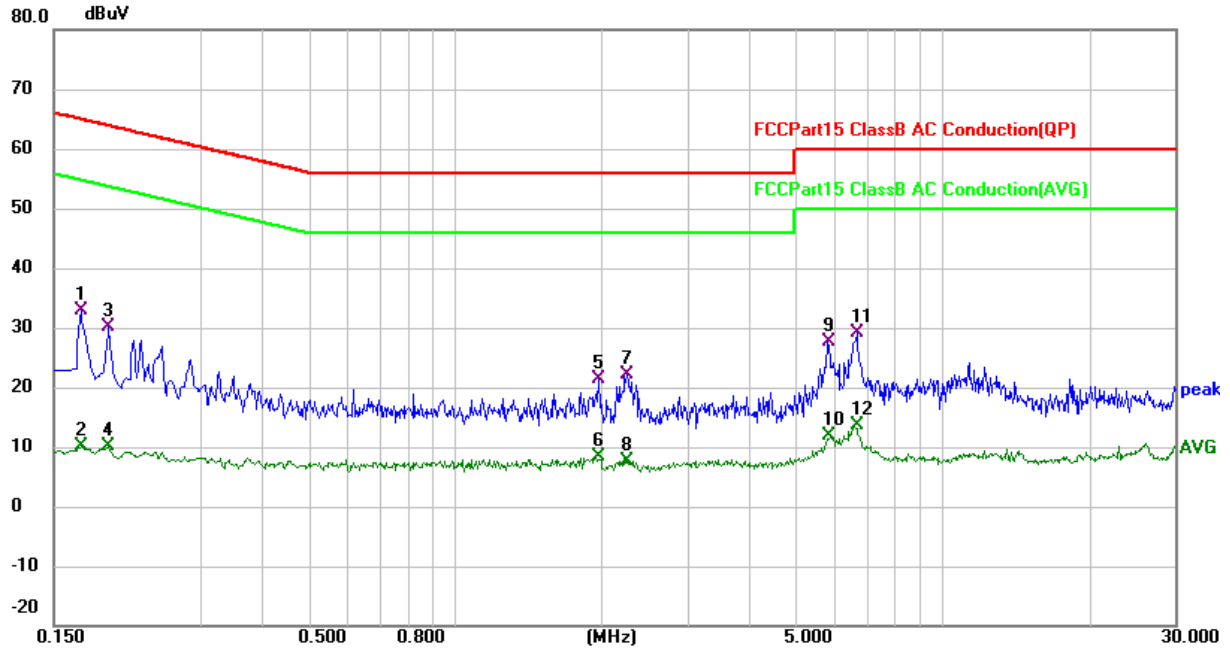

No.	Mk.	Freq. MHz	Reading Level dBuV	Correct Factor dB	Measure- ment dBuV	Limit dBuV	Over dB	Detector
1		0.1700	21.94	10.93	32.87	64.96	-32.09	QP
2		0.1700	-0.81	10.93	10.12	54.96	-44.84	AVG
3		0.1940	19.24	10.92	30.16	63.86	-33.70	QP
4		0.1940	-0.83	10.92	10.09	53.86	-43.77	AVG
5		1.9700	6.03	15.32	21.35	56.00	-34.65	QP
6		1.9700	-6.93	15.32	8.39	46.00	-37.61	AVG
7		2.2580	6.28	15.91	22.19	56.00	-33.81	QP
8		2.2580	-8.22	15.91	7.69	46.00	-38.31	AVG
9		5.8260	16.18	11.40	27.58	60.00	-32.42	QP
10		5.8260	0.37	11.40	11.77	50.00	-38.23	AVG
11	*	6.6820	17.67	11.41	29.08	60.00	-30.92	QP
12		6.6820	2.28	11.41	13.69	50.00	-36.31	AVG



EUT:	Wireless Label Maker	Model Name:	P12 Pro
Pressure:	1010hPa	Phase:	L
Test Voltage:	DC 5V from adapter AC 240V/60Hz	Test Mode:	Charging+TX

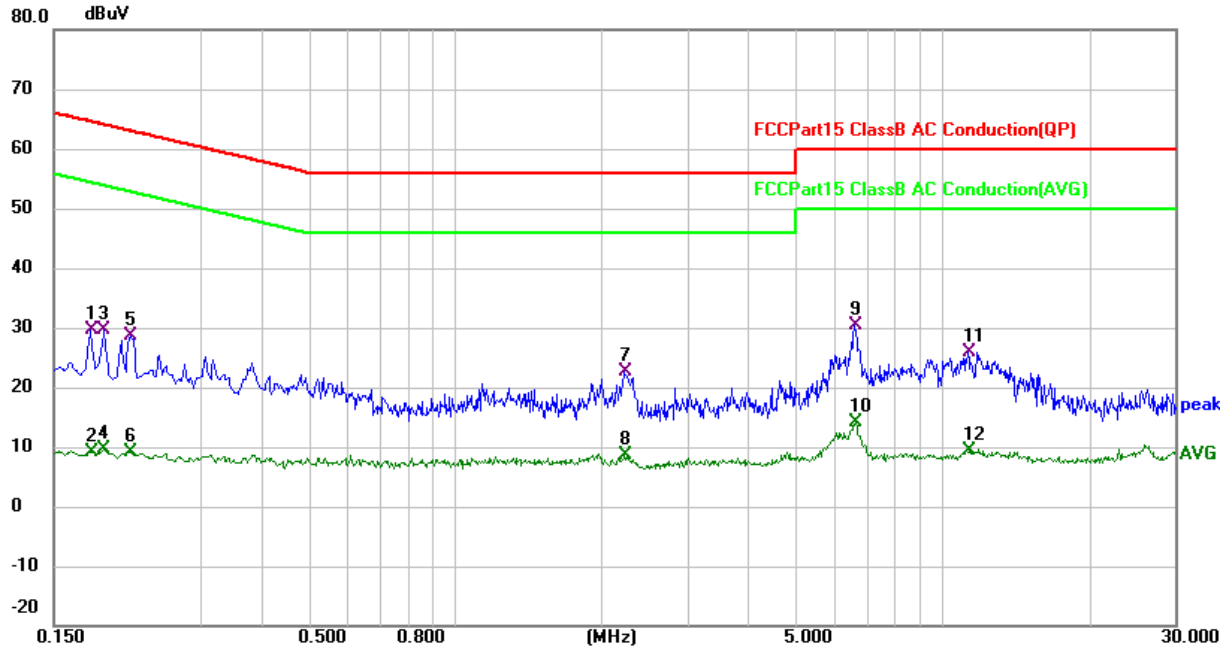

No.	Mk.	Freq. MHz	Reading Level dBuV	Correct Factor dB	Measure- ment dBuV	Limit dBuV	Over dB	Detector
1		0.1780	18.56	10.98	29.54	64.58	-35.04	QP
2		0.1780	-1.74	10.98	9.24	54.58	-45.34	AVG
3		0.1900	18.75	10.98	29.73	64.04	-34.31	QP
4		0.1900	-1.29	10.98	9.69	54.04	-44.35	AVG
5		0.2140	17.57	10.98	28.55	63.05	-34.50	QP
6		0.2140	-1.74	10.98	9.24	53.05	-43.81	AVG
7		2.2340	6.87	15.86	22.73	56.00	-33.27	QP
8		2.2340	-7.34	15.86	8.52	46.00	-37.48	AVG
9	*	6.6220	18.75	11.61	30.36	60.00	-29.64	QP
10		6.6220	2.56	11.61	14.17	50.00	-35.83	AVG
11		11.2860	14.35	11.61	25.96	60.00	-34.04	QP
12		11.2860	-2.11	11.61	9.50	50.00	-40.50	AVG



EUT:	Wireless Label Maker	Model Name:	P12 Pro
Pressure:	1010hPa	Phase:	N
Test Voltage:	DC 5V from adapter AC 240V/60Hz	Test Mode:	Charging+TX

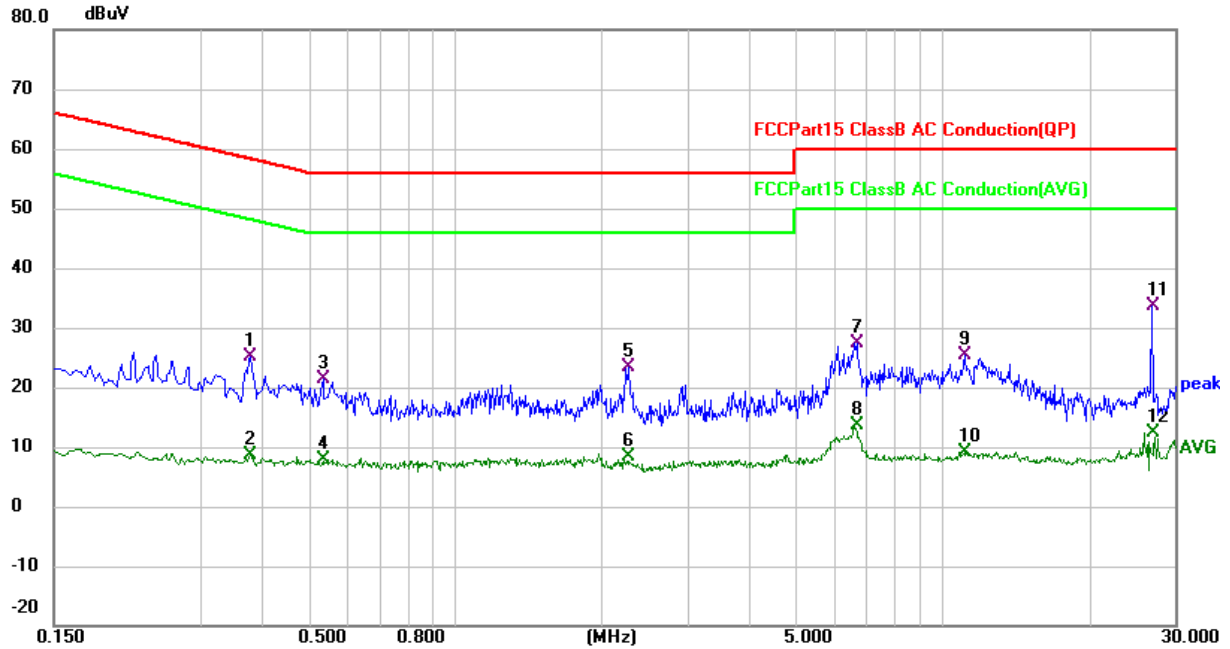

No.	Mk.	Freq.	Reading Level	Correct Factor	Measurement	Limit	Over	
		MHz	dBuV	dB	dBuV	dBuV	dB	Detector
1		0.3780	14.20	10.89	25.09	58.32	-33.23	QP
2		0.3780	-2.33	10.89	8.56	48.32	-39.76	AVG
3		0.5340	10.44	10.94	21.38	56.00	-34.62	QP
4		0.5340	-2.99	10.94	7.95	46.00	-38.05	AVG
5		2.2740	7.46	15.93	23.39	56.00	-32.61	QP
6		2.2740	-7.56	15.93	8.37	46.00	-37.63	AVG
7		6.6740	15.92	11.41	27.33	60.00	-32.67	QP
8		6.6740	2.19	11.41	13.60	50.00	-36.40	AVG
9		11.1140	13.88	11.56	25.44	60.00	-34.56	QP
10		11.1140	-2.45	11.56	9.11	50.00	-40.89	AVG
11	*	26.8980	21.88	11.73	33.61	60.00	-26.39	QP
12		26.8980	0.65	11.73	12.38	50.00	-37.62	AVG

5.4 Radiated spurious emission

5.4.1 Limits

20dBc in any 100 kHz bandwidth outside the operating frequency band. In case the emission fall within the restricted band specified on 15.205(a), then the 15.209(a) limit in the table below has to be followed.

Frequency (MHz)	Field Strength (micovolts/meter)	Measurement Distance (meters)
0.009~0.490	2400/F(kHz)	300
0.490~1.705	24000/F(kHz)	30
1.705~30.0	30	30
30~88	100	3
88~216	150	3
216~960	200	3
Above 960	500	3

Spectrum Parameter	Setting
Attenuation	Auto
Start Frequency	1000 MHz
Stop Frequency	10th carrier harmonic
RB / VB (emission in restricted band)	1 MHz / 1 MHz for Peak, 1 MHz / 10Hz for Average

Receiver Parameter	Setting
Attenuation	Auto
Start ~ Stop Frequency	9kHz~150kHz / RB 200Hz for QP
Start ~ Stop Frequency	150kHz~30MHz / RB 9kHz for QP
Start ~ Stop Frequency	30MHz~1000MHz / RB 120kHz for QP

5.4.2 Test setup

Radiated emission test-up frequency below 30MHz

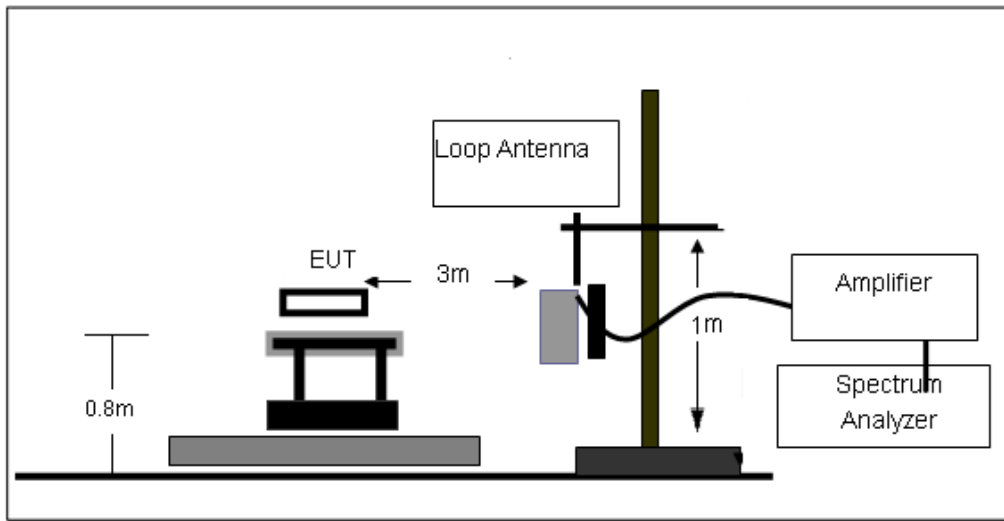

Radiated emission test-up frequency 30MHz~1GHz

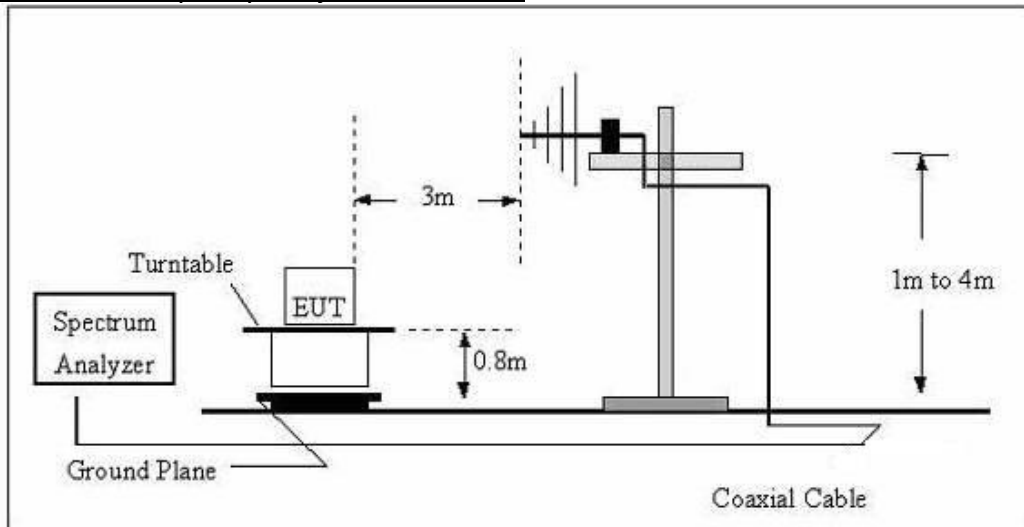

Radiated emission test-up frequency above 1GHz

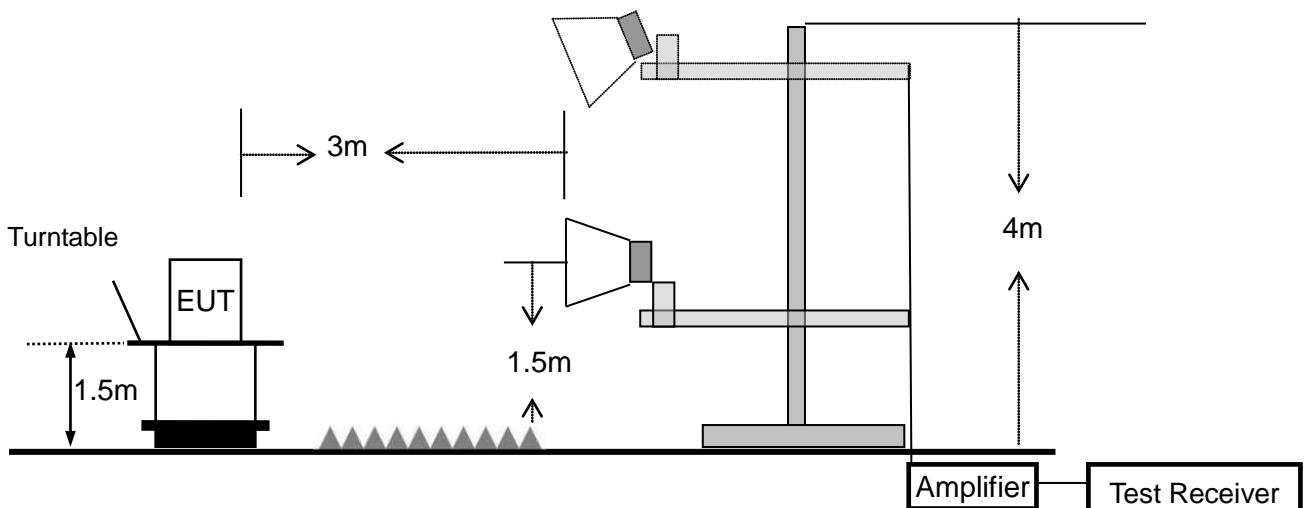

5.4.3 Test procedure

- a. EUT operating conditions. The EUT tested system was configured as the statements of 3.2 Unless otherwise a special operating condition is specified in the follows during the testing.
- b. The measuring distance of at 3 m shall be used for measurements at frequency up to 1GHz. For frequencies above 1GHz, any suitable measuring distance may be used.
- c. The EUT was placed on the top of a rotating table 0.8 meters above the ground at a 3 meter open area test site. The table was rotated 360 degrees to determine the position of the highest radiation.
- d. The height of the equipment or of the substitution antenna shall be 0.8 m; the height of the test antenna shall vary between 1 m to 4 m. Both horizontal and vertical polarizations of the antenna are set to make the measurement.
- e. For emission measurements above 1 GHz, the EUT shall be placed at a height of 1.5 m above the floor on a support that is RF transparent for the frequencies of interest. Final measurements for the EUT require a measurement antenna height scan of 1 m to 4 m.
- f. The initial step in collecting conducted emission data is a spectrum analyzer peak detector mode pre-scanning the measurement frequency range. Significant peaks are then marked and then Quasi Peak detector mode re-measured.
- g. If the Peak Mode measured value compliance with and lower than Quasi Peak Mode Limit, the EUT shall be deemed to meet QP Limits and then no additional QP Mode measurement performed.
- h. For the actual test configuration, please refer to the related Item –EUT Test photos.

Note: Both horizontal and vertical antenna polarities were tested. The worst case emissions were reported.

During the radiated emission test, the Spectrum Analyzer was set with the following configurations:

Frequency Band (MHz)	Function	Resolution bandwidth	Video Bandwidth
30 to 1000	QP	120 kHz	300 kHz
Above 1000	Peak	1 MHz	1 MHz
	Average	1 MHz	10 Hz

Note: for the frequency ranges below 30 MHz, a narrower RBW is used for these ranges but the measured value should add a RBW correction factor (RBWCF) where $RBWCF [dB] = 10 \cdot \lg(100 [kHz] / \text{narrower RBW [kHz]})$. , the narrower RBW is 1 kHz and RBWCF is 20 dB for the frequency 9 kHz to 150 kHz, and the narrower RBW is 10 kHz and RBWCF is 10 dB for the frequency 150 kHz to 30 MHz.

5.4.4 Test results
Below 30MHz

EUT:	Wireless Label Maker	Model Name:	P12 Pro
Pressure:	1010 hPa	Test Voltage:	DC 7.4V from battery
Test Mode:	Charging+TX	Polarization:	--

Freq.	Reading	Limit	Margin	State
(MHz)	(dBuV/m)	(dBuV/m)	(dB)	P/F
--	--	--	--	Pass
--	--	--	--	Pass

Note:

1. For 9kHz-30MHz, the amplitude of spurious emissions which are attenuated by more than 20dB below the permissible value has no need to be reported.
2. Distance extrapolation factor = $40 \log(\text{specific distance}/\text{test distance})$ (dB);
3. Limit line = specific limits (dBuV) + distance extrapolation factor.



Between 30MHz – 1GHz

EUT:	Wireless Label Maker	Model Name:	P12 Pro
Pressure:	1010 hPa	Phase:	H
Test Mode:	Charging+TX	Test Voltage:	DC 7.4V from battery

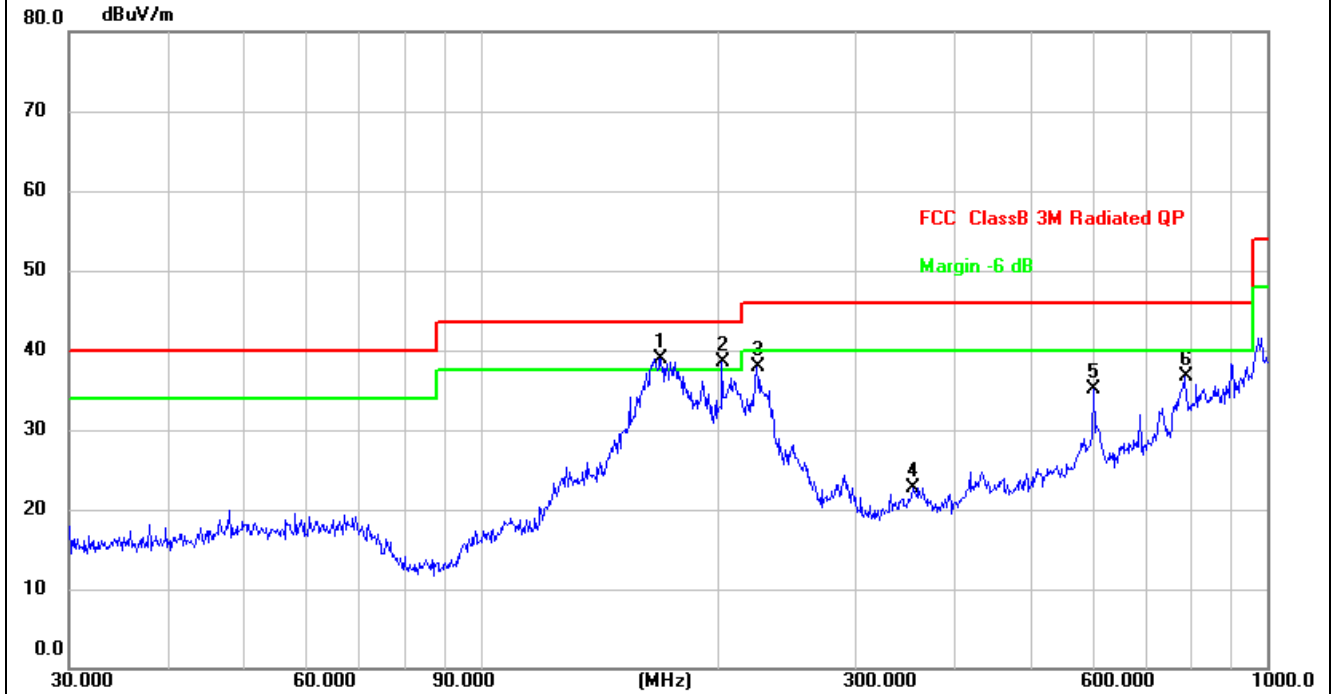

No.	Frequency (MHz)	Reading (dBuV)	Factor (dB/m)	Level (dBuV/m)	Limit (dBuV/m)	Margin (dB)	Detector
1 *	169.5990	54.87	-15.88	38.99	43.50	-4.51	QP
2 !	202.8104	51.28	-12.76	38.52	43.50	-4.98	QP
3	224.5193	50.50	-12.64	37.86	46.00	-8.14	QP
4	354.1831	31.41	-8.64	22.77	46.00	-23.23	QP
5	601.4265	38.72	-3.61	35.11	46.00	-10.89	QP
6	785.0935	38.61	-1.81	36.80	46.00	-9.20	QP

EUT:	Wireless Label Maker	Model Name:	P12 Pro
Pressure:	1010 hPa	Phase:	V
Test Mode:	Charging+TX	Test Voltage:	DC 7.4V from battery



No.	Frequency (MHz)	Reading (dBuV)	Factor (dB/m)	Level (dBuV/m)	Limit (dBuV/m)	Margin (dB)	Detector
1	40.2757	38.91	-13.30	25.61	40.00	-14.39	QP
2	58.8185	40.30	-12.36	27.94	40.00	-12.06	QP
3	137.4202	52.72	-17.31	35.41	43.50	-8.09	QP
4 *	173.8135	54.14	-15.70	38.44	43.50	-5.06	QP
5	601.4265	36.25	-0.23	36.02	46.00	-9.98	QP
6	782.3453	31.48	3.80	35.28	46.00	-10.72	QP

Note:

1. Emission Level = Meter Reading + Factor, Margin= Emission Level- Limit, Factor = Antenna Factor + Cable Loss – Pre-amplifier.
2. The three modulated high, medium and low channels have been tested. The report only shows the worst mode. The worst mode is $\pi/4$ -DQPSK CH00.

1GHz-25GHz

Frequency	Read Level	Correct Factor	Emission Level	Limits	Margin	Remark	Comment
(MHz)	(dBμV)	(dB)	(dBμV/m)	(dBμV/m)	(dB)		
Low Channel (2402 MHz)(π/4-DQPSK)--Above 1G							
4804.000	49.48	1.52	51.00	74.00	-23.00	Pk	Vertical
4804.000	40.41	1.52	41.93	54.00	-12.07	AV	Vertical
7206.000	40.08	5.46	45.54	74.00	-28.46	Pk	Vertical
7206.000	36.38	5.46	41.84	54.00	-12.16	AV	Vertical
4804.000	48.26	1.52	49.78	74.00	-24.22	Pk	Horizontal
4804.000	40.14	1.52	41.66	54.00	-12.34	AV	Horizontal
7206.000	39.21	5.46	44.67	74.00	-29.33	Pk	Horizontal
7206.000	37.91	5.46	43.37	54.00	-10.63	AV	Horizontal
Mid Channel (2441 MHz)(π/4-DQPSK)--Above 1G							
4882.000	50.61	1.68	52.29	74.00	-21.71	Pk	Vertical
4882.000	46.55	1.68	48.23	54.00	-5.77	AV	Vertical
7323.000	44.68	5.45	50.13	74.00	-23.87	Pk	Vertical
7323.000	38.21	5.45	43.66	54.00	-10.34	AV	Vertical
4882.000	49.19	1.68	50.87	74.00	-23.13	Pk	Horizontal
4882.000	43.43	1.68	45.11	54.00	-8.89	AV	Horizontal
7323.000	43.00	5.45	48.45	74.00	-25.55	Pk	Horizontal
7323.000	36.70	5.45	42.15	54.00	-11.85	AV	Horizontal
High Channel (2480 MHz)(π/4-DQPSK)-- Above 1G							
4960.000	47.02	1.83	48.85	74.00	-25.15	Pk	Vertical
4960.000	40.87	1.83	42.70	54.00	-11.30	AV	Vertical
7440.000	44.83	5.43	50.26	74.00	-23.74	Pk	Vertical
7440.000	37.08	5.43	42.51	54.00	-11.49	AV	Vertical
4960.000	46.66	1.83	48.49	74.00	-25.51	Pk	Horizontal
4960.000	42.27	1.83	44.10	54.00	-9.90	AV	Horizontal
7440.000	42.21	5.43	47.64	74.00	-26.36	Pk	Horizontal
7440.000	37.98	5.43	43.41	54.00	-10.59	AV	Horizontal

Note:

1. All Readings are Peak Value (VBW=3MHz) and AV Value (VBW=10Hz).
2. Correct Factor= Antenna Factor + Cable Loss - Preamp Factor
3. Emission Level= Correct Factor + Read Level
4. All the modulation modes have been tested, and only the worst results are reflected in the report.
The worst mode is π/4-DQPSK

5.4.5 Band edge – radiated

Frequency	Read Level	Correct Factor	Emission Level	Limits	Margin	Remark	Comment
(MHz)	(dB μ V)	(dB)	(dB μ V/m)	(dB μ V/m)	(dB)		
2Mbps(π /4-DQPSK) - hopping							
2310.000	44.37	-6.60	37.77	74.00	-36.23	Pk	Horizontal
2310.000	32.24	-6.60	25.64	54.00	-28.36	AV	Horizontal
2310.000	43.90	-6.60	37.30	74.00	-36.70	Pk	Vertical
2310.000	32.33	-6.60	25.73	54.00	-28.27	AV	Vertical
2390.000	51.13	-6.23	44.90	74.00	-29.10	Pk	Horizontal
2390.000	41.89	-6.23	35.66	54.00	-18.34	AV	Horizontal
2390.000	50.93	-6.23	44.70	74.00	-29.30	Pk	Vertical
2390.000	42.13	-6.23	35.90	54.00	-18.10	AV	Vertical
2400.000	64.62	-6.18	58.44	74.00	-15.56	Pk	Horizontal
2400.000	49.01	-6.18	43.28	54.00	-10.72	AV	Horizontal
2400.000	60.05	-6.18	53.87	74.00	-20.13	Pk	Vertical
2400.000	52.04	-6.18	45.86	54.00	-8.14	AV	Vertical
2483.500	61.44	-5.79	55.65	74.00	-18.35	Pk	Horizontal
2483.500	54.63	-5.79	48.84	54.00	-5.16	AV	Horizontal
2483.500	62.67	-5.79	56.88	74.00	-17.12	Pk	Vertical
2483.500	55.82	-5.79	50.03	54.00	-3.97	AV	Vertical
2500.000	51.34	-5.72	45.62	74.00	-28.38	Pk	Horizontal
2500.000	41.96	-5.72	36.24	54.00	-17.76	AV	Horizontal
2500.000	52.04	-5.72	46.32	74.00	-27.68	Pk	Vertical
2500.000	42.77	-5.72	37.05	54.00	-16.95	AV	Vertical

Note:

5. All Readings are Peak Value (VBW=3MHz) and AV Value (VBW=10Hz).
6. Correct Factor= Antenna Factor + Cable Loss - Preamp Factor
7. Emission Level= Correct Factor + Read Level
8. All the modulation modes have been tested, and only the worst results are reflected in the report.
The worst mode is π /4-DQPSK

5.5 20dB occupied channel bandwidth

5.5.1 Limit

FCC Part15 (15.247) , Subpart C			
Section	Test Item	Limit	Frequency Range (MHz)
15.247a(1)	20dB bandwidth	N/A	2400-2483.5

5.5.2 Test setup

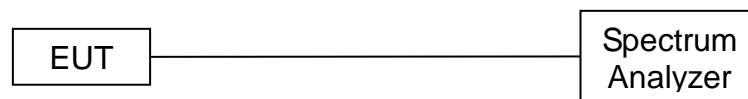

5.5.3 Test procedure

(1) The EUT was directly connected to the spectrum analyzer and antenna output port as show in the block diagram above.

(2) Spectrum Setting:

Bandwidth: RBW=30 kHz, VBW=100 kHz, detector= Peak

5.5.4 Test results



Test data

EUT:	Wireless Label Maker	Model Name:	P12 Pro
Pressure:	1012 hPa	Test Voltage:	DC 7.4V from battery

Mode	Frequency (MHz)	20dB Bandwidth (MHz)	Limit (kHz)	Result
GFSK	2402	0.9582	N/A	Pass
	2441	0.9503	N/A	Pass
	2480	0.9588	N/A	Pass
$\pi/4$ -DQPSK	2402	1.3130	N/A	Pass
	2441	1.3200	N/A	Pass
	2480	1.3180	N/A	Pass



Test plots

GFSK mode



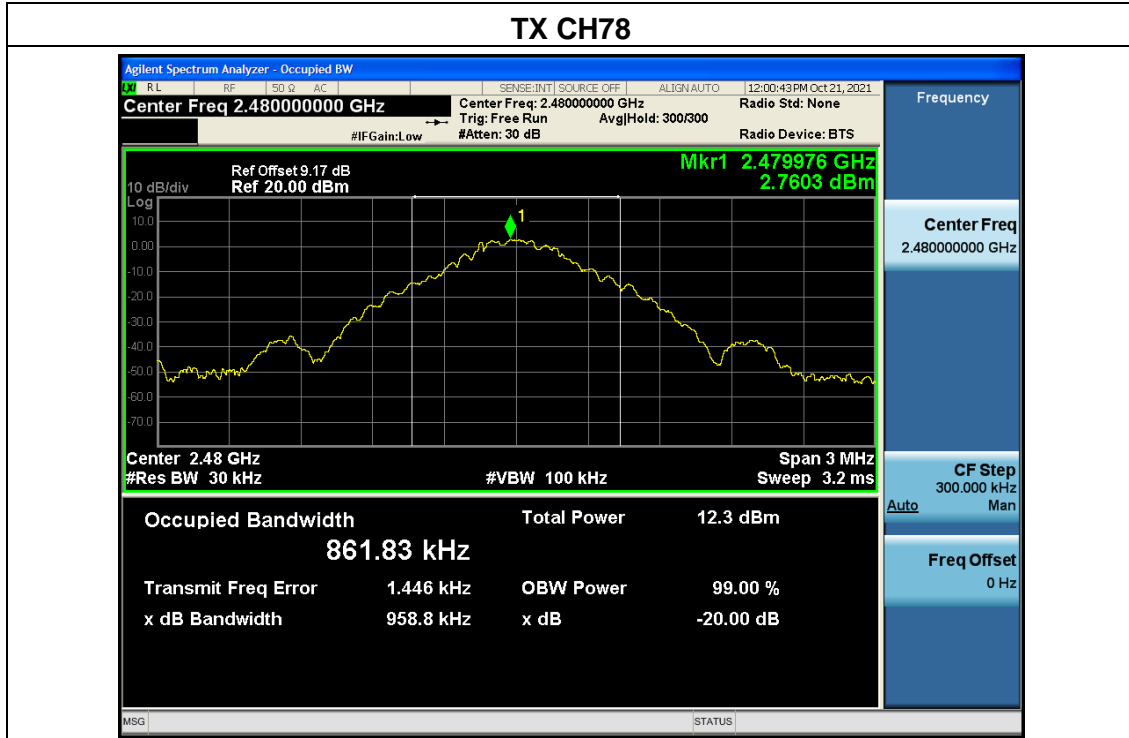

$\pi/4$ -DQPSK

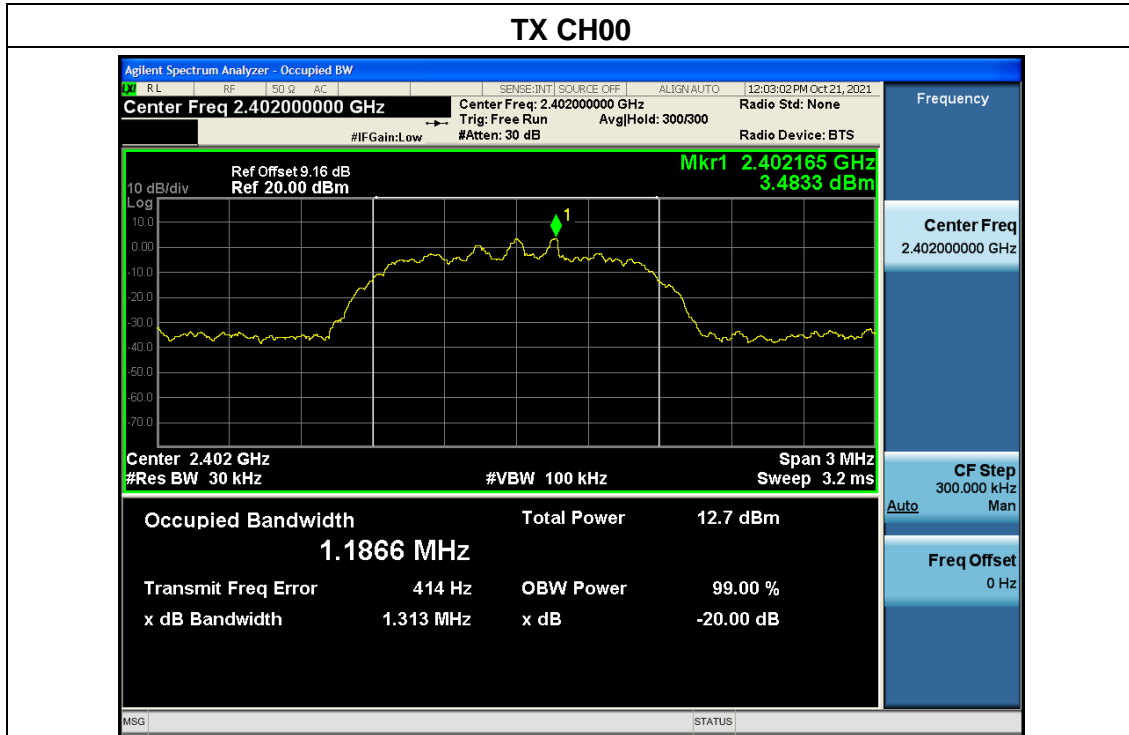



5.6 Carrier frequency separation

5.6.1 Limit

FCC Part15 (15.247) , Subpart C			
Section	Test Item	Limit	Frequency Range (MHz)
15.247(a)(1)	Channel Separation	>25kHz or >two-thirds of the 20 dB bandwidth (Which is greater)	2400-2483.5

5.6.2 Test setup

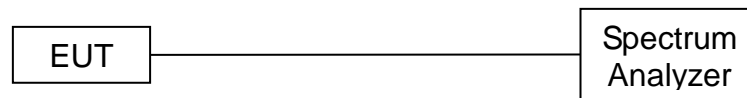

5.6.3 Test procedure

- (1) The EUT was directly connected to the spectrum analyzer and antenna output port as show in the block diagram above.
- (2) Spectrum Setting:
RBW=30 kHz, VBW=100 kHz, detector= Peak, Sweep Time =auto.
- (3) The EUT was set to the Hopping Mode for Channel Separation Test and continuously transmitting for the Test.

5.6.4 Test results

Test data

EUT:	Wireless Label Maker	Model Name:	P12 Pro
Pressure:	1012 hPa	Test Voltage:	DC 7.4V from battery
Test Mode:	GFSK, $\pi/4$ -DQPSK /CH00, CH39, CH78		

Mode	Channel	Frequency (MHz)	Test Result (kHz)	Limit (kHz)		Result
GFSK	Low	2402	1002	638.800	2/3 of 20dB BW	Pass
	Middle	2441	1002	633.533	2/3 of 20dB BW	Pass
	High	2480	1000	639.200	2/3 of 20dB BW	Pass
$\pi/4$ -DQPSK	Low	2402	1002	875.333	2/3 of 20dB BW	Pass
	Middle	2441	998	880.000	2/3 of 20dB BW	Pass
	High	2480	1004	878.667	2/3 of 20dB BW	Pass

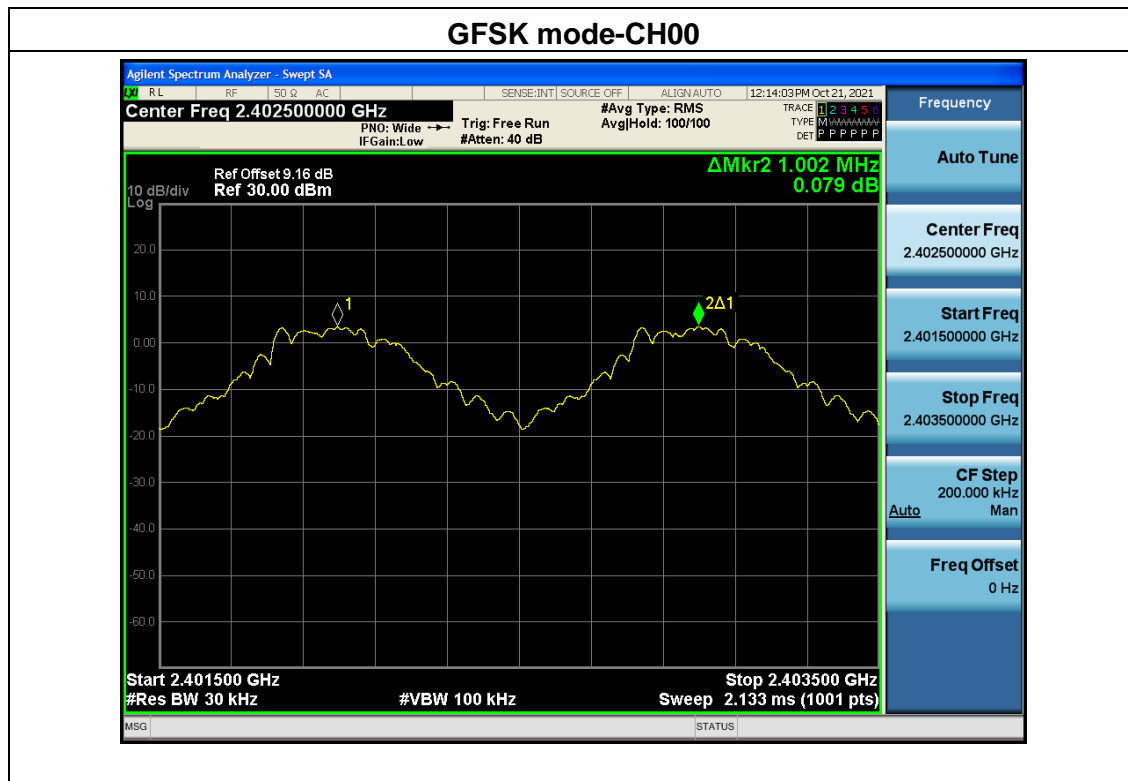
Test plots



GFSK mode-CH39



GFSK mode-CH78

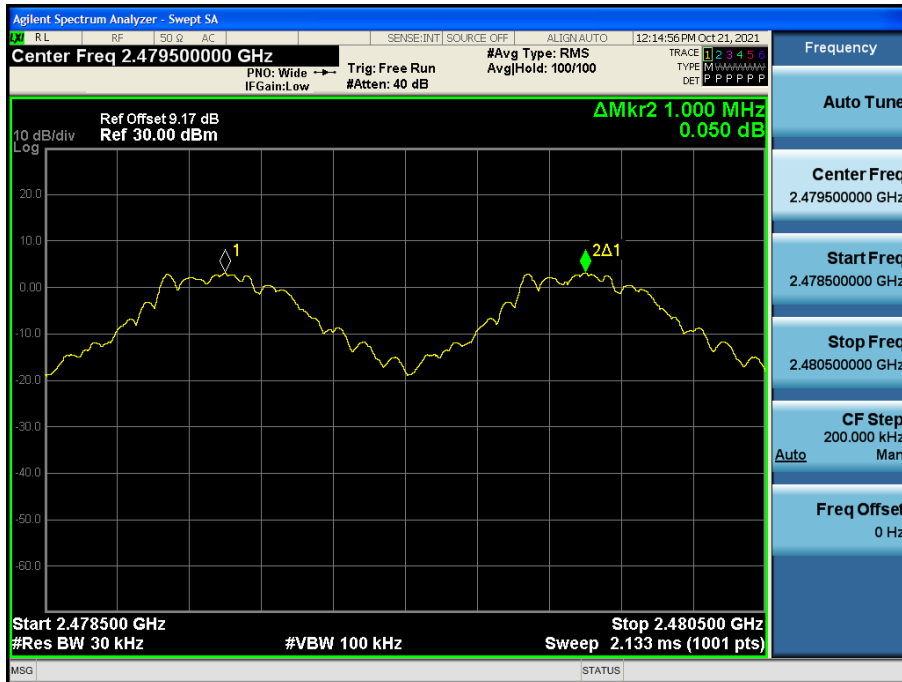



$\pi/4$ -DQPSK mode-CH00

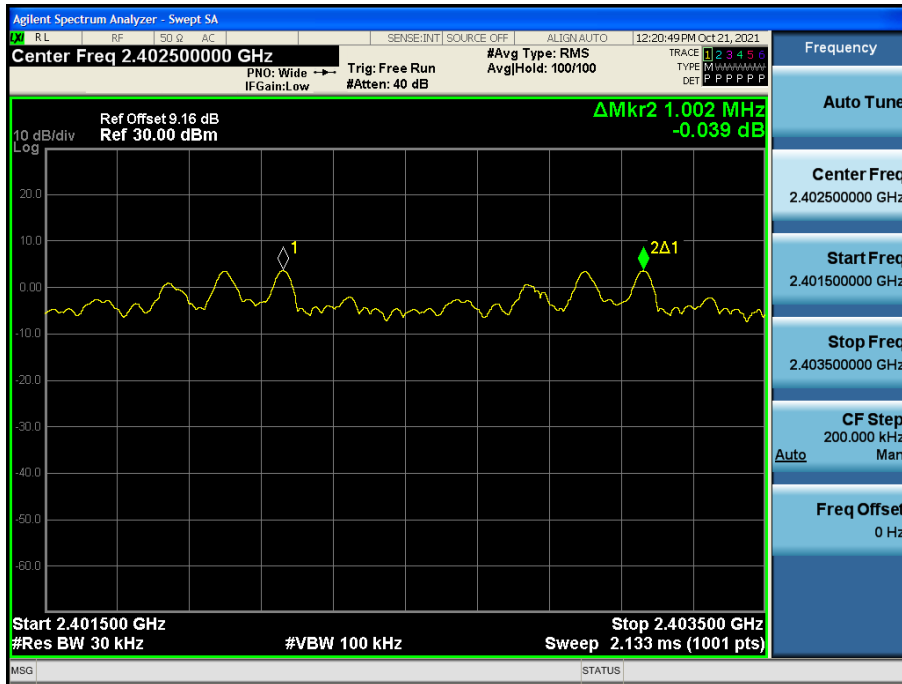

$\pi/4$ -DQPSK mode-CH39

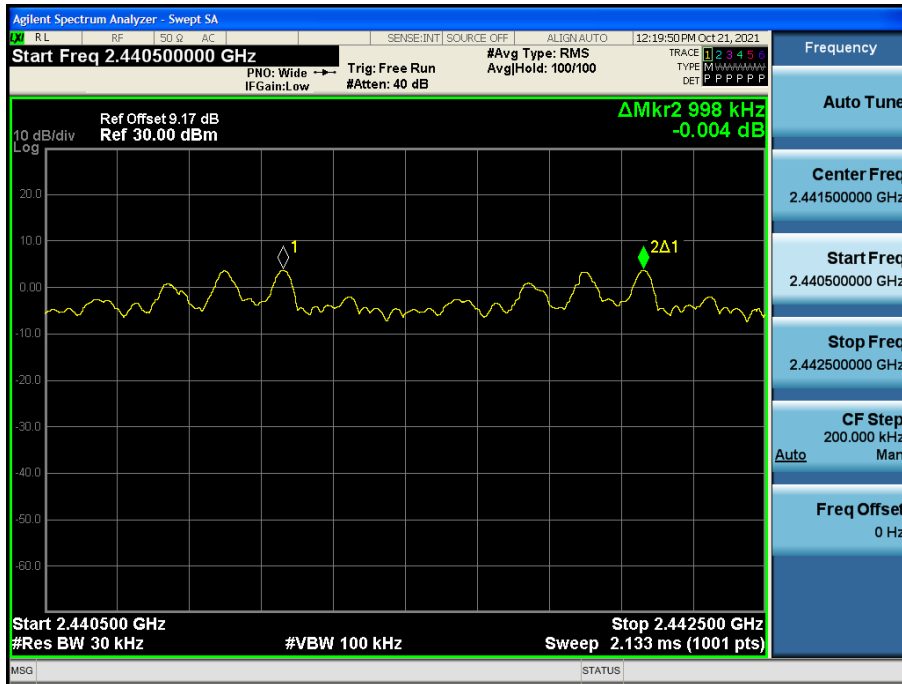

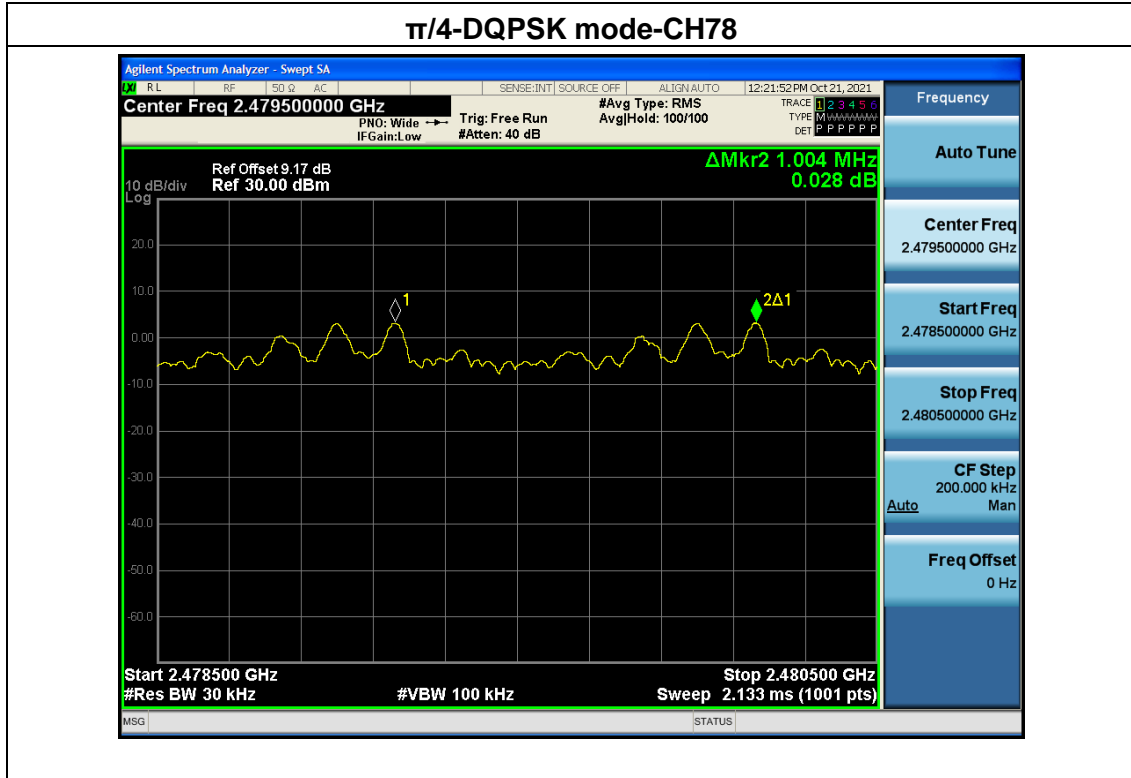

5.7 Hopping Channel

5.7.1 Limit

Frequency hopping systems in the 2400-2483.5MHz band shall use at least 15 channels.

5.7.2 Test setup

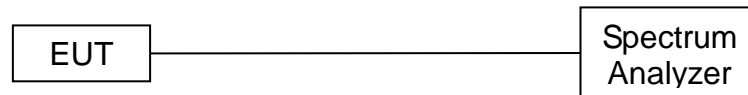

5.7.3 Test procedure

The testing follows ANSI C63.10-2013 clause 7.8.3

The RF output of EUT was connected to the spectrum analyzer by RF cable and attenuator.

The path loss was compensated to the results for each measurement.

Set to the maximum power setting and enable the EUT transmit continuously.

The EUT must have its hopping function enabled.

Use the following spectrum analyzer settings:

Span = the frequency band of operation

RBW : To identify clearly the individual channels, set the RBW to less than 30% of the channel spacing or the 20 dB bandwidth, whichever is smaller.

VBW \geq RBW

Sweep = auto

Detector function = peak

Trace = max hold

5.7.4 Test results



Mode	Quantity of Hopping Channel	Limit	Results
GFSK, $\pi/4$ -DQPSK	79	>15	Pass

Test plots

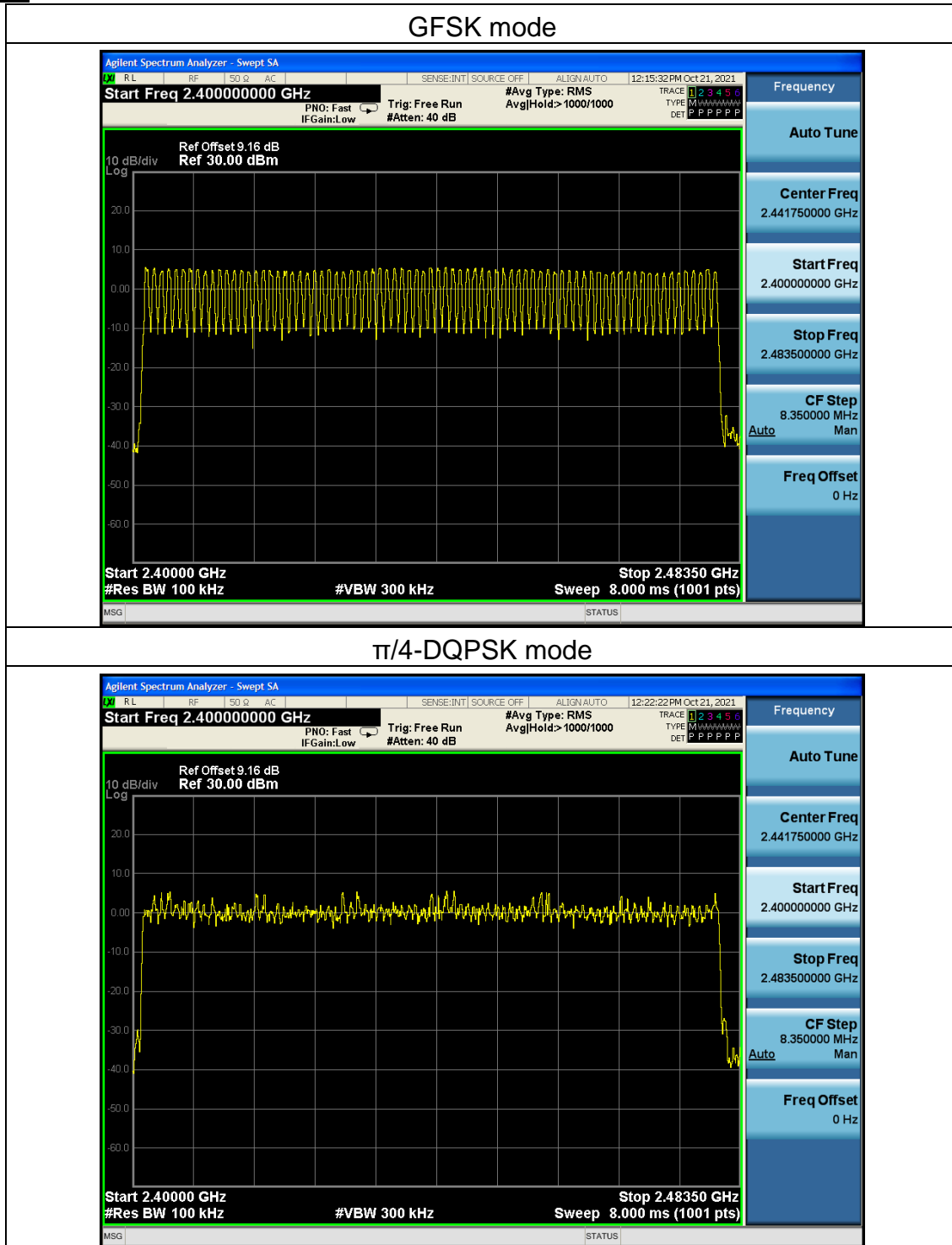

5.8 Dwell time

5.8.1 Limit

FCC Part15 (15.247) , Subpart C			
Section	Test Item	Limit	Frequency Range (MHz)
15.247(a)(1)	Dwell time	0.4 sec	2400-2483.5

5.8.2 Test setup

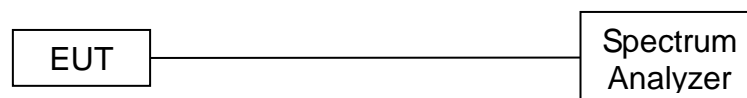

5.8.3 Test procedure

- (1) The EUT was directly connected to the spectrum analyzer and antenna output port as show in the block diagram above.
- (2) Spectrum Setting: RBW=1MHz, VBW=3MHz, Span=0Hz, Detector=Peak
- (3) Use video trigger with the trigger level set to enable triggering only on full pulses.
- (4) Sweep Time is more than once pulse time.
- (5) Set the center frequency on any frequency would be measure and set the frequency span to zero span.
- (6) Measure the maximum time duration of one single pulse.
- (7) Set the EUT for packet transmitting.
- (8) Measure the maximum time duration of one single pulse.
- (9) The EUT was set to the Hopping Mode for Dwell Time Test.

5.8.4 Test results



Test data

EUT:	Wireless Label Maker	Model Name:	P12 Pro
Pressure:	1012 hPa	Test Voltage:	DC 7.4V from battery
Test Mode:	GFSK, $\pi/4$ -DQPSK /CH39		

Mode	Data Packet	Frequency (MHz)	Pulse Duration (ms)	Dwell Time (ms)	Limit(s)	Conclusion
GFSK	DH1	2441	0.3737	119.58	<0.4	Pass
	DH3	2441	1.6300	260.80	<0.4	Pass
	DH5	2441	2.8770	306.88	<0.4	Pass
$\pi/4$ DQPSK	2DH1	2441	0.3876	124.03	<0.4	Pass
	2DH3	2441	1.6370	261.92	<0.4	Pass
	2DH5	2441	2.8830	307.52	<0.4	Pass

Note:

1. A period time = 0.4 (s) * 79 = 31.6(s)

2. DH1 time slot = Pulse Duration * (1600/(2*79)) * A period time

DH3 time slot = Pulse Duration * (1600/(4*79)) * A period time

DH5 time slot = Pulse Duration * (1600/(6*79)) * A period time

3. For GFSK and $\pi/4$ -DQPSK: The test period: T = 0.4 Second/Channel x 79 Channel = 31.6 s



Test plots

Modulation mode		GFSK mode	
DH1			
DH3			

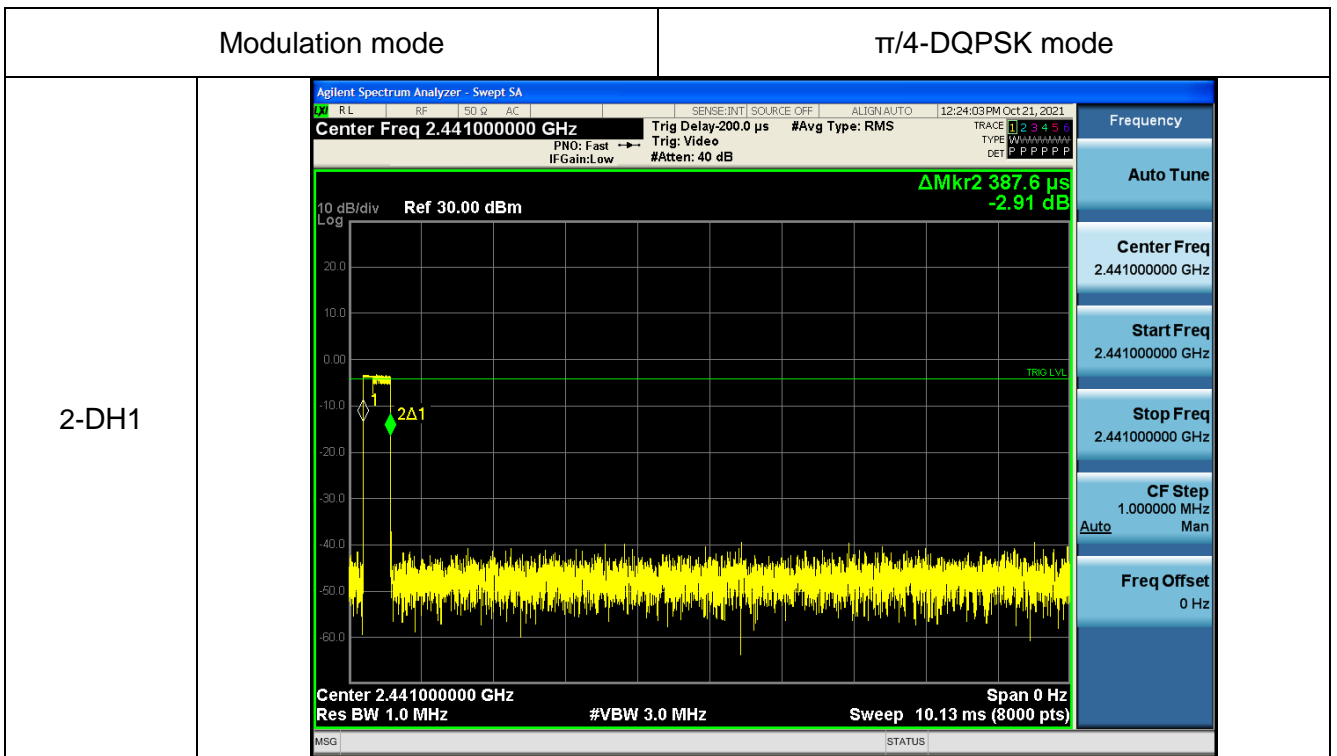
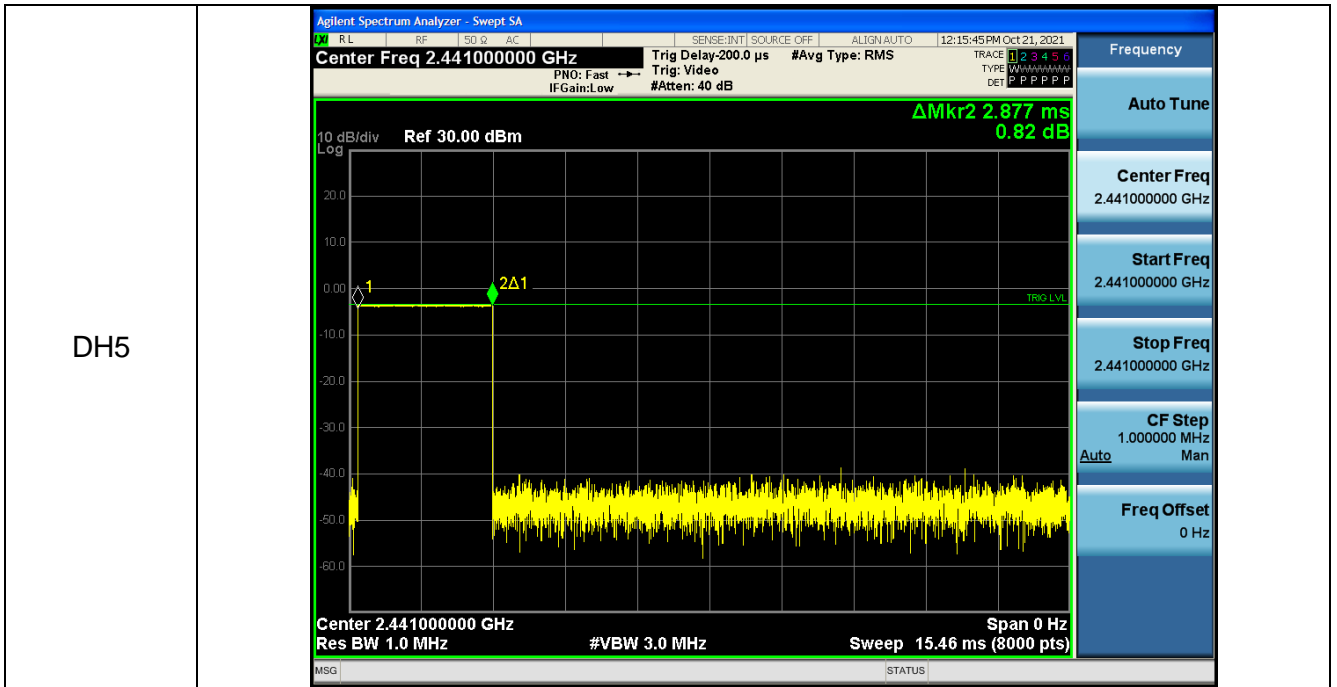

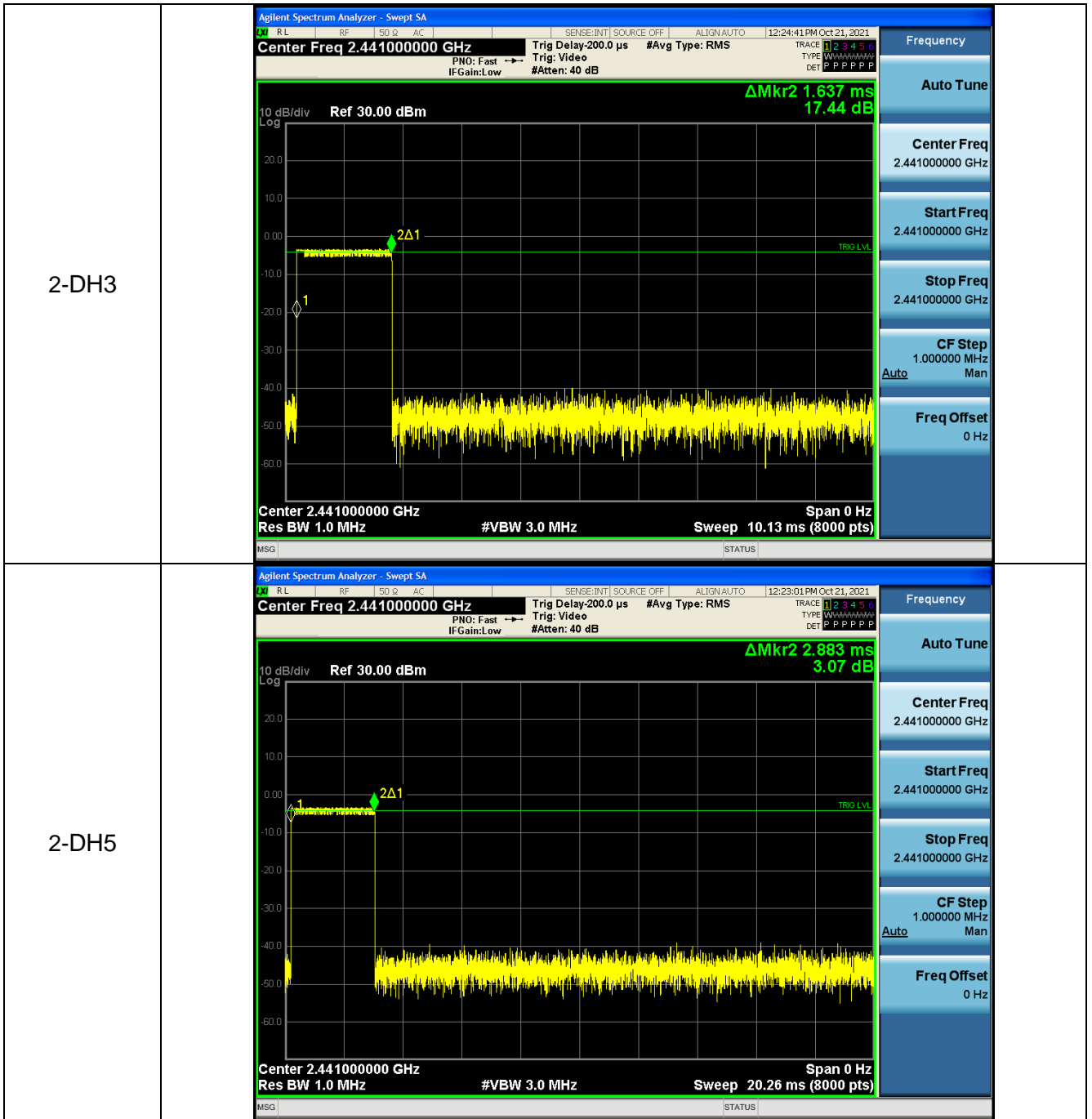

5.9 Conducted band edge

5.9.1 Limit

In any 100 kHz bandwidth outside the frequency band in which the spread spectrum or digitally modulated intentional radiator is operating, the radio frequency power that is produced by the intentional radiator shall be at least 20 dB below that in the 100 kHz bandwidth within the band that contains the highest level of the desired power, based on either an RF conducted or a radiated measurement, provided the transmitter demonstrates compliance with the peak conducted power limits. If the transmitter complies with the conducted power limits based on the use of RMS averaging over a time interval, as permitted under paragraph (b)(3) of this section, the attenuation required under this paragraph shall be 30 dB instead of 20 dB. Attenuation below the general limits specified in §15.209(a) is not required. In addition, radiated emissions which fall in the restricted bands, as defined in §15.205(a), must also comply with the radiated emission limits specified in §15.209(a) (see §15.205(c)).

5.9.2 Test setup

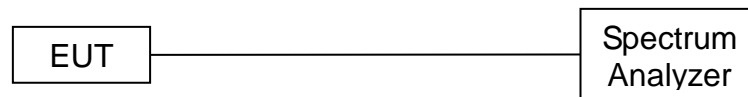

5.9.3 Test procedure

- a) Check the calibration of the measuring instrument using either an internal calibrator or a known signal from an external generator.
- b) Position the EUT without connection to measurement instrument. Turn on the EUT and connect its antenna terminal to measurement instrument via a low loss cable. Then set it to any one measured frequency within its operating range, and make sure the instrument is operated in its linear range.
- c) Set RBW to 100 kHz and VBW of spectrum analyzer to 300 kHz with a convenient frequency span including 100 kHz bandwidth from band edge.
- d) Measure the highest amplitude appearing on spectral display and set it as a reference level. Plot the graph with marking the highest point and edge frequency.
- e) Repeat above procedures until all measured frequencies were complete.

5.9.4 Test results



Test data

EUT:	Wireless Label Maker	Model Name:	P12 Pro
Pressure:	1012 hPa	Test Voltage:	DC 7.4V from battery

Test plots

GFSK: Band Edge, Left Side

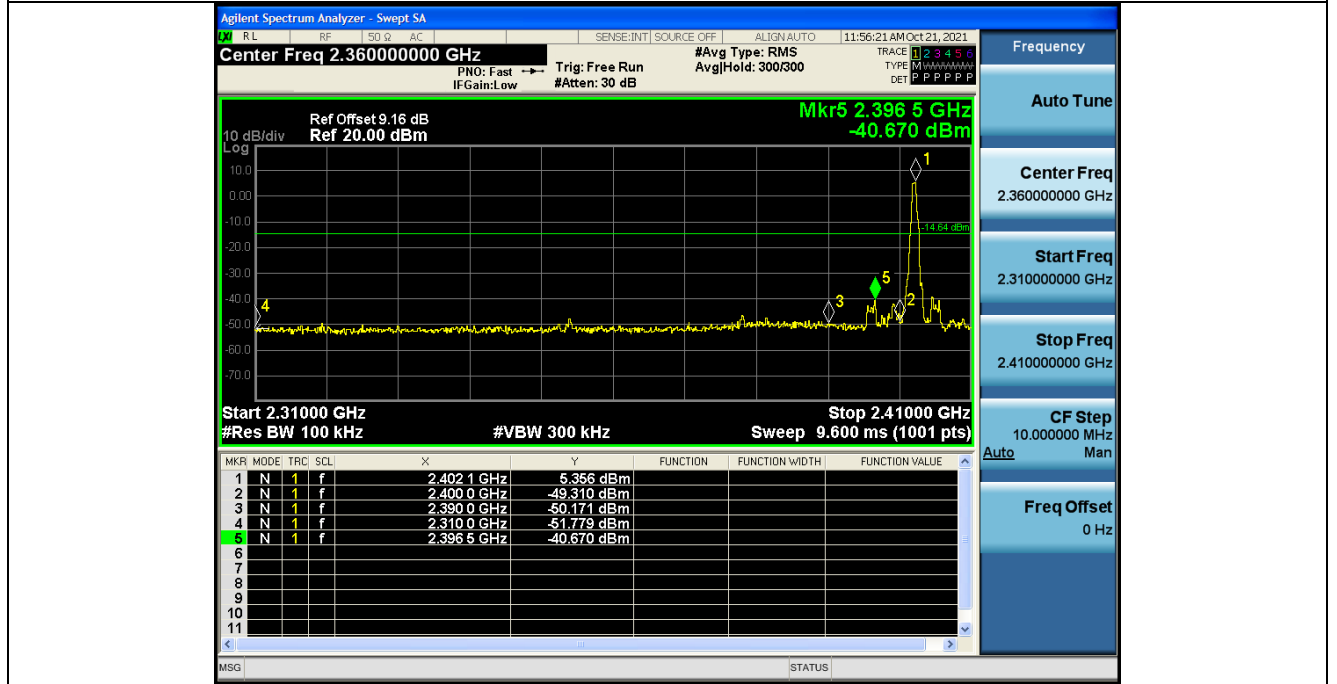

GFSK: Band Edge, Right Side

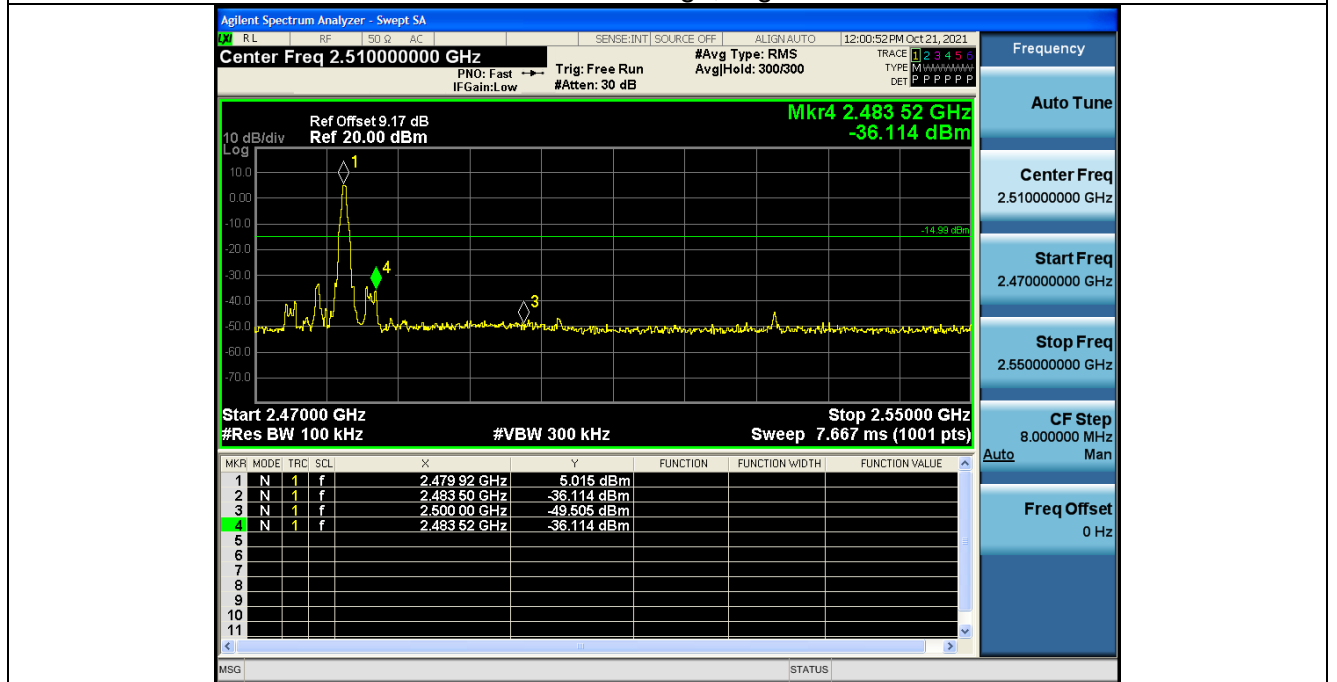



$\pi/4$ -DQPSK: Band Edge, Left Side

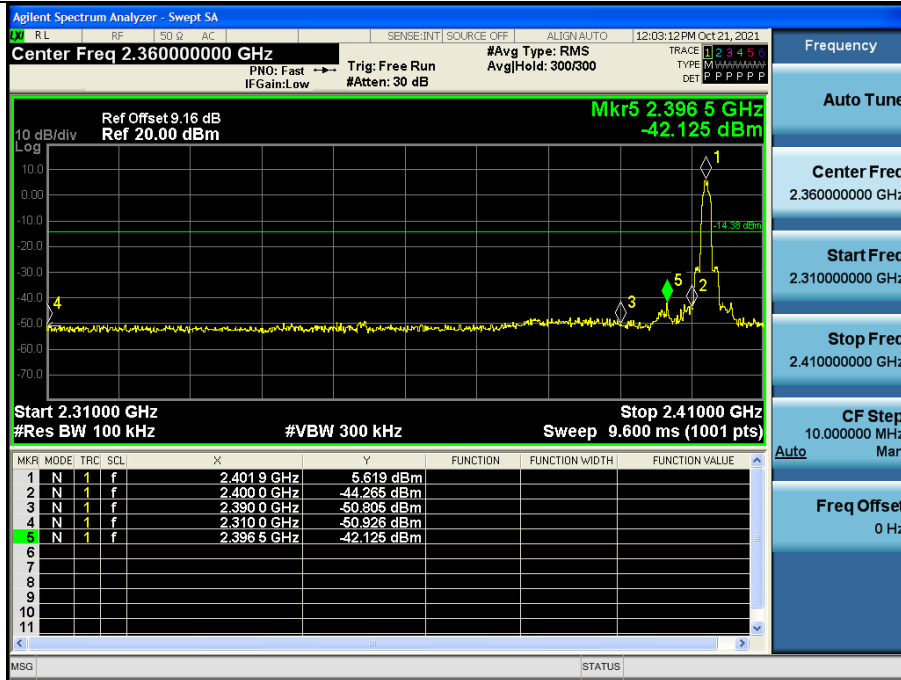

$\pi/4$ -DQPSK: Band Edge, Right Side

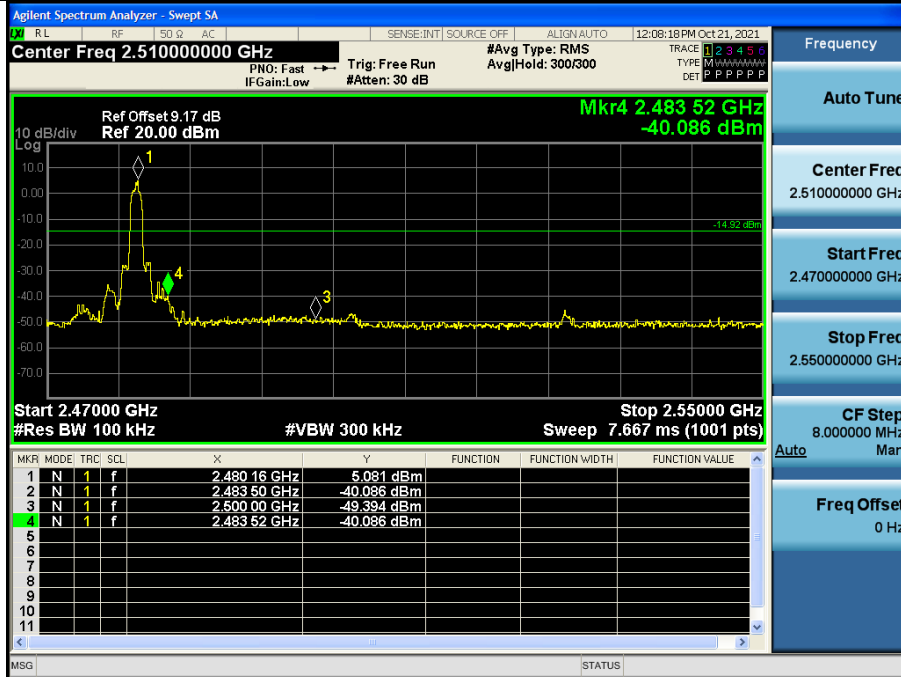



Hopping Mode
Test plots

GFSK: Band Edge, Left Side

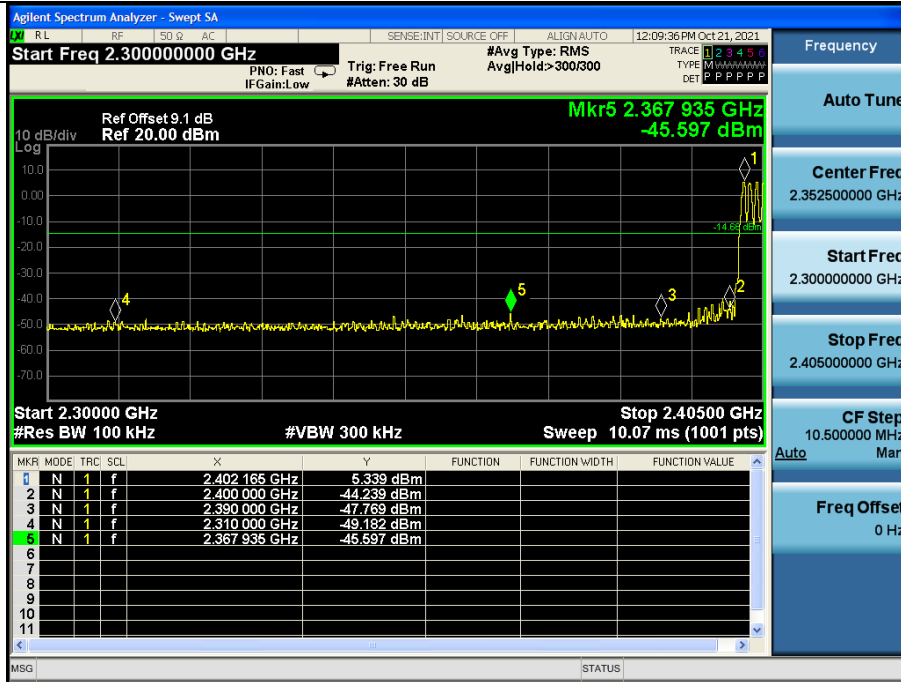

GFSK: Band Edge, Right Side

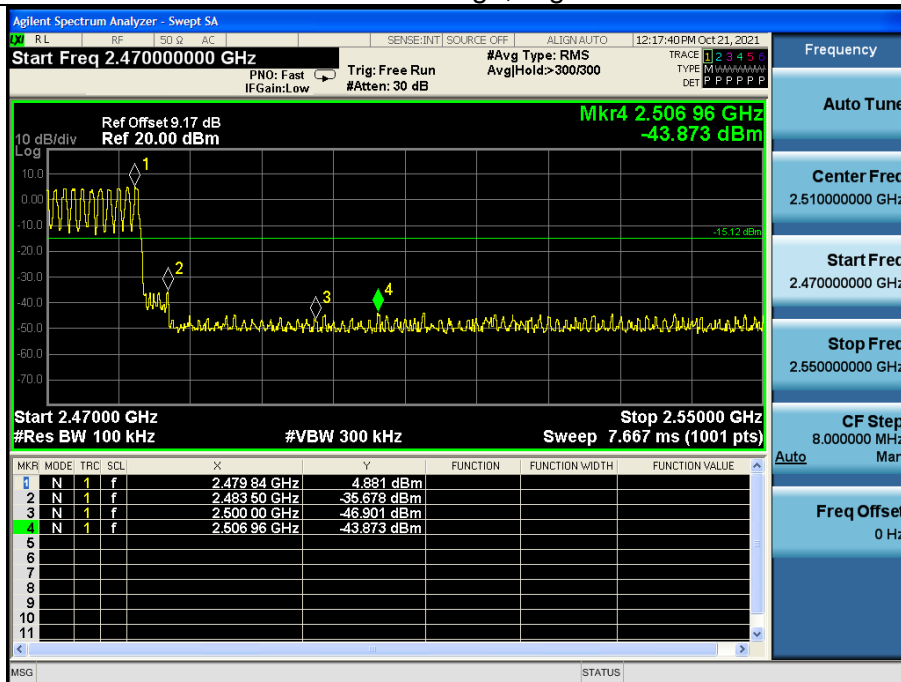



$\pi/4$ -DQPSK: Band Edge, Left Side

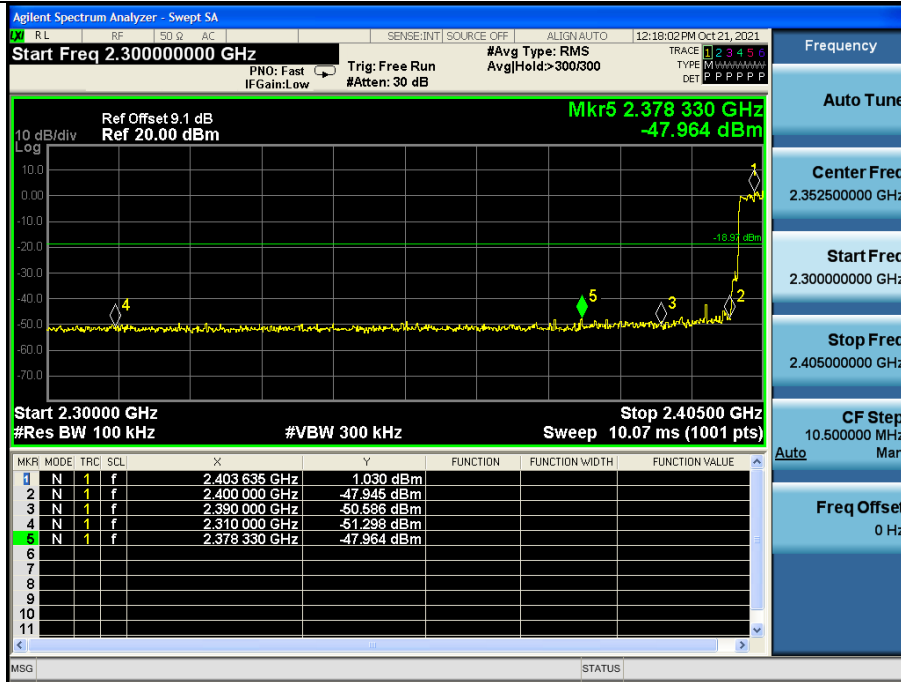

$\pi/4$ -DQPSK Band Edge, Right Side

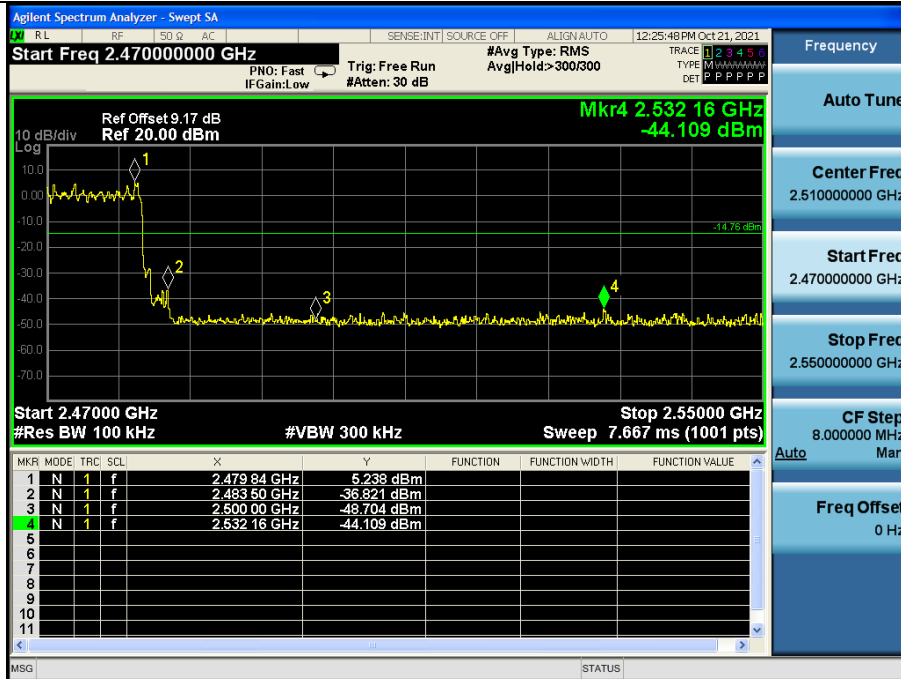

5.10 Spurious RF Conducted Emissions

5.10.1 Limit

Below -20dB of the highest emission level in operating band.

5.10.2 Measuring instruments

The Measuring equipment is listed in the section 4 of this test report.

5.10.3 Test setup

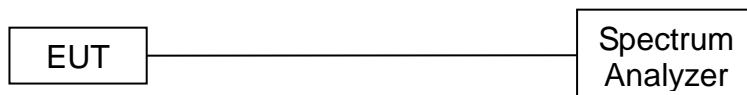

5.10.4 Test procedure

The Spurious RF conducted emissions compliance of RF radiated emission should be measured by following the guidance in ANSI C63.10-2013 with respect to maximizing the emission by rotating the EUT, measuring the emission while the EUT is situated in three orthogonal planes (if appropriate), adjusting the measurement antenna height and polarization etc. Set RBW=100kHz and VBW= 300kHz to measure the peak field strength, and measure frequency range from 9kHz to 26.5GHz.

5.10.5 Test results

Note:

- 1: The measurement frequency range is from 9kHz to the 10th harmonic of the fundamental frequency. The lowest, middle and highest channels are tested to verify the spurious emissions and band edge measurement data.
- 2: The worst mode is $\pi/4$ -DQPSK mode, and the report only show the worst mode data.



$\pi/4$ -DQPSK on Channel 00

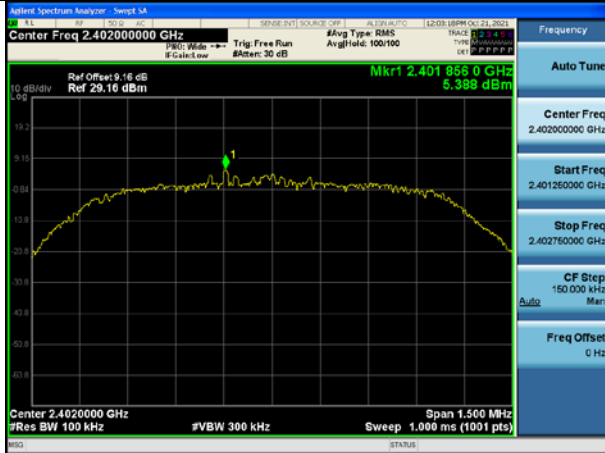

$\pi/4$ -DQPSK on Channel 00

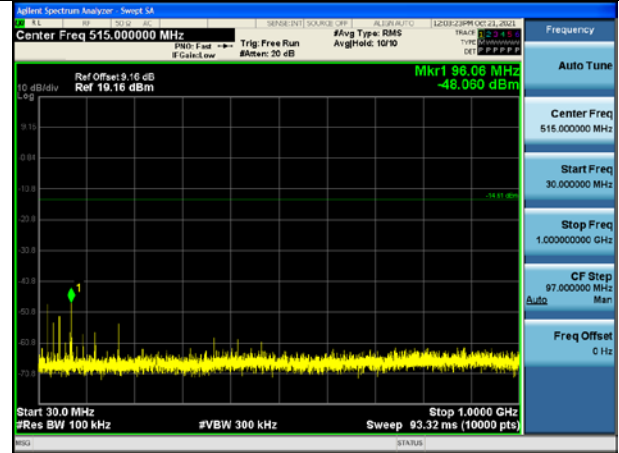

$\pi/4$ -DQPSK on Channel 00

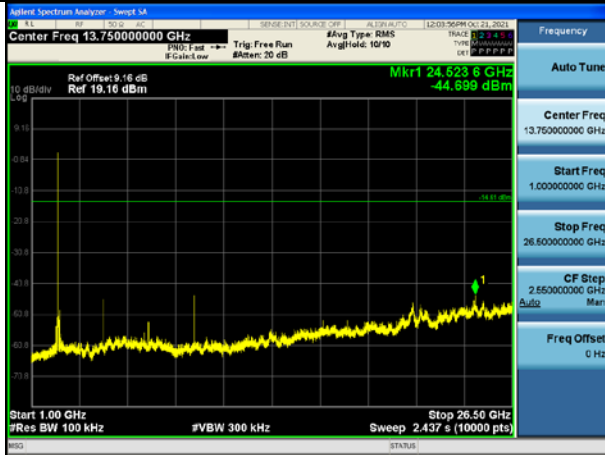

$\pi/4$ -DQPSK on Channel 39

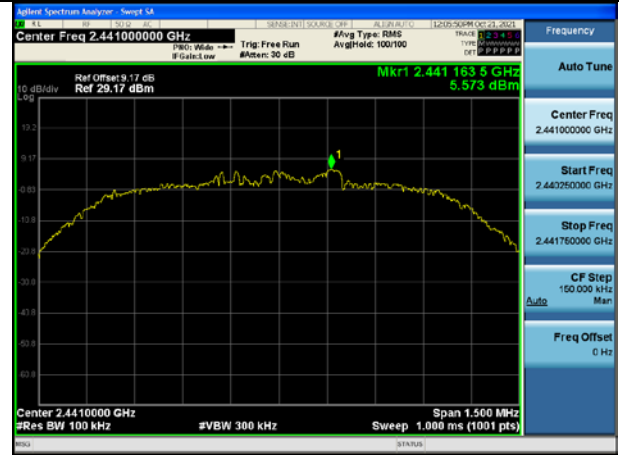

$\pi/4$ -DQPSK on Channel 39

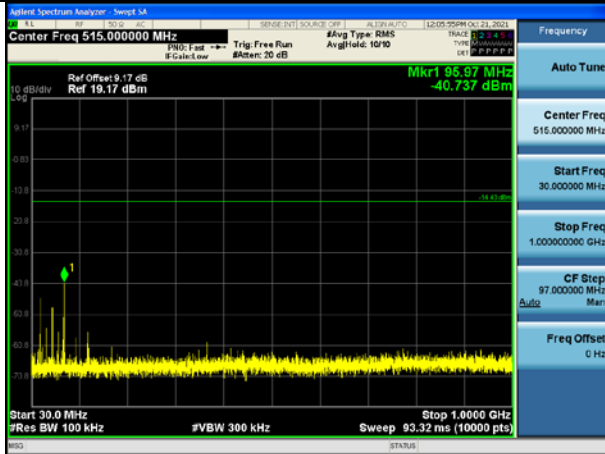

$\pi/4$ -DQPSK on Channel 39

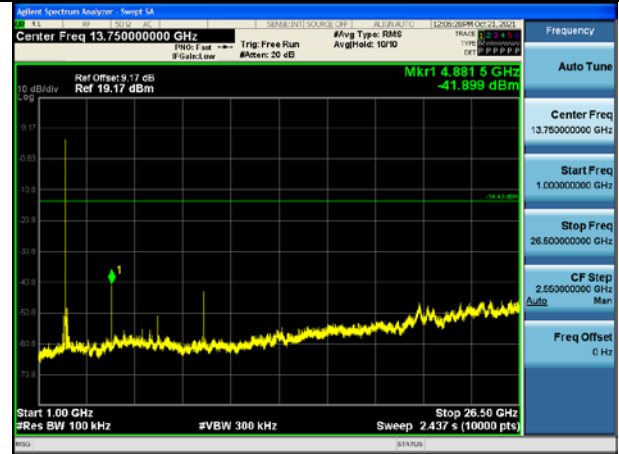



$\pi/4$ -DQPSK on Channel 78



$\pi/4$ -DQPSK on Channel 78

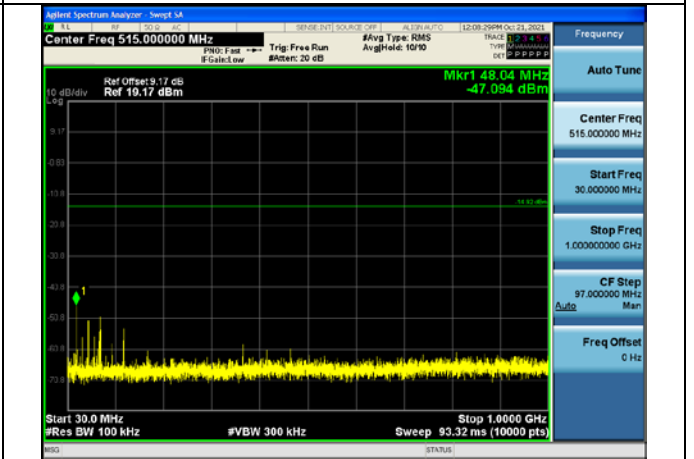

$\pi/4$ -DQPSK on Channel 78

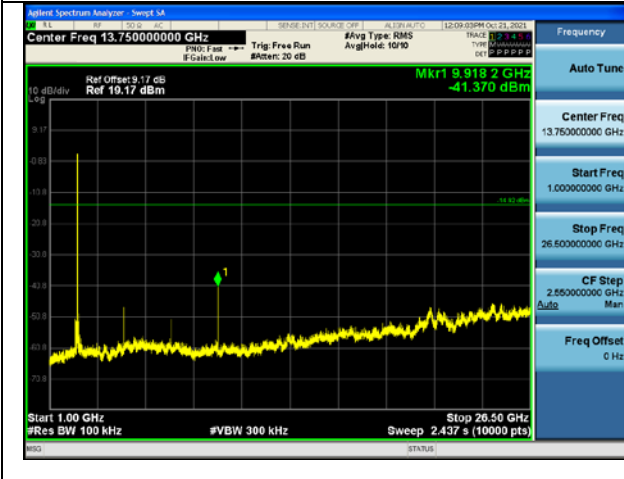

Photographs of the Test Setup

Radiated emission





Conducted emission





Photographs of the EUT

See the APPENDIX 1- EUT PHOTO.

----END OF REPORT----