

						标识	版本号	处数	修改内容	日期
						1				
						2				
						3				
A										
B										
C										
D										
E										
F										

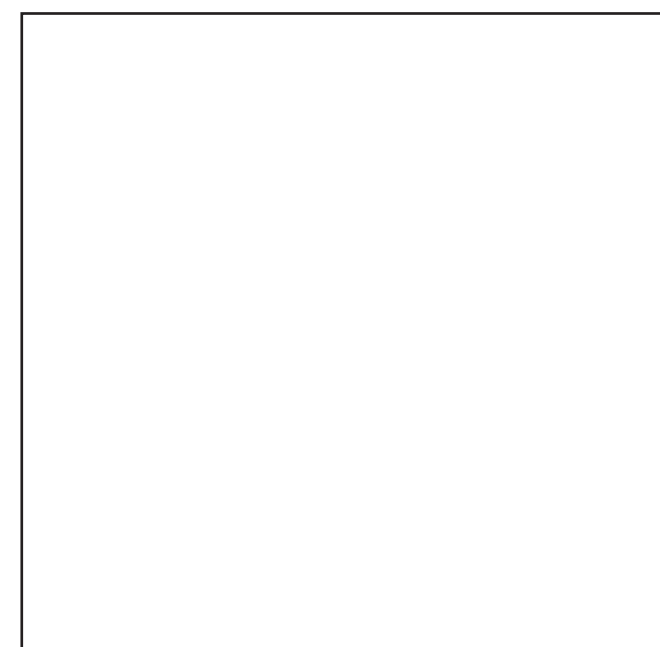
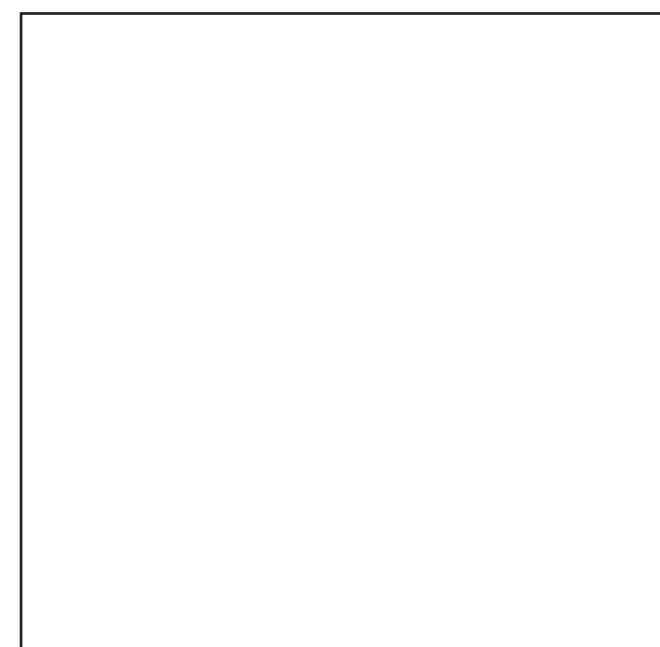
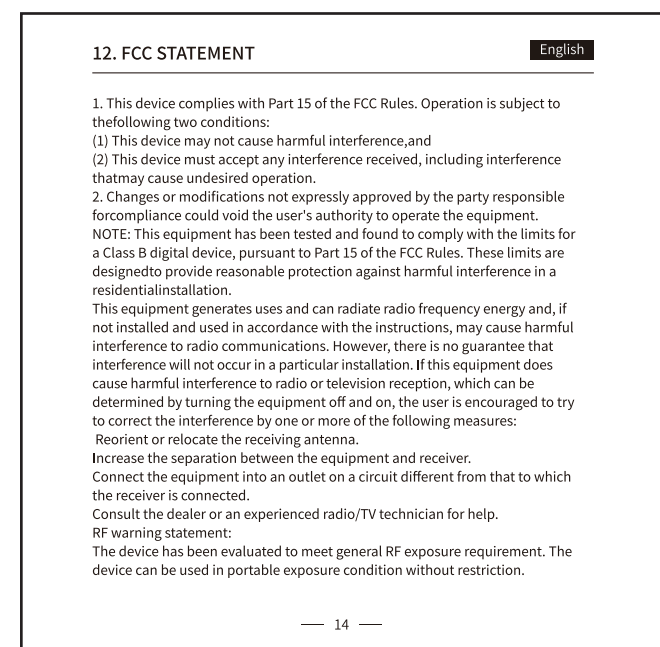
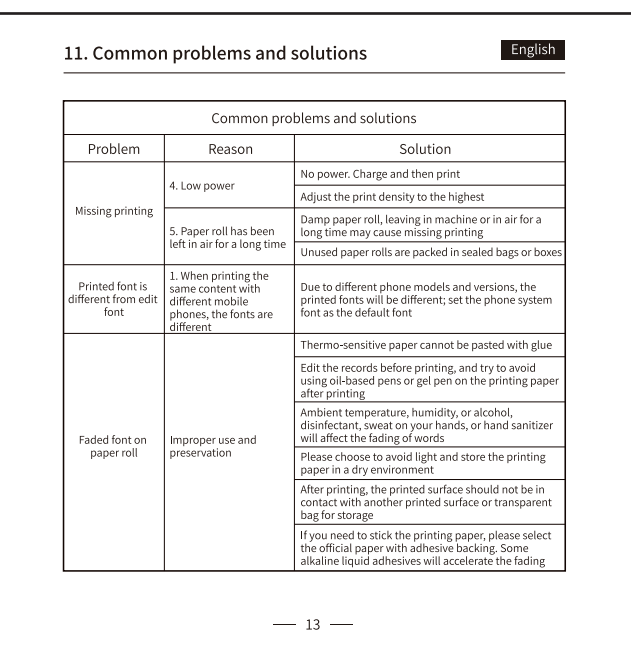
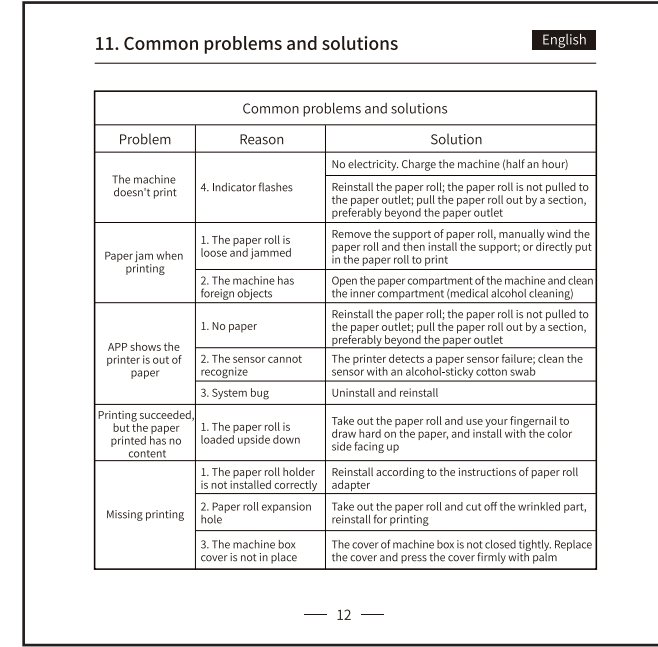
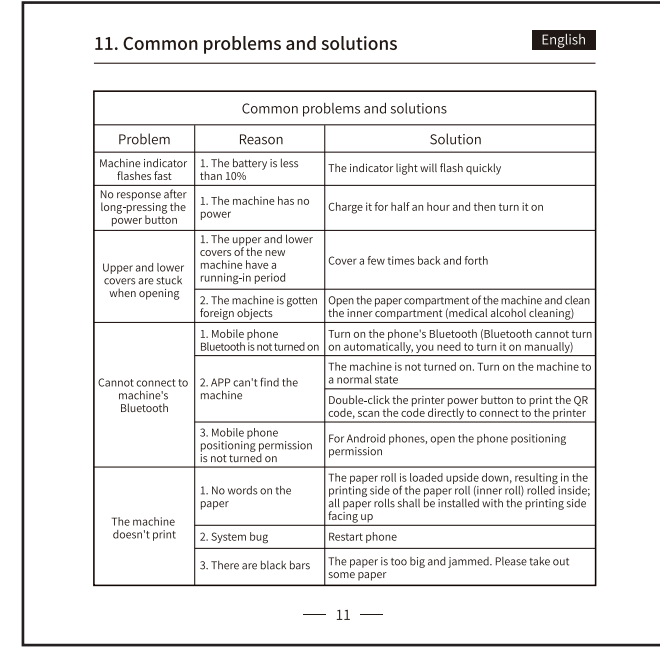
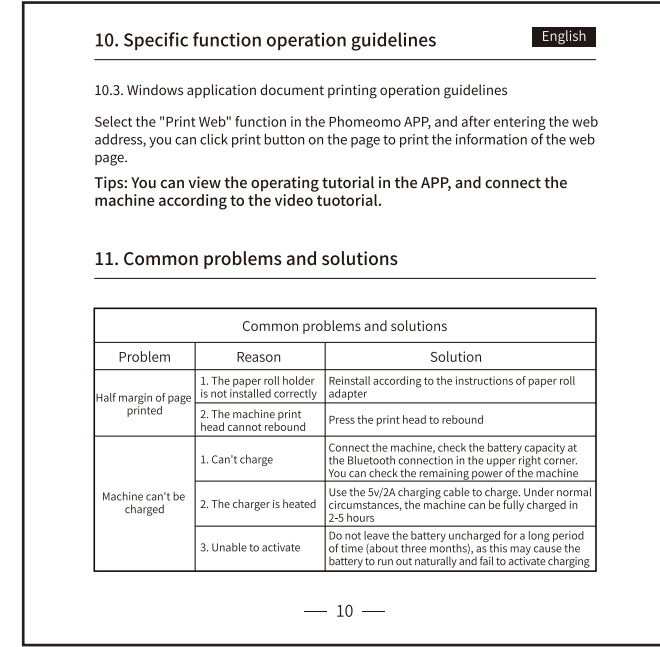
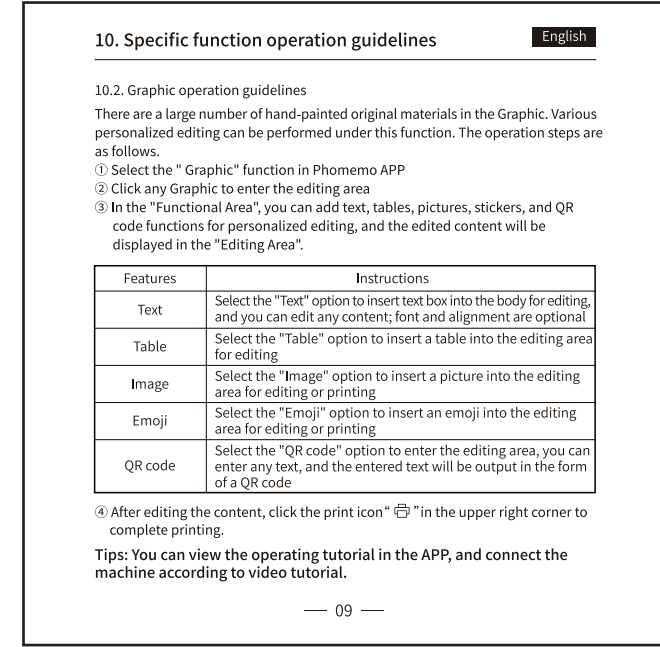
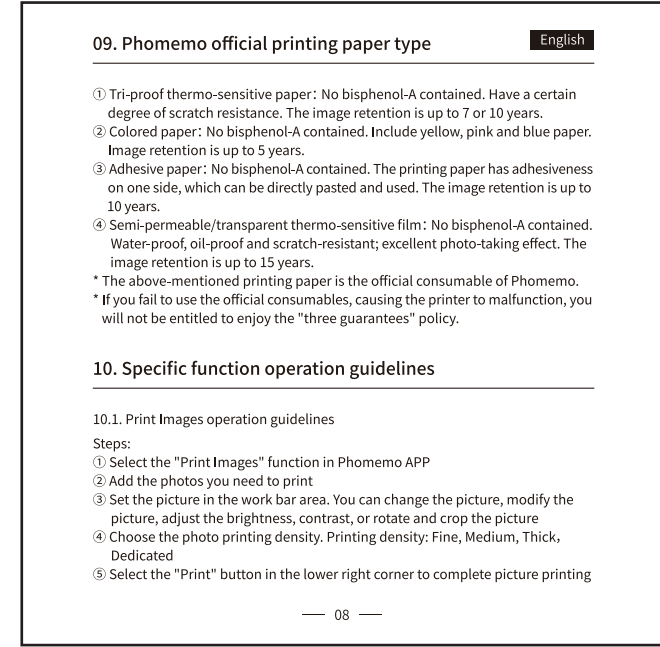
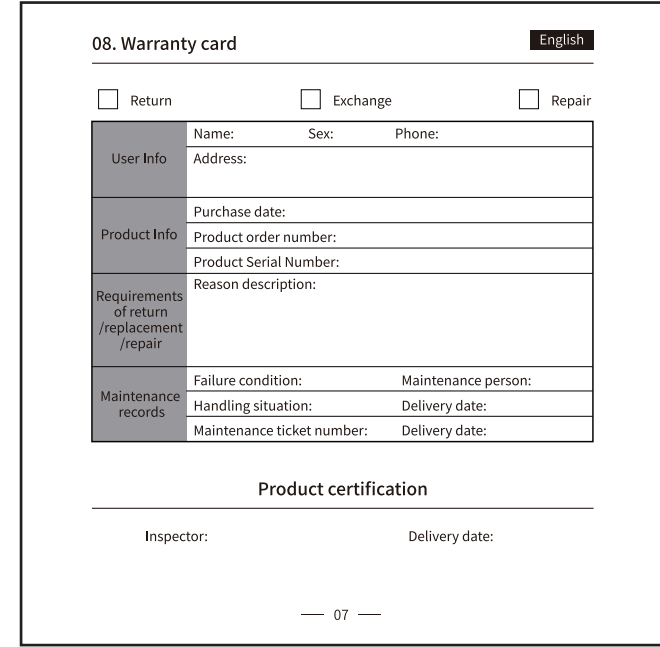
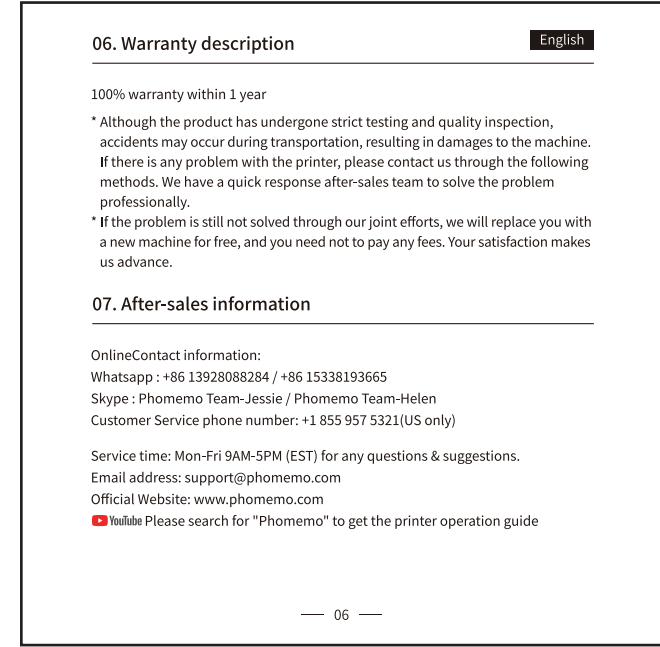
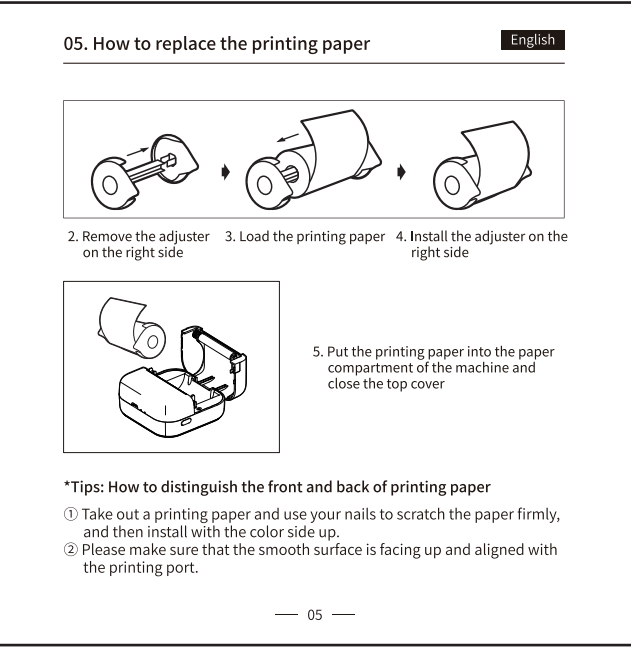
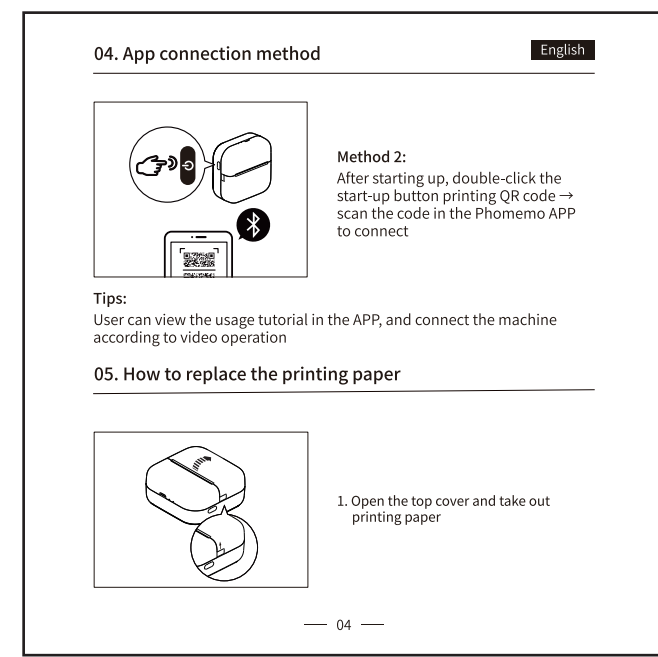
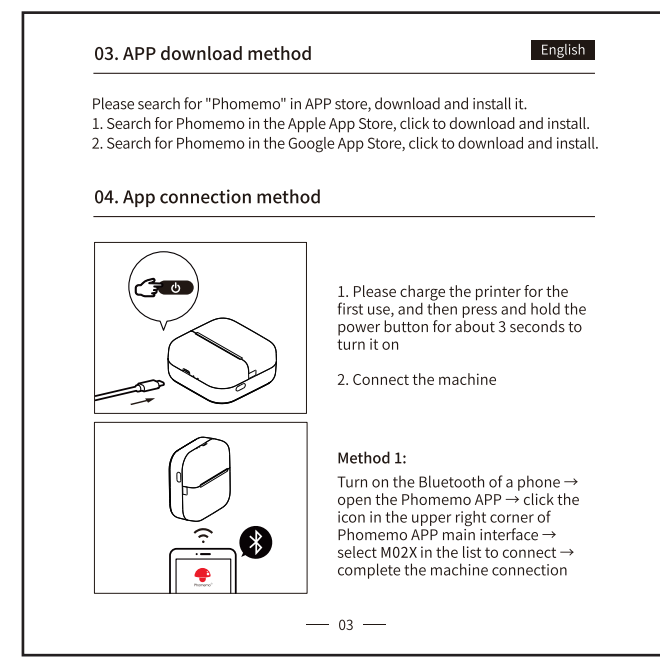
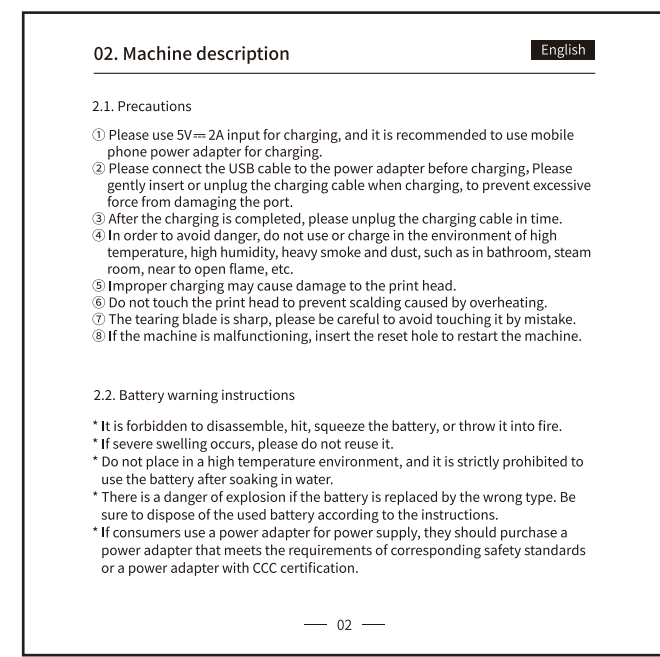
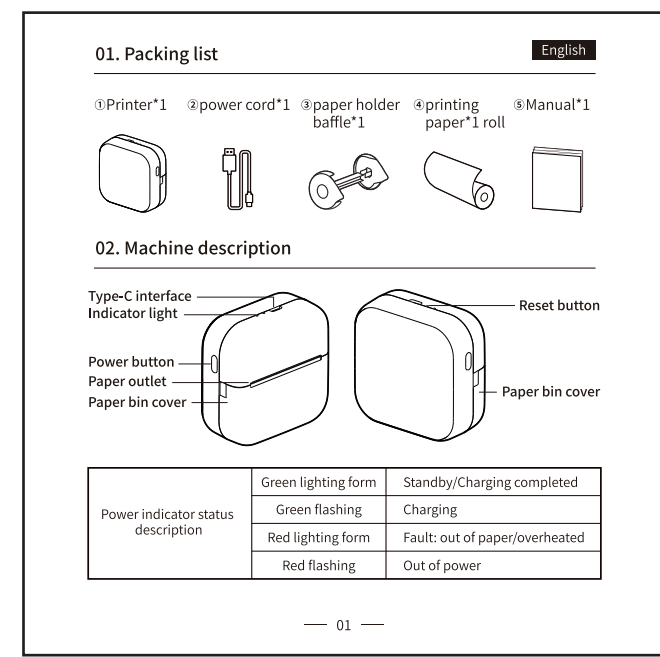
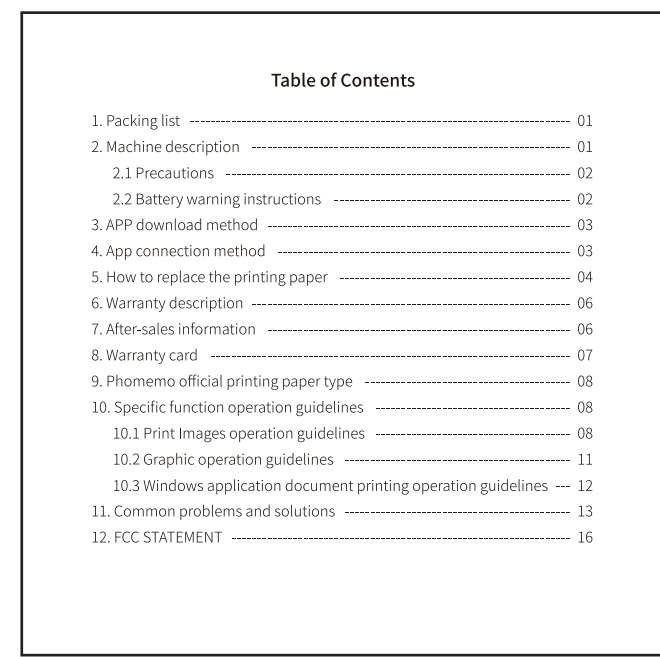
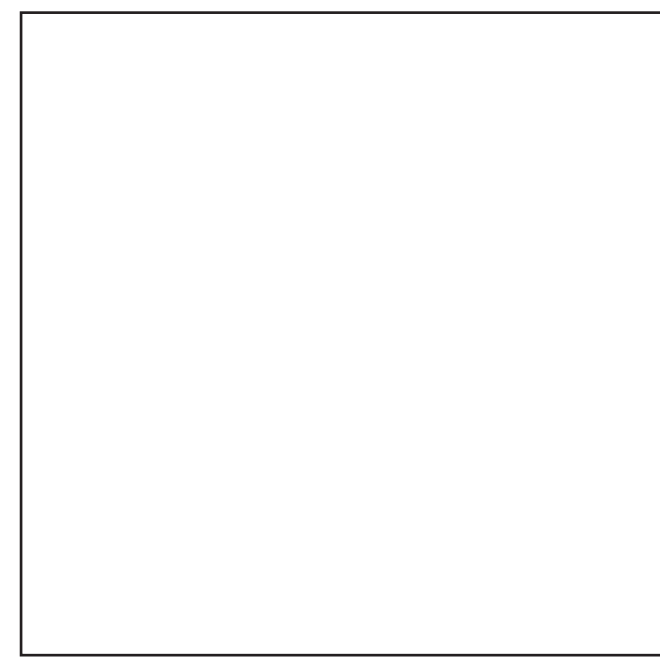
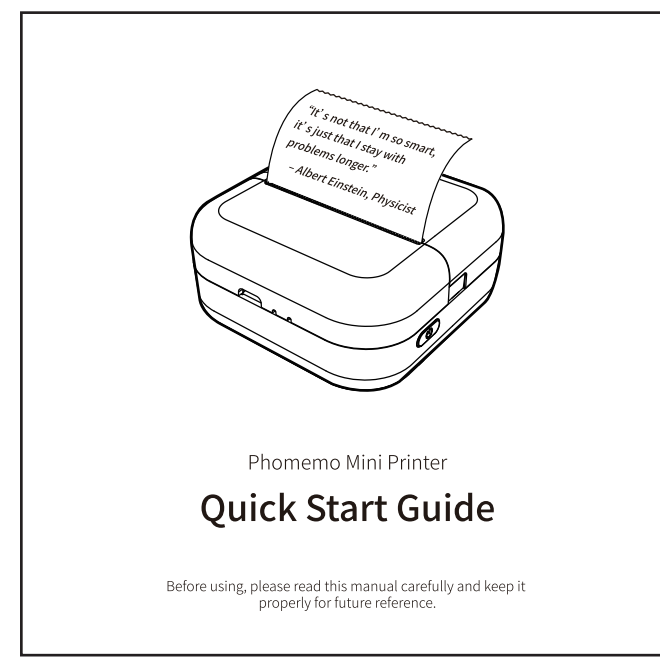
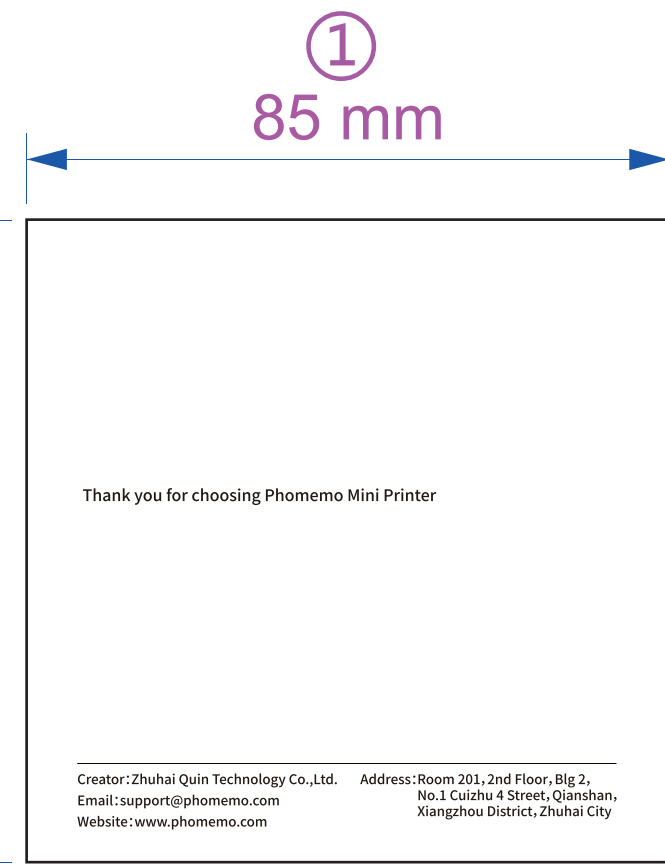

包装工艺：骑马钉

除非另有说明，否则公差按下表：				产品型号		 Phomemo-M02X 英日 说明书 80g 书写纸	
尺寸标注	CLASS A	CLASS B	CLASS C	名称 料号 版本号 比例			
<6.0	±0.5	±1	±2	材料 颜色		1:1	
6.0~30.0	±0.5	±1	±2	单位 图幅			
30~120	±0.5	±1	±2	mm		第 1 张 共 1 张	
120~400	±0.5	±1	±2	第三角度投影			
400~1000	±0.5	±1	±2				
设计				名称			
确认				料号			
审核				版本号			