



# Antenna Describe

Antenna	PCB
Antenna Gain	2.56dBi
Frequency Range	2.4Ghz-2.483Ghz
Connector Type	Direct
Location of mearement(company name)	SHENZHEN SHIXINZHONGXN TECHNOLOGY.CO.,LTD

## 2: External View Drawing

Picture of antenna

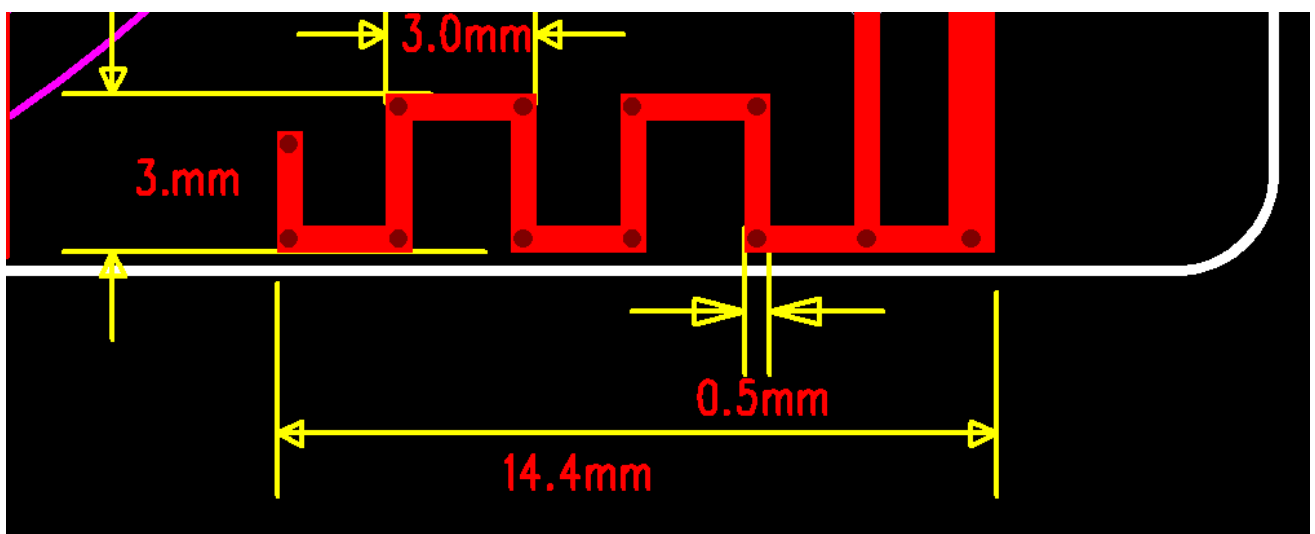

### 3: Measurement Result

#### 3.1 Return Loss (S11 )

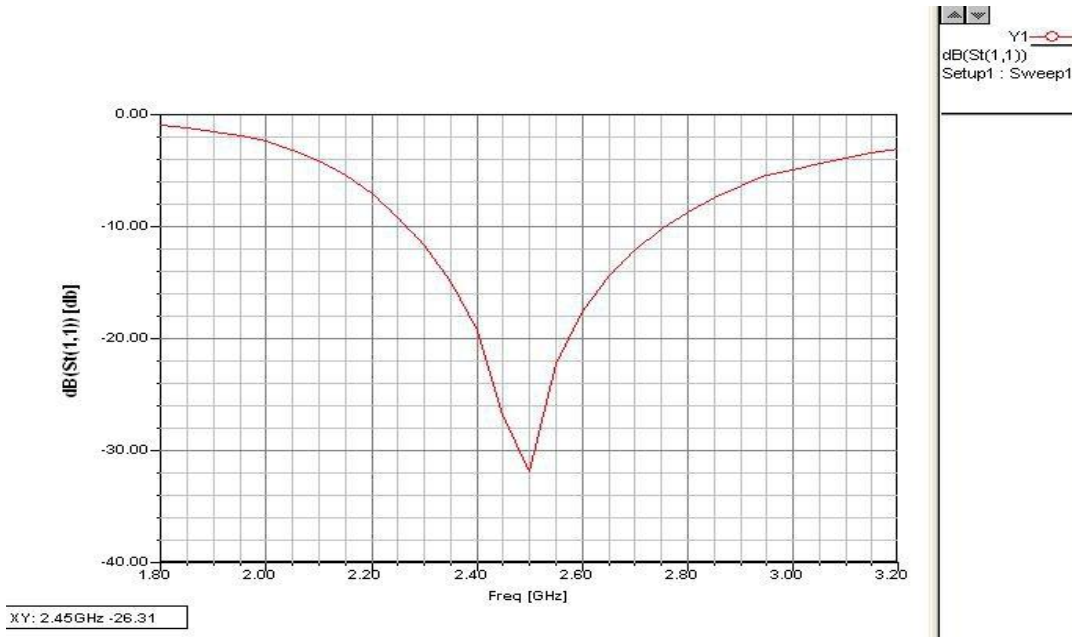

#### 3.2 Smith Chart

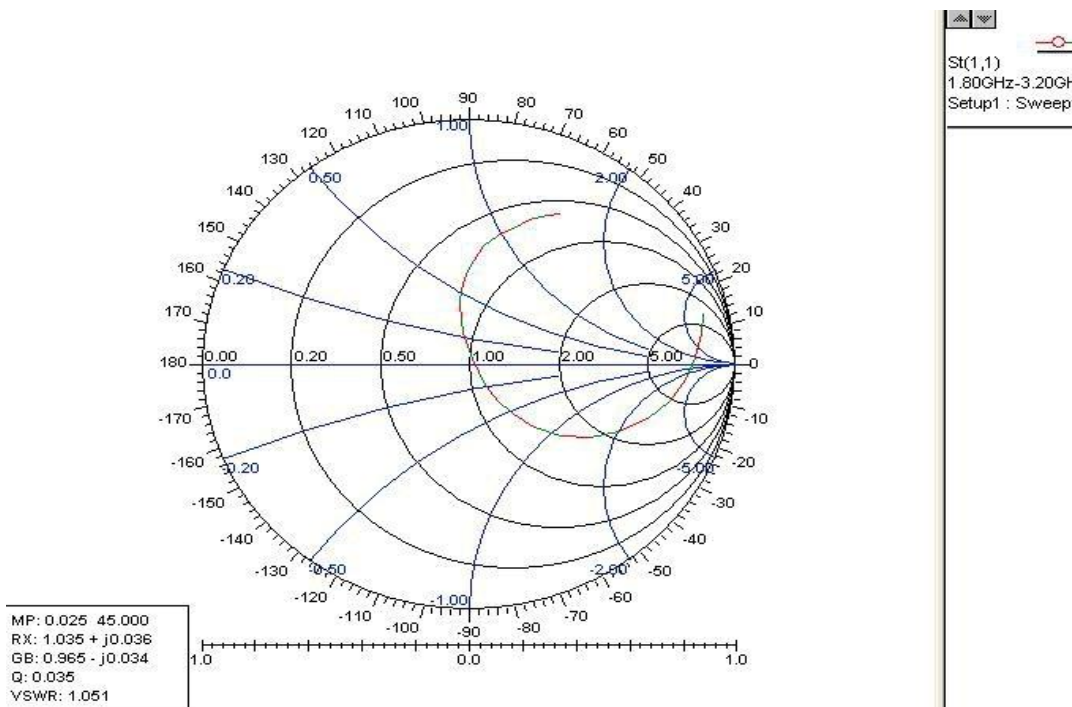

#### 3.3 Gain

### 2400.000MHz H

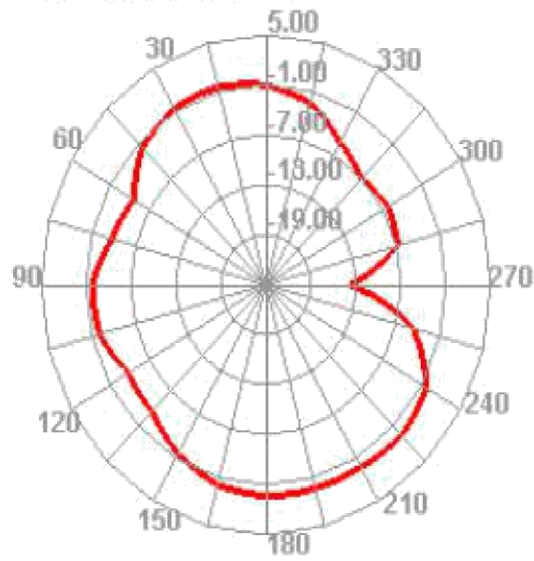

### 2400.000MHz E1

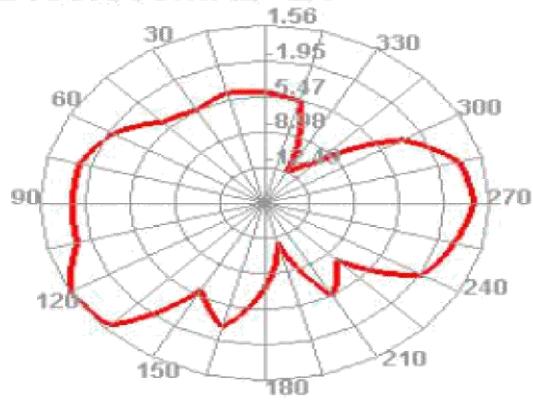

### 2400.000MHz E2

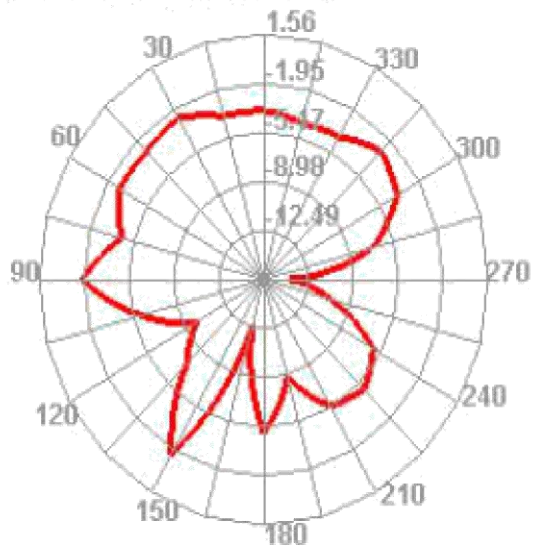

### 2450.000MHz H

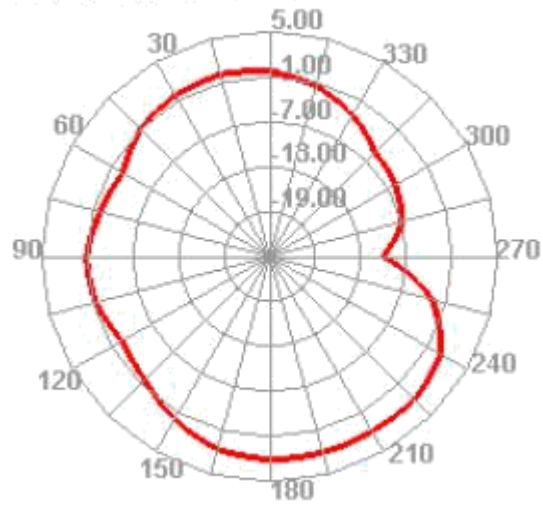

### 2450.000MHz E1

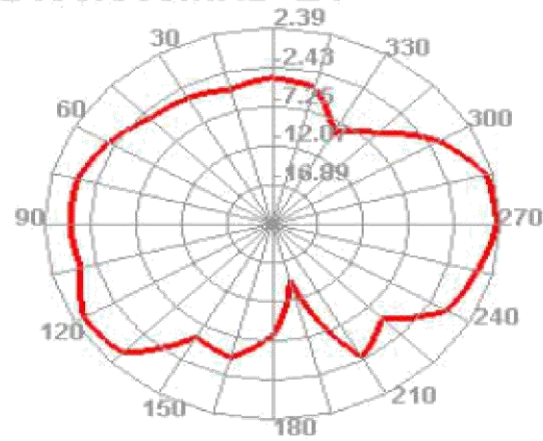

### 2450.000MHz E2

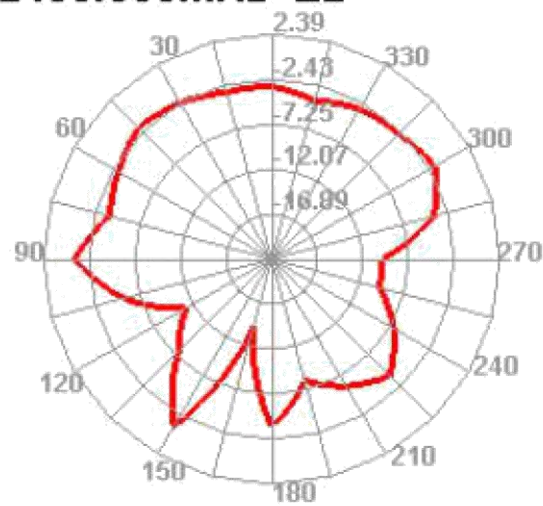

### 2500.000MHz H

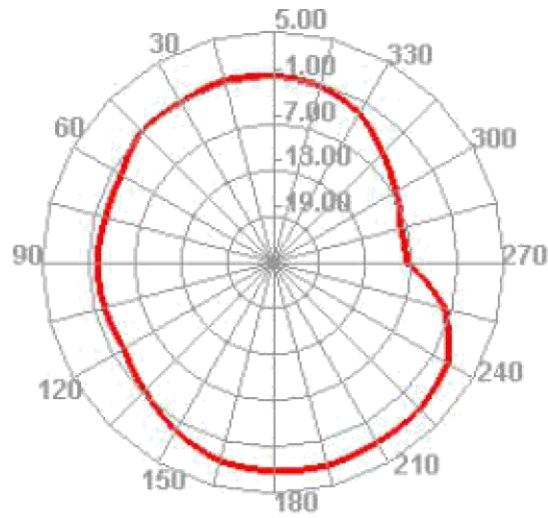

### 2500.000MHz E1

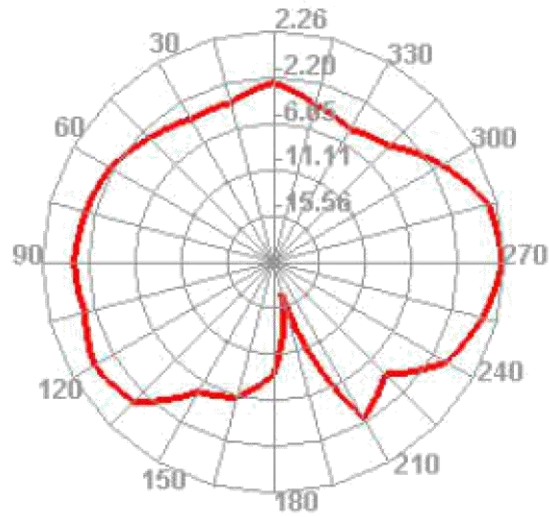

### 2500.000MHz E2

