



RADIO TEST REPORT

Report No.:STS2101023W04

Issued for

Shenzhen Mediafly Technology CO.,LTD

1F A bldg ,weixing Tech-park 268-3 Baoshi Road, Shuitian
community Shiyan St, ShenZhen, China

Product Name:	Tablet PC
Brand Name:	HAOVM
Model Name:	MediaPad P9
Series Model:	N/A
FCC ID:	2ASQ8-P9
Test Standard:	FCC Part 15.407

Any reproduction of this document must be done in full. No single part of this document may be reproduced without permission from STS, All Test Data Presented in this report is only applicable to presented Test sample.

Shenzhen STS Test Services Co., Ltd.
A 1/F, Building B, Zhuoke Science Park, No.190 Chongqing Road, HepingShequ,
Fuyong Sub-District, Bao'an District, Shenzhen, Guang Dong, China
TEL: +86-755 3688 6288 FAX: +86-755 3688 6277 E-mail:sts@stsapp.com





TEST RESULT CERTIFICATION

Applicant's Name..... : Shenzhen Mediafly Technology CO.,LTD
 Address : 1F A bldg ,weixing Tech-park 268-3 Baoshi Road, Shuitian community Shiyian St, ShenZhen, China
Manufacture's Name..... : Shenzhen Mediafly Technology CO.,LTD
 Address : 1F A bldg ,weixing Tech-park 268-3 Baoshi Road, Shuitian community Shiyian St, ShenZhen, China

Product Description

Product Name..... : Tablet PC
 Brand Name : HAOVM
 Model Name : MediaPad P9
 Series Model..... : N/A

Test Standards..... : FCC Part15.407

Test Procedure..... ANSI C63.10-2013

This device described above has been tested by STS, the test results show that the equipment under test (EUT) is in compliance with the FCC requirements. And it is applicable only to the tested sample identified in the report.

This report shall not be reproduced except in full, without the written approval of STS, this document only be altered or revised by STS, personal only, and shall be noted in the revision of the document.

Date of Test..... :
 Date of receipt of test item : 07 Jan. 2021
 Date (s) of performance of tests..... : 07 Jan. 2021 ~ 19 Jan. 2021
 Date of Issue..... : 19 Jan. 2021
 Test Result..... : **Pass**

Testing Engineer : 

 (Chris Chen)

Technical Manager : 

 (Sean she)

Authorized Signatory : 

 (Vita Li)





Table of Contents	Page
1 . SUMMARY OF TEST RESULTS	6
1.1 TEST FACTORY	7
1.2 MEASUREMENT UNCERTAINTY	7
2 . GENERAL INFORMATION	8
2.1 GENERAL DESCRIPTION OF THE EUT	8
2.2 DESCRIPTION OF TEST MODES	10
2.3 TEST SOFTWARE AND POWER LEVEL	11
2.4 BLOCK DIGRAM SHOWING THE CONFIGURATION OF SYSTEM TESTED	12
2.5 DESCRIPTION OF NECESSARY ACCESSORIES AND SUPPORT UNITS	13
2.6 EQUIPMENTS LIST FOR ALL TEST ITEMS	14
3 . EMC EMISSION TEST	15
3.1 CONDUCTED EMISSION MEASUREMENT	15
3.2 RADIATED EMISSION AND (BANDEDGE) MEASUREMENT	19
4. POWER SPECTRAL DENSITY TEST	41
4.1 LIMIT	41
4.2 TEST PROCEDURE	41
4.3 DEVIATION FROM STANDARD	42
4.4 TEST SETUP	42
4.5 EUT OPERATION CONDITIONS	42
4.6 TEST RESULTS	42
5. BANDWIDTH MEASUREMENT	44
5.1 EMISSION BANDWIDTH (EBW) 26 BANDWID PROCEDURES / LIMIT	44
5.2 OCCUPIED BANDWIDTH (99%) TEST APPLIED PROCEDURES / LIMIT	46
5.3 MINIMUM EMISSION BANDWIDTH(6 DB) PROCEDURES / LIMIT	48
6. MAXIMUM CONDUCTED OUTPUT POWER	50
6.1 LIMIT	50
6.2 TEST PROCEDURE	50
6.3 DEVIATION FROM STANDARD	50
6.4 TEST SETUP	50
6.5 EUT OPERATION CONDITIONS	50
6.6 TEST RESULTS	51
7. AUTOMATICALLY DISCONTINUE TRANSMISSION	57
7.1 LIMIT OF AUTOMATICALLY DISCONTINUE TRANSMISSION	57
7.2 TEST RESULT OF AUTOMATICALLY DISCONTINUE TRANSMISSION	57



Table of Contents	Page
8. ANTENNA REQUIREMENT	58
8.1 STANDARD REQUIREMENT	58
8.2 EUT ANTENNA	58
APPENDIX - PHOTOS OF TEST SETUP	59





Revision History

Rev.	Issue Date	Report NO.	Effect Page	Contents
00	19 Jan. 2021	STS2101023W04	ALL	Initial Issue





1. SUMMARY OF TEST RESULTS

Test procedures according to the technical standards:

§ 15.407, KDB 789033 D02 General U-NII Test Procedures New Rules v02r01.

FCC Part 15.407		
FCC standard	Test Item	Results
15.207	AC Conducted Emission	PASS
15.407 (a) /15.407 (e)	26dB/6dB &99% Bandwidth	PASS
15.407(a)	Maximum Conducted Output Power	PASS
15.407(b)/15.205/15.209	Radiated Emission And (bandedge Emissions) Measurement	PASS
15.407(a)	Power Spectral Density	PASS
15.407(c)	Automatically Discontinue Transmission	PASS
15.203/15.204	Antenna Requirement	PASS

NOTE:

(1) 'N/A' denotes test is not applicable in this Test Report.

(2) All tests are according to ANSI C63.10-2013.



1.1 TEST FACTORY

SHENZHEN STS TEST SERVICES CO., LTD

Add. : A 1/F, Building B, Zhuoke Science Park, No.190 Chongqing Road, HepingShequ, Fuyong Sub-District, Bao'an District, Shenzhen, Guang Dong, China

FCC test Firm Registration Number: 625569

IC test Firm Registration Number: 12108A

A2LA Certificate No.: 4338.01

1.2 MEASUREMENT UNCERTAINTY

The reported uncertainty of measurement $y \pm U$, where expanded uncertainty U is based on a standard uncertainty multiplied by a coverage factor of $k=2$, providing a level of confidence of approximately **95 %**.

No.	Item	Uncertainty
1	RF output power, conducted	$\pm 0.68\text{dB}$
2	Unwanted Emissions, conducted	$\pm 2.988\text{dB}$
3	All emissions, radiated 30-1GHz	$\pm 4.39\text{dB}$
4	All emissions, radiated 1G-6GHz	$\pm 5.10\text{dB}$
5	All emissions, radiated >6G	$\pm 5.48\text{dB}$
6	Conducted Emission (9KHz-150KHz)	$\pm 2.79\text{dB}$
7	Conducted Emission (150KHz-30MHz)	$\pm 2.80\text{dB}$



2. GENERAL INFORMATION

2.1 GENERAL DESCRIPTION OF THE EUT

Product Name	Tablet PC	
Trade Name	HAOVM	
Model Name	MediaPad P9	
Series Model	N/A	
Model Difference	N/A	
Product Description	The EUT is a Tablet PC	
	Operation Frequency:	IEEE 802.11a/ n(HT20)/ac(VHT20): 5.180GHz-5.240GHz IEEE 802.11n(HT40)/ac(VHT40): 5.190GHz-5.230GHz IEEE 802.11ac(VHT80): 5.210GHz
		IEEE 802.11a/ n(HT20)/ac(VHT20): 5.745GHz-5.825GHz IEEE 802.11n(HT40)/ac(VHT40): 5.755GHz-5.795GHz IEEE 802.11ac(VHT80): 5.775GHz
		802.11a(OFDM): BPSK,QPSK,16-QAM,64-QAM 802.11n(OFDM): BPSK,QPSK,16-QAM,64-QAM 802.11ac(OFDM): BPSK,QPSK,16-QAM,64-QAM,256-QAM
	Antenna Designation:	Please refer to the Note 3.
	Max.Output Power(Conducted):	9.78dBm
More details of EUT technical specification, please refer to the User's Manual.		
Test Channel	Please refer to the Note 2.	
Adapter	Input: 100-240Vac 50/60Hz 0.4A max Output:DC 5V2A	
Battery	Rated Voltage:3.8V Charge Limit Voltage:4.35V Capacity: 5000mAh	
Hardware version number	P30-9863A-V1.0	
Software version number	P9_V1.0_20201225	
Connecting I/O Port(s)	Please refer to the Note 1.	

Note:

1. For a more detailed features description, please refer to the manufacturer's specifications or the User Manual.



2. Operation Frequency of channel			
5.180GHz-5.240GHz		5.745GHz-5.825GHz	
Channel	Frequency	Channel	Frequency
36	5180	149	5745
38	5190	151	5755
40	5200	153	5765
42	5210	157	5785
44	5220	159	5795
46	5230	161	5805
48	5240	165	5825

Note:

In section 15.31(m), regards to the operating frequency range over 10 MHz, the Lowest frequency, the middle frequency, and the highest frequency of channel were selected to perform the test, and the selected channel see below:

Carrier Frequency Channel

5GHz:

For 802.11a/n(HT20) /ac (VHT20)			
Channel	Freq.(MHz)	Channel	Freq.(MHz)
36	5180	149	5745
40	5200	157	5785
48	5240	165	5825

For 802.11n(HT40) /ac (VHT40)			
Channel	Freq.(MHz)	Channel	Freq.(MHz)
38	5190	151	5755
46	5230	159	5795

For 802.11ac (VHT80)			
Channel	Freq.(MHz)	Channel	Freq.(MHz)
42	5210	155	5775

3.	Ant	Brand	Model Name	Ant Type	Connector	Gain (dBi)	NOTE
	A	HAOVM	MediaPad P9	PIFA	N/A	1.39dBi	WLAN Ant.

Note: The antenna information refer the manufacturer provide report, applicable only to the tested sample identified in the report.



2.2 DESCRIPTION OF TEST MODES

To investigate the maximum EMI emission characteristics generates from EUT, the test system was pre-scanning tested base on the consideration of following EUT operation mode or test configuration mode which possible have effect on EMI emission level. Each of these EUT operation mode(s) or test configuration mode(s) mentioned above was evaluated respectively.

Worst Mode	Description	Data Rate
Mode 1	TX IEEE 802.11a HT20 CH36&CH40&CH48	6 Mbps
Mode 2	TX IEEE 802.11a HT20 CH149&CH157&CH165	6 Mbps
Mode 3	TX IEEE 802.11n HT20 CH36&CH40&CH48	MCS 0
Mode 4	TX IEEE 802.11ac VHT20 CH36&CH40&CH48	NSS1 MCS0
Mode 5	TX IEEE 802.11n HT20 CH149&CH157&CH165	MCS 0
Mode 6	TX IEEE 802.11ac VHT20 CH149&CH157&CH165	NSS1 MCS0
Mode 7	TX IEEE 802.11n HT40 CH38&CH46	MCS 0
Mode 8	TX IEEE 802.11ac VHT40 CH38&CH46	NSS1 MCS0
Mode 9	TX IEEE 802.11n HT40 CH151&CH159	MCS 0
Mode 10	TX IEEE 802.11ac VHT40 CH151&CH159	NSS1 MCS0
Mode 11	TX IEEE 802.11ac VHT80 CH42	NSS1 MCS0
Mode 12	TX IEEE 802.11ac VHT80 CH155	NSS1 MCS0

- Note: (1) The measurements are performed at the highest, middle, lowest available channels.
 (2) The measurements are performed at all Bit Rate of Transmitter, the worst data was reported.
 (3) We have be tested for all avaiable U.S. voltage and frequencies(For 120V,50/60Hz and 240V, 50/60Hz) for which the device is capable of operation.
 (4) The battery is full-charged during the radited and RF conducted test.

AC Conducted Emission

Test Case	
AC Conducted Emission	Mode 13: Keeping TX + WLAN Link



2.3 TEST SOFTWARE AND POWER LEVEL

During testing channel & power controlling software provided by the customer was used to control the operating channel as well as the output power level.

RF Function	Type	Mode Or Modulation type	ANT Gain(dBi)	Power Class	Software For Testing
WIFI(5G)	5G WIFI Band1 (5150MHz-5250MHz)	802.11a	1.39	10	Pandora
		802.11n(HT20)		10	
		802.11n(HT40)		10	
		802.11ac(VHT20)		10	
		802.11ac(VHT40)		10	
		802.11ac(VHT80)		5	
RF Function	Type	Mode Or Modulation type	ANT Gain(dBi)	Power Class	Software For Testing
WIFI(5G)	5G WIFI Band4 (5725MHz-5875MHz)	802.11a	1.39	10	Pandora
		802.11n(HT20)		10	
		802.11n(HT40)		10	
		802.11ac(VHT20)		10	
		802.11ac(VHT40)		10	
		802.11ac(VHT80)		5	

2.4 BLOCK DIGRAM SHOWING THE CONFIGURATION OF SYSTEM TESTED

Radiated Spurious Emission Test

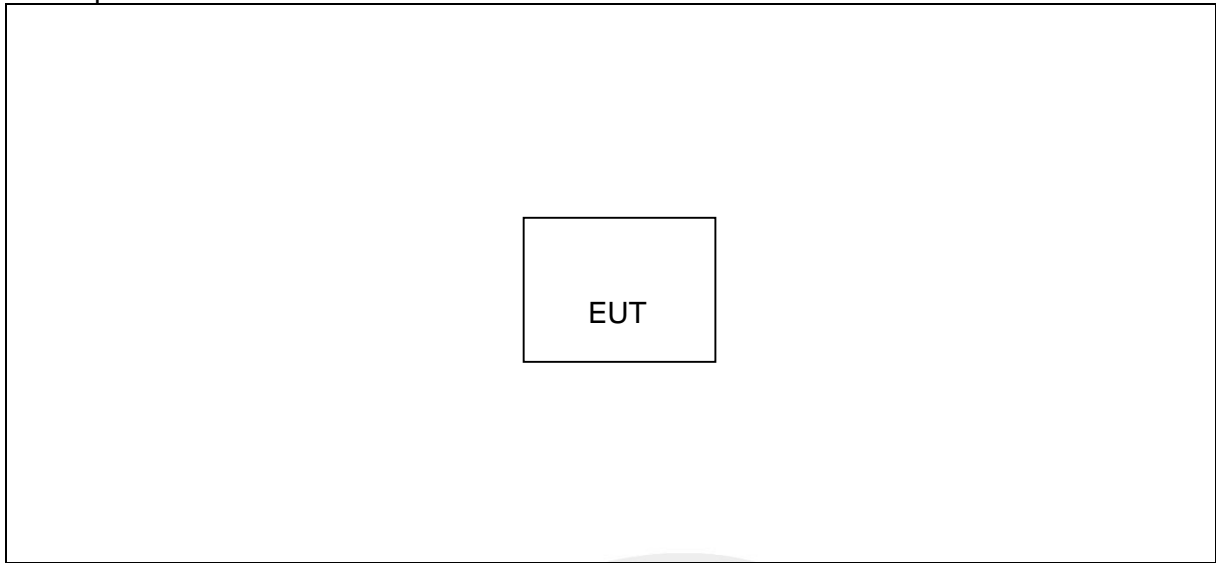

Conducted Emission Test

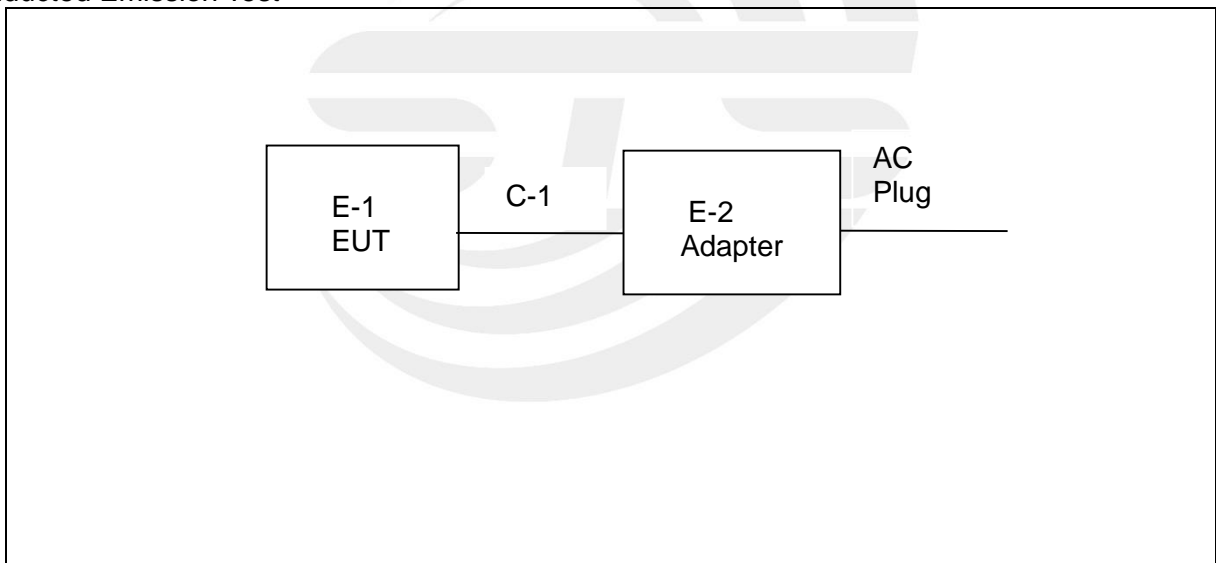



2.5 DESCRIPTION OF NECESSARY ACCESSORIES AND SUPPORT UNITS

The EUT has been tested as an independent unit together with other necessary accessories or support units. The following support units or accessories were used to form a representative test configuration during the tests.

Necessary accessories

Item	Equipment	Mfr/Brand	Model/Type No.	Length	Note
E-2	Adapter	N/A	FX2U-050300U	N/A	N/A
C-1	USB Cable	N/A	N/A	N/A	N/A

Support units

Item	Equipment	Mfr/Brand	Model/Type No.	Length	Note
N/A	N/A	N/A	N/A	N/A	N/A

Note:

- (1) The support equipment was authorized by Declaration of Confirmation.
- (2) For detachable type I/O cable should be specified the length in cm in 『Length』 column.



2.6 EQUIPMENTS LIST FOR ALL TEST ITEMS

Radiation Test equipment

Kind of Equipment	Manufacturer	Type No.	Serial No.	Last calibration	Calibrated until
Test Receiver	R&S	ESCI	101427	2020.10.12	2021.10.11
Signal Analyzer	Agilent	N9020A	MY51110105	2020.10.10	2021.10.09
Active loop Antenna	ZHINAN	ZN30900C	16035	2019.07.11	2021.07.10
Bilog Antenna	TESEQ	CBL6111D	34678	2020.10.12	2022.10.11
Horn Antenna	SCHWARZBECK	BBHA 9120D(1201)	9120D-1343	2019.10.15	2021.10.14
SHF-EHF Horn Antenna (18G-40GHz)	A-INFO	LB-180400-KF	J211020657	2020.10.12	2022.10.11
Pre-Amplifier (0.1M-3GHz)	EM	EM330	060665	2020.10.12	2021.10.11
Pre-Amplifier (1G-18GHz)	SKET	LNPA-01018G-45	SK2018080901	2020.10.12	2021.10.11
Pre-Amplifier (18G-40GHz)	SKET	LNPA-1840-50	SK2018101801	2020.10.10	2021.10.09
Temperature & Humidity	HH660	Mieo	N/A	2020.10.13	2021.10.12
turn table	EM	SC100_1	60531	N/A	N/A
Antenna mast	EM	SC100	N/A	N/A	N/A
Test SW	FARAD	EZ-EMC(Ver.STSLAB-03A1 RE)			

Conduction Test equipment

Kind of Equipment	Manufacturer	Type No.	Serial No.	Last calibration	Calibrated until
Test Receiver	R&S	ESCI	101427	2020.10.12	2021.10.11
LISN	R&S	ENV216	101242	2020.10.12	2021.10.11
LISN	EMCO	3810/2NM	23625	2020.10.12	2021.10.11
Temperature & Humidity	HH660	Mieo	N/A	2020.10.12	2021.10.11
Test SW	FARAD	EZ-EMC(Ver.STSLAB-03A1 CE)			

RF Connected Test

Kind of Equipment	Manufacturer	Type No.	Serial No.	Last calibration	Calibrated until
Power Sensor	Keysight	U2021XA	MY55520005	2020.10.10	2021.10.09
			MY55520006	2020.10.10	2021.10.09
			MY56120038	2020.10.10	2021.10.09
			MY56280002	2020.10.10	2021.10.09
Signal Analyzer	Agilent	N9020A	MY51110105	2020.03.05	2021.03.04
Temperature & Humidity	HH660	Mieo	N/A	2020.10.13	2021.10.12



3. EMC EMISSION TEST

3.1 CONDUCTED EMISSION MEASUREMENT

3.1.1 POWER LINE CONDUCTED EMISSION Limits (Frequency Range 150KHz-30MHz)

FREQUENCY (MHz)	Class B (dBuV)		Standard
	Quasi-peak	Average	
0.15 -0.5	66 - 56 *	56 - 46 *	CISPR
0.50 -5.0	56.00	46.00	CISPR
5.0 -30.0	60.00	50.00	CISPR

0.15 -0.5	66 - 56 *	56 - 46 *	FCC
0.50 -5.0	56.00	46.00	FCC
5.0 -30.0	60.00	50.00	FCC

Note:

- (1) The tighter limit applies at the band edges.
- (2) The limit of “ * ” marked band means the limitation decreases linearly with the logarithm of the frequency in the range.

The following table is the setting of the receiver

Receiver Parameters	Setting
Attenuation	10 dB
Start Frequency	0.15 MHz
Stop Frequency	30 MHz
IF Bandwidth	9 kHz

3.1.2 TEST PROCEDURE

- a. The EUT was placed 0.8 meters from the horizontal ground plane with EUT being connected to the power mains through a line impedance stabilization network (LISN). All other support equipments powered from additional LISN(s). The LISN provide 50 Ohm/ 50uH of coupling impedance for the measuring instrument.
- b. Interconnecting cables that hang closer than 40 cm to the ground plane shall be folded back and forth in the center forming a bundle 30 to 40 cm long.
- c. I/O cables that are not connected to a peripheral shall be bundled in the center. The end of the cable may be terminated, if required, using the correct terminating impedance. The overall length shall not exceed 1 m.
- d. LISN at least 80 cm from nearest part of EUT chassis.
- e. For the actual test configuration, please refer to the related Item –EUT Test Photos.

3.1.3 DEVIATION FROM TEST STANDARD

No deviation

3.1.4 TEST SETUP

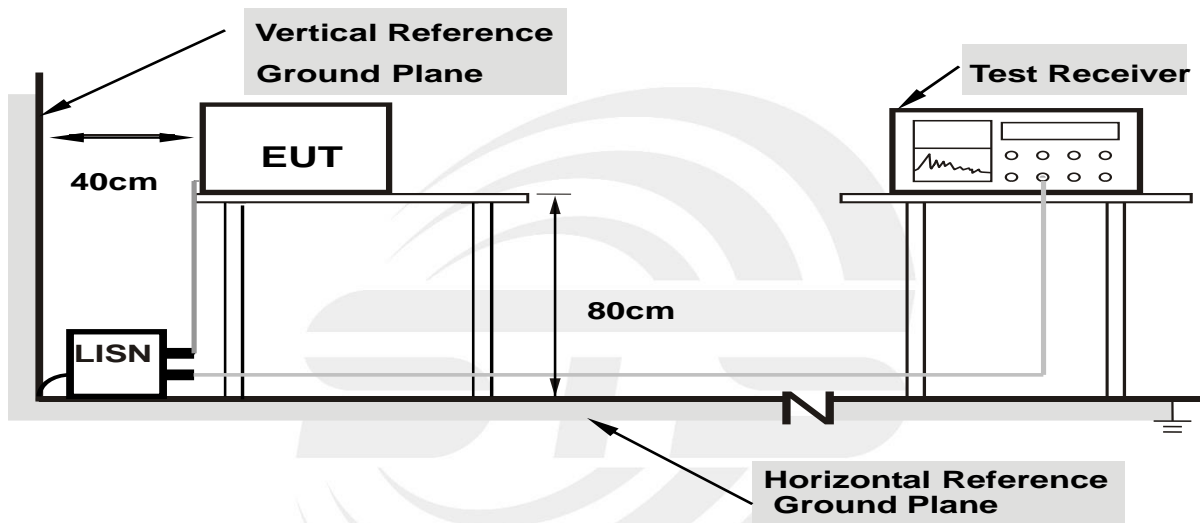

- Note: 1.Support units were connected to second LISN.**
2.Both of LISNs (AMN) are 80 cm from EUT and at least 80 from other units and other metal planes

3.1.5 EUT OPERATING CONDITIONS

The EUT was configured for testing in a typical fashion (as a customer would normally use it). The EUT has been programmed to continuously transmit during test. This operating condition was tested and used to collect the included data.



3.1.6 TEST RESULTS

Temperature:	24.5(C)	Relative Humidity:	45%RH
Test Voltage:	AC 120V/60Hz	Phase:	L
Test Mode :	Mode 13		

No.	Frequency (MHz)	Reading (dBuV)	Correct Factor(dB)	Result (dBuV)	Limit (dBuV)	Margin (dB)	Remark
1	0.1582	17.98	20.21	38.19	65.56	-27.37	QP
2	0.1582	2.63	20.21	22.84	55.56	-32.72	AVG
3	0.5900	16.37	20.36	36.73	56.00	-19.27	QP
4	0.5900	5.85	20.36	26.21	46.00	-19.79	AVG
5	1.1300	11.62	20.16	31.78	56.00	-24.22	QP
6	1.1300	-3.41	20.16	16.75	46.00	-29.25	AVG
7	1.9460	9.89	20.15	30.04	56.00	-25.96	QP
8	1.9460	-2.64	20.15	17.51	46.00	-28.49	AVG
9	3.5100	10.59	20.07	30.66	56.00	-25.34	QP
10	3.5100	-2.80	20.07	17.27	46.00	-28.73	AVG
11	14.3300	21.20	20.04	41.24	60.00	-18.76	QP
12	14.3300	6.43	20.04	26.47	50.00	-23.53	AVG

Remark:

1. All readings are Quasi-Peak and Average values.
2. Margin = Result (Result =Reading + Factor)–Limit
3. Factor=LISN factor+Cable loss+Limiter (10dB)

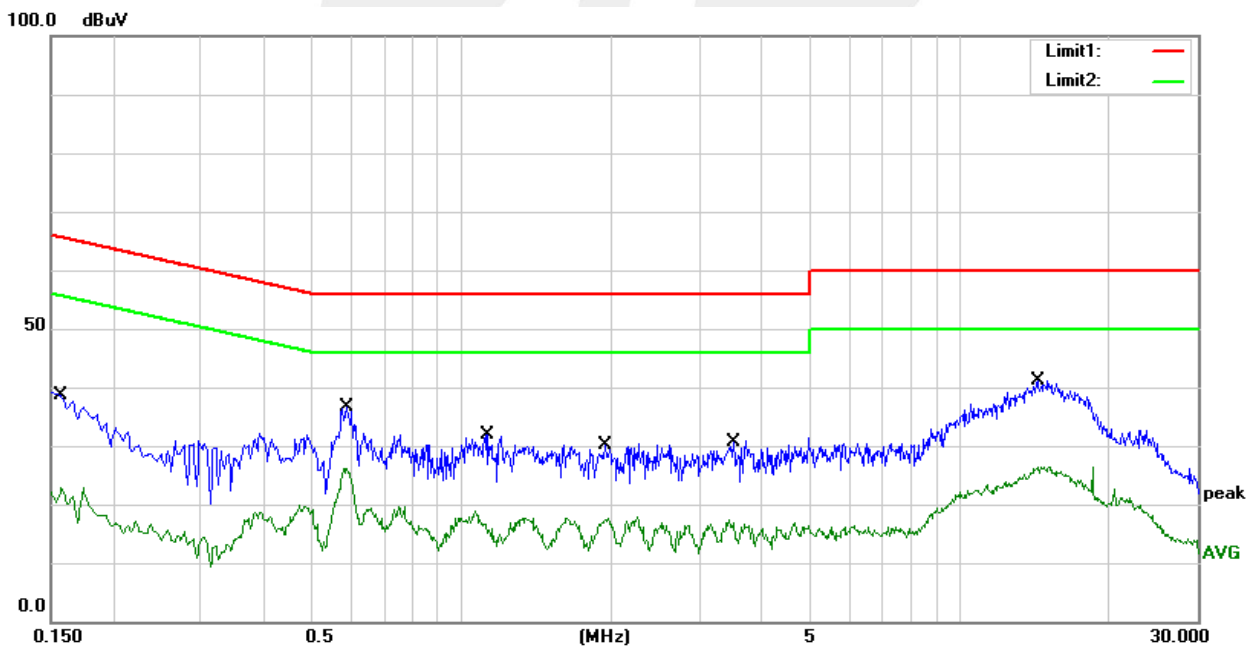



Temperature:	24.5(C)	Relative Humidity:	45%RH
Test Voltage	AC 120V/60Hz	Phase:	N
Test Mode	Mode 13		

No.	Frequency (MHz)	Reading (dBuV)	Correct Factor(dB)	Result (dBuV)	Limit (dBuV)	Margin (dB)	Remark
1	0.1500	18.14	20.19	38.33	66.00	-27.67	QP
2	0.1500	3.47	20.19	23.66	56.00	-32.34	AVG
3	0.5860	20.06	20.37	40.43	56.00	-15.57	QP
4	0.5860	10.88	20.37	31.25	46.00	-14.75	AVG
5	1.3780	10.64	20.16	30.80	56.00	-25.20	QP
6	1.3780	2.45	20.16	22.61	46.00	-23.39	AVG
7	2.2860	10.12	20.13	30.25	56.00	-25.75	QP
8	2.2860	1.86	20.13	21.99	46.00	-24.01	AVG
9	5.0620	10.27	20.02	30.29	60.00	-29.71	QP
10	5.0620	1.26	20.02	21.28	50.00	-28.72	AVG
11	15.1980	22.10	20.09	42.19	60.00	-17.81	QP
12	15.1980	9.32	20.09	29.41	50.00	-20.59	AVG

Remark:

1. All readings are Quasi-Peak and Average values.
2. Margin = Result (Result =Reading + Factor) –Limit
3. Factor=LISN factor+Cable loss+Limiter (10dB)

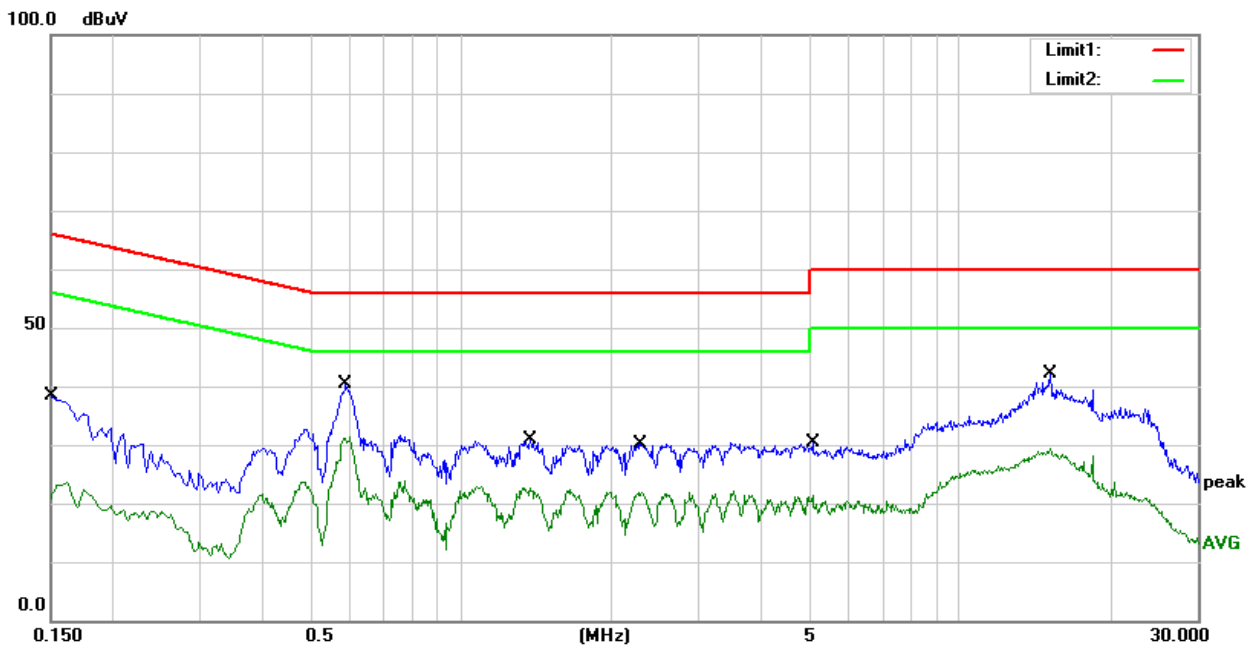



3.2 RADIATED EMISSION AND (BANDEDGE) MEASUREMENT

3.2.1 RADIATED EMISSION LIMITS (Frequency Range 9kHz-1000MHz)

In case the emission fall within the restricted band specified on 15.407(b)7& 15.205/209(a), then the (a); limit in the table below has to be followed.

Frequencies (MHz)	Field Strength (microrvolts/meter)	Measurement Distance (meters)
0.009~0.490	2400/F(KHz)	300
0.490~1.705	24000/F(KHz)	30
1.705~30.0	30	30
30~88	100	3
88~216	150	3
216~960	200	3
Above 960	500	3

LIMITS OF RADIATED EMISSION MEASUREMENT (Above 1000MHz)

FREQUENCY (MHz)	Class B (dBuV/m) (at 3M)	
	PEAK	AVERAGE
Above 1000	68.2	54

Notes:

- (1) The limit for radiated test was performed according to FCC PART 15E.
- (2) The tighter limit applies at the band edges.
- (3) Emission level (dBuV/m)=20log Emission level (uV/m).

LIMITS OF RESTRICTED FREQUENCY BANDS

FREQUENCY (MHz)	FREQUENCY (MHz)	FREQUENCY (MHz)	FREQUENCY (GHz)
0.090-0.110	16.42-16.423	399.9-410	4.5-5.15
0.495-0.505	16.69475-16.69525	608-614	5.35-5.46
2.1735-2.1905	16.80425-16.80475	960-1240	7.25-7.75
4.125-4.128	25.5-25.67	1300-1427	8.025-8.5
4.17725-4.17775	37.5-38.25	1435-1626.5	9.0-9.2
4.20725-4.20775	73-74.6	1645.5-1646.5	9.3-9.5
6.215-6.218	74.8-75.2	1660-1710	10.6-12.7
6.26775-6.26825	108-121.94	1718.8-1722.2	13.25-13.4
6.31175-6.31225	123-138	2200-2300	14.47-14.5
8.291-8.294	149.9-150.05	2310-2390	15.35-16.2
8.362-8.366	156.52475-156.52525	2483.5-2500	17.7-21.4
8.37625-8.38675	156.7-156.9	2690-2900	22.01-23.12
8.41425-8.41475	162.0125-167.17	3260-3267	23.6-24.0
12.29-12.293	167.72-173.2	3332-3339	31.2-31.8
12.51975-12.52025	240-285	3345.8-3358	36.43-36.5
12.57675-12.57725	322-335.4	3600-4400	Above 38.6
13.36-13.41			

Note: In case the emission radiated emission above 1000MHz fall within the restricted band the restricted frequency bands, the peak limit is 74 dBuV/m.



LIMITS OF EMISSIONS OUTSIDE OF THE FREQUENCY BANDS

Undesirable emission limits. Except as shown in paragraph (b)(7) of this section, the maximum emissions outside of the frequency bands of operation shall be attenuated in accordance with the following limits:

- (1) For transmitters operating in the 5.15-5.25 GHz band: All emissions outside of the 5.15-5.35 GHz band shall not exceed an e.i.r.p. of -27 dBm/MHz.
- (2) For transmitters operating in the 5.25-5.35 GHz band: All emissions outside of the 5.15-5.35 GHz band shall not exceed an e.i.r.p. of -27 dBm/MHz.
- (3) For transmitters operating in the 5.47-5.725 GHz band: All emissions outside of the 5.47-5.725 GHz band shall not exceed an e.i.r.p. of -27 dBm/MHz.
- (4) For transmitters operating in the 5.725-5.85 GHz band:
 - (i) All emissions shall be limited to a level of -27 dBm/MHz at 75 MHz or more above or below the band edge increasing linearly to 10 dBm/MHz at 25 MHz above or below the band edge, and from 25 MHz above or below the band edge increasing linearly to a level of 15.6 dBm/MHz at 5 MHz above or below the band edge, and from 5 MHz above or below the band edge increasing linearly to a level of 27 dBm/MHz at the band edge.

Note: dBuV/m(at 3M) = EIRP(dBm) + 95.3.

Peak Limit = -27dBm/MHz + 95.3 = 68.3 dBuV/m.

Spectrum Parameter	Setting
Attenuation	Auto
Detector	Peak
Start Frequency	1000 MHz(Peak/AV)
Stop Frequency	10th carrier harmonic (Peak/AV)
RB / VB (emission in restricted band)	1 MHz / 1 MHz, AV=1 MHz /3 MHz

For Band edge

Spectrum Parameter	Setting
Detector	Peak
RB / VB (emission in restricted band)	1 MHz / 1 MHz, AV=1 MHz /3 MHz

Receiver Parameter	Setting
Attenuation	Auto
Start ~ Stop Frequency	9kHz~90kHz / RB 200Hz for PK & AV
Start ~ Stop Frequency	90kHz~110kHz / RB 200Hz for QP
Start ~ Stop Frequency	110kHz~490kHz / RB 200Hz for PK & AV
Start ~ Stop Frequency	490kHz~30MHz / RB 9kHz for QP
Start ~ Stop Frequency	30MHz~1000MHz / RB 120kHz for QP



3.2.2 TEST PROCEDURE

- a. The measuring distance of at 3 m shall be used for measurements at frequency 0.009MHz up to 1GHz. For frequencies above 1GHz, any suitable measuring distance may be used.
- b. The EUT was placed on the top of a rotating table 0.8 meters(above 1GHz is 1.5 m) above the ground at a 3 meter anechoic chamber. The table was rotated 360 degrees to determine the position of the highest radiation.
- c. The height of the equipment shall be 0.8 m(above 1GHz is 1.5 m); the height of the test antenna shall vary between 1 m to 4 m. Horizontal and vertical polarizations of the antenna are set to make the measurement.
- d. The initial step in collecting conducted emission data is a spectrum analyzer peak detector mode pre-scanning the measurement frequency range. Significant peaks are then marked and then Quasi Peak detector mode re-measured.
- e. If the Peak Mode measured value compliance with and lower than Quasi Peak Mode Limit, the EUT shall be deemed to meet QP Limits and then no additional QP Mode measurement performed.
- f. For the actual test configuration, please refer to the related Item –EUT Test Photos.

Note:

Both horizontal and vertical antenna polarities were tested and performed test to three orthogonal axis. The worst case emissions were reported.

3.2.2 DEVIATION FROM TEST STANDARD

No deviation

3.2.3 TEST SETUP

(A) Radiated Emission Test-Up Frequency Below 30MHz

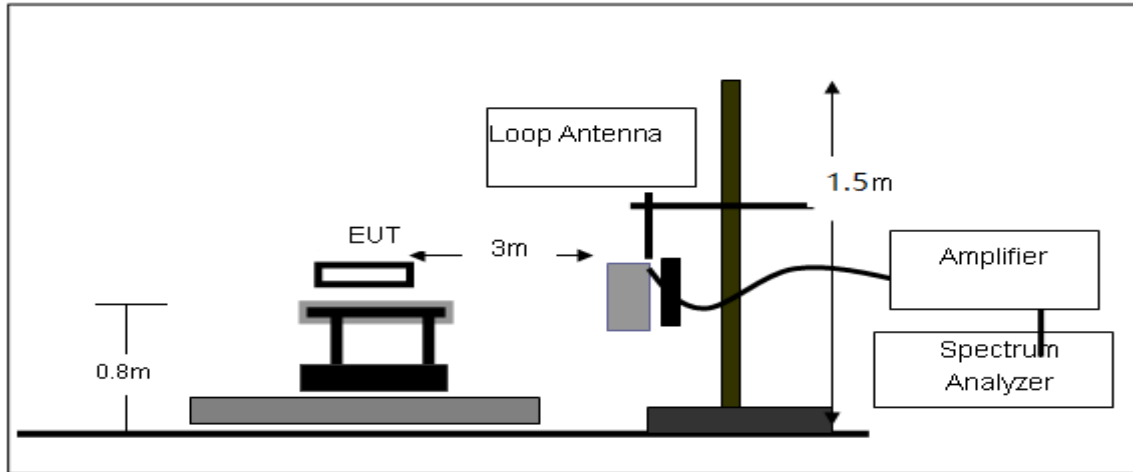

(B) Radiated Emission Test-Up Frequency 30MHz~1GHz

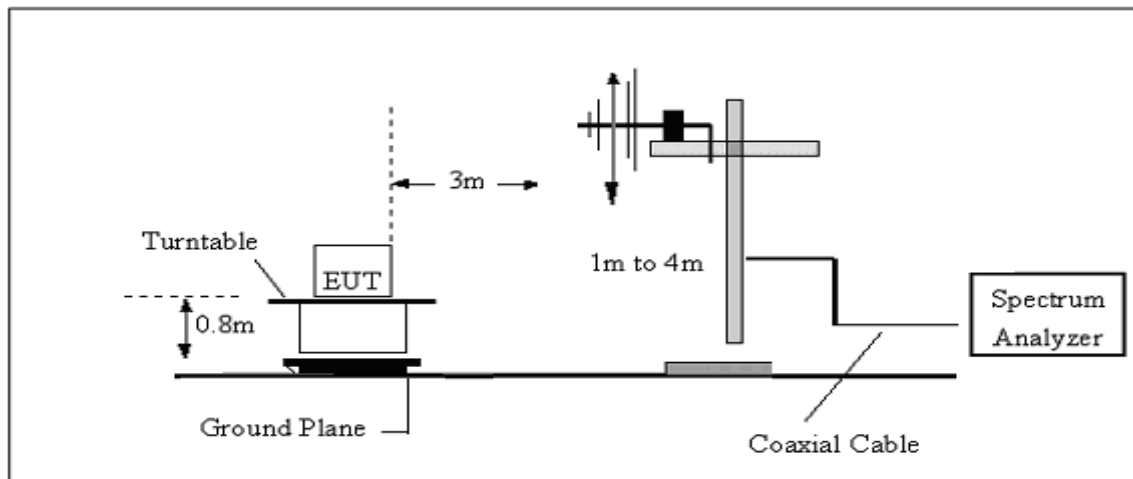

(C) Radiated Emission Test-Up Frequency Above 1GHz

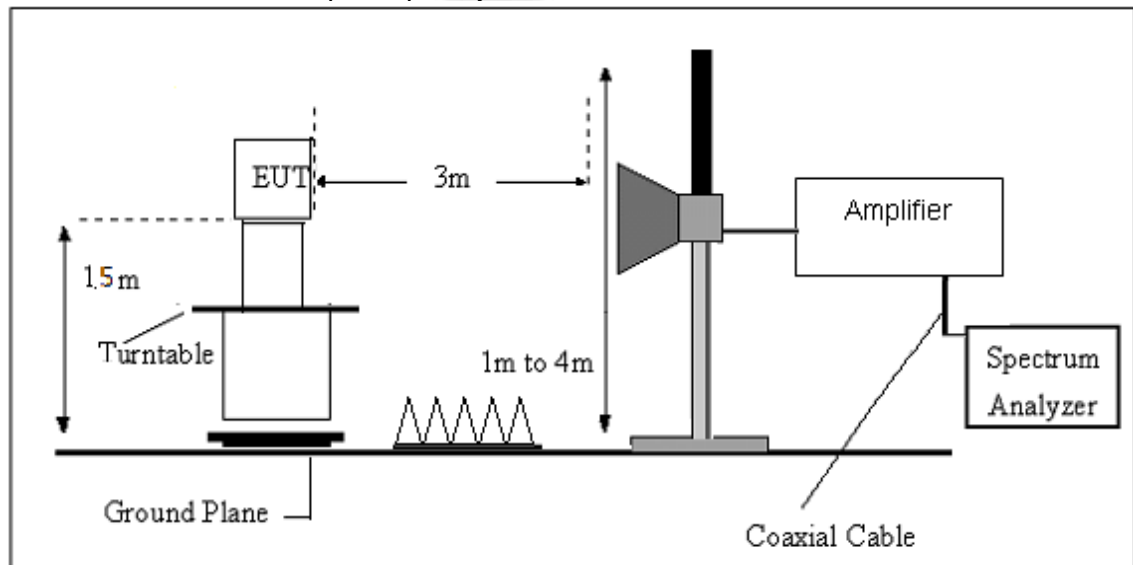



3.2.4 EUT OPERATING CONDITIONS

The EUT tested system was configured as the statements of 2.4 Unless otherwise a special operating condition is specified in the follows during the testing.

3.2.5 FIELD STRENGTH CALCULATION

The field strength is calculated by adding the Antenna Factor and Cable Factor and subtracting the Amplifier Gain and Duty Cycle Correction Factor (if any) from the measured reading. The basic equation with a sample calculation is as follows:

$$FS = RA + AF + CL - AG$$

Where

FS = Field Strength

CL = Cable Attenuation Factor (Cable Loss)

RA = Reading Amplitude

AG = Amplifier Gain

AF = Antenna Factor

For example

Frequency (MHz)	FS (dB μ V/m)	RA (dB μ V/m)	AF (dB)	CL (dB)	AG (dB)	Factor (dB)
300	40	58.1	12.2	1.6	31.9	-18.1

$$\text{Factor} = \text{AF} + \text{CL} - \text{AG}$$

**3.2.6 TEST RESULTS (Between 9KHz – 30 MHz)**

Temperature:	23.1(C)	Relative Humidity:	60%RH
Test Voltage :	DC 3.8V	Polarization :	--
Test Mode :	TX Mode		

Freq. (MHz)	Reading (dBuV/m)	Limit (dBuV/m)	Margin (dB)	State P/F
--	--	--	--	PASS
--	--	--	--	PASS

Note:

The amplitude of spurious emissions which are attenuated by more than 20dB below the permissible value has no need to be reported.

Distance extrapolation factor = $40 \log(\text{specific distance}/\text{test distance})$ (dB);

Limit line = specific limits(dBuv) + distance extrapolation factor.



3.2.7 TEST RESULTS (Between 30MHz – 1GHz)

Temperature	23.1(C)	Relative Humidity:	60%RH
Test Voltage	DC 3.8V	Polarization:	Horizontal
Test Mode	Mode 1~12(Mode 12 worst mode)		

No.	Frequency (MHz)	Reading (dBuV)	Correct Factor(dB/m)	Result (dBuV/m)	Limit (dBuV/m)	Margin (dB)	Remark
1	171.6200	36.35	-19.87	16.48	43.50	-27.02	QP
2	397.6300	29.88	-11.24	18.64	46.00	-27.36	QP
3	614.9100	27.37	-5.49	21.88	46.00	-24.12	QP
4	733.2500	27.88	-2.35	25.53	46.00	-20.47	QP
5	894.2700	27.11	-0.59	26.52	46.00	-19.48	QP
6	978.6600	27.19	2.58	29.77	54.00	-24.23	QP

Remark:

1. Margin = Result (Result =Reading + Factor)–Limit

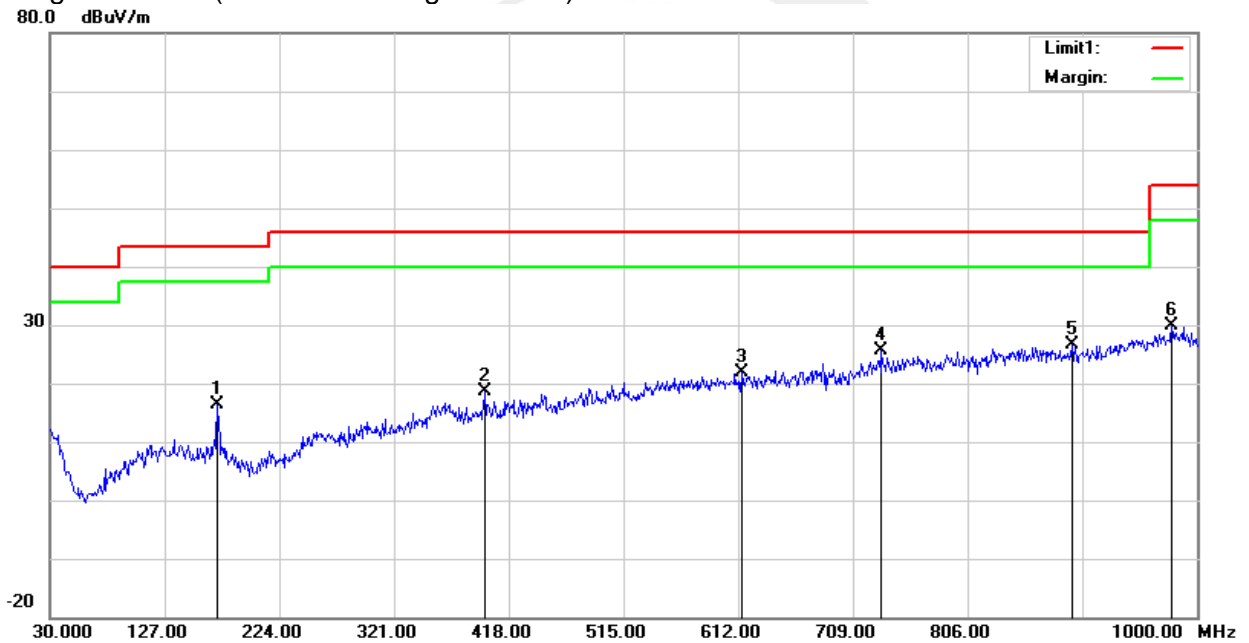



Temperature	23.1(C)	Relative Humidity:	60%RH
Test Voltage	DC 3.8V	Polarization:	Vertical
Test Mode	Mode 1~12(Mode 12 worst mode)		

No.	Frequency (MHz)	Reading (dBuV)	Correct Factor(dB/m)	Result (dBuV/m)	Limit (dBuV/m)	Margin (dB)	Remark
1	179.3800	30.99	-20.02	10.97	43.50	-32.53	QP
2	410.2400	27.36	-10.55	16.81	46.00	-29.19	QP
3	478.1400	28.11	-8.71	19.40	46.00	-26.60	QP
4	644.9800	28.37	-4.87	23.50	46.00	-22.50	QP
5	868.0800	27.07	-0.51	26.56	46.00	-19.44	QP
6	976.7200	26.51	2.45	28.96	54.00	-25.04	QP

Remark:

1. Margin = Result (Result =Reading + Factor)–Limit

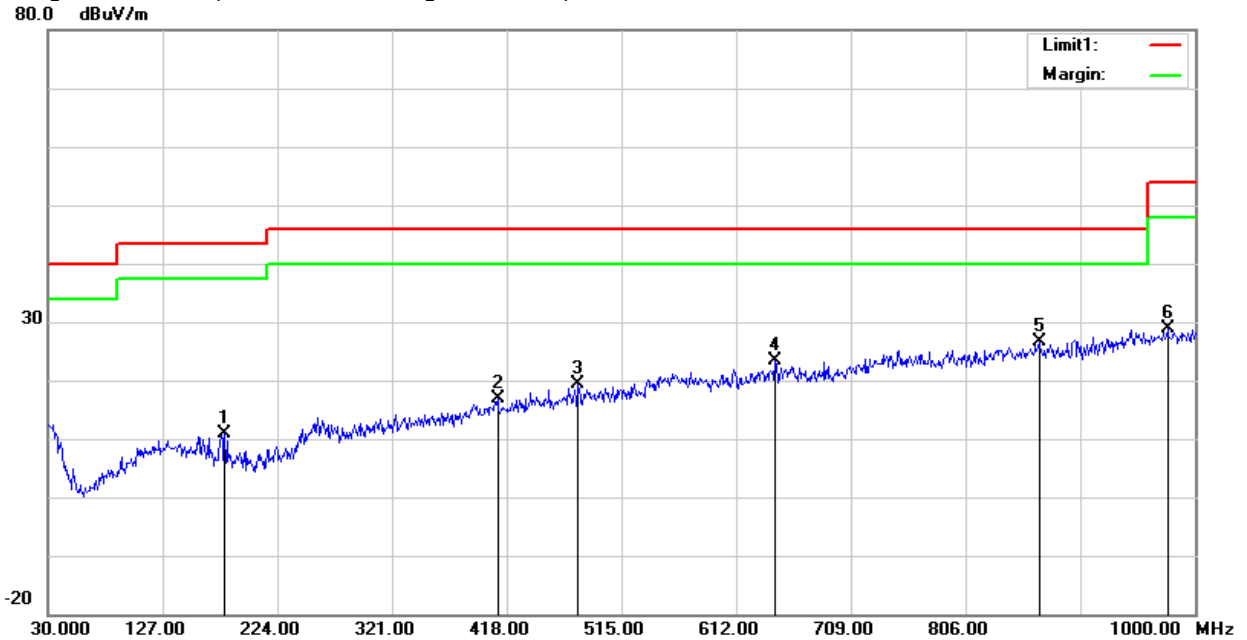



3.2.8 TEST RESULTS (Above 1000 MHz)

Band I 5150-5250MHz

Frequency (MHz)	Reading (dBuV)	Amplifier (dB)	Loss (dB)	Antenna Factor (dB/m)	Orrected Factor (dB)	Emission Level (dBμV/m)	Limit (dBuV/m)	Margin (dB)	Detector	Comment
Low Channel (802.11ac80/ 5210 MHz)										
3284.76	41.25	44.70	6.70	28.20	-9.80	31.45	68.20	-36.75	Pk	Vertical
3283.63	45.15	44.70	6.70	28.20	-9.80	35.35	54.00	-18.65	AV	Vertical
3283.63	41.49	44.70	6.70	28.20	-9.80	31.69	68.20	-36.51	Pk	Horizontal
4031.63	40.08	44.70	6.70	28.20	-9.80	30.28	54.00	-23.72	AV	Horizontal
4031.63	36.54	44.20	7.90	29.70	-6.60	29.94	68.20	-38.26	Pk	Vertical
4042.06	39.90	44.20	7.90	29.70	-6.60	33.30	54.00	-20.70	AV	Vertical
4042.06	35.81	44.20	7.90	29.70	-6.60	29.21	68.20	-38.99	Pk	Horizontal
7305.51	36.54	44.20	7.90	29.70	-6.60	29.94	54.00	-24.06	AV	Horizontal
7305.51	33.91	43.50	11.40	35.50	3.40	37.31	68.20	-30.89	Pk	Vertical
7311.02	37.33	43.50	11.40	35.50	3.40	40.73	54.00	-13.27	AV	Vertical
7311.02	33.60	43.50	11.40	35.50	3.40	37.00	68.20	-31.20	Pk	Horizontal
10480.56	39.05	43.50	11.40	35.50	3.40	42.45	54.00	-11.55	AV	Horizontal
10480.56	36.64	44.50	13.80	38.80	8.10	44.74	68.20	-23.46	Pk	Vertical
10480.41	40.02	44.50	13.80	38.80	8.10	48.12	54.00	-5.88	AV	Vertical
10480.41	35.82	44.50	13.80	38.80	8.10	43.92	68.20	-24.28	Pk	Horizontal
11153.24	33.35	44.50	13.80	38.80	8.10	41.45	54.00	-12.55	AV	Horizontal
11153.24	30.13	43.60	14.30	39.50	10.20	40.33	68.20	-27.87	Pk	Vertical
11157.10	33.55	43.60	14.30	39.50	10.20	43.75	54.00	-10.25	AV	Vertical
11157.10	30.40	43.60	14.30	39.50	10.20	40.60	68.20	-27.60	Pk	Horizontal
13437.84	32.81	43.60	14.30	39.50	10.20	43.01	54.00	-10.99	AV	Horizontal
13437.84	28.77	42.60	15.90	38.90	12.20	40.97	68.20	-27.23	Pk	Vertical
13436.17	31.63	42.60	15.90	38.90	12.20	43.83	54.00	-10.17	AV	Vertical
13436.17	30.02	42.60	15.90	38.90	12.20	42.22	68.20	-25.98	Pk	Horizontal
13388.26	29.61	42.60	15.90	38.90	12.20	41.81	54.00	-12.19	AV	Horizontal

Remark:

- Factor = Antenna Factor + Cable Loss – Pre-amplifier.
- Scan with 802.11a,802.11n (HT-20),802.11n (HT-40), 802.11ac (VHT-20),802.11ac (VHT-40), 802.11ac (VHT-80) the worst case is 802.11ac (VHT-80).
- The frequency emission of peak points that did not show above the forms are at least 20dB below the limit, the frequency emission is mainly from the environment noise.



Band IV(5.725-5.850) GHz

Frequency (MHz)	Reading	Amplifier	Loss	Antenna Factor	Orrected Factor	Emission Level	Limit (dBuV/m)	Margin	Detector	Comment
	(dBuV)	(dB)	(dB)	(dB/m)	(dB)	(dBuV/m)		(dB)		
Low Channel (802.11ac80/ 5775 MHz)										
3271.45	44.69	44.70	6.70	28.20	-9.80	34.89	68.20	-33.31	Pk	Vertical
3271.45	40.98	44.70	6.70	28.20	-9.80	31.18	54.00	-22.82	AV	Vertical
3278.10	44.55	44.70	6.70	28.20	-9.80	34.75	68.20	-33.45	Pk	Horizontal
3278.10	41.44	44.70	6.70	28.20	-9.80	31.64	54.00	-22.36	AV	Horizontal
4008.42	39.22	44.20	7.90	29.70	-6.60	32.62	68.20	-35.58	Pk	Vertical
4008.42	35.81	44.20	7.90	29.70	-6.60	29.21	54.00	-24.79	AV	Vertical
4017.32	38.98	44.20	7.90	29.70	-6.60	32.38	68.20	-35.82	Pk	Horizontal
4017.32	36.77	44.20	7.90	29.70	-6.60	30.17	54.00	-23.83	AV	Horizontal
7265.73	36.45	43.50	11.40	35.50	3.40	39.85	68.20	-28.35	Pk	Vertical
7265.73	34.77	43.50	11.40	35.50	3.40	38.17	54.00	-15.83	AV	Vertical
7268.69	37.91	43.50	11.40	35.50	3.40	41.31	68.20	-26.89	Pk	Horizontal
7268.69	34.88	43.50	11.40	35.50	3.40	38.28	54.00	-15.72	AV	Horizontal
10567.42	39.30	44.50	13.90	38.80	8.20	47.50	68.20	-20.70	Pk	Vertical
10567.42	35.77	44.50	13.90	38.80	8.20	43.97	54.00	-10.03	AV	Vertical
10572.30	39.29	44.50	13.90	38.80	8.20	47.49	68.20	-20.71	Pk	Horizontal
10572.30	37.17	44.50	13.90	38.80	8.20	45.37	54.00	-8.63	AV	Horizontal
11550.17	34.07	43.60	14.30	39.50	10.20	44.27	68.20	-23.93	Pk	Vertical
11550.17	29.93	43.60	14.30	39.50	10.20	40.13	54.00	-13.87	AV	Vertical
11550.26	33.98	43.60	14.30	39.50	10.20	44.18	68.20	-24.02	Pk	Horizontal
11550.26	31.02	43.60	14.30	39.50	10.20	41.22	54.00	-12.78	AV	Horizontal
13349.43	32.33	42.60	15.90	38.90	12.20	44.53	68.20	-23.67	Pk	Vertical
13349.43	29.58	42.60	15.90	38.90	12.20	41.78	54.00	-12.22	AV	Vertical
13367.33	32.46	42.60	15.90	38.90	12.20	44.66	68.20	-23.54	Pk	Horizontal
13367.33	29.46	42.60	15.90	38.90	12.20	41.66	54.00	-12.34	AV	Horizontal

Remark:

- Factor = Antenna Factor + Cable Loss – Pre-amplifier.
- Scan with 802.11a,802.11n (HT-20),802.11n (HT-40), 802.11ac (VHT-20),802.11ac (VHT-40), 802.11ac (VHT-80) the worst case is 802.11ac (VHT-80).
- The frequency emission of peak points that did not show above the forms are at least 20dB below the limit, the frequency emission is mainly from the environment noise.



3.2.9 RESTRICTED FREQUENCY BANDS AND BAND EDGE

Band I 5150-5250MHz

802.11a-L-H

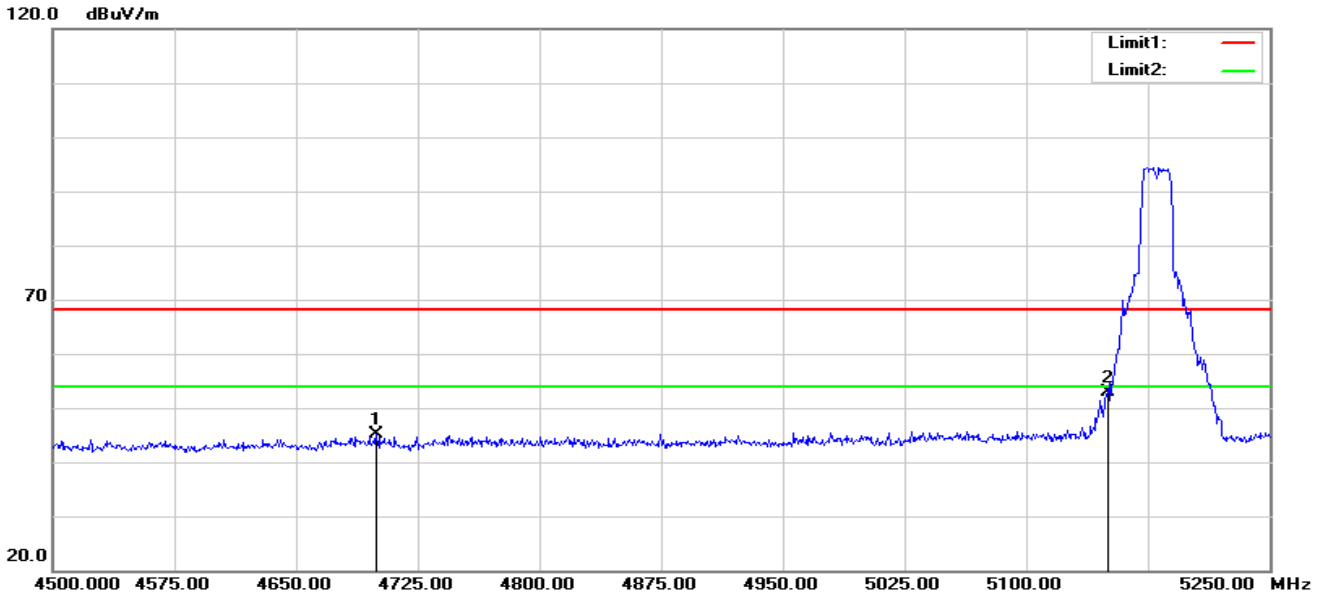

No.	Frequency (MHz)	Reading (dBuV)	Correct Factor(dB/m)	Result (dBuV/m)	Limit (dBuV/m)	Margin (dB)	Remark
1	4699.500	52.38	-7.36	45.02	68.20	-23.18	peak
2	5150.000	58.66	-5.73	52.93	68.20	-15.27	peak

802.11a-L-V

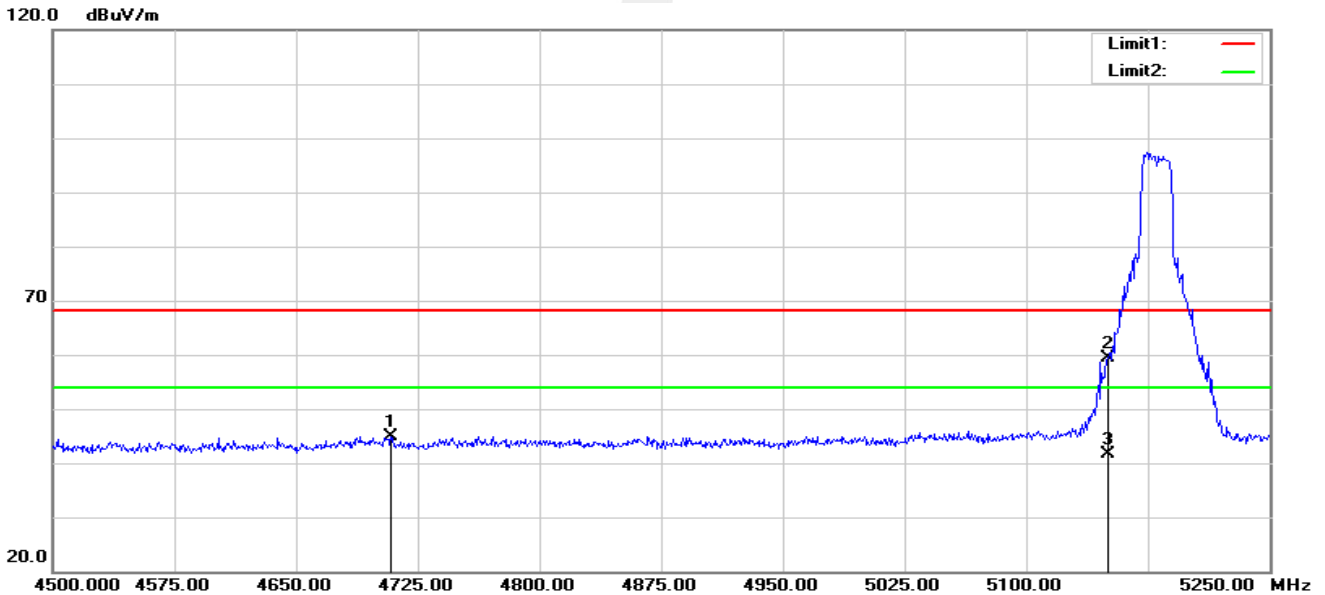

No.	Frequency (MHz)	Reading (dBuV)	Correct Factor(dB/m)	Result (dBuV/m)	Limit (dBuV/m)	Margin (dB)	Remark
1	4708.500	52.33	-7.35	44.98	68.20	-23.22	peak
2	5150.000	65.03	-5.73	59.30	68.20	-8.90	peak
3	5150.000	47.44	-5.73	41.71	54.00	-12.29	AVG



802.11a-H-H

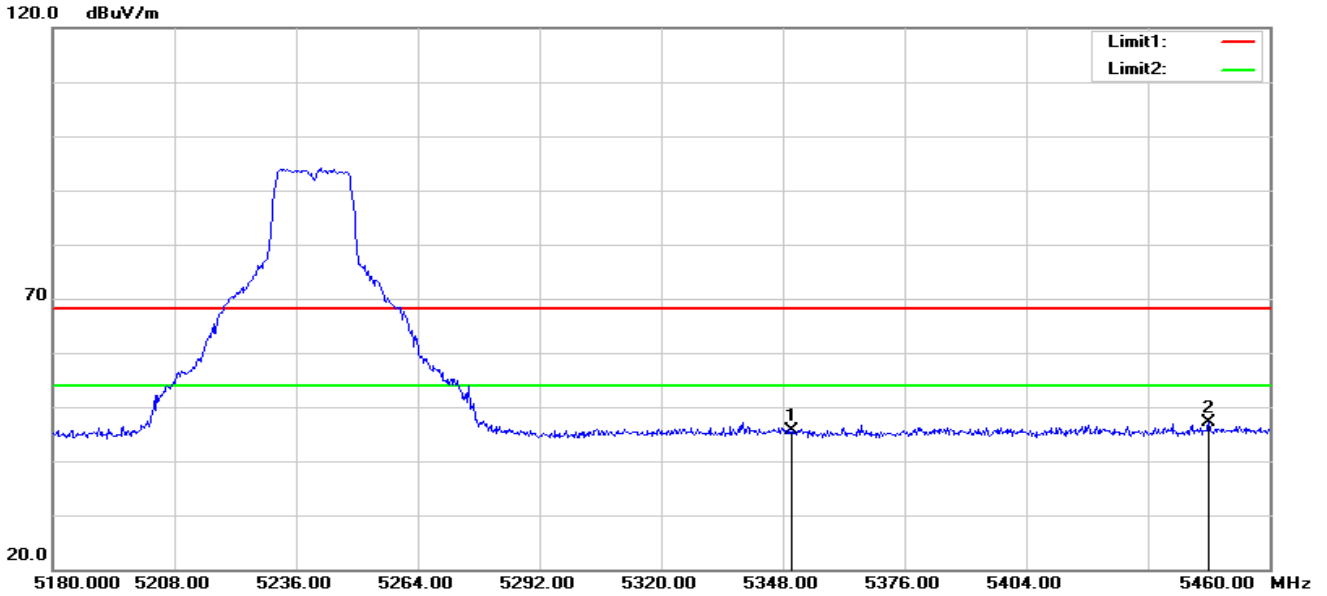

No.	Frequency (MHz)	Reading (dBuV)	Correct Factor(dB/m)	Result (dBuV/m)	Limit (dBuV/m)	Margin (dB)	Remark
1	5350.000	50.83	-5.23	45.60	68.20	-22.60	peak
2	5446.000	52.22	-5.14	47.08	68.20	-21.12	peak

802.11a-H-V

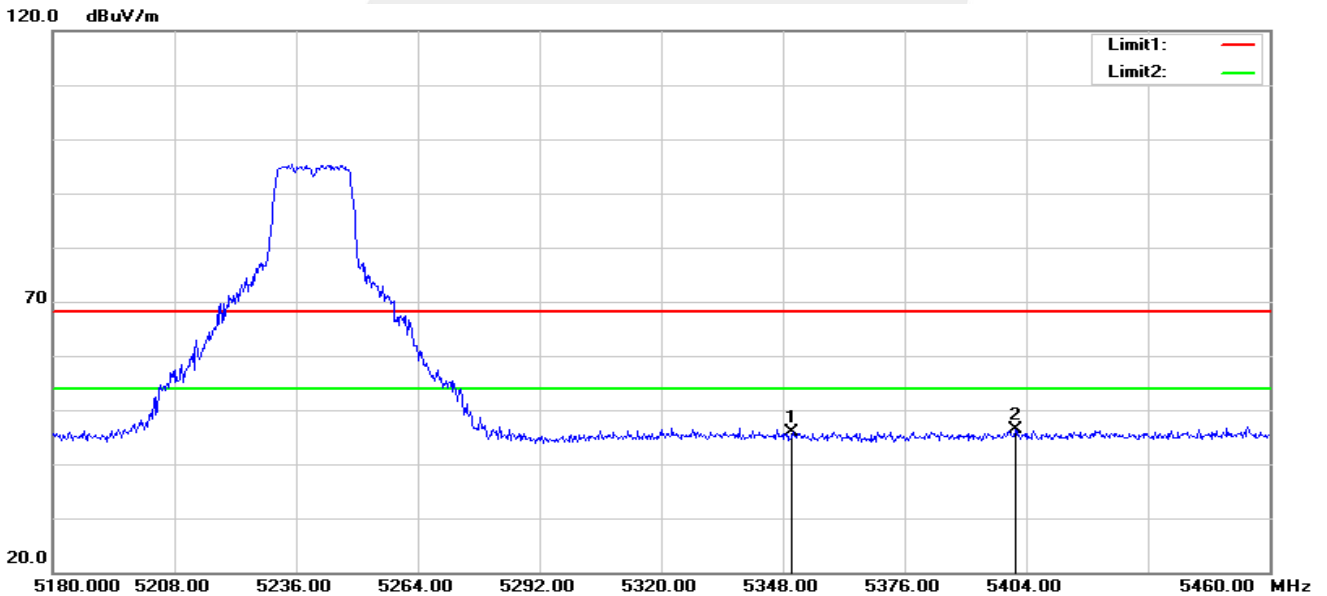

No.	Frequency (MHz)	Reading (dBuV)	Correct Factor(dB/m)	Result (dBuV/m)	Limit (dBuV/m)	Margin (dB)	Remark
1	5350.000	51.18	-5.23	45.95	68.20	-22.25	peak
2	5401.480	51.58	-5.25	46.33	68.20	-21.87	peak



802.11n40-L-H

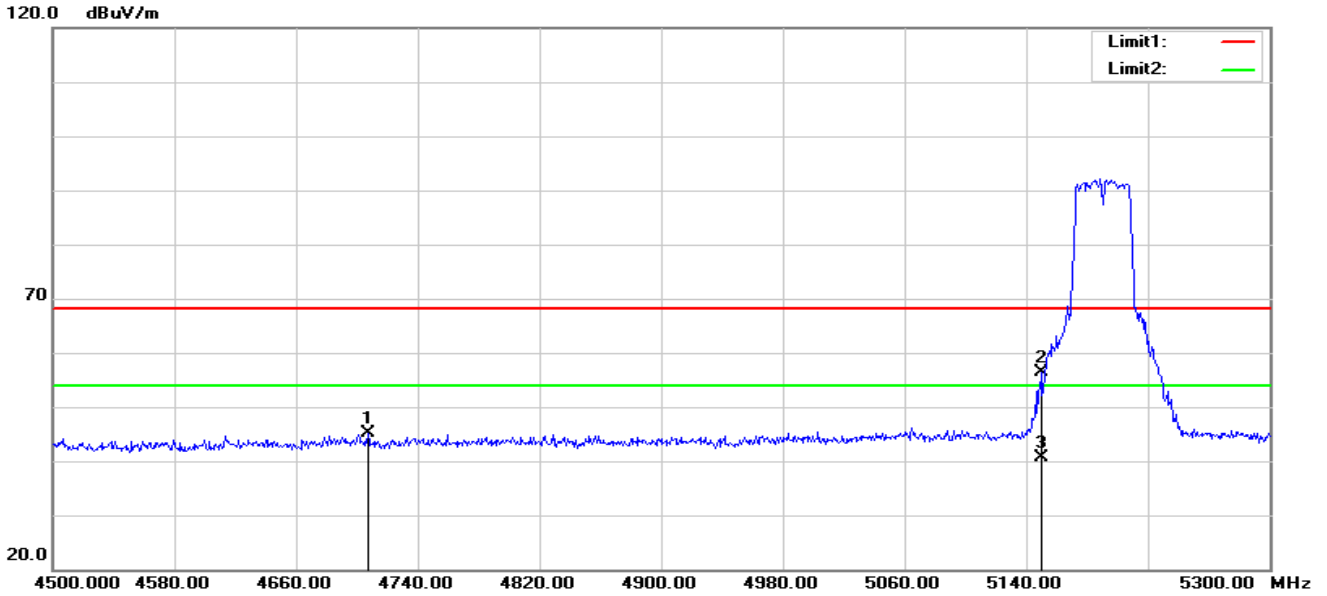

No.	Frequency (MHz)	Reading (dBuV)	Correct Factor(dB/m)	Result (dBuV/m)	Limit (dBuV/m)	Margin (dB)	Remark
1	4707.200	52.44	-7.35	45.09	68.20	-23.11	peak
2	5150.000	62.01	-5.73	56.28	68.20	-11.92	peak
3	5150.000	46.29	-5.73	40.56	54.00	-13.44	AVG

802.11n40-L-V

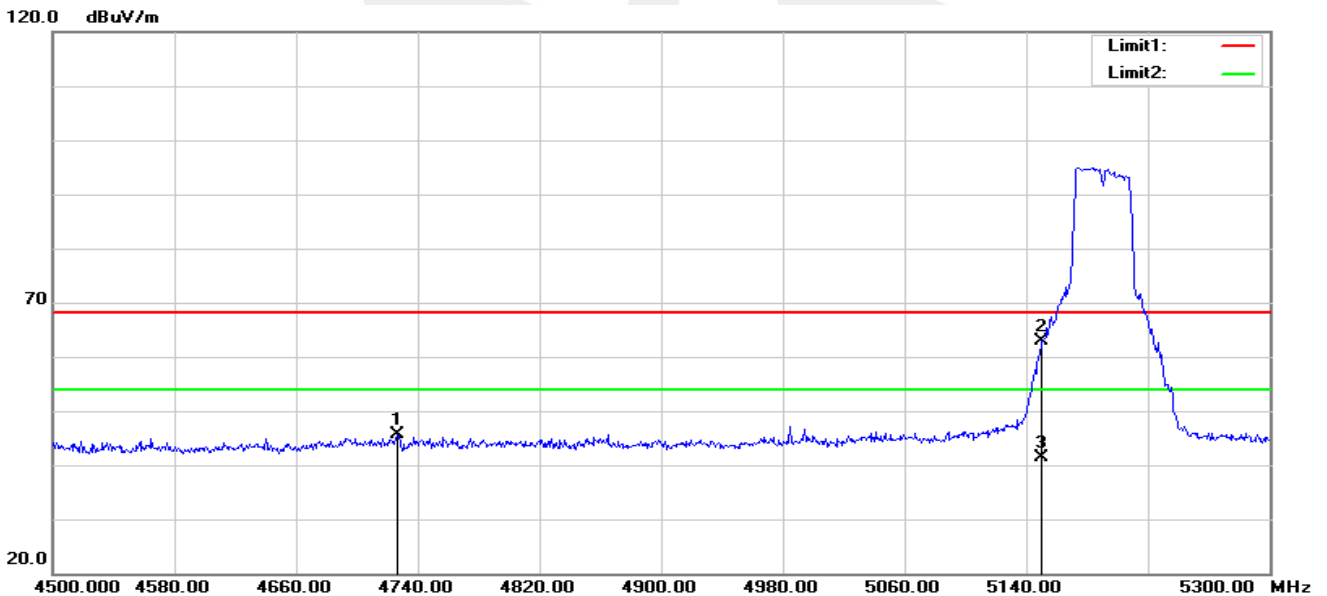

No.	Frequency (MHz)	Reading (dBuV)	Correct Factor(dB/m)	Result (dBuV/m)	Limit (dBuV/m)	Margin (dB)	Remark
1	4726.400	53.05	-7.33	45.72	68.20	-22.48	peak
2	5150.000	68.56	-5.73	62.83	68.20	-5.37	peak
3	5150.000	47.18	-5.73	41.45	54.00	-12.55	AVG



802.11n40-H-H

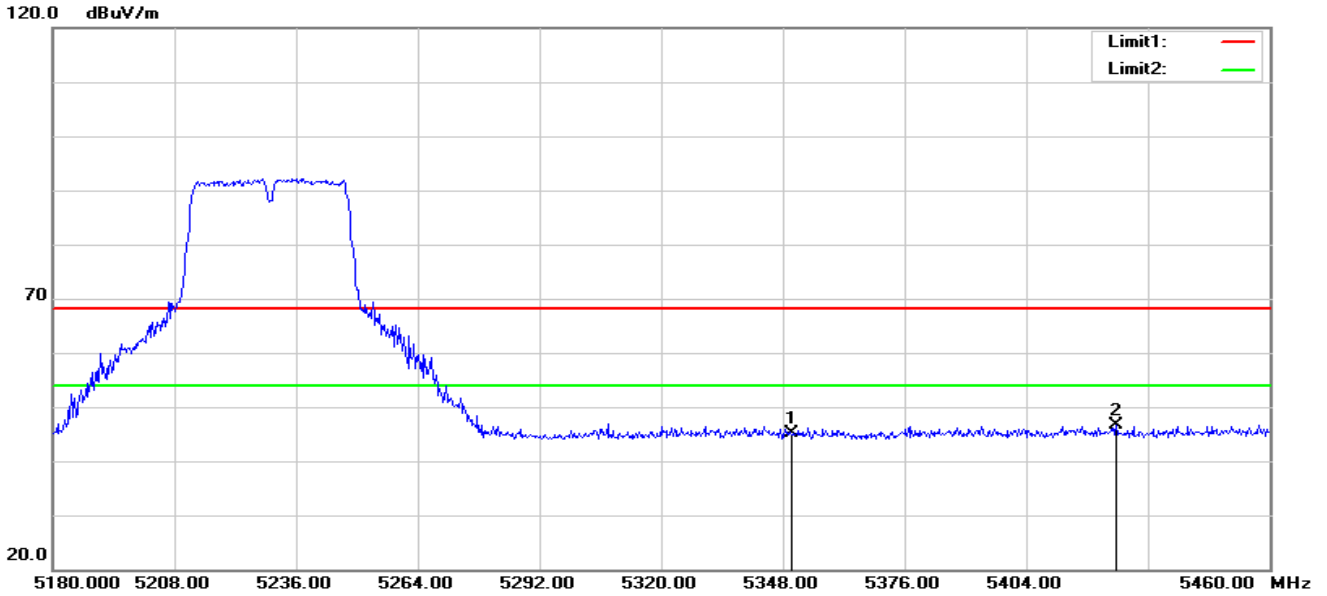

No.	Frequency (MHz)	Reading (dBuV)	Correct Factor(dB/m)	Result (dBuV/m)	Limit (dBuV/m)	Margin (dB)	Remark
1	5350.000	50.24	-5.23	45.01	68.20	-23.19	peak
2	5424.720	51.93	-5.19	46.74	68.20	-21.46	peak

802.11n40-H-V

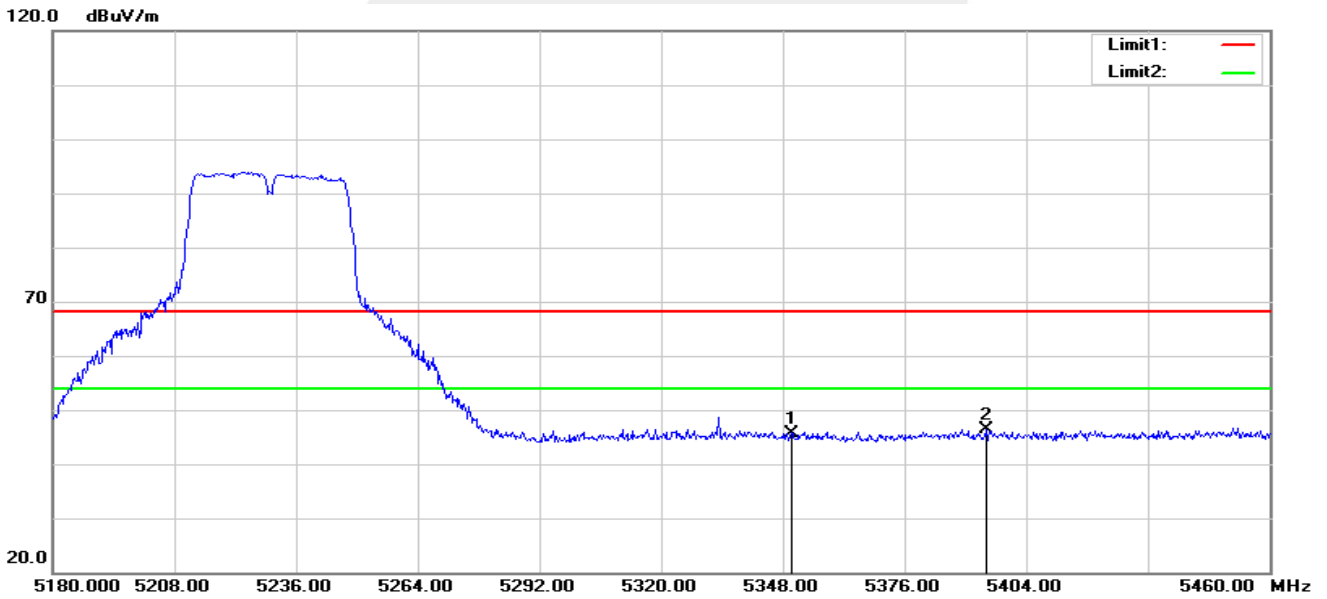

No.	Frequency (MHz)	Reading (dBuV)	Correct Factor(dB/m)	Result (dBuV/m)	Limit (dBuV/m)	Margin (dB)	Remark
1	5350.000	50.84	-5.23	45.61	68.20	-22.59	peak
2	5394.760	51.57	-5.24	46.33	68.20	-21.87	peak



802.11ac80-L-H

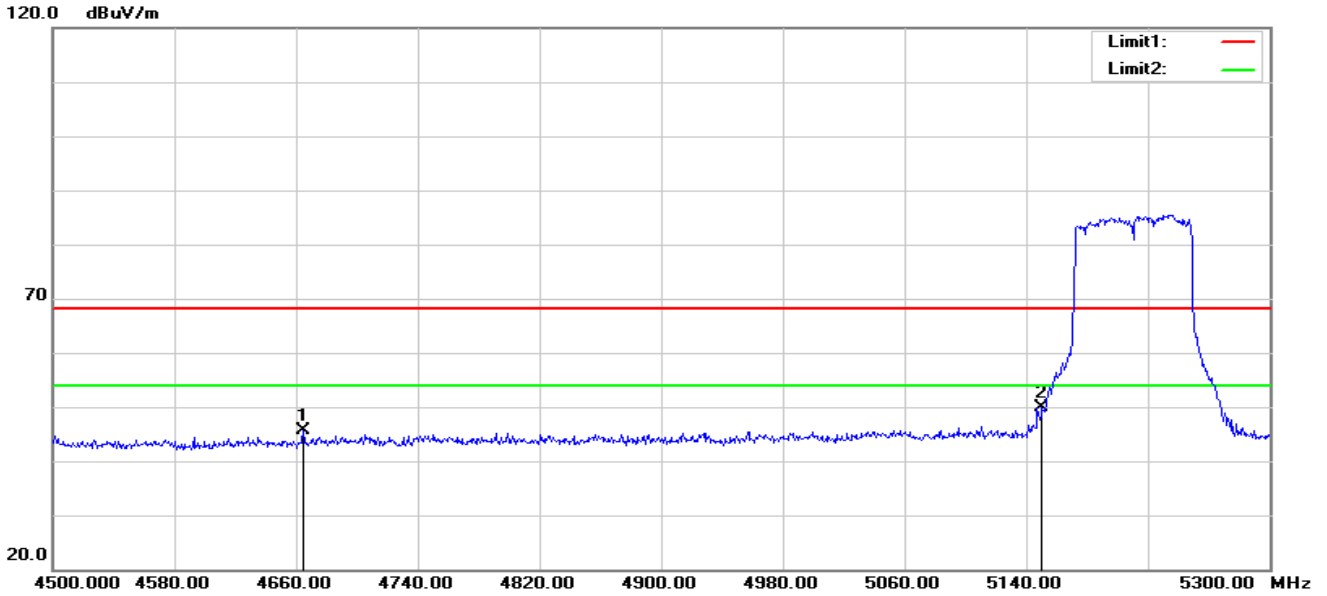

No.	Frequency (MHz)	Reading (dBuV)	Correct Factor(dB/m)	Result (dBuV/m)	Limit (dBuV/m)	Margin (dB)	Remark
1	4664.800	53.20	-7.54	45.66	68.20	-22.54	peak
2	5150.000	55.70	-5.73	49.97	68.20	-18.23	peak

802.11ac80-L-V

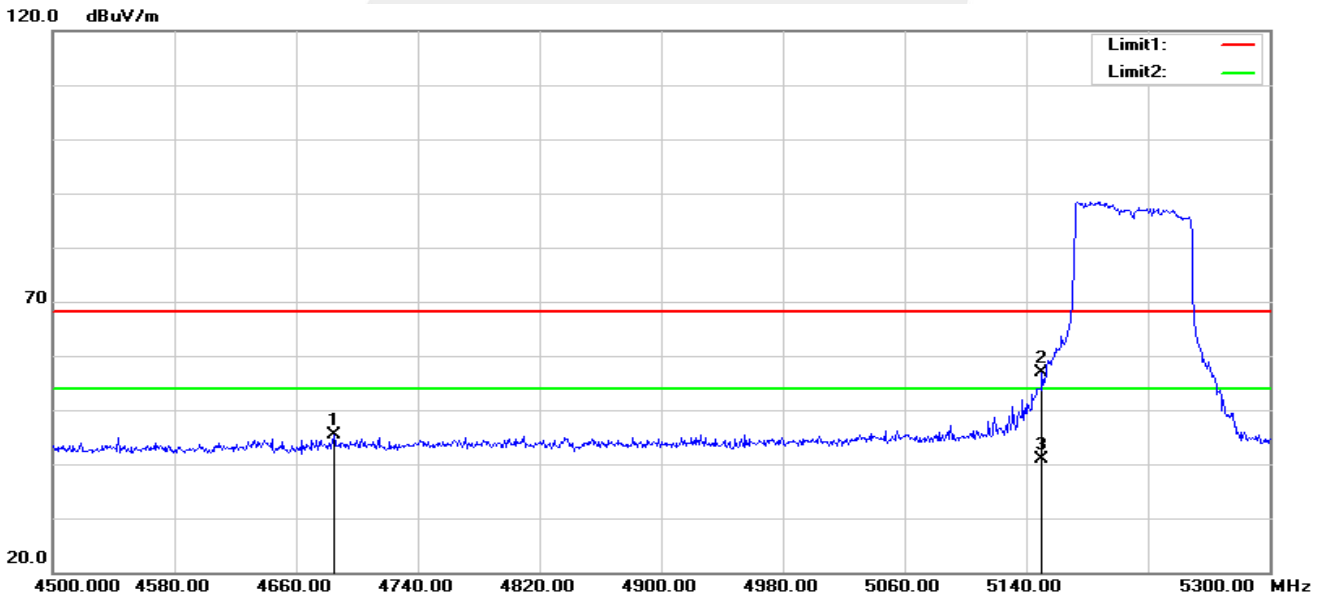

No.	Frequency (MHz)	Reading (dBuV)	Correct Factor(dB/m)	Result (dBuV/m)	Limit (dBuV/m)	Margin (dB)	Remark
1	4684.800	52.92	-7.44	45.48	68.20	-22.72	peak
2	5150.000	62.72	-5.73	56.99	68.20	-11.21	peak
3	5150.000	46.67	-5.73	40.94	54.00	-13.06	AVG



802.11ac80-H-H

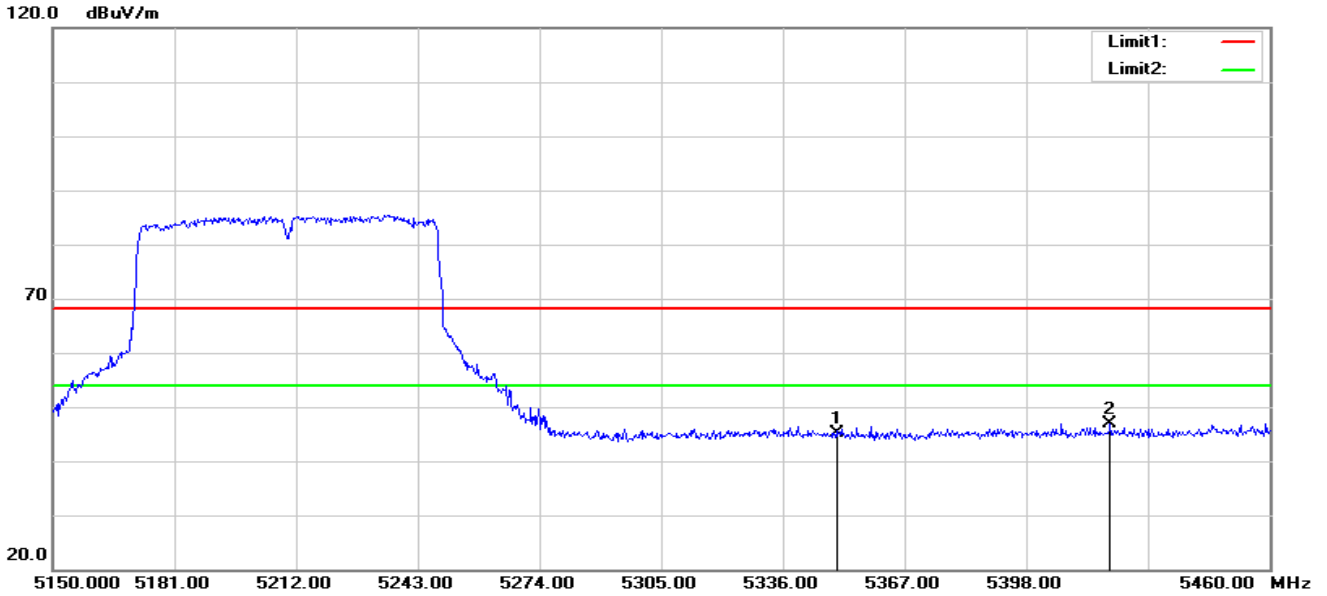

No.	Frequency (MHz)	Reading (dBuV)	Correct Factor(dB/m)	Result (dBuV/m)	Limit (dBuV/m)	Margin (dB)	Remark
1	5350.000	50.43	-5.23	45.20	68.20	-23.00	peak
2	5419.390	52.08	-5.20	46.88	68.20	-21.32	peak

802.11ac80-H-V

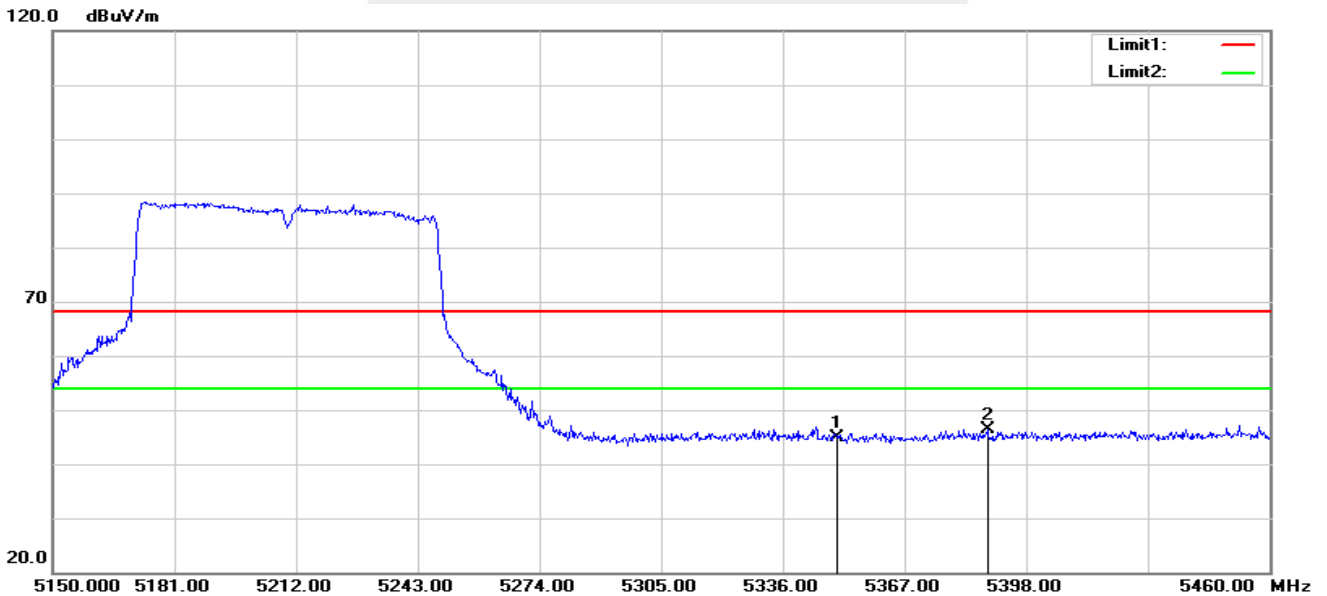

No.	Frequency (MHz)	Reading (dBuV)	Correct Factor(dB/m)	Result (dBuV/m)	Limit (dBuV/m)	Margin (dB)	Remark
1	5350.000	50.04	-5.23	44.81	68.20	-23.39	peak
2	5388.080	51.67	-5.25	46.42	68.20	-21.78	peak

Note: All modes have been tested. Only the worst mode shown in the report.



Band IV(5.725-5.85 GHz)

802.11a-L-H

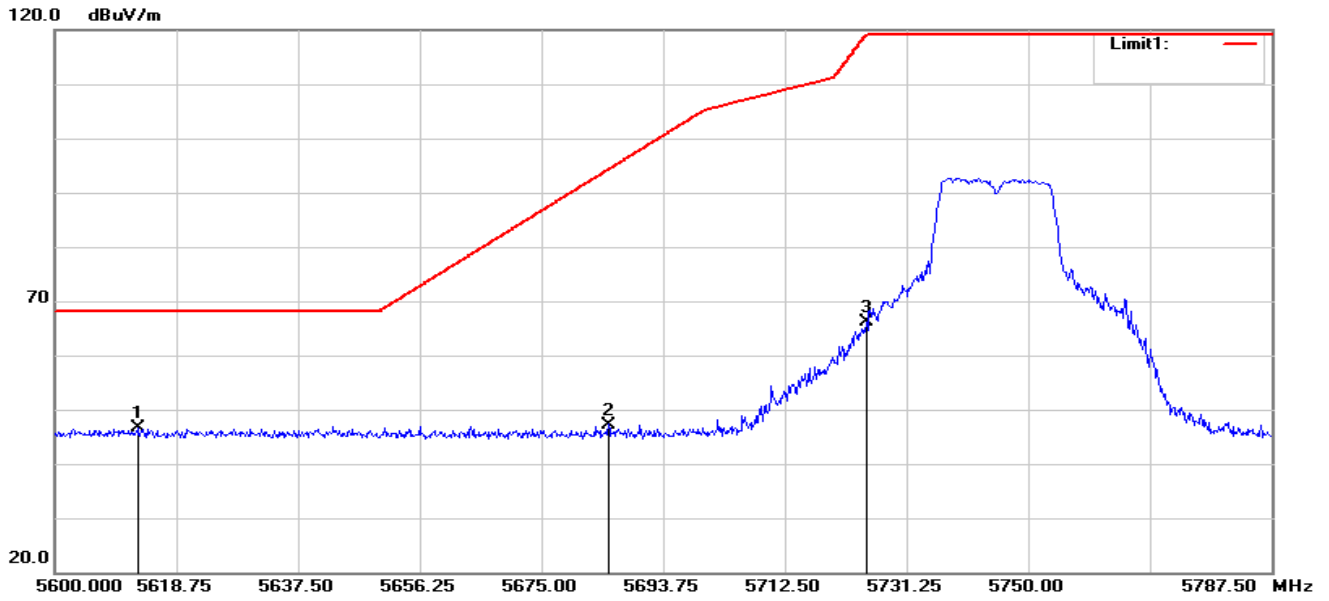

No.	Frequency (MHz)	Reading (dBuV)	Correct Factor(dB/m)	Result (dBuV/m)	Limit (dBuV/m)	Margin (dB)	Remark
1	5612.938	51.24	-4.70	46.54	68.20	-21.66	peak
2	5685.313	51.91	-4.66	47.25	94.33	-47.08	peak
3	5725.000	70.78	-4.57	66.21	119.20	-52.99	peak

802.11a-L-V

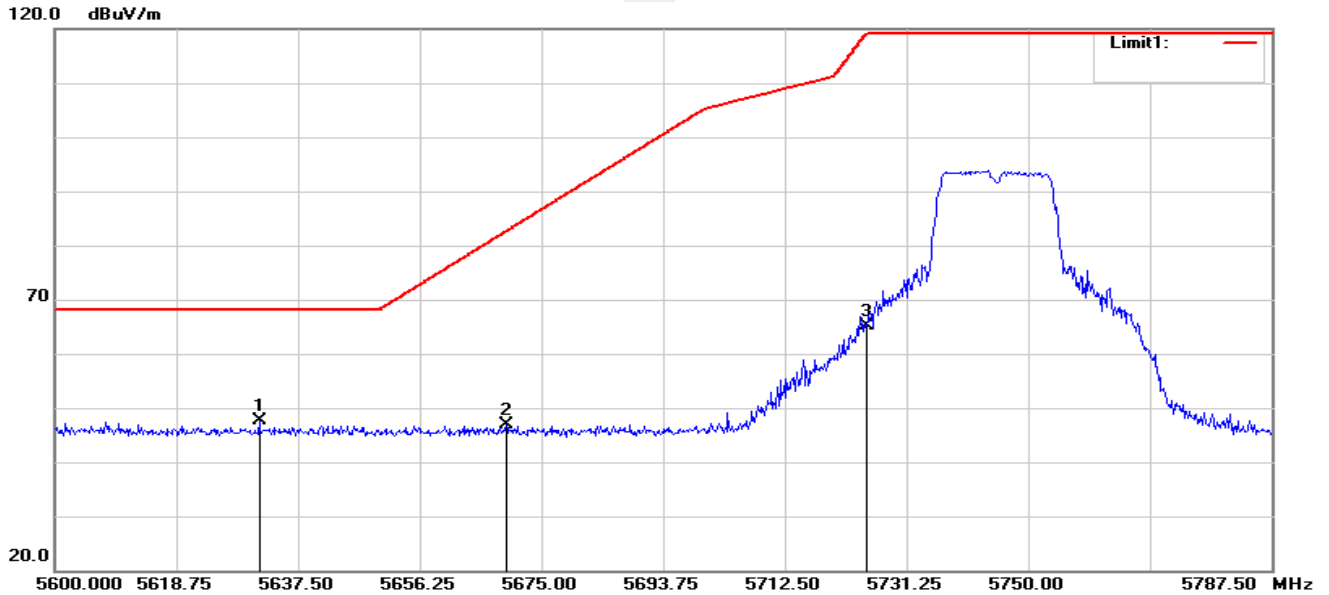

No.	Frequency (MHz)	Reading (dBuV)	Correct Factor(dB/m)	Result (dBuV/m)	Limit (dBuV/m)	Margin (dB)	Remark
1	5631.500	52.21	-4.69	47.52	68.20	-20.68	peak
2	5669.563	51.46	-4.67	46.79	82.68	-35.89	peak
3	5725.000	69.68	-4.57	65.11	119.20	-54.09	peak



802.11a-H-H

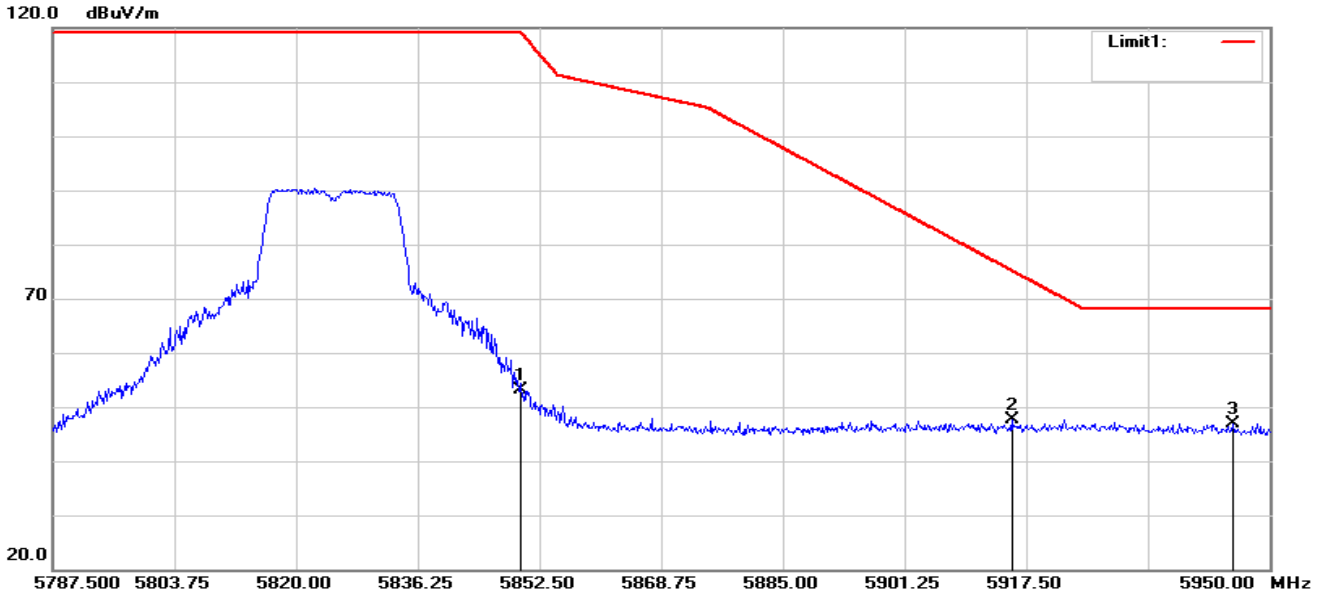

No.	Frequency (MHz)	Reading (dBuV)	Correct Factor(dB/m)	Result (dBuV/m)	Limit (dBuV/m)	Margin (dB)	Remark
1	5850.000	57.23	-4.10	53.13	119.20	-66.07	peak
2	5915.550	51.57	-3.91	47.66	75.19	-27.53	peak
3	5945.125	50.93	-3.96	46.97	68.20	-21.23	peak

802.11a-H-V

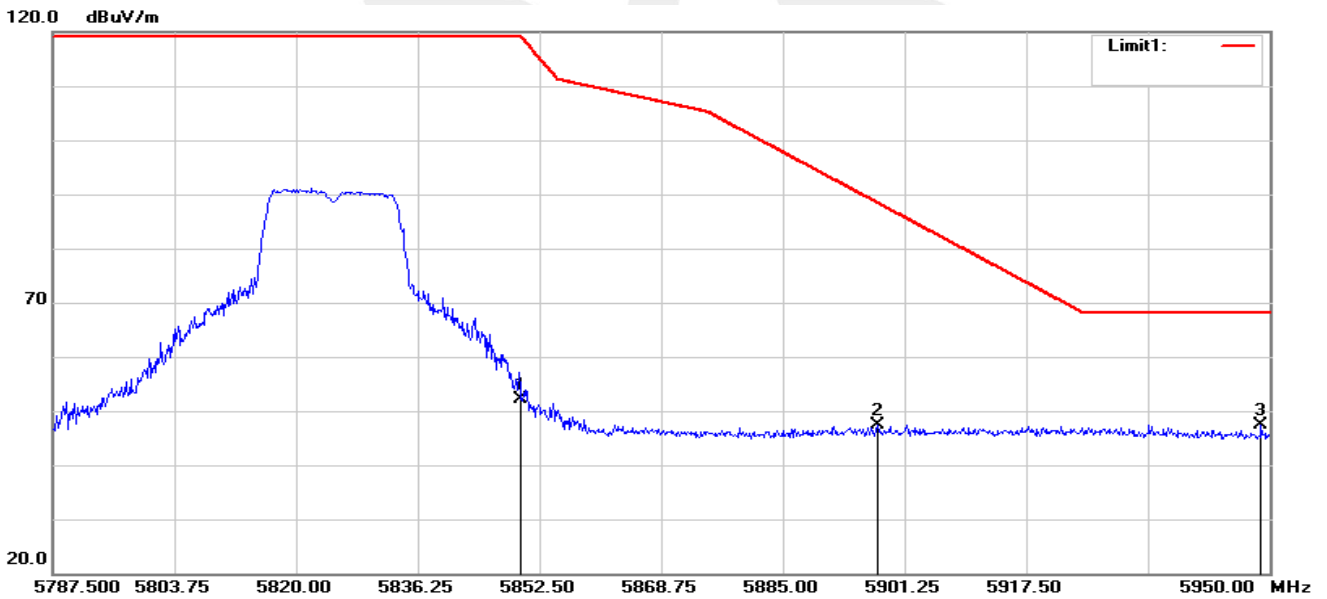

No.	Frequency (MHz)	Reading (dBuV)	Correct Factor(dB/m)	Result (dBuV/m)	Limit (dBuV/m)	Margin (dB)	Remark
1	5850.000	56.23	-4.10	52.13	119.20	-67.07	peak
2	5897.675	51.35	-3.89	47.46	88.42	-40.96	peak
3	5948.863	51.33	-3.96	47.37	68.20	-20.83	peak



802.11n40-L-H

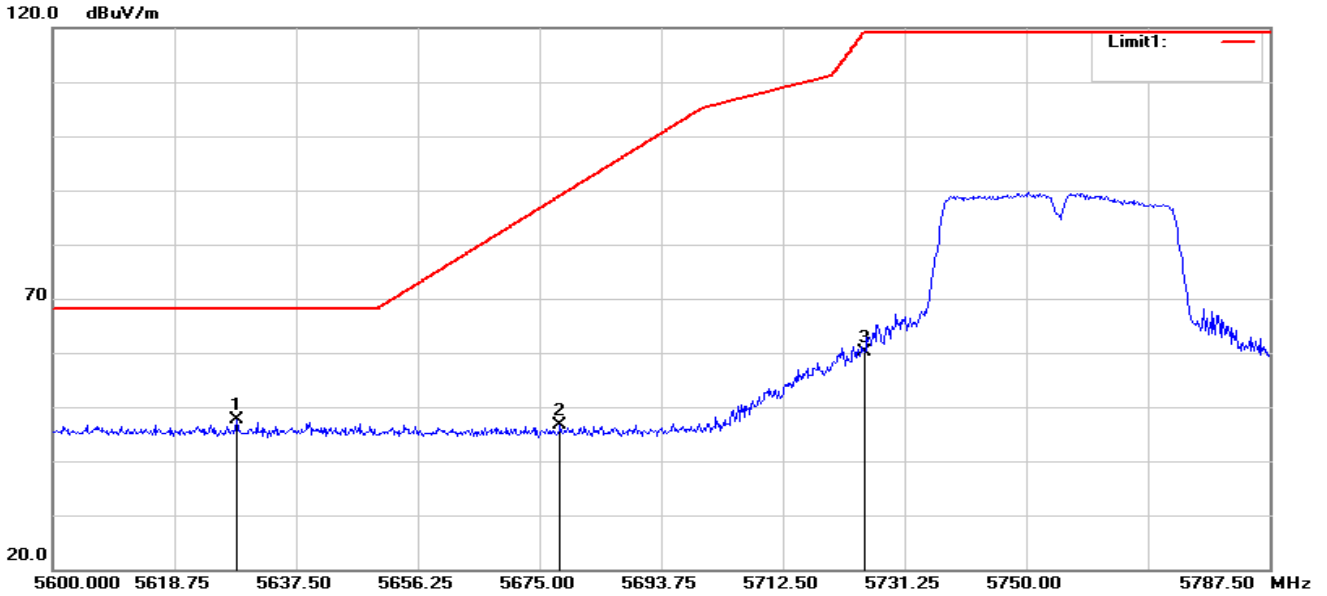

No.	Frequency (MHz)	Reading (dBuV)	Correct Factor(dB/m)	Result (dBuV/m)	Limit (dBuV/m)	Margin (dB)	Remark
1	5628.313	52.42	-4.68	47.74	68.20	-20.46	peak
2	5678.188	51.35	-4.66	46.69	89.06	-42.37	peak
3	5725.000	64.58	-4.57	60.01	119.20	-59.19	peak

802.11n40-L-V

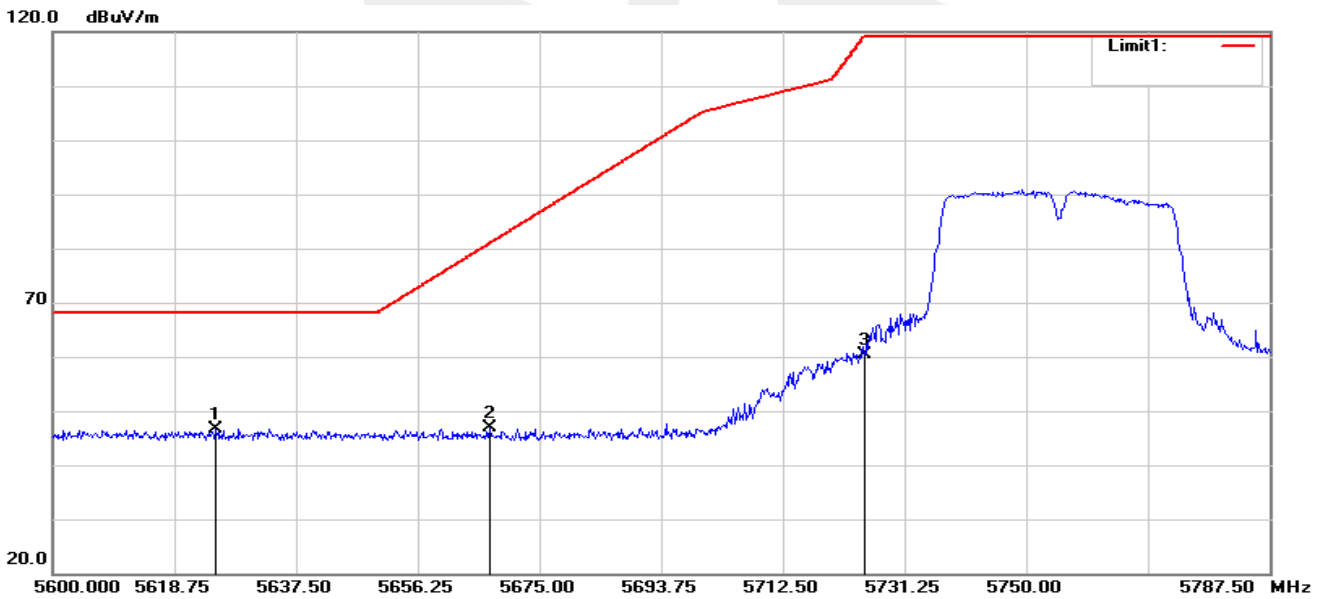

No.	Frequency (MHz)	Reading (dBuV)	Correct Factor(dB/m)	Result (dBuV/m)	Limit (dBuV/m)	Margin (dB)	Remark
1	5625.125	51.42	-4.69	46.73	68.20	-21.47	peak
2	5667.313	51.49	-4.67	46.82	81.01	-34.19	peak
3	5725.000	65.06	-4.57	60.49	119.20	-58.71	peak



802.11n40-H-H

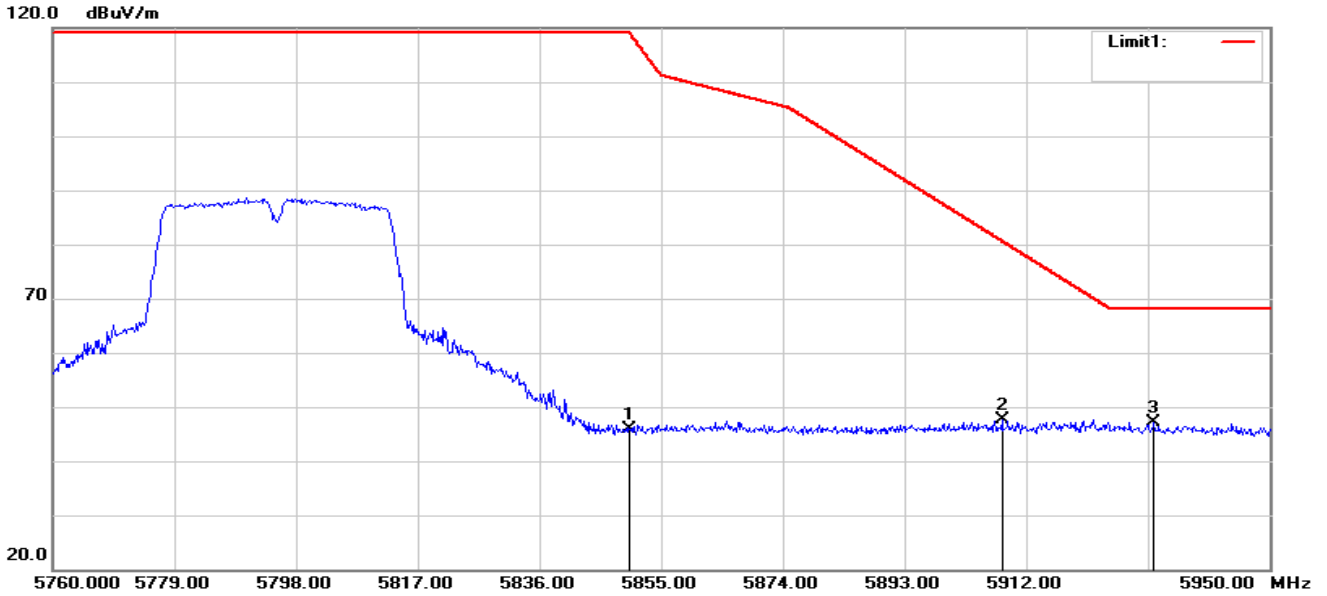

No.	Frequency (MHz)	Reading (dBuV)	Correct Factor(dB/m)	Result (dBuV/m)	Limit (dBuV/m)	Margin (dB)	Remark
1	5850.000	49.90	-4.10	45.80	119.20	-73.40	peak
2	5908.200	51.57	-3.90	47.67	80.63	-32.96	peak
3	5931.950	51.18	-3.94	47.24	68.20	-20.96	peak

802.11n40-H-V

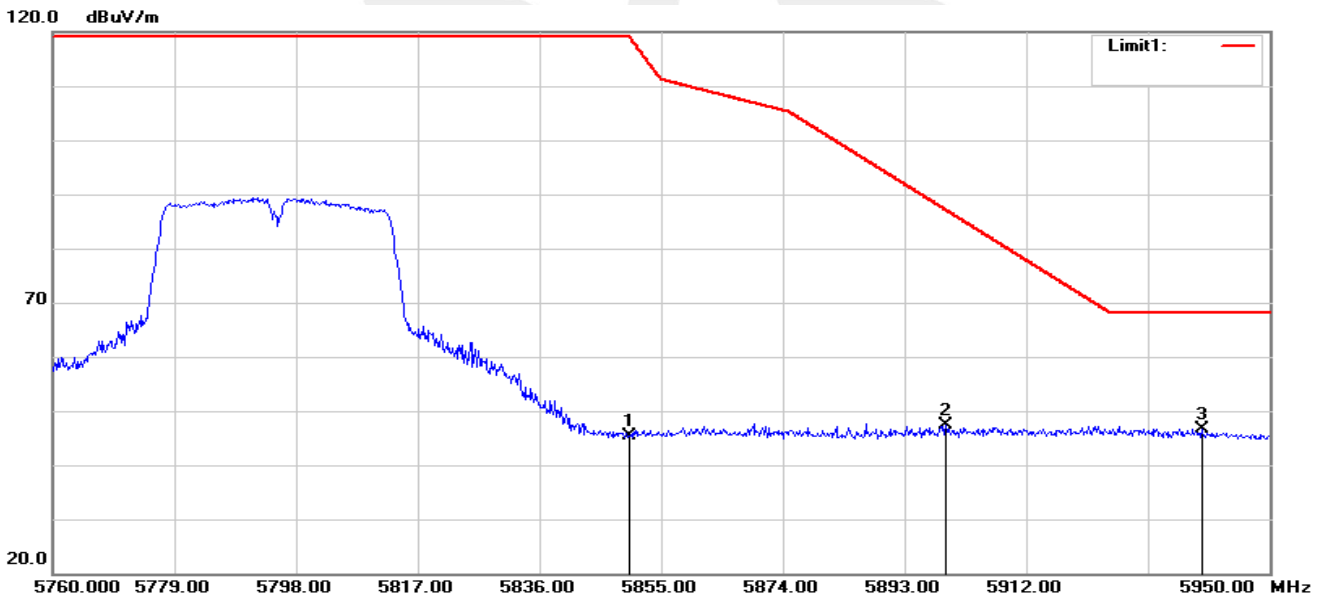

No.	Frequency (MHz)	Reading (dBuV)	Correct Factor(dB/m)	Result (dBuV/m)	Limit (dBuV/m)	Margin (dB)	Remark
1	5850.000	49.44	-4.10	45.34	119.20	-73.86	peak
2	5899.460	51.20	-3.88	47.32	87.10	-39.78	peak
3	5939.360	50.62	-3.95	46.67	68.20	-21.53	peak



802.11ac80-H

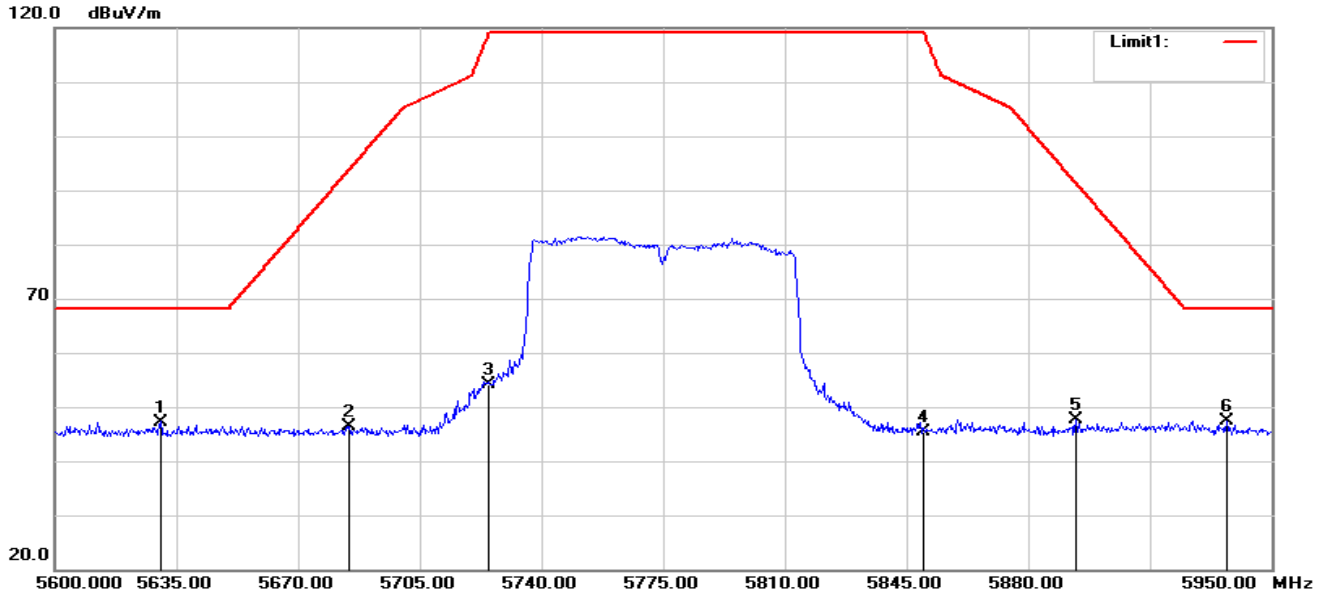

No.	Frequency (MHz)	Reading (dBuV)	Correct Factor(dB/m)	Result (dBuV/m)	Limit (dBuV/m)	Margin (dB)	Remark
1	5630.450	51.94	-4.69	47.25	68.20	-20.95	peak
2	5684.700	51.13	-4.66	46.47	93.88	-47.41	peak
3	5725.000	58.74	-4.57	54.17	119.20	-65.03	peak
4	5850.000	49.37	-4.10	45.27	119.20	-73.93	peak
5	5893.650	51.66	-3.91	47.75	91.40	-43.65	peak
6	5937.050	51.44	-3.94	47.50	68.20	-20.70	peak



802.11ac80-V

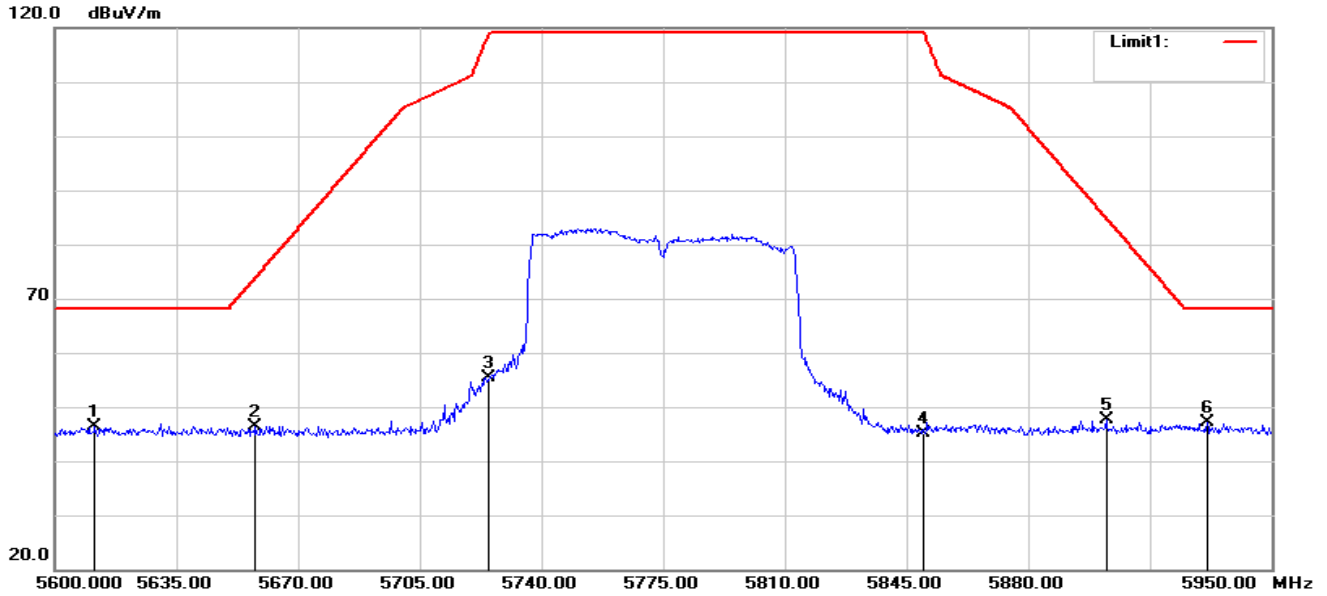

No.	Frequency (MHz)	Reading (dBuV)	Correct Factor(dB/m)	Result (dBuV/m)	Limit (dBuV/m)	Margin (dB)	Remark
1	5611.550	51.08	-4.69	46.39	68.20	-21.81	peak
2	5657.750	51.17	-4.68	46.49	73.94	-27.45	peak
3	5725.000	60.07	-4.57	55.50	119.20	-63.70	peak
4	5850.000	49.22	-4.10	45.12	119.20	-74.08	peak
5	5902.400	51.49	-3.89	47.60	84.92	-37.32	peak
6	5931.450	50.99	-3.93	47.06	68.20	-21.14	peak

Note: All modes have been tested. Only the worst mode shown in the report.



4. POWER SPECTRAL DENSITY TEST

4.1 LIMIT

1. For mobile and portable client devices in the 5.15-5.25 GHz band, , the maximum power spectral density shall not exceed 11 dBm in any 1 megahertz band. If transmitting antennas of directional gain greater than 6 dBi are used, both the maximum conducted output power and the maximum power spectral density shall be reduced by the amount in dB that the directional gain of the antenna exceeds 6 dBi.
2. For the 5.25-5.35 GHz and 5.47-5.725 GHz bands, the maximum power spectral density shall not exceed 11 dBm in any 1 megahertz band. If transmitting antennas of directional gain greater than 6 dBi are used, both the maximum conducted output power and the maximum power spectral density shall be reduced by the amount in dB that the directional gain of the antenna exceeds 6 dBi.
3. For the band 5.725-5.850 GHz, the peak power spectral density shall not exceed 30 dBm in any 500KHz band. If transmitting antenna directional gain is greater than 6 dBi, both the maximum conducted output power and the peak power spectral density shall be reduced by the amount in dB that the directional gain of the antenna exceeds 6 dBi.

4.2 TEST PROCEDURE

1. The setting follows Method SA-1 of FCC KDB D02 General UNII Test Procedures New Rules v01r03.

For devices operating in the band, the rules specify a measurement bandwidth of 500 kHz.

Many spectrum analyzers do not have 500 kHz RBW, thus a narrower RBW may need to be used.

The rules permit the use of a RBWs less than 1 MHz, or 500 kHz, "provided that the measured power is integrated over the full reference bandwidth" to show the total power over the specified measurement bandwidth (*i.e.*, 1 MHz, or 500 kHz). If measurements are performed using a reduced resolution bandwidth (< 1 MHz, or < 500 kHz) and integrated over 1 MHz, or 500 KHz bandwidth, the following adjustments to the procedures apply:

- a) Set $RBW \geq 1/T$, where T is defined in section II.B.I.a).
- b) Set $VBW \geq 3 RBW$.
- c) If measurement bandwidth of Maximum PSD is specified in 500 kHz, add $10 \log (500\text{kHz}/RBW)$ to the measured result, whereas $RBW (< 500 \text{ kHz})$ is the reduced resolution bandwidth of the spectrum analyzer set during measurement.
- d) If measurement bandwidth of Maximum PSD is specified in 1 MHz, add $10 \log (1\text{MHz}/RBW)$ to the measured result, whereas $RBW (< 1 \text{ MHz})$ is the reduced resolution bandwidth of spectrum analyzer set during measurement.
- e) Care must be taken to ensure that the measurements are performed during a period of continuous transmission or are corrected upward for duty cycle.

Note: As a practical matter, it is recommended to use reduced RBW of 100 kHz for the sections 5.c) and 5.d) above, since $RBW=100 \text{ KHZ}$ is available on nearly all spectrum analyzers.



4.3 DEVIATION FROM STANDARD

No deviation.

4.4 TEST SETUP



4.5 EUT OPERATION CONDITIONS

The EUT tested system was configured as the statements of 2.1 Unless otherwise a special operating condition is specified in the follows during the testing.

4.6 TEST RESULTS

5150-5250MHz					
Frequency	Direct measurement Power Density (dBm)	Duty cycle factor (dB)	Final Power Density (dBm)	Limit (dBm)	Result
802.11a					
5180	-7.156	0.296	-6.860	11	PASS
5200	-5.002	0.296	-4.706	11	PASS
5240	-5.051	0.296	-4.755	11	PASS
802.11n20					
5180	-7.849	0.332	-7.517	11	PASS
5200	-5.332	0.332	-5.000	11	PASS
5240	-5.195	0.332	-4.863	11	PASS
802.11n40					
5190	-8.446	0.641	-7.805	11	PASS
5230	-8.453	0.641	-7.812	11	PASS
802.11ac20					
5180	-5.045	0.300	-4.745	11	PASS
5200	-4.944	0.300	-4.644	11	PASS
5240	-4.756	0.300	-4.456	11	PASS
802.11ac40					
5190	-10.636	0.672	-9.964	11	PASS
5230	-8.279	0.672	-7.607	11	PASS
802.11ac80					
5210	-11.540	1.203	-10.337	11	PASS



5725-5850MHz						
Frequency	Use RBW 510KHz direct measurement Direct measurement Power Density (dBm)	Convert to RBW 500KHz direct measurement Power Density (dBm)	Duty cycle factor (dB)	Final Power Density (dBm)	Limit (dBm)	Result
802.11a						
5745	-5.571	-5.657	0.313	-5.344	30	PASS
5785	-6.071	-6.157	0.313	-5.844	30	PASS
5825	-7.509	-7.595	0.313	-7.282	30	PASS
802.11n20						
5745	-6.111	-6.197	0.301	-5.896	30	PASS
5785	-6.566	-6.652	0.301	-6.351	30	PASS
5825	-7.727	-7.813	0.301	-7.512	30	PASS
802.11n40						
5755	-10.775	-10.861	0.627	-10.234	30	PASS
5795	-11.511	-11.597	0.627	-10.970	30	PASS
802.11ac20						
5745	-5.569	-5.655	0.314	-5.341	30	PASS
5785	-6.060	-6.146	0.314	-5.832	30	PASS
5825	-7.209	-7.295	0.314	-6.981	30	PASS
802.11ac40						
5755	-8.958	-9.044	0.621	-8.423	30	PASS
5795	-9.872	-9.958	0.621	-9.337	30	PASS
802.11ac80						
5775	-17.195	-17.281	1.249	-16.032	30	PASS

Note: 1. RB conversion formula: $10 \cdot \text{LOG}(500\text{KHz}/\text{RBW})$
 2. Test plots see Attachment A

5. BANDWIDTH MEASUREMENT

5.1 EMISSION BANDWIDTH (EBW) 26 BANDWID PROCEDURES / LIMIT

The following procedure shall be used for measuring 26 bandwidth.

5.1.1 TEST PROCEDURE

1. The testing follows FCC KDB 789033 D02 General UNII Test Procedures New Rules v02r01
2. Set RBW = approximately 1% of the emission bandwidth.
3. Set the VBW \geq RBW.
4. Detector = Peak.
5. Trace mode = max hold.
6. Measure the maximum width of the emission that is 26 dB down from the peak of the emission. Compare this with the RBW setting of the analyzer. Readjust RBW and repeat measurement as needed until the RBW/EBW ratio is approximately 1%.

5.1.2 DEVIATION FROM STANDARD

No deviation.

6.1.3 TEST SETUP

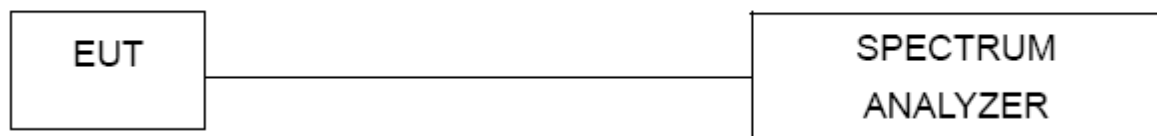

5.1.4 EUT OPERATION CONDITIONS

The EUT tested system was configured as the statements of 2.4 Unless otherwise a special operating condition is specified in the follows during the testing.



5.1.5 TEST RESULTS

Frequency (MHz)	26dB Bandwidth (MHz)	Pass/Fail
802.11a		
5180	23.84	Pass
5200	24.12	Pass
5240	24.02	Pass
802.11n(HT20)		
5180	24.11	Pass
5200	25.76	Pass
5240	25.68	Pass
802.11n(HT40)		
5190	43.60	Pass
5230	42.20	Pass
802.11ac(VHT20)		
5180	24.89	Pass
5200	24.69	Pass
5240	24.99	Pass
802.11ac(VHT40)		
5190	42.19	Pass
5230	41.57	Pass
802.11ac(VHT80)		
5210	88.16	Pass

Frequency (MHz)	26dB Bandwidth (MHz)	Pass/Fail
802.11a		
5745	24.57	Pass
5785	24.60	Pass
5825	24.50	Pass
802.11n(HT20)		
5745	25.12	Pass
5785	24.95	Pass
5825	24.71	Pass
802.11n(HT40)		
5755	40.33	Pass
5795	44.15	Pass
802.11ac(VHT20)		
5745	25.10	Pass
5785	24.71	Pass
5825	24.94	Pass
802.11ac(VHT40)		
5755	41.47	Pass
5795	41.84	Pass
802.11ac(VHT80)		
5775	83.94	Pass

Test plot see Attachment B



5.2 OCCUPIED BANDWIDTH (99%) TEST APPLIED PROCEDURES / LIMIT

The following procedure shall be used for measuring (99 %) power bandwidth.

5.2.1 TEST PROCEDURE

1. The testing follows FCC KDB 789033 D02 General UNII Test Procedures v02r01.

The following procedure shall be used for measuring (99 %) power bandwidth:

1. Set center frequency to the nominal EUT channel center frequency.
2. Set span = 1.5 times to 5.0 times the OBW.
3. Set RBW = 1 % to 5 % of the OBW
4. Set VBW $\geq 3 \cdot$ RBW
5. Video averaging is not permitted. Where practical, a sample detection and single sweep mode shall be used. Otherwise, peak detection and max hold mode (until the trace stabilizes) shall be used.
6. Use the 99 % power bandwidth function of the instrument (if available).
7. If the instrument does not have a 99 % power bandwidth function, the trace data points are recovered and directly summed in power units. The recovered amplitude data points, beginning at the lowest frequency, are placed in a running sum until 0.5 % of the total is reached; that frequency is recorded as the lower frequency. The process is repeated until 99.5 % of the total is reached; that frequency is recorded as the upper frequency. The 99% occupied bandwidth is the difference between these two frequencies.

5.2.2 DEVIATION FROM STANDARD

No deviation.

5.2.3 TEST SETUP

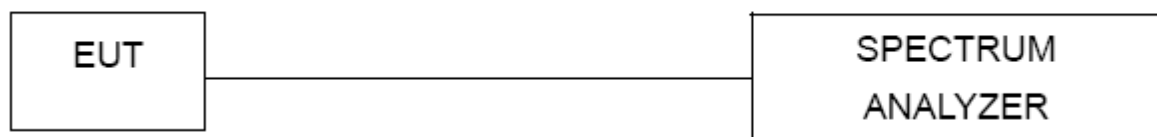

5.2.4 EUT OPERATION CONDITIONS

The EUT tested system was configured as the statements of 2.4 Unless otherwise a special operating condition is specified in the follows during the testing.



5.2.5 TEST RESULTS

Frequency (MHz)	99% Bandwidth (MHz)	Pass/Fail
802.11a		
5180	16.67	Pass
5200	16.66	Pass
5240	16.68	Pass
802.11n(HT20)		
5180	17.71	Pass
5200	17.71	Pass
5240	17.70	Pass
802.11n(HT40)		
5190	36.09	Pass
5230	36.06	Pass
802.11ac(VHT20)		
5180	17.72	Pass
5200	17.71	Pass
5240	17.72	Pass
802.11ac(VHT40)		
5190	36.08	Pass
5230	36.12	Pass
802.11ac(VHT80)		
5210	75.58	Pass

Frequency (MHz)	99% Bandwidth (MHz)	Pass/Fail
802.11a		
5745	16.67	Pass
5785	16.66	Pass
5825	16.67	Pass
802.11n(HT20)		
5745	17.69	Pass
5785	17.73	Pass
5825	17.73	Pass
802.11n(HT40)		
5755	36.07	Pass
5795	36.05	Pass
802.11ac(VHT20)		
5745	17.70	Pass
5785	17.70	Pass
5825	17.73	Pass
802.11ac(VHT40)		
5755	36.07	Pass
5795	36.11	Pass
802.11ac(VHT80)		
5775	75.51	Pass

Test plot See Attachment B

5.3 MINIMUM EMISSION BANDWIDTH(6 DB) PROCEDURES / LIMIT

Section 15.407(e) specifies the minimum 6 dB emission bandwidth of at least 500 KHz for the band 5.725-5.85 GHz. The following procedure shall be used for measuring this bandwidth:

5.3.1 TEST PROCEDURE

1. The testing follows FCC KDB 789033 D02 General UNII Test Procedures v02r01.
 - a) Set RBW = 100 kHz.
 - b) Set the video bandwidth (VBW) $\geq 3 \times$ RBW.
 - c) Detector = Peak.
 - d) Trace mode = max hold.
 - e) Sweep = auto couple.
 - f) Allow the trace to stabilize.
 - g) Measure the maximum width of the emission that is constrained by the frequencies associated with the two outermost amplitude points (upper and lower frequencies) that are attenuated by 6 dB relative to the maximum level measured in the fundamental emission.

5.3.2 DEVIATION FROM STANDARD

No deviation.

5.3.3 TEST SETUP



5.3.4 EUT OPERATION CONDITIONS

The EUT tested system was configured as the statements of 2.4 Unless otherwise a special operating condition is specified in the follows during the testing.

**6.3.5 TEST RESULTS**

Frequency (MHz)	6dB Bandwidth (MHz)	Pass/Fail
802.11a		
5745	16.38	Pass
5785	16.44	Pass
5825	16.37	Pass
802.11n(HT20)		
5745	17.62	Pass
5785	17.61	Pass
5825	17.59	Pass
802.11n(HT40)		
5755	35.73	Pass
5795	35.85	Pass
802.11ac(VHT20)		
5745	17.64	Pass
5785	17.59	Pass
5825	17.60	Pass
802.11ac(VHT40)		
5755	35.79	Pass
5795	35.68	Pass
802.11ac(VHT80)		
5775	75.95	Pass

Test plot see Attachment C

6. MAXIMUM CONDUCTED OUTPUT POWER

6.1 LIMIT

For mobile and portable client devices in the 5.15-5.25 GHz band, the maximum conducted output power over the frequency band of operation shall not exceed 250 mW provided the maximum antenna gain does not exceed 6 dBi. If transmitting antennas of directional gain greater than 6 dBi are used, both the maximum conducted output power and the maximum power spectral density shall be reduced by the amount in dB that the directional gain of the antenna exceeds 6 dBi.

For the 5.25-5.35 GHz and 5.47-5.725 GHz bands, the maximum conducted output power over the frequency bands of operation shall not exceed the lesser of 250 mW or 11 dBm + 10 log B, where B is the 26 dB emission bandwidth in megahertz, If transmitting antennas of directional gain greater than 6 dBi are used.

For the band 5.725-5.85 GHz, the maximum conducted output power over the frequency band of operation shall not exceed 1 W. If transmitting antennas of directional gain greater than 6 dBi are used.

FCC Part15 (15.407) , Subpart E				
Section	Test Item	Limit	Frequency Range (MHz)	Result
15.407(a) (1) (iv)	Peak Output Power	0.25 watt	5150-5250	PASS
		The lesser of 250 mW or 11 dBm + 10 log (26 dB emission bandwidth)	5250-5350 5470-5725	
15.407(a) (3)		1 watt	5725-5825	

6.2 TEST PROCEDURE

The EUT was directly connected to the Power Sensor&PC

6.3 DEVIATION FROM STANDARD

No deviation.

6.4 TEST SETUP

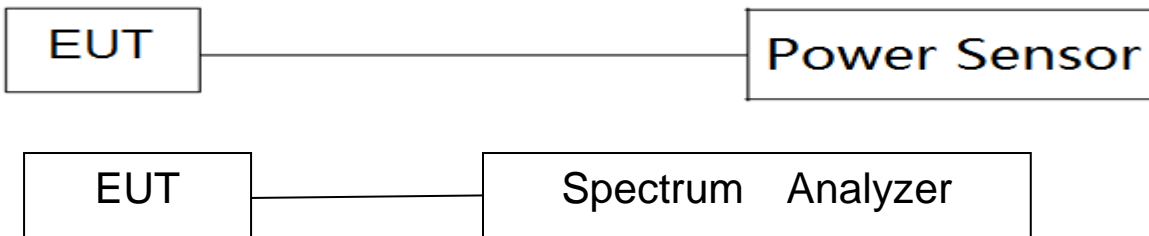

6.5 EUT OPERATION CONDITIONS

The EUT tested system was configured as the statements of 5 Unless otherwise a special operating condition is specified in the follows during the testing.

**6.6 TEST RESULTS**

Band I (5.15-5.25GHz)					
Test Channel	Frequency (MHz)	Direct measurement AV Power (dBm)	Duty cycle factor (dB)	Final AV Power (dBm)	LIMIT (dBm)
802.11a					
36	5180	6.78	0.296	7.08	23.98
40	5200	7.01	0.296	7.31	23.98
48	5240	7.05	0.296	7.35	23.98
802.11n(HT20)					
36	5180	6.82	0.332	7.15	23.98
40	5200	7.02	0.332	7.35	23.98
48	5240	7.15	0.332	7.48	23.98
802.11n(HT40)					
38	5190	6.09	0.641	6.73	23.98
46	5230	6.28	0.641	6.92	23.98
802.11ac(VHT20)					
36	5180	6.81	0.300	7.11	23.98
40	5200	7.07	0.300	7.37	23.98
48	5240	7.09	0.300	7.39	23.98
802.11ac(VHT40)					
38	5190	6.11	0.672	6.78	23.98
46	5230	6.26	0.672	6.93	23.98
802.11ac(VHT80)					
42	5210	7.58	1.203	8.78	23.98



Band IV (5.725-5.85GHz)					
Test Channel	Frequency (MHz)	Direct measurement AV Power (dBm)	Duty cycle factor (dB)	Final AV Power (dBm)	LIMIT (dBm)
802.11a					
149	5745	8.01	0.313	8.32	30.00
157	5785	7.09	0.313	7.40	30.00
165	5825	6.01	0.313	6.32	30.00
802.11n(HT20)					
149	5745	8.04	0.301	8.34	30.00
157	5785	7.12	0.301	7.42	30.00
165	5825	6.05	0.301	6.35	30.00
802.11n(HT40)					
151	5755	7.01	0.627	7.64	30.00
159	5795	6.06	0.627	6.69	30.00
802.11ac(VHT20)					
149	5745	8.02	0.314	8.33	30.00
157	5785	7.12	0.314	7.43	30.00
165	5825	6.07	0.314	6.38	30.00
802.11ac(VHT40)					
151	5755	7.01	0.621	7.63	30.00
159	5795	6.07	0.621	6.69	30.00
802.11ac(VHT80)					
155	5775	8.53	1.249	9.78	30.00

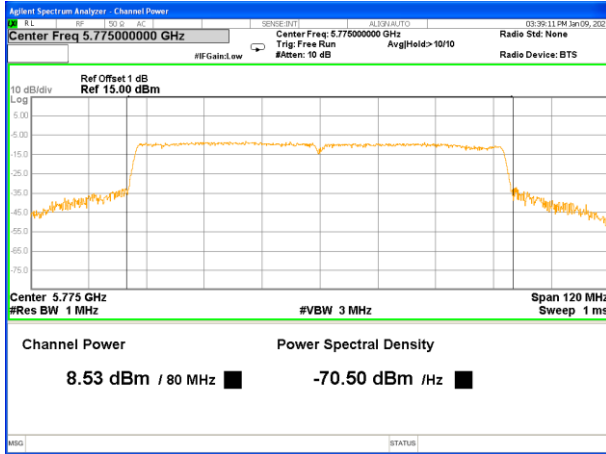

5775MHz_AV

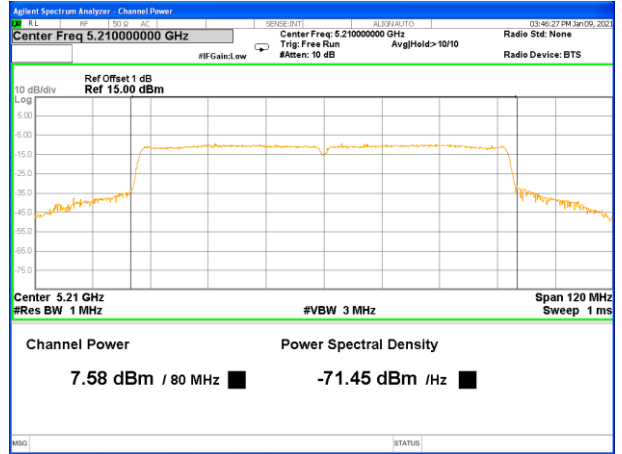

5210MHz_AV





Duty cycle

Band1				
Mode	Ton(ms)	Tp(ms)	Duty cycle(%)	Duty factor(dB)
a	1.420	1.520	93.42%	0.296
n20	1.320	1.425	92.63%	0.332
n40	0.660	0.765	86.27%	0.641
ac20	1.330	1.425	93.33%	0.300
ac40	0.663	0.774	85.66%	0.672
ac80	0.332	0.438	75.80%	1.203
Band4				
Mode	Ton(ms)	Tp(ms)	Duty cycle(%)	Duty factor(dB)
a	1.405	1.510	93.05%	0.313
n20	1.325	1.420	93.31%	0.301
n40	0.657	0.759	86.56%	0.627
ac20	1.335	1.435	93.03%	0.314
ac40	0.663	0.765	86.67%	0.621
ac80	0.330	0.440	75.00%	1.249



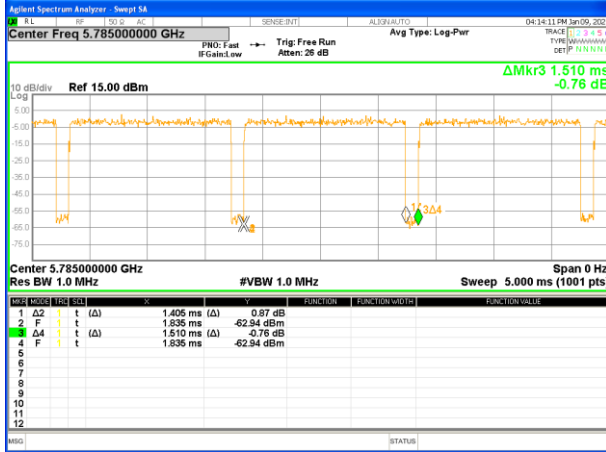

Band 1-a20



Band 1-n20



Band 1-n40



Band 1-ac20

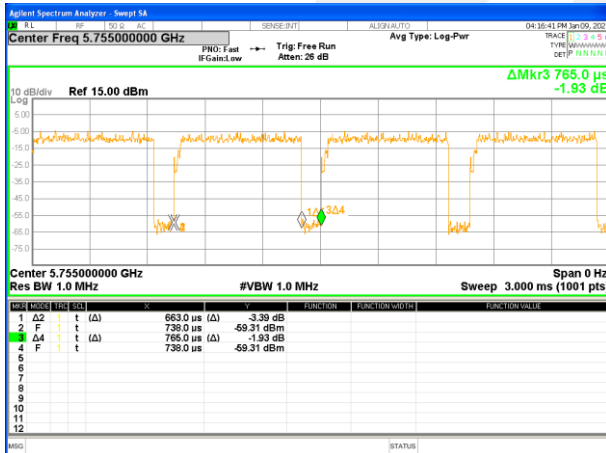

Band 1-ac40



Band 1-ac80



Band 4-a20

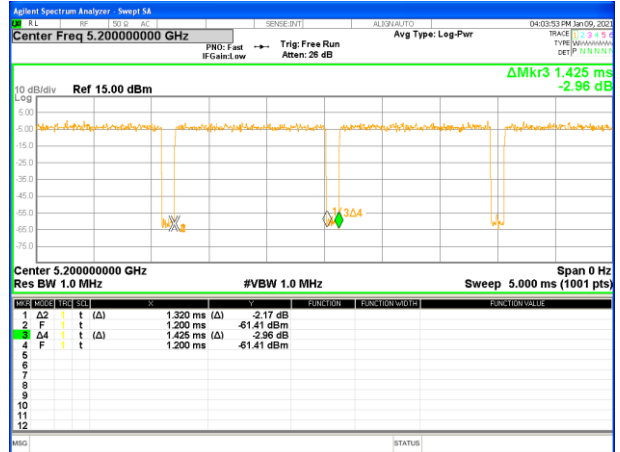

Band 4-n20



Band 4-n40



Band 4-ac20

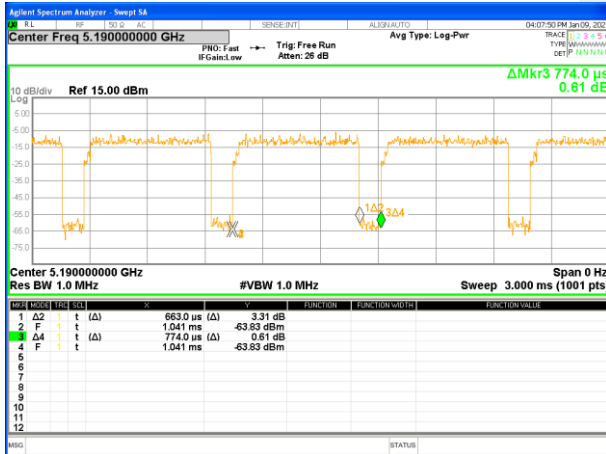

Band 4-ac40



Band 4-ac80



7. AUTOMATICALLY DISCONTINUE TRANSMISSION

7.1 LIMIT OF AUTOMATICALLY DISCONTINUE TRANSMISSION

The device shall automatically discontinue transmission in case of either absence of information to transmit or operational failure. These provisions are not intended to preclude the transmission of control or signaling information or the use of repetitive codes used by certain digital technologies to complete frame or burst intervals. Applicants shall include in their application for equipment authorization to describe how this requirement is met.

7.2 TEST RESULT OF AUTOMATICALLY DISCONTINUE TRANSMISSION

During no any information transmission, the EUT can automatically discontinue transmission and become standby mode for power saving. The EUT can detect the controlling signal of ACK message transmitting from remote device and verify whether it shall resend or discontinue transmission.





8. ANTENNA REQUIREMENT

8.1 STANDARD REQUIREMENT

15.203 requirement: For intentional device, according to 15.203: an intentional radiator shall be designed to ensure that no antenna other than that furnished by the responsible party shall be used with the device.

8.2 EUT ANTENNA

The EUT antenna is PIFA Antenna. It comply with the standard requirement.





APPENDIX - PHOTOS OF TEST SETUP

Note: See test photos in setup photo document for the actual connections between Product and support equipment.

※※※※END OF THE REPORT※※※※

