



Welcome to the World of  
**E-Collar Technologies Incorporated**

---

## **FOB Educator**

**FE-560A**

(FE-560A-TX, RX-050)

**FE-562A**

(FE-560A-TX, RX-050, RX-050)

**Owner's Manual**

**“Happiness is a Well  
Behaved Dog”**

Welcome to the World of E-Collar Technologies Incorporated

---



# FE-560A Series E-Collar

Remote Education Collar

Thank you for purchasing the FE-560A or FE-562A Remote Education Collar from E-Collar Technologies Incorporated. We have made every attempt to provide you with the most technologically advanced product using the most stringent quality and manufacturing standards.

We are confident you will be pleased with the results you will attain with your e-collar. Please remember you will get better results with the use of lower stimulation combined with consistent training techniques.

The use of high levels of stimulation should only be used as a last resort and in life-threatening situations. Visit our youtube channel for training videos and "Like" our Facebook page to network with fellow e-collar users.

Good luck with your training and please feel free to contact us should you have any questions.

1-855-326-5527 or [sales@ecollar.com](mailto:sales@ecollar.com)

# 02

## TABLE OF CONTENTS

---

- Important Notice .....	03
- Characteristics .....	04
- Package Contents .....	05
- Device Operation .....	06
- Charging the Batteries .....	08
- Turning Your E-collar ON/OFF .....	10
- Correctly Fitting Collar .....	12
- LCD Display Description .....	13
- Function Description .....	14
- Button Operation .....	15
- Programming Mode .....	19
- How to Find the Proper Stimulation Level .....	22
- Stimulation Level Button Lock/Unlock .....	23
- Rising Stimulation .....	24
- Replace/Add Collar .....	25
 <b>Two Dog FE-562 Specifics</b>	
- 562A LCD Display Description .....	26
- 562A Function Description .....	27
- 562A Button Operation .....	28
- 562A Programming Mode .....	33
- 562A Stimulation Level Button Lock/Unlock .....	38
- 562A Rising Stimulation .....	40
- Testing Your E-collar .....	42
- Replacing the Contact Points .....	43
- Finger Trainer .....	44
- Pairing Finger Trainer with FT-330/332 Transmitter .....	45
- Changing the Button the Finger Trainer Controls on the FE560A/562A Transmitter .....	47
- Operating Distance and Battery of Finger Trainer .....	48
- Training Tips .....	49
- Troubleshooting .....	50
- Two Year Warranty .....	51
- Accessories .....	52
- Safety and general Information .....	53

## Important Notice

### Caution

This product is intended to be used on DOGS ONLY.

E-Collar Technologies Incorporated is not responsible for any misuse of this Product including damages from dog bites and lost items. Seek an evaluation by professional trainer before use on aggressive dogs. It is not uncommon for aggressive dogs to associate the stimulation with the handler and take action against the handler. Sometimes dogs put under e-collar pressure during a fight can exhibit redirected aggression and become more aggressive.

The use of high levels of stimulation should only be used as a last resort and in life-threatening situations.

To prevent giving stimulation to your dog by accident, keep the stimulation level below 5 while not in use.

The range of the FE-560A/562A may vary according to terrain, weather conditions, foliage, and power lines as well as radio transmissions from other devices.

### FCC Statements.

· MODEL : FE-560A-TX      FE-560 FCC ID : 2ASPX-FE-560ATX

#### **Compliance Statement (Part 15.19)**

*This device complies with Part 15 of the FCC Rules. Operation is subject to the following two conditions:*

- 1. This device may not cause harmful interference, and*
- 2. This device must accept any interference received, including interference that may cause undesired operation.*

#### **Warning (Part 15.21)**

*Changes or modifications not expressly approved by the party responsible for compliance could void the user's authority to operate the equipment.*

# 04

## CHARACTERISTICS

---

- Range : 300 Yards
- Two Stimulation Modes (Continuous/Rising Stimulation)
- 3 Functions Settable Front Button (Tone/Vibrations/Stimulation)
- Tapping Sensation or Tone Stimulation (Pavlovian Conditioning)

**Tapping Sensation:** Alternative to Stimulation

(vibration similar to a Cell Phone)

**Tone Stimulation:** After 1.2 seconds of tone, the collar will send continuous stimulation at the conditioning level as long as button is pressed (up to 10 seconds), leads to “Pavlovian Conditioning” whereby the dog responds to the tone.

- Quick Charge Li-polymer Batteries
- User Settable Max. Limit Level (5 to 100)
- User Settable Ramping up Speed to Max.
- Limit Level (0 sec./1sec./ 2sec./5sec.)  
Stimulation Levels Adjustable from 1 to 00
- Collar Receiver Light for locating your dog at night Lock and Set Stimulation Safety Feature
- Stimulation Boosting Mode provides instant control when normal stimulation is ignored - great for emergency situations.  
Completely Waterproof and Shock Resistant
- Convertible from 1-Dog model (FE-560A) to 2-Dog model (FE-562A)

# Package CONTENTS

- Transmitter

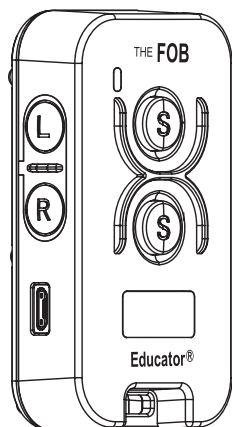

- Collar Receiver with Strap  
(FE-562A Package includes 2 Receivers and straps)

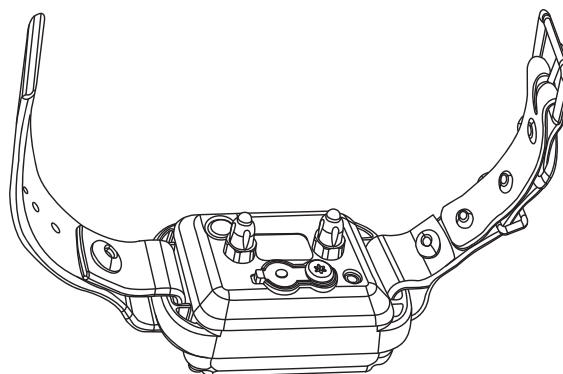

- Finger Trainer

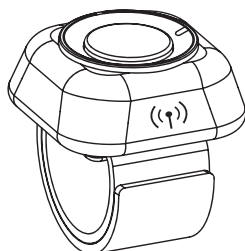

- Battery Charger  
(FE-562A package contains splitter cable)

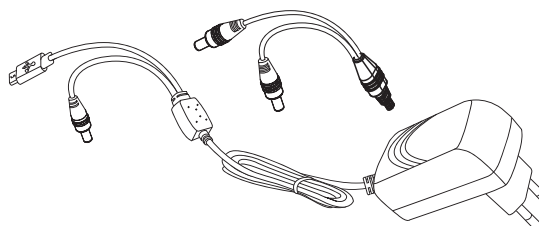

- Owner's Manual

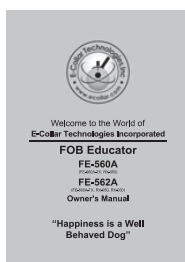

- Extra Contact Points 3/4"

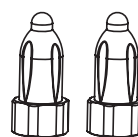

- Test Light

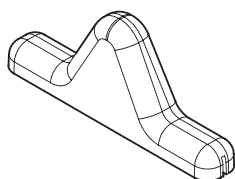

- Contact Point Tool



- Lanyard

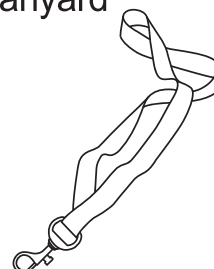

# 06

## DEVICE OPERATION

---

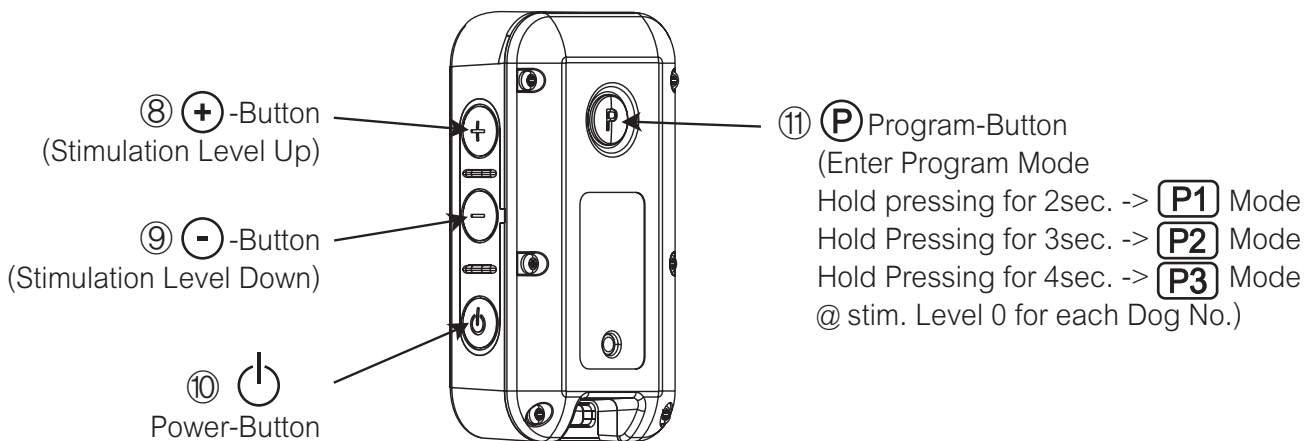
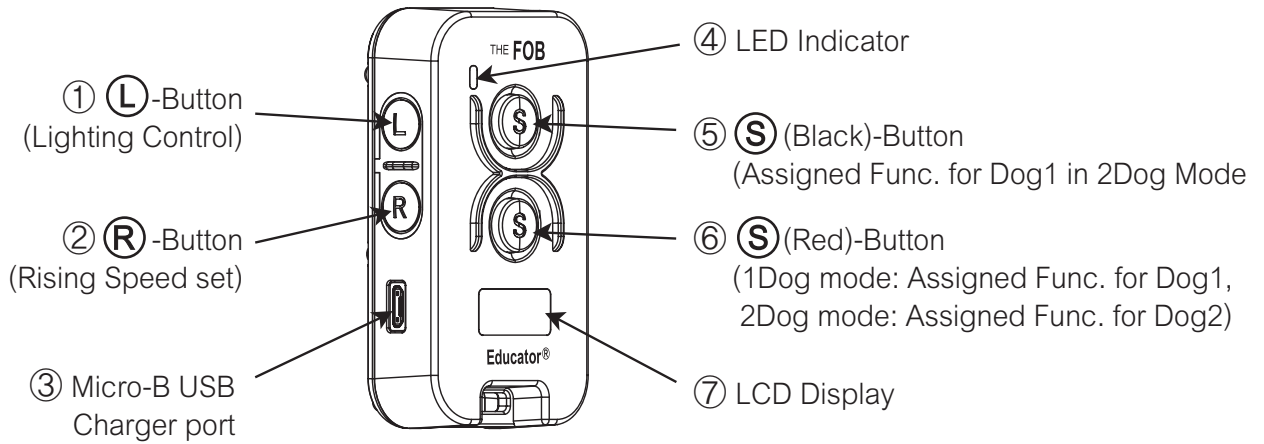

- ① **L**-Button : Selecting Lighting mode operation
- ② **R**-Button : Selecting the operation time of Rising Stimulation Mode
- ③ Micro-B USB Charger port : Transmitter Charging Port (Micro-B type USB)
- ④ LED Indicator : Indicate signal transmission status and Battery status.
- ⑤ **S** (Black)-Button : Stimulation operation with set stimulation level
- ⑥ **S** (Red)-Button : Operation with preset mode among  
Stimulation / Tone / Vibration / Rising Stimulation mode
- ⑦ LCD Display : Indicates Transmitter transmission level, operation status, and Dog1/Dog2 status
- ⑧ **+**-Button : Stimulation Level Up
- ⑨ **-**-Button : Stimulation Level Down
- ⑩ Power-Button : Transmitter Power ON/OFF
- ⑪ **P** Program-Button : Enter programming mode & Dog select in 2Dog mode

# DEVICE OPERATION

---

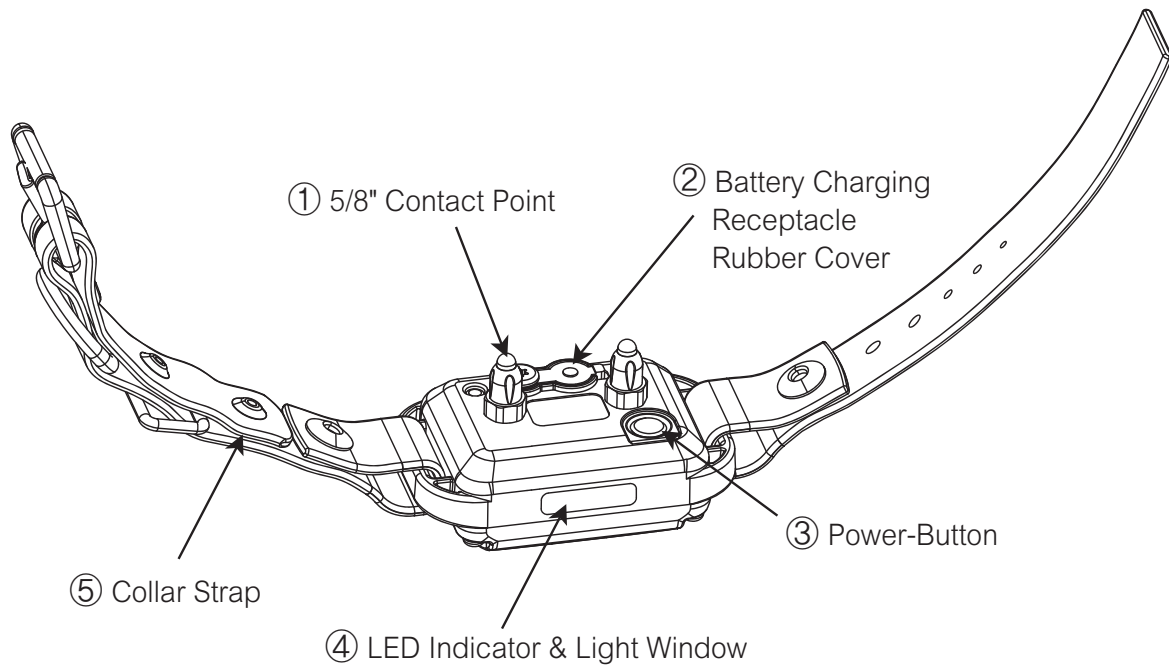

- ① 5/8" Contact Point
- ② Battery Charging Receptacle and Rubber Cover
- ③ Power-Button : Receiver Power ON/OFF
- ④ LED Indicator & Light Window : Battery indicator & Light
- ⑤ Collar Strap



# 08

## CHARGING THE BATTERIES

---

Indicator Light is blinking “Green” under normal operation.

solid “Red” when stimulation is applied.

blinking “Red” when recharging is required.

Do not allow the batteries to get hot or be fully discharged, store at room temperature and 50% capacity charge.

### Transmitter Battery Charging

The Micro-B USB charging cable can be used to charge the product.

Micro-B USB Charger port

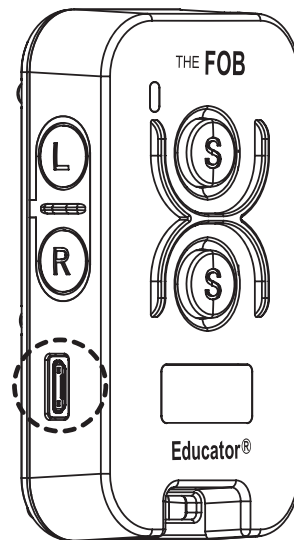

The indicator light will turn solid red during charge cycles and turn green if it is fully charged. (approximately 2 hours)

Your e-collar is outfitted with Li-Polymer batteries which requires specific care to assure longevity. It is best not to let the battery be fully discharged and if it does, recharge immediately or irreversible damage may occur. Keep the units away from extreme heat and cold temperatures.

# CHARGING THE BATTERIES

Collar Receiver Battery Charging Receptacle and Rubber Cover.

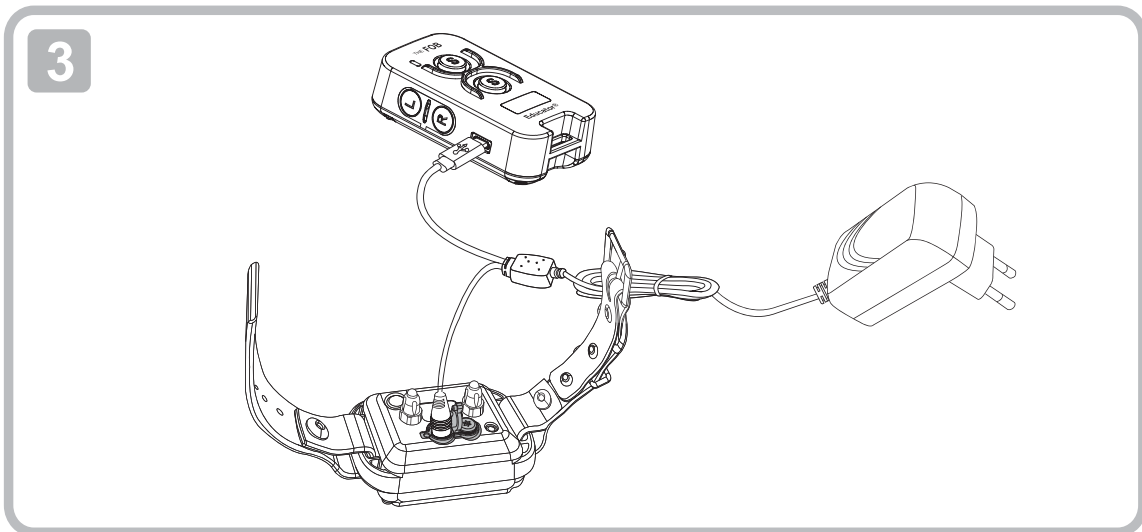
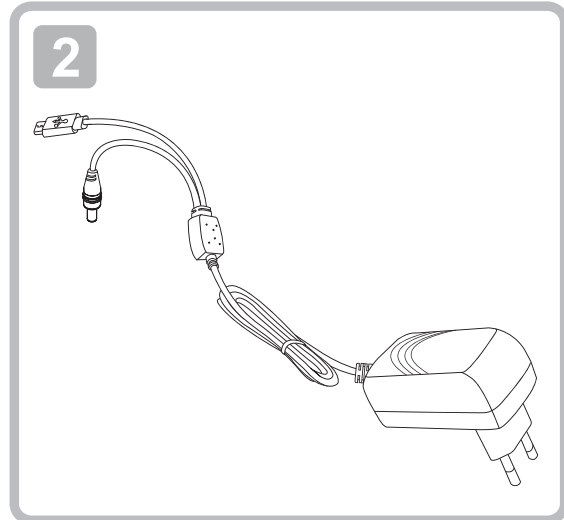
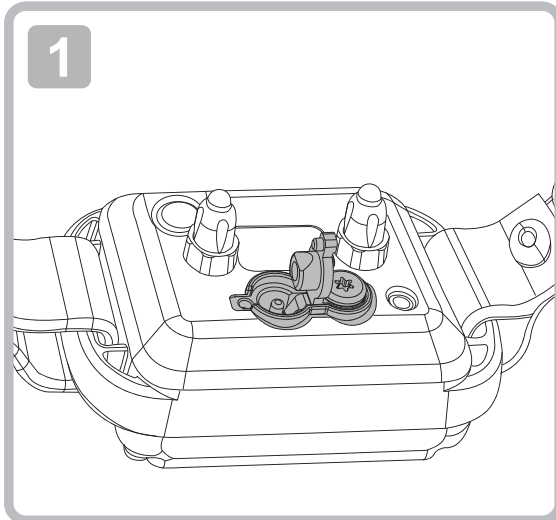

# 10

## TURNING YOUR TRANSMITTER ON/OFF

Transmitter can be turned on and off by pressing the Power-Button.

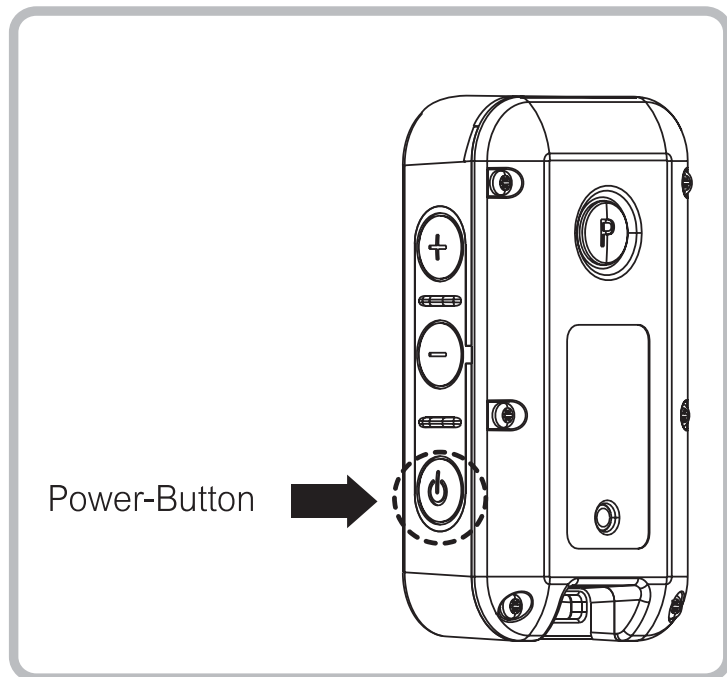

- **Power ON** : Press the power button for more than 0.5 seconds to turn Transmitter on.



- **Power OFF** : Press power button for more than 1.5 seconds to turn Transmitter off.

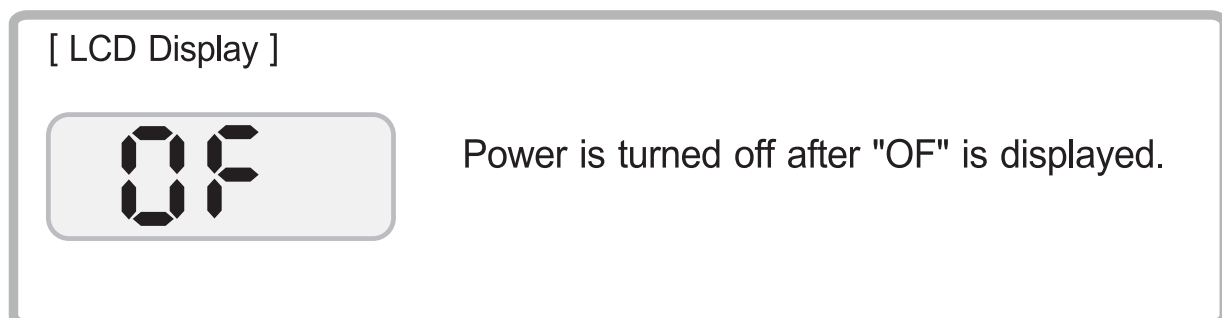

## TURNING YOUR RECEIVER ON/OFF

---

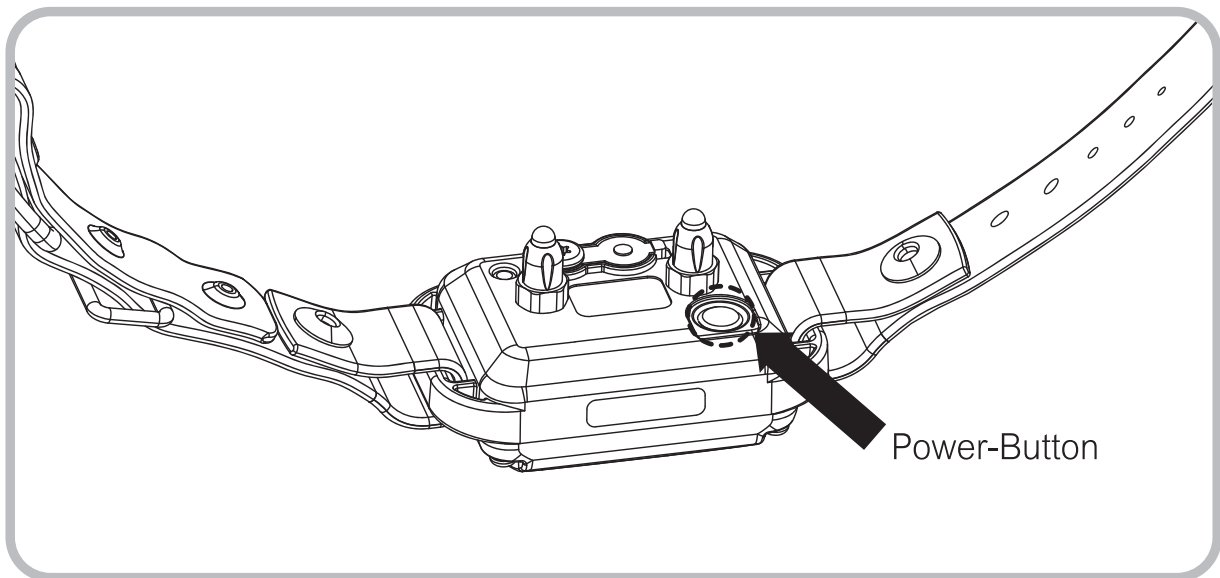

Collar Receiver can be turned on and off by pressing the Power-Button.

- **Power ON** : Press the Power-Button for more than 1 second to turn it on.
  - **Power OFF** : Press the Power-Button for more than 1 second to turn it off.
- 

### • Holding the Transmitter

To obtain the maximum range hold the transmitter like the torch on the Statue of Liberty. Keep the antenna away from your body or fingers at all times, touching the antenna will greatly reduce the range.



[ Long Range ]

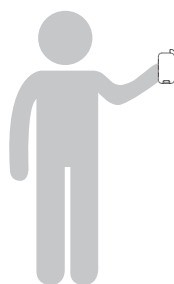

[ Medium Range ]

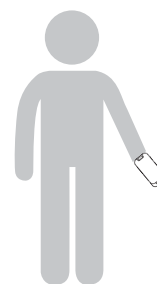

[ Short Range ]

# 12

## CORRECTLY FITTING COLLAR

---

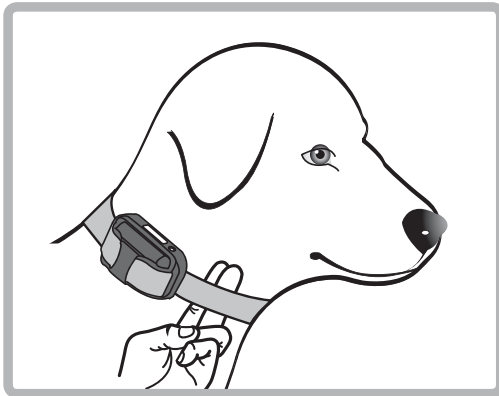

The collar should be adjusted to allow the “contact points” to have direct contact with the skin. You should be able to fit a couple of fingers between the collar strap and your dog's skin.

Too tight poses the risk of skin irritation

and discomfort. Too loose and the contact points will not be able to administer the stimulation reliably and can cause skin irritation due to chafing. Short hair breeds may need the 3/8" microprobes offered as an accessory item, contact customer service for details. The optimal position for the collar receiver is on either side of the dog's windpipe. If the factory installed 5/8" contact points are not making good contact due to thick fur, see page 39 for changing contact points.

### IMPORTANT NOTICE

To prevent the occurrence of skin irritations the Collar Receiver should never be worn for more than 12 hours per day. Should your dog experience skin irritations from over exposure to the contact points remove the collar receiver unit immediately and stop using your e-collar until all skin irritations are completely healed. Antibiotic ointment will aid in the healing process. Some dog breeds have extra thick fur or extra short fur that requires special contact points. Please contact our customer service or visit [www.ecollar.com](http://www.ecollar.com) for more information.

## 560A THE LCD DISPLAY DESCRIPTION

[ LCD Display ]

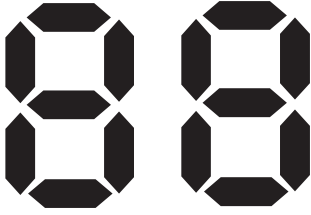

Display	Description
<b>1D</b>	Indicates Dog 1
	(1) Indicates Current Stimulation Level in Standby and Stimulation Mode ("0~HI" Level ) (2) Displays text for other settings and operations
<b>V</b>	Indicates HI-Vibration
<b>v</b>	Indicates LOW-Vibration
<b>T</b>	Indicates Tone
<b>+</b>	Indicates Rising Stimulation and Step to Increase Stimulation Level

# 14

## 560A FUNCTION DESCRIPTION

---

### - Stimulation

While the button is pressed, the preset stimulation level is transmitted.  
(Maximum operating time : 10 seconds)

### - Rising Stimulation

While the button is pressed, the level increases from the currently set stimulation level to the set max level for a predetermined time interval.  
(Stimulation Max Level and time interval can be set separately.)







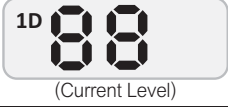
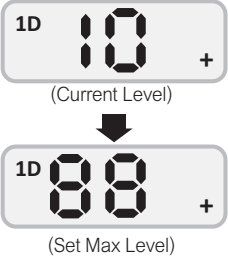

### - Vibration

While the button is pressed, it transmits a vibration. Two vibration modes available.  
(LOW(weak vibration) / HI(strong vibration))

### - Tone or Tone followed by Stimulation (Pavlovian Conditioning)

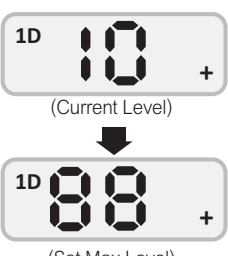
- Tone followed by Stimulation (Stimulation Level is not "0") : While the button is pressed, the tone is transmitted for 1.25 seconds.  
If the button is pressed longer than 1.25 seconds, the current level stimulation is transmitted." (Maximum operating time 10 seconds)
- Tone (Stimulation Level is "0") : While the button is pressed, only tone is transmitted instead of stimulation.

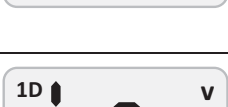
# 560A BUTTON OPERATION

Button	Function	Description	LCD Display
Black Ⓢ	Assigned Function in <b>P2</b> for 1Dog Mode - Stimulation - Rising Stimulation - Tone - LOW-Vibration - HI-Vibration	Stimulation	
		Rising Stimulation	
		Tone or Tone followed by Stimulation * Level "0" : Tone only * Level "1~HI" : Tone followed by Stimulation	
		LOW-Vibration	
		HI-Vibration	
		Red Ⓢ	Assigned Function in <b>P3</b> for 1Dog Mode - Stimulation - Rising Stimulation - Tone - LOW-Vibration - HI-Vibration
Rising Stimulation			
Tone or Tone followed by Stimulation * Level "0" : Tone only * Level "1~HI" : Tone followed by Stimulation			
LOW-Vibration			
HI-Vibration			



# 16

## 560A BUTTON OPERATION





Button	Function	Description	LCD Display
Ⓛ	Light ON/OFF	Select Light Operation Press the button within 1 second. flickering - steady - off in turn	1D L
		Light OFF * Press the Ⓛ-button for more han 1 second or longer to power light off.	1D -L
Ⓡ	Rising Stimulation Time Set	Select time to reach Max Level in Rising Stimulation mode. (By pressing and releasing the Ⓡ-button. "0 sec->1 sec-> 2 sec-> 5 sec->1 sec ...")	1D r 0 ↓ 1D r 1 ↓ 1D r 2 ↓ 1D r 5
⊕ / ⊖	Stimulation Level UP/DOWN	Stimulation Level UP/DOWN	1D 88 (0-HI)
Ⓜ	Power ON/OFF	Press and hold Power button for more than 1 second to turn power on.	1D 88 V v 2D 88 T + ↓ 0n ↓ (Set Level) 1D 88
		Press and hold Power button for more than 1.5 second to turn power off.	0F

# 560A BUTTON OPERATION

Button	Function	Description	LCD Display
Stimulation Level = 0 + (P) Program + 2 Seconds (P1) 3 Seconds (P2) 4 Seconds (P3)	Programming Mode	When the (P) Program Button is pressed for 2 seconds it enters (P1), holding for an additional 1 second it will enter (P2), and holding for an additional 1 second it will enter (P3).	
(P) Program + Black (S)	Rising Stimulation	Activates Rising Stimulation.	
(P) Program + (-)	Lock (+), (-) Level when "1D" icon is blinking in the display.	- When "1D" icon on the display is blinking, pressing the (P) button and (-) button at the same time will activate the Level Lock function. - "1D" icon changes from blinking to solid. - Pressing (+) or (-) button after Level Lock function is activated, the stimulation level does not change and only beeps.	
	Unlock (+), (-) Level when "1D" icon is solid in the display.	- When "1D" icon on the display is solid, pressing the (P) button and (-) button at the same time will deactivate the Level Lock function. - "1D" icon changes from solid to blinking.	

# 18

## 560A BUTTON OPERATION

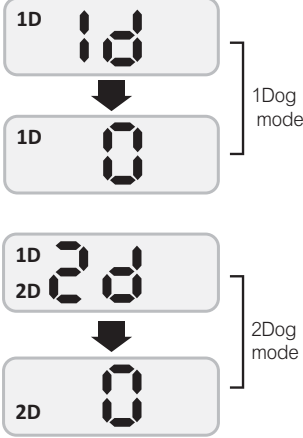
Button	Function	Description	LCD Display
Stimulation Level = 0 +  + 	Pairing	Pairs / Syncs collar receiver to transmitter.	
Stimulation Level = 0 +  Program +  + 3 Seconds	Change 1Dog / 2Dog Mode	Changes from 1Dog mode to 2Dog mode and vice versa.	

## 560 PROGRAMMING MODE

### \* How to enter program mode

- (1) After adjusting the stimulation level to "0", press and hold the **P**-button on the back of transmitter for 2 seconds to enter the program mode.
- (2) If you keep holding the button while entering the program mode, the LCD display cycles every 1 second in the order of "**P1** → **P2** → **P3** → **P1**...".

Press and hold the **P**-button to display the mode you want to set.  
Release to enter the setting mode.

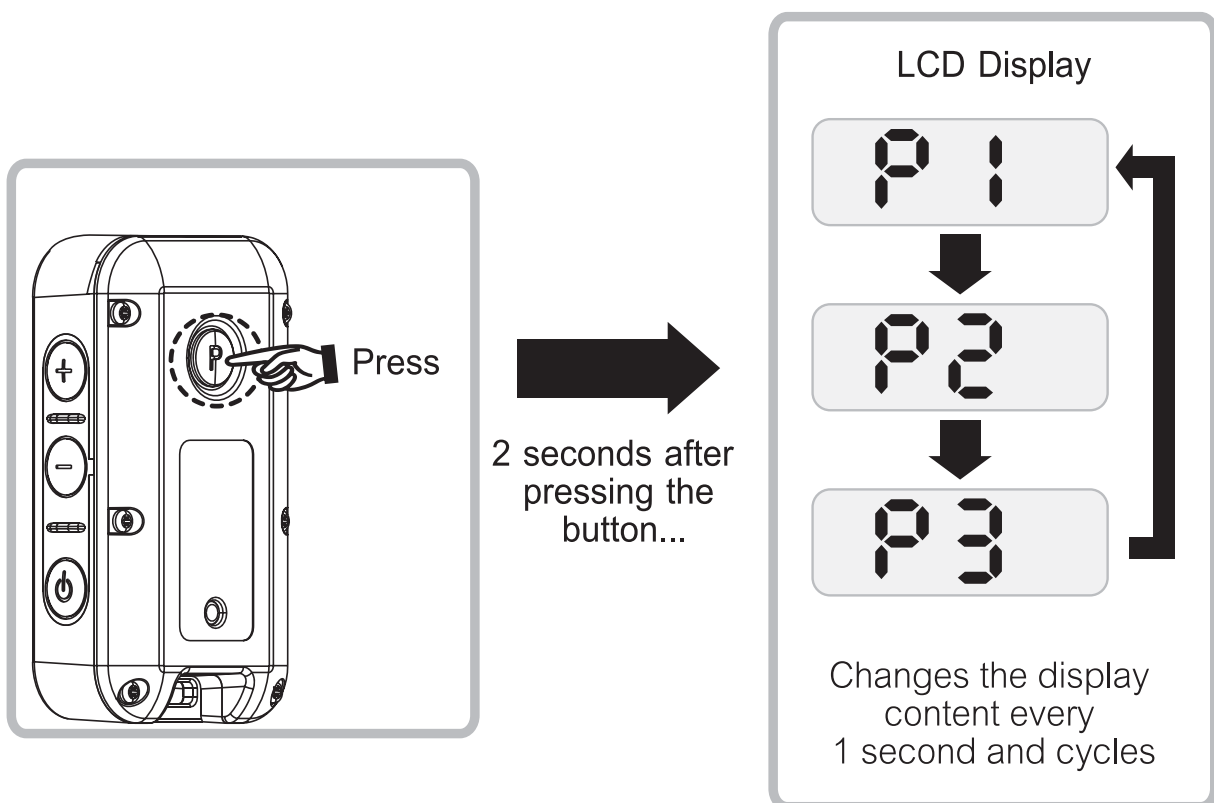

## 560A PROGRAMMING MODE

- In the program mode, the functions of the **(S)** (Black)-button and **(S)** (Red)-button can be set respectively.
- After setting the function of each button, press the **(P)**-button to save the changes and exit the program mode.

MODE	Setting Value	LCD Display
<b>(P1)</b>	<p>Sets the maximum stimulation level. (Settable level : 5 ~ HI)</p> <p>* Set the level value with <b>(+)</b>, <b>(-)</b>-button.</p>	
<b>(P2)</b>	<p>Sets the operation function of the <b>(S)</b> (Black)-button. (Stimulation → Rising Stimulation → Tone → LOW Vibration → HIGH Vibration)</p> <p>Select the mode by pressing <b>(S)</b> (Black)-Button</p>	
<b>(P3)</b>	<p>Sets the operation function of the <b>(S)</b> (Red)-button. (Stimulation → Rising Stimulation → Tone → LOW Vibration → HIGH Vibration)</p> <p>Select the mode by pressing <b>(S)</b> (Red)-Button</p>	

## 560A PROGRAMMING MODE

\* If the maximum level limit is set in **(P1)**, it will not go above the set value when raising the stimulation level with the **(+)**-button.

### \* Setting stimulation level Increasing step

- You can increase the stimulation level by using the **(+)**-button.

(The default setting is "5" <increase level value by 5>, and can be set to "1" or "10"..)

### - Setting Procedure

1. Enter "**(P2)**" in program mode.
2. Press the **(S)** (Black)-button to select the "**10 5 8**" icon.
3. Press the **(+)**-button to display the desired setting among "1+", "5+" and "10+".
4. Press the **(P)**-button to save changes and exit program mode.

Increasing Step	Operation	LCD Display
1 Step	Until LCD shows desired step as "1 +", repeat pressing <b>(+)</b> -Button.	
5 Step	Until LCD shows desired step as "5 +", repeat pressing <b>(+)</b> -Button.	
10 Step	Until LCD shows desired step as "10 +", repeat pressing <b>(+)</b> -Button.	

\* Regardless of the setting of the level increasing step, level decreasing step when press **(-)**-Button is fixed by 1 step.

## HOW TO FIND THE PROPER STIMULATION LEVEL

---

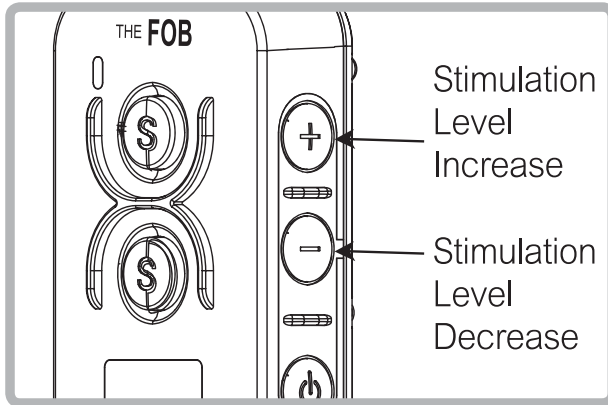

The stimulation level increases when you press  $\oplus$ -Button and the stimulation level decreases when you press  $\ominus$ -Button

It is highly recommended that the user practices changing levels and modes before putting the collar receiver on a dog.

Setting the correct stimulation level for your dog is very important. To set your “conditioning” stimulation level, correctly put the collar receiver on your dog (see page 12 for instructions). Let the dog get used to the collar receiver for a couple of hours.

While watching your dog, turn the level to “0” and press the continuous stimulation button. Slowly turn the stimulation up at a rate of approximately 2-3 levels per second. When your dog first perceives the stimulation, usually between 5 and 20, release the button. This is your “conditioning” stimulation level. You may need to increase the “conditioning” level a few levels to get your dog to respond at first, some dogs are more stubborn and need more stimulation. The boosted level is typically 5 to 20 levels higher than the “conditioning” level.

# 560A STIMULATION LEVEL BUTTON LOCK/UNLOCK





The stimulation level set by the user can be locked and unlocked.

- **Stimulation Level Button Lock**

- Holding down **(P)**-Button and pressing **(-)**-Button at the same time to activate the Stimulation Level Button Lock function when "1D" icon on the LCD display is blinking (Stimulation Level Button Unlock Status).
- After the Stimulation Level Button Lock function is activated, the "1D" icon on the LCD changes solid.
- When the Stimulation Level Up/Down Button, **(+)** / **(-)** is pressed, a beep sounds and the stimulation does not change.

- **Stimulation Level Button Unlock**

- Holding down **(P)**-Button and pressing **(-)**-Button at the same time to deactivate the Stimulation Level Button Lock function when "1D" icon on the LCD display is solid (Stimulation Level Button Lock Status).
- After the Stimulation Level Button Lock function is deactivated, the "1D" icon on the LCD changes blinking.

Button	Function	Description	LCD Display
<b>(P)</b> Program + <b>(-)</b>	Lock <b>(+)</b> , <b>(-)</b> Level when "1D" icon is blinking in the display.	<ul style="list-style-type: none"> <li>- When "1D" icon on the display is blinking, pressing the <b>(P)</b> button and <b>(-)</b> button at the same time will activate the Level Lock function.</li> <li>- "1D" icon changes from blinking to solid.</li> <li>- Pressing <b>(+)</b> or <b>(-)</b> button after Level Lock function is activated, the stimulation level does not change and only beeps.</li> </ul>	 <p>(1D icon will be solid after activation)</p>  <p>↓</p>  <p>(Display changes for a while when pressing <b>(+)</b> or <b>(-)</b> button during Level Lock)</p>
	Unlock <b>(+)</b> , <b>(-)</b> Level when "1D" icon is solid in the display.	<ul style="list-style-type: none"> <li>- When "1D" icon on the display is solid, pressing the <b>(P)</b> button and <b>(-)</b> button at the same time will deactivate the Level Lock function.</li> <li>- "1D" icon changes from solid to blinking.</li> </ul>	 <p>(1D icon will be blinking after deactivation)</p>



## RISING STIMULATION

It is possible to increase the stimulation from the current level to the set maximum level.

- **Rising Stimulation Operation**
  - Press the Rising Stimulation button to increase the stimulation from the current level to the maximum level.
  - The time to reach the maximum stimulation level can be set by pressing the **(R)**-Button.
- **Rising Stimulation Operation Button**
  - Press Stimulation **(S)** (Black)-Button and **(P)**-Button with the current stimulation level not "0".
  - In programming mode, set Stimulation **(S)** (Red)-Button to, **1D 5t** then press Stimulation **(S)** (Red)-Button.
- **Set stimulus level rise time**
  - : Time to reach the maximum stimulation level from the current stimulation level can be set.
  - Every time you press **(R)**-Button in standby, "r0-> r1-> r2-> r5 ..." is changed.
  - When you exit the mode from the currently selected screen, the last selected time is automatically set.

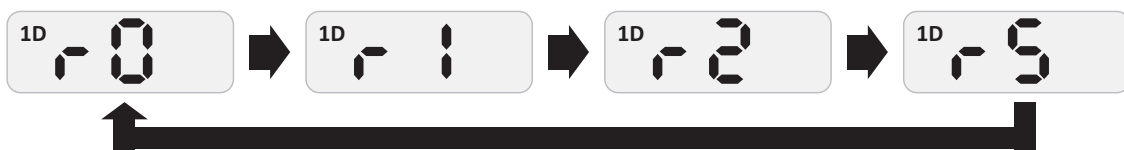

LCD Display	Description
<b>1D r0</b>	When the button is pressed, it immediately outputs the maximum stimulation level. (Stimulation boosting mode)
<b>1D r1</b>	It takes 1 second to reach the maximum stimulation level from the current stimulation level.
<b>1D r2</b>	It takes 2 second to reach the maximum stimulation level from the current stimulation level.
<b>1D r5</b>	It takes 5 second to reach the maximum stimulation level from the current stimulation level.

- The maximum stimulation level can be set in programming mode.

## REPLACE/ADD COLLAR

---

Occasionally, it is necessary to pair/sync a transmitter to a collar receiver, the following procedure will accomplish this.

1. Turn on the Transmitter
2. Set the stimulation level at "0"
3. Make sure Receiver is turned off.
4. Press the Collar Receiver's Power-Button for more than 5 seconds until green light on receiver flashes rapidly.
5. Immediately after, press and hold **(-)**-button followed by the **(L)**-button until you hear confirmation sound from collar receiver.

### HOW TO CHANGE THE TRANSMITTER TO A 2 DOG TRANSMITTER

The button functions will change. The changes are described on on pages 26 through 41. You can change the transmitter back to the 1Dog system (560) at any time.

1. Turn on the Transmitter.
2. Set the stimulation level at "0"
3. Press the **(P)**-Button followed by the **(+)**-Button simultaneously for more than 2 seconds until you hear the confirmation beeps.
4. Repeat step 2 to return back to a 1 dog system.

### ADD/REPLACE COLLAR FOR SECOND DOG

1. Turn on the Transmitter
2. Set the stimulation level at "0" when 2D is displayed on the LCD.
3. Make sure Receiver is turned off.
4. Press the Collar Receiver's Power-Button for more than 5 seconds until green light on receiver flashes rapidly.
5. Immediately after, press and hold **(-)**-button followed by the **(L)**-button until you hear confirmation sound from collar receiver.

## 562A LCD DISPLAY DESCRIPTION

[ LCD Display ]



Display	Description
<p><b>1D</b></p> <p><b>2D</b></p>	<p>Indicates Dog1 / Dog2 in 2Dog Mode</p> <ul style="list-style-type: none"> <li>- 1D : Dog1</li> <li>- 2D : Dog2</li> </ul>
	<p>(1) Indicates Current Stimulation Level in Standby and Stimulation Mode ("0~HI" Level )</p> <p>(2) Displays text for other settings and operations</p>
<p><b>V</b></p>	<p>Indicates HI-Vibration</p>
<p><b>v</b></p>	<p>Indicates LOW-Vibration</p>
<p><b>T</b></p>	<p>Indicates Tone</p>
<p><b>+</b></p>	<p>Indicates Rising Stimulation and Steps to Increase Stimulation Level</p>

## 562A FUNCTION DESCRIPTION

---

### - Stimulation

While the button is pressed, the preset stimulation level is transmitted.  
(Maximum operating time : 10 seconds)

### - Rising Stimulation

While the button is pressed, the level increases from the currently set stimulation level to the set max level for a predetermined time interval.  
(Stimulation Max Level and time interval can be set separately.)

### - Vibration

While the button is pressed, it transmits a vibration. Two vibration modes available.







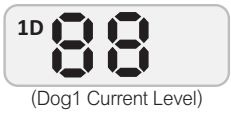
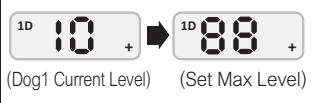

(LOW(weak vibration) / HI(strong vibration))

### - Tone or Tone followed by Stimulation (Pavlovian Conditioning)



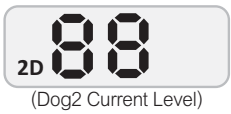
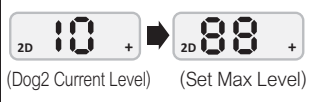

- Tone followed by Stimulation (Stimulation Level is not "0") : While the button is pressed, the tone is transmitted for 1.25 seconds.  
If the button is pressed longer than 1.25 seconds, the current level stimulation is transmitted." (Maximum operating time 10 seconds)

- Tone (Stimulation Level is "0") : While the button is pressed, only tone is transmitted instead of stimulation.

## 562A BUTTON OPERATION

Button	Function	Description	LCD Display
Black (S)	Assigned Function in <b>(P2)</b> for Dog 1 - Stimulation - Rising Stimulation - Tone - LOW-Vibration - HI-Vibration	Dog1 Stimaultion	
		Dog1 Rising Stimulation	
		Dog1 Tone or Tone followed by Stimulation * Level "0" : Tone only * Level "1~HI" : Tone followed by Stimulation	
		Dog1 LOW-Vibration	
		Dog1 HI-Vibration	
Red (S)	Assigned Function in <b>(P3)</b> for Dog 2 - Stimulation - Rising Assigned - Tone - LOW-Vibration - HI-Vibration	Dog2 Stimaultion	
		Dog2 Rising Stimulation	
		Dog2 Tone or Tone followed by Stimulation * Level "0" : Tone only * Level "1~HI" : Tone followed by Stimulation	
		Dog2 LOW-Vibration	
		Dog2 HI-Vibration	



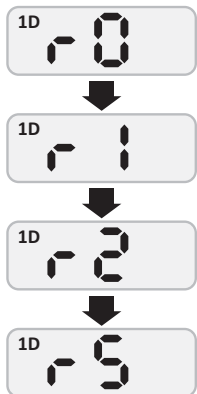
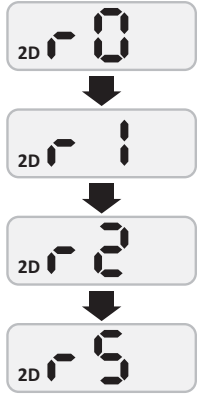





# 562A BUTTON OPERATION

Button	Function	Description	LCD Display
Ⓛ	Dog1 and Dog2 Light ON/OFF	Select Dog1 Light operation when displaying 1D on LCD Press the button within 1 second. flickering - steady - off in turn	 (Dog1 Light)
		Select Dog2 Light operation when displaying 2D on LCD Press the button within 1 second. flickering - steady - off in turn	 (Dog2 Light)
		Dog1 Light OFF when 1D is displayed on LCD * Press the Ⓛ-button for more than 1 second or longer to power light off.	 (Dog1 Light OFF)
		Dog2 Light OFF when 2D is displayed on LCD * Press the Ⓛ-button for more than 1 second or longer to power light off.	 (Dog2 Light OFF)
Ⓡ	Dog1 Rising Stimulation Time Set	When 1D is displayed on the LCD Select time interval to the maximum level in Dog1 Rising Stimulation. (Each time button is pressed, "0 sec->1 sec->2 sec->5 sec->0 sec ...")	
	Dog2 Rising Stimulation Time Set	When 2D is displayed on the LCD Select time interval to the maximum level in Dog2 Rising Stimulation. (Each time button is pressed, "0 sec->1 sec -> 2 sec -> 5 sec -> 0 sec ...")	

## 562A BUTTON OPERATION

Button	Function	Description	LCD Display
+ / -	Dog1 Stimulation Level UP/DOWN	When 1D is displayed on the LCD Dog1 Stimulation Level UP/DOWN	1D 88 (0~HI)
	Dog2 Stimulation Level UP/DOWN	When 2D is displayed on the LCD Dog2 Stimulation Level UP/DOWN	2D 88 (0~HI)
Power	Power ON/OFF	Press and hold Power button for more than 1 second to turn power on.	1D 88 V v 2D 88 T + ↓ 0n ↓ 1D 88 (Set Level)
		Press and hold Power button for more than 1.5 seconds to turn power off.	0F
Program	Dog1 / Dog2 Change	Dog1->Dog2 (or Dog2->Dog1) Standby transition	1D 88 (Dog1 Standby Display)  2D 88 (Dog2 Standby Display)
Stimulation Level = 0 + Program + 2 Seconds P1 3 Seconds P2 4 Seconds P3	Programming Mode	When the Program Button is pressed for 2 seconds it enters P1, holding for an additional 1 second it will enter P2, and holding for an additional 1 second it will enter P3.	P1 ↓ P2 ↓ P3

# 562A BUTTON OPERATION

Button	Function	Description	LCD Display
(P) Program + (-)	Lock (+), (-) Level for Dog1 when "1D" icon is blinking in the display.	<ul style="list-style-type: none"> <li>- When "1D" icon on the display is blinking, pressing the (P) button and (-) button at the same time will activate the Level Lock function.</li> <li>- "1D" icon changes from blinking to solid.</li> <li>- Pressing (+) or (-) button after Level Lock function is activated, the stimulation level does not change and only beeps.</li> </ul>	 <p>(1D icon will be solid after activation)</p>  <p>↓</p>  <p>(Display changes for a while when pressing (+) or (-) button during Level Button Lock activation)</p>
	Lock (+), (-) Level for Dog2 when "2D" icon is blinking in the display.	<ul style="list-style-type: none"> <li>- When "2D" icon on the display is blinking, pressing the (P) button and (-) button at the same time will activate the Level Lock function.</li> <li>- "2D" icon changes from blinking to solid.</li> <li>- Pressing (+) or (-) button after Level Lock function is activated, the stimulation level does not change and only beeps.</li> </ul>	 <p>(2D icon will be solid after activation)</p>  <p>↓</p>  <p>(Display changes for a while when pressing (+) or (-) button during Level Button Lock activation)</p>
	Unlock (+), (-) Level for Dog1 when "1D" icon is solid in the display.	<ul style="list-style-type: none"> <li>- When "1D" icon on the display is solid, pressing the (P) button and (-) button at the same time will deactivate the Level Lock function.</li> <li>- "1D" icon changes from solid to blinking.</li> </ul>	 <p>(1D icon will be blinking after deactivation)</p>
	Unlock (+), (-) Level for Dog2 when "2D" icon is solid in the display.	<ul style="list-style-type: none"> <li>- When "2D" icon on the display is solid, pressing the (P) button and (-) button at the same time will deactivate the Level Lock function.</li> <li>- "2D" icon changes from solid to blinking.</li> </ul>	 <p>(2D icon will be blinking after deactivation)</p>



## 562A BUTTON OPERATION

Button	Function	Description	LCD Display
(P) Program + (S) (Black)	Dog1 Rising Stimulation	Dog1 Rising Stimulation	<p>1D 10 + (Current Level) ↓ 1D 88 + (Set Max Level)</p>
(P) Program + (S) (Red)	Dog2 Rising Stimulation	Dog2 Rising Stimulation	<p>2D 10 + (Current Level) ↓ 2D 88 + (Set Max Level)</p>
Stimulation Level = 0 + (-) + (L)	Dog1 Pairing	When 1D is displayed on the LCD, Execute Pairing for Dog1	<p>1D PA</p>
	Dog2 Pairing	When 2D is displayed on the LCD, Execute Pairing for Dog2	<p>2D PA</p>
Stimulation Level = 0 + (P) Program + (+) + 3 Seconds	Change 1Dog / 2Dog Mode	1Dog-> 2Dog mode change (toggle action)	<p>1D 1d } 1Dog mode ↓ 1D 0 } 1D 2d } 2Dog mode ↓ 2D 0 }</p>

## 562A PROGRAMMING MODE

### \* How to enter program mode

- (1) After adjusting the stimulation level to "0", press and hold the **P**-button on the back of transmitter for 2 seconds to enter the program mode.
- (2) If you keep holding the button while entering the program mode, the LCD display cycles every 1 second in the order of "**P1** → **P2** → **P3** → **P1**...".

Press and hold the **P**-button to display the mode you want to set. Release to enter the setting mode.

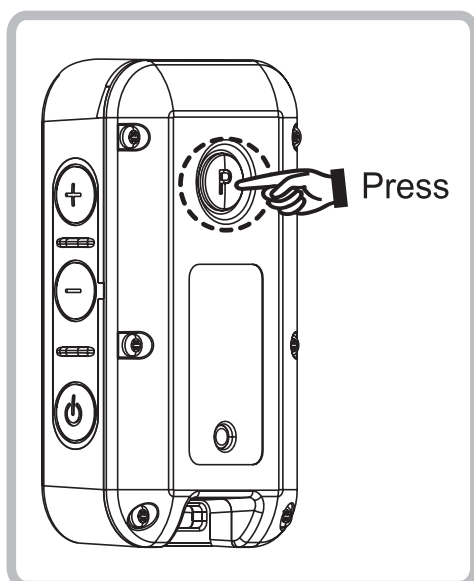

2 seconds after  
pressing the  
button...

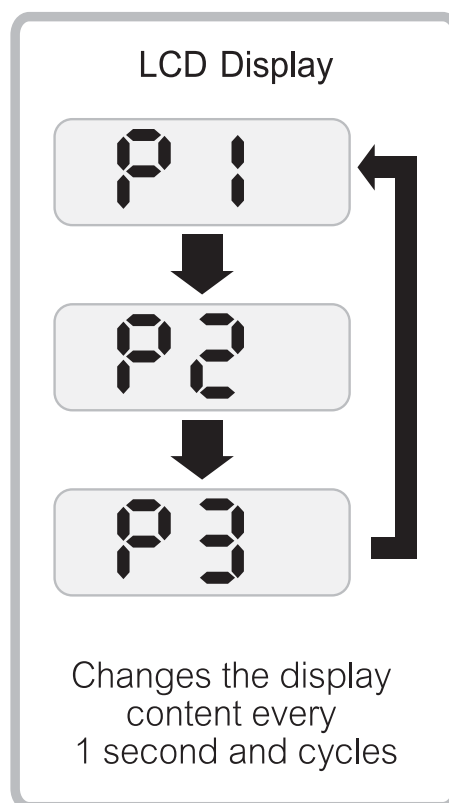

## 562A PROGRAMMING MODE

- In the program mode, the setting of 1D (DOG1) can be selected by pressing the **(S)**(Black)-button, and the setting of 2D(DOG2) can be selected by pressing the **(S)**(Red)-button.
- After setting the function of each button, press the **(P)**-button to save the changes and exit the program mode.

MODE	Setting Value	LCD Display
<b>(P1)</b>	The maximum level limit of the DOG1 stimulation can be set. (Settable level : 5 ~ HI) * Select 1D(DOG1) with <b>(S)</b> (black)-button. * Set the level value with <b>(+)</b> , <b>(-)</b> -button.	
	The maximum level limit of the DOG2 stimulation can be set. (Settable level : 5 ~ HI) * Select 2D(DOG2) with <b>(S)</b> (Red)-button. * Set the level value with <b>(+)</b> , <b>(-)</b> -button.	
<b>(P2)</b>	Sets the operation function of the <b>(S)</b> (Black)-button (Dog1). (Stimulation → Rising Stimulation → Tone → LOW Vibration → HIGH Vibration)  Select the mode by pressing <b>(S)</b> (Black)-Button	

## 562A PROGRAMMING MODE

MODE	Setting Value	LCD Display
<b>P3</b>	<p>Sets the operation function of the <b>S</b> (Red)-button (Dog2). (Stimulation → Rising Stimulation → Tone → LOW Vibration → HIGH Vibration)</p> <p>Select the mode by pressing <b>S</b> (Red)-Button</p>	<p>The LCD display sequence for mode P3 is as follows:</p> <ul style="list-style-type: none"> <li>2D St</li> <li>2D St +</li> <li>2D T</li> <li>2D Lo v</li> <li>2D Hi v</li> </ul>

\* If the maximum level limit is set in **P1**, it will not go above the set value when raising the stimulation level with the **+**-button.

### \* **+**-button stimulation level increase value setting

- You can increase the stimulation level by using the **+**-button.

(The default setting is "5" <increase level value by 5>, and can be set to "1" or "10"..)

- Setting method

1. DOG1 setting

1-1. Enter "**P2**" in program mode.

1-2. Press the **S** (Black)-button to select the "**St**" icon.

1-3. Press the **+**-button to display the desired setting among "1+", "5+" and "10+".

1-4. Press the **P**-button to save changes and exit program mode.







## 562A PROGRAMMING MODE

### 2. DOG2 setting

2-1. Enter "**P3**" in program mode.

2-3. Press the **+**-button to display the desired setting among "1+", "5+" and "10+".

2-4. Press the **P**-button to save changes and exit program mode.

Increasing Level	Operation	LCD Display	
1	Press the <b>+</b> -button to increase the stimulation level by 1.	 (Dog1 setting)	 (Dog2 setting)
5	Press the <b>+</b> -button to increase the stimulation level by 5.	 (Dog1 setting)	 (Dog2 setting)
10	Press the <b>+</b> -button to increase the stimulation level by 10.	 (Dog1 setting)	 (Dog2 setting)

\* Irrespective of the above setting, pressing the **-**-button decreases the stimulation level by 1.

## 562A PROGRAMMING MODE

### \* Setting stimulation level Increasing step

- You can increase the stimulation level by using the (+)-Button (The default setting is "5" <increase level value by 5>, and can be set to "1" or "10"..)

#### - Setting Procedure

1. Enters (P2) mode.
2. To select Stimulation Mode for Dog1, press (S)(Black)-Button until LCD shows <sup>1D</sup>5+. To select Stimulation Mode for Dog2, press (S)(Red)-Button until LCD shows <sub>2D</sub>5+ in (P3) mode.
3. Press the (+)-button to display the desired setting among "1+", "5+" and "10+".
4. Press the (P)-button to save changes and exit program mode.

Increasing Level	Operation	LCD Display
1 Step	Until LCD shows desired step as "1 +", repeat pressing (+)-Button.	 (Dog1 mode)  (Dog2 mode)
5 Steps	Until LCD shows desired step as "5 +", repeat pressing (+)-Button.	 (Dog1 mode)  (Dog2 mode)
10 Steps	Until LCD shows desired step as "10 +", repeat pressing (+)-Button.	 (Dog1 mode)  (Dog2 mode)

\* Regardless of the setting of the level increasing step, level decreasing step when press (-)-Button is fixed by 1 step.

## 562A STIMULATION LEVEL BUTTON LOCK/UNLOCK

---

The stimulation level for Dog 1 and Dog 2 set by the user can be locked and unlocked.

- **Stimulation Level Button Lock**

**[Dog 1 setting]**

- Holding down (P)-Button and pressing (-)-Button at the same time to activate the Stimulation Level Button Lock function for Dog 1 when "1D" icon on the LCD display is blinking (Stimulation Level Button Unlock Status).
- After the Stimulation Level Button Lock function for Dog 1 is activated, the "1D" icon on the LCD changes solid.
- When the Stimulation Level Up/Down Button, (+)/(-) is pressed, a beep sounds and the stimulation does not change.

**[Dog 2 setting]**

- Holding down (P)-Button and pressing (-)-Button at the same time to activate the Stimulation Level Button Lock function for Dog 2 when "2D" icon on the LCD display is blinking (Stimulation Level Button Unlock Status).
- After the Stimulation Level Button Lock function for Dog 2 is activated, the "2D" icon on the LCD changes solid.
- When the Stimulation Level Up/Down Button, (+)/(-) is pressed, a beep sounds and the stimulation does not change.

- **Stimulation Level Button Unlock**









**[Dog 1 setting]**

- Holding down (P)-Button and pressing (-)-Button at the same time to deactivate the Stimulation Level Button Lock function for Dog 1 when "1D" icon on the LCD display is solid (Stimulation Level Button Lock Status).
- After the Stimulation Level Button Lock function is deactivated, the "1D" icon on the LCD changes blinking.

**[Dog 2 setting]**

- Holding down (P)-Button and pressing (-)-Button at the same time to deactivate the Stimulation Level Button Lock function for Dog 2 when "2D" icon on the LCD display is solid (Stimulation Level Button Lock Status).
- After the Stimulation Level Button Lock function is deactivated, the "2D" icon on the LCD changes blinking.

# 562A STIMULATION LEVEL BUTTON LOCK/UNLOCK

Button	Function	Description	LCD Display
(P) Program + (-)	Lock (+), (-) Level for Dog1 when "1D" icon is blinking in the display.	<ul style="list-style-type: none"> <li>- When "1D" icon on the display is blinking, pressing the (P) button and (-) button at the same time will activate the Level Lock function.</li> <li>- "1D" icon changes from blinking to solid.</li> <li>- Pressing (+) or (-) button after Level Lock function is activated, the stimulation level does not change and only beeps.</li> </ul>	 <p>(1D icon will be solid after activation)</p>  <p>↓</p>  <p>(Display changes for a while when pressing (+) or (-) button during Level Button Lock activation)</p>
	Lock (+), (-) Level for Dog2 when "2D" icon is blinking in the display.	<ul style="list-style-type: none"> <li>- When "2D" icon on the display is blinking, pressing the (P) button and (-) button at the same time will activate the Level Lock function.</li> <li>- "2D" icon changes from blinking to solid.</li> <li>- Pressing (+) or (-) button after Level Lock function is activated, the stimulation level does not change and only beeps.</li> </ul>	 <p>(2D icon will be solid after activation)</p>  <p>↓</p>  <p>(Display changes for a while when pressing (+) or (-) button during Level Button Lock activation)</p>
	Unlock (+), (-) Level for Dog1 when "1D" icon is solid in the display.	<ul style="list-style-type: none"> <li>- When "1D" icon on the display is solid, pressing the (P) button and (-) button at the same time will deactivate the Level Lock function.</li> <li>- "1D" icon changes from solid to blinking.</li> </ul>	 <p>(1D icon will be blinking after deactivation)</p>
	Unlock (+), (-) Level for Dog2 when "2D" icon is solid in the display.	<ul style="list-style-type: none"> <li>- When "2D" icon on the display is solid, pressing the (P) button and (-) button at the same time will deactivate the Level Lock function.</li> <li>- "2D" icon changes from solid to blinking.</li> </ul>	 <p>(2D icon will be blinking after deactivation)</p>



## 562A RISING STIMULATION

---

- **Rising Stimulation Operation**

- Press the Rising Stimulation button to increase the stimulation from the current level to the maximum level.
- The time to reach the maximum level can be set by pressing the **(R)**-Button.

- **Rising Stimulation Operation Button**

- Dog1 Operation Button

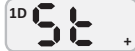
- Press Stimulation **(S)**(Black)-Button and **(P)**-Button with the current stimulation level not "0".
- In programming mode, set Stimulation **(S)**(Black)-Button to,  then press Stimulation **(S)**(Black)-Button.

- Dog2 Operation Button

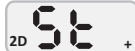
- Press Stimulation **(S)**(Red)-Button and **(P)**-Button with the current stimulation level not "0".
- In programming mode, set Stimulation **(S)**(Red)-Button to,  then press Stimulation **(S)**(Red)-Button.

- **Set stimulus level rise time**

: Time to reach the maximum stimulation level from the current stimulation level can be set.

- Every time you press **(R)**-Button in standby, "r0-> r1-> r2-> r5 ..." is changed.
- When you exit the mode from the currently selected screen, the last selected time is automatically set.

## 562A RISING STIMULATION

### Dog1 Setting

: In standby mode, press (P)-Button to display 1D and press (R)-Button to set time.

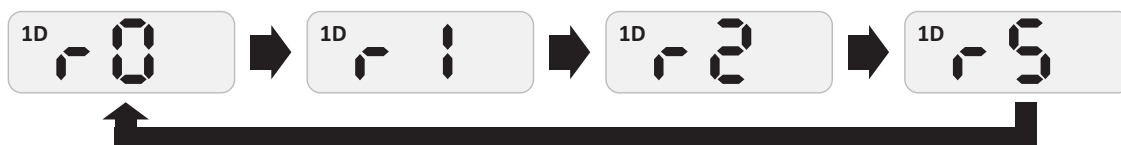

LCD Display	Description
	When the button is pressed, it immediately outputs the maximum stimulation level.(Dog1 Stimulation boosting mode)
	It takes 1 second to reach the maximum stimulation level from the current stimulation level.
	It takes 2 second to reach the maximum stimulation level from the current stimulation level.
	It takes 5 second to reach the maximum stimulation level from the current stimulation level.

- The maximum stimulation level can be set in programming mode.

### Dog2 Setting

: In standby mode, press (P)-Button to display 2D and press (R)-Button to set time.

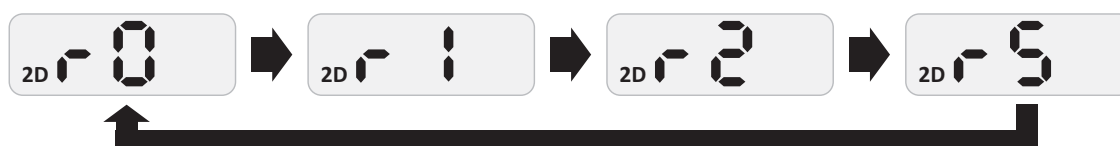

LCD Display	Description
	When the button is pressed, it immediately outputs the maximum stimulation level.(Dog2 Stimulation boosting mode)
	It takes 1 second to reach the maximum stimulation level from the current stimulation level.
	It takes 2 second to reach the maximum stimulation level from the current stimulation level.
	It takes 5 second to reach the maximum stimulation level from the current stimulation level.

- The maximum stimulation level can be set in programming mode.

## TESTING YOUR E-COLLAR

---

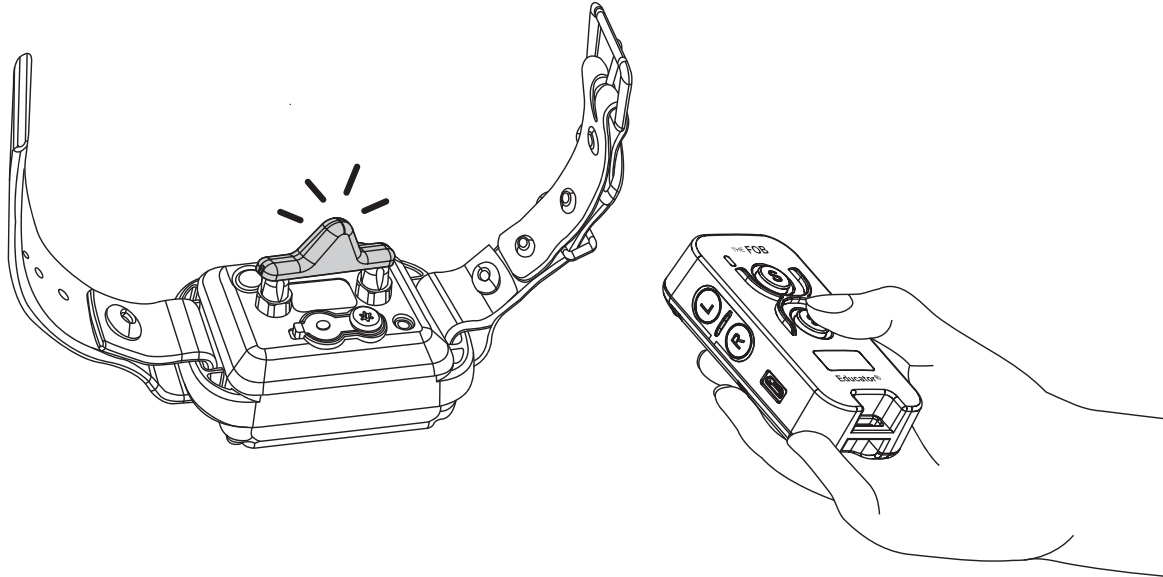

If you need to check your unit, hold the test light against the contact points on the collar receiver. This test will let you know that the collar receiver is generating the proper sensation to the dog, it should brighten in a smooth fashion as the stimulation level increases.

Some people find it easier to hold the collar receiver in the palm of their hand and slowly turn the stimulation up using the continuous mode, typical human feel it between 8 and 25 depending on the dryness of their hands.

Feel free to contact us if you need help, 1-855-326-5527.

## REPLACING THE CONTACT POINTS

---

The standard 5/8" contact points are used for most dogs. Thicker fur breeds require the longer 3/4" contact points. Replace the 5/8" contact points by following the instructions below using the enclosed contact point tool.

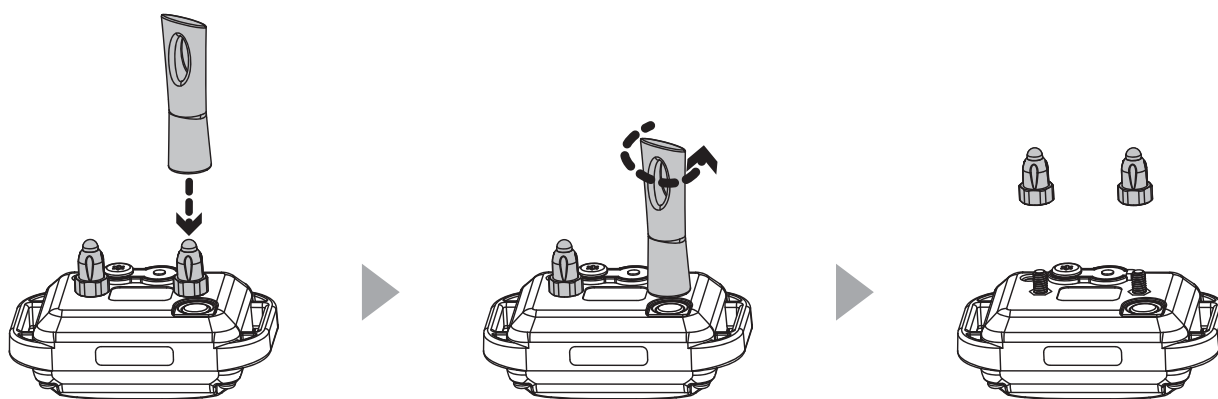

1. Loosen both contact points by rotating the contact point counter-clockwise using the contact point tool.

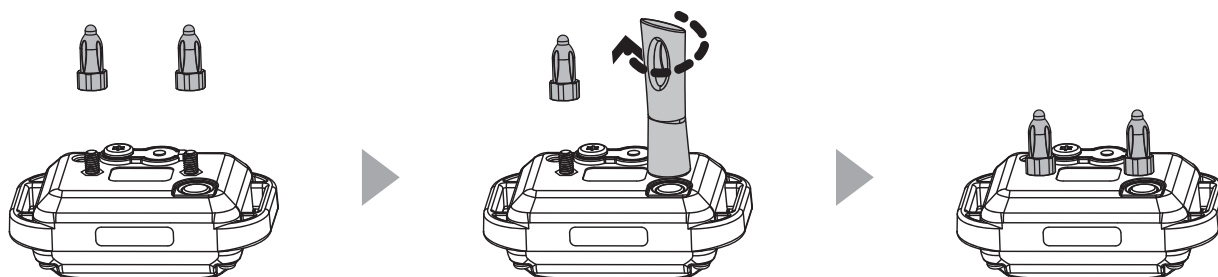

2. Install the 3/4" contact points onto the bolt and tighten the contact points by rotating them clockwise with the contact point tool.

\* For short haired breeds such as boxers, dachshund, pit bulls, etc, and thick fur breeds please visit our website or contact us to inquire about special contact points for your dog.

# FINGER TRAINER

---

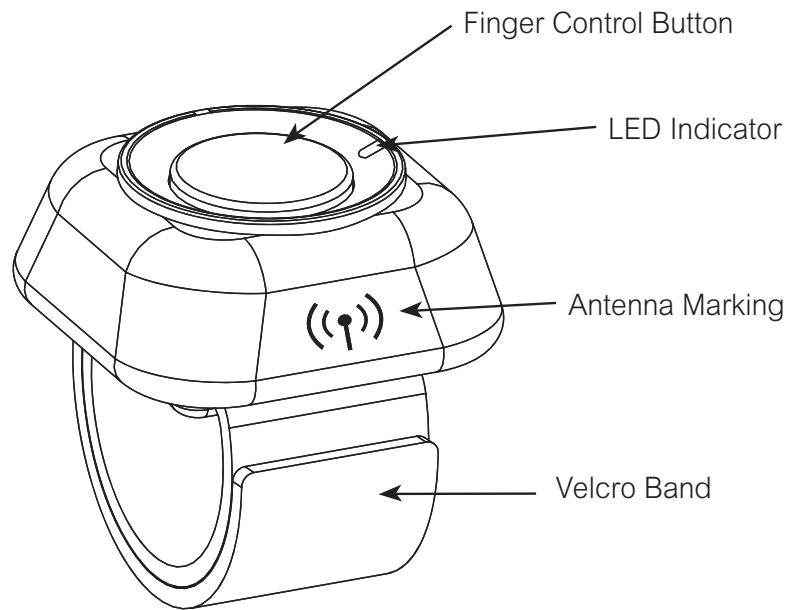

There is no power switch on Finger Trainer because it is always turned on. To minimize battery consumption, it will enter standby mode after 2 hours of inactivity.

If the Finger Control Button is pressed during standby mode, it exits from standby mode.

\* Cautions : To reduce antenna interference, make sure your fingers do not cover the antenna markings.

# PAIRING FINGER TRAINER WITH TRANSMITTER

1. Prepare Transmitter and Finger Trainer for pairing.

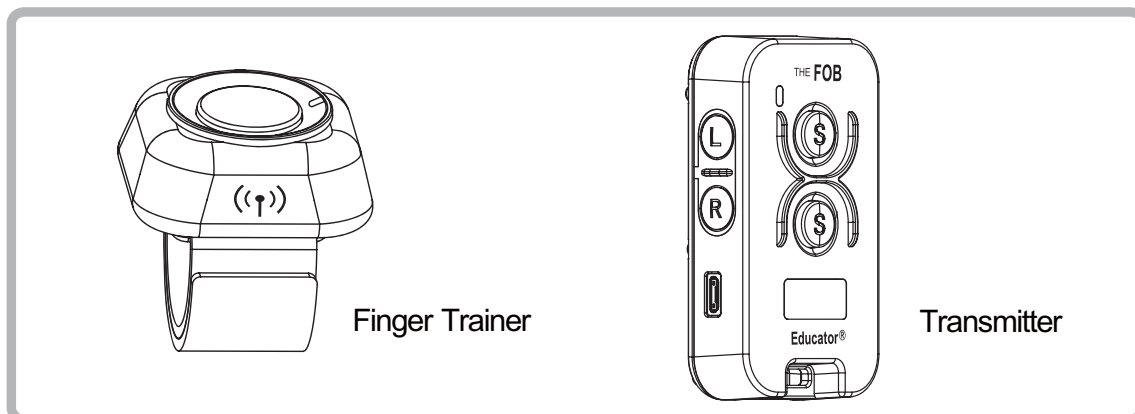

2. While holding down the control button on the Finger Trainer, turn on Transmitter

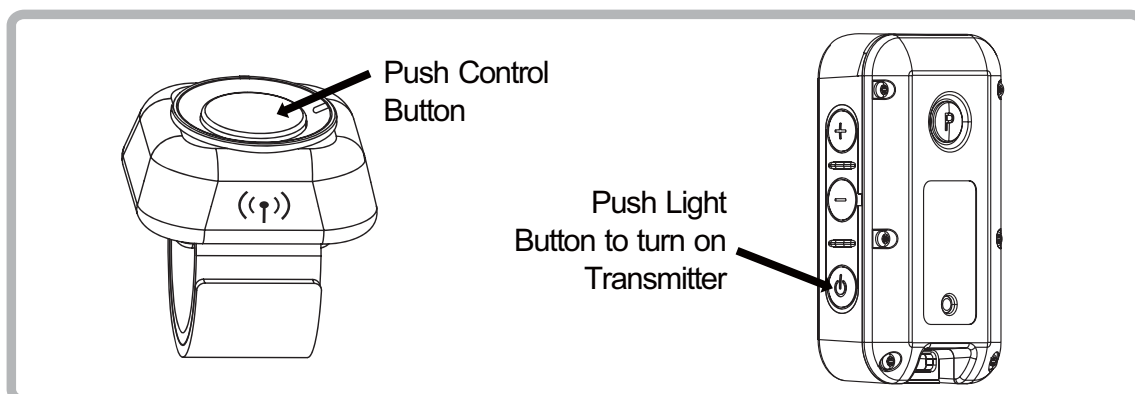

3. Release the stimulation button on the Finger Trainer when transmitter is turned on.

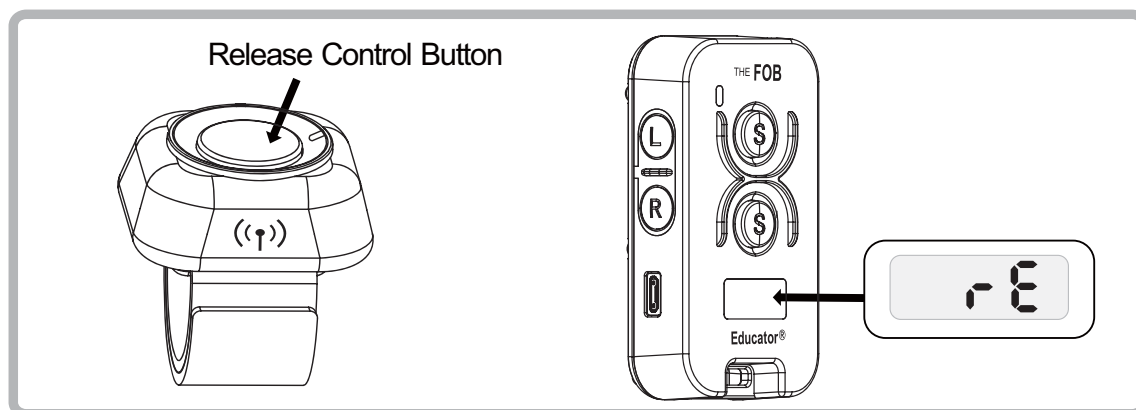

## PAIRING FINGER TRAINER WITH TRANSMITTER

---

4. Check for successful pairing (Collar Receiver is not to be on the Dog)
  - (1) Turn Transmitter stimulation dial to any value other than "0".
  - (2) Press the Finger Trainer control button and make sure the Transmitter is activating the collar receiver.  
(Stimulation Button (Black S1) is the factory default setting.)

## CHANGING THE BUTTON THE FINGER TRAINER CONTROLS ON THE TRANSMITTER

The Finger Trainer can be set to control any one of the 2 Buttons of the Transmitter, S1(Black) S2(Red) and T Button.

- How to set the Finger Trainer to control different Transmitter buttons.

Simply push the desired Transmitter Button simultaneously with the POWER button.

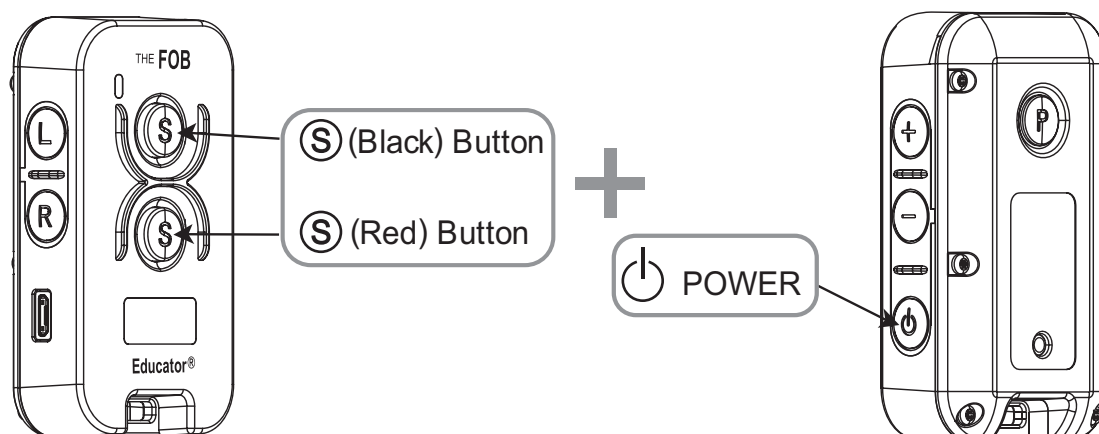

- One Dog Mode (1D)

Finger Trainer Control Button	How To Set	Possible Functions
S1(Black) Button (Default)	POWER Button + S1(Black) Button	C
S2(Red) Button	POWER Button + S2(Red) Button	T

- Two Dog Mode (2D)

Finger Trainer Control Button	How To Set	Possible Functions
S1(Black) Button (Default)	M/C-Button + S(Black)-Button	1Dog - T
S2(Red) Button	M/C-Button + S(Red)-Button	2Dog - V

NOTE: The Finger Trainer controls the physical button, not the function of the button. The Transmitter controls the function.



## **OPERATING DISTANCE AND BATTERY OF FINGER TRAINER**

---

- Operating distance between Finger Trainer and Transmitter is maximum 12 feet.
- CR2032 3 Volt Lithium Battery is used.
- To replace battery, simply remove the 4 small screws on the back of the Finger Trainer.
- Battery Life is Approximately 1 Year, life will vary with usage

**IMPORTANT TRAINING TIPS**

E-Collars can be used to reinforce commands your dog already knows or as a learning sensation when paired with leash pressure. It is not a replacement for basic leash obedience training, but a tool to allow you to better communicate with your dog. For best results, use the least amount of stimulation required to get the attention of your dog. A calm and consistent approach to training will always produce better long term results. It is highly recommended that aggressive dogs be taken to a professional trainer for evaluation before e-collar use. There are many different e-collar training techniques recommended by a variety of professional trainers. We believe you, the owner of the dog, can best determine the most successful technique for your dog. We recommend first time users immerse themselves in learning about the proper techniques or seek a professional e-collar trainer. The technique used in the initial introduction of the e-collar is very important to the success of e-collar training. Search E-Collar Technologies Incorporated on youtube and subscribe to our channel, new training videos are posted weekly. Also "Like" our Facebook page to receive more training advice and connect with other e-collar users.

**Good Luck with your training from your friends at  
E-Collar Technologies Incorporated**

## TROUBLESHOOTING

---

### ? My Receiver / Transmitter is not turning on

- A Make sure the collar receiver is fully charged. Collar receiver light should turn green when the battery is connected to the charger.

### ? My Receiver is not responding

- A Check Receiver's indicator light is blinking green and Transmitter LCD is on. Check to make sure the collar receiver's indicator light is red when the stimulation button is pressed.
- A Try pairing/syncing the transmitter to the receiver. (Page 25)

### ? The receiver doesn't seem to provide stimulation to the dog

- A Remove Contact points from Receiver. Connect Test Light to the receiver and test for stimulation. If the test light is blinking, receiver is providing stimulation.

### ? Max range of device has been decreased

- A Check Transmitter's battery condition. Working range decreases when the battery level is low.  
Keep your fingers from touching the antenna. See the bottom of page 11 for the proper technique to maximize range.

### ? You cannot change the stimulation level of the Transmitter

- A Make sure 1D or 2D on transmitter LCD is blinking. If 1D or 2D icons are solid, you cannot change stimulation. You can unlock the stimulation at any time by press **(-)**-Button while pressing **(P)**-Button.

**CONTACT US FOR EXPERT HELP WITH YOUR E-COLLAR**

## TWO YEAR WARRANTY

---

To register your FE560/562 product, please log onto our website at [www.ecollar.com](http://www.ecollar.com), click on the Product Registration link and fill out the required information. Please register your product within 30 days of your purchase. If you do not have access to a computer, please call our toll free number of 1-855-326-5527 and one of our customer service representatives will register your product for you. In the event the product is not properly registered proof of purchase is not required to obtain warranty, we will estimate your purchase date by the serial number. Misuse, improper maintenance, lost units are not covered by this warranty. Your complete satisfaction is our only concern.

**"Making Bad Dogs Good  
and Good Dogs Better!"**

## ACCESSORIES

---

- Micro-Probes Contact Points



- 50% Stimulation Reducer



- Thick-Hair Contact Points



- Short Probe Comfort Adapter



- Car Charger

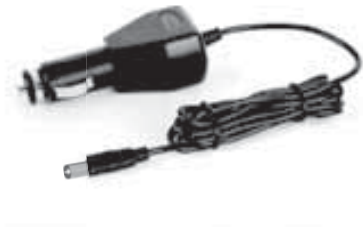

- 3/4" Quick Snap Nylon Collar (black or red)



- 3/4" Bungee Collar (24" or 30" length)



- Deluxe Hard Carry Case



[www.ecollar.com](http://www.ecollar.com)

# ACCESSORIES

---

- Dummy Collar  
(specify Nylon or Biothane strap)



- 1" MAX Probes



[www.ecollar.com](http://www.ecollar.com)

## SAFETY AND GENERAL INFORMATION

---

- The FE-560A/562A Education Collar complies with all National and International Standards and Guidelines for human exposure to radio frequency electromagnetic energy.
- Nearly all electronic devices are susceptible to electromagnetic interference (EMI) if inadequately shielded or designed without precautions to EMI.

### IMPORTANT NOTICE

1. To avoid Electromagnetic Interference and/or compatibility conflicts, please turn off your transmitter and collar receiver in any facility where posted notices instruct you to do so. Never use your equipment in close proximity of a Hospital or Health Care Facility or enter the facility without turning off both units.
2. Any change or modification made to the transmitter, including the supplied antenna, without the expressed written approval of E-Collar Technologies Incorporated could void your authority to operate.

# TRAINING NOTES

---



# TRAINING NOTES

---



# E-Collar Technologies Incorporated

2120 Forrest Park Drive  
Garrett, IN 46738-1887

1-260-357-0051 (US & International)

1-855-326-5527 (US Toll Free)

1-855-226-5527 (US Toll Free Fax)

**sales@ecollar.com**  
**www.ecollar.com**  
**customerservice@ecollar.com**



*Thank you for Supporting American Workers*

Copyright 2020 E-Collar Technologies Incorporated

All Rights Reserved.