

## FCC Test Report (Part 22)

**Report No.:** RF190130C26-6

**FCC ID:** 2ASPU-HERA51

**Test Model:** HERA51

**Received Date:** Jan. 30, 2019

**Test Date:** Feb. 13 ~ Mar. 05, 2019

**Issued Date:** Mar. 13, 2019

**Applicant:** mPLUS Technology Co., Ltd.

**Address:** 22F, 333 Dunhua S. Rd. Sec. 2, Taipei, Taiwan

**Issued By:** Bureau Veritas Consumer Products Services (H.K.) Ltd., Taoyuan Branch

**Lab Address:** No. 47-2, 14th Ling, Chia Pau Vil., Lin Kou Dist., New Taipei City, Taiwan  
(R.O.C.)

**Test Location:** No. 19, Hwa Ya 2nd Rd., Wen Hwa Vil., Kwei Shan Dist., Taoyuan City  
33383, TAIWAN (R.O.C.)

**FCC Registration /** 788550 / TW0003

**Designation Number:**



This report is for your exclusive use. Any copying or replication of this report to or for any other person or entity, or use of our name or trademark, is permitted only with our prior written permission. This report sets forth our findings solely with respect to the test samples identified herein. The results set forth in this report are not indicative or representative of the quality or characteristics of the lot from which a test sample was taken or any similar or identical product unless specifically and expressly noted. Our report includes all of the tests requested by you and the results thereof based upon the information that you provided to us. You have 60 days from date of issuance of this report to notify us of any material error or omission caused by our negligence, provided, however, that such notice shall be in writing and shall specifically address the issue you wish to raise. A failure to raise such issue within the prescribed time shall constitute your unqualified acceptance of the completeness of this report, the tests conducted and the correctness of the report contents. Unless specific mention, the uncertainty of measurement has been explicitly taken into account to declare the compliance or non-compliance to the specification. The report must not be used by the client to claim product certification, approval, or endorsement by TAF or any government agencies

## Table of Contents

<b>Release Control Record</b> .....	<b>4</b>
<b>1 Certificate of Conformity</b> .....	<b>5</b>
<b>2 Summary of Test Results</b> .....	<b>6</b>
2.1 Measurement Uncertainty.....	6
2.2 Test Site and Instruments.....	7
<b>3 General Information</b> .....	<b>8</b>
3.1 General Description of EUT.....	8
3.2 Configuration of System under Test.....	10
3.2.1 Description of Support Units.....	10
3.3 Test Mode Applicability and Tested Channel Detail.....	11
3.4 EUT Operating Conditions.....	19
3.5 General Description of Applied Standards.....	19
<b>4 Test Types and Results</b> .....	<b>20</b>
4.1 Output Power Measurement.....	20
4.1.1 Limits of Output Power Measurement.....	20
4.1.2 Test Procedures.....	20
4.1.3 Test Setup.....	21
4.1.4 Test Results.....	22
4.2 Modulation Characteristics Measurement.....	52
4.2.1 Limits of Modulation Characteristics.....	52
4.2.2 Test Procedure.....	52
4.2.3 Test Setup.....	52
4.2.4 Test Results.....	53
4.2.5 Limits of Frequency Stability Measurement.....	57
4.2.6 Test Procedure.....	57
4.2.7 Test Setup.....	57
4.2.8 Test Results.....	58
4.3 Occupied Bandwidth Measurement.....	71
4.3.1 Test Procedure.....	71
4.3.2 Test Setup.....	71
4.3.3 Test Result.....	72
4.4 Band Edge Measurement.....	86
4.4.1 Limits of Band Edge Measurement.....	86
4.4.2 Test Setup.....	86
4.4.3 Test Procedures.....	86
4.4.4 Test Results.....	87
4.5 Peak to Average Ratio.....	99
4.5.1 Limits of Peak to Average Ratio Measurement.....	99
4.5.2 Test Setup.....	99
4.5.3 Test Procedures.....	99
4.5.4 Test Results.....	100
4.6 Conducted Spurious Emissions.....	107
4.6.1 Limits of Conducted Spurious Emissions Measurement.....	107
4.6.2 Test Setup.....	107
4.6.3 Test Procedure.....	107
4.6.4 Test Results.....	108
4.7 Radiated Emission Measurement.....	156
4.7.1 Limits of Radiated Emission Measurement.....	156
4.7.2 Test Procedure.....	156
4.7.3 Deviation from Test Standard.....	156
4.7.4 Test Setup.....	157
4.7.5 Test Results.....	158

<b>5</b>	<b>Pictures of Test Arrangements.....</b>	<b>186</b>
	<b>Appendix – Information of the Testing Laboratories .....</b>	<b>187</b>

### Release Control Record

Issue No.	Description	Date Issued
RF190130C26-6	Original release	Mar. 13, 2019

## 1 Certificate of Conformity

**Product:** mobile POS

**Brand:** 

**Test Model:** HERA51

**Sample Status:** Engineering sample

**Applicant:** mPLUS Technology Co., Ltd.

**Test Date:** Feb. 13 ~ Mar. 05, 2019

**Standards:** FCC Part 22, Subpart H

The above equipment has been tested by **Bureau Veritas Consumer Products Services (H.K.) Ltd., Taoyuan Branch**, and found compliance with the requirement of the above standards. The test record, data evaluation & Equipment Under Test (EUT) configurations represented herein are true and accurate accounts of the measurements of the sample's RF characteristics under the conditions specified in this report.

**Prepared by :**  , **Date:** Mar. 13, 2019  
Polly Chien / Specialist

**Approved by :**  , **Date:** Mar. 13, 2019  
Bruce Chen / Project Engineer

## 2 Summary of Test Results

Applied Standard: FCC Part 22 & Part 2			
FCC Clause	Test Item	Result	Remarks
2.1046 22.913 (a)	Effective radiated power	Pass	Meet the requirement of limit.
2.1047	Modulation Characteristics	Pass	Meet the requirement
---	Peak To Average Ratio	Pass	Meet the requirement of limit.
2.1055 22.355	Frequency Stability	Pass	Meet the requirement of limit.
2.1049	Occupied Bandwidth	Pass	Meet the requirement of limit.
22.917	Band Edge Measurements	Pass	Meet the requirement of limit.
2.1051 22.917	Conducted Spurious Emissions	Pass	Meet the requirement of limit.
2.1053 22.917	Radiated Spurious Emissions	Pass	Meet the requirement of limit. Minimum passing margin is -23.9dB at 45.52MHz.

Note:

Determining compliance based on the results of the compliance measurement, not taking into account measurement instrumentation uncertainty.

### 2.1 Measurement Uncertainty

Where relevant, the following measurement uncertainty levels have been estimated for tests performed on the EUT as specified in CISPR 16-4-2:

Measurement	Frequency	Expanded Uncertainty (k=2) ( $\pm$ )
Radiated Emissions up to 1 GHz	9kHz ~ 30MHz	3.04 dB
	30MHz ~ 200MHz	3.63 dB
	200MHz ~ 1000MHz	3.64 dB
Radiated Emissions above 1 GHz	1GHz ~ 18GHz	2.29 dB
	18GHz ~ 40GHz	2.29 dB

## 2.2 Test Site and Instruments

Description & Manufacturer	Model No.	Serial No.	Cal. Date	Cal. Due
Test Receiver ROHDE & SCHWARZ	ESCI	100424	Jan. 03, 2019	Jan. 02, 2020
Spectrum Analyzer ROHDE & SCHWARZ	FSP40	100040	Sep. 25, 2018	Sep. 24, 2019
BILOG Antenna SCHWARZBECK	VULB9168	9168-155	Nov. 21, 2018	Nov. 20, 2019
HORN Antenna SCHWARZBECK	BBHA 9120D	9120D-1170	Nov. 25, 2018	Nov. 24, 2019
HORN Antenna SCHWARZBECK	BBHA 9170	BBHA9170241	Nov. 25, 2018	Nov. 24, 2019
Loop Antenna TESEQ	HLA 6121	45745	Jun. 14, 2018	Jun. 13, 2019
Preamplifier Agilent (Below 1GHz)	8447D	2944A10631	Aug. 08, 2018	Aug. 07, 2019
Preamplifier KEYSIGHT (Above 1GHz)	83017A	MY53270295	Jul. 02, 2018	Jul. 01, 2019
RF signal cable HUBER+SUHNER	SUCOFLEX 104	MY 13380+295012/04	Aug. 08, 2018	Aug. 07, 2019
RF signal cable HUBER+SUHNER	SUCOFLEX 104	Cable-CH4-03 (250724)	Aug. 08, 2018	Aug. 07, 2019
Software BV ADT	ADT_Radiated_ V7.6.15.9.5	NA	NA	NA
Antenna Tower inn-co GmbH	MA 4000	010303	NA	NA
Antenna Tower Controller BV ADT	AT100	AT93021703	NA	NA
Turn Table BV ADT	TT100	TT93021703	NA	NA
Turn Table Controller BV ADT	SC100	SC93021703	NA	NA
Boresight Antenna Fixture	FBA-01	FBA-SIP01	NA	NA
WIT Standard Temperature And Humidity Chamber	TH-4S-C	W981030	Jun. 04, 2018	Jun. 03, 2019
JFW 20dB attenuation	50HF-020-SMA	NA	NA	NA

- Note: 1. The calibration interval of the above test instruments is 12 months and the calibrations are traceable to NML/ROC and NIST/USA.  
 2. The test was performed in HwaYa Chamber 4.  
 3. The FCC Designation Number is TW0003. The number will be varied with the Lab location and scope as attached.  
 4. The IC Site Registration No. is 7450F-4.

### 3 General Information

#### 3.1 General Description of EUT

Product	mobile POS			
Brand				
Test Model	HERA51			
Sample Status	Engineering sample			
Power Supply Rating	5Vdc (adapter) 3.75Vdc (battery)			
Modulation Type	GSM, GPRS: GMSK EDGE: 8PSK CDMA: QPSK, OQPSK, HPSK WCDMA: BPSK, QPSK HSDPA: BPSK HSUPA: QPSK LTE: QPSK, 16QAM			
Operating Frequency	GSM/GPRS/EDGE	824.2~848.8MHz		
	CDMA	824.7~848.31MHz		
	WCDMA Band 5	826.4~846.6MHz		
	LTE Band 5 (Channel Bandwidth 1.4MHz)	824.7~848.3MHz		
	LTE Band 5 (Channel Bandwidth 3MHz)	825.5~847.5MHz		
	LTE Band 5 (Channel Bandwidth 5MHz)	826.5~846.5MHz		
	LTE Band 5 (Channel Bandwidth 10MHz)	829.0~844.0MHz		
	LTE Band 26 (Channel Bandwidth 1.4MHz)	824.7~848.3MHz		
	LTE Band 26 (Channel Bandwidth 3MHz)	825.5~847.5MHz		
	LTE Band 26 (Channel Bandwidth 5MHz)	826.5~846.5MHz		
	LTE Band 26 (Channel Bandwidth 10MHz)	829.0~844.0MHz		
	LTE Band 26 (Channel Bandwidth 15MHz)	831.5~841.5MHz		
Max. ERP Power	GSM/GPRS/EDGE	2089.296mW (33.2dBm)		
	CDMA	107.152mW (20.3dBm)		
	WCDMA Band 5	213.796mW (23.3dBm)		
		QPSK	16QAM	
	LTE Band 5 (Channel Bandwidth 1.4MHz)	144.544mW (21.6dBm)	107.152mW (20.3dBm)	
	LTE Band 5 (Channel Bandwidth 3MHz)	162.181mW (22.1dBm)	109.648mW (20.4dBm)	
	LTE Band 5 (Channel Bandwidth 5MHz)	154.882mW (21.9dBm)	109.648mW (20.4dBm)	
	LTE Band 5 (Channel Bandwidth 10MHz)	151.356mW (21.8dBm)	109.648mW (20.4dBm)	
	LTE Band 26 (Channel Bandwidth 1.4MHz)	138.038mW (21.4dBm)	109.648mW (20.4dBm)	
	LTE Band 26 (Channel Bandwidth 3MHz)	154.882mW (21.9dBm)	114.815mW (20.6dBm)	
	LTE Band 26 (Channel Bandwidth 5MHz)	147.911mW (21.7dBm)	102.329mW (20.1dBm)	
	LTE Band 26 (Channel Bandwidth 10MHz)	154.882mW (21.9dBm)	114.815mW (20.6dBm)	
	LTE Band 26 (Channel Bandwidth 15MHz)	151.356mW (21.8dBm)	114.815mW (20.6dBm)	



Emission Designator	GSM/GPRS/EDGE	260KGXW	
	CDMA	1M28F9W	
	WCDMA Band 5	4M13F9W	
		QPSK	16QAM
	LTE Band 5 (Channel Bandwidth 1.4MHz)	1M09G7D	1M09D7W
	LTE Band 5 (Channel Bandwidth 3MHz)	2M70G7D	2M70D7W
	LTE Band 5 (Channel Bandwidth 5MHz)	4M48G7D	4M49D7W
	LTE Band 5 (Channel Bandwidth 10MHz)	8M96G7D	8M97D7W
	LTE Band 26 (Channel Bandwidth 1.4MHz)	1M09G7D	1M09D7W
	LTE Band 26 (Channel Bandwidth 3MHz)	2M70G7D	2M69D7W
	LTE Band 26 (Channel Bandwidth 5MHz)	4M49G7D	4M48D7W
	LTE Band 26 (Channel Bandwidth 10MHz)	8M96G7D	8M96D7W
LTE Band 26 (Channel Bandwidth 15MHz)	13M4G7D	13M4D7W	
Antenna Type	Refer to Note		
Antenna Connector	Refer to Note		
Accessory Device	Refer to Note		
Cable Supplied	1.45m non-shielded snapon cable with one core		

Note:

1. The EUT uses following antennas.

Antenna Type	Antenna Connector	Antenna Gain (dBi)		
		Ant.	Main (TX/RX)	Diversity (RX)
PIFA	Spring	GSM 850	2.9	-4.0
		CDMA BC0	2.9	-4.0
		WCDMA Band 5	2.9	-4.0
		LTE Band 5	2.9	-4.0
		LTE Band 26	2.9	-4.0

2. The EUT uses following accessory devices.

Component	Vendor	Model	Specification
Adapter	Sunny COMPUTER TECHNOLOGY CO.,LTD.	SYS1561-1005	I/P: 100-240Vac, 1.0A MAX, 50-60Hz O/P: +5Vdc, 2A, 10W MAX.
Battery	CIPHERLAB	BA-0115A3	Rating: 3.75Vdc, 5300mAh, 19.88Wh

### 3.2 Configuration of System under Test

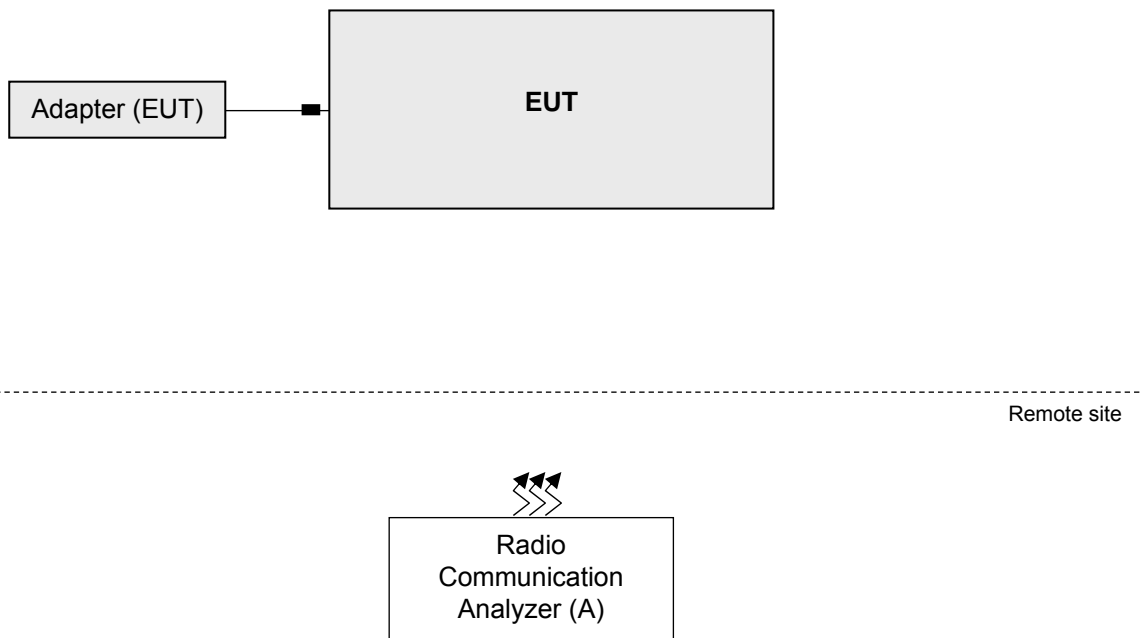

#### 3.2.1 Description of Support Units

The EUT has been tested as an independent unit together with other necessary accessories or support units. The following support units or accessories were used to form a representative test configuration during the tests.

ID	Product	Brand	Model No.	Serial No.	FCC ID	Remarks
A.	Radio Communication Analyzer	Anritsu	MT8860C	1702001	NA	-

Note:

1. All power cords of the above support units are non-shielded (1.8m).
2. Item A acted as a communication partner to transfer data.

### 3.3 Test Mode Applicability and Tested Channel Detail

Pre-Scan has been conducted to determine the worst-case mode from all possible combinations between available modulations, data rates, XYZ axis and antenna ports. The worst case was found when positioned on Z-plane. Following channel(s) was (were) selected for the final test as listed below.

#### GSM Mode

EUT Configure Mode	Test Item	Available Channel	Tested Channel	Mode
-	ERP	128 to 251	128(824.2MHz), 189(836.4MHz), 251(848.8MHz)	GSM
-	Modulation Characteristics	128 to 251	128(824.2MHz)	GSM, GPRS, EDGE
-	Frequency Stability	128 to 251	128(824.2MHz)	GSM, EDGE
-	Occupied Bandwidth	128 to 251	128(824.2MHz), 189(836.4MHz), 251(848.8MHz)	GSM, GPRS, EDGE
-	Band Edge	128 to 251	128(824.2MHz), 251(848.8MHz)	GSM, GPRS, EDGE
-	Peak To Average Ratio	128 to 251	128(824.2MHz), 189(836.4MHz), 251(848.8MHz)	GSM, GPRS, EDGE
-	Conducted Emission	128 to 251	128(824.2MHz), 189(836.4MHz), 251(848.8MHz)	GSM, GPRS, EDGE
-	Radiated Emission Below 1GHz	128 to 251	128(824.2MHz)	GSM
-	Radiated Emission Above 1GHz	128 to 251	128(824.2MHz), 189(836.4MHz), 251(848.8MHz)	GSM

CDMA Mode

EUT Configure Mode	Test Item	Available Channel	Tested Channel	Mode
-	ERP	1013 to 777	1013(824.7MHz), 384(836.52MHz), 777(848.31MHz)	RC3+SO55
-	Modulation Characteristics	1013 to 777	1013(824.7MHz)	RC1+SO03
-	Frequency Stability	1013 to 777	1013(824.7MHz), 777(848.31MHz)	RC3+SO55
-	Occupied Bandwidth	1013 to 777	1013(824.7MHz), 384(836.52MHz), 777(848.31MHz)	RC3+SO55
-	Band Edge	1013 to 777	1013(824.7MHz), 777(848.31MHz)	RC3+SO55
-	Peak To Average Ratio	1013 to 777	1013(824.7MHz), 384(836.52MHz), 777(848.31MHz)	RC3+SO55
-	Conducted Emission	1013 to 777	1013(824.7MHz), 384(836.52MHz), 777(848.31MHz)	RC3+SO55
-	Radiated Emission Below 1GHz	1013 to 777	1013(824.7MHz)	RC3+SO55
-	Radiated Emission Above 1GHz	1013 to 777	1013(824.7MHz), 384(836.52MHz), 777(848.31MHz)	RC3+SO55

### WCDMA Band 5

EUT Configure Mode	Test Item	Available Channel	Tested Channel	Mode
-	ERP	4132 to 4233	4132 (826.4MHz), 4182 (836.4MHz), 4233 (846.6MHz)	WCDMA
-	Modulation Characteristics	4132 to 4233	4132 (826.4MHz)	WCDMA, HSDPA, HSUPA
-	Frequency Stability	4132 to 4233	4132 (826.4MHz)	WCDMA
-	Occupied Bandwidth	4132 to 4233	4132 (826.4MHz), 4182 (836.4MHz), 4233 (846.6MHz)	WCDMA, HSDPA, HSUPA
-	Band Edge	4132 to 4233	4132 (826.4MHz), 4233 (846.6MHz)	WCDMA, HSDPA, HSUPA
-	Peak To Average Ratio	4132 to 4233	4132 (826.4MHz), 4182 (836.4MHz), 4233 (846.6MHz)	WCDMA, HSDPA, HSUPA
-	Conducted Emission	4132 to 4233	4132 (826.4MHz), 4182 (836.4MHz), 4233 (846.6MHz)	WCDMA, HSDPA, HSUPA
-	Radiated Emission Below 1GHz	4132 to 4233	4132 (826.4MHz)	WCDMA
-	Radiated Emission Above 1GHz	4132 to 4233	4132 (826.4MHz), 4182 (836.4MHz), 4233 (846.6MHz)	WCDMA

LTE Band 5

EUT Configure Mode	Test item	Available channel	Tested channel	Channel Bandwidth	Modulation	Mode
-	ERP	20407 to 20643	20407(824.7MHz), 20525(836.5MHz), 20643(848.3MHz)	1.4MHz	QPSK / 16QAM	1 RB / 0 RB Offset
		20415 to 20635	20415(825.5MHz), 20525(836.5MHz), 20635(847.5MHz)	3MHz	QPSK / 16QAM	1 RB / 0 RB Offset
		20425 to 20625	20425(826.5MHz), 20525(836.5MHz), 20625(846.5MHz)	5MHz	QPSK / 16QAM	1 RB / 0 RB Offset
		20450 to 20600	20450(829.0MHz), 20525(836.5MHz), 20600(844.0MHz)	10MHz	QPSK / 16QAM	1 RB / 0 RB Offset
-	Modulation characteristics	20407 to 20643	20525(836.5MHz)	10MHz	QPSK / 16QAM	1 RB / 49 RB Offset
-	Frequency Stability	20407 to 20643	20407(824.7MHz), 20643(848.3MHz)	1.4MHz	QPSK	1 RB / 5 RB Offset
		20415 to 20635	20415(825.5MHz), 20635(847.5MHz)	3MHz	QPSK	1 RB / 14 RB Offset
		20425 to 20625	20425(826.5MHz), 20625(846.5MHz)	5MHz	QPSK	1 RB / 24 RB Offset
		20450 to 20600	20450(829.0MHz), 20600(844.0MHz)	10MHz	QPSK	1 RB / 49 RB Offset
-	Occupied Bandwidth	20407 to 20643	20407(824.7MHz), 20525(836.5MHz), 20643(848.3MHz)	1.4MHz	QPSK / 16QAM	5 RB / 0RB Offset
		20415 to 20635	20415(825.5MHz), 20525(836.5MHz), 20635(847.5MHz)	3MHz	QPSK / 16QAM	14 RB / 0RB Offset
		20425 to 20625	20425(826.5MHz), 20525(836.5MHz), 20625(846.5MHz)	5MHz	QPSK / 16QAM	24RB / 0RB Offset
		20450 to 20600	20450(829.0MHz), 20525(836.5MHz), 20600(844.0MHz)	10MHz	QPSK / 16QAM	49RB / 0RB Offset
-	Band Edge	20407 to 20643	20407(824.7MHz), 20643(848.3MHz)	1.4MHz	QPSK	1 RB / 0 RB Offset 1 RB / 5 RB Offset 6 RB / 0 RB Offset
		20415 to 20635	20415(825.5MHz), 20635(847.5MHz)	3MHz	QPSK	1 RB / 0 RB Offset 1 RB / 14 RB Offset 15 RB / 0 RB Offset
		20425 to 20625	20425(826.5MHz), 20625(846.5MHz)	5MHz	QPSK	1 RB / 0 RB Offset 1 RB / 24 RB Offset 25 RB / 0 RB Offset
		20450 to 20600	20450(829.0MHz), 20600(844.0MHz)	10MHz	QPSK	1 RB / 0 RB Offset 1 RB / 49 RB Offset 50 RB / 0 RB Offset

EUT Configure Mode	Test item	Available channel	Tested channel	Channel Bandwidth	Modulation	Mode
-	Peak to Average Ratio	20407 to 20643	20407(824.7MHz), 20525(836.5MHz), 20643(848.3MHz)	1.4MHz	QPSK / 16QAM	1 RB / 5 RB Offset
		20415 to 20635	20415(825.5MHz), 20525(836.5MHz), 20635(847.5MHz)	3MHz	QPSK / 16QAM	1 RB / 14 RB Offset
		20425 to 20625	20425(826.5MHz), 20525(836.5MHz), 20625(846.5MHz)	5MHz	QPSK / 16QAM	1 RB / 24 RB Offset
		20450 to 20600	20450(829.0MHz), 20525(836.5MHz), 20600(844.0MHz)	10MHz	QPSK / 16QAM	1 RB / 49 RB Offset
-	Conducted Emission	20407 to 20643	20407(824.7MHz), 20525(836.5MHz), 20643(848.3MHz)	1.4MHz	QPSK	1 RB / 0 RB Offset
		20415 to 20635	20415(825.5MHz), 20525(836.5MHz), 20635(847.5MHz)	3MHz	QPSK	1 RB / 0 RB Offset
		20425 to 20625	20425(826.5MHz), 20525(836.5MHz), 20625(846.5MHz)	5MHz	QPSK	1 RB / 0 RB Offset
		20450 to 20600	20450(829.0MHz), 20525(836.5MHz), 20600(844.0MHz)	10MHz	QPSK	1 RB / 0 RB Offset
-	Radiated Emission Below 1GHz	20425 to 20625	20425(826.5MHz)	5MHz	QPSK	1 RB / 0 RB Offset
-	Radiated Emission Above 1GHz	20407 to 20643	20407(824.7MHz), 20525(836.5MHz), 20643(848.3MHz)	1.4MHz	QPSK	1 RB / 0 RB Offset
		20425 to 20625	20425(826.5MHz), 20525(836.5MHz), 20625(846.5MHz)	5MHz	QPSK	1 RB / 0 RB Offset
		20450 to 20600	20450(829.0MHz), 20525(836.5MHz), 20600(844.0MHz)	10MHz	QPSK	1 RB / 0 RB Offset

LTE Band 26

EUT Configure Mode	Test item	Available channel	Tested channel	Channel Bandwidth	Modulation	Mode
-	ERP	26797 to 27033	26797 (824.7MHz), 26915 (836.5MHz), 27033 (848.3MHz)	1.4MHz	QPSK / 16QAM	1 RB / 5 RB Offset
		26805 to 27025	26805 (825.5MHz), 26915 (836.5MHz), 27025 (847.5MHz)	3MHz	QPSK / 16QAM	1 RB / 14 RB Offset
		26815 to 27015	26815 (826.5MHz), 26915 (836.5MHz), 27015 (846.5MHz)	5MHz	QPSK / 16QAM	1 RB / 24 RB Offset
		26840 to 26990	26840 (829MHz), 26915 (836.5MHz), 26990 (844MHz)	10MHz	QPSK / 16QAM	1 RB / 49 RB Offset
		26865 to 26965	26865 (831.5MHz), 26915 (836.5MHz), 26965 (841.5MHz)	15MHz	QPSK / 16QAM	1 RB / 74 RB Offset
-	Modulation Characteristics	26865 to 26965	26865 (831.5MHz)	15MHz	QPSK / 16QAM	1 RB / 74 RB Offset
-	Frequency Stability	26797 to 27033	26797 (824.7MHz), 27033 (848.3MHz)	1.4MHz	QPSK / 16QAM	1 RB / 0 RB Offset
		26805 to 27025	26805 (825.5MHz), 27025 (847.5MHz)	3MHz	QPSK / 16QAM	1 RB / 0 RB Offset
		26815 to 27015	26815 (826.5MHz), 27015 (846.5MHz)	5MHz	QPSK / 16QAM	1 RB / 0 RB Offset
		26840 to 26990	26840 (829MHz), 26990 (844MHz)	10MHz	QPSK / 16QAM	1 RB / 0 RB Offset
		26865 to 26965	26865 (831.5MHz), 26965 (841.5MHz)	15MHz	QPSK / 16QAM	1 RB / 0 RB Offset
-	Occupied Bandwidth	26797 to 27033	26797 (824.7MHz), 26915 (836.5MHz), 27033 (848.3MHz)	1.4MHz	QPSK / 16QAM	1 RB / 6 RB Offset
		26805 to 27025	26805 (825.5MHz), 26915 (836.5MHz), 27025 (847.5MHz)	3MHz	QPSK / 16QAM	1 RB / 15 RB Offset
		26815 to 27015	26815 (826.5MHz), 26915 (836.5MHz), 27015 (846.5MHz)	5MHz	QPSK / 16QAM	1 RB / 25 RB Offset
		26840 to 26990	26840 (829MHz), 26915 (836.5MHz), 26990 (844MHz)	10MHz	QPSK / 16QAM	1 RB / 50 RB Offset
		26865 to 26965	26865 (831.5MHz), 26915 (836.5MHz), 26965 (841.5MHz)	15MHz	QPSK / 16QAM	1 RB / 75 RB Offset



EUT Configure Mode	Test item	Available channel	Tested channel	Channel Bandwidth	Modulation	Mode
-	Band Edge	26797 to 27033	26797 (824.7MHz), 27033 (848.3MHz)	1.4MHz	QPSK	1 RB / 0 RB Offset 1 RB / 5 RB Offset 6 RB / 0 RB Offset
		26805 to 27025	26805 (825.5MHz), 27025 (847.5MHz)	3MHz	QPSK	1 RB / 0 RB Offset 1 RB / 14 RB Offset 15 RB / 0 RB Offset
		26815 to 27015	26815 (826.5MHz), 27015 (846.5MHz)	5MHz	QPSK	1 RB / 0 RB Offset 1 RB / 24 RB Offset 25 RB / 0 RB Offset
		26840 to 26990	26840 (829MHz), 26990 (844MHz)	10MHz	QPSK	1 RB / 0 RB Offset 1 RB / 49 RB Offset 50 RB / 0 RB Offset
		26865 to 26965	26865 (831.5MHz), 26965 (841.5MHz)	15MHz	QPSK	1 RB / 0 RB Offset 1 RB / 74 RB Offset 75 RB / 0 RB Offset
-	Peak to Average Ratio	26797 to 27033	26797 (824.7MHz), 26915 (836.5MHz), 27033 (848.3MHz)	1.4MHz	QPSK / 16QAM	1 RB / 0 RB Offset
		26805 to 27025	26805 (825.5MHz), 26915 (836.5MHz), 27025 (847.5MHz)	3MHz	QPSK / 16QAM	1 RB / 0 RB Offset
		26815 to 27015	26815 (826.5MHz), 26915 (836.5MHz), 27015 (846.5MHz)	5MHz	QPSK / 16QAM	1 RB / 0 RB Offset
		26840 to 26990	26840 (829MHz), 26915 (836.5MHz), 26990 (844MHz)	10MHz	QPSK / 16QAM	1 RB / 0 RB Offset
		26865 to 26965	26865 (831.5MHz), 26915 (836.5MHz), 26965 (841.5MHz)	15MHz	QPSK / 16QAM	1 RB / 0 RB Offset
-	Conducted Emission	26797 to 27033	26797 (824.7MHz), 26915 (836.5MHz), 27033 (848.3MHz)	1.4MHz	QPSK	1 RB / 5 RB Offset
		26805 to 27025	26805 (825.5MHz), 26915 (836.5MHz), 27025 (847.5MHz)	3MHz	QPSK	1 RB / 14 RB Offset
		26815 to 27015	26815 (826.5MHz), 26915 (836.5MHz), 27015 (846.5MHz)	5MHz	QPSK	1 RB / 24 RB Offset
		26840 to 26990	26840 (829MHz), 26915 (836.5MHz), 26990 (844MHz)	10MHz	QPSK	1 RB / 49 RB Offset
		26865 to 26965	26865 (831.5MHz), 26915 (836.5MHz), 26965 (841.5MHz)	15MHz	QPSK	1 RB / 74 RB Offset

EUT Configure Mode	Test item	Available channel	Tested channel	Channel Bandwidth	Modulation	Mode
-	Radiated Emission Below 1GHz	26815 to 27015	26815 (826.5MHz)	5MHz	QPSK	1 RB / 24 RB Offset
-	Radiated Emission Above 1GHz	26797 to 27033	26797 (824.7MHz), 26915 (836.5MHz), 27033 (848.3MHz)	1.4MHz	QPSK	1 RB / 5 RB Offset
		26815 to 27015	26815 (826.5MHz), 26915 (836.5MHz), 27015 (846.5MHz)	5MHz	QPSK	1 RB / 14 RB Offset
		26865 to 26965	26865 (831.5MHz), 26915 (836.5MHz), 26965 (841.5MHz)	15MHz	QPSK	1 RB / 74 RB Offset

**Note:**

1. For radiated emission below 1GHz, low, mid and high channels were pre-tested in chamber. Low channel was the worst case for all final tests.
2. The conducted output power for QPSK and 16QAM, measured value of QPSK is higher than 16QAM mode. Therefore, Occupied bandwidth and Peak to average ratio items were tested under QPSK and 16QAM modes, and the other test items were tested under QPSK mode only.

**Test Condition:**

Test Item	Environmental Conditions	Input Power	Tested By
ERP	25deg. C, 70%RH 22deg. C, 66%RH	120Vac, 60Hz	Noah Chang, Greg Lin, Han Wu
Modulation Characteristics	24deg. C, 64%RH	120Vac, 60Hz	James Yang
Frequency Stability	24deg. C, 64%RH	120Vac, 60Hz	James Yang
Occupied Bandwidth	24deg. C, 64%RH	120Vac, 60Hz	James Yang
Band Edge	24deg. C, 64%RH	120Vac, 60Hz	James Yang
Peak To Average Ratio	24deg. C, 64%RH	120Vac, 60Hz	James Yang
Conducted Emission	24deg. C, 64%RH	120Vac, 60Hz	James Yang
Radiated Emission	25deg. C, 70%RH 22deg. C, 66%RH	120Vac, 60Hz	Luis Lee Noah Chang, Han Wu

### **3.4 EUT Operating Conditions**

The EUT makes a call to the communication simulator. The communication simulator station system controlled a EUT to export maximum output power under transmission mode and specific channel frequency

### **3.5 General Description of Applied Standards**

The EUT is a RF Product. According to the specifications of the manufacturer, it must comply with the requirements of the following standards:

**FCC 47 CFR Part 2**

**FCC 47 CFR Part 22**

**KDB 971168 D01 Power Meas License Digital Systems v03r01**

**ANSI/TIA/EIA-603-E 2016**

**ANSI 63.26-2015**

All test items have been performed and recorded as per the above standards.

## 4 Test Types and Results

### 4.1 Output Power Measurement

#### 4.1.1 Limits of Output Power Measurement

Mobile / Portable station are limited to 7 watts e.r.p.

#### 4.1.2 Test Procedures

##### EIRP / ERP Measurement:

- a. All measurements were done at low, middle and high operational frequency range. RBW and VBW is 1MHz for GSM, 5MHz for CDMA and WCDMA mode, 10MHz for LTE mode.
- b. Substitution method is used for E.I.R.P measurement. In the semi-anechoic chamber, EUT placed on the 0.8m(below or equal 1GHz) and/or 1.5m(above 1GHz) height of Turn Table, rotated the table around 360 degrees to search the maximum radiation power and receiver antenna shall be rotated vertical and horizontal polarization and moved height from 1m to 4m to find the maximum polar radiated power. The "Read Value" is the spectrum reading the maximum power value.
- c. The substitution horn antenna is substituted for EUT at the same position and signals generator export the CW signal to the substitution antenna via a TX cable. Rotated the Turn Table and moved receiving antenna to find the maximum radiation power. Adjust output power level of S.G to get a Value of spectrum reading equal to "Read Value" of step b. Record the power level of S.G
- d. EIRP = Output power level of S.G – TX cable loss + Antenna gain of substitution horn. E.R.P power can be calculated form E.I.R.P power by subtracting the gain of dipole, E.R.P power = E.I.R.P power - 2.15dBi.

Where:

$$ERP/EIRP = P_{Meas} + G_T - L_C$$

$P_{Meas}$  : Measure transmitter output power.

$G_T$  : Gain of the transmitting antenna.

$L_C$  : signal attenuation in the connecting cable between the transmitter and antenna.

##### Conducted Power Measurement:

The EUT was set up for the maximum power with GSM, CDMA, WCDMA and LTE link data modulation and link up with simulator. Set the EUT to transmit under low, middle and high channel and record the power level shown on simulator.

### 4.1.3 Test Setup

EIRP / ERP Measurement:

**For radiated emission 30MHz to 1GHz**

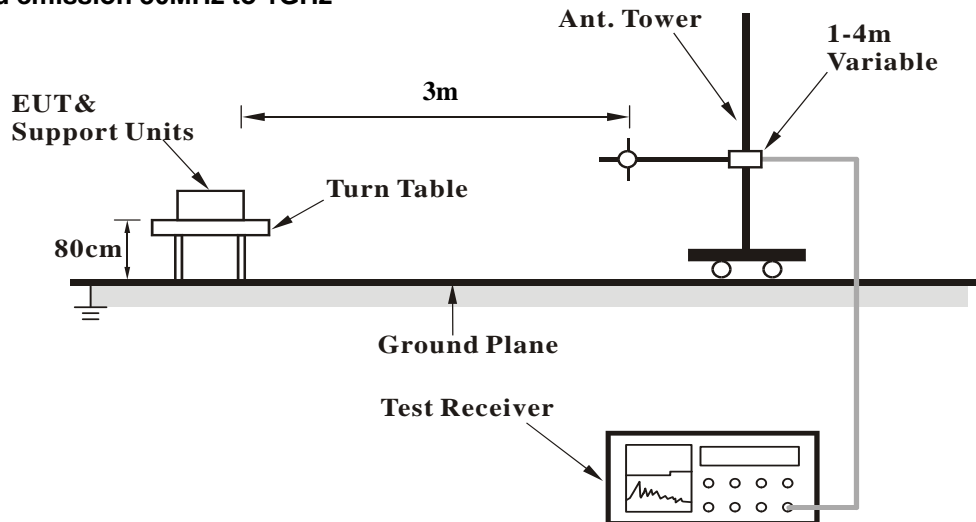

**For radiated emission above 1GHz**

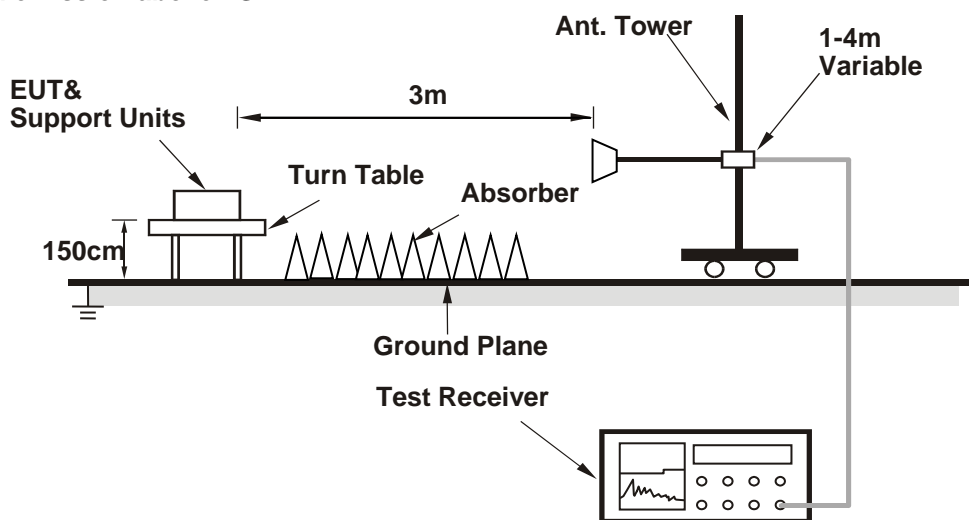

For the actual test configuration, please refer to the attached file (Test Setup Photo).

Conducted Power Measurement:



For the actual test configuration, please refer to the attached file (Test Setup Photo).

#### 4.1.4 Test Results

Conducted Output Power (dBm)

Band	GSM850		
Channel	128	189	251
Frequency	824.2	836.4	848.8
GSM	31.88	31.94	32.04
GPRS 1Tx Slot	31.86	31.92	32.02
GPRS 2Tx Slot	29.95	30.01	30.11
GPRS 3Tx Slot	28.62	28.68	28.78
GPRS 4Tx Slot	25.33	25.39	25.49
DTM 9 (GPRS)	30.01	30.07	30.17
DTM 11 (GPRS)	28.65	28.71	28.81
EDGE 1Tx Slot (MCS9)	25.36	25.42	25.52
EDGE 2Tx Slot (MCS9)	23.78	23.84	23.94
EDGE 3Tx Slot (MCS9)	22.20	22.26	22.36
EDGE 4Tx Slot (MCS9)	20.22	20.28	20.38
DTM 9 (EDGE)	25.32	25.38	25.48
DTM 11 (EDGE)	24.92	24.98	25.08

Band	CDMA2000 BC0		
Channel	1013	384	777
Frequency (MHz)	824.7	836.52	848.31
RC1+SO55	24.16	24.27	24.19
RC3+SO55	24.18	24.29	24.21
RC3+SO32(+ F-SCH)	23.86	23.97	23.89
RC3+SO32(+SCH)	23.59	23.70	23.62
RC1+SO3, 1/8 Rate	23.91	24.02	23.94
RTAP 153.6	24.02	24.13	24.05
RETAP 4096	23.82	23.93	23.85

Band	WCDMA Band V		
Channel	4132	4182	4233
Frequency (MHz)	826.4	836.4	846.6
RMC 12.2K	22.81	22.85	22.88
HSDPA Subtest-1	22.25	21.81	21.68
HSDPA Subtest-2	22.03	21.83	21.71
HSDPA Subtest-3	21.59	21.30	21.26
HSDPA Subtest-4	21.58	21.30	21.26
DC-HSDPA Subtest-1	22.22	21.78	21.65
DC-HSDPA Subtest-2	22.00	21.80	21.68
DC-HSDPA Subtest-3	21.56	21.27	21.23
DC-HSDPA Subtest-4	21.55	21.27	21.23
HSUPA Subtest-1	21.80	21.73	21.72
HSUPA Subtest-2	19.74	19.61	19.58
HSUPA Subtest-3	20.61	20.69	20.67
HSUPA Subtest-4	19.62	19.51	19.65
HSUPA Subtest-5	21.70	21.60	21.70

LTE Band 5								
BW	MCS Index	RB Size	RB Offset	Low	Mid	High	3GPP MPR (dB)	Max. Tune-up (dBm)
		Channel		20450	20525	20600		
		Frequency (MHz)		829	836.5	844		
10M	QPSK	1	0	22.76	22.66	22.78	0	23.5
		1	24	22.81	22.71	22.83	0	23.5
		1	49	22.74	22.64	22.76	0	23.5
		25	0	21.73	21.63	21.75	1	22.5
		25	12	21.70	21.60	21.72	1	22.5
		25	25	21.68	21.58	21.70	1	22.5
		50	0	21.74	21.64	21.76	1	22.5
	16QAM	1	0	21.36	21.26	21.38	1	22.5
		1	24	21.62	21.52	21.64	1	22.5
		1	49	21.37	21.27	21.39	1	22.5
		25	0	20.89	20.79	20.91	2	21.5
		25	12	20.87	20.77	20.89	2	21.5
		25	25	21.01	20.91	21.03	2	21.5
		50	0	20.77	20.67	20.79	2	21.5
BW	MCS Index	Channel		20425	20525	20625	3GPP MPR	Max. Tune-up
		Frequency (MHz)		826.5	836.5	846.5		
5M	QPSK	1	0	22.69	22.66	22.77	0	23.5
		1	12	22.76	22.64	22.78	0	23.5
		1	24	22.64	22.57	22.69	0	23.5
		12	0	21.70	21.63	21.75	1	22.5
		12	6	21.69	21.54	21.69	1	22.5
		12	13	21.68	21.55	21.70	1	22.5
		25	0	21.66	21.57	21.74	1	22.5
	16QAM	1	0	21.32	21.21	21.29	1	22.5
		1	12	21.53	21.44	21.56	1	22.5
		1	24	21.33	21.24	21.31	1	22.5
		12	0	20.81	20.78	20.89	2	21.5
		12	6	20.78	20.73	20.82	2	21.5
		12	13	20.96	20.84	21.00	2	21.5
		25	0	20.76	20.60	20.70	2	21.5

LTE Band 5								
BW	MCS Index	Channel		20415	20525	20635	3GPP MPR	Max. Tune-up
		Frequency (MHz)		825.5	836.5	847.5		
3M	QPSK	1	0	22.67	22.55	22.68	0	23.5
		1	7	22.71	22.65	22.63	0	23.5
		1	14	22.58	22.61	22.53	0	23.5
		8	0	21.55	21.51	21.59	1	22.5
		8	3	21.62	21.55	21.63	1	22.5
		8	7	21.54	21.44	21.63	1	22.5
		15	0	21.64	21.61	21.75	1	22.5
	16QAM	1	0	21.27	21.22	21.30	1	22.5
		1	7	21.46	21.38	21.45	1	22.5
		1	14	21.33	21.16	21.21	1	22.5
		8	0	20.68	20.70	20.84	2	21.5
		8	3	20.84	20.73	20.80	2	21.5
		8	7	20.87	20.72	20.82	2	21.5
		15	0	20.68	20.56	20.73	2	21.5
BW	MCS Index	Channel		20407	20525	20643	3GPP MPR	Max. Tune-up
		Frequency (MHz)		824.7	836.5	848.3		
1.4M	QPSK	1	0	22.59	22.58	22.77	0	23.5
		1	2	22.64	22.63	22.69	0	23.5
		1	5	22.69	22.45	22.75	0	23.5
		3	0	22.56	22.42	22.65	0	23.5
		3	1	22.47	22.48	22.63	0	23.5
		3	3	22.59	22.50	22.54	0	23.5
		6	0	21.67	21.52	21.60	1	22.5
	16QAM	1	0	21.17	21.11	21.30	1	22.5
		1	2	21.43	21.47	21.56	1	22.5
		1	5	21.18	21.15	21.29	1	22.5
		3	0	21.66	21.62	21.74	1	22.5
		3	1	21.66	21.67	21.68	1	22.5
		3	3	21.90	21.79	21.80	1	22.5
		6	0	20.72	20.58	20.79	2	21.5



LTE Band 26								
BW	MCS Index	RB Size	RB Offset	Low	Mid	High	3GPP MPR (dB)	Max. Tune-up (dBm)
		Channel		26865	26915	26965		
		Frequency (MHz)		831.5	836.5	841.5		
15M	QPSK	1	0	22.32	22.26	22.34	0	23.5
		1	37	22.73	22.67	22.75	0	23.5
		1	74	22.40	22.34	22.42	0	23.5
		36	0	21.32	21.26	21.34	1	22.5
		36	19	21.27	21.21	21.29	1	22.5
		36	39	21.35	21.29	21.37	1	22.5
		75	0	21.28	21.22	21.30	1	22.5
	16QAM	1	0	21.09	21.03	21.11	1	22.5
		1	37	21.12	21.06	21.14	1	22.5
		1	74	21.13	21.07	21.15	1	22.5
		36	0	20.17	20.11	20.19	2	21.5
		36	19	20.20	20.14	20.22	2	21.5
		36	39	20.17	20.11	20.19	2	21.5
		75	0	20.15	20.09	20.17	2	21.5
BW	MCS Index	Channel		26840	26915	26990	3GPP MPR	Max. Tune-up
		Frequency (MHz)		829	836.5	844		
10M	QPSK	1	0	22.28	22.18	22.25	0	23.5
		1	24	22.65	22.66	22.71	0	23.5
		1	49	22.32	22.27	22.34	0	23.5
		25	0	21.31	21.19	21.25	1	22.5
		25	12	21.22	21.19	21.20	1	22.5
		25	25	21.32	21.27	21.31	1	22.5
		50	0	21.21	21.15	21.29	1	22.5
	16QAM	1	0	21.01	20.93	21.08	1	22.5
		1	24	21.12	21.02	21.04	1	22.5
		1	49	21.05	21.06	21.07	1	22.5
		25	0	20.14	20.06	20.15	2	21.5
		25	12	20.15	20.13	20.17	2	21.5
		25	25	20.14	20.05	20.19	2	21.5
		50	0	20.09	20.09	20.16	2	21.5

LTE Band 26								
BW	MCS Index	Channel		26815	26915	27015	3GPP MPR	Max. Tune-up
		Frequency (MHz)		826.5	836.5	846.5		
5M	QPSK	1	0	22.17	22.14	22.18	0	23.5
		1	12	22.69	22.57	22.59	0	23.5
		1	24	22.21	22.28	22.22	0	23.5
		12	0	21.25	21.15	21.09	1	22.5
		12	6	21.02	21.00	21.19	1	22.5
		12	13	21.26	21.07	21.22	1	22.5
	16QAM	25	0	21.12	21.05	21.16	1	22.5
		1	0	21.04	20.92	21.10	1	22.5
		1	12	21.01	20.83	20.96	1	22.5
		1	24	21.03	20.85	20.95	1	22.5
		12	0	19.96	19.99	20.01	2	21.5
		12	6	20.06	20.05	20.08	2	21.5
		12	13	20.07	19.91	20.07	2	21.5
25	0	19.95	19.99	19.99	2	21.5		
BW	MCS Index	Channel		26805	26915	27025	3GPP MPR	Max. Tune-up
		Frequency (MHz)		825.5	836.5	847.5		
3M	QPSK	1	0	22.16	22.09	22.08	0	23.5
		1	7	22.59	22.52	22.59	0	23.5
		1	14	22.19	22.09	22.13	0	23.5
		8	0	21.13	21.16	21.05	1	22.5
		8	3	21.13	21.16	21.18	1	22.5
		8	7	21.23	21.12	21.14	1	22.5
		15	0	21.08	21.13	21.24	1	22.5
	16QAM	1	0	21.02	20.91	21.01	1	22.5
		1	7	20.91	21.02	20.96	1	22.5
		1	14	20.89	21.00	21.11	1	22.5
		8	0	20.09	19.99	20.04	2	21.5
		8	3	20.16	19.98	20.16	2	21.5
		8	7	20.00	20.01	20.08	2	21.5
15	0	19.92	20.00	19.93	2	21.5		

LTE Band 26								
BW	MCS Index	Channel		26797	26915	27033	3GPP MPR	Max. Tune-up
		Frequency (MHz)		824.7	836.5	848.3		
1.4M	QPSK	1	0	22.19	22.20	22.22	0	23.5
		1	2	22.68	22.56	22.58	0	23.5
		1	5	22.31	22.23	22.33	0	23.5
		3	0	22.24	22.04	22.12	0	23.5
		3	1	22.13	22.19	22.13	0	23.5
		3	3	22.16	22.23	22.25	0	23.5
	16QAM	6	0	21.03	21.10	21.22	1	22.5
		1	0	20.95	20.88	20.98	1	22.5
		1	2	20.88	20.98	20.94	1	22.5
		1	5	21.11	21.01	21.09	1	22.5
		3	0	21.09	21.10	21.03	1	22.5
		3	1	21.07	21.01	21.20	1	22.5
		3	3	20.99	20.94	21.00	1	22.5
		6	0	20.04	19.91	20.00	2	21.5

LTE Band 26_For 824-848MHz								
BW	MCS Index	Channel		26865	26915	26965	3GPP MPR	Max. Tune-up
		Frequency (MHz)		831.5	836.5	841.5		
15M	QPSK	1	0	22.26	22.16	22.34	0	23.5
		1	37	22.67	22.67	22.75	0	23.5
		1	74	22.34	22.32	22.42	0	23.5
		36	0	21.26	21.18	21.34	1	22.5
		36	19	21.21	21.12	21.29	1	22.5
		36	39	21.29	21.24	21.37	1	22.5
		75	0	21.22	21.14	21.30	1	22.5
	16QAM	1	0	21.03	20.99	21.11	1	22.5
		1	37	21.06	21.02	21.14	1	22.5
		1	74	21.07	21.07	21.15	1	22.5
		36	0	20.11	20.02	20.19	2	21.5
		36	19	20.14	20.05	20.22	2	21.5
		36	39	20.11	20.03	20.19	2	21.5
		75	0	20.09	20.00	20.17	2	21.5
BW	MCS Index	Channel		26840	26915	26990	3GPP MPR	Max. Tune-up
		Frequency (MHz)		829.0	836.5	844.0		
10M	QPSK	1	0	22.23	22.02	22.25	0	23.5
		1	24	22.65	22.63	22.71	0	23.5
		1	49	22.26	22.20	22.34	0	23.5
		25	0	21.17	21.14	21.25	1	22.5
		25	12	21.09	21.08	21.20	1	22.5
		25	25	21.19	21.22	21.31	1	22.5
		50	0	21.15	21.03	21.29	1	22.5
	16QAM	1	0	20.99	20.87	21.08	1	22.5
		1	24	21.03	20.99	21.04	1	22.5
		1	49	21.05	21.03	21.07	1	22.5
		25	0	20.01	19.88	20.15	2	21.5
		25	12	20.14	19.94	20.17	2	21.5
		25	25	20.03	19.97	20.19	2	21.5
		50	0	19.95	19.87	20.16	2	21.5

LTE Band 26_For 824-848MHz								
BW	MCS Index	Channel		26815	26915	27015	3GPP MPR	Max. Tune-up
		Frequency (MHz)		826.5	836.5	846.5		
5M	QPSK	1	0	22.14	21.99	22.18	0	23.5
		1	12	22.58	22.49	22.59	0	23.5
		1	24	22.12	22.09	22.22	0	23.5
		12	0	21.11	21.14	21.09	1	22.5
		12	6	21.01	21.03	21.19	1	22.5
		12	13	21.13	21.10	21.22	1	22.5
		25	0	21.14	20.97	21.16	1	22.5
	16QAM	1	0	20.86	20.72	21.10	1	22.5
		1	12	21.02	20.96	20.96	1	22.5
		1	24	20.94	20.97	20.95	1	22.5
		12	0	19.93	19.76	20.01	2	21.5
		12	6	19.99	19.82	20.08	2	21.5
		12	13	20.00	19.93	20.07	2	21.5
		25	0	19.90	19.78	19.99	2	21.5
BW	MCS Index	Channel		26805	26915	27025	3GPP MPR	Max. Tune-up
		Frequency (MHz)		825.5	836.5	847.5		
3M	QPSK	1	0	22.01	22.22	22.08	0	23.5
		1	7	22.60	22.61	22.59	0	23.5
		1	14	22.10	22.34	22.13	0	23.5
		8	0	21.03	21.14	21.05	1	22.5
		8	3	20.96	21.19	21.18	1	22.5
		8	7	21.14	21.18	21.14	1	22.5
		15	0	20.97	21.19	21.24	1	22.5
	16QAM	1	0	20.80	20.96	21.01	1	22.5
		1	7	20.88	20.96	20.96	1	22.5
		1	14	20.96	21.06	21.11	1	22.5
		8	0	19.74	20.15	20.04	2	21.5
		8	3	19.85	20.03	20.16	2	21.5
		8	7	19.93	20.11	20.08	2	21.5
		15	0	19.77	20.06	19.93	2	21.5

**LTE Band 26\_For 824-848MHz**

BW	MCS Index	Channel		26797	26915	27033	3GPP MPR	Max. Tune-up
		Frequency (MHz)		824.7	836.5	848.3		
1.4M	QPSK	1	0	21.97	22.22	22.22	0	23.5
		1	2	22.49	22.61	22.58	0	23.5
		1	5	22.08	22.26	22.33	0	23.5
		3	0	22.04	22.20	22.12	0	23.5
		3	1	21.98	22.07	22.13	0	23.5
		3	3	22.08	22.16	22.25	0	23.5
	16QAM	6	0	20.96	21.25	21.22	1	22.5
		1	0	20.79	21.04	20.98	1	22.5
		1	2	20.93	20.95	20.94	1	22.5
		1	5	20.97	20.98	21.09	1	22.5
		3	0	20.83	21.00	21.03	1	22.5
		3	1	20.82	21.04	21.20	1	22.5
		3	3	20.91	21.17	21.00	1	22.5
		6	0	19.77	20.01	20.00	2	21.5

**ERP Power**  
GSM Mode

MODE		TX channel 128					
Antenna Polarity & Test Distance: Horizontal at 3 M							
No.	Freq. (MHz)	Reading (dBm)	S.G Power Value (dBm)	Correction Factor (dB)	ERP (dBm)	Limit (dBm)	Margin (dB)
1	824.20	-4.5	26.6	0.0	26.6	38.5	-11.9
Antenna Polarity & Test Distance: Vertical at 3 M							
No.	Freq. (MHz)	Reading (dBm)	S.G Power Value (dBm)	Correction Factor (dB)	ERP (dBm)	Limit (dBm)	Margin (dB)
1	824.20	1.1	33.1	0.0	33.1	38.5	-5.4

MODE		TX channel 189					
Antenna Polarity & Test Distance: Horizontal at 3 M							
No.	Freq. (MHz)	Reading (dBm)	S.G Power Value (dBm)	Correction Factor (dB)	ERP (dBm)	Limit (dBm)	Margin (dB)
1	836.40	-4.1	27.1	0.2	27.3	38.5	-11.2
Antenna Polarity & Test Distance: Vertical at 3 M							
No.	Freq. (MHz)	Reading (dBm)	S.G Power Value (dBm)	Correction Factor (dB)	ERP (dBm)	Limit (dBm)	Margin (dB)
1	836.40	1.2	33.0	0.2	<b>33.2</b>	38.5	-5.3

MODE		TX channel 251					
Antenna Polarity & Test Distance: Horizontal at 3 M							
No.	Freq. (MHz)	Reading (dBm)	S.G Power Value (dBm)	Correction Factor (dB)	ERP (dBm)	Limit (dBm)	Margin (dB)
1	848.80	-3.8	26.7	0.5	27.2	38.5	-11.3
Antenna Polarity & Test Distance: Vertical at 3 M							
No.	Freq. (MHz)	Reading (dBm)	S.G Power Value (dBm)	Correction Factor (dB)	ERP (dBm)	Limit (dBm)	Margin (dB)
1	848.80	0.8	32.1	0.5	32.6	38.5	-5.9

Note: ERP (dBm) = S.G Power Value (dBm) + Correction Factor (dB).

CDMA Mode

MODE		TX channel 1013					
Antenna Polarity & Test Distance: Horizontal at 3 M							
No.	Freq. (MHz)	Reading (dBm)	S.G Power Value (dBm)	Correction Factor (dB)	ERP (dBm)	Limit (dBm)	Margin (dB)
1	824.70	-13.6	17.5	0.0	17.5	38.5	-21.0
Antenna Polarity & Test Distance: Vertical at 3 M							
No.	Freq. (MHz)	Reading (dBm)	S.G Power Value (dBm)	Correction Factor (dB)	ERP (dBm)	Limit (dBm)	Margin (dB)
1	824.70	-11.8	20.1	0.0	20.1	38.5	-18.4

MODE		TX channel 384					
Antenna Polarity & Test Distance: Horizontal at 3 M							
No.	Freq. (MHz)	Reading (dBm)	S.G Power Value (dBm)	Correction Factor (dB)	ERP (dBm)	Limit (dBm)	Margin (dB)
1	836.52	-14.2	17.0	0.2	17.2	38.5	-21.3
Antenna Polarity & Test Distance: Vertical at 3 M							
No.	Freq. (MHz)	Reading (dBm)	S.G Power Value (dBm)	Correction Factor (dB)	ERP (dBm)	Limit (dBm)	Margin (dB)
1	836.52	-11.7	20.1	0.2	<b>20.3</b>	38.5	-18.2

MODE		TX channel 777					
Antenna Polarity & Test Distance: Horizontal at 3 M							
No.	Freq. (MHz)	Reading (dBm)	S.G Power Value (dBm)	Correction Factor (dB)	ERP (dBm)	Limit (dBm)	Margin (dB)
1	848.31	-13.2	17.3	0.5	17.8	38.5	-20.7
Antenna Polarity & Test Distance: Vertical at 3 M							
No.	Freq. (MHz)	Reading (dBm)	S.G Power Value (dBm)	Correction Factor (dB)	ERP (dBm)	Limit (dBm)	Margin (dB)
1	848.31	-12.1	19.3	0.5	19.8	38.5	-18.7

Note: ERP (dBm) = S.G Power Value (dBm) + Correction Factor (dB).



WCDMA Band 5

MODE		TX channel 4132					
Antenna Polarity & Test Distance: Horizontal at 3 M							
No.	Freq. (MHz)	Reading (dBm)	S.G Power Value (dBm)	Correction Factor (dB)	ERP (dBm)	Limit (dBm)	Margin (dB)
1	826.40	-14.2	16.9	0.0	16.9	38.5	-21.6
Antenna Polarity & Test Distance: Vertical at 3 M							
No.	Freq. (MHz)	Reading (dBm)	S.G Power Value (dBm)	Correction Factor (dB)	ERP (dBm)	Limit (dBm)	Margin (dB)
1	826.40	-9.1	22.8	0.0	22.8	38.5	-15.7

MODE		TX channel 4182					
Antenna Polarity & Test Distance: Horizontal at 3 M							
No.	Freq. (MHz)	Reading (dBm)	S.G Power Value (dBm)	Correction Factor (dB)	ERP (dBm)	Limit (dBm)	Margin (dB)
1	836.40	-14.1	17.1	0.2	17.3	38.5	-21.2
Antenna Polarity & Test Distance: Vertical at 3 M							
No.	Freq. (MHz)	Reading (dBm)	S.G Power Value (dBm)	Correction Factor (dB)	ERP (dBm)	Limit (dBm)	Margin (dB)
1	836.40	-8.9	22.9	0.2	23.1	38.5	-15.4

MODE		TX channel 4233					
Antenna Polarity & Test Distance: Horizontal at 3 M							
No.	Freq. (MHz)	Reading (dBm)	S.G Power Value (dBm)	Correction Factor (dB)	ERP (dBm)	Limit (dBm)	Margin (dB)
1	846.60	-13.2	17.2	0.4	17.6	38.5	-20.9
Antenna Polarity & Test Distance: Vertical at 3 M							
No.	Freq. (MHz)	Reading (dBm)	S.G Power Value (dBm)	Correction Factor (dB)	ERP (dBm)	Limit (dBm)	Margin (dB)
1	846.60	-8.3	22.9	0.4	<b>23.3</b>	38.5	-15.2

Note: ERP (dBm) = S.G Power Value (dBm) + Correction Factor (dB).

**Modulation Type: QPSK**

LTE Band 5, Channel Bandwidth: 1.4MHz

MODE		TX channel 20407					
Antenna Polarity & Test Distance: Horizontal at 3 M							
No.	Freq. (MHz)	Reading (dBm)	S.G Power Value (dBm)	Correction Factor (dB)	ERP (dBm)	Limit (dBm)	Margin (dB)
1	824.70	-18.4	9.2	3.9	13.1	38.5	-25.4
Antenna Polarity & Test Distance: Vertical at 3 M							
No.	Freq. (MHz)	Reading (dBm)	S.G Power Value (dBm)	Correction Factor (dB)	ERP (dBm)	Limit (dBm)	Margin (dB)
1	824.70	-10.6	17.7	3.9	<b>21.6</b>	38.5	-16.9

MODE		TX channel 20525					
Antenna Polarity & Test Distance: Horizontal at 3 M							
No.	Freq. (MHz)	Reading (dBm)	S.G Power Value (dBm)	Correction Factor (dB)	ERP (dBm)	Limit (dBm)	Margin (dB)
1	836.50	-18.9	8.6	3.8	12.4	38.5	-26.1
Antenna Polarity & Test Distance: Vertical at 3 M							
No.	Freq. (MHz)	Reading (dBm)	S.G Power Value (dBm)	Correction Factor (dB)	ERP (dBm)	Limit (dBm)	Margin (dB)
1	836.50	-10.5	17.6	3.8	21.4	38.5	-17.1

MODE		TX channel 20643					
Antenna Polarity & Test Distance: Horizontal at 3 M							
No.	Freq. (MHz)	Reading (dBm)	S.G Power Value (dBm)	Correction Factor (dB)	ERP (dBm)	Limit (dBm)	Margin (dB)
1	848.30	-18.7	9.0	3.4	12.4	38.5	-26.1
Antenna Polarity & Test Distance: Vertical at 3 M							
No.	Freq. (MHz)	Reading (dBm)	S.G Power Value (dBm)	Correction Factor (dB)	ERP (dBm)	Limit (dBm)	Margin (dB)
1	848.30	-10.3	17.8	3.4	21.2	38.5	-17.3

Note: ERP (dBm) = S.G Power Value (dBm) + Correction Factor (dB).

LTE Band 5, Channel Bandwidth: 3MHz

MODE		TX channel 20415					
Antenna Polarity & Test Distance: Horizontal at 3 M							
No.	Freq. (MHz)	Reading (dBm)	S.G Power Value (dBm)	Correction Factor (dB)	ERP (dBm)	Limit (dBm)	Margin (dB)
1	825.50	-18.9	8.7	3.9	12.6	38.5	-25.9
Antenna Polarity & Test Distance: Vertical at 3 M							
No.	Freq. (MHz)	Reading (dBm)	S.G Power Value (dBm)	Correction Factor (dB)	ERP (dBm)	Limit (dBm)	Margin (dB)
1	825.50	-10.1	18.2	3.9	<b>22.1</b>	38.5	-16.4

MODE		TX channel 20525					
Antenna Polarity & Test Distance: Horizontal at 3 M							
No.	Freq. (MHz)	Reading (dBm)	S.G Power Value (dBm)	Correction Factor (dB)	ERP (dBm)	Limit (dBm)	Margin (dB)
1	836.50	-18.6	8.8	3.8	12.6	38.5	-25.9
Antenna Polarity & Test Distance: Vertical at 3 M							
No.	Freq. (MHz)	Reading (dBm)	S.G Power Value (dBm)	Correction Factor (dB)	ERP (dBm)	Limit (dBm)	Margin (dB)
1	836.50	-10.5	17.6	3.8	21.4	38.5	-17.1

MODE		TX channel 20635					
Antenna Polarity & Test Distance: Horizontal at 3 M							
No.	Freq. (MHz)	Reading (dBm)	S.G Power Value (dBm)	Correction Factor (dB)	ERP (dBm)	Limit (dBm)	Margin (dB)
1	847.50	-18.5	9.1	3.4	12.5	38.5	-26.0
Antenna Polarity & Test Distance: Vertical at 3 M							
No.	Freq. (MHz)	Reading (dBm)	S.G Power Value (dBm)	Correction Factor (dB)	ERP (dBm)	Limit (dBm)	Margin (dB)
1	847.50	-10.7	17.5	3.4	20.9	38.5	-17.6

Note: ERP (dBm) = S.G Power Value (dBm) + Correction Factor (dB).

LTE Band 5, Channel Bandwidth: 5MHz

MODE		TX channel 20425					
Antenna Polarity & Test Distance: Horizontal at 3 M							
No.	Freq. (MHz)	Reading (dBm)	S.G Power Value (dBm)	Correction Factor (dB)	ERP (dBm)	Limit (dBm)	Margin (dB)
1	826.50	-18.9	8.7	3.9	12.6	38.5	-25.9
Antenna Polarity & Test Distance: Vertical at 3 M							
No.	Freq. (MHz)	Reading (dBm)	S.G Power Value (dBm)	Correction Factor (dB)	ERP (dBm)	Limit (dBm)	Margin (dB)
1	826.50	-10.4	18.0	3.9	<b>21.9</b>	38.5	-16.6

MODE		TX channel 20525					
Antenna Polarity & Test Distance: Horizontal at 3 M							
No.	Freq. (MHz)	Reading (dBm)	S.G Power Value (dBm)	Correction Factor (dB)	ERP (dBm)	Limit (dBm)	Margin (dB)
1	836.50	-18.6	8.9	3.8	12.7	38.5	-25.8
Antenna Polarity & Test Distance: Vertical at 3 M							
No.	Freq. (MHz)	Reading (dBm)	S.G Power Value (dBm)	Correction Factor (dB)	ERP (dBm)	Limit (dBm)	Margin (dB)
1	836.50	-10.2	17.9	3.8	21.7	38.5	-16.8

MODE		TX channel 20625					
Antenna Polarity & Test Distance: Horizontal at 3 M							
No.	Freq. (MHz)	Reading (dBm)	S.G Power Value (dBm)	Correction Factor (dB)	ERP (dBm)	Limit (dBm)	Margin (dB)
1	846.50	-18.3	9.3	3.4	12.7	38.5	-25.8
Antenna Polarity & Test Distance: Vertical at 3 M							
No.	Freq. (MHz)	Reading (dBm)	S.G Power Value (dBm)	Correction Factor (dB)	ERP (dBm)	Limit (dBm)	Margin (dB)
1	846.50	-10.3	17.9	3.4	21.3	38.5	-17.2

Note: ERP (dBm) = S.G Power Value (dBm) + Correction Factor (dB).

LTE Band 5, Channel Bandwidth: 10MHz

MODE		TX channel 20450					
Antenna Polarity & Test Distance: Horizontal at 3 M							
No.	Freq. (MHz)	Reading (dBm)	S.G Power Value (dBm)	Correction Factor (dB)	ERP (dBm)	Limit (dBm)	Margin (dB)
1	829.00	-18.8	8.9	3.9	12.8	38.5	-25.7
Antenna Polarity & Test Distance: Vertical at 3 M							
No.	Freq. (MHz)	Reading (dBm)	S.G Power Value (dBm)	Correction Factor (dB)	ERP (dBm)	Limit (dBm)	Margin (dB)
1	829.00	-10.3	17.9	3.9	<b>21.8</b>	38.5	-16.7

MODE		TX channel 20525					
Antenna Polarity & Test Distance: Horizontal at 3 M							
No.	Freq. (MHz)	Reading (dBm)	S.G Power Value (dBm)	Correction Factor (dB)	ERP (dBm)	Limit (dBm)	Margin (dB)
1	836.50	-18.2	9.2	3.8	13.0	38.5	-25.5
Antenna Polarity & Test Distance: Vertical at 3 M							
No.	Freq. (MHz)	Reading (dBm)	S.G Power Value (dBm)	Correction Factor (dB)	ERP (dBm)	Limit (dBm)	Margin (dB)
1	836.50	-10.4	17.7	3.8	21.5	38.5	-17.0

MODE		TX channel 20600					
Antenna Polarity & Test Distance: Horizontal at 3 M							
No.	Freq. (MHz)	Reading (dBm)	S.G Power Value (dBm)	Correction Factor (dB)	ERP (dBm)	Limit (dBm)	Margin (dB)
1	844.00	-18.4	9.1	3.7	12.8	38.5	-25.7
Antenna Polarity & Test Distance: Vertical at 3 M							
No.	Freq. (MHz)	Reading (dBm)	S.G Power Value (dBm)	Correction Factor (dB)	ERP (dBm)	Limit (dBm)	Margin (dB)
1	844.00	-10.5	17.9	3.7	21.6	38.5	-16.9

Note: ERP (dBm) = S.G Power Value (dBm) + Correction Factor (dB).

LTE Band 26, Channel Bandwidth 1.4MHz

MODE		TX channel 26797					
Antenna Polarity & Test Distance: Horizontal at 3 M							
No.	Freq. (MHz)	Reading (dBm)	S.G Power Value (dBm)	Correction Factor (dB)	ERP (dBm)	Limit (dBm)	Margin (dB)
1	824.70	-17.2	10.4	3.9	14.3	38.5	-24.2
Antenna Polarity & Test Distance: Vertical at 3 M							
No.	Freq. (MHz)	Reading (dBm)	S.G Power Value (dBm)	Correction Factor (dB)	ERP (dBm)	Limit (dBm)	Margin (dB)
1	824.70	-10.9	17.5	3.9	<b>21.4</b>	38.5	-17.1

MODE		TX channel 26915					
Antenna Polarity & Test Distance: Horizontal at 3 M							
No.	Freq. (MHz)	Reading (dBm)	S.G Power Value (dBm)	Correction Factor (dB)	ERP (dBm)	Limit (dBm)	Margin (dB)
1	836.50	-17.4	10.1	3.8	13.9	38.5	-24.6
Antenna Polarity & Test Distance: Vertical at 3 M							
No.	Freq. (MHz)	Reading (dBm)	S.G Power Value (dBm)	Correction Factor (dB)	ERP (dBm)	Limit (dBm)	Margin (dB)
1	836.50	-10.5	17.6	3.8	<b>21.4</b>	38.5	-17.1

MODE		TX channel 27033					
Antenna Polarity & Test Distance: Horizontal at 3 M							
No.	Freq. (MHz)	Reading (dBm)	S.G Power Value (dBm)	Correction Factor (dB)	ERP (dBm)	Limit (dBm)	Margin (dB)
1	848.30	-16.8	10.9	3.4	14.3	38.5	-24.2
Antenna Polarity & Test Distance: Vertical at 3 M							
No.	Freq. (MHz)	Reading (dBm)	S.G Power Value (dBm)	Correction Factor (dB)	ERP (dBm)	Limit (dBm)	Margin (dB)
1	848.30	-10.7	17.4	3.4	20.8	38.5	-17.7

Note: ERP (dBm) = S.G Power Value (dBm) + Correction Factor (dB).

LTE Band 26, Channel Bandwidth 3MHz

MODE		TX channel 26805					
Antenna Polarity & Test Distance: Horizontal at 3 M							
No.	Freq. (MHz)	Reading (dBm)	S.G Power Value (dBm)	Correction Factor (dB)	ERP (dBm)	Limit (dBm)	Margin (dB)
1	825.50	-16.9	10.7	3.9	14.6	38.5	-23.9
Antenna Polarity & Test Distance: Vertical at 3 M							
No.	Freq. (MHz)	Reading (dBm)	S.G Power Value (dBm)	Correction Factor (dB)	ERP (dBm)	Limit (dBm)	Margin (dB)
1	825.50	-10.4	18.0	3.9	<b>21.9</b>	38.5	-16.6

MODE		TX channel 26915					
Antenna Polarity & Test Distance: Horizontal at 3 M							
No.	Freq. (MHz)	Reading (dBm)	S.G Power Value (dBm)	Correction Factor (dB)	ERP (dBm)	Limit (dBm)	Margin (dB)
1	836.50	-16.9	10.6	3.8	14.4	38.5	-24.1
Antenna Polarity & Test Distance: Vertical at 3 M							
No.	Freq. (MHz)	Reading (dBm)	S.G Power Value (dBm)	Correction Factor (dB)	ERP (dBm)	Limit (dBm)	Margin (dB)
1	836.50	-10.5	17.6	3.8	21.4	38.5	-17.1

MODE		TX channel 27025					
Antenna Polarity & Test Distance: Horizontal at 3 M							
No.	Freq. (MHz)	Reading (dBm)	S.G Power Value (dBm)	Correction Factor (dB)	ERP (dBm)	Limit (dBm)	Margin (dB)
1	847.50	-17.0	10.6	3.4	14.0	38.5	-24.5
Antenna Polarity & Test Distance: Vertical at 3 M							
No.	Freq. (MHz)	Reading (dBm)	S.G Power Value (dBm)	Correction Factor (dB)	ERP (dBm)	Limit (dBm)	Margin (dB)
1	847.50	-10.2	18.0	3.4	21.4	38.5	-17.1

Note: ERP (dBm) = S.G Power Value (dBm) + Correction Factor (dB).

LTE Band 26, Channel Bandwidth 5MHz

MODE		TX channel 26815					
Antenna Polarity & Test Distance: Horizontal at 3 M							
No.	Freq. (MHz)	Reading (dBm)	S.G Power Value (dBm)	Correction Factor (dB)	ERP (dBm)	Limit (dBm)	Margin (dB)
1	826.50	-17.3	10.3	3.9	14.2	38.5	-24.3
Antenna Polarity & Test Distance: Vertical at 3 M							
No.	Freq. (MHz)	Reading (dBm)	S.G Power Value (dBm)	Correction Factor (dB)	ERP (dBm)	Limit (dBm)	Margin (dB)
1	826.50	-10.6	17.7	3.9	21.6	38.5	-16.9

MODE		TX channel 26915					
Antenna Polarity & Test Distance: Horizontal at 3 M							
No.	Freq. (MHz)	Reading (dBm)	S.G Power Value (dBm)	Correction Factor (dB)	ERP (dBm)	Limit (dBm)	Margin (dB)
1	836.50	-17.2	10.2	3.8	14.0	38.5	-24.5
Antenna Polarity & Test Distance: Vertical at 3 M							
No.	Freq. (MHz)	Reading (dBm)	S.G Power Value (dBm)	Correction Factor (dB)	ERP (dBm)	Limit (dBm)	Margin (dB)
1	836.50	-10.2	17.9	3.8	<b>21.7</b>	38.5	-16.8

MODE		TX channel 27015					
Antenna Polarity & Test Distance: Horizontal at 3 M							
No.	Freq. (MHz)	Reading (dBm)	S.G Power Value (dBm)	Correction Factor (dB)	ERP (dBm)	Limit (dBm)	Margin (dB)
1	846.50	-17.3	10.3	3.4	13.7	38.5	-24.8
Antenna Polarity & Test Distance: Vertical at 3 M							
No.	Freq. (MHz)	Reading (dBm)	S.G Power Value (dBm)	Correction Factor (dB)	ERP (dBm)	Limit (dBm)	Margin (dB)
1	846.50	-10.1	18.1	3.4	21.5	38.5	-17.0

Note: ERP (dBm) = S.G Power Value (dBm) + Correction Factor (dB).



LTE Band 26, Channel Bandwidth 10MHz

MODE		TX channel 26840					
Antenna Polarity & Test Distance: Horizontal at 3 M							
No.	Freq. (MHz)	Reading (dBm)	S.G Power Value (dBm)	Correction Factor (dB)	ERP (dBm)	Limit (dBm)	Margin (dB)
1	829.00	-17.3	10.4	3.9	14.3	38.5	-24.2
Antenna Polarity & Test Distance: Vertical at 3 M							
No.	Freq. (MHz)	Reading (dBm)	S.G Power Value (dBm)	Correction Factor (dB)	ERP (dBm)	Limit (dBm)	Margin (dB)
1	829.00	-10.3	17.9	3.9	21.8	38.5	-16.7

MODE		TX channel 26915					
Antenna Polarity & Test Distance: Horizontal at 3 M							
No.	Freq. (MHz)	Reading (dBm)	S.G Power Value (dBm)	Correction Factor (dB)	ERP (dBm)	Limit (dBm)	Margin (dB)
1	836.50	-17.6	9.9	3.8	13.7	38.5	-24.8
Antenna Polarity & Test Distance: Vertical at 3 M							
No.	Freq. (MHz)	Reading (dBm)	S.G Power Value (dBm)	Correction Factor (dB)	ERP (dBm)	Limit (dBm)	Margin (dB)
1	836.50	-10.5	17.6	3.8	21.4	38.5	-17.1

MODE		TX channel 26990					
Antenna Polarity & Test Distance: Horizontal at 3 M							
No.	Freq. (MHz)	Reading (dBm)	S.G Power Value (dBm)	Correction Factor (dB)	ERP (dBm)	Limit (dBm)	Margin (dB)
1	844.00	-17.4	10.1	3.7	13.8	38.5	-24.7
Antenna Polarity & Test Distance: Vertical at 3 M							
No.	Freq. (MHz)	Reading (dBm)	S.G Power Value (dBm)	Correction Factor (dB)	ERP (dBm)	Limit (dBm)	Margin (dB)
1	844.00	-10.2	18.2	3.7	<b>21.9</b>	38.5	-16.6

Note: ERP (dBm) = S.G Power Value (dBm) + Correction Factor (dB).

LTE Band 26, Channel Bandwidth 15MHz

MODE		TX channel 26865					
Antenna Polarity & Test Distance: Horizontal at 3 M							
No.	Freq. (MHz)	Reading (dBm)	S.G Power Value (dBm)	Correction Factor (dB)	ERP (dBm)	Limit (dBm)	Margin (dB)
1	831.50	-17.5	10.0	3.9	13.9	38.5	-24.6
Antenna Polarity & Test Distance: Vertical at 3 M							
No.	Freq. (MHz)	Reading (dBm)	S.G Power Value (dBm)	Correction Factor (dB)	ERP (dBm)	Limit (dBm)	Margin (dB)
1	831.50	-10.1	17.9	3.9	<b>21.8</b>	38.5	-16.7

MODE		TX channel 26915					
Antenna Polarity & Test Distance: Horizontal at 3 M							
No.	Freq. (MHz)	Reading (dBm)	S.G Power Value (dBm)	Correction Factor (dB)	ERP (dBm)	Limit (dBm)	Margin (dB)
1	836.50	-17.4	10.1	3.8	13.9	38.5	-24.6
Antenna Polarity & Test Distance: Vertical at 3 M							
No.	Freq. (MHz)	Reading (dBm)	S.G Power Value (dBm)	Correction Factor (dB)	ERP (dBm)	Limit (dBm)	Margin (dB)
1	836.50	-10.4	17.7	3.8	21.5	38.5	-17.0

MODE		TX channel 26965					
Antenna Polarity & Test Distance: Horizontal at 3 M							
No.	Freq. (MHz)	Reading (dBm)	S.G Power Value (dBm)	Correction Factor (dB)	ERP (dBm)	Limit (dBm)	Margin (dB)
1	841.50	-17.6	9.9	3.6	13.5	38.5	-25.0
Antenna Polarity & Test Distance: Vertical at 3 M							
No.	Freq. (MHz)	Reading (dBm)	S.G Power Value (dBm)	Correction Factor (dB)	ERP (dBm)	Limit (dBm)	Margin (dB)
1	841.50	-10.3	18.1	3.6	21.7	38.5	-16.8

Note: ERP (dBm) = S.G Power Value (dBm) + Correction Factor (dB).

**Modulation Type: 16QAM**

LTE Band 5, Channel Bandwidth: 1.4MHz

MODE		TX channel 20407					
Antenna Polarity & Test Distance: Horizontal at 3 M							
No.	Freq. (MHz)	Reading (dBm)	S.G Power Value (dBm)	Correction Factor (dB)	ERP (dBm)	Limit (dBm)	Margin (dB)
1	824.70	-20.0	7.6	3.9	11.5	38.5	-27.0
Antenna Polarity & Test Distance: Vertical at 3 M							
No.	Freq. (MHz)	Reading (dBm)	S.G Power Value (dBm)	Correction Factor (dB)	ERP (dBm)	Limit (dBm)	Margin (dB)
1	824.70	-11.9	16.4	3.9	<b>20.3</b>	38.5	-18.2

MODE		TX channel 20525					
Antenna Polarity & Test Distance: Horizontal at 3 M							
No.	Freq. (MHz)	Reading (dBm)	S.G Power Value (dBm)	Correction Factor (dB)	ERP (dBm)	Limit (dBm)	Margin (dB)
1	836.50	-19.6	7.8	3.8	11.6	38.5	-26.9
Antenna Polarity & Test Distance: Vertical at 3 M							
No.	Freq. (MHz)	Reading (dBm)	S.G Power Value (dBm)	Correction Factor (dB)	ERP (dBm)	Limit (dBm)	Margin (dB)
1	836.50	-11.6	16.5	3.8	<b>20.3</b>	38.5	-18.2

MODE		TX channel 20643					
Antenna Polarity & Test Distance: Horizontal at 3 M							
No.	Freq. (MHz)	Reading (dBm)	S.G Power Value (dBm)	Correction Factor (dB)	ERP (dBm)	Limit (dBm)	Margin (dB)
1	848.30	-19.6	8.1	3.4	11.5	38.5	-27.0
Antenna Polarity & Test Distance: Vertical at 3 M							
No.	Freq. (MHz)	Reading (dBm)	S.G Power Value (dBm)	Correction Factor (dB)	ERP (dBm)	Limit (dBm)	Margin (dB)
1	848.30	-11.2	16.9	3.4	<b>20.3</b>	38.5	-18.2

Note: ERP (dBm) = S.G Power Value (dBm) + Correction Factor (dB).

LTE Band 5, Channel Bandwidth: 3MHz

MODE		TX channel 20415					
Antenna Polarity & Test Distance: Horizontal at 3 M							
No.	Freq. (MHz)	Reading (dBm)	S.G Power Value (dBm)	Correction Factor (dB)	ERP (dBm)	Limit (dBm)	Margin (dB)
1	825.50	-19.7	7.9	3.9	11.8	38.5	-26.7
Antenna Polarity & Test Distance: Vertical at 3 M							
No.	Freq. (MHz)	Reading (dBm)	S.G Power Value (dBm)	Correction Factor (dB)	ERP (dBm)	Limit (dBm)	Margin (dB)
1	825.50	-11.9	16.5	3.9	<b>20.4</b>	38.5	-18.1

MODE		TX channel 20525					
Antenna Polarity & Test Distance: Horizontal at 3 M							
No.	Freq. (MHz)	Reading (dBm)	S.G Power Value (dBm)	Correction Factor (dB)	ERP (dBm)	Limit (dBm)	Margin (dB)
1	836.50	-19.6	7.8	3.8	11.6	38.5	-26.9
Antenna Polarity & Test Distance: Vertical at 3 M							
No.	Freq. (MHz)	Reading (dBm)	S.G Power Value (dBm)	Correction Factor (dB)	ERP (dBm)	Limit (dBm)	Margin (dB)
1	836.50	-11.6	16.5	3.8	20.3	38.5	-18.2

MODE		TX channel 20635					
Antenna Polarity & Test Distance: Horizontal at 3 M							
No.	Freq. (MHz)	Reading (dBm)	S.G Power Value (dBm)	Correction Factor (dB)	ERP (dBm)	Limit (dBm)	Margin (dB)
1	847.50	-19.5	8.1	3.4	11.5	38.5	-27.0
Antenna Polarity & Test Distance: Vertical at 3 M							
No.	Freq. (MHz)	Reading (dBm)	S.G Power Value (dBm)	Correction Factor (dB)	ERP (dBm)	Limit (dBm)	Margin (dB)
1	847.50	-11.7	16.5	3.4	19.9	38.5	-18.6

Note: ERP (dBm) = S.G Power Value (dBm) + Correction Factor (dB).

LTE Band 5, Channel Bandwidth: 5MHz

MODE		TX channel 20425					
Antenna Polarity & Test Distance: Horizontal at 3 M							
No.	Freq. (MHz)	Reading (dBm)	S.G Power Value (dBm)	Correction Factor (dB)	ERP (dBm)	Limit (dBm)	Margin (dB)
1	826.50	-19.7	7.9	3.9	11.8	38.5	-26.7
Antenna Polarity & Test Distance: Vertical at 3 M							
No.	Freq. (MHz)	Reading (dBm)	S.G Power Value (dBm)	Correction Factor (dB)	ERP (dBm)	Limit (dBm)	Margin (dB)
1	826.50	-11.9	16.4	3.9	20.3	38.5	-18.2

MODE		TX channel 20525					
Antenna Polarity & Test Distance: Horizontal at 3 M							
No.	Freq. (MHz)	Reading (dBm)	S.G Power Value (dBm)	Correction Factor (dB)	ERP (dBm)	Limit (dBm)	Margin (dB)
1	836.50	-19.6	7.9	3.8	11.7	38.5	-26.8
Antenna Polarity & Test Distance: Vertical at 3 M							
No.	Freq. (MHz)	Reading (dBm)	S.G Power Value (dBm)	Correction Factor (dB)	ERP (dBm)	Limit (dBm)	Margin (dB)
1	836.50	-11.8	16.3	3.8	20.1	38.5	-18.4

MODE		TX channel 20625					
Antenna Polarity & Test Distance: Horizontal at 3 M							
No.	Freq. (MHz)	Reading (dBm)	S.G Power Value (dBm)	Correction Factor (dB)	ERP (dBm)	Limit (dBm)	Margin (dB)
1	846.50	-19.4	8.2	3.4	11.6	38.5	-26.9
Antenna Polarity & Test Distance: Vertical at 3 M							
No.	Freq. (MHz)	Reading (dBm)	S.G Power Value (dBm)	Correction Factor (dB)	ERP (dBm)	Limit (dBm)	Margin (dB)
1	846.50	-11.2	17.0	3.4	<b>20.4</b>	38.5	-18.1

Note: ERP (dBm) = S.G Power Value (dBm) + Correction Factor (dB).

LTE Band 5, Channel Bandwidth: 10MHz

MODE		TX channel 20450					
Antenna Polarity & Test Distance: Horizontal at 3 M							
No.	Freq. (MHz)	Reading (dBm)	S.G Power Value (dBm)	Correction Factor (dB)	ERP (dBm)	Limit (dBm)	Margin (dB)
1	829.00	-20.1	7.6	3.9	11.5	38.5	-27.0
Antenna Polarity & Test Distance: Vertical at 3 M							
No.	Freq. (MHz)	Reading (dBm)	S.G Power Value (dBm)	Correction Factor (dB)	ERP (dBm)	Limit (dBm)	Margin (dB)
1	829.00	-12.1	16.1	3.9	20.0	38.5	-18.5

MODE		TX channel 20525					
Antenna Polarity & Test Distance: Horizontal at 3 M							
No.	Freq. (MHz)	Reading (dBm)	S.G Power Value (dBm)	Correction Factor (dB)	ERP (dBm)	Limit (dBm)	Margin (dB)
1	836.50	-19.6	7.8	3.8	11.6	38.5	-26.9
Antenna Polarity & Test Distance: Vertical at 3 M							
No.	Freq. (MHz)	Reading (dBm)	S.G Power Value (dBm)	Correction Factor (dB)	ERP (dBm)	Limit (dBm)	Margin (dB)
1	836.50	-12.0	16.1	3.8	19.9	38.5	-18.6

MODE		TX channel 20600					
Antenna Polarity & Test Distance: Horizontal at 3 M							
No.	Freq. (MHz)	Reading (dBm)	S.G Power Value (dBm)	Correction Factor (dB)	ERP (dBm)	Limit (dBm)	Margin (dB)
1	844.00	-19.4	8.1	3.7	11.8	38.5	-26.7
Antenna Polarity & Test Distance: Vertical at 3 M							
No.	Freq. (MHz)	Reading (dBm)	S.G Power Value (dBm)	Correction Factor (dB)	ERP (dBm)	Limit (dBm)	Margin (dB)
1	844.00	-11.7	16.7	3.7	<b>20.4</b>	38.5	-18.1

Note: ERP (dBm) = S.G Power Value (dBm) + Correction Factor (dB).

LTE Band 26, Channel Bandwidth 1.4MHz

MODE		TX channel 26797					
Antenna Polarity & Test Distance: Horizontal at 3 M							
No.	Freq. (MHz)	Reading (dBm)	S.G Power Value (dBm)	Correction Factor (dB)	ERP (dBm)	Limit (dBm)	Margin (dB)
1	824.70	-18.5	9.1	3.9	13.0	38.5	-25.5
Antenna Polarity & Test Distance: Vertical at 3 M							
No.	Freq. (MHz)	Reading (dBm)	S.G Power Value (dBm)	Correction Factor (dB)	ERP (dBm)	Limit (dBm)	Margin (dB)
1	824.70	-11.9	16.5	3.9	<b>20.4</b>	38.5	-18.1

MODE		TX channel 26915					
Antenna Polarity & Test Distance: Horizontal at 3 M							
No.	Freq. (MHz)	Reading (dBm)	S.G Power Value (dBm)	Correction Factor (dB)	ERP (dBm)	Limit (dBm)	Margin (dB)
1	836.50	-18.1	9.3	3.8	13.1	38.5	-25.4
Antenna Polarity & Test Distance: Vertical at 3 M							
No.	Freq. (MHz)	Reading (dBm)	S.G Power Value (dBm)	Correction Factor (dB)	ERP (dBm)	Limit (dBm)	Margin (dB)
1	836.50	-11.5	16.6	3.8	<b>20.4</b>	38.5	-18.1

MODE		TX channel 27033					
Antenna Polarity & Test Distance: Horizontal at 3 M							
No.	Freq. (MHz)	Reading (dBm)	S.G Power Value (dBm)	Correction Factor (dB)	ERP (dBm)	Limit (dBm)	Margin (dB)
1	848.30	-18.1	9.6	3.4	13.0	38.5	-25.5
Antenna Polarity & Test Distance: Vertical at 3 M							
No.	Freq. (MHz)	Reading (dBm)	S.G Power Value (dBm)	Correction Factor (dB)	ERP (dBm)	Limit (dBm)	Margin (dB)
1	848.30	-11.4	16.7	3.4	20.1	38.5	-18.4

Note: ERP (dBm) = S.G Power Value (dBm) + Correction Factor (dB).

LTE Band 26, Channel Bandwidth 3MHz

MODE		TX channel 26805					
Antenna Polarity & Test Distance: Horizontal at 3 M							
No.	Freq. (MHz)	Reading (dBm)	S.G Power Value (dBm)	Correction Factor (dB)	ERP (dBm)	Limit (dBm)	Margin (dB)
1	825.50	-18.6	9.0	3.9	12.9	38.5	-25.6
Antenna Polarity & Test Distance: Vertical at 3 M							
No.	Freq. (MHz)	Reading (dBm)	S.G Power Value (dBm)	Correction Factor (dB)	ERP (dBm)	Limit (dBm)	Margin (dB)
1	825.50	-11.9	16.5	3.9	20.4	38.5	-18.1

MODE		TX channel 26915					
Antenna Polarity & Test Distance: Horizontal at 3 M							
No.	Freq. (MHz)	Reading (dBm)	S.G Power Value (dBm)	Correction Factor (dB)	ERP (dBm)	Limit (dBm)	Margin (dB)
1	836.50	-18.2	9.2	3.8	13.0	38.5	-25.5
Antenna Polarity & Test Distance: Vertical at 3 M							
No.	Freq. (MHz)	Reading (dBm)	S.G Power Value (dBm)	Correction Factor (dB)	ERP (dBm)	Limit (dBm)	Margin (dB)
1	836.50	-11.2	16.8	3.8	<b>20.6</b>	38.5	-17.9

MODE		TX channel 27025					
Antenna Polarity & Test Distance: Horizontal at 3 M							
No.	Freq. (MHz)	Reading (dBm)	S.G Power Value (dBm)	Correction Factor (dB)	ERP (dBm)	Limit (dBm)	Margin (dB)
1	847.50	-17.7	9.9	3.4	13.3	38.5	-25.2
Antenna Polarity & Test Distance: Vertical at 3 M							
No.	Freq. (MHz)	Reading (dBm)	S.G Power Value (dBm)	Correction Factor (dB)	ERP (dBm)	Limit (dBm)	Margin (dB)
1	847.50	-11.0	17.2	3.4	<b>20.6</b>	38.5	-17.9

Note: ERP (dBm) = S.G Power Value (dBm) + Correction Factor (dB).



LTE Band 26, Channel Bandwidth 5MHz

MODE		TX channel 26815					
Antenna Polarity & Test Distance: Horizontal at 3 M							
No.	Freq. (MHz)	Reading (dBm)	S.G Power Value (dBm)	Correction Factor (dB)	ERP (dBm)	Limit (dBm)	Margin (dB)
1	826.50	-18.6	9.0	3.9	12.9	38.5	-25.6
Antenna Polarity & Test Distance: Vertical at 3 M							
No.	Freq. (MHz)	Reading (dBm)	S.G Power Value (dBm)	Correction Factor (dB)	ERP (dBm)	Limit (dBm)	Margin (dB)
1	826.50	-12.1	16.2	3.9	<b>20.1</b>	38.5	-18.4

MODE		TX channel 26915					
Antenna Polarity & Test Distance: Horizontal at 3 M							
No.	Freq. (MHz)	Reading (dBm)	S.G Power Value (dBm)	Correction Factor (dB)	ERP (dBm)	Limit (dBm)	Margin (dB)
1	836.50	-18.4	9.0	3.8	12.8	38.5	-25.7
Antenna Polarity & Test Distance: Vertical at 3 M							
No.	Freq. (MHz)	Reading (dBm)	S.G Power Value (dBm)	Correction Factor (dB)	ERP (dBm)	Limit (dBm)	Margin (dB)
1	836.50	-11.8	16.3	3.8	<b>20.1</b>	38.5	-18.4

MODE		TX channel 27015					
Antenna Polarity & Test Distance: Horizontal at 3 M							
No.	Freq. (MHz)	Reading (dBm)	S.G Power Value (dBm)	Correction Factor (dB)	ERP (dBm)	Limit (dBm)	Margin (dB)
1	846.50	-18.2	9.4	3.4	12.8	38.5	-25.7
Antenna Polarity & Test Distance: Vertical at 3 M							
No.	Freq. (MHz)	Reading (dBm)	S.G Power Value (dBm)	Correction Factor (dB)	ERP (dBm)	Limit (dBm)	Margin (dB)
1	846.50	-11.5	16.7	3.4	<b>20.1</b>	38.5	-18.4

Note: ERP (dBm) = S.G Power Value (dBm) + Correction Factor (dB).

LTE Band 26, Channel Bandwidth 10MHz

MODE		TX channel 26840					
Antenna Polarity & Test Distance: Horizontal at 3 M							
No.	Freq. (MHz)	Reading (dBm)	S.G Power Value (dBm)	Correction Factor (dB)	ERP (dBm)	Limit (dBm)	Margin (dB)
1	829.00	-18.3	9.4	3.9	13.3	38.5	-25.2
Antenna Polarity & Test Distance: Vertical at 3 M							
No.	Freq. (MHz)	Reading (dBm)	S.G Power Value (dBm)	Correction Factor (dB)	ERP (dBm)	Limit (dBm)	Margin (dB)
1	829.00	-11.5	16.7	3.9	<b>20.6</b>	38.5	-17.9

MODE		TX channel 26915					
Antenna Polarity & Test Distance: Horizontal at 3 M							
No.	Freq. (MHz)	Reading (dBm)	S.G Power Value (dBm)	Correction Factor (dB)	ERP (dBm)	Limit (dBm)	Margin (dB)
1	836.50	-18.4	9.1	3.8	12.9	38.5	-25.6
Antenna Polarity & Test Distance: Vertical at 3 M							
No.	Freq. (MHz)	Reading (dBm)	S.G Power Value (dBm)	Correction Factor (dB)	ERP (dBm)	Limit (dBm)	Margin (dB)
1	836.50	-11.8	16.3	3.8	20.1	38.5	-18.4

MODE		TX channel 26990					
Antenna Polarity & Test Distance: Horizontal at 3 M							
No.	Freq. (MHz)	Reading (dBm)	S.G Power Value (dBm)	Correction Factor (dB)	ERP (dBm)	Limit (dBm)	Margin (dB)
1	844.00	-18.1	9.5	3.7	13.2	38.5	-25.3
Antenna Polarity & Test Distance: Vertical at 3 M							
No.	Freq. (MHz)	Reading (dBm)	S.G Power Value (dBm)	Correction Factor (dB)	ERP (dBm)	Limit (dBm)	Margin (dB)
1	844.00	-11.5	16.9	3.7	<b>20.6</b>	38.5	-17.9

Note: ERP (dBm) = S.G Power Value (dBm) + Correction Factor (dB).

LTE Band 26, Channel Bandwidth 15MHz

MODE		TX channel 26865					
Antenna Polarity & Test Distance: Horizontal at 3 M							
No.	Freq. (MHz)	Reading (dBm)	S.G Power Value (dBm)	Correction Factor (dB)	ERP (dBm)	Limit (dBm)	Margin (dB)
1	831.50	-18.9	9.1	3.9	13.0	38.5	-25.5
Antenna Polarity & Test Distance: Vertical at 3 M							
No.	Freq. (MHz)	Reading (dBm)	S.G Power Value (dBm)	Correction Factor (dB)	ERP (dBm)	Limit (dBm)	Margin (dB)
1	831.50	-11.2	16.7	3.9	<b>20.6</b>	38.5	-17.9

MODE		TX channel 26915					
Antenna Polarity & Test Distance: Horizontal at 3 M							
No.	Freq. (MHz)	Reading (dBm)	S.G Power Value (dBm)	Correction Factor (dB)	ERP (dBm)	Limit (dBm)	Margin (dB)
1	836.50	-18.1	9.3	3.8	13.1	38.5	-25.4
Antenna Polarity & Test Distance: Vertical at 3 M							
No.	Freq. (MHz)	Reading (dBm)	S.G Power Value (dBm)	Correction Factor (dB)	ERP (dBm)	Limit (dBm)	Margin (dB)
1	836.50	-11.8	16.3	3.8	20.1	38.5	-18.4

MODE		TX channel 26965					
Antenna Polarity & Test Distance: Horizontal at 3 M							
No.	Freq. (MHz)	Reading (dBm)	S.G Power Value (dBm)	Correction Factor (dB)	ERP (dBm)	Limit (dBm)	Margin (dB)
1	841.50	-18.2	9.3	3.6	12.9	38.5	-25.6
Antenna Polarity & Test Distance: Vertical at 3 M							
No.	Freq. (MHz)	Reading (dBm)	S.G Power Value (dBm)	Correction Factor (dB)	ERP (dBm)	Limit (dBm)	Margin (dB)
1	841.50	-11.4	17.0	3.6	<b>20.6</b>	38.5	-17.9

Note: ERP (dBm) = S.G Power Value (dBm) + Correction Factor (dB).

## 4.2 Modulation Characteristics Measurement

### 4.2.1 Limits of Modulation Characteristics

N/A

### 4.2.2 Test Procedure

Connect the EUT to Communication Simulator via the antenna connector, The frequency band is set as EUT supported Modulation and Channels, the EUT output is matched with 50 ohm load, the waveform quality and constellation of the EUT was tested.

### 4.2.3 Test Setup



### 4.2.4 Test Results

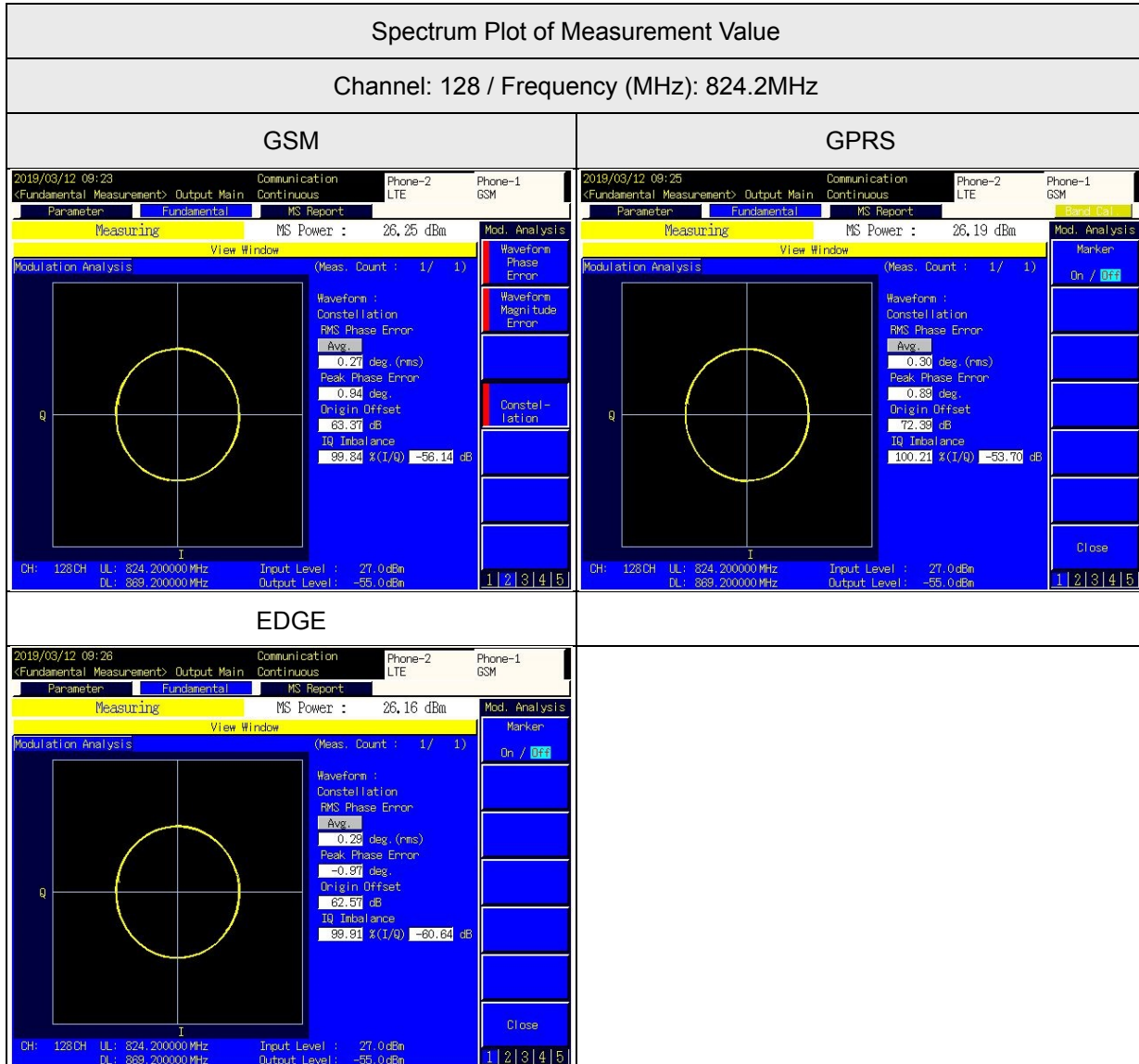

CDMA

Spectrum Plot of Measurement Value

Channel: 1013 / Frequency (MHz): 824.7MHz

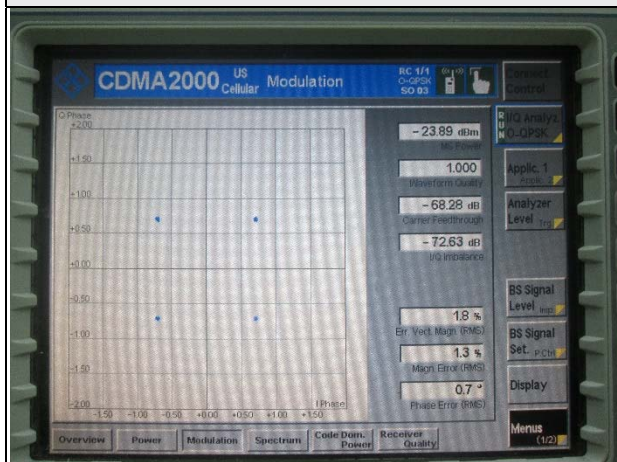

WCDMA Band 5

Spectrum Plot of Measurement Value

Channel: 4132 / Frequency (MHz): 836.4MHz

WCDMA

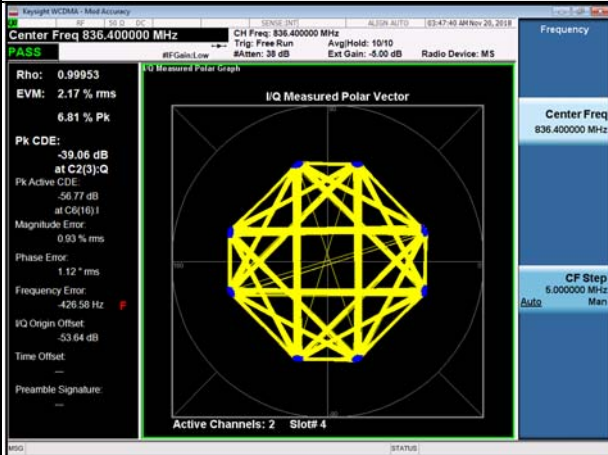

HSDPA

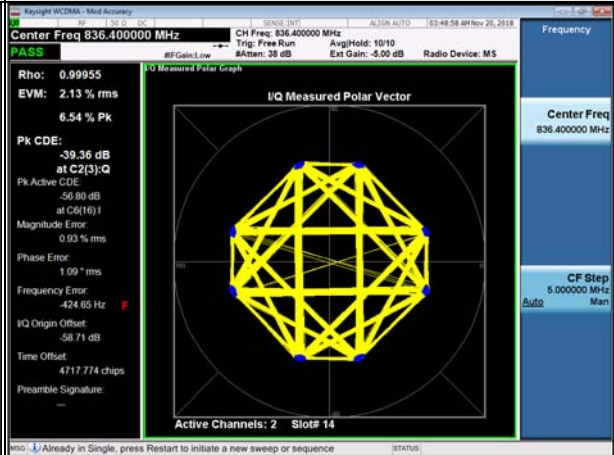

HSUPA

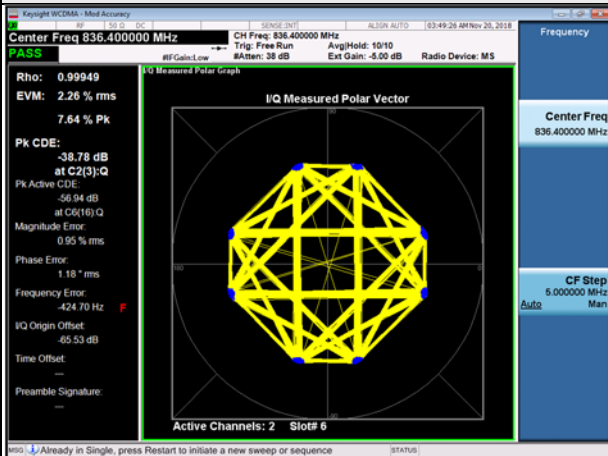

### LTE Band 5

#### Spectrum Plot of Measurement Value

Channel: 20525 / Frequency (MHz): 836.5MHz

QPSK

16QAM

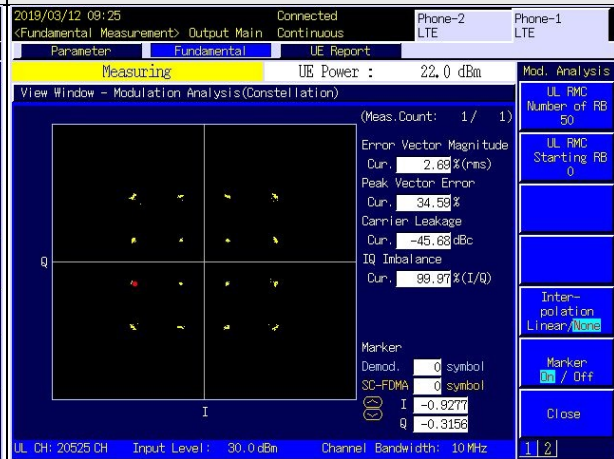
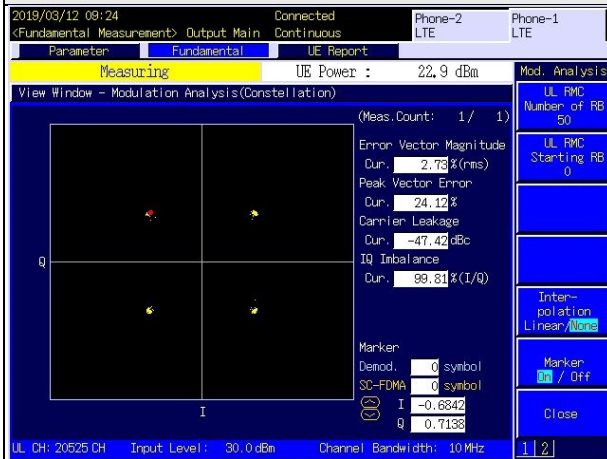

### LTE Band 26

#### Spectrum Plot of Measurement Value

Channel: 26865 / Frequency (MHz): 831.5MHz

QPSK

16QAM

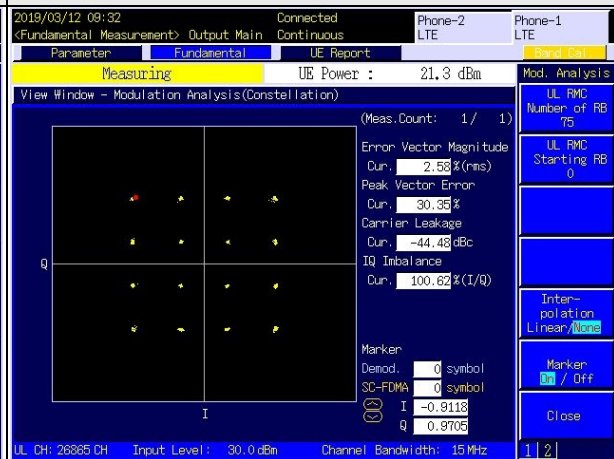
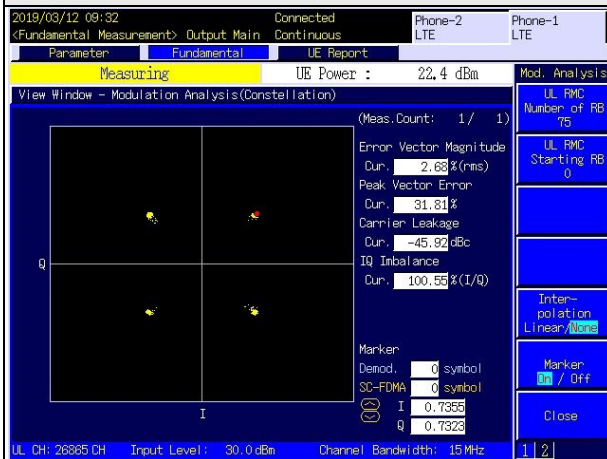



#### 4.2.5 Limits of Frequency Stability Measurement

1.5 ppm is for base and fixed station. 2.5 ppm is for mobile station.

#### 4.2.6 Test Procedure

- a. Device is placed at the oven room. The oven room could control the temperatures and humidity. Power warm up is at least 15 min and power applied should perform before recording frequency error.
- b. EUT is connected the external power supply to control the DC input power. The test voltage range is from minimum to maximum working voltage. Each step shall be record the frequency error rate.
- c. The temperature range step is 10 degrees in this test items. All temperature levels shall be hold the  $\pm 0.5$  °C during the measurement testing. The each temperature step shall be at least 0.5 hours, consider the EUT could be test under the stability condition.

Note: The frequency error was recorded frequency error from the communication simulator.

#### 4.2.7 Test Setup

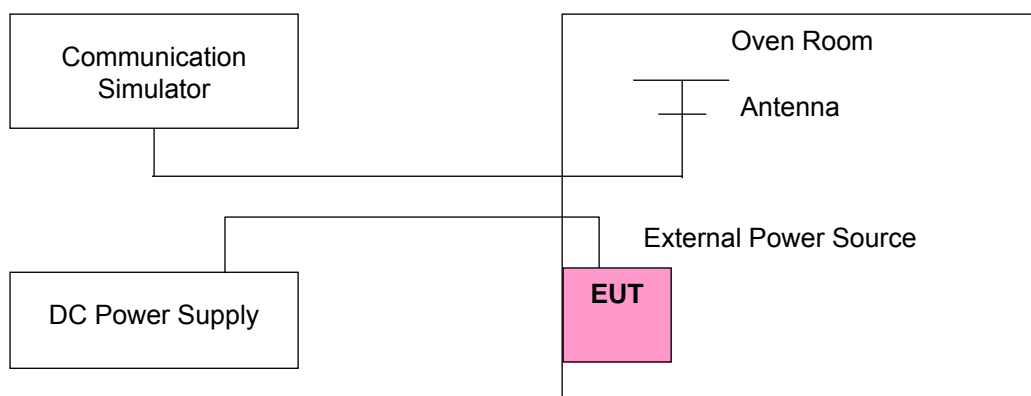

#### 4.2.8 Test Results

##### Frequency Error vs. Voltage

Voltage (Volts)	GSM 850			
	Low Channel		High Channel	
	Frequency (MHz)	Frequency Error (ppm)	Frequency (MHz)	Frequency Error (ppm)
3.75	824.200001	0.001	848.800002	0.002
3.20	824.200003	0.004	848.800002	0.003
4.30	824.200002	0.002	848.800003	0.004

Note: The applicant defined the normal working voltage is from 3.20Vdc to 4.30Vdc.

##### Frequency Error vs. Temperature

Temp. (°C)	GSM 850			
	Low Channel		High Channel	
	Frequency (MHz)	Frequency Error (ppm)	Frequency (MHz)	Frequency Error (ppm)
-30	824.200003	0.004	848.800004	0.004
-20	824.200003	0.003	848.800003	0.003
-10	824.200003	0.004	848.800003	0.004
0	824.200003	0.004	848.800001	0.001
10	824.200003	0.003	848.800004	0.004
20	824.199997	-0.004	848.799997	-0.004
30	824.199997	-0.004	848.799998	-0.002
40	824.199997	-0.003	848.799997	-0.003
50	824.199996	-0.005	848.799997	-0.003
60	824.199996	-0.005	848.799997	-0.003

Frequency Error vs. Voltage

Voltage (Volts)	EDGE 850			
	Low Channel		High Channel	
	Frequency (MHz)	Frequency Error (ppm)	Frequency (MHz)	Frequency Error (ppm)
3.75	824.200003	0.003	848.800003	0.003
3.20	824.200001	0.001	848.800003	0.004
4.30	824.200003	0.003	848.800003	0.004

Note: The applicant defined the normal working voltage is from 3.20Vdc to 4.30Vdc.

Frequency Error vs. Temperature

Temp. (°C)	EDGE 850			
	Low Channel		High Channel	
	Frequency (MHz)	Frequency Error (ppm)	Frequency (MHz)	Frequency Error (ppm)
-30	824.200003	0.004	848.800002	0.002
-20	824.200002	0.002	848.800002	0.002
-10	824.200002	0.003	848.800002	0.002
0	824.200003	0.004	848.800003	0.003
10	824.200003	0.003	848.800004	0.004
20	824.199996	-0.005	848.799998	-0.002
30	824.199999	-0.002	848.799999	-0.002
40	824.199997	-0.004	848.799997	-0.003
50	824.199998	-0.002	848.799998	-0.002
60	824.199997	-0.003	848.799998	-0.002

Frequency Error vs. Voltage

Voltage (Volts)	CDMA			
	Low Channel		High Channel	
	Frequency (MHz)	Frequency Error (ppm)	Frequency (MHz)	Frequency Error (ppm)
3.75	824.700002	0.002	848.310004	0.004
3.20	824.700003	0.004	848.310003	0.003
4.30	824.700001	0.002	848.310002	0.003

Note: The applicant defined the normal working voltage is from 3.20Vdc to 4.30Vdc.

Frequency Error vs. Temperature

Temp. (°C)	CDMA			
	Low Channel		High Channel	
	Frequency (MHz)	Frequency Error (ppm)	Frequency (MHz)	Frequency Error (ppm)
-30	824.700003	0.004	848.310004	0.005
-20	824.700002	0.003	848.310002	0.002
-10	824.700003	0.003	848.310002	0.002
0	824.700003	0.003	848.310002	0.002
10	824.700002	0.003	848.310001	0.001
20	824.699997	-0.004	848.309999	-0.002
30	824.699997	-0.003	848.309998	-0.003
40	824.699999	-0.002	848.309997	-0.004
50	824.699997	-0.004	848.309998	-0.003
60	824.699999	-0.002	848.309998	-0.003

Frequency Error vs. Voltage

Voltage (Volts)	WCDMA Band 5			
	Low Channel		High Channel	
	Frequency (MHz)	Frequency Error (ppm)	Frequency (MHz)	Frequency Error (ppm)
3.75	826.400002	0.002	846.600002	0.002
3.20	826.400003	0.004	846.600004	0.004
4.30	826.400001	0.001	846.600003	0.003

Note: The applicant defined the normal working voltage is from 3.20Vdc to 4.30Vdc.

Frequency Error vs. Temperature

Temp. (°C)	WCDMA Band 5			
	Low Channel		High Channel	
	Frequency (MHz)	Frequency Error (ppm)	Frequency (MHz)	Frequency Error (ppm)
-30	826.400004	0.005	846.600004	0.004
-20	826.400003	0.004	846.600003	0.004
-10	826.400004	0.004	846.600004	0.004
0	826.400003	0.003	846.600002	0.002
10	826.400003	0.004	846.600001	0.002
20	826.399998	-0.002	846.599996	-0.005
30	826.399998	-0.003	846.599998	-0.002
40	826.399996	-0.005	846.599998	-0.002
50	826.399996	-0.005	846.599996	-0.004
60	826.399997	-0.004	846.599998	-0.002

Frequency Error vs. Voltage

Voltage (Volts)	LTE Band 5			
	Channel Bandwidth: 1.4 MHz			
	Low Channel		High Channel	
	Frequency (MHz)	Frequency Error (ppm)	Frequency (MHz)	Frequency Error (ppm)
3.20	824.700002	0.003	848.300002	0.002
3.75	824.700004	0.005	848.300003	0.004
4.30	824.700004	0.004	848.300002	0.002

Note: The applicant defined the normal working voltage is from 3.20Vdc to 4.30Vdc.

Frequency Error vs. Temperature

Temp. (°C)	LTE Band 5			
	Channel Bandwidth: 1.4 MHz			
	Low Channel		High Channel	
	Frequency (MHz)	Frequency Error (ppm)	Frequency (MHz)	Frequency Error (ppm)
-30	824.700003	0.004	848.300002	0.003
-20	824.700002	0.002	848.300004	0.004
-10	824.700002	0.002	848.300001	0.001
0	824.700003	0.004	848.300003	0.003
10	824.700002	0.002	848.300002	0.002
20	824.699997	-0.003	848.299997	-0.004
30	824.699998	-0.002	848.299997	-0.004
40	824.699998	-0.003	848.299999	-0.002
50	824.699998	-0.003	848.299999	-0.002
60	824.699999	-0.001	848.299997	-0.003

Frequency Error vs. Voltage

Voltage (Volts)	LTE Band 5			
	Channel Bandwidth: 3 MHz			
	Low Channel		High Channel	
	Frequency (MHz)	Frequency Error (ppm)	Frequency (MHz)	Frequency Error (ppm)
3.75	825.500002	0.002	847.500003	0.003
3.20	825.500003	0.004	847.500004	0.005
4.30	825.500004	0.004	847.500003	0.004

Note: The applicant defined the normal working voltage is from 3.20Vdc to 4.30Vdc.

Frequency Error vs. Temperature

Temp. (°C)	LTE Band 5			
	Channel Bandwidth: 3 MHz			
	Low Channel		High Channel	
	Frequency (MHz)	Frequency Error (ppm)	Frequency (MHz)	Frequency Error (ppm)
-30	825.500001	0.001	847.500002	0.002
-20	825.500004	0.005	847.500003	0.003
-10	825.500002	0.002	847.500001	0.001
0	825.500003	0.004	847.500002	0.002
10	825.500003	0.004	847.500003	0.003
20	825.499998	-0.002	847.499999	-0.001
30	825.499996	-0.005	847.499998	-0.002
40	825.499998	-0.003	847.499998	-0.002
50	825.499998	-0.002	847.499998	-0.002
60	825.499999	-0.001	847.499999	-0.002

Frequency Error vs. Voltage

Voltage (Volts)	LTE Band 5			
	Channel Bandwidth: 5 MHz			
	Low Channel		High Channel	
	Frequency (MHz)	Frequency Error (ppm)	Frequency (MHz)	Frequency Error (ppm)
3.75	826.500002	0.003	846.500002	0.002
3.20	826.500001	0.001	846.500004	0.005
4.30	826.500004	0.004	846.500002	0.003

Note: The applicant defined the normal working voltage is from 3.20Vdc to 4.30Vdc.

Frequency Error vs. Temperature

Temp. (°C)	LTE Band 5			
	Channel Bandwidth: 5 MHz			
	Low Channel		High Channel	
	Frequency (MHz)	Frequency Error (ppm)	Frequency (MHz)	Frequency Error (ppm)
-30	826.500002	0.002	846.500001	0.002
-20	826.500002	0.003	846.500004	0.005
-10	826.500003	0.003	846.500002	0.002
0	826.500004	0.004	846.500003	0.003
10	826.500003	0.004	846.500001	0.001
20	826.499998	-0.002	846.499998	-0.003
30	826.499998	-0.002	846.499997	-0.004
40	826.499996	-0.005	846.499999	-0.001
50	826.499997	-0.004	846.499998	-0.002
60	826.499997	-0.003	846.499999	-0.002



Frequency Error vs. Voltage

Voltage (Volts)	LTE Band 5			
	Channel Bandwidth: 10 MHz			
	Low Channel		High Channel	
	Frequency (MHz)	Frequency Error (ppm)	Frequency (MHz)	Frequency Error (ppm)
3.75	829.000002	0.002	844.000003	0.003
3.20	829.000002	0.003	844.000004	0.005
4.30	829.000003	0.004	844.000002	0.003

Note: The applicant defined the normal working voltage is from 3.20Vdc to 4.30Vdc.

Frequency Error vs. Temperature

Temp. (°C)	LTE Band 5			
	Channel Bandwidth: 10 MHz			
	Low Channel		High Channel	
	Frequency (MHz)	Frequency Error (ppm)	Frequency (MHz)	Frequency Error (ppm)
-30	829.000004	0.005	844.000001	0.001
-20	829.000001	0.002	844.000003	0.004
-10	829.000002	0.003	844.000001	0.002
0	829.000003	0.004	844.000001	0.002
10	829.000003	0.003	844.000002	0.002
20	828.999997	-0.004	843.999998	-0.003
30	828.999996	-0.004	843.999998	-0.002
40	828.999997	-0.004	843.999999	-0.001
50	828.999997	-0.004	843.999998	-0.002
60	828.999998	-0.002	843.999997	-0.004

Frequency Error vs. Voltage

Voltage (Volts)	LTE Band 26			
	Channel Bandwidth: 1.4 MHz			
	Low Channel		High Channel	
	Frequency (MHz)	Frequency Error (ppm)	Frequency (MHz)	Frequency Error (ppm)
3.75	824.700003	0.003	848.300000	0.003
3.20	824.700002	0.002	848.300000	0.003
4.30	824.700002	0.003	848.300000	0.005

Note: The applicant defined the normal working voltage is from 3.20Vdc to 4.30Vdc.

Frequency Error vs. Temperature

Temp. (°C)	LTE Band 26			
	Channel Bandwidth: 1.4 MHz			
	Low Channel		High Channel	
	Frequency (MHz)	Frequency Error (ppm)	Frequency (MHz)	Frequency Error (ppm)
-30	824.700001	0.001	848.300000	0.004
-20	824.700003	0.004	848.300000	0.004
-10	824.700002	0.002	848.300000	0.003
0	824.700001	0.002	848.300000	0.001
10	824.700003	0.004	848.300000	0.002
20	824.699998	-0.002	848.300000	-0.004
30	824.699998	-0.003	848.300000	-0.003
40	824.699999	-0.002	848.300000	-0.004
50	824.699998	-0.003	848.300000	-0.002
60	824.699996	-0.004	848.300000	-0.003

Frequency Error vs. Voltage

Voltage (Volts)	LTE Band 26			
	Channel Bandwidth: 3 MHz			
	Low Channel		High Channel	
	Frequency (MHz)	Frequency Error (ppm)	Frequency (MHz)	Frequency Error (ppm)
3.75	825.500002	0.003	847.500000	0.001
3.20	825.500002	0.003	847.500000	0.002
4.30	825.500002	0.002	847.500000	0.003

Note: The applicant defined the normal working voltage is from 3.20Vdc to 4.30Vdc.

Frequency Error vs. Temperature

Temp. (°C)	LTE Band 26			
	Channel Bandwidth: 3 MHz			
	Low Channel		High Channel	
	Frequency (MHz)	Frequency Error (ppm)	Frequency (MHz)	Frequency Error (ppm)
-30	825.500003	0.003	847.500000	0.004
-20	825.500002	0.002	847.500000	0.004
-10	825.500001	0.001	847.500000	0.003
0	825.500002	0.002	847.500000	0.002
10	825.500002	0.002	847.500000	0.004
20	825.499998	-0.003	847.500000	-0.004
30	825.499996	-0.004	847.500000	-0.005
40	825.499997	-0.003	847.500000	-0.001
50	825.499996	-0.005	847.500000	-0.003
60	825.499998	-0.003	847.500000	-0.002

Frequency Error vs. Voltage

Voltage (Volts)	LTE Band 26			
	Channel Bandwidth: 5 MHz			
	Low Channel		High Channel	
	Frequency (MHz)	Frequency Error (ppm)	Frequency (MHz)	Frequency Error (ppm)
3.75	826.500003	0.003	846.500002	0.003
3.20	826.500003	0.004	846.500004	0.005
4.30	826.500002	0.003	846.500003	0.004

Note: The applicant defined the normal working voltage is from 3.20Vdc to 4.30Vdc.

Frequency Error vs. Temperature

Temp. (°C)	LTE Band 26			
	Channel Bandwidth: 5 MHz			
	Low Channel		High Channel	
	Frequency (MHz)	Frequency Error (ppm)	Frequency (MHz)	Frequency Error (ppm)
-30	826.500002	0.003	846.500002	0.002
-20	826.500001	0.002	846.500002	0.002
-10	826.500004	0.004	846.500002	0.002
0	826.500002	0.002	846.500003	0.003
10	826.500003	0.004	846.500004	0.005
20	826.499996	-0.004	846.499996	-0.005
30	826.499997	-0.004	846.499996	-0.004
40	826.499997	-0.004	846.499998	-0.002
50	826.499996	-0.005	846.499997	-0.003
60	826.499998	-0.002	846.499996	-0.004

Frequency Error vs. Voltage

Voltage (Volts)	LTE Band 26			
	Channel Bandwidth: 10 MHz			
	Low Channel		High Channel	
	Frequency (MHz)	Frequency Error (ppm)	Frequency (MHz)	Frequency Error (ppm)
3.75	829.000002	0.003	844.000002	0.002
3.20	829.000002	0.002	844.000001	0.002
4.30	829.000003	0.003	844.000002	0.002

Note: The applicant defined the normal working voltage is from 3.20Vdc to 4.30Vdc.

Frequency Error vs. Temperature

Temp. (°C)	LTE Band 26			
	Channel Bandwidth: 10 MHz			
	Low Channel		High Channel	
	Frequency (MHz)	Frequency Error (ppm)	Frequency (MHz)	Frequency Error (ppm)
-30	829.000001	0.002	844.000003	0.004
-20	829.000003	0.004	844.000004	0.004
-10	829.000002	0.002	844.000004	0.005
0	829.000004	0.005	844.000004	0.004
10	829.000002	0.002	844.000003	0.004
20	828.999998	-0.002	843.999996	-0.004
30	828.999997	-0.004	843.999997	-0.003
40	828.999997	-0.003	843.999997	-0.004
50	828.999999	-0.002	843.999999	-0.001
60	828.999999	-0.002	843.999999	-0.002

Frequency Error vs. Voltage

Voltage (Volts)	LTE Band 26			
	Channel Bandwidth: 15 MHz			
	Low Channel		High Channel	
	Frequency (MHz)	Frequency Error (ppm)	Frequency (MHz)	Frequency Error (ppm)
3.75	831.500004	0.004	841.500004	0.005
3.20	831.500003	0.003	841.500001	0.001
4.30	831.500001	0.002	841.500004	0.004

Note: The applicant defined the normal working voltage is from 3.20Vdc to 4.30Vdc.

Frequency Error vs. Temperature

Temp. (°C)	LTE Band 26			
	Channel Bandwidth: 15 MHz			
	Low Channel		High Channel	
	Frequency (MHz)	Frequency Error (ppm)	Frequency (MHz)	Frequency Error (ppm)
-30	831.500004	0.004	841.500002	0.002
-20	831.500004	0.004	841.500004	0.005
-10	831.500002	0.002	841.500003	0.004
0	831.500002	0.002	841.500003	0.004
10	831.500003	0.004	841.500003	0.004
20	831.499998	-0.003	841.499996	-0.004
30	831.499998	-0.002	841.499999	-0.001
40	831.499998	-0.002	841.499996	-0.004
50	831.499997	-0.003	841.499999	-0.002
60	831.499999	-0.002	841.499997	-0.003

### 4.3 Occupied Bandwidth Measurement

#### 4.3.1 Test Procedure

The EUT makes a call to the communication simulator. All measurements were done at low, middle and high operational frequency range. The communication simulator station system controlled a EUT to export maximum output power under transmission mode and specific channel frequency. Use OBW measurement function of Spectrum analyzer to measure 99 % occupied bandwidth.

#### 4.3.2 Test Setup

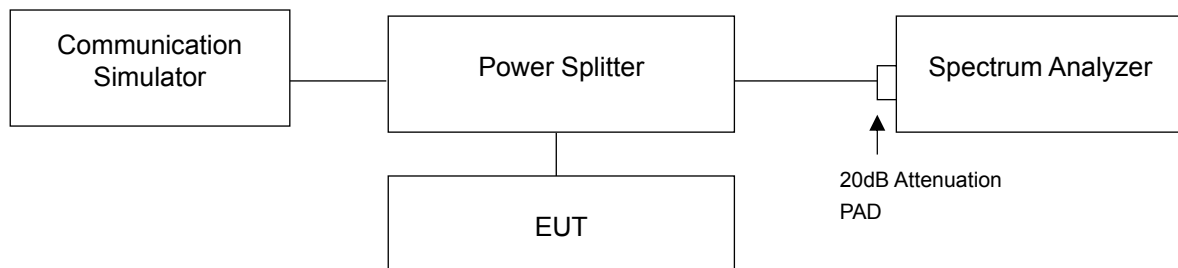

### 4.3.3 Test Result

#### Occupied Bandwidth

Channel	Frequency (MHz)	99% Occupied Bandwidth (kHz)		
		GSM	GPRS	EDGE
128	824.2	250	250	250
189	836.4	260	250	250
251	848.8	260	250	250

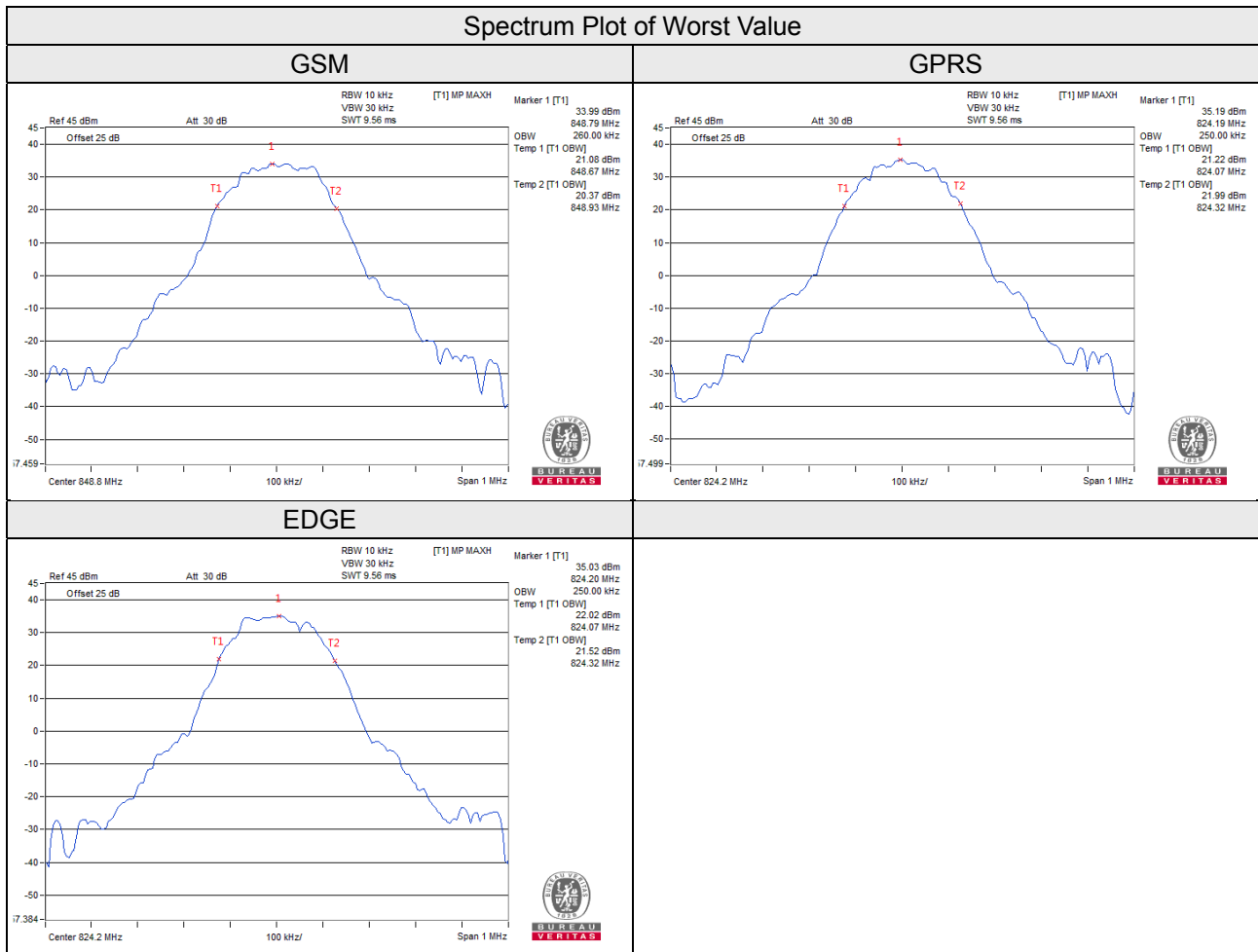



Channel	Frequency (MHz)	99% Occupied Bandwidth (MHz)
		CDMA
1013	824.70	1.27
384	836.52	1.27
777	848.31	1.28

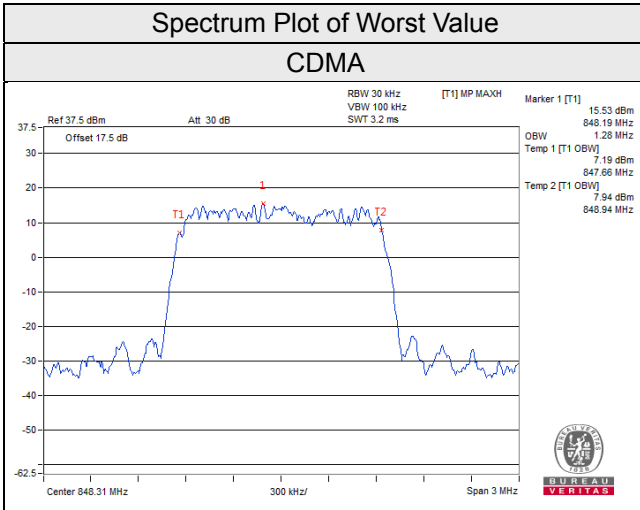

### WCDMA Band 5

Channel	Frequency (MHz)	99% Occupied Bandwidth (MHz)		
		WCDMA	HSDPA	HSUPA
4132	826.4	4.13	4.13	4.13
4182	836.4	4.13	4.11	4.13
4233	846.6	4.13	4.13	4.11

### Spectrum Plot of Worst Value

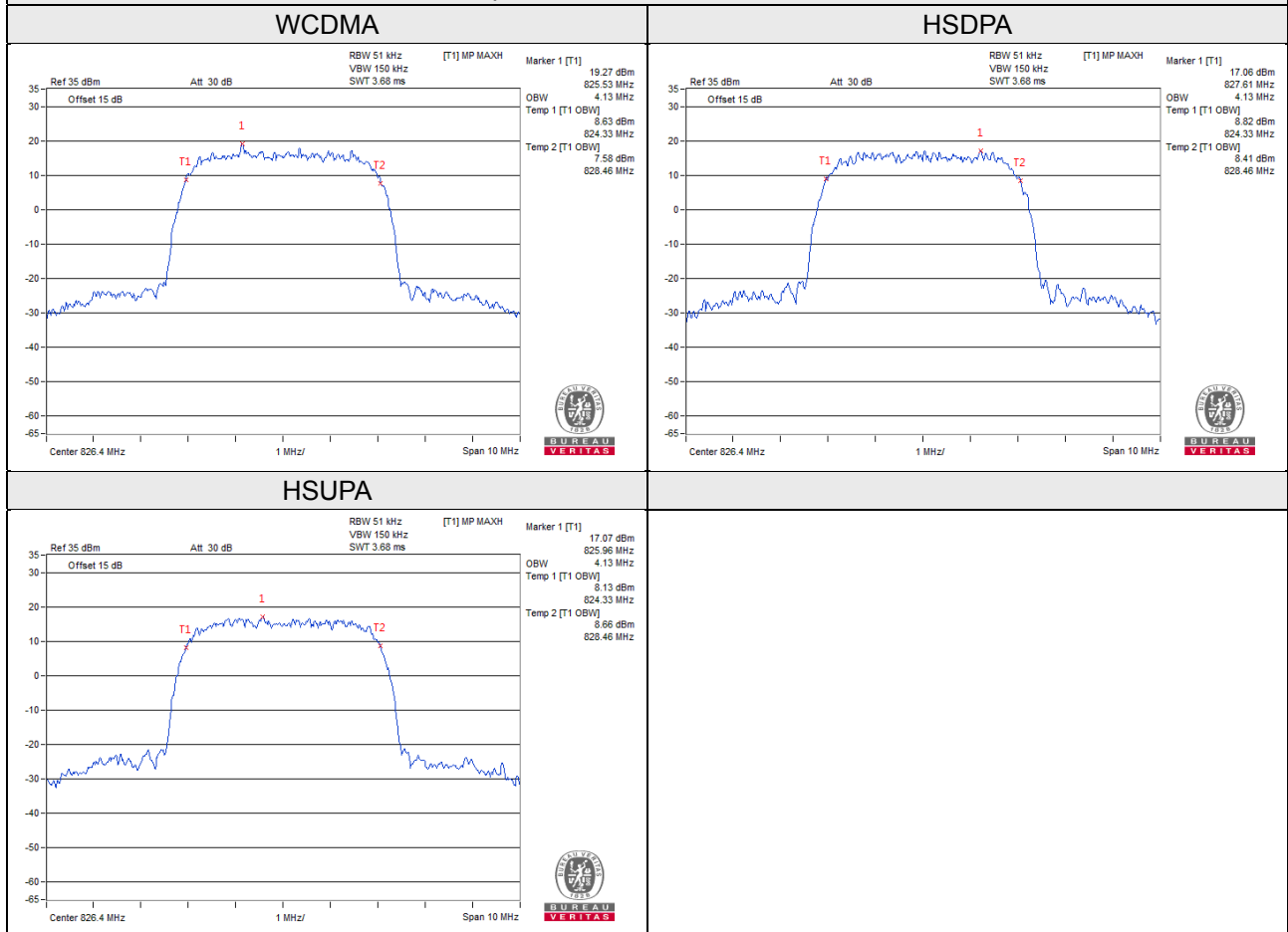

LTE Band 5, Channel Bandwidth 1.4MHz			
Channel	Frequency (MHz)	99% Occupied Bandwidth (MHz)	
		QPSK	16QAM
20407	824.7	1.09	1.09
20525	836.5	1.09	1.09
20643	848.3	1.09	1.09

LTE Band 5, Channel Bandwidth 3MHz			
Channel	Frequency (MHz)	99% Occupied Bandwidth (MHz)	
		QPSK	16QAM
20415	825.5	2.70	2.70
20525	836.5	2.70	2.69
20635	847.5	2.70	2.69

LTE Band 5, Channel Bandwidth 5MHz			
Channel	Frequency (MHz)	99% Occupied Bandwidth (MHz)	
		QPSK	16QAM
20425	826.5	4.48	4.49
20525	836.5	4.48	4.48
20625	846.5	4.48	4.48

LTE Band 5, Channel Bandwidth 10MHz			
Channel	Frequency (MHz)	99% Occupied Bandwidth (MHz)	
		QPSK	16QAM
20450	829.0	8.96	8.97
20525	836.5	8.94	8.94
20600	844.0	8.95	8.95

### Spectrum Plot of Worst Value

1.4MHz / 16QAM



3MHz / QPSK

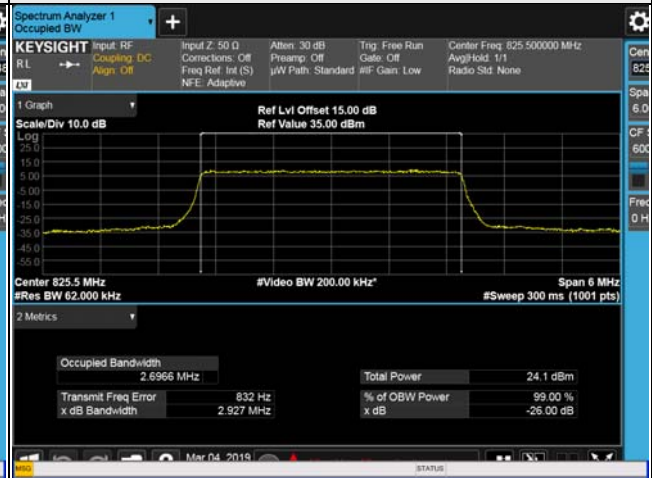

5MHz / 16QAM



10MHz / 16QAM



LTE Band 26, Channel Bandwidth 1.4MHz			
Channel	Frequency (MHz)	99% Occupied Bandwidth (MHz)	
		QPSK	16QAM
26797	824.7	1.09	1.09
26915	836.5	1.09	1.09
27033	848.3	1.09	1.09

LTE Band 26, Channel Bandwidth 3MHz			
Channel	Frequency (MHz)	99% Occupied Bandwidth (MHz)	
		QPSK	16QAM
26805	825.5	2.70	2.69
26915	836.5	2.70	2.69
27025	847.5	2.70	2.69

LTE Band 26, Channel Bandwidth 5MHz			
Channel	Frequency (MHz)	99% Occupied Bandwidth (MHz)	
		QPSK	16QAM
26815	826.5	4.49	4.48
26915	836.5	4.48	4.48
27015	846.5	4.48	4.48

LTE Band 26, Channel Bandwidth 10MHz			
Channel	Frequency (MHz)	99% Occupied Bandwidth (MHz)	
		QPSK	16QAM
26840	829.0	8.96	8.96
26915	836.5	8.94	8.94
26990	844.0	8.95	8.96

LTE Band 26, Channel Bandwidth 15MHz			
Channel	Frequency (MHz)	99% Occupied Bandwidth (MHz)	
		QPSK	16QAM
26865	831.5	13.44	13.43
26915	836.5	13.40	13.39
26965	841.5	13.42	13.40

### Spectrum Plot of Worst Value

1.4MHz / 16QAM

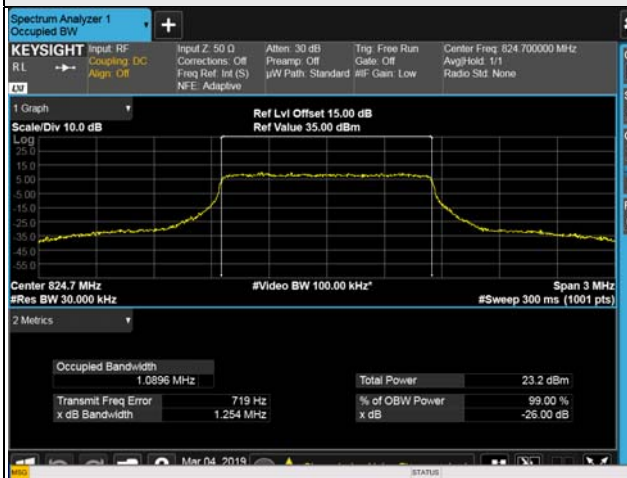

3MHz / QPSK

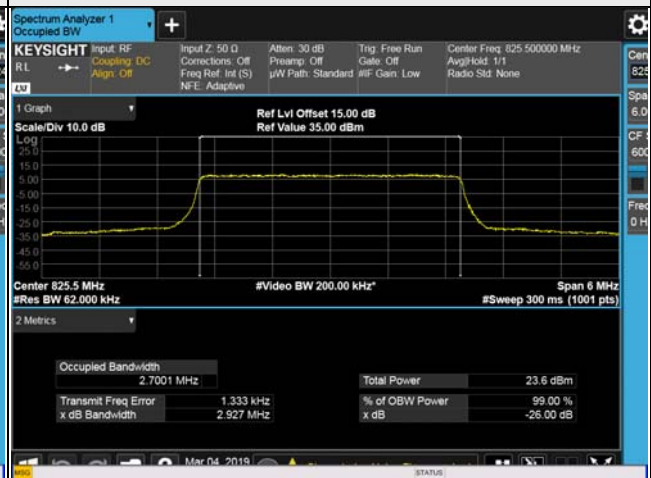

5MHz / QPSK

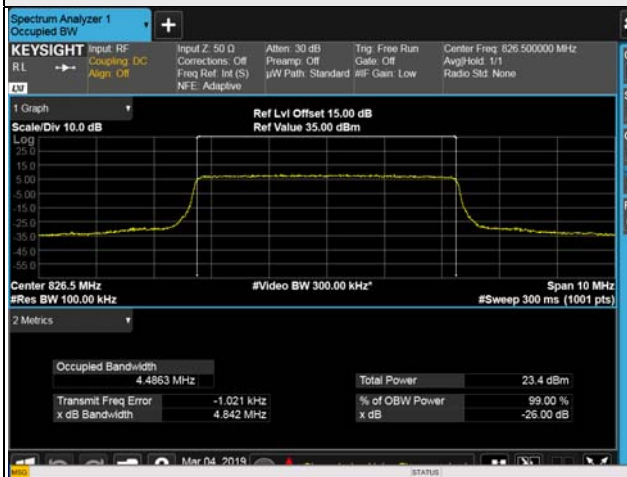

10MHz / 16QAM

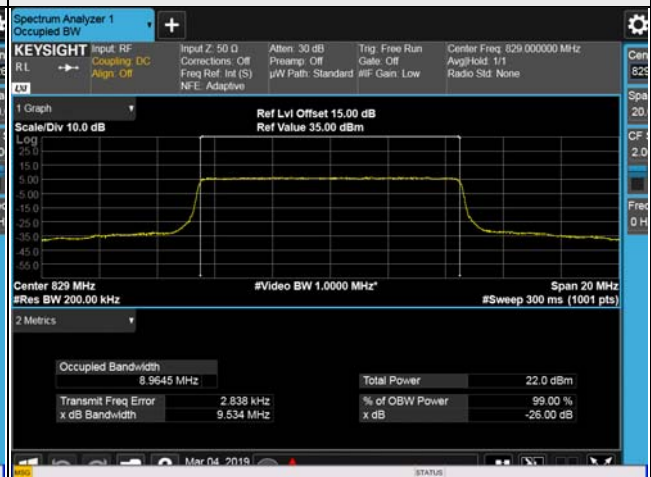

15MHz / QPSK

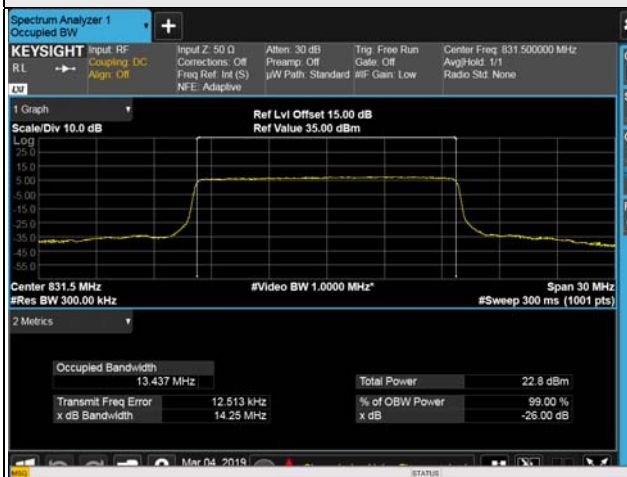

### 26dB Bandwidth

Channel	Frequency (MHz)	26dB Bandwidth (kHz)		
		GSM	GPRS	EDGE
128	824.2	311	312	302
189	836.4	319	311	309
251	848.8	309	309	314

### Spectrum Plot of Worst Value

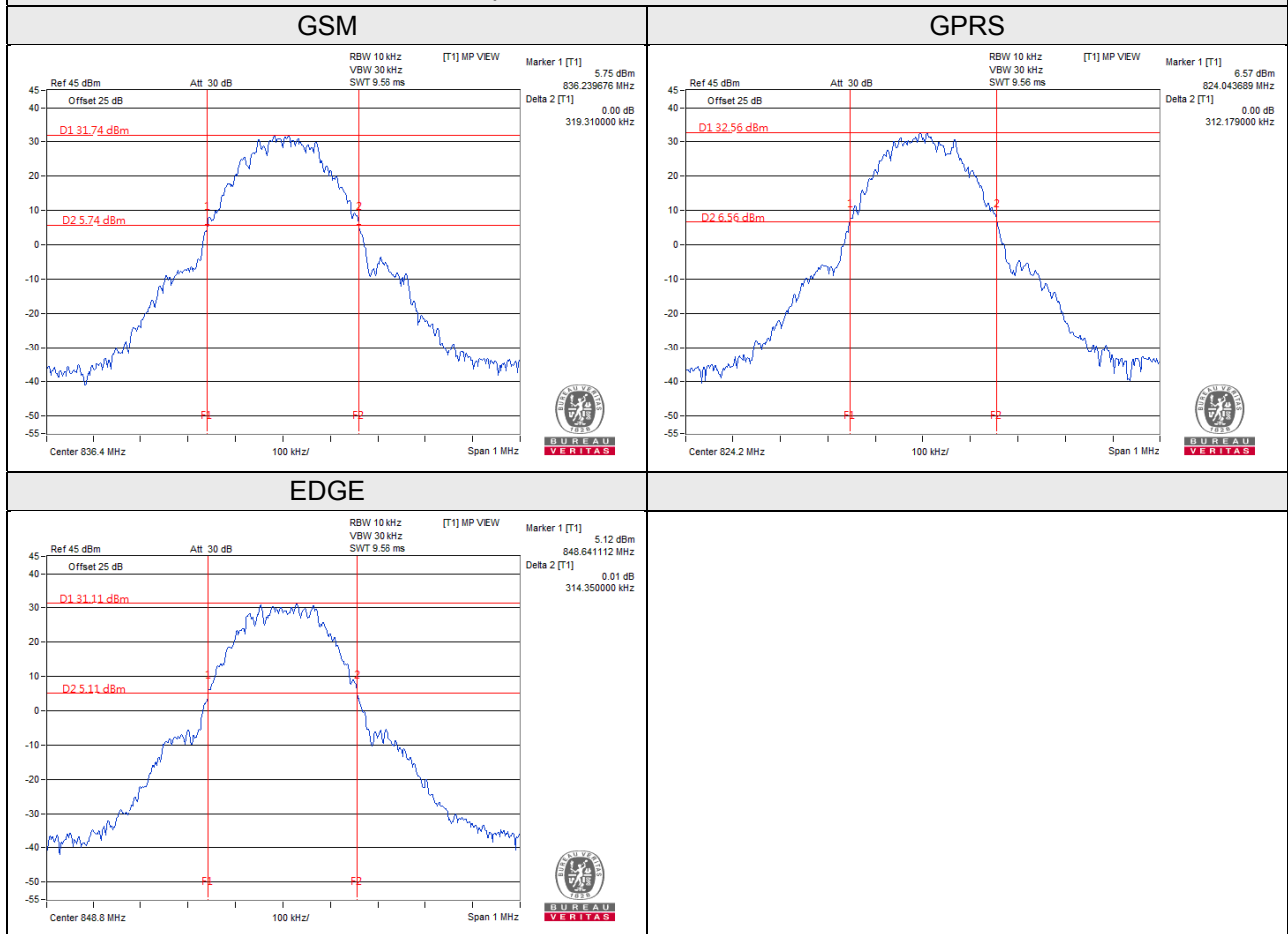

Channel	Frequency (MHz)	26dB Bandwidth (MHz)
		CDMA
1013	824.70	1.435
384	836.52	1.431
777	848.31	1.428

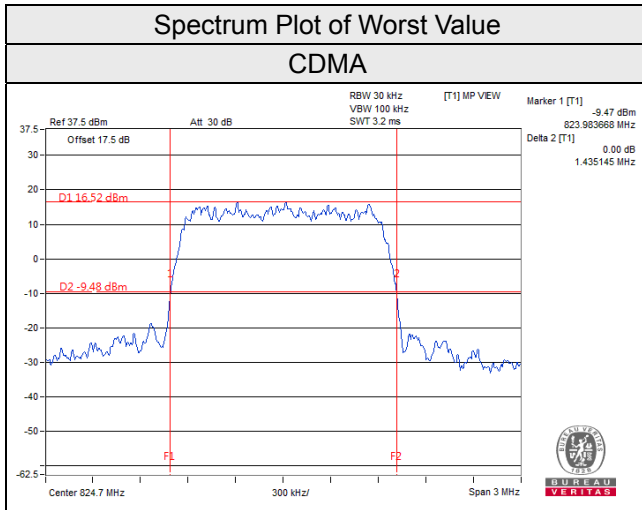



WCDMA Band 5

Channel	Frequency (MHz)	26dB Bandwidth (MHz)		
		WCDMA	HSDPA	HSUPA
4132	826.4	4.704	4.721	4.679
4182	836.6	4.706	4.715	4.674
4233	846.6	4.685	4.712	4.698

Spectrum Plot of Worst Value

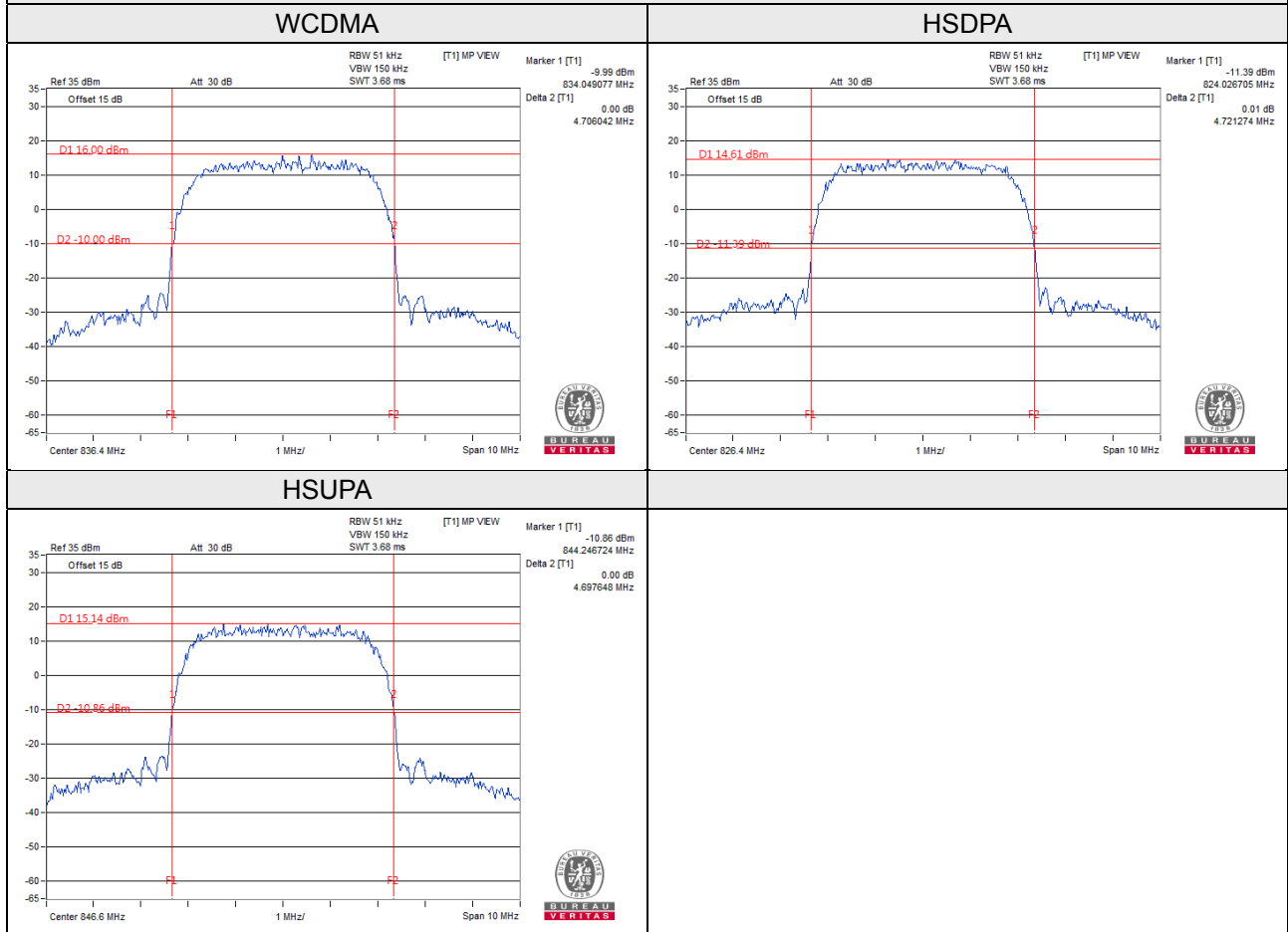

LTE Band 5, Channel Bandwidth 1.4MHz			
Channel	Frequency (MHz)	26dB Bandwidth (MHz)	
		QPSK	16QAM
20407	824.7	1.26	1.26
20525	836.5	1.25	1.26
20643	848.3	1.27	1.25

LTE Band 5, Channel Bandwidth 3MHz			
Channel	Frequency (MHz)	26dB Bandwidth (MHz)	
		QPSK	16QAM
20415	825.5	2.93	2.93
20525	836.5	2.92	2.92
20635	847.5	2.92	2.92

LTE Band 5, Channel Bandwidth 5MHz			
Channel	Frequency (MHz)	26dB Bandwidth (MHz)	
		QPSK	16QAM
20425	826.5	4.79	4.83
20525	836.5	4.79	4.79
20625	846.5	4.81	4.80

LTE Band 5, Channel Bandwidth 10MHz			
Channel	Frequency (MHz)	26dB Bandwidth (MHz)	
		QPSK	16QAM
20450	829.0	9.54	9.53
20525	836.5	9.50	9.50
20600	844.0	9.52	9.52

### Spectrum Plot of Worst Value

#### 1.4MHz / QPSK

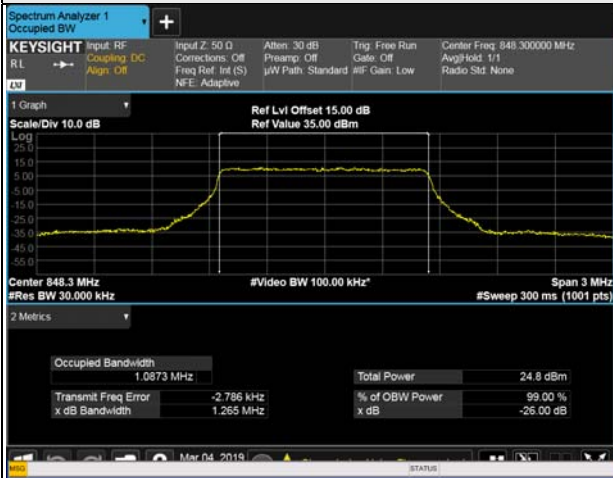

#### 3MHz / 16QAM

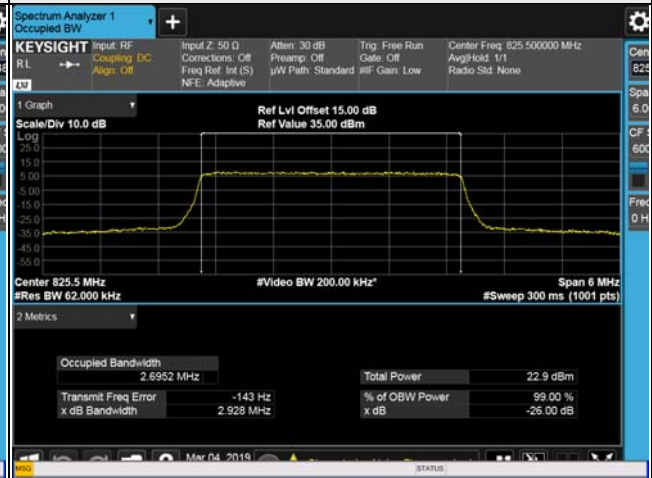

#### 5MHz / 16QAM



#### 10MHz / QPSK



LTE Band 26, Channel Bandwidth 1.4MHz			
Channel	Frequency (MHz)	26dB Bandwidth (MHz)	
		QPSK	16QAM
26797	824.7	1.26	1.25
26915	836.5	1.26	1.26
27033	848.3	1.26	1.26

LTE Band 26, Channel Bandwidth 3MHz			
Channel	Frequency (MHz)	26dB Bandwidth (MHz)	
		QPSK	16QAM
26805	825.5	2.93	2.93
26915	836.5	2.91	2.92
27025	847.5	2.92	2.92

LTE Band 26, Channel Bandwidth 5MHz			
Channel	Frequency (MHz)	26dB Bandwidth (MHz)	
		QPSK	16QAM
26815	826.5	4.84	4.81
26915	836.5	4.79	4.80
27015	846.5	4.81	4.80

LTE Band 26, Channel Bandwidth 10MHz			
Channel	Frequency (MHz)	26dB Bandwidth (MHz)	
		QPSK	16QAM
26840	829.0	9.54	9.53
26915	836.5	9.50	9.51
26990	844.0	9.52	9.52

LTE Band 26, Channel Bandwidth 15MHz			
Channel	Frequency (MHz)	26dB Bandwidth (MHz)	
		QPSK	16QAM
26865	831.5	14.25	14.23
26915	836.5	14.22	14.20
26965	841.5	14.23	14.22

### Spectrum Plot of Worst Value

1.4MHz / 16QAM

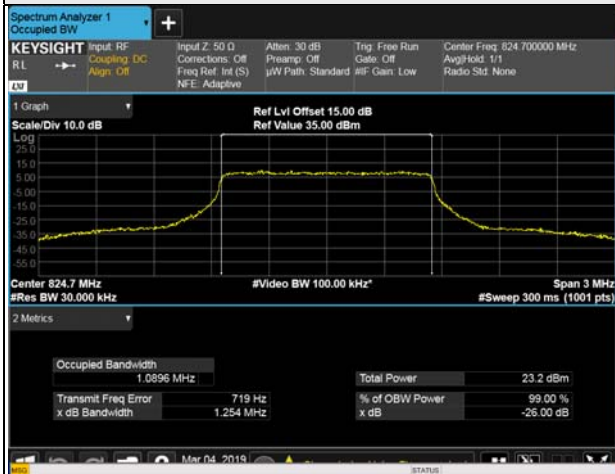

3MHz / 16QAM



5MHz / QPSK

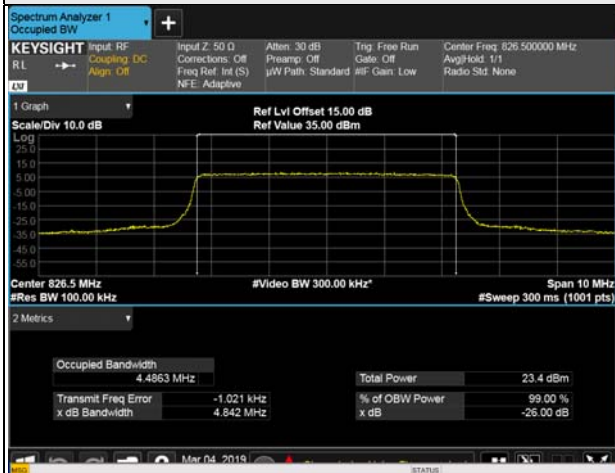

10MHz / QPSK

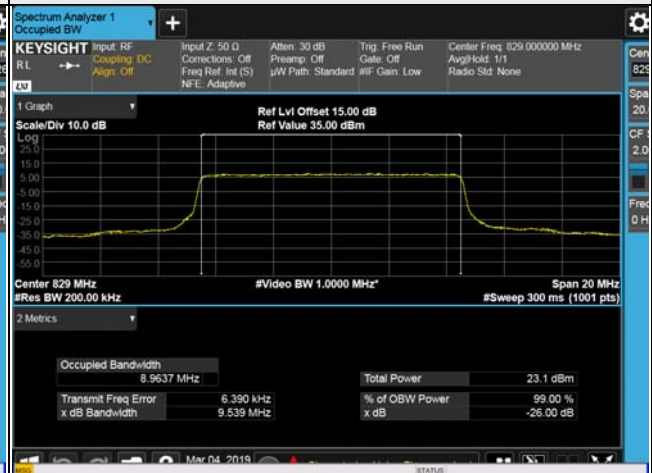

15MHz / QPSK

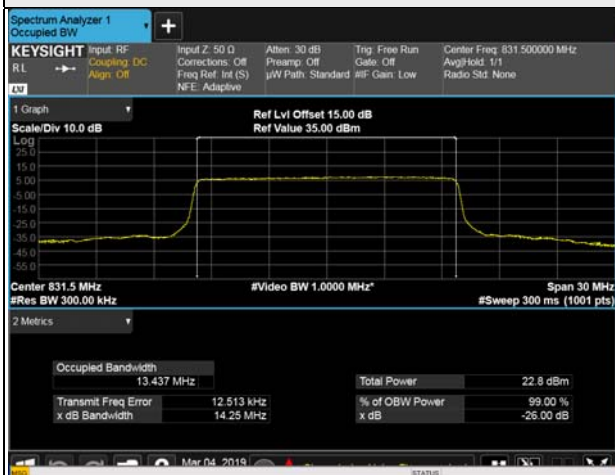

## 4.4 Band Edge Measurement

### 4.4.1 Limits of Band Edge Measurement

Power of any emission outside of the authorized operating frequency ranges must be attenuated below the transmitting power (P) by a factor of at least  $43 + 10 \log(P)$  dB. In the 1 MHz bands immediately outside and adjacent to the frequency block a resolution bandwidth of at least one percent of the emission bandwidth of the fundamental emission of the transmitter may be employed.

### 4.4.2 Test Setup

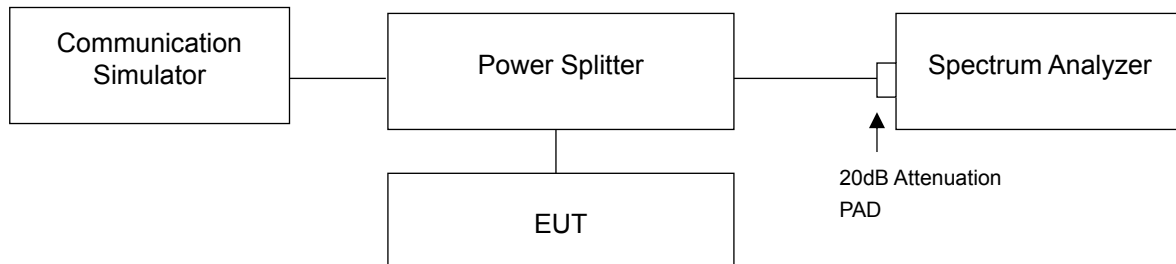

### 4.4.3 Test Procedures

- a. All measurements were done at low and high operational frequency range.
- b. The center frequency of spectrum is the band edge frequency and span is 1.5MHz. RB of the spectrum is 10kHz and VB of the spectrum is 30kHz (GSM / GPRS / EDGE).
- c. The center frequency of spectrum is the band edge frequency and span is 3MHz. RB of the spectrum is 3kHz and VB of the spectrum is 10kHz (CDMA).
- d. The center frequency of spectrum is the band edge frequency and span is 10MHz. RB of the spectrum is 51kHz and VB of the spectrum is 150kHz (WCDMA / HSDPA / HSUPA).
- e. The center frequency of spectrum is the band edge frequency and span is 1.5MHz. RB of the spectrum is 15kHz and VB of the spectrum is 51kHz (LTE Channel Bandwidth 1.4MHz).
- f. The center frequency of spectrum is the band edge frequency and span is 1.5MHz. RB of the spectrum is 30kHz and VB of the spectrum is 100kHz (LTE Channel Bandwidth 3MHz).
- g. The center frequency of spectrum is the band edge frequency and span is 1.5MHz. RB of the spectrum is 62kHz and VB of the spectrum is 200kHz (LTE Channel Bandwidth 5MHz).
- h. The center frequency of spectrum is the band edge frequency and span is 1.5MHz. RB of the spectrum is 100kHz and VB of the spectrum is 300kHz (LTE Channel Bandwidth 10MHz).
- i. The center frequency of spectrum is the band edge frequency and span is 1.5MHz. RB of the spectrum is 150kHz and VB of the spectrum is 470kHz (LTE Channel Bandwidth 15MHz).
- j. Record the max trace plot into the test report.

### 4.4.4 Test Results

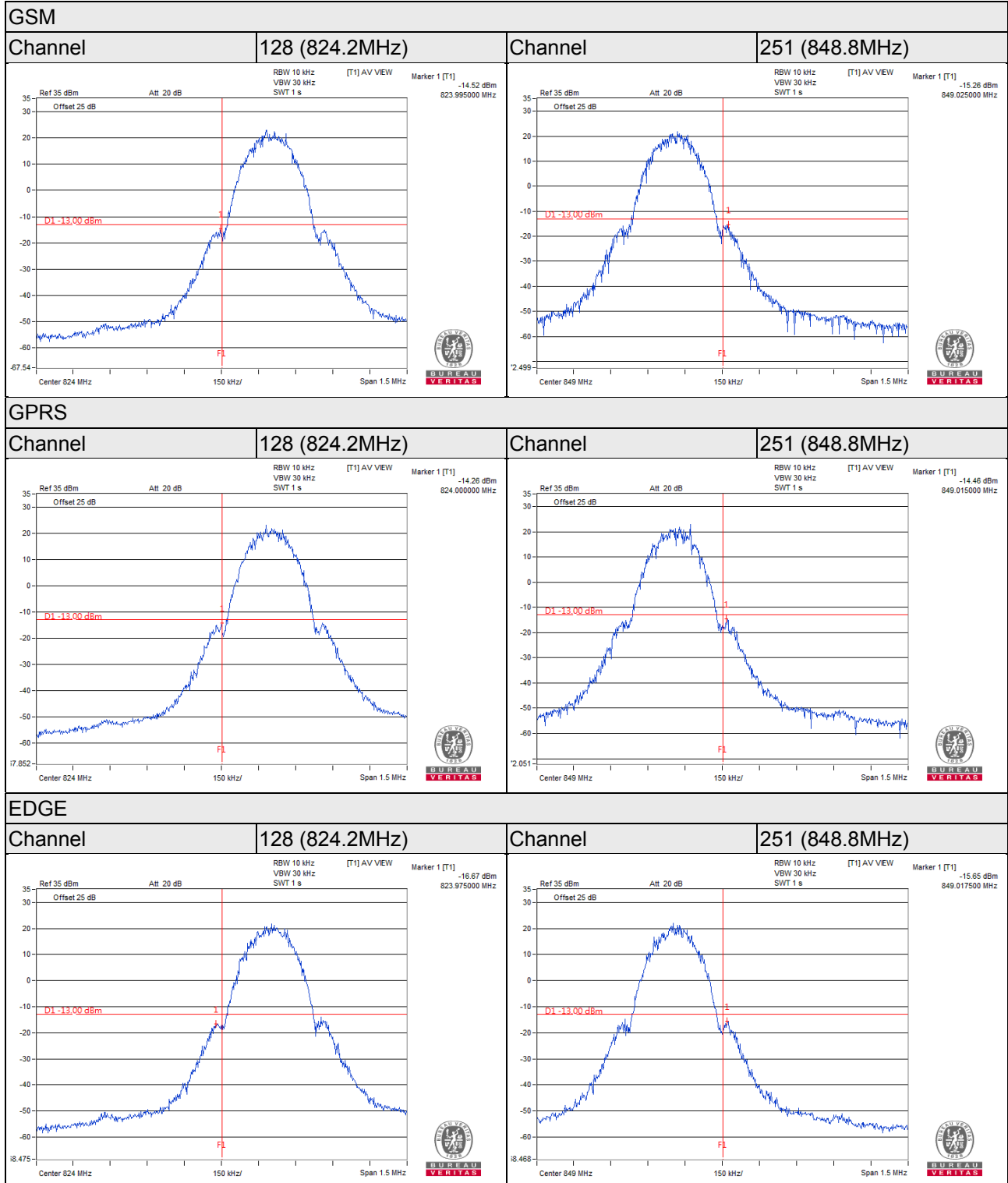

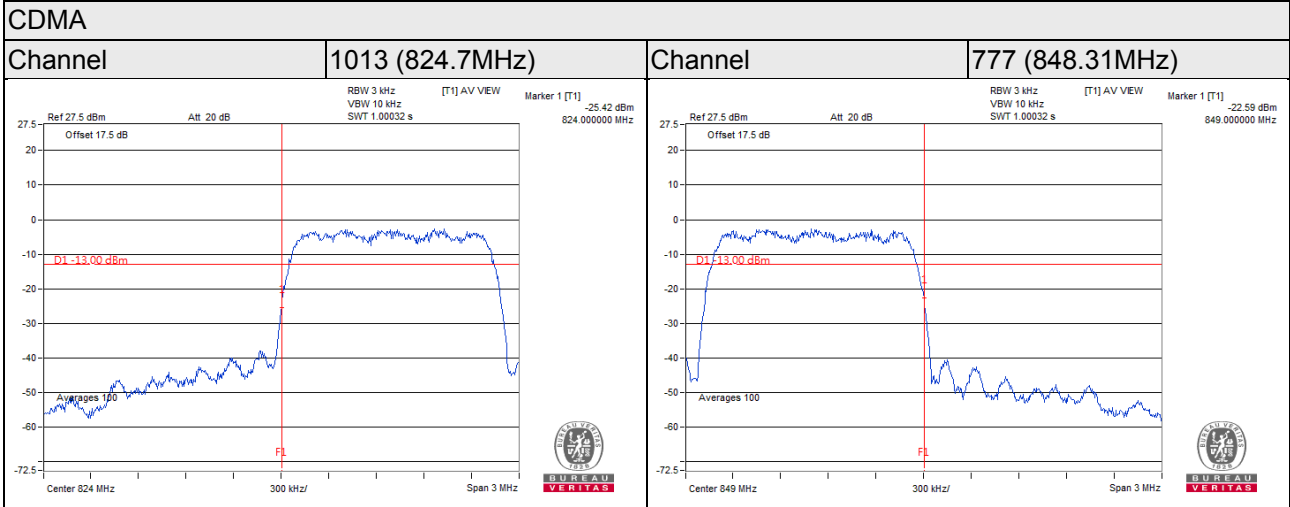



### WCDMA

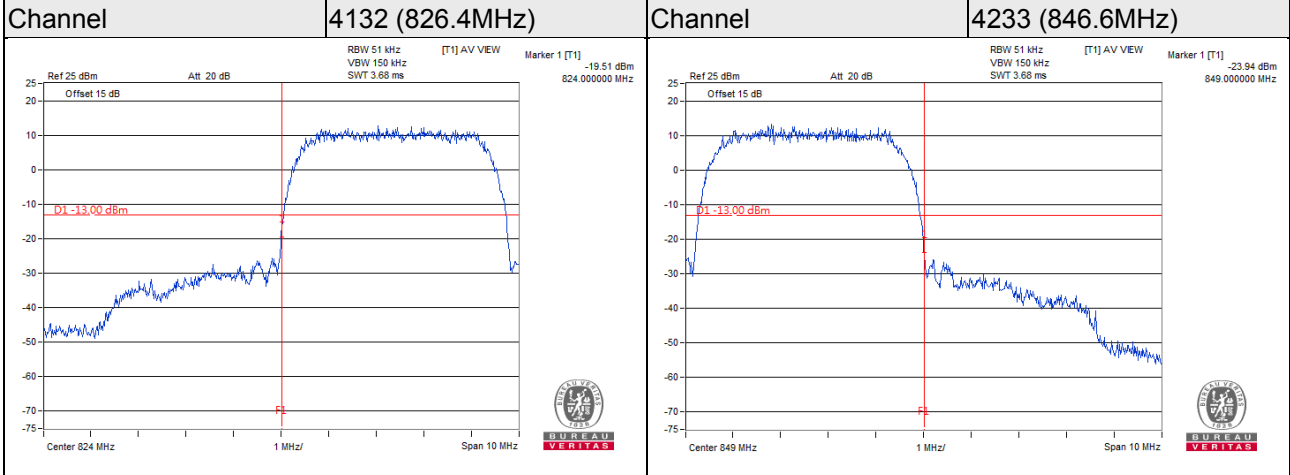

### HSDPA

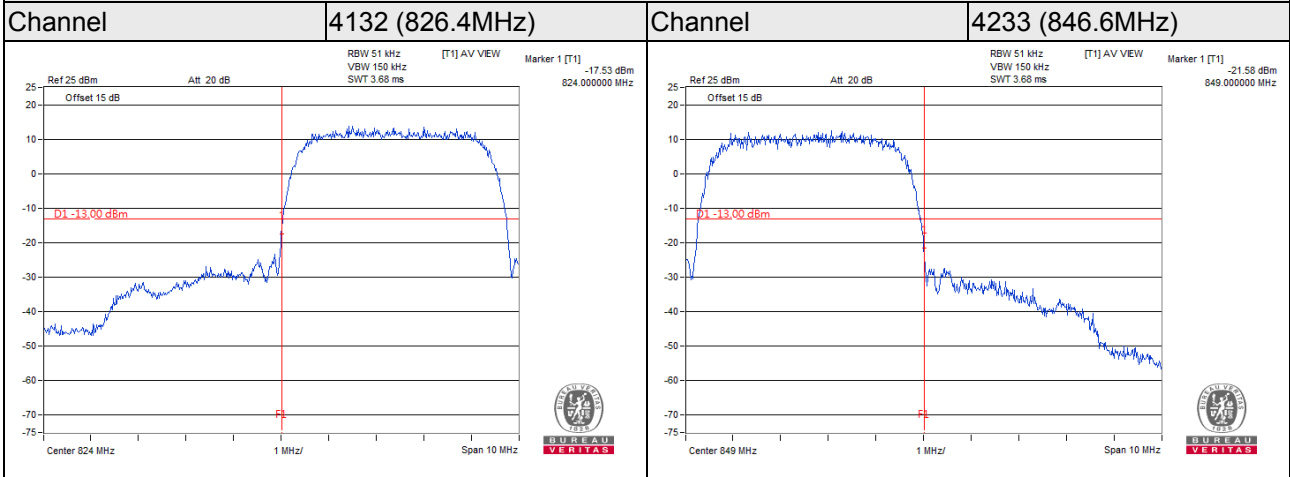

### HSUPA

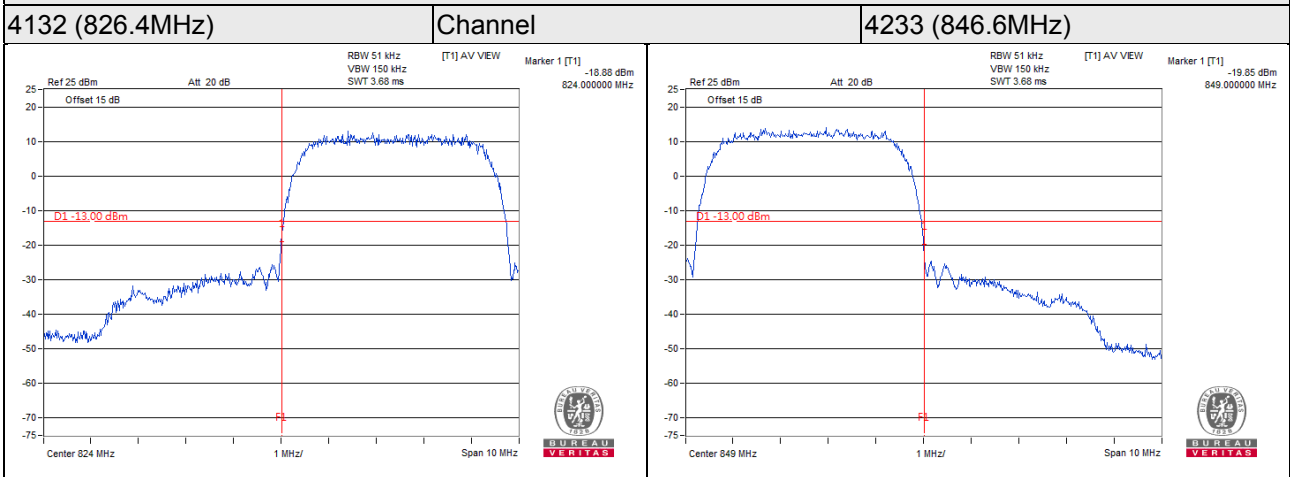

LTE Band 5, Channel Bandwidth 1.4MHz

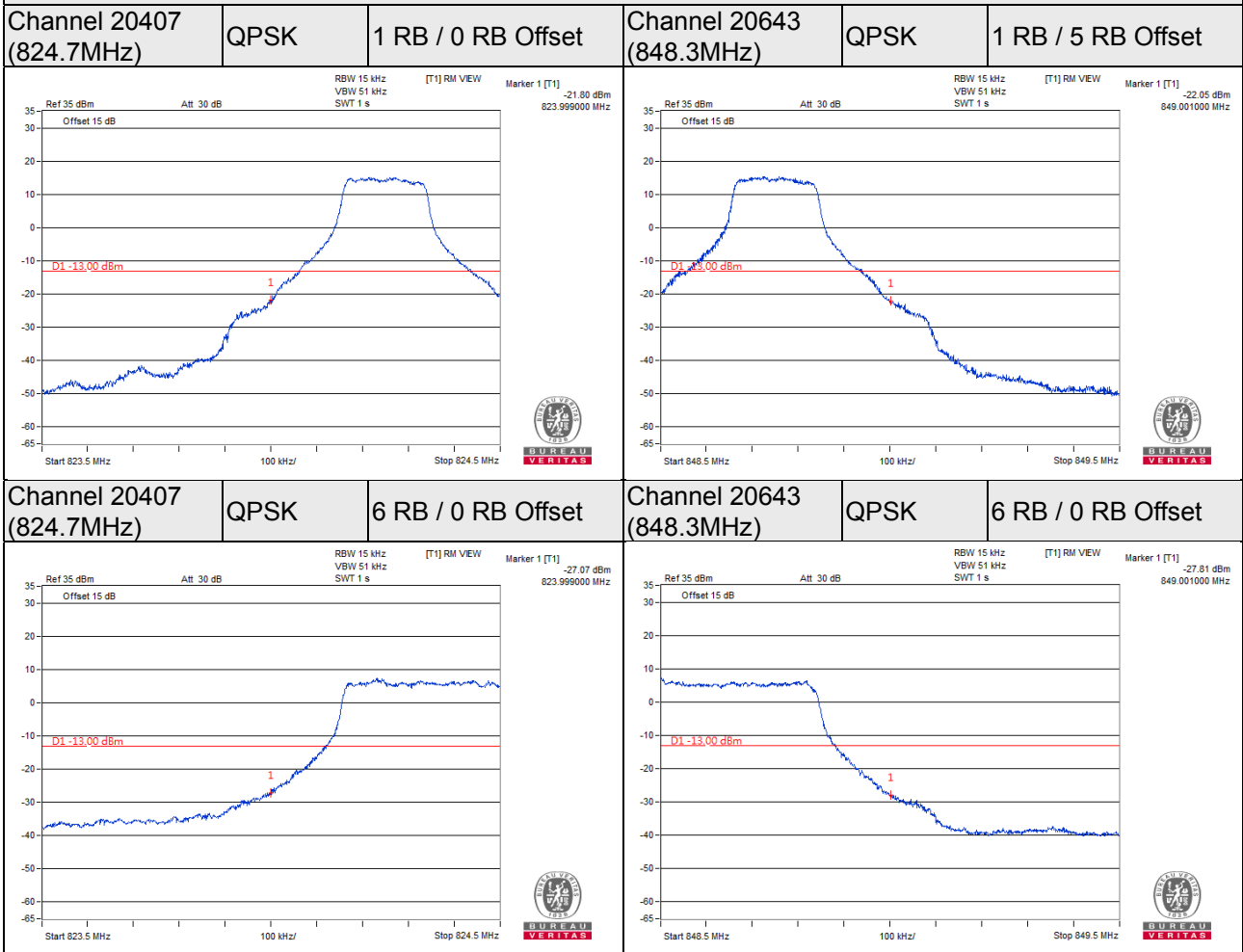

LTE Band 5, Channel Bandwidth 3MHz

Channel 20415 (825.5MHz)	QPSK	1 RB / 0 RB Offset	Channel 20635 (847.5MHz)	QPSK	1 RB / 14 RB Offset
-----------------------------	------	--------------------	-----------------------------	------	---------------------

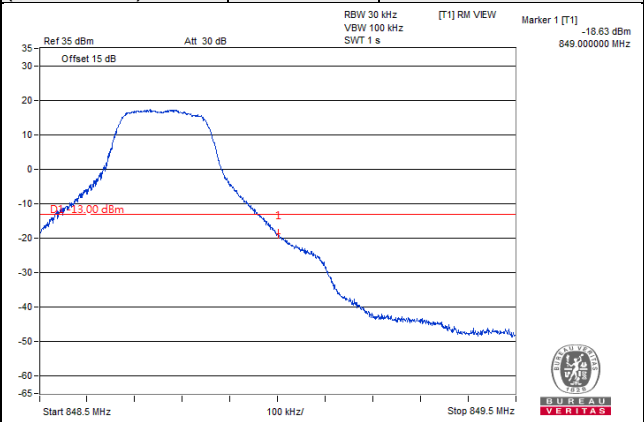
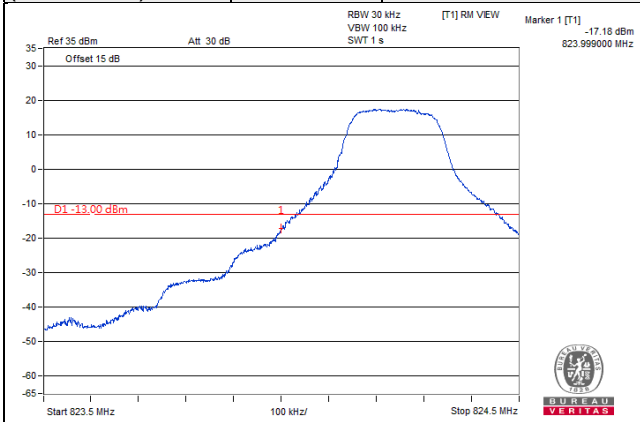

Channel 20415 (825.5MHz)	QPSK	15 RB / 0 RB Offset	Channel 20635 (847.5MHz)	QPSK	15 RB / 0 RB Offset
-----------------------------	------	---------------------	-----------------------------	------	---------------------

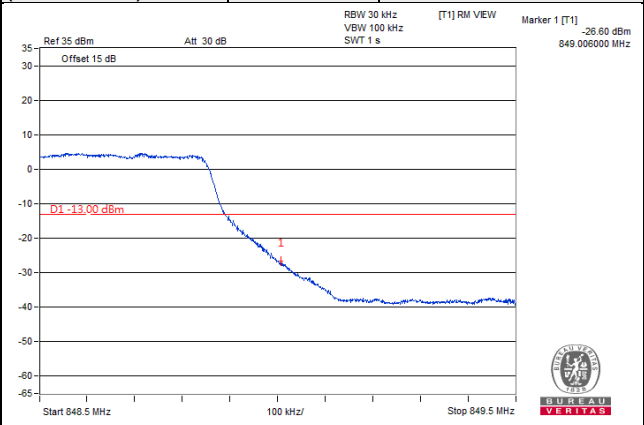
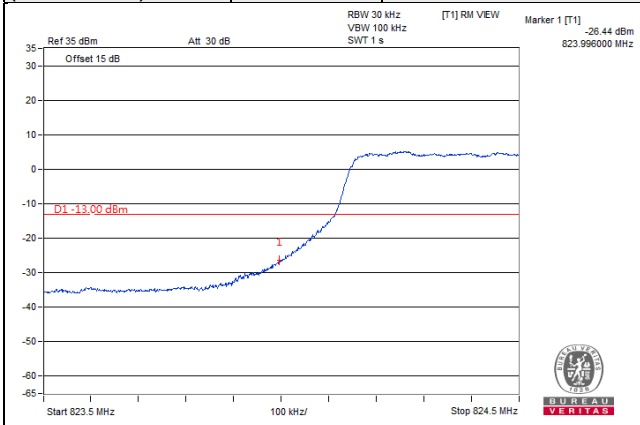

**LTE Band 5, Channel Bandwidth 5MHz**

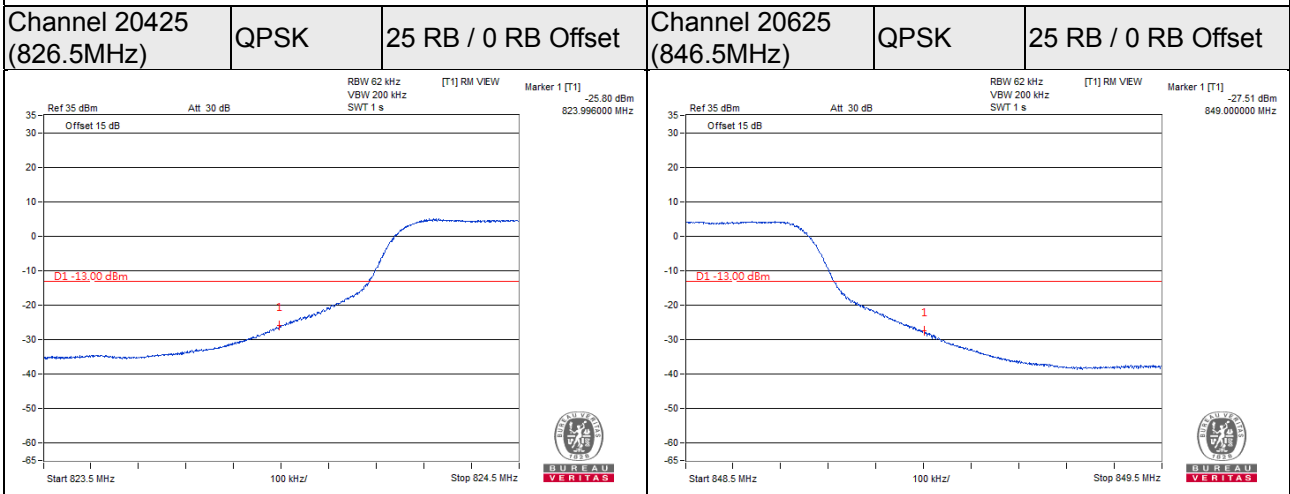
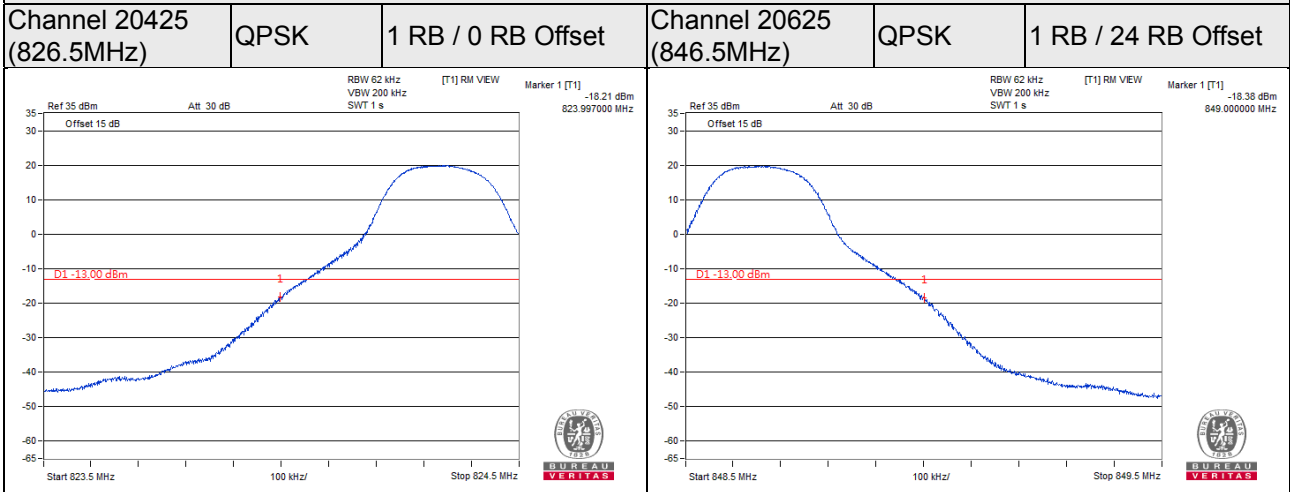

LTE Band 5, Channel Bandwidth 10MHz

Channel 20450 (829.0MHz)	QPSK	1 RB / 0 RB Offset	Channel 20600 (844.0MHz)	QPSK	1 RB / 49 RB Offset
-----------------------------	------	--------------------	-----------------------------	------	---------------------

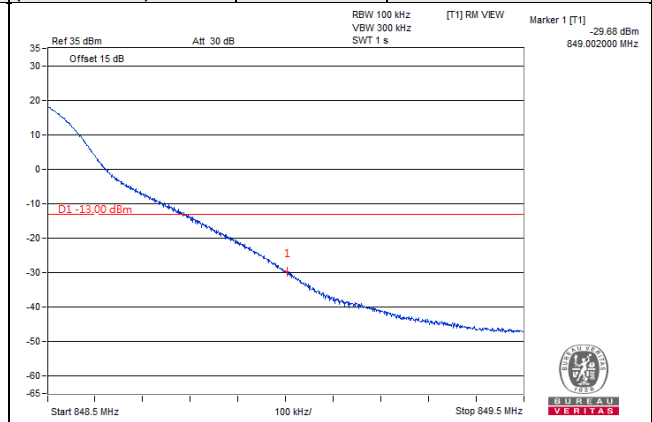
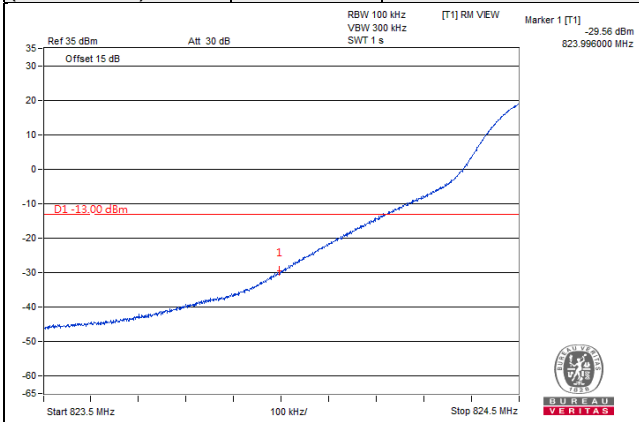

Channel 20450 (829.0MHz)	QPSK	50 RB / 0 RB Offset
-----------------------------	------	---------------------

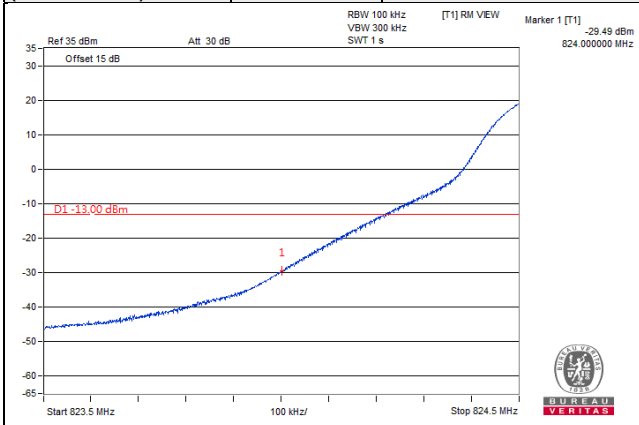

Channel 20600 (844.0MHz)	QPSK	50 RB / 0 RB Offset
-----------------------------	------	---------------------

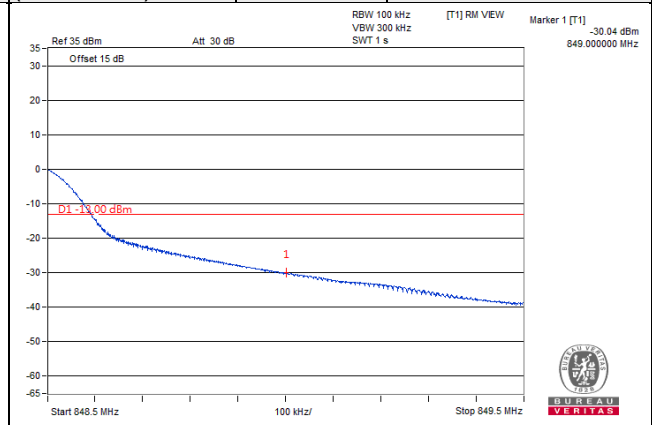

LTE Band 26, Channel Bandwidth 1.4MHz

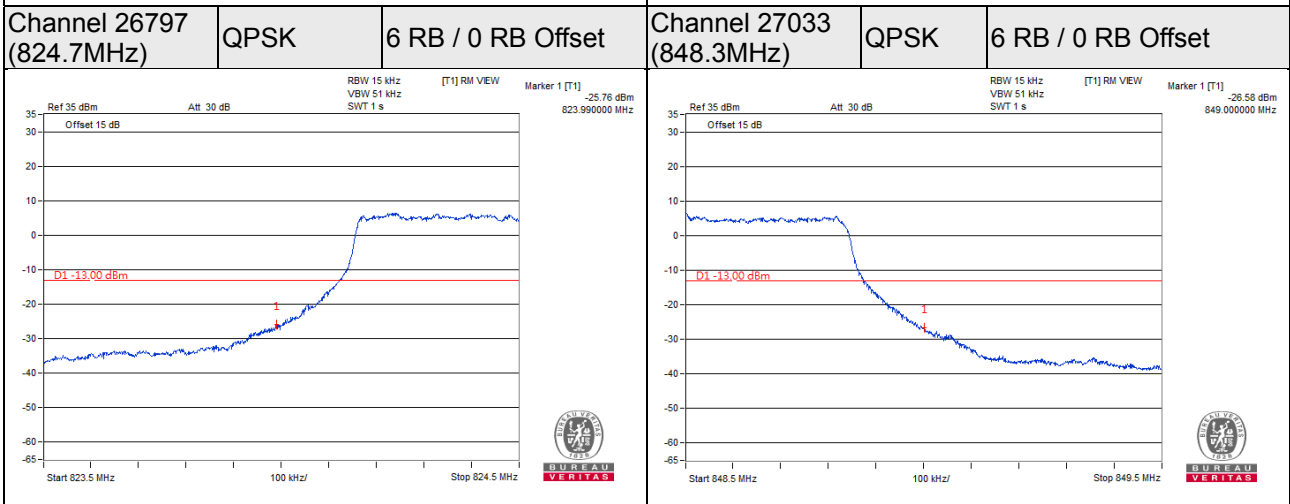
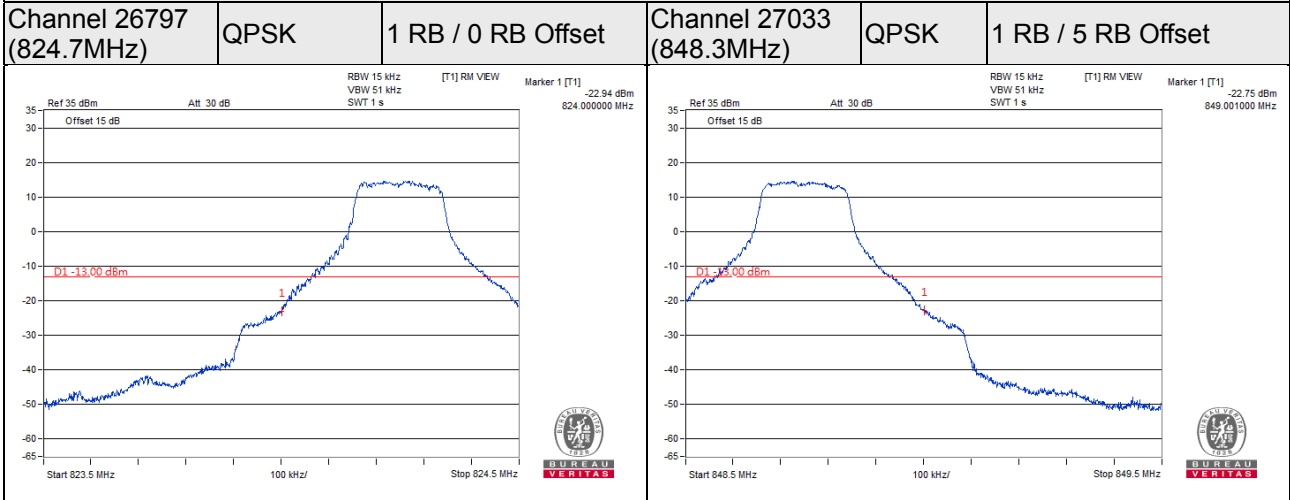

**LTE Band 26, Channel Bandwidth 3MHz**

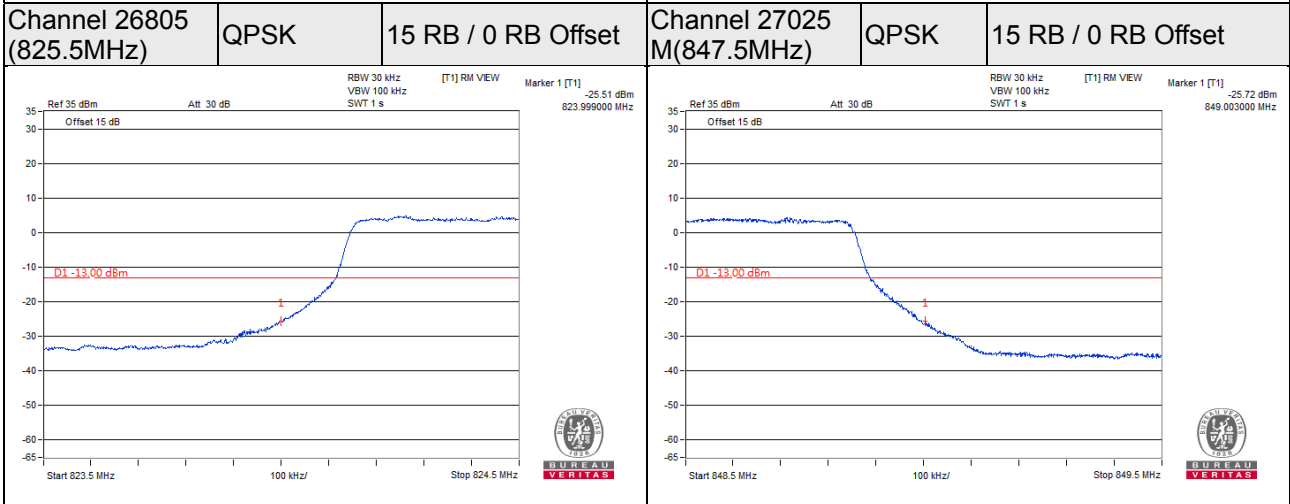
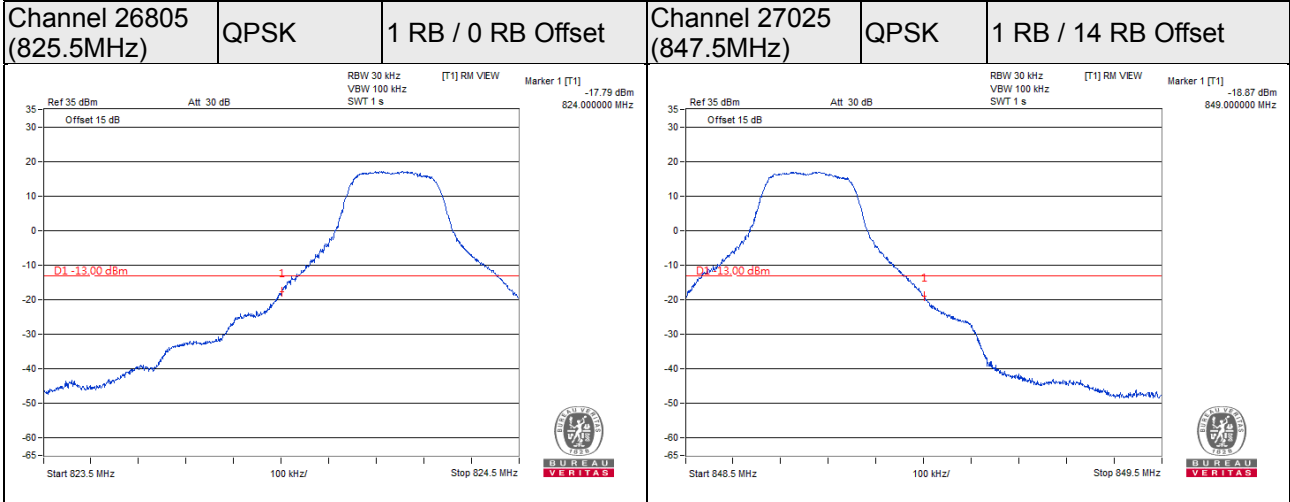

**LTE Band 26, Channel Bandwidth 5MHz**

<b>Channel 26815 (826.5MHz)</b>	<b>QPSK</b>	<b>1 RB / 0 RB Offset</b>	<b>Channel 27015 (846.5MHz)</b>	<b>QPSK</b>	<b>1 RB / 24 RB Offset</b>
-------------------------------------	-------------	---------------------------	-------------------------------------	-------------	----------------------------

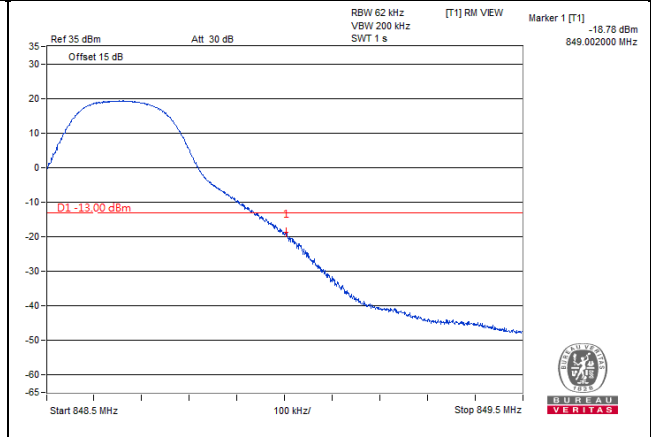
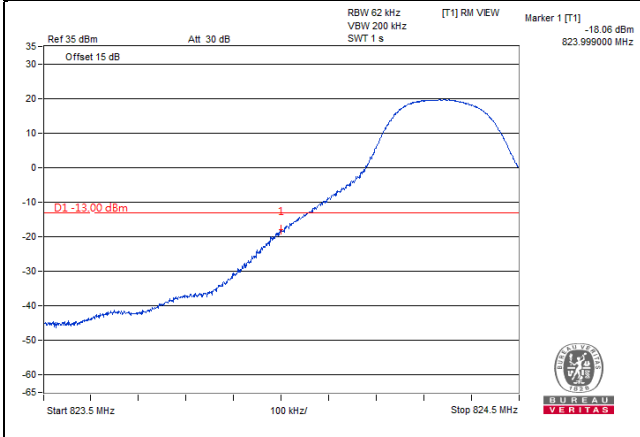

<b>Channel 26815 (826.5MHz)</b>	<b>QPSK</b>	<b>25 RB / 0 RB Offset</b>	<b>Channel 27015 (846.5MHz)</b>	<b>QPSK</b>	<b>25 RB / 0 RB Offset</b>
-------------------------------------	-------------	----------------------------	-------------------------------------	-------------	----------------------------

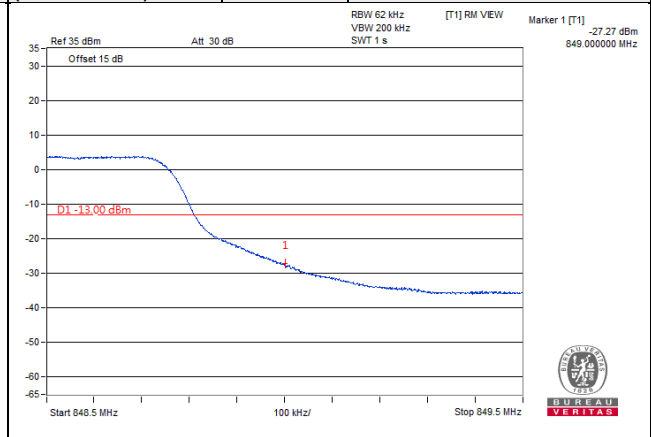
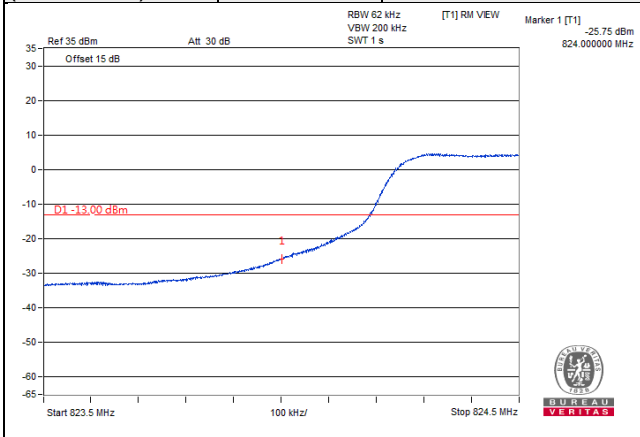



LTE Band 26, Channel Bandwidth 10MHz

Channel 26840 (829MHz)	QPSK	1 RB / 0 RB Offset	Channel 26990 (844MHz)	QPSK	1 RB / 49 RB Offset
---------------------------	------	--------------------	---------------------------	------	---------------------

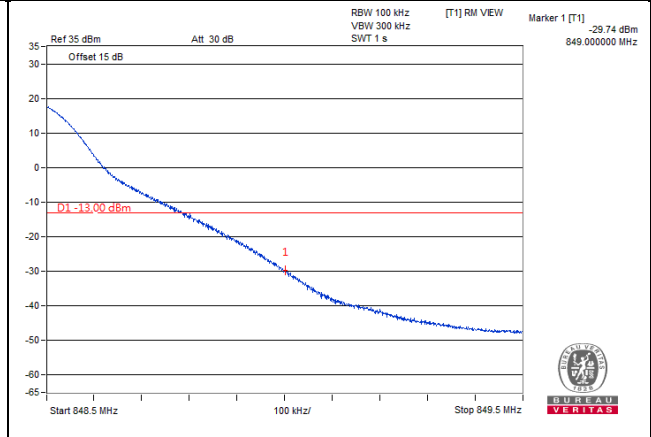
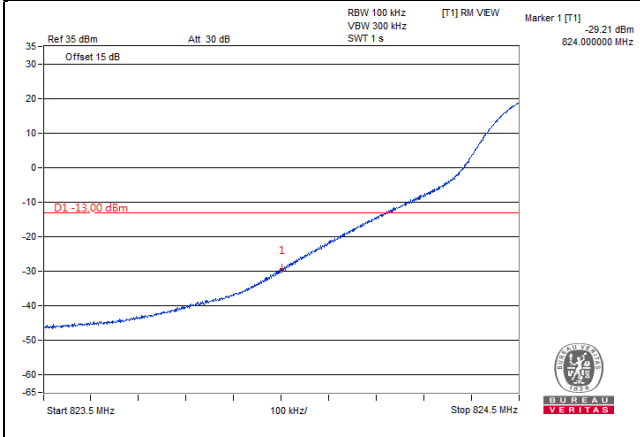

Channel 26840 (829MHz)	QPSK	50 RB / 0 RB Offset	Channel 26990 (844MHz)	QPSK	50 RB / 0 RB Offset
---------------------------	------	---------------------	---------------------------	------	---------------------

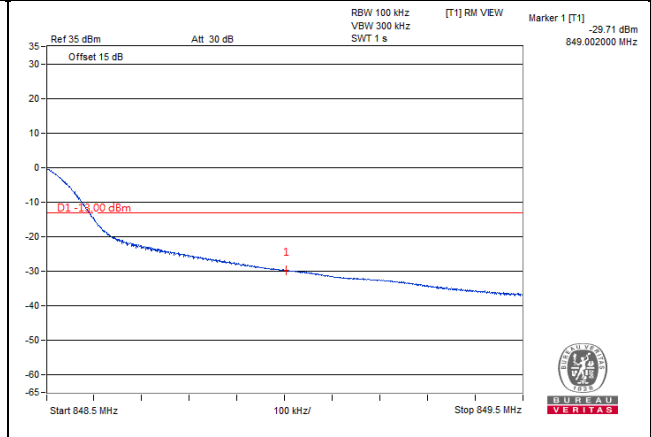
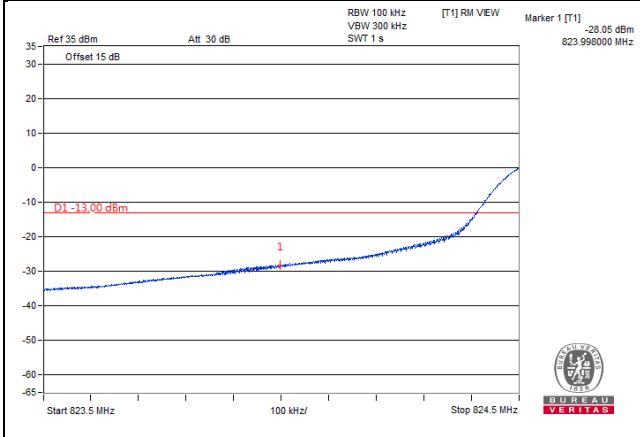

LTE Band 26, Channel Bandwidth 15MHz

Channel 26915 (831.5MHz)	QPSK	1 RB / 0 RB Offset	Channel 26965 (841.5MHz)	QPSK	1 RB / 74 RB Offset
-----------------------------	------	--------------------	-----------------------------	------	---------------------

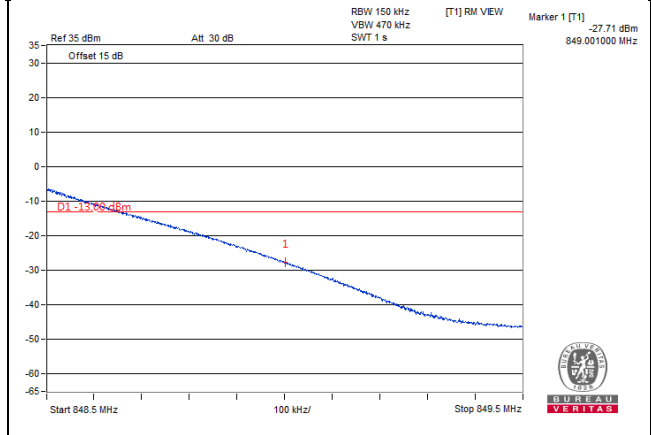
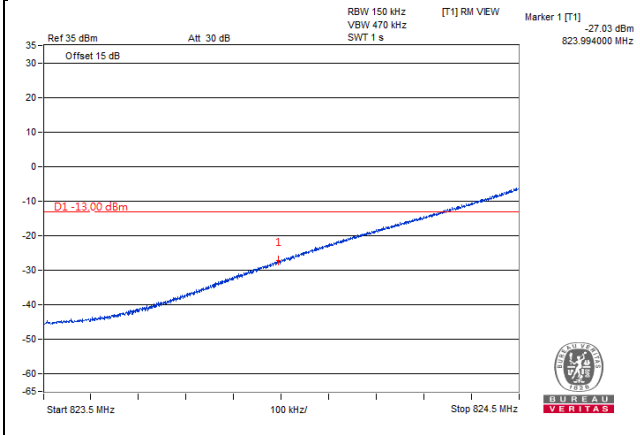

Channel 26915 (831.5MHz)	QPSK	75 RB / 0 RB Offset	Channel 26965 (841.5MHz)	QPSK	75 RB / 0 RB Offset
-----------------------------	------	---------------------	-----------------------------	------	---------------------

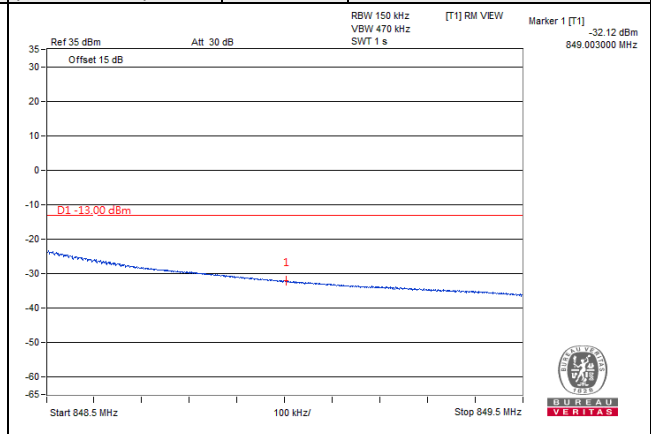
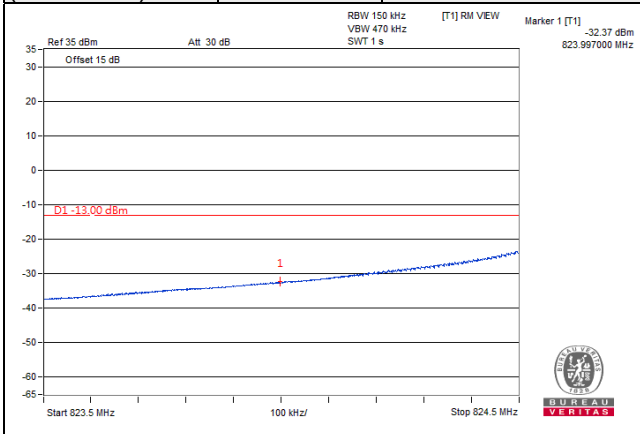

## 4.5 Peak to Average Ratio

### 4.5.1 Limits of Peak to Average Ratio Measurement

In measuring transmissions in this band using an average power technique, the peak to-average ratio (PAR) of the transmission may not exceed 13 dB

### 4.5.2 Test Setup

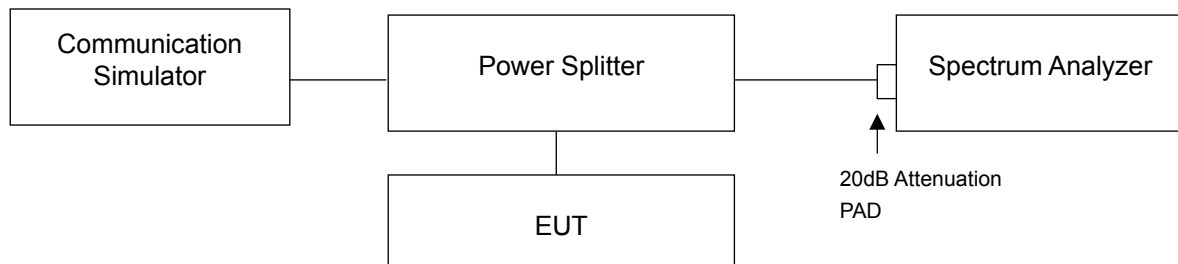

### 4.5.3 Test Procedures

- Set resolution/measurement bandwidth  $\geq$  signal's occupied bandwidth;
- Set the number of counts to a value that stabilizes the measured CCDF curve;
- Record the maximum PAPR level associated with a probability of 0.1%.

#### 4.5.4 Test Results

Channel	Frequency (MHz)	Peak To Average Ratio (dB)		
		GSM	GPRS	EDGE
128	824.2	3.00	3.02	3.00
189	836.4	3.01	3.01	3.00
251	848.8	3.00	3.00	3.00

#### Spectrum Plot of Worst Value

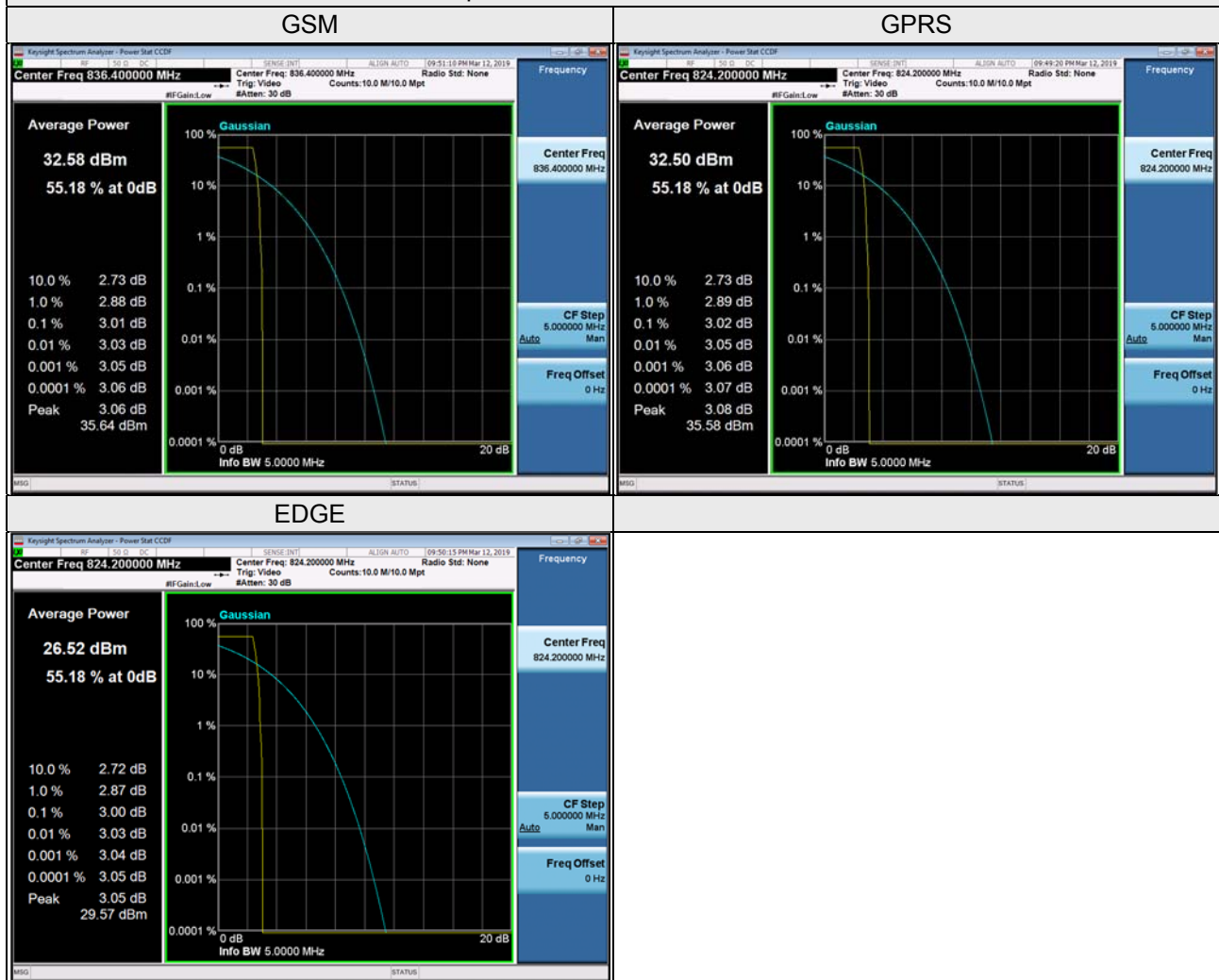

Channel	Frequency (MHz)	Peak To Average Ratio (dB)
		CDMA
1013	824.70	5.08
384	836.52	5.07
777	848.31	5.01

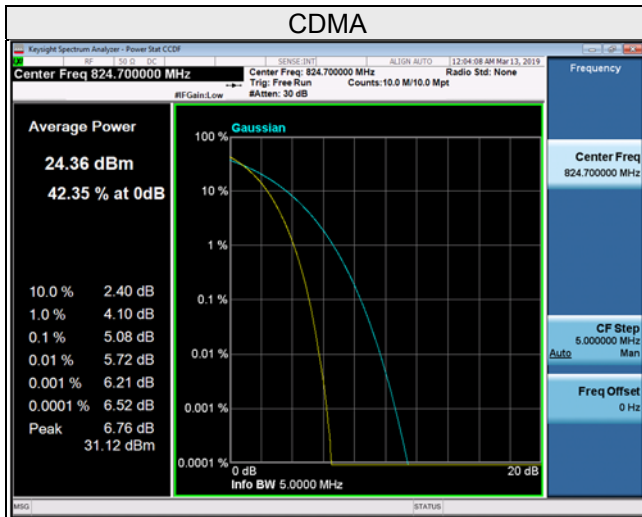

WCDMA Band 5

Channel	Frequency (MHz)	Peak To Average Ratio (dB)		
		WCDMA	HSDPA	HSUPA
4132	826.4	3.01	3.00	3.00
4182	836.6	3.00	2.99	2.99
4233	846.6	3.02	3.02	3.02

Spectrum Plot of Worst Value

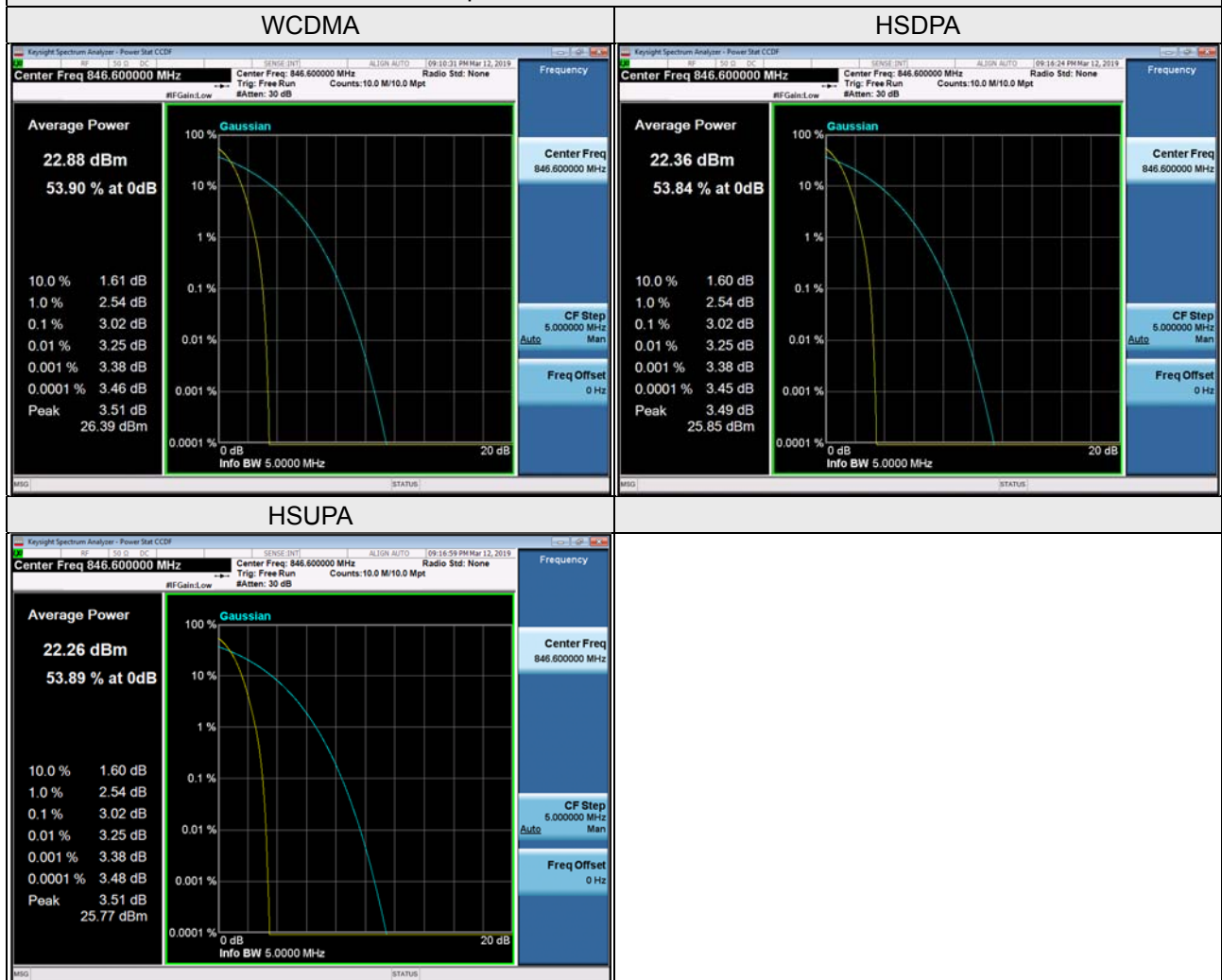

LTE Band 5, Channel Bandwidth 1.4MHz			
Channel	Frequency (MHz)	Peak To Average Ratio (dB)	
		QPSK	16QAM
20407	824.7	3.64	4.33
20525	836.5	3.66	4.38
20643	848.3	3.50	4.31

LTE Band 5, Channel Bandwidth 3MHz			
Channel	Frequency (MHz)	Peak To Average Ratio (dB)	
		QPSK	16QAM
20415	825.5	3.64	4.34
20525	836.5	3.65	4.37
20635	847.5	3.60	4.36

LTE Band 5, Channel Bandwidth 5MHz			
Channel	Frequency (MHz)	Peak To Average Ratio (dB)	
		QPSK	16QAM
20425	826.5	3.54	4.22
20525	836.5	3.58	4.34
20625	846.5	3.58	4.31

LTE Band 5, Channel Bandwidth 10MHz			
Channel	Frequency (MHz)	Peak To Average Ratio (dB)	
		QPSK	16QAM
20450	829.0	3.53	4.27
20525	836.5	3.58	4.29
20600	844.0	3.51	4.27

### Spectrum Plot of Worst Value

1.4MHz / 16QAM

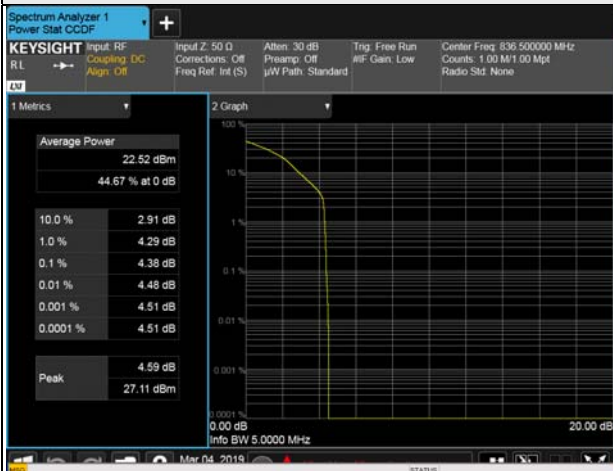

3MHz / 16QAM

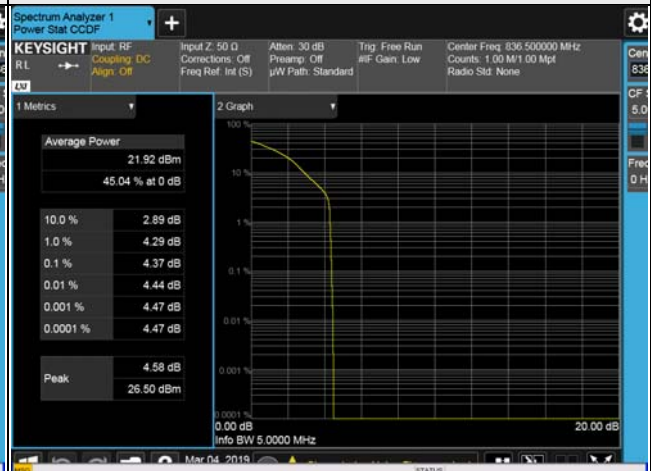

5MHz / 16QAM



10MHz / 16QAM





LTE Band 26, Channel Bandwidth 1.4MHz			
Channel	Frequency (MHz)	Peak To Average Ratio (dB)	
		QPSK	16QAM
26797	824.7	3.50	4.24
26915	836.5	3.53	4.26
27033	848.3	3.45	4.20

LTE Band 26, Channel Bandwidth 3MHz			
Channel	Frequency (MHz)	Peak To Average Ratio (dB)	
		QPSK	16QAM
26805	825.5	3.52	4.22
26915	836.5	3.58	4.32
27025	847.5	3.53	4.28

LTE Band 26, Channel Bandwidth 5MHz			
Channel	Frequency (MHz)	Peak To Average Ratio (dB)	
		QPSK	16QAM
26815	826.5	3.45	4.20
26915	836.5	3.51	4.28
27015	846.5	3.50	4.24

LTE Band 26, Channel Bandwidth 10MHz			
Channel	Frequency (MHz)	Peak To Average Ratio (dB)	
		QPSK	16QAM
26840	829.0	3.45	4.16
26915	836.5	3.51	4.24
26990	844.0	3.44	4.20

LTE Band 26, Channel Bandwidth 15MHz			
Channel	Frequency (MHz)	Peak To Average Ratio (dB)	
		QPSK	16QAM
26865	831.5	3.43	4.16
26915	836.5	3.46	4.20
26965	841.5	3.48	4.22

### Spectrum Plot of Worst Value

1.4MHz / 16QAM

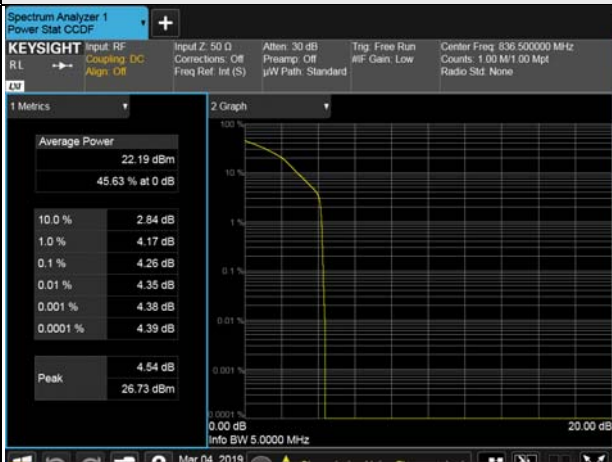

3MHz / 16QAM



5MHz / 16QAM

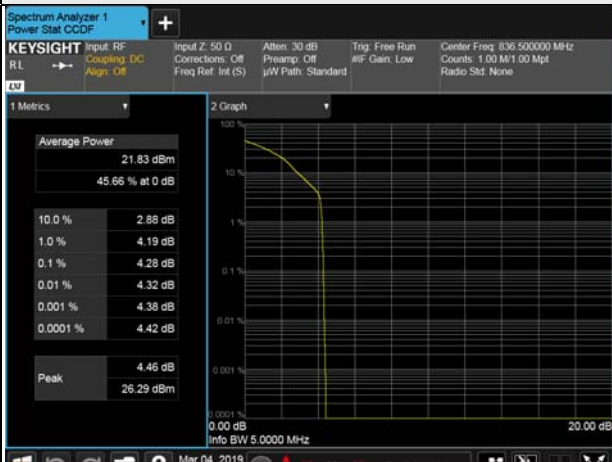

10MHz / 16QAM

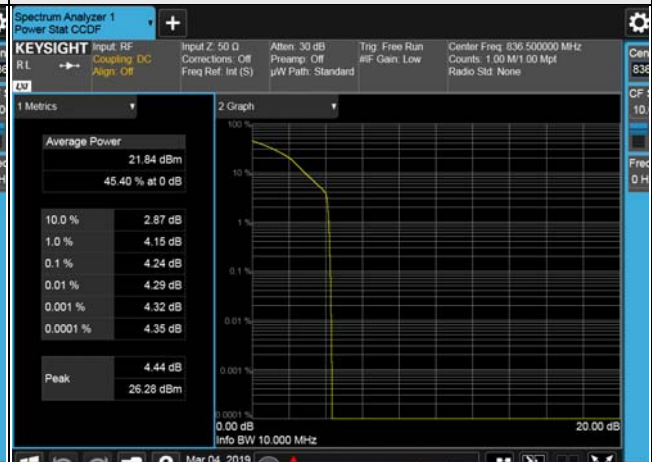

15MHz / 16QAM

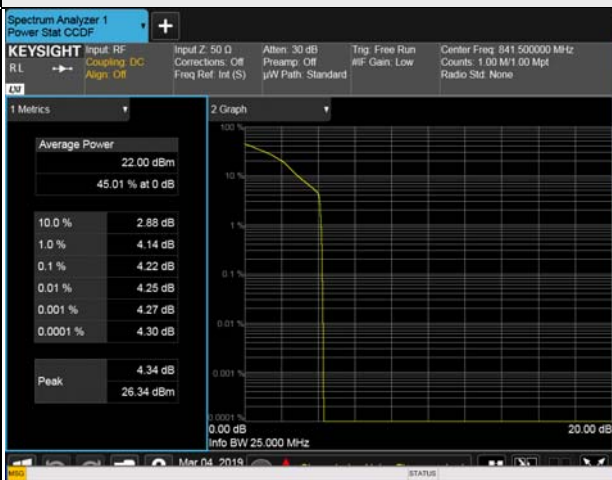

## 4.6 Conducted Spurious Emissions

### 4.6.1 Limits of Conducted Spurious Emissions Measurement

The power of any emission outside of the authorized operating frequency ranges must be attenuated below the transmitting power (P) by a factor of at least  $43 + 10 \log(P)$  dB. The emission limit equal to  $-13\text{dBm}$ .

### 4.6.2 Test Setup

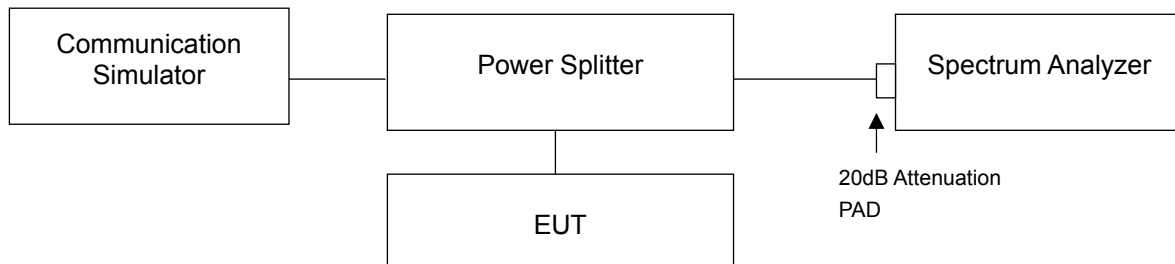

### 4.6.3 Test Procedure

- The EUT makes a phone call to the communication simulator. All measurements were done at low, middle and high operational frequency range.
- Measuring frequency range is from 9 kHz to 1GHz. 20dB attenuation pad is connected with spectrum. RBW=100kHz and VBW=300kHz is used for conducted emission measurement.
- Measuring frequency range is from 1GHz to 27GHz. 20dB attenuation pad is connected with spectrum. RBW=1MHz and VBW=3MHz is used for conducted emission measurement.

### 4.6.4 Test Results

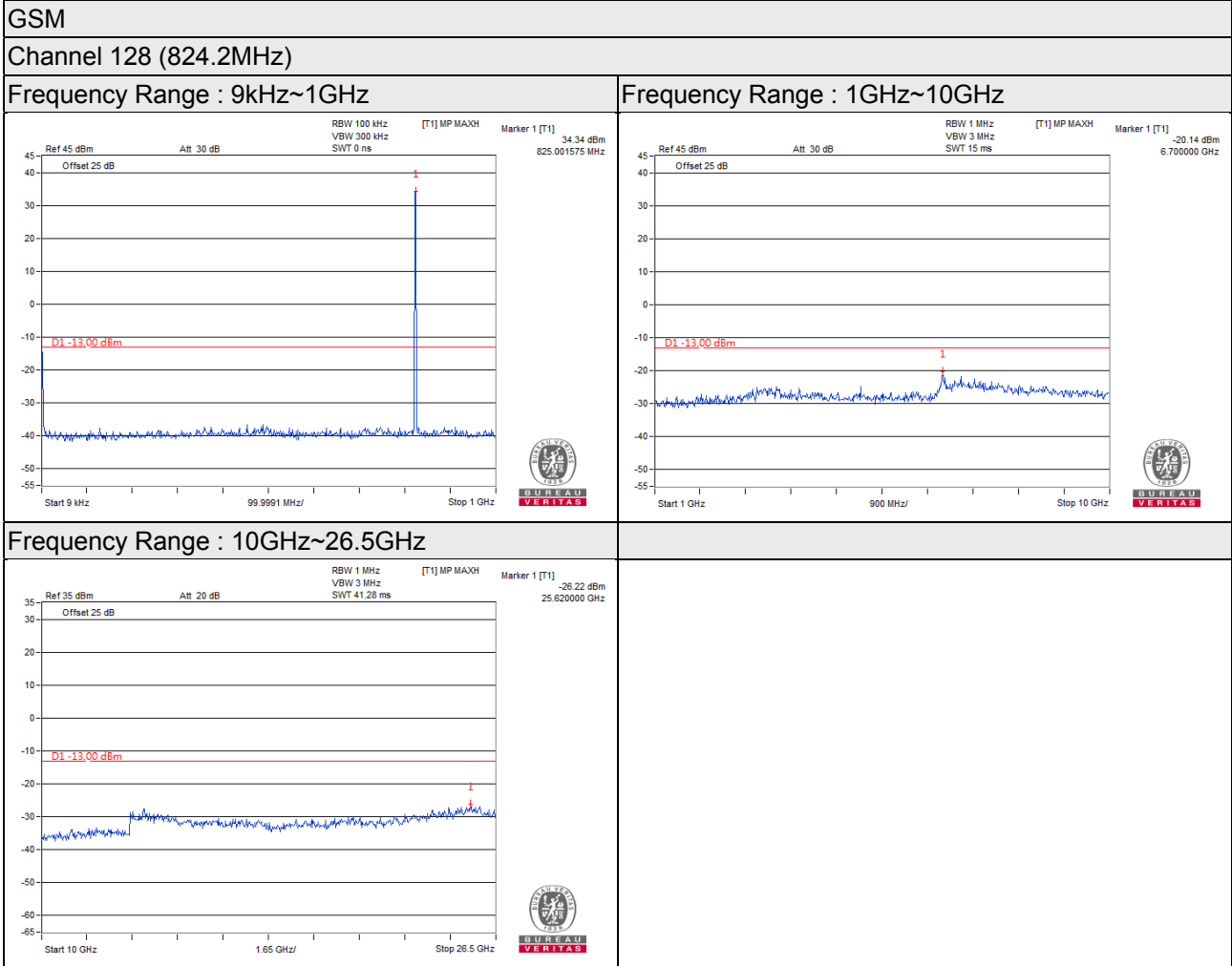

**GSM**

**Channel 189 (836.4MHz)**

**Frequency Range : 9kHz~1GHz**

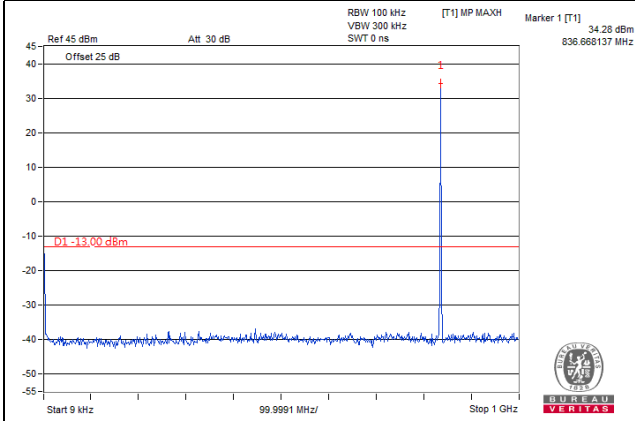

**Frequency Range : 1GHz~10GHz**

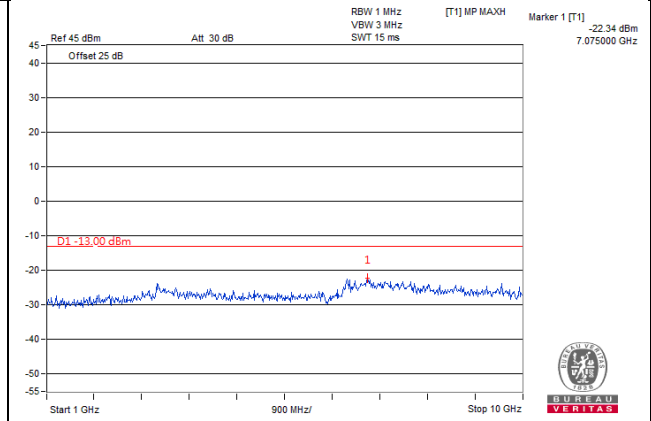

**Frequency Range : 10GHz~26.5GHz**

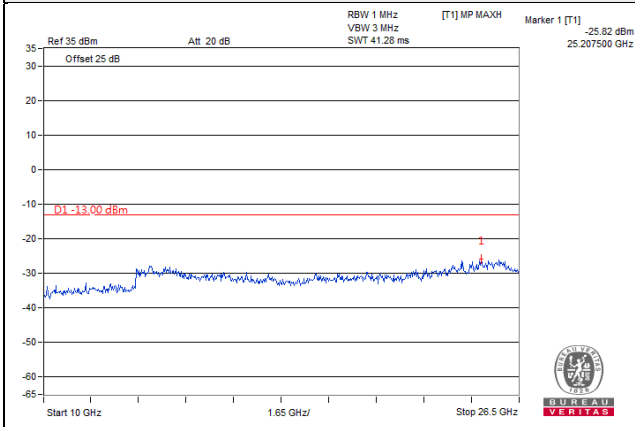

**GSM**

**Channel 251 (848.8MHz)**

**Frequency Range : 9kHz~1GHz**

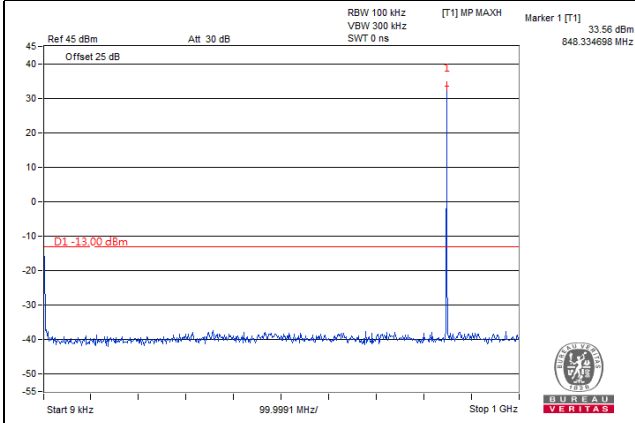

**Frequency Range : 1GHz~10GHz**

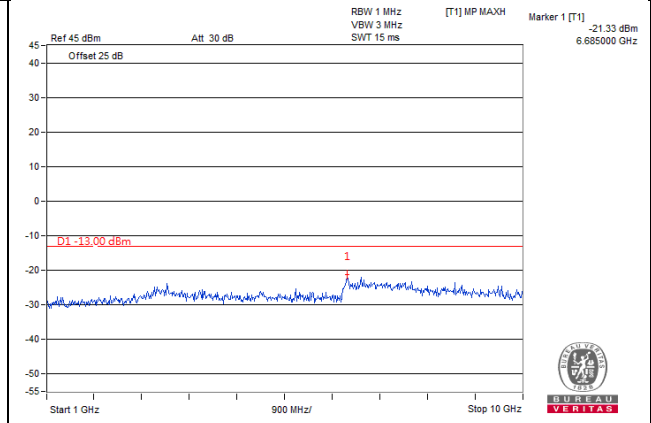

**Frequency Range : 10GHz~26.5GHz**

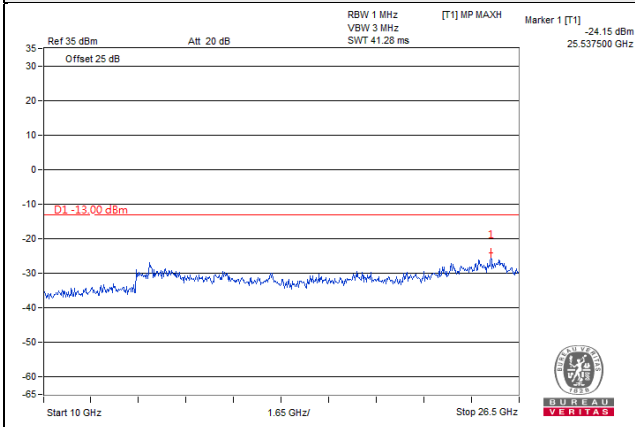

**GPRS**

**Channel 128 (824.2MHz)**

**Frequency Range : 9kHz~1GHz**

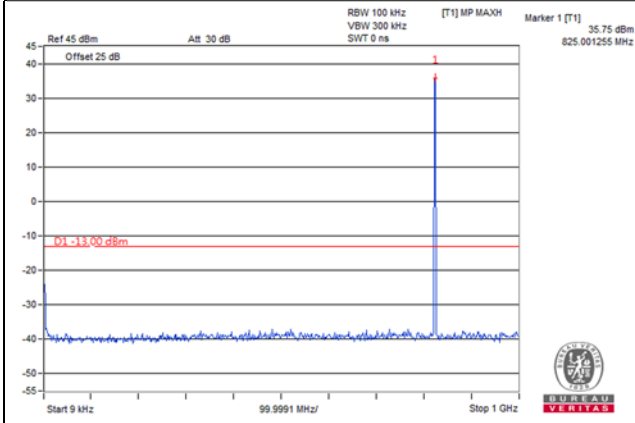

**Frequency Range : 1GHz~10GHz**

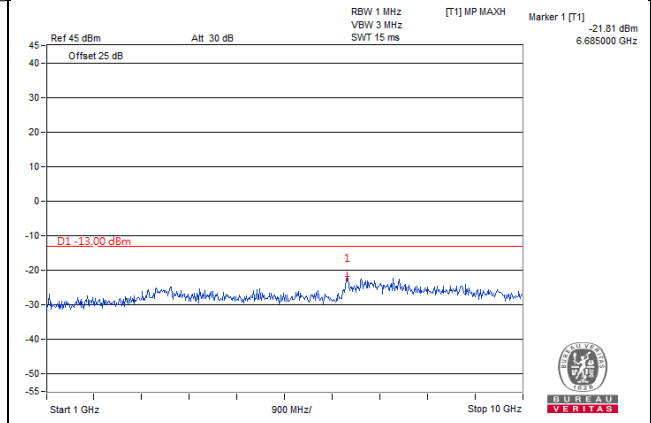

**Frequency Range : 10GHz~26.5GHz**

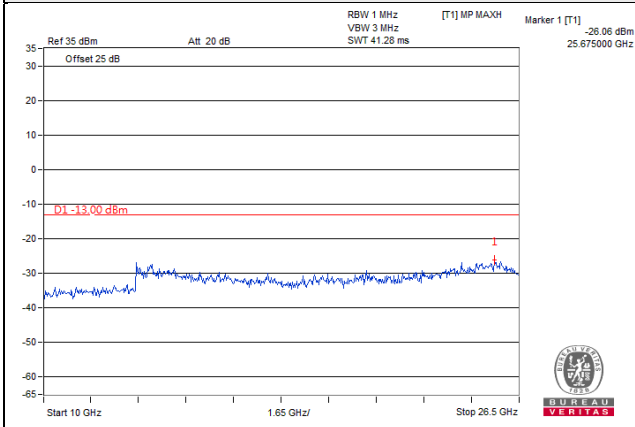

**GPRS**

**Channel 189 (836.4MHz)**

**Frequency Range : 9kHz~1GHz**

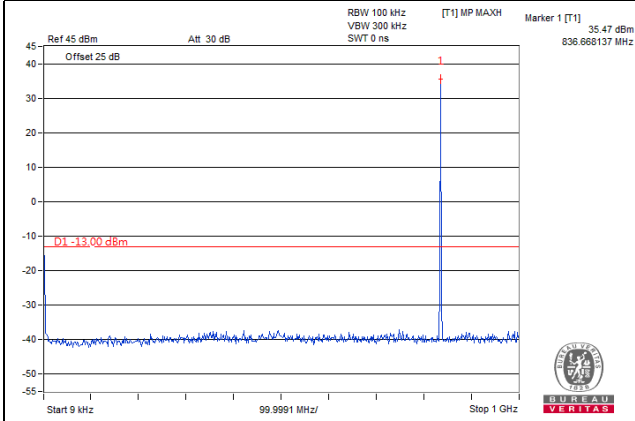

**Frequency Range : 1GHz~10GHz**

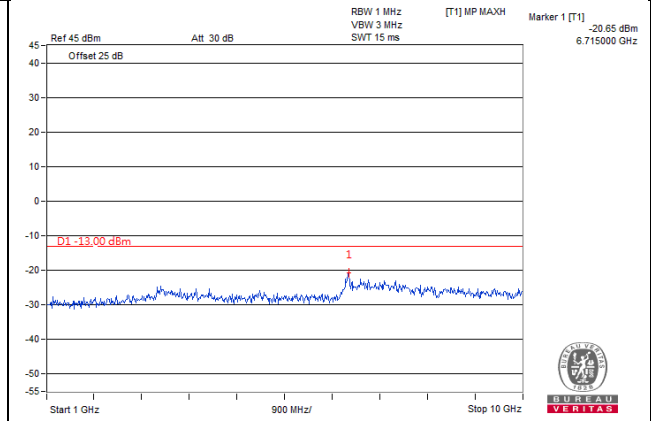

**Frequency Range : 10GHz~26.5GHz**

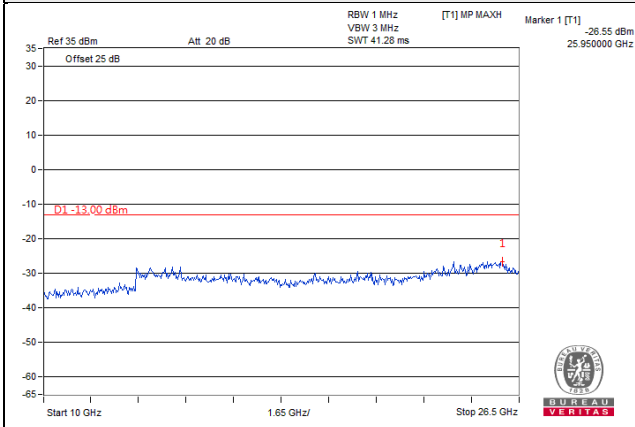



**GPRS**

**Channel 251 (848.8MHz)**

**Frequency Range : 9kHz~1GHz**

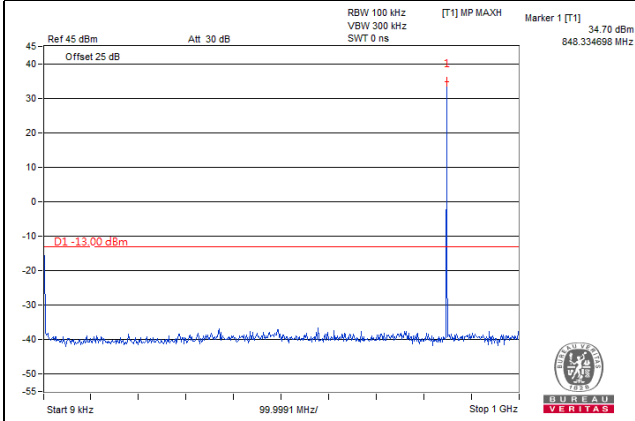

**Frequency Range : 1GHz~10GHz**

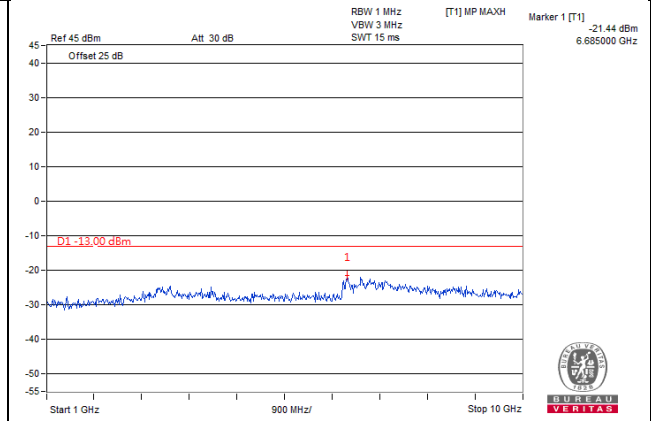

**Frequency Range : 10GHz~26.5GHz**

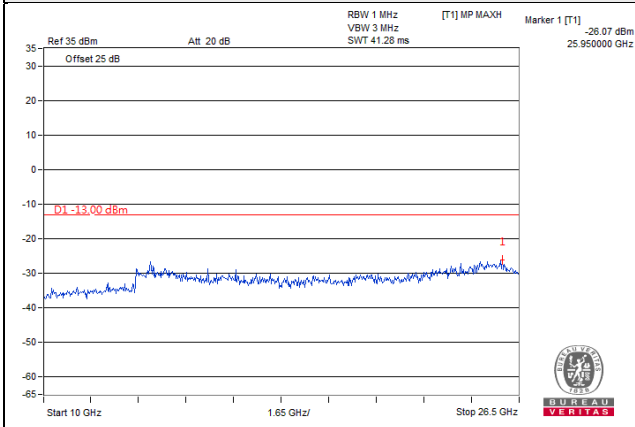

**EDGE**

**Channel 128 (824.2MHz)**

**Frequency Range : 9kHz~1GHz**

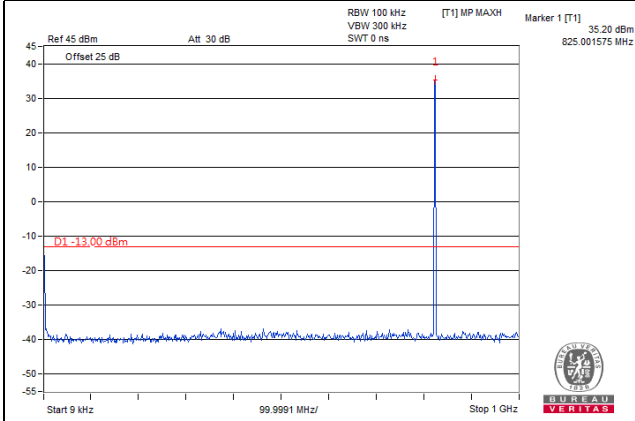

**Frequency Range : 1GHz~10GHz**

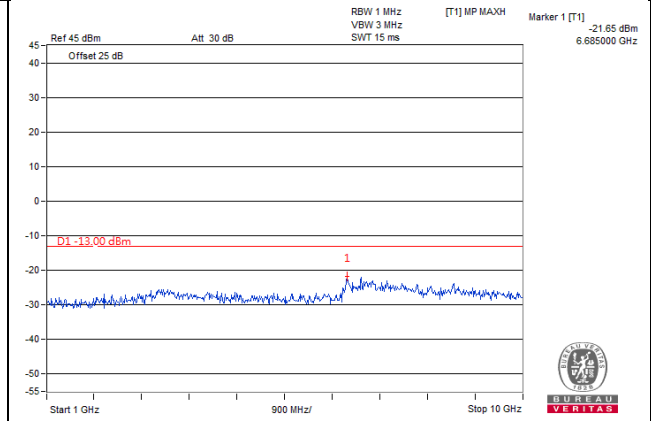

**Frequency Range : 10GHz~26.5GHz**

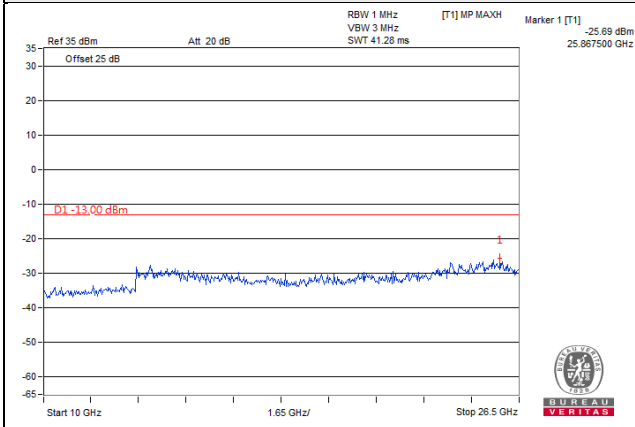

**EDGE**

**Channel 189 (836.4MHz)**

**Frequency Range : 9kHz~1GHz**

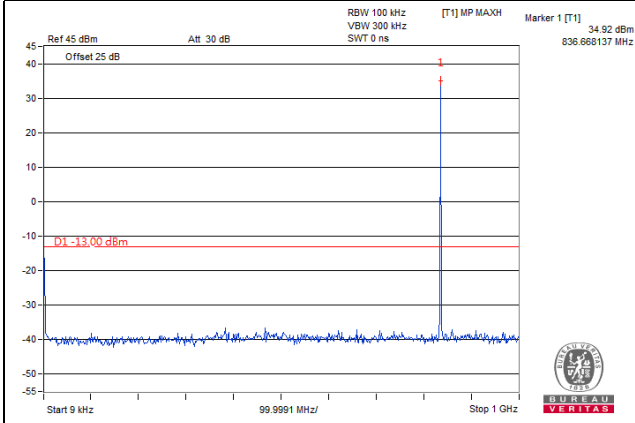

**Frequency Range : 1GHz~10GHz**

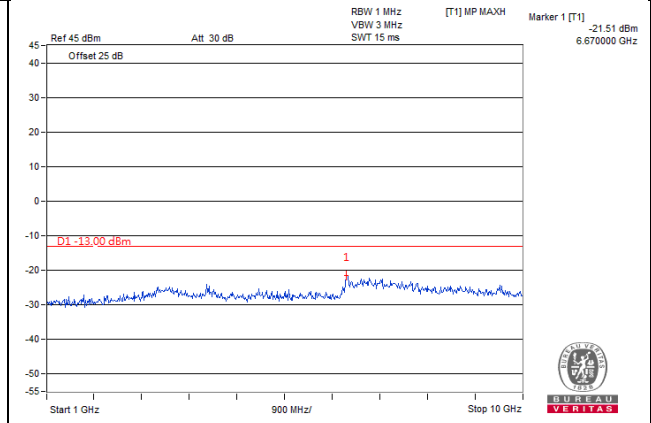

**Frequency Range : 10GHz~26.5GHz**

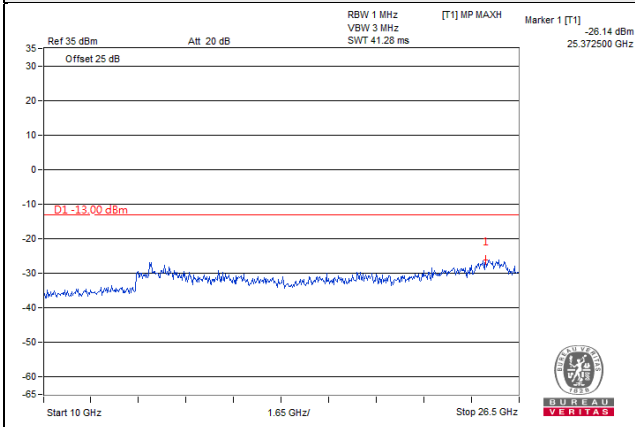

**EDGE**

**Channel 251 (848.8MHz)**

**Frequency Range : 9kHz~1GHz**

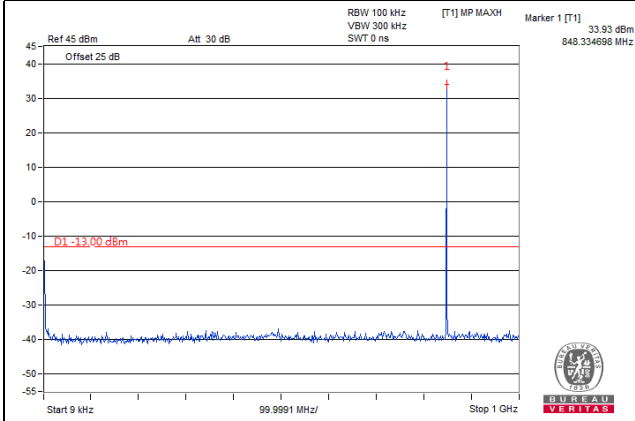

**Frequency Range : 1GHz~10GHz**

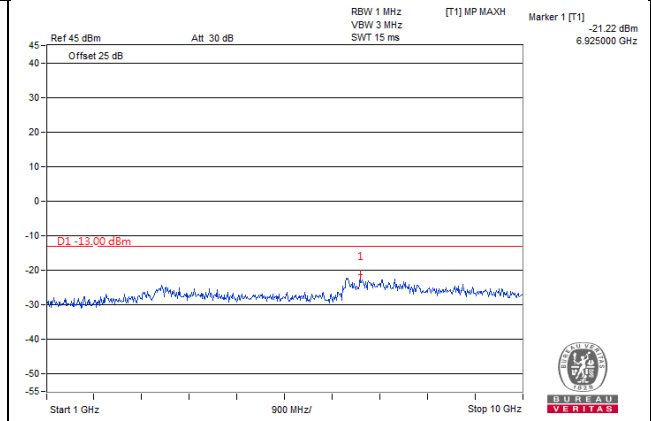

**Frequency Range : 10GHz~26.5GHz**

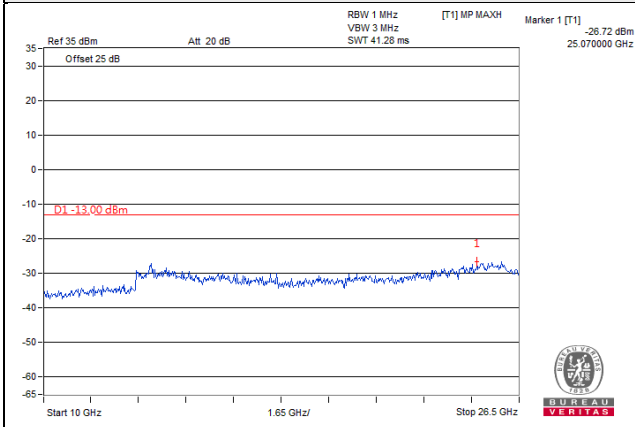

**CDMA**

**Channel 1013 (824.7MHz)**

**Frequency Range : 9kHz~1GHz**

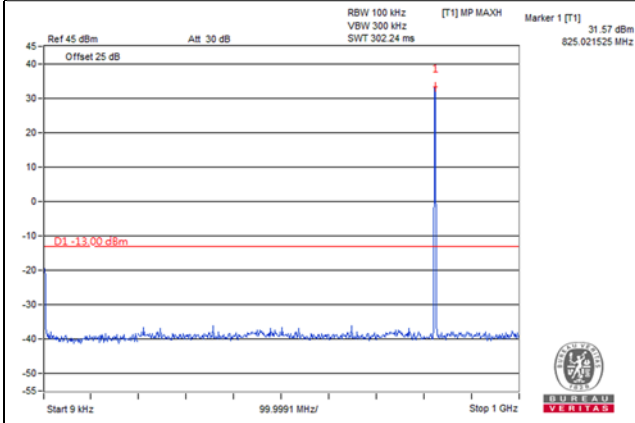

**Frequency Range : 1GHz~10GHz**

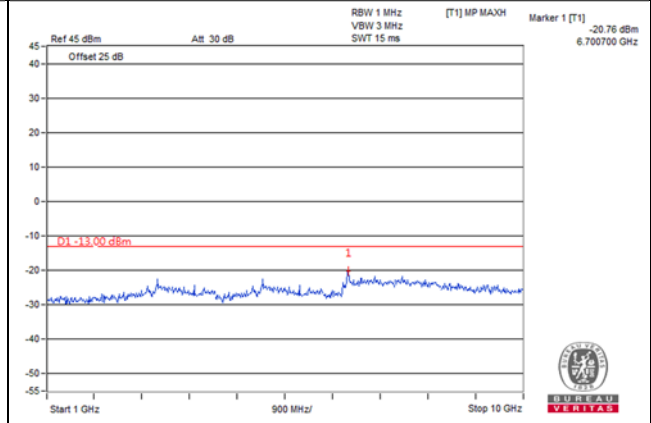

**Frequency Range : 10GHz~26.5GHz**

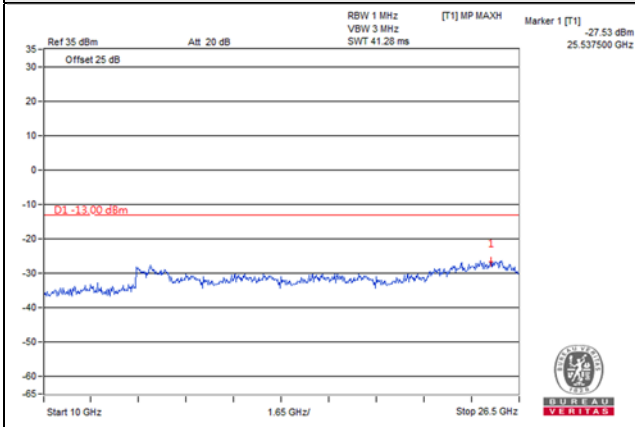

CDMA

Channel 384 (836.52MHz)

Frequency Range : 9kHz~1GHz

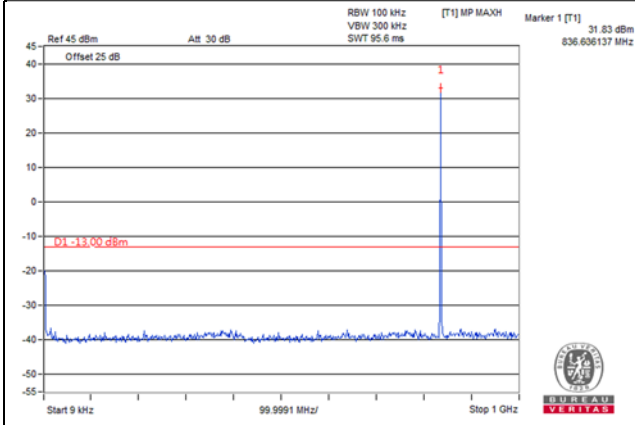

Frequency Range : 1GHz~10GHz

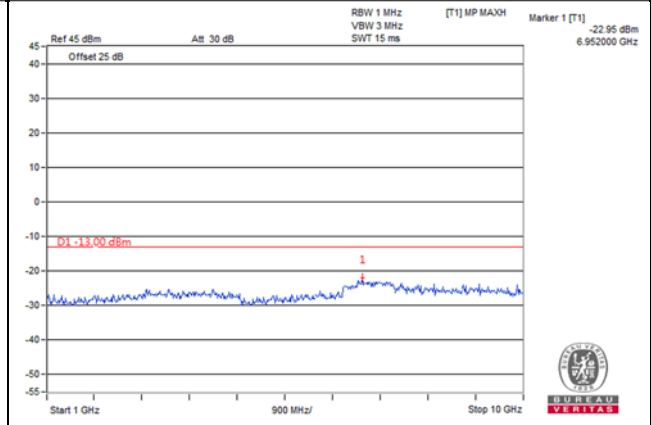

Frequency Range : 10GHz~26.5GHz

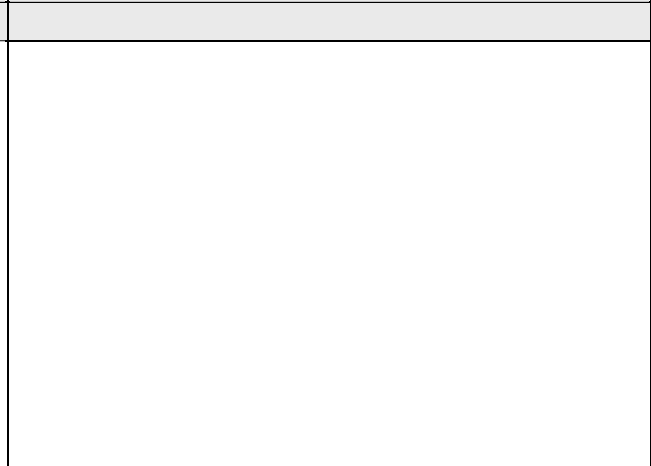
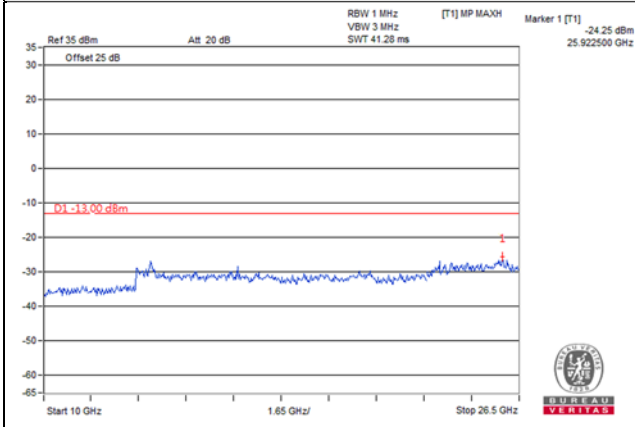

CDMA

Channel 777 (848.31MHz)

Frequency Range : 9kHz~1GHz

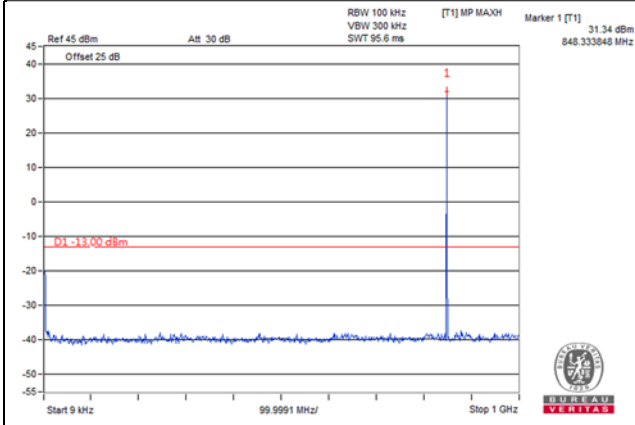

Frequency Range : 1GHz~10GHz

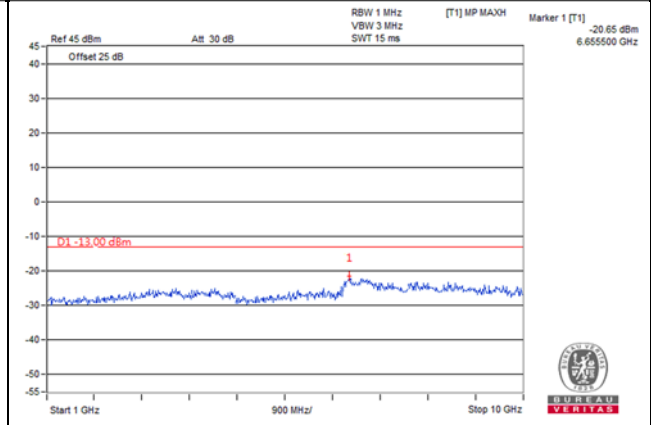

Frequency Range : 10GHz~26.5GHz

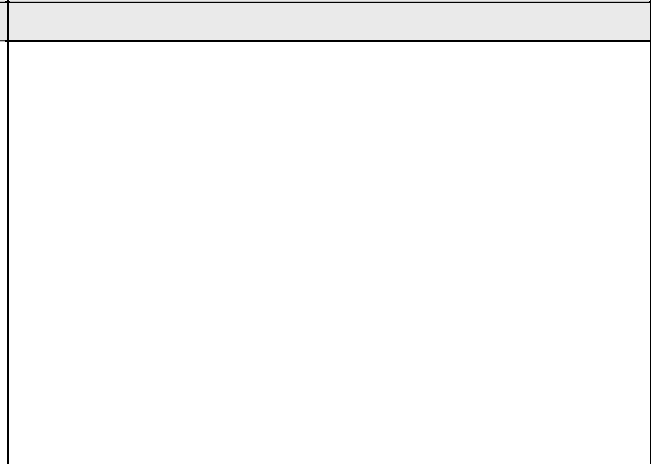
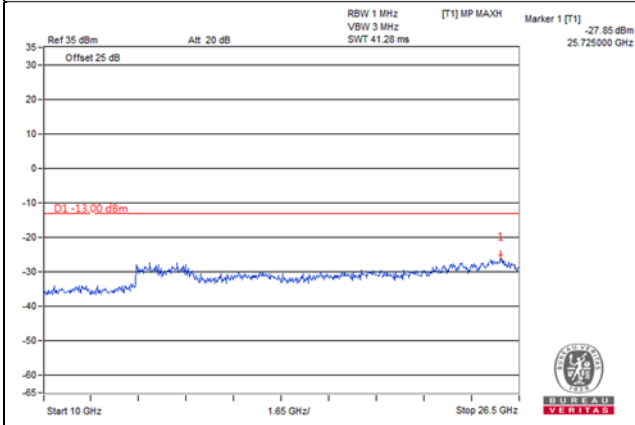

WCDMA

Channel 4132 (826.4MHz)

Frequency Range : 9kHz~1GHz

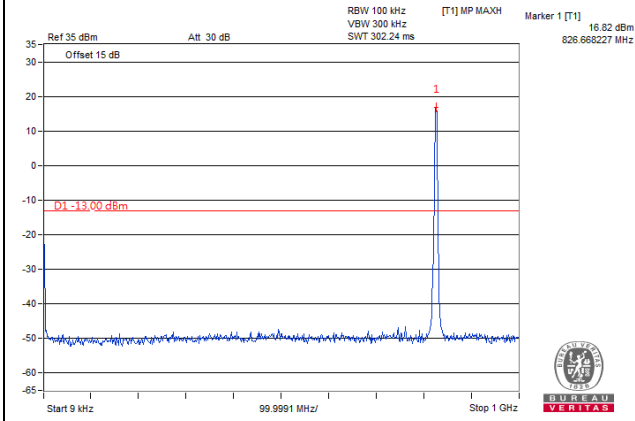

Frequency Range : 1GHz~10GHz

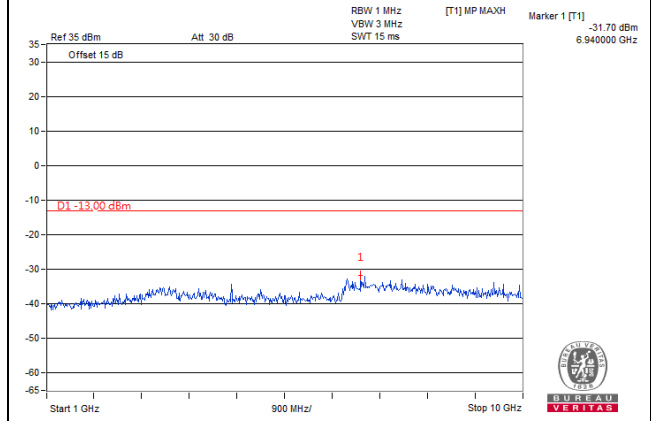

Frequency Range : 10GHz~26.5GHz

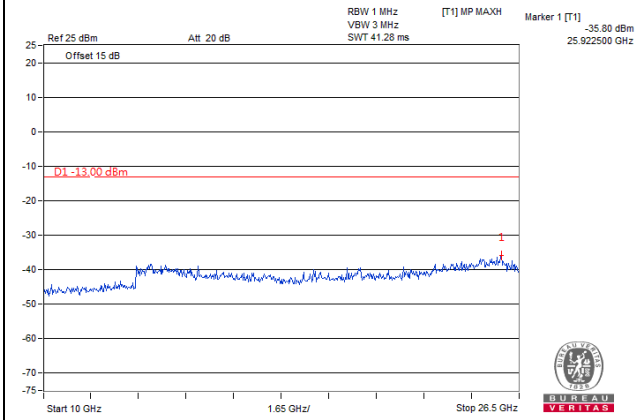



**WCDMA**

**Channel 4182 (836.4MHz)**

**Frequency Range : 9kHz~1GHz**

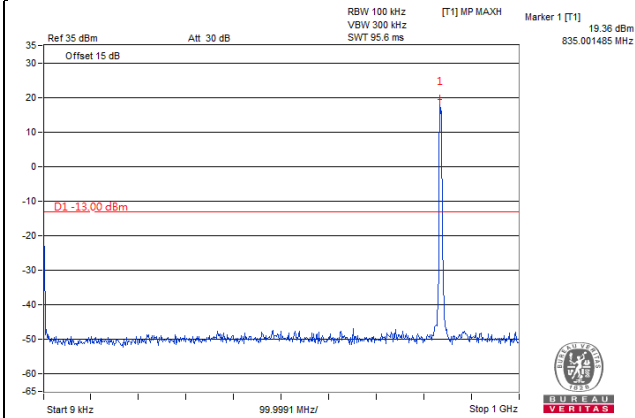

**Frequency Range : 1GHz~10GHz**

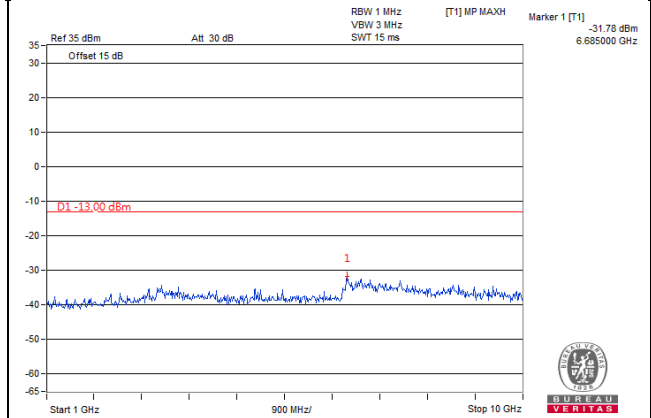

**Frequency Range : 10GHz~26.5GHz**

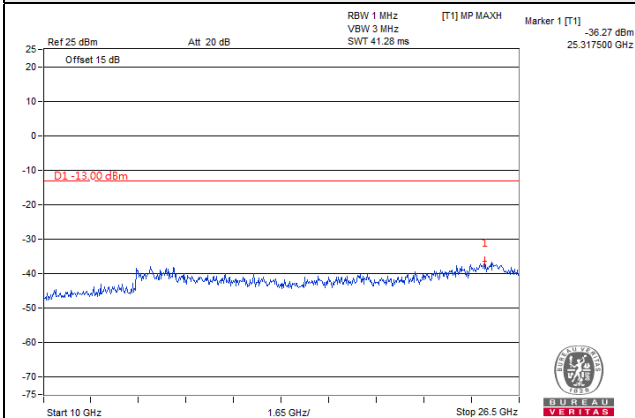

WCDMA

Channel 4233 (846.6MHz)

Frequency Range : 9kHz~1GHz

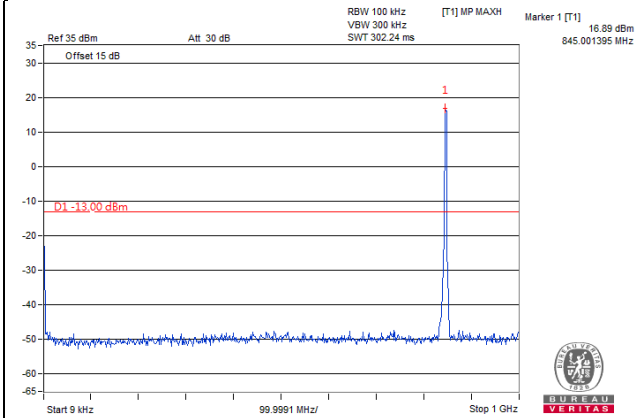

Frequency Range : 1GHz~10GHz

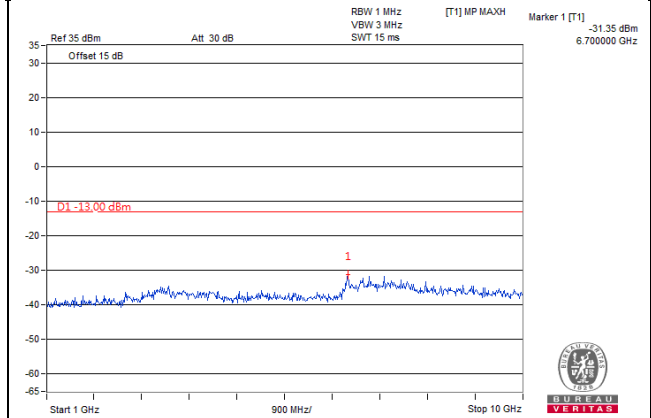

Frequency Range : 10GHz~26.5GHz

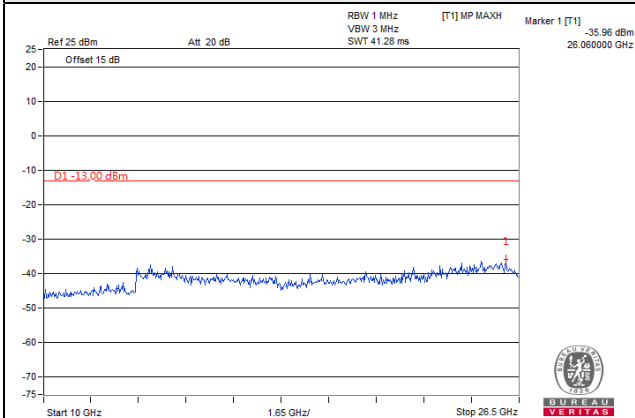

# HSDPA

## Channel 4132 (826.4MHz)

### Frequency Range : 9kHz~1GHz

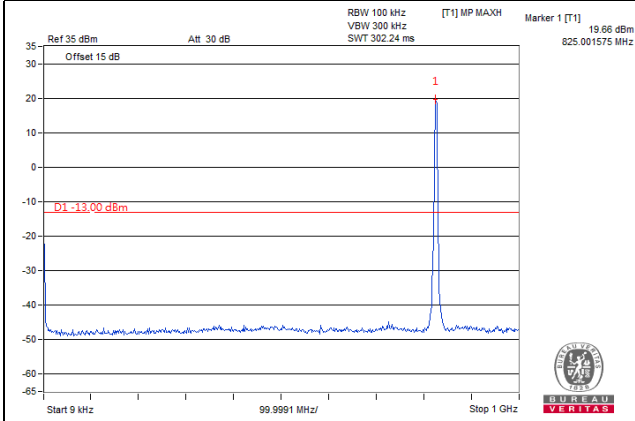

### Frequency Range : 1GHz~10GHz

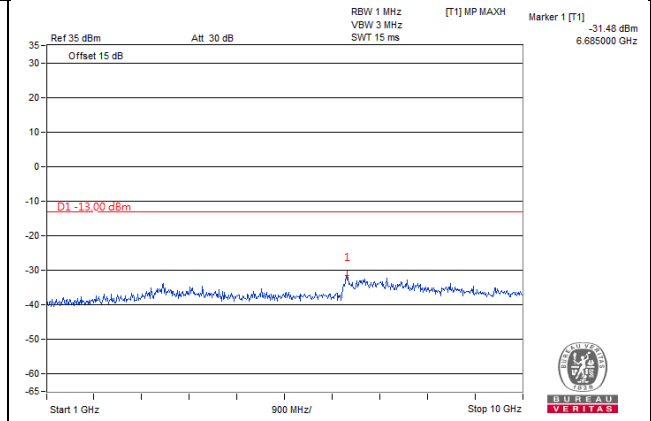

### Frequency Range : 10GHz~26.5GHz

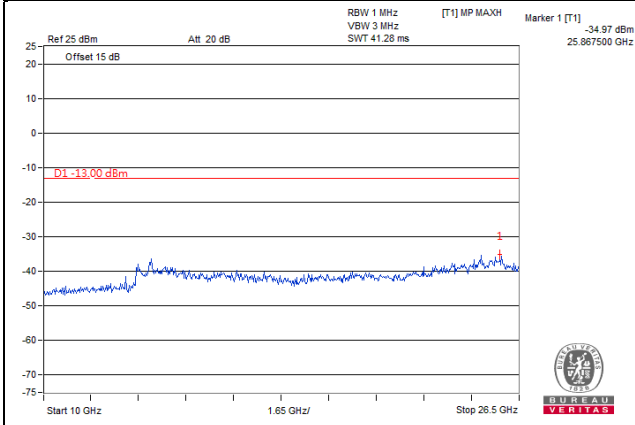

**HSDPA**

**Channel 4182 (836.4MHz)**

**Frequency Range : 9kHz~1GHz**

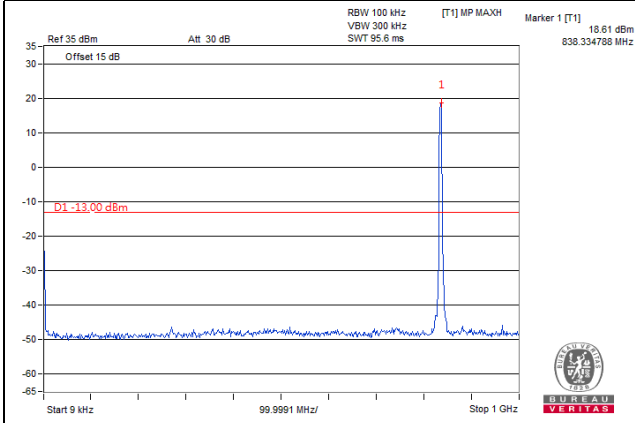

**Frequency Range : 1GHz~10GHz**

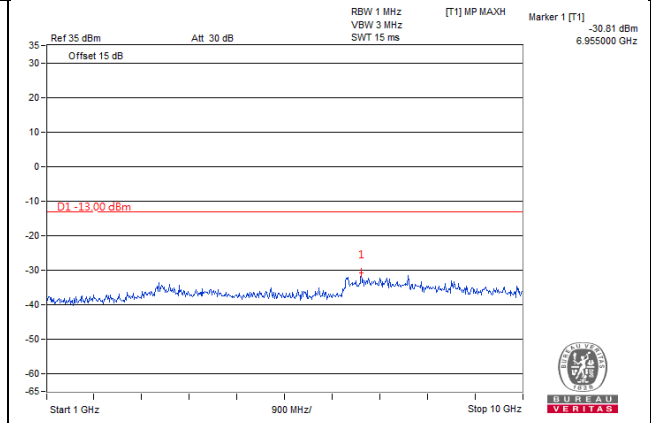

**Frequency Range : 10GHz~26.5GHz**

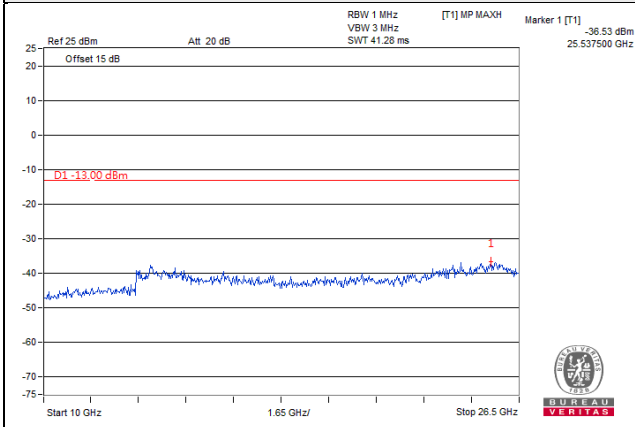

**HSDPA**

**Channel 4233 (846.6MHz)**

**Frequency Range : 9kHz~1GHz**

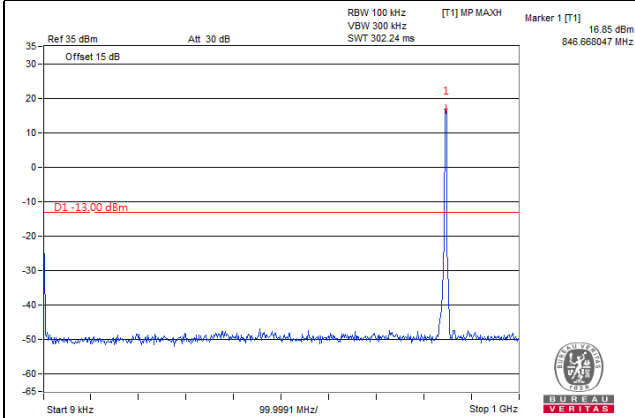

**Frequency Range : 1GHz~10GHz**

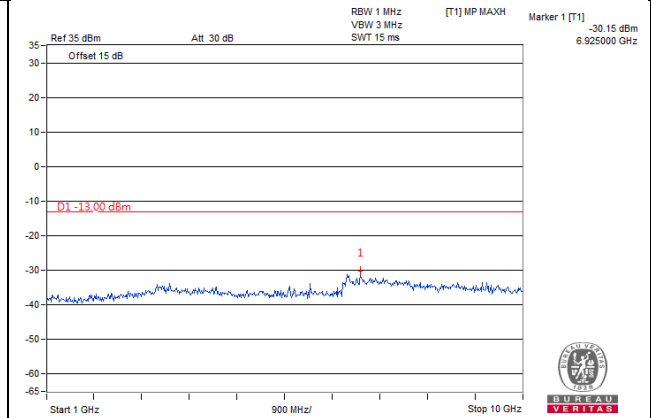

**Frequency Range : 10GHz~26.5GHz**

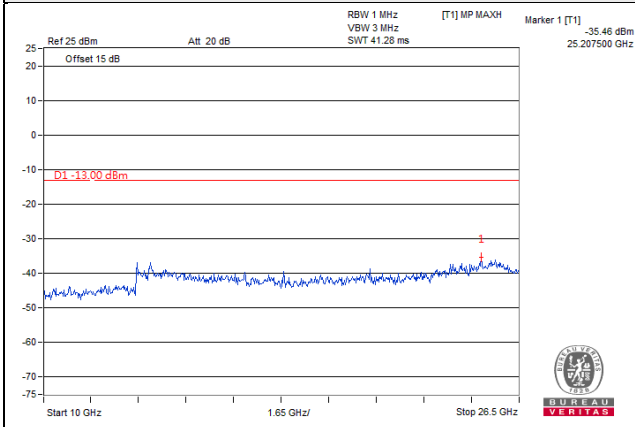

**HSUPA**

**Channel 4132 (826.4MHz)**

**Frequency Range : 9kHz~1GHz**

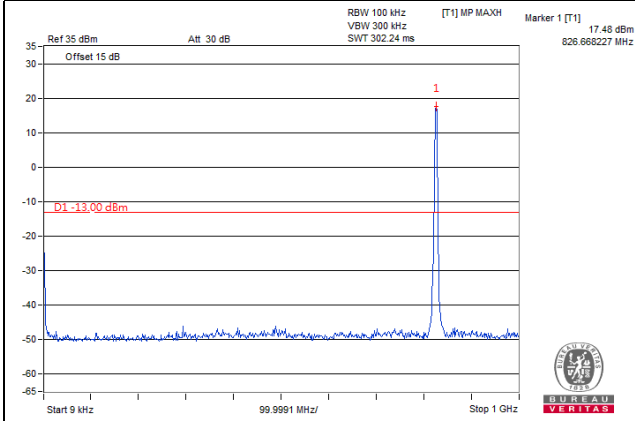

**Frequency Range : 1GHz~10GHz**

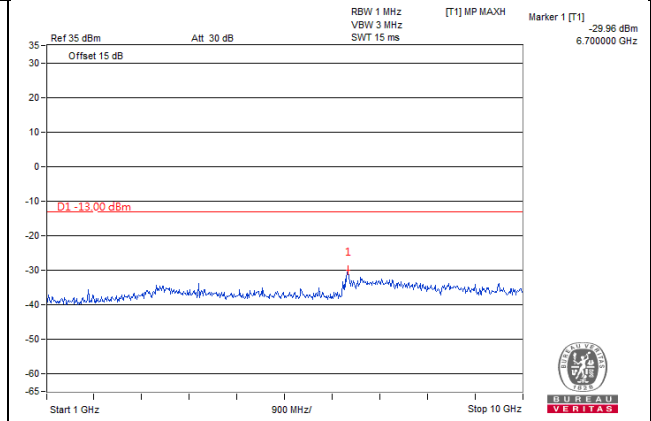

**Frequency Range : 10GHz~26.5GHz**

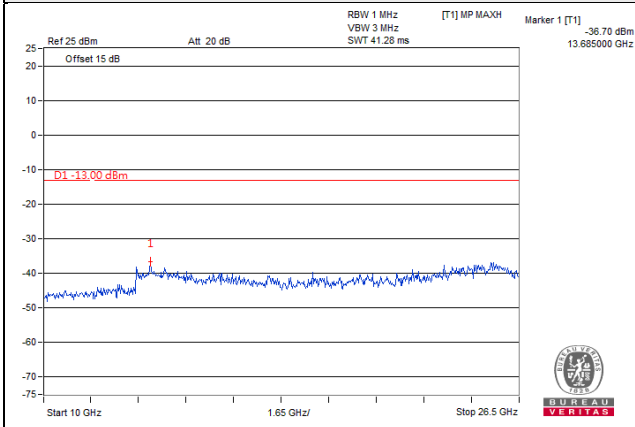

**HSUPA**

**Channel 4182 (836.4MHz)**

**Frequency Range : 9kHz~1GHz**

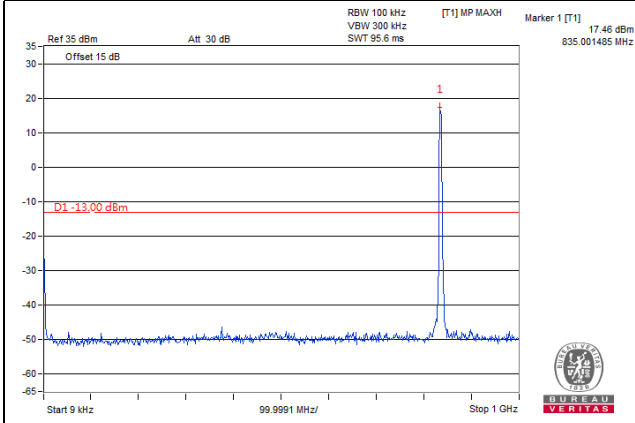

**Frequency Range : 1GHz~10GHz**

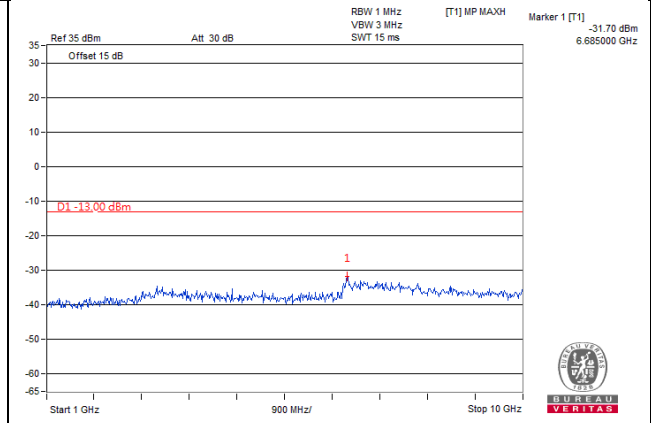

**Frequency Range : 10GHz~26.5GHz**

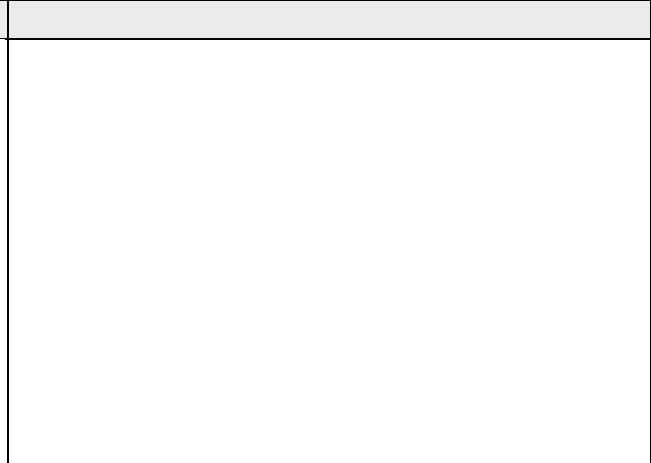
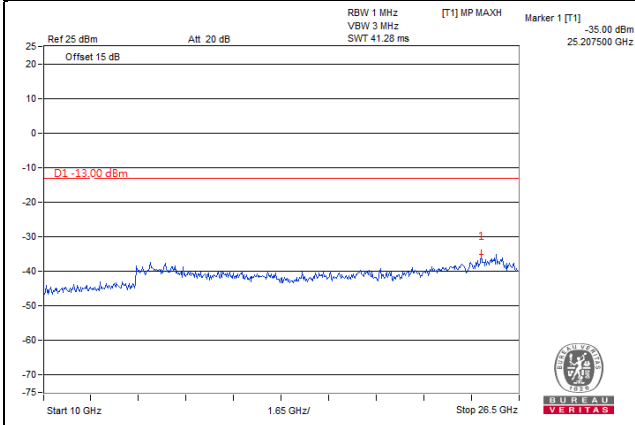

**HSUPA**

**Channel 4233 (846.6MHz)**

**Frequency Range : 9kHz~1GHz**

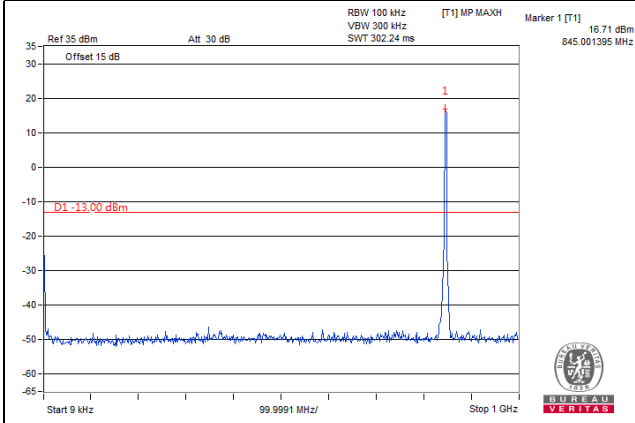

**Frequency Range : 1GHz~10GHz**

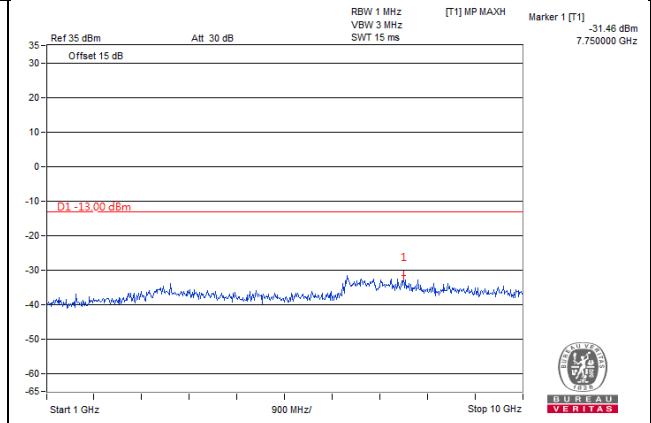

**Frequency Range : 10GHz~26.5GHz**

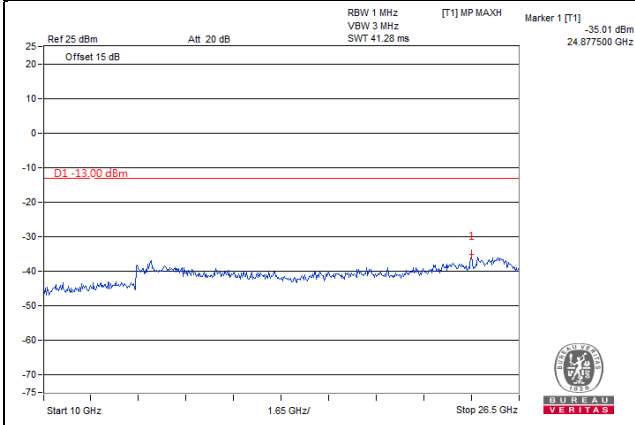



LTE Band 5, Channel Bandwidth 1.4MHz

Channel 20407 (824.7MHz)

Frequency Range : 9kHz~1GHz

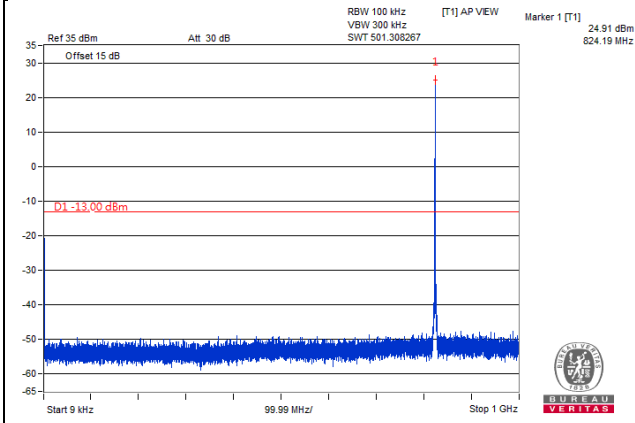

Frequency Range : 1GHz~10GHz

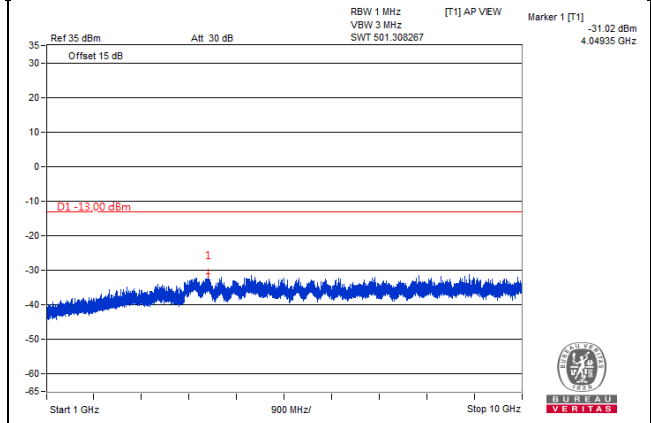

Frequency Range : 10GHz~27GHz

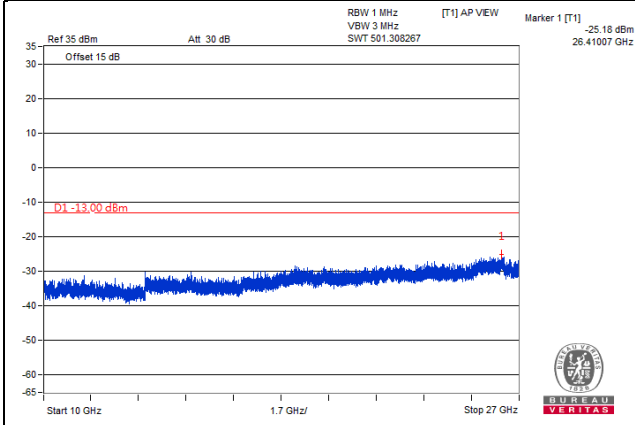

LTE Band 5, Channel Bandwidth 1.4MHz

Channel 20525 (836.5MHz)

Frequency Range : 9kHz~1GHz

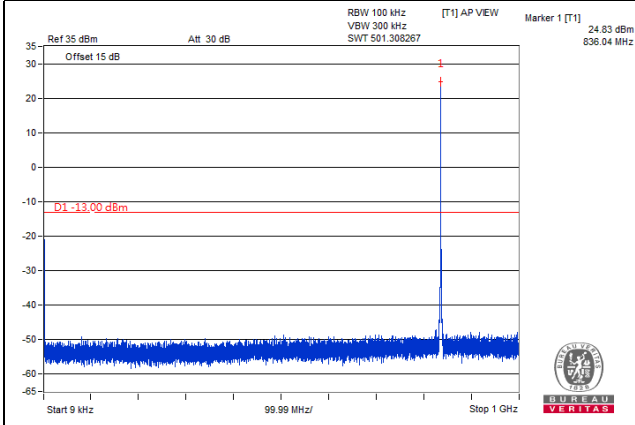

Frequency Range : 1GHz~10GHz

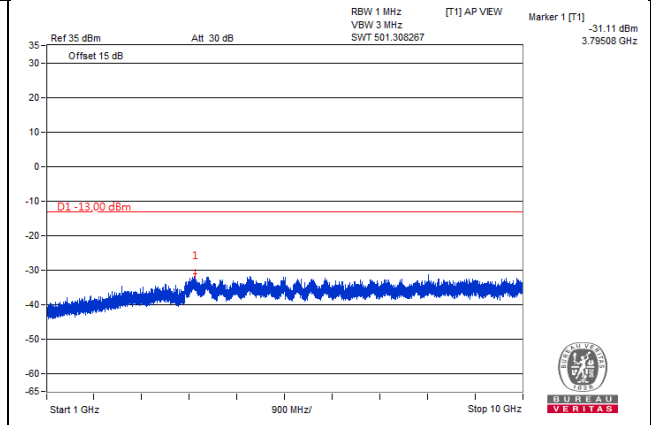

Frequency Range : 10GHz~27GHz

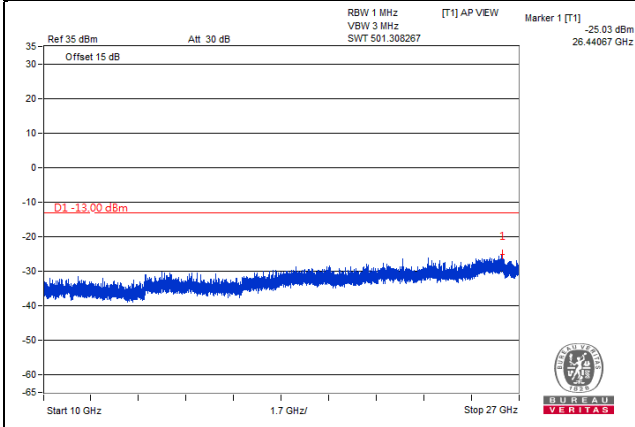

LTE Band 5, Channel Bandwidth 1.4MHz

Channel 20643 (848.3MHz)

Frequency Range : 9kHz~1GHz

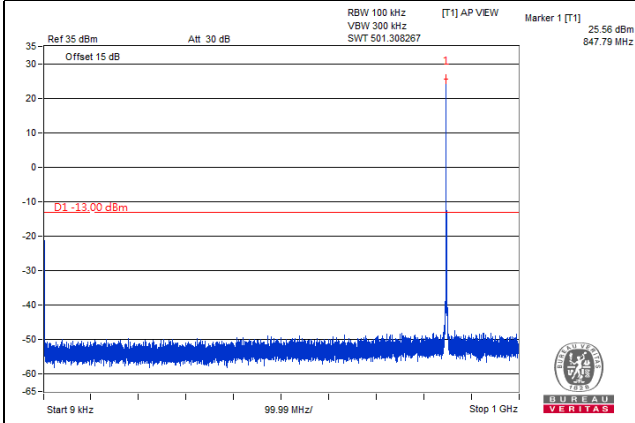

Frequency Range : 1GHz~10GHz

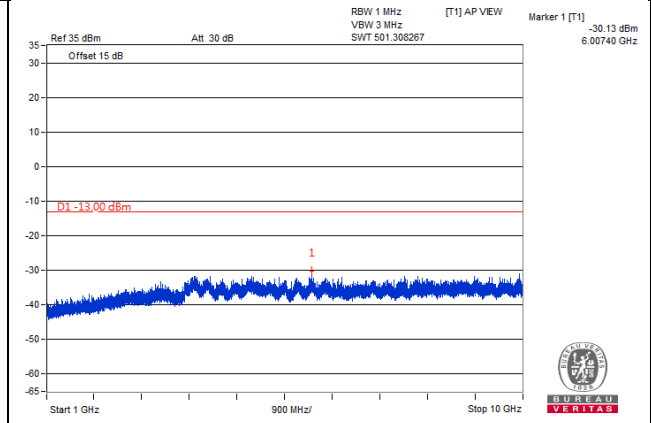

Frequency Range : 10GHz~27GHz

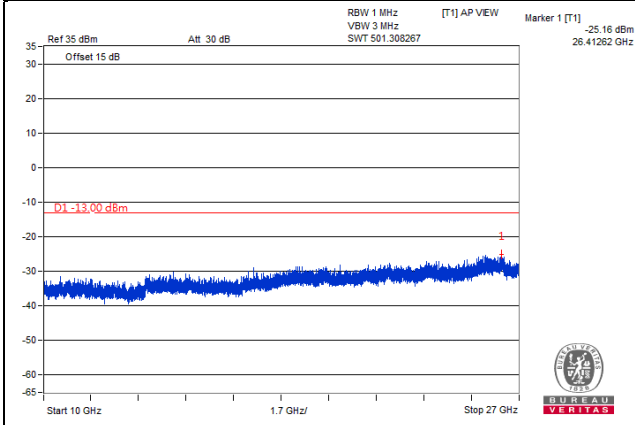

LTE Band 5, Channel Bandwidth 3MHz

Channel 20415 (825.5MHz)

Frequency Range : 9kHz~1GHz

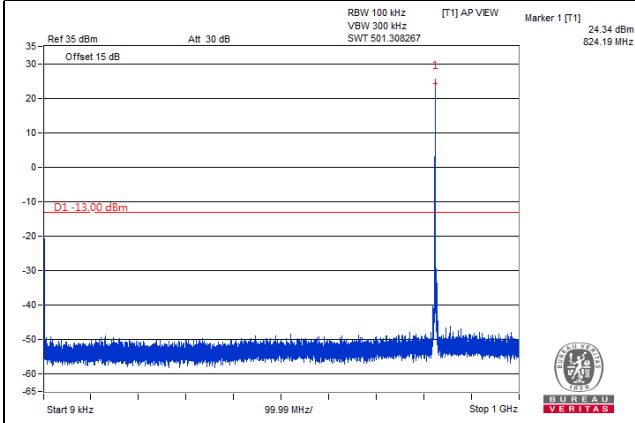

Frequency Range : 1GHz~10GHz

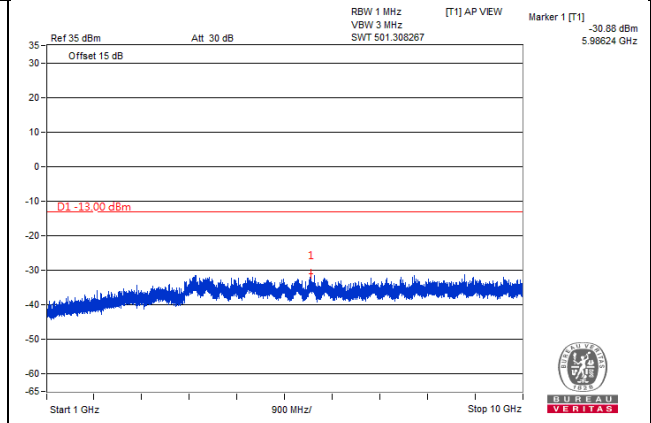

Frequency Range : 10GHz~27GHz

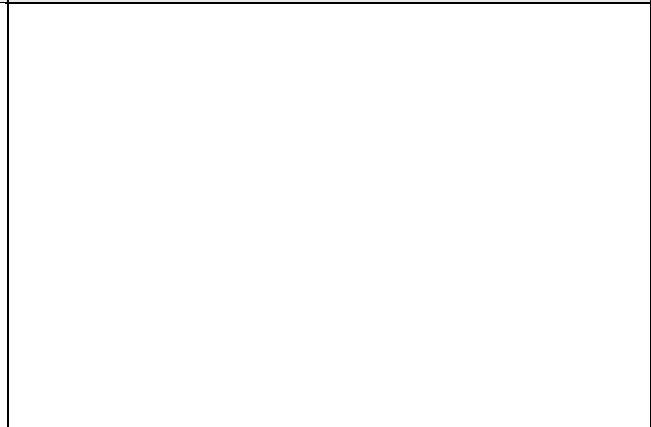
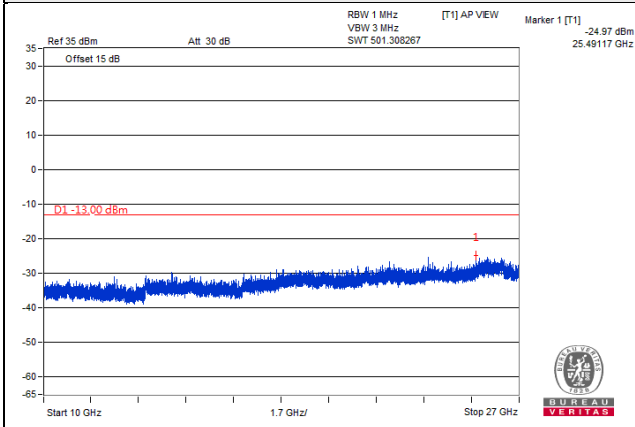

LTE Band 5, Channel Bandwidth 3MHz

Channel 20525 (836.5MHz)

Frequency Range : 9kHz~1GHz

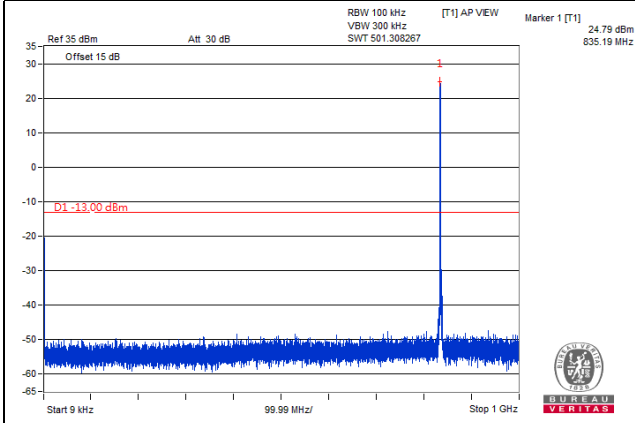

Frequency Range : 1GHz~10GHz

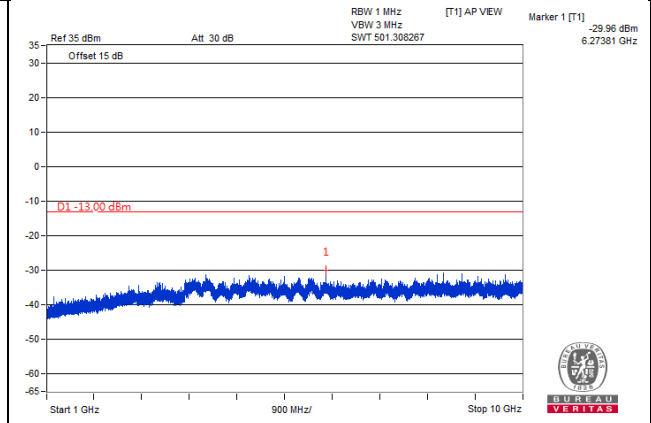

Frequency Range : 10GHz~27GHz

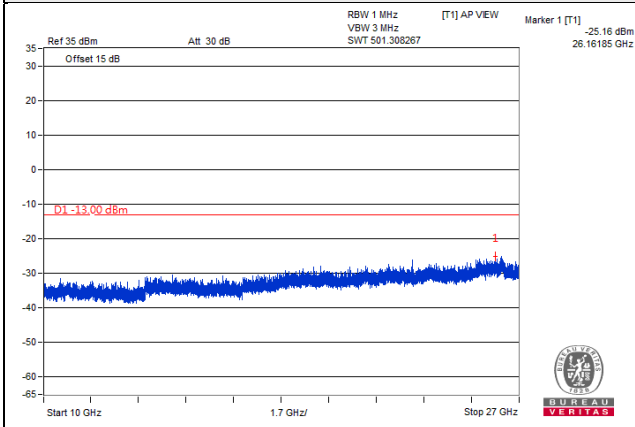

LTE Band 5, Channel Bandwidth 3MHz

Channel 20635 (847.5MHz)

Frequency Range : 9kHz~1GHz

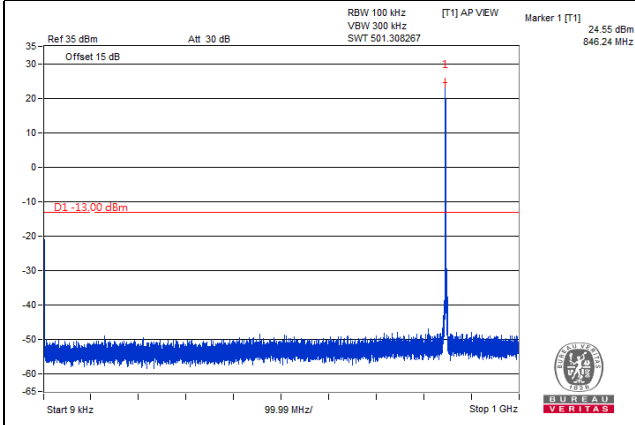

Frequency Range : 1GHz~10GHz

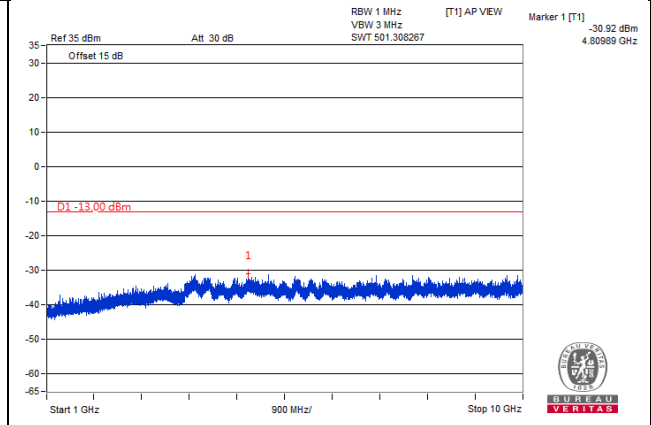

Frequency Range : 10GHz~27GHz

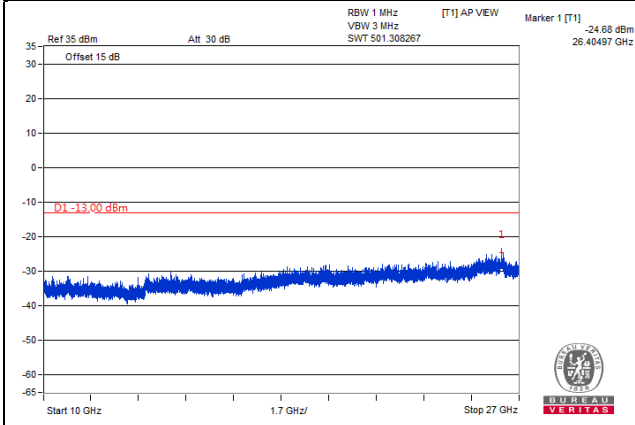

LTE Band 5, Channel Bandwidth 5MHz

Channel 20425 (826.5MHz)

Frequency Range : 9kHz~1GHz

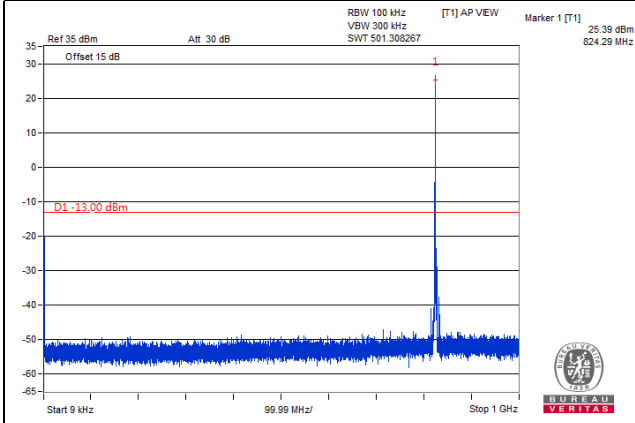

Frequency Range : 1GHz~10GHz

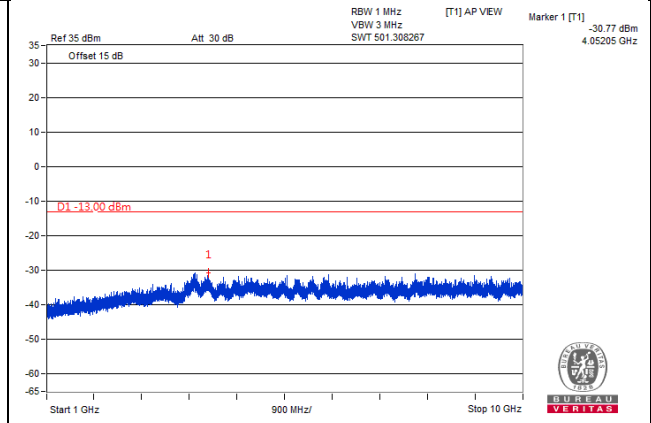

Frequency Range : 10GHz~27GHz

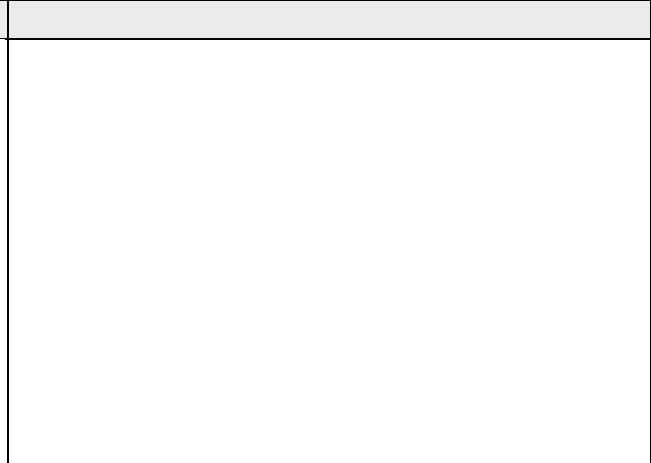
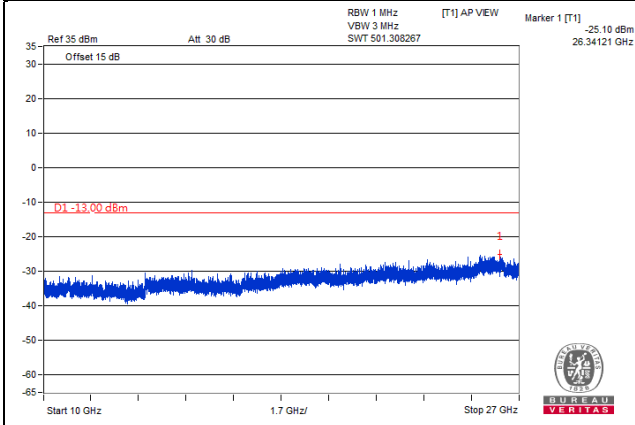

LTE Band 5, Channel Bandwidth 5MHz

Channel 20525 (836.5MHz)

Frequency Range : 9kHz~1GHz

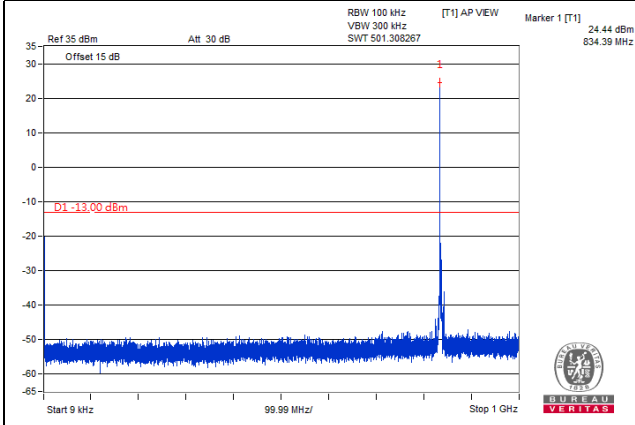

Frequency Range : 1GHz~10GHz

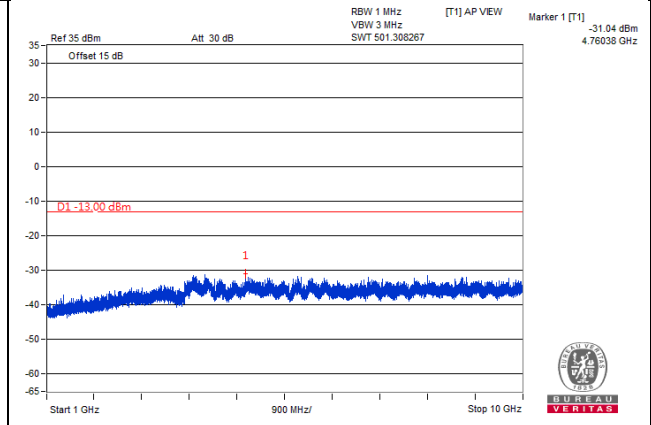

Frequency Range : 10GHz~27GHz

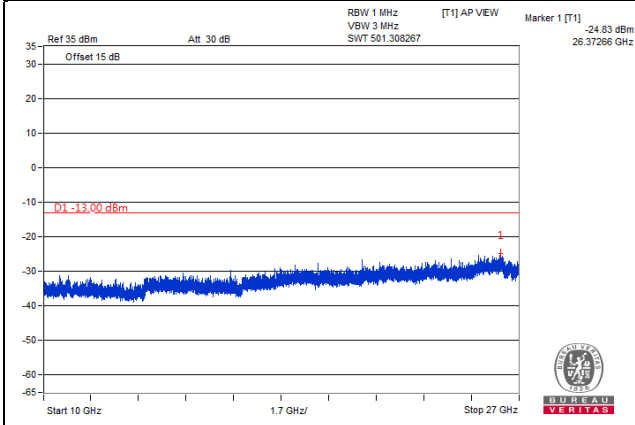



LTE Band 5, Channel Bandwidth 5MHz

Channel 20625 (846.5MHz)

Frequency Range : 9kHz~1GHz

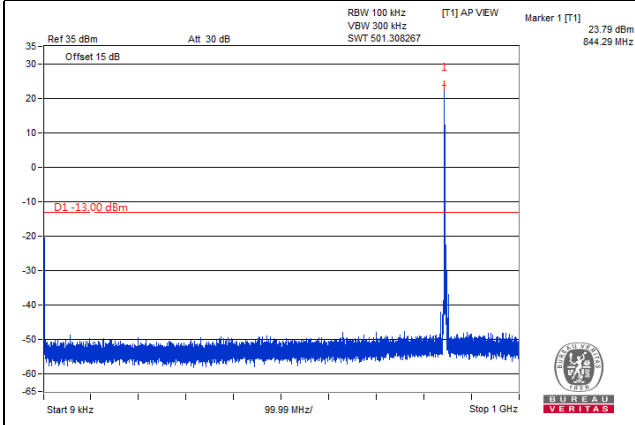

Frequency Range : 1GHz~10GHz

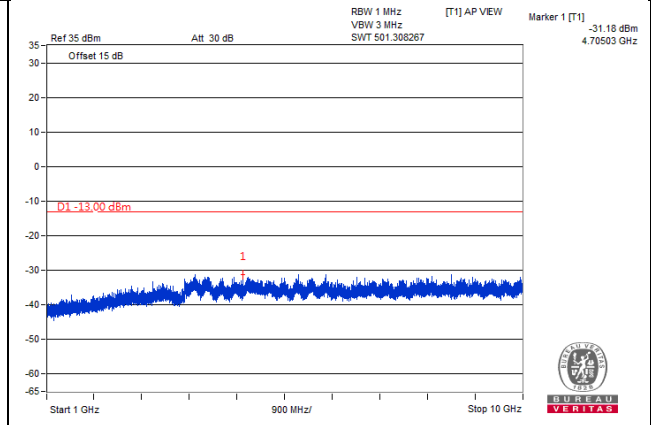

Frequency Range : 10GHz~27GHz

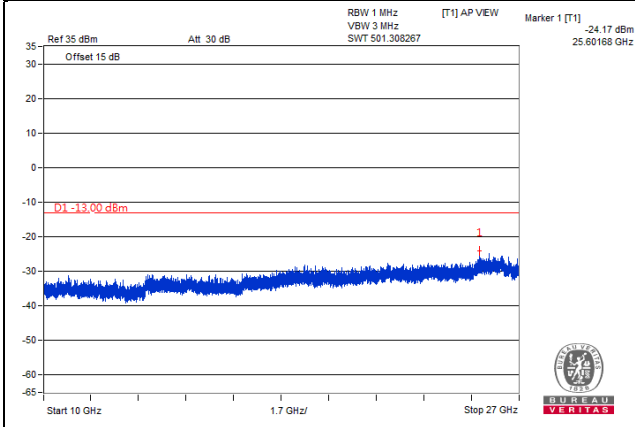

LTE Band 5, Channel Bandwidth 10MHz

Channel 20450 (829.0MHz)

Frequency Range : 9kHz~1GHz

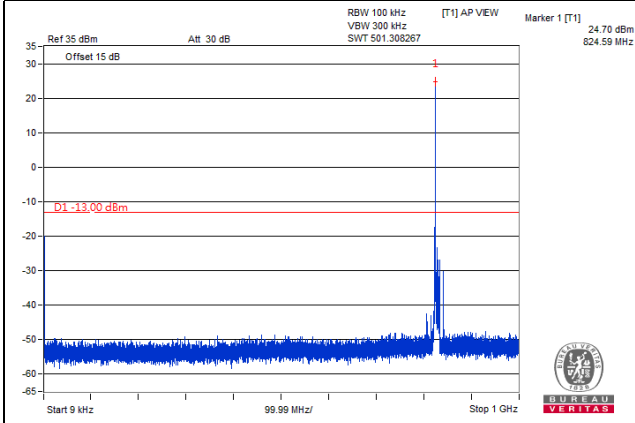

Frequency Range : 1GHz~10GHz

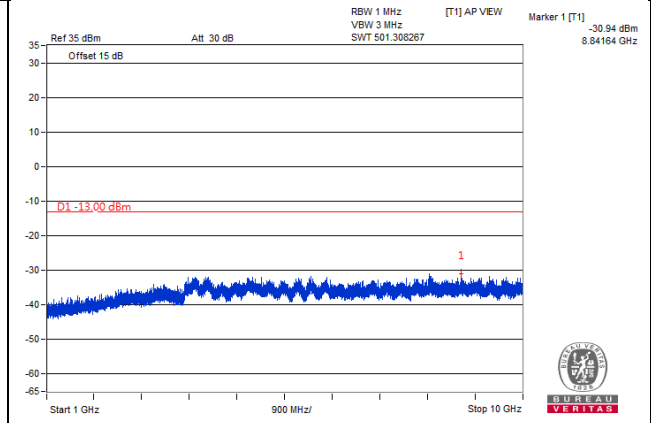

Frequency Range : 10GHz~27GHz

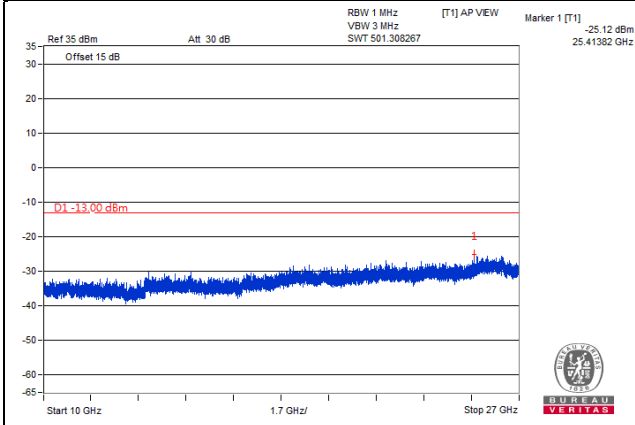

LTE Band 5, Channel Bandwidth 10MHz

Channel 20525 (836.5MHz)

Frequency Range : 9kHz~1GHz

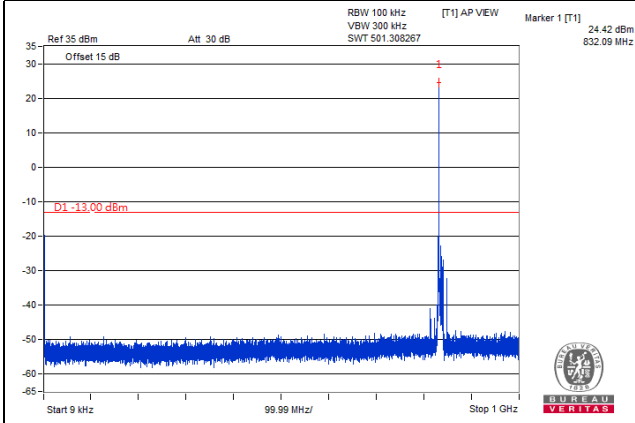

Frequency Range : 1GHz~10GHz

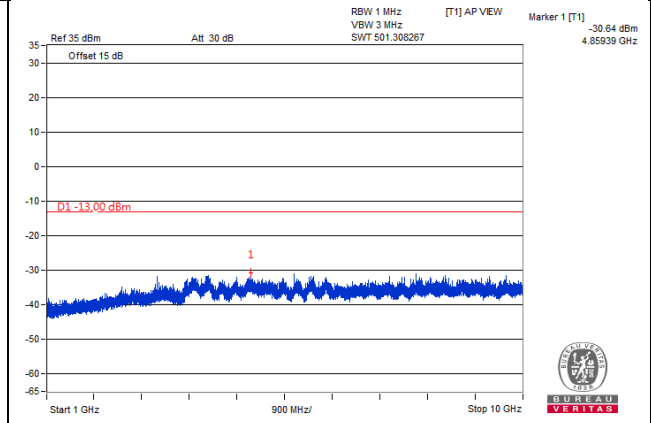

Frequency Range : 10GHz~27GHz

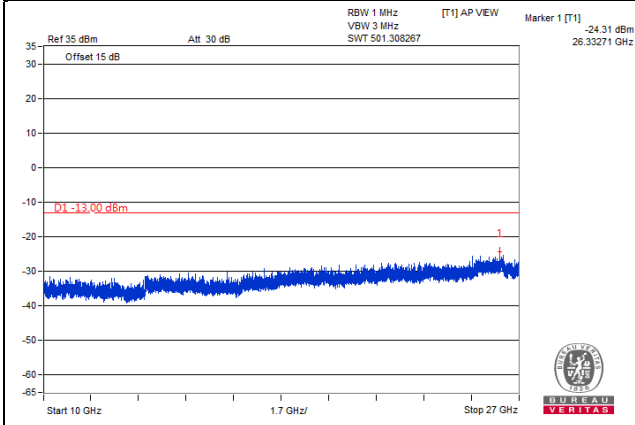

LTE Band 5, Channel Bandwidth 10MHz

Channel 20600 (844.0MHz)

Frequency Range : 9kHz~1GHz

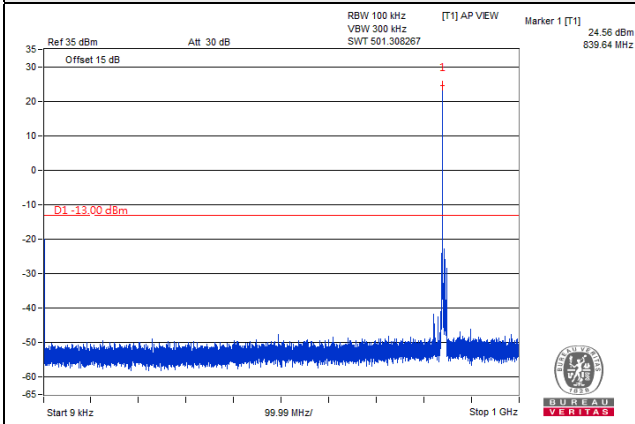

Frequency Range : 1GHz~10GHz

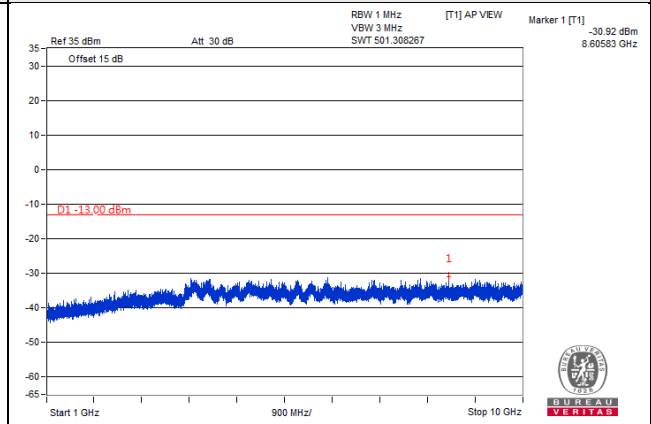

Frequency Range : 10GHz~27GHz

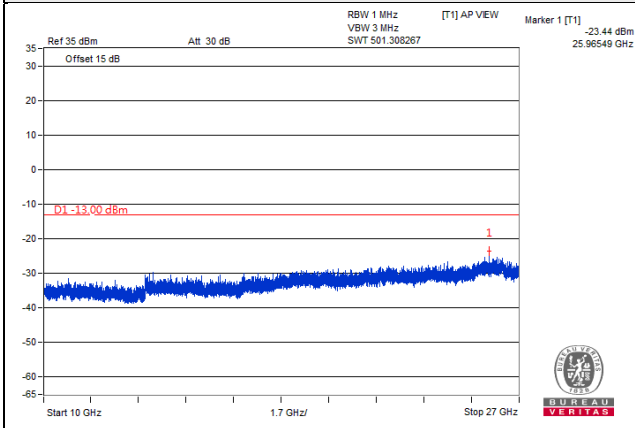

LTE Band 26, Channel Bandwidth 1.4MHz

Channel 26797 (824.7MHz)

Frequency Range : 9kHz~1GHz

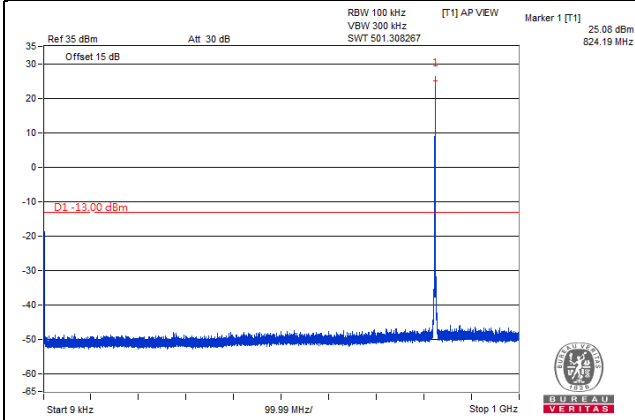

Frequency Range : 1GHz~10GHz

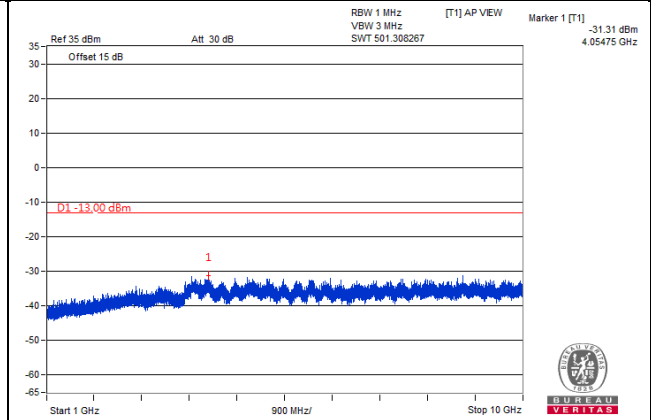

Frequency Range : 10GHz~27GHz

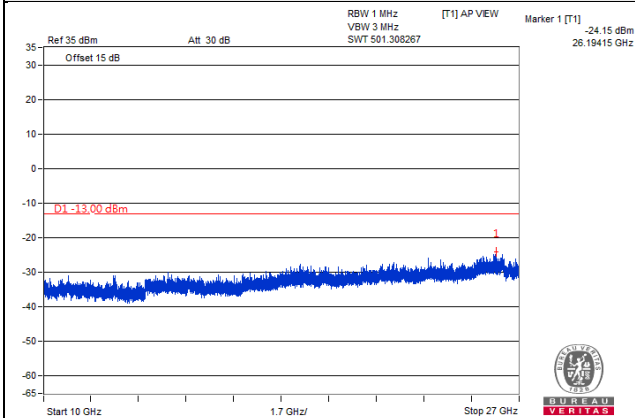

\*The 9kHz signal over the limit is from Spectrum.

LTE Band 26, Channel Bandwidth 1.4MHz

Channel 26915 (836.5MHz)

Frequency Range : 9kHz~1GHz

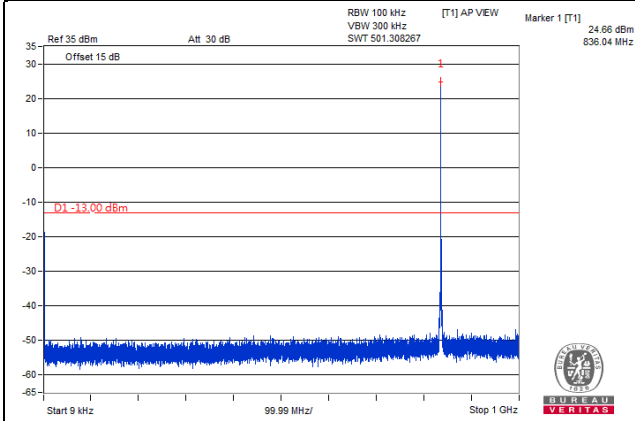

Frequency Range : 1GHz~10GHz

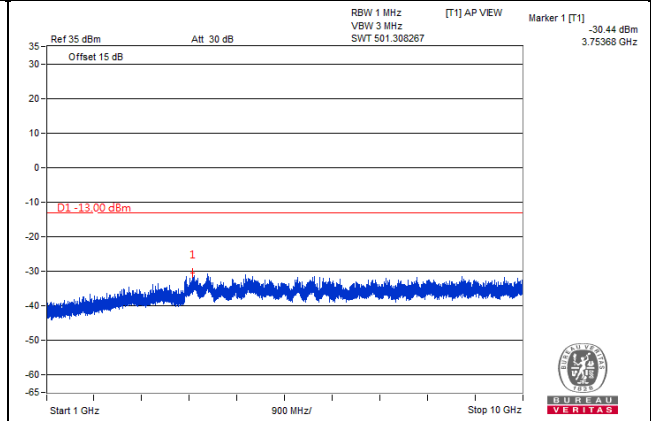

Frequency Range : 10GHz~27GHz

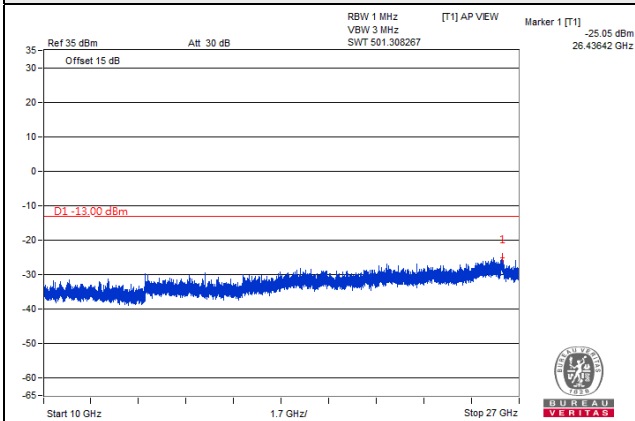

\*The 9kHz signal over the limit is from Spectrum.

LTE Band 26, Channel Bandwidth 1.4MHz

Channel 27033 (848.3MHz)

Frequency Range : 9kHz~1GHz

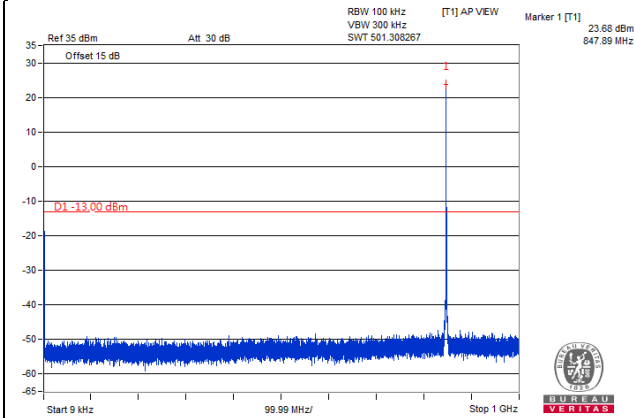

Frequency Range : 1GHz~10GHz

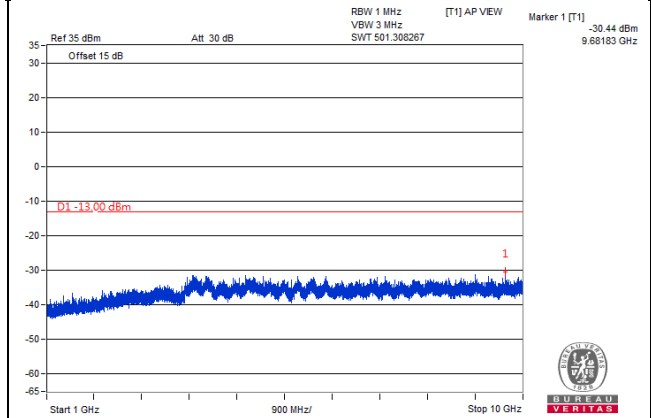

Frequency Range : 10GHz~27GHz

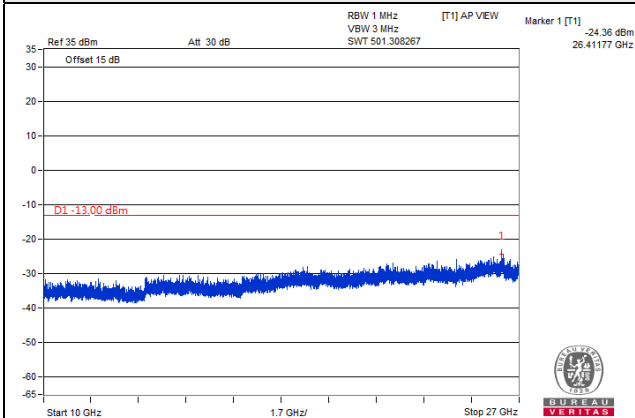

\*The 9kHz signal over the limit is from Spectrum.

LTE Band 26, Channel Bandwidth 3MHz

Channel 26805 (825.5MHz)

Frequency Range : 9kHz~1GHz

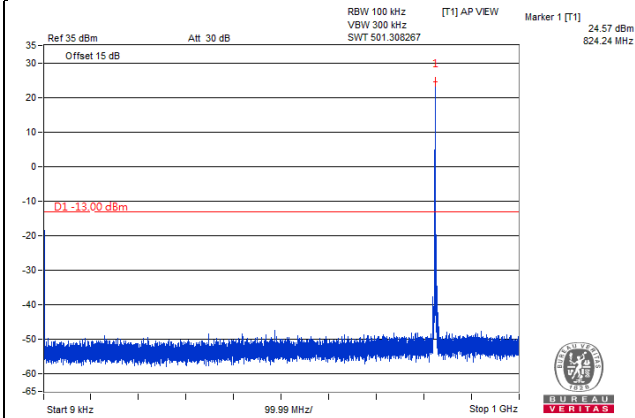

Frequency Range : 1GHz~10GHz

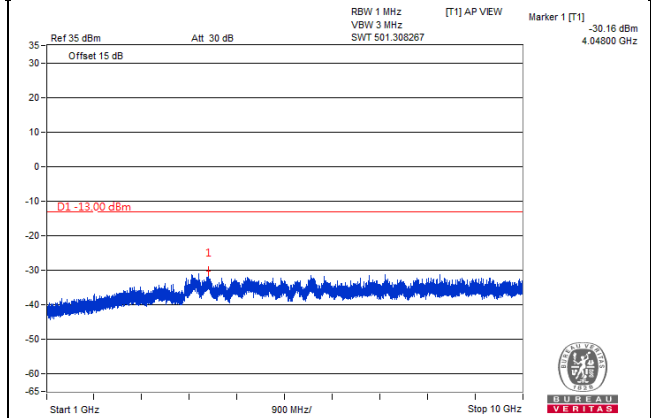

Frequency Range : 10GHz~27GHz

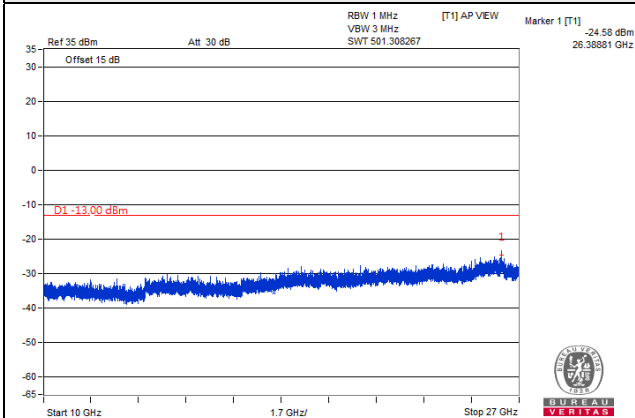

\*The 9kHz signal over the limit is from Spectrum.



LTE Band 26, Channel Bandwidth 3MHz

Channel 26915 (836.5MHz)

Frequency Range : 9kHz~1GHz

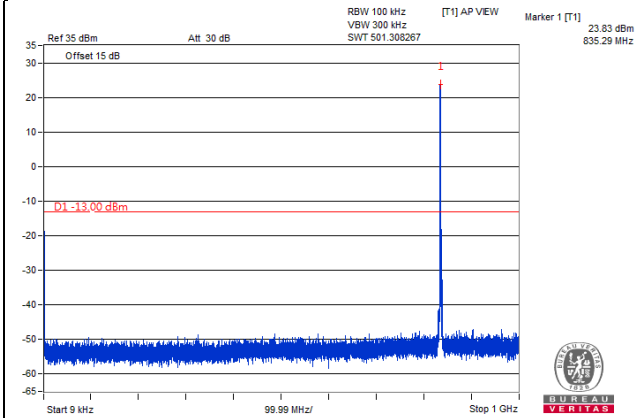

Frequency Range : 1GHz~10GHz

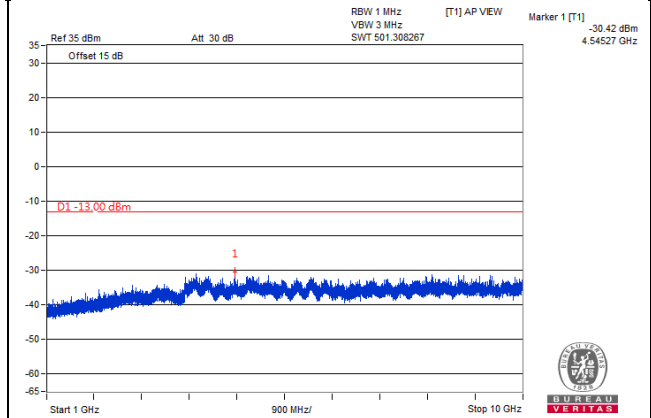

Frequency Range : 10GHz~27GHz

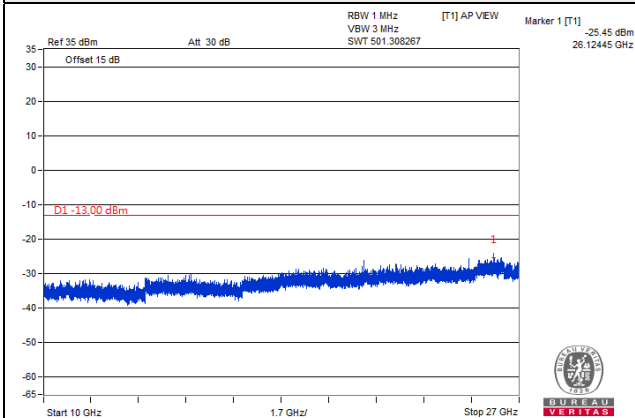

\*The 9kHz signal over the limit is from Spectrum.

LTE Band 26, Channel Bandwidth 3MHz

Channel 27025 (847.5MHz)

Frequency Range : 9kHz~1GHz

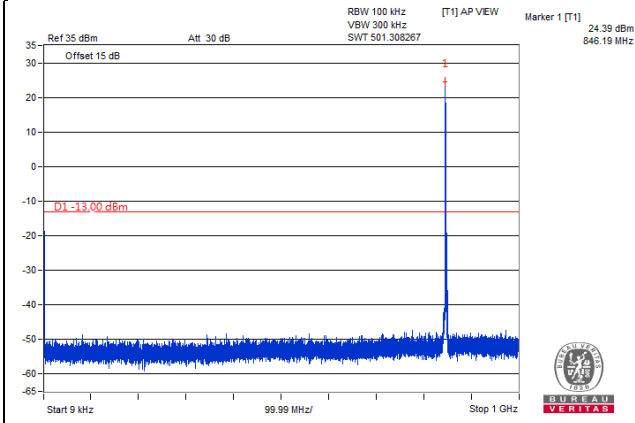

Frequency Range : 1GHz~10GHz

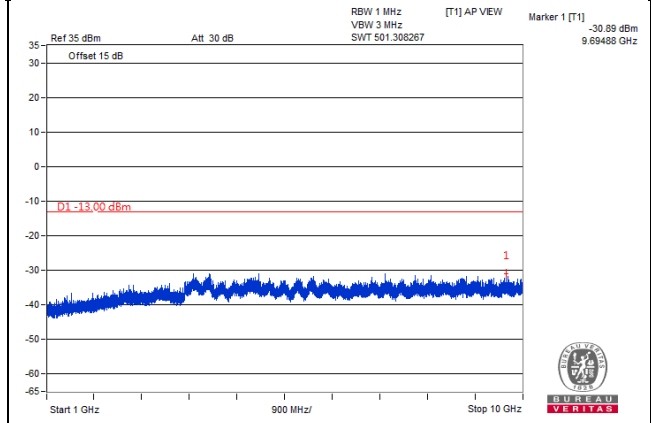

Frequency Range : 10GHz~27GHz

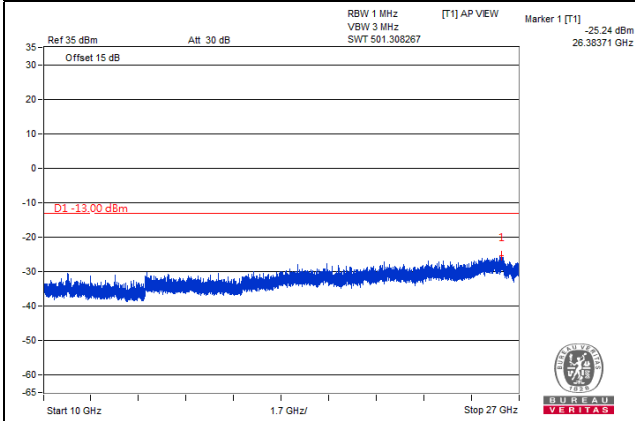

\*The 9kHz signal over the limit is from Spectrum.

LTE Band 26, Channel Bandwidth 5MHz

Channel 26815 (826.5MHz)

Frequency Range : 9kHz~1GHz

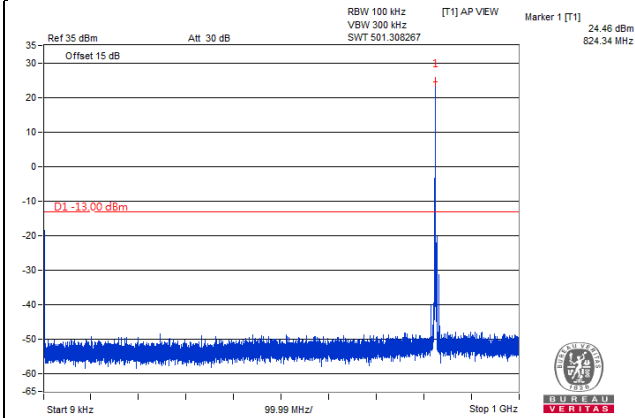

Frequency Range : 1GHz~10GHz

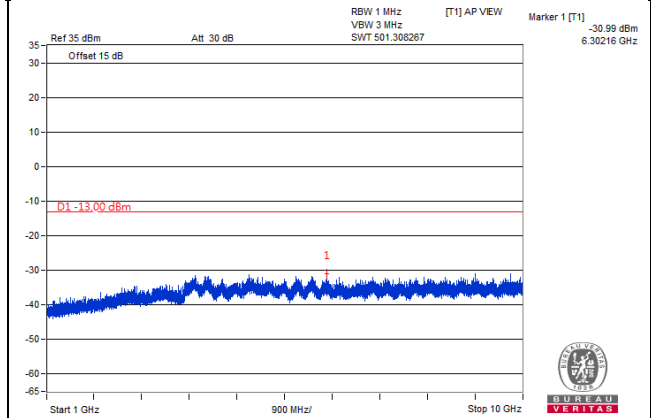

Frequency Range : 10GHz~27GHz

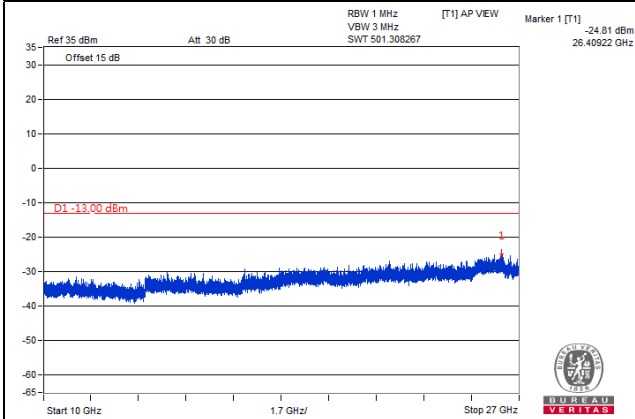

\*The 9kHz signal over the limit is from Spectrum.

LTE Band 26, Channel Bandwidth 5MHz

Channel 26915 (836.5MHz)

Frequency Range : 9kHz~1GHz

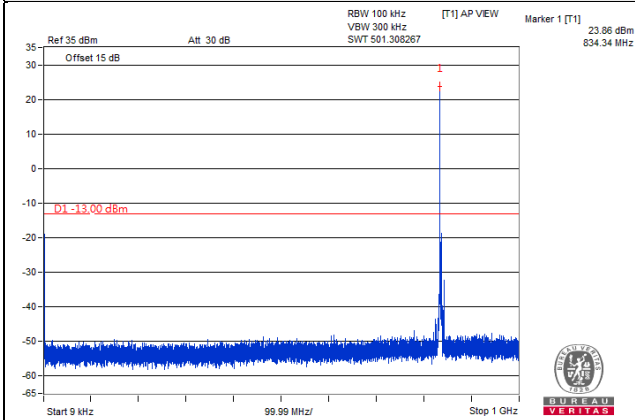

Frequency Range : 1GHz~10GHz

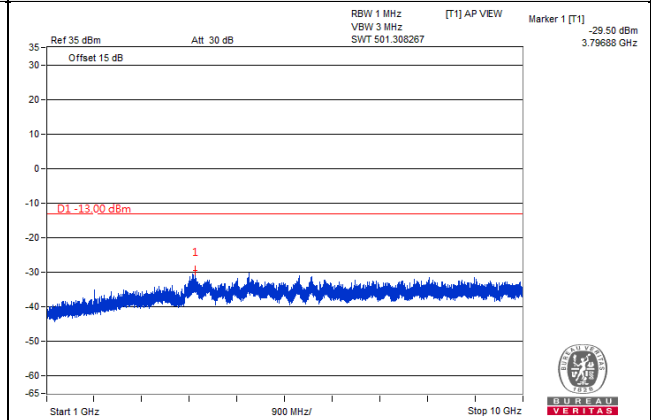

Frequency Range : 10GHz~27GHz

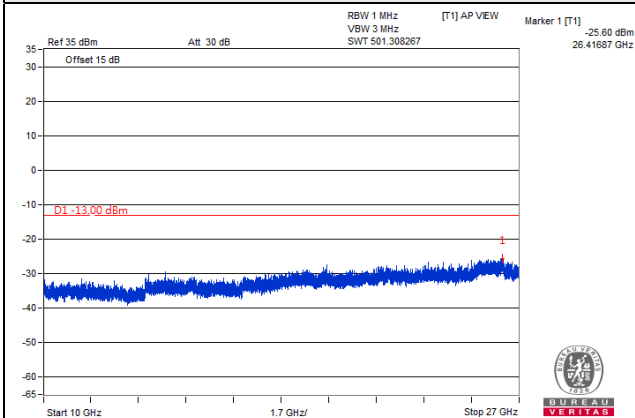

\*The 9kHz signal over the limit is from Spectrum.

LTE Band 26, Channel Bandwidth 5MHz

Channel 27015 (846.5MHz)

Frequency Range : 9kHz~1GHz

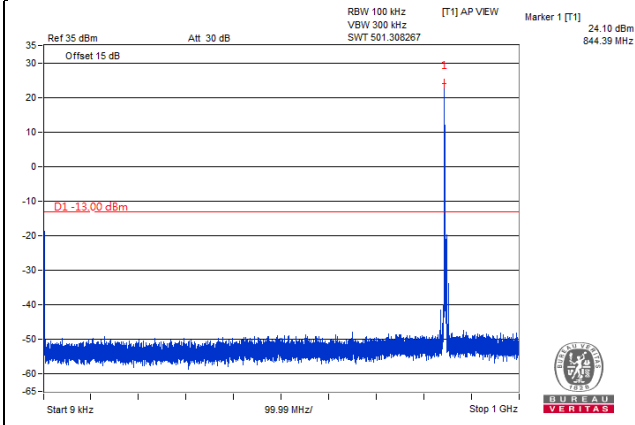

Frequency Range : 1GHz~10GHz

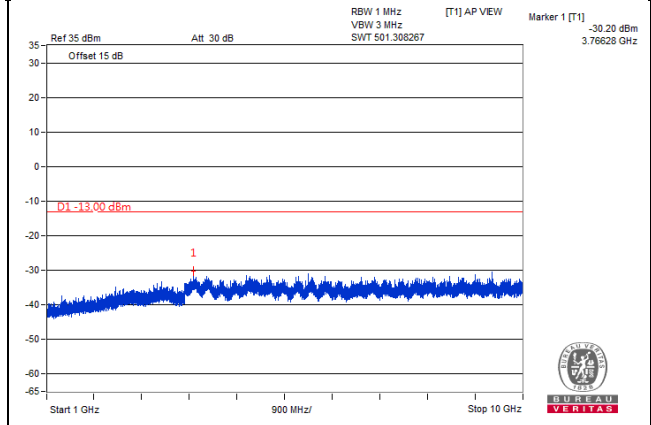

Frequency Range : 10GHz~27GHz

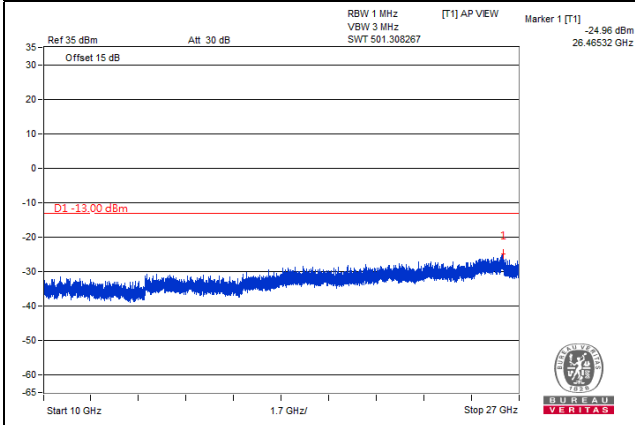

\*The 9kHz signal over the limit is from Spectrum.

LTE Band 26, Channel Bandwidth 10MHz

Channel 26840 (829MHz)

Frequency Range : 9kHz~1GHz

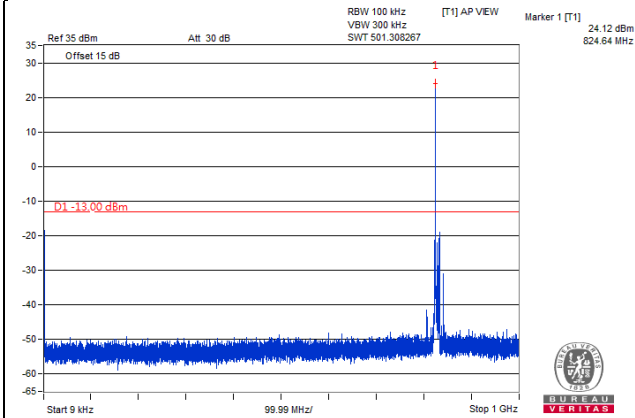

Frequency Range : 1GHz~10GHz

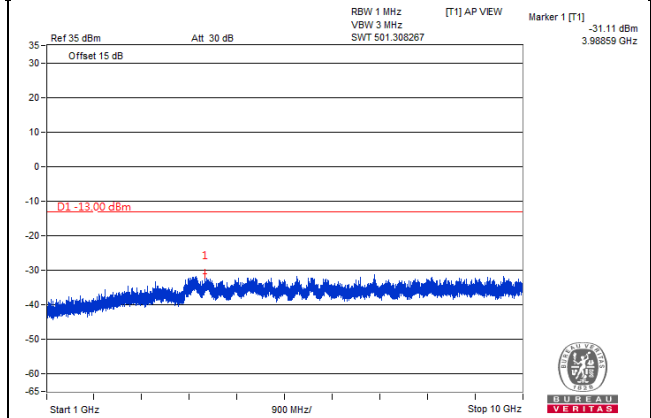

Frequency Range : 10GHz~27GHz

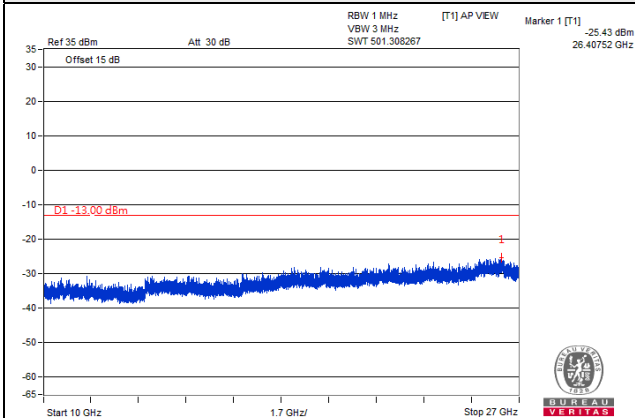

\*The 9kHz signal over the limit is from Spectrum.

LTE Band 26, Channel Bandwidth 10MHz

Channel 26915 (836.5MHz)

Frequency Range : 9kHz~1GHz

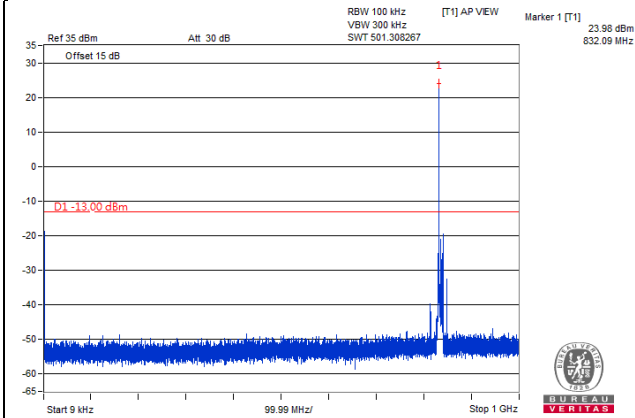

Frequency Range : 1GHz~10GHz

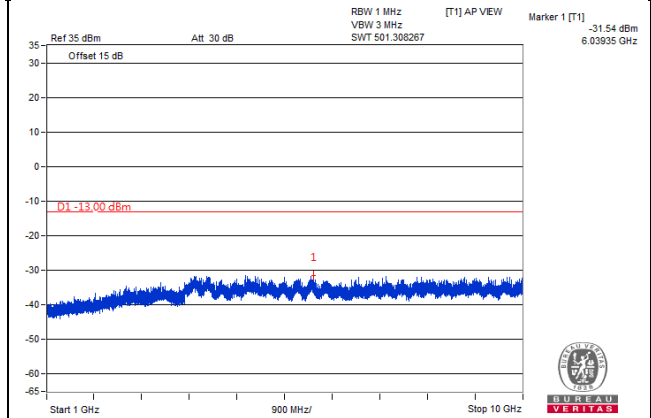

Frequency Range : 10GHz~27GHz

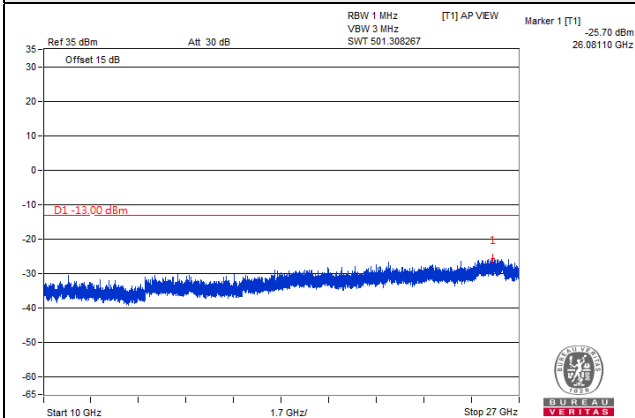

\*The 9kHz signal over the limit is from Spectrum.

LTE Band 26, Channel Bandwidth 10MHz

Channel 26990 (844MHz)

Frequency Range : 9kHz~1GHz

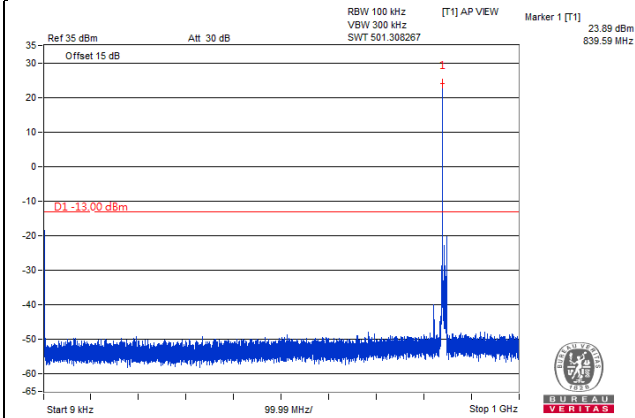

Frequency Range : 1GHz~10GHz

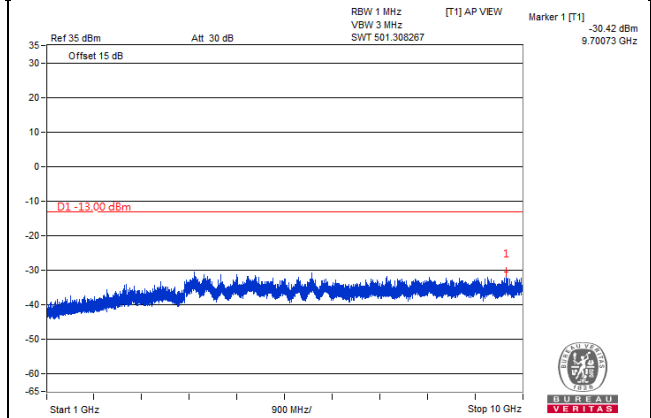

Frequency Range : 10GHz~27GHz

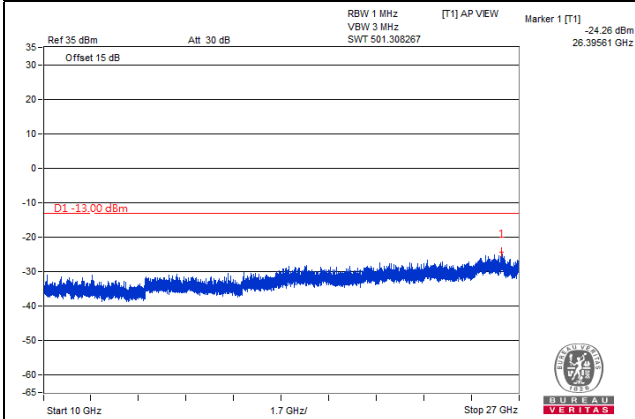

\*The 9kHz signal over the limit is from Spectrum.



LTE Band 26, Channel Bandwidth 15MHz

Channel 26865 (831.5MHz)

Frequency Range : 9kHz~1GHz

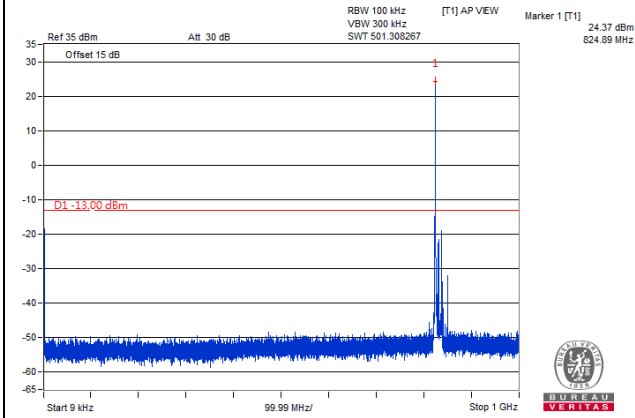

Frequency Range : 1GHz~10GHz

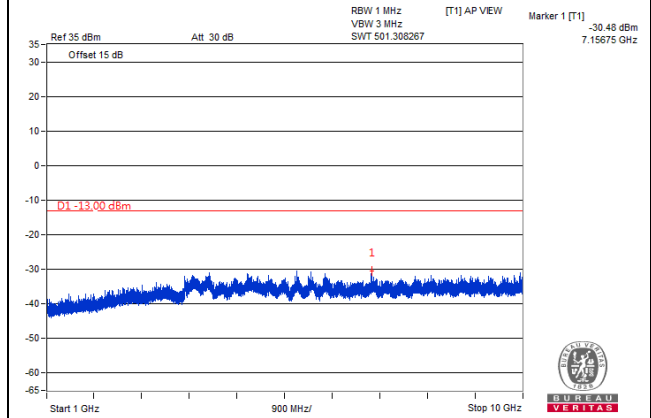

Frequency Range : 10GHz~27GHz

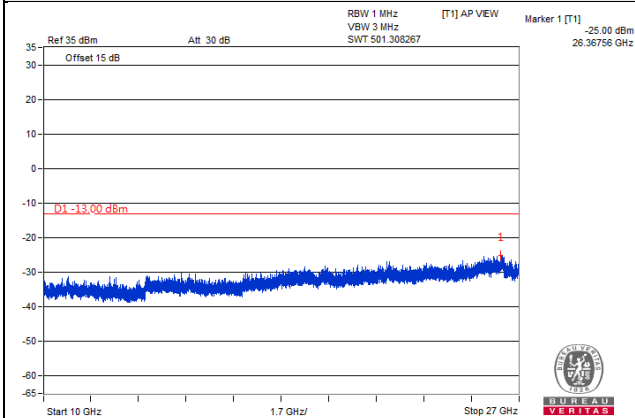

\*The 9kHz signal over the limit is from Spectrum.

LTE Band 26, Channel Bandwidth 15MHz

Channel 26915 (836.5MHz)

Frequency Range : 9kHz~1GHz

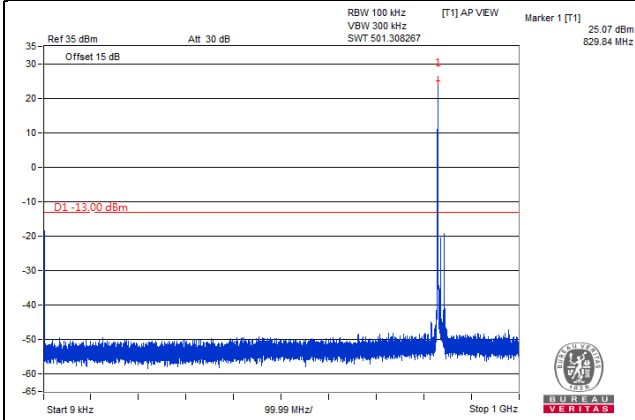

Frequency Range : 1GHz~10GHz

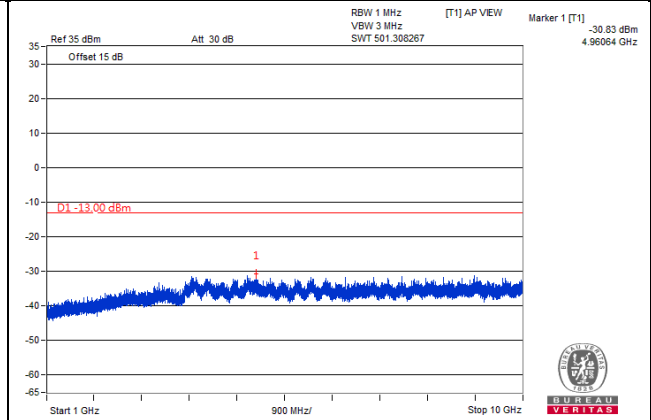

Frequency Range : 10GHz~27GHz

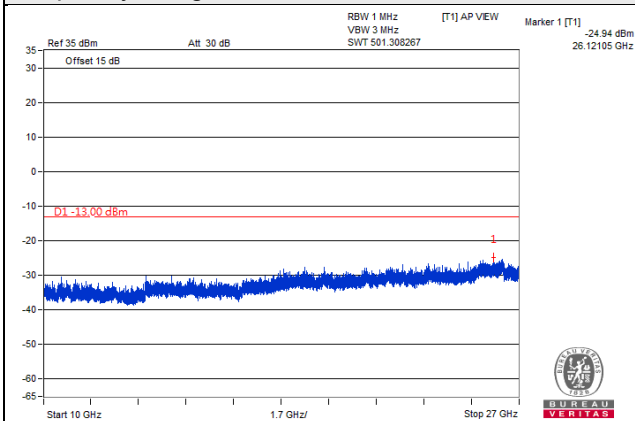

\*The 9kHz signal over the limit is from Spectrum.

LTE Band 26, Channel Bandwidth 15MHz

Channel 26965 (841.5MHz)

Frequency Range : 9kHz~1GHz

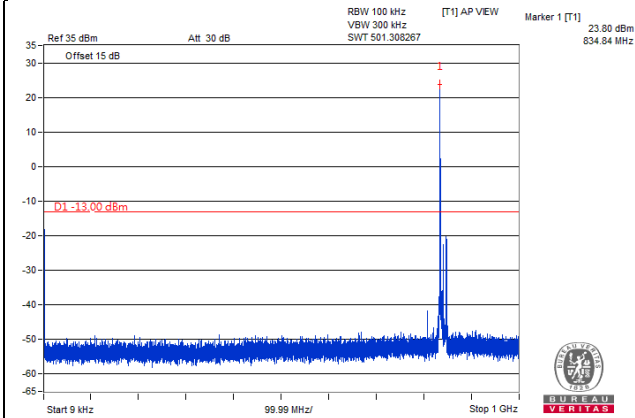

Frequency Range : 1GHz~10GHz

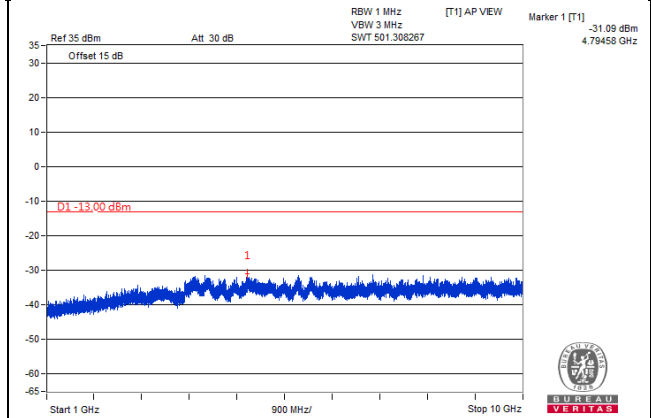

Frequency Range : 10GHz~27GHz

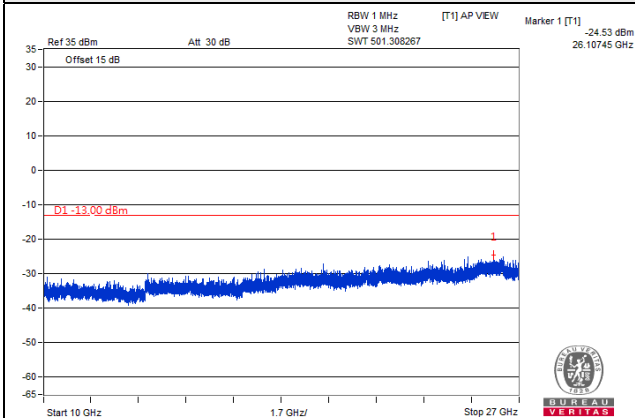

\*The 9kHz signal over the limit is from Spectrum.

## 4.7 Radiated Emission Measurement

### 4.7.1 Limits of Radiated Emission Measurement

The power of any emission outside of the authorized operating frequency ranges must be attenuated below the transmitting power (P) by a factor of at least  $43 + 10 \log(P)$  dB. The emission limit equal to  $-13\text{dBm}$ .

### 4.7.2 Test Procedure

- a. Substitution method is used for E.I.R.P measurement. In the semi-anechoic chamber, EUT placed on the 0.8m height of Turn Table, rotated the table around 360 degrees to search the maximum radiation power and receiver antenna shall be rotated vertical and horizontal polarization and moved height from 1m to 4m to find the maximum polar radiated power. The "Read Value" is the spectrum reading the maximum power value.
- b. The substitution horn antenna is substituted for EUT at the same position and signals generator export the CW signal to the substitution antenna via a TX cable. Rotated the Turn Table and moved receiving antenna to find the maximum radiation power. Adjust output power level of S.G to get a Value of spectrum reading equal to "Read Value" of step a. Record the power level of S.G
- c.  $\text{EIRP} = \text{Output power level of S.G} - \text{TX cable loss} + \text{Antenna gain of substitution horn}$ .
- d. E.R.P power can be calculated form E.I.R.P power by subtracting the gain of dipole,  $\text{E.R.P power} = \text{E.I.R.P power} - 2.15\text{dBi}$ .

NOTE: The resolution bandwidth and video bandwidth of test receiver/spectrum analyzer is 1MHz/3MHz.

### 4.7.3 Deviation from Test Standard

No deviation.

#### 4.7.4 Test Setup

For radiated emission 30MHz to 1GHz

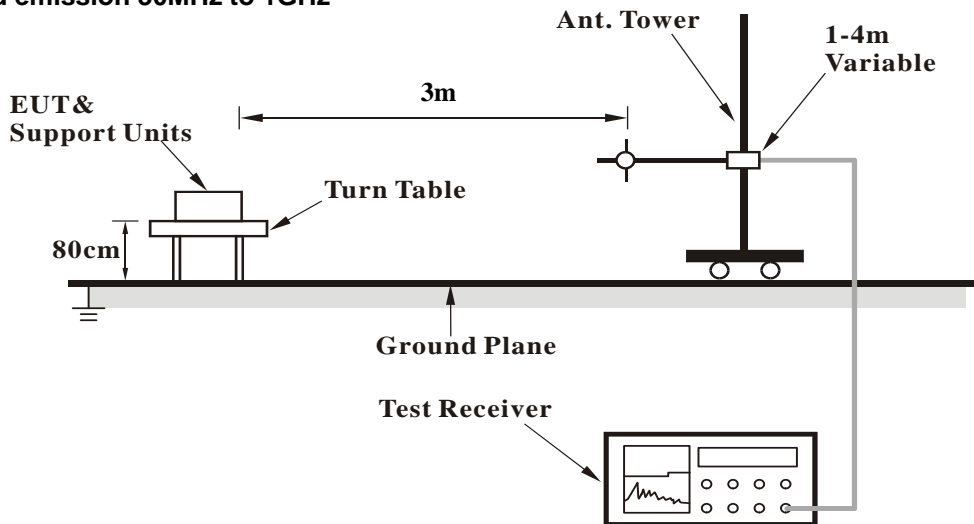

For radiated emission above 1GHz

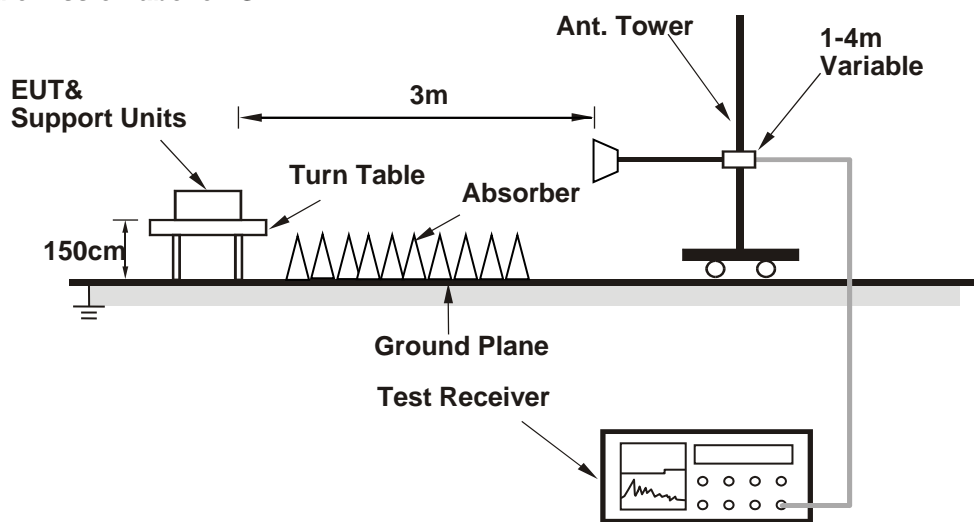

For the actual test configuration, please refer to the attached file (Test Setup Photo).

#### 4.7.5 Test Results

Below 1GHz  
GSM Mode

Mode	TX channel 128 (824.2MHz)	Frequency Range	Below 1000 MHz
Environmental Conditions	25deg. C, 70%RH	Input Power	120Vac, 60Hz
Tested By	Luis Lee		

Antenna Polarity & Test Distance: Horizontal at 3 M							
No.	Freq. (MHz)	Reading (dBm)	S.G Power Value (dBm)	Correction Factor (dB)	ERP (dBm)	Limit (dBm)	Margin (dB)
1	94.02	-40.5	-51.4	1.0	-50.4	-13.0	-37.4
2	119.24	-43.0	-52.8	0.1	-52.7	-13.0	-39.7
3	245.34	-54.5	-70.0	5.4	-64.6	-13.0	-51.6
4	433.52	-61.5	-70.2	5.2	-65.0	-13.0	-52.0
5	763.32	-69.2	-71.5	4.5	-67.0	-13.0	-54.0
6	889.42	-71.5	-71.1	3.9	-67.2	-13.0	-54.2

Remarks:

1. ERP (dBm) = S.G Value (dBm) + Correction Factor (dB).
2. Correction Factor (dB) = Substitution Antenna Gain (dB) + Cable Loss (dB).

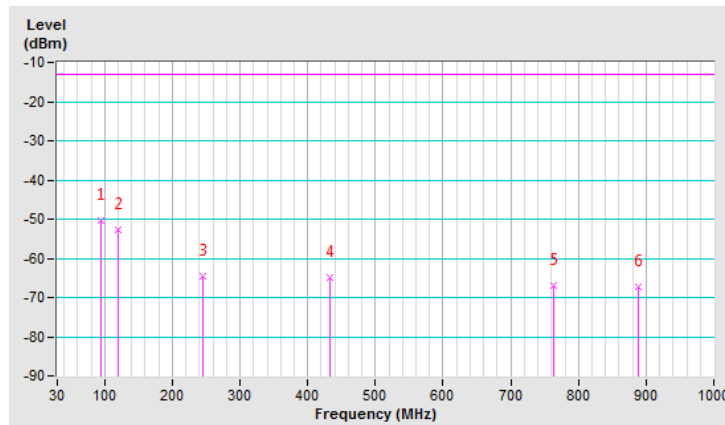

Mode	TX channel 128 (824.2MHz)	Frequency Range	Below 1000 MHz
Environmental Conditions	25deg. C, 70%RH	Input Power	120Vac, 60Hz
Tested By	Luis Lee		

Antenna Polarity & Test Distance: Vertical at 3 M							
No.	Freq. (MHz)	Reading (dBm)	S.G Power Value (dBm)	Correction Factor (dB)	ERP (dBm)	Limit (dBm)	Margin (dB)
1	45.52	-28.3	-26.9	-10.0	-36.9	-13.0	-23.9
2	61.04	-39.1	-41.2	-7.3	-48.5	-13.0	-35.5
3	146.40	-43.9	-48.0	-0.2	-48.2	-13.0	-35.2
4	175.50	-54.1	-59.0	2.3	-56.7	-13.0	-43.7
5	350.10	-59.6	-68.4	5.2	-63.2	-13.0	-50.2
6	786.60	-66.8	-66.9	4.2	-62.7	-13.0	-49.7

Remarks:

1. ERP (dBm) = S.G Value (dBm) + Correction Factor (dB).
2. Correction Factor (dB) = Substitution Antenna Gain (dB) + Cable Loss (dB).

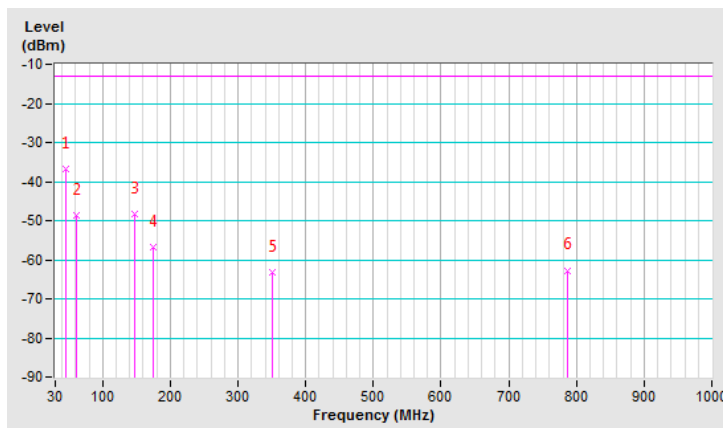

CDMA Mode

Mode	TX channel 1013 (824.7MHz)	Frequency Range	Below 1000 MHz
Environmental Conditions	25deg. C, 70%RH	Input Power	120Vac, 60Hz
Tested By	Luis Lee		

Antenna Polarity & Test Distance: Horizontal at 3 M							
No.	Freq. (MHz)	Reading (dBm)	S.G Power Value (dBm)	Correction Factor (dB)	ERP (dBm)	Limit (dBm)	Margin (dB)
1	49.40	-57.6	-50.3	-9.3	-59.6	-13.0	-46.6
2	64.92	-52.0	-53.8	-6.3	-60.1	-13.0	-47.1
3	192.96	-45.1	-60.9	4.6	-56.3	-13.0	-43.3
4	295.78	-48.0	-58.9	5.1	-53.8	-13.0	-40.8
5	790.48	-62.2	-63.1	4.1	-59.0	-13.0	-46.0
6	935.98	-55.1	-54.1	3.9	-50.2	-13.0	-37.2

Remarks:

- ERP (dBm) = S.G Value (dBm) + Correction Factor (dB).
- Correction Factor (dB) = Substitution Antenna Gain (dB) + Cable Loss (dB).

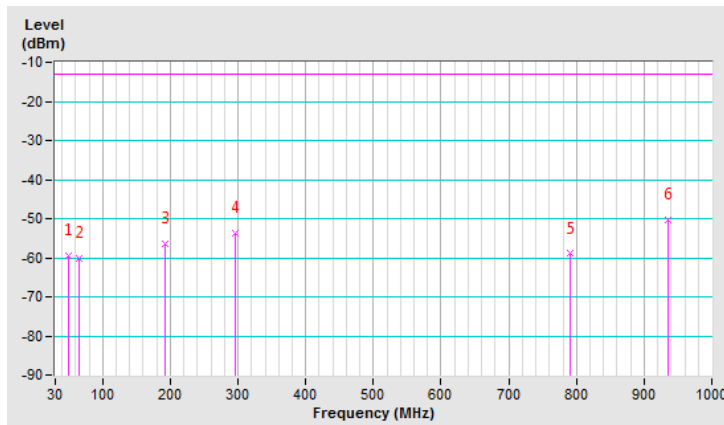



Mode	TX channel 1013 (824.7MHz)	Frequency Range	Below 1000 MHz
Environmental Conditions	25deg. C, 70%RH	Input Power	120Vac, 60Hz
Tested By	Luis Lee		

Antenna Polarity & Test Distance: Vertical at 3 M							
No.	Freq. (MHz)	Reading (dBm)	S.G Power Value (dBm)	Correction Factor (dB)	ERP (dBm)	Limit (dBm)	Margin (dB)
1	136.70	-56.0	-62.1	-0.3	-62.4	-13.0	-49.4
2	266.68	-59.1	-63.6	5.3	-58.3	-13.0	-45.3
3	435.46	-57.9	-66.7	5.2	-61.5	-13.0	-48.5
4	596.48	-66.8	-70.0	4.4	-65.6	-13.0	-52.6
5	691.54	-69.3	-71.8	5.2	-66.6	-13.0	-53.6
6	854.50	-73.1	-72.8	3.9	-68.9	-13.0	-55.9

Remarks:

1. ERP (dBm) = S.G Value (dBm) + Correction Factor (dB).
2. Correction Factor (dB) = Substitution Antenna Gain (dB) + Cable Loss (dB).

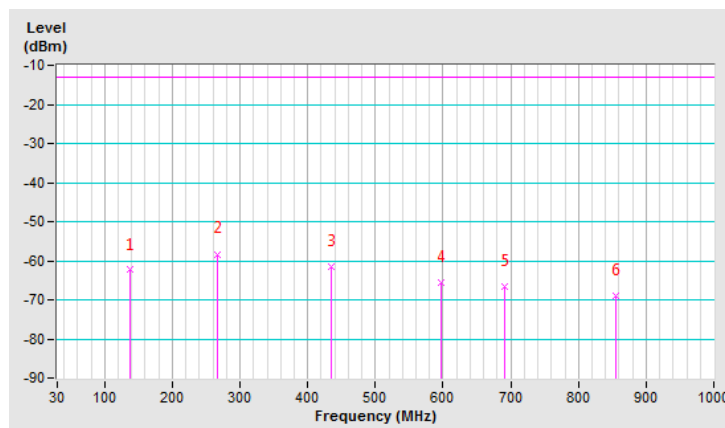

WCDMA Band 5

Mode	TX channel 4132 (826.4MHz)	Frequency Range	Below 1000 MHz
Environmental Conditions	25deg. C, 70%RH	Input Power	120Vac, 60Hz
Tested By	Luis Lee		

Antenna Polarity & Test Distance: Horizontal at 3 M							
No.	Freq. (MHz)	Reading (dBm)	S.G Power Value (dBm)	Correction Factor (dB)	ERP (dBm)	Limit (dBm)	Margin (dB)
1	53.28	-48.5	-43.8	-8.5	-52.3	-13.0	-39.3
2	227.88	-51.6	-67.6	5.4	-62.2	-13.0	-49.2
3	425.76	-60.9	-69.7	5.2	-64.5	-13.0	-51.5
4	557.68	-64.7	-72.1	4.7	-67.4	-13.0	-54.4
5	763.32	-68.0	-70.3	4.5	-65.8	-13.0	-52.8
6	935.98	-54.6	-53.7	3.9	-49.8	-13.0	-36.8

Remarks:

1. ERP (dBm) = S.G Value (dBm) + Correction Factor (dB).
2. Correction Factor (dB) = Substitution Antenna Gain (dB) + Cable Loss (dB).

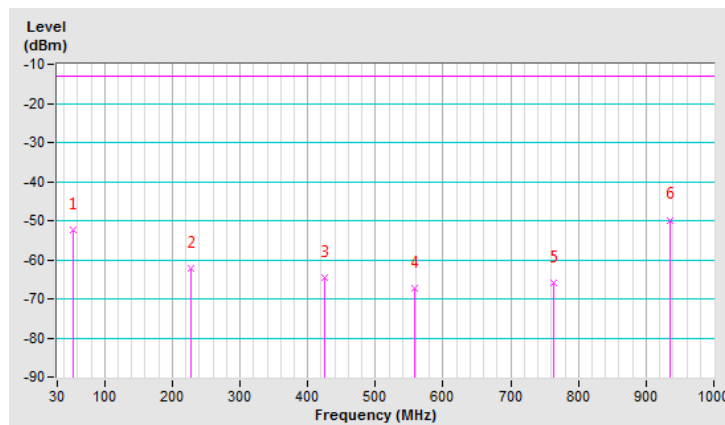

Mode	TX channel 4132 (826.4MHz)	Frequency Range	Below 1000 MHz
Environmental Conditions	25deg. C, 70%RH	Input Power	120Vac, 60Hz
Tested By	Luis Lee		

Antenna Polarity & Test Distance: Vertical at 3 M							
No.	Freq. (MHz)	Reading (dBm)	S.G Power Value (dBm)	Correction Factor (dB)	ERP (dBm)	Limit (dBm)	Margin (dB)
1	45.52	-35.2	-33.7	-10.0	-43.7	-13.0	-30.7
2	142.52	-49.9	-54.8	-0.3	-55.1	-13.0	-42.1
3	179.38	-53.4	-59.6	2.8	-56.8	-13.0	-43.8
4	326.82	-59.2	-67.6	5.2	-62.4	-13.0	-49.4
5	730.34	-70.3	-71.7	4.9	-66.8	-13.0	-53.8
6	790.48	-64.4	-64.3	4.1	-60.2	-13.0	-47.2

Remarks:

1. ERP (dBm) = S.G Value (dBm) + Correction Factor (dB).
2. Correction Factor (dB) = Substitution Antenna Gain (dB) + Cable Loss (dB).

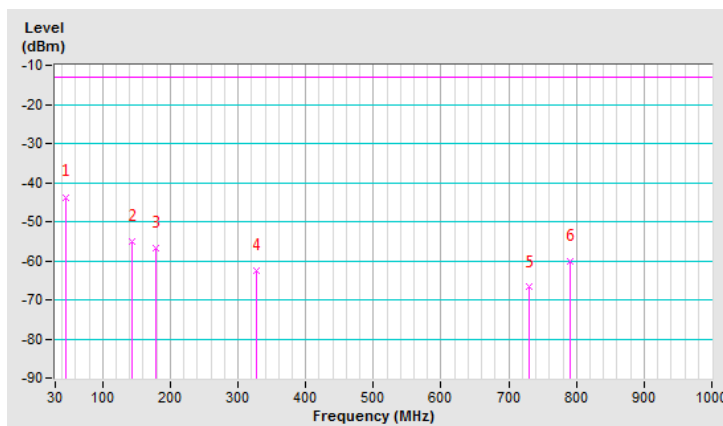

LTE Band 5, Channel Bandwidth: 5MHz

Mode	TX channel 20425 (826.5MHz)	Frequency Range	Below 1000 MHz
Environmental Conditions	25deg. C, 70%RH	Input Power	120Vac, 60Hz
Tested By	Luis Lee		

Antenna Polarity & Test Distance: Horizontal at 3 M							
No.	Freq. (MHz)	Reading (dBm)	S.G Power Value (dBm)	Correction Factor (dB)	ERP (dBm)	Limit (dBm)	Margin (dB)
1	53.28	-47.0	-42.3	-8.5	-50.8	-13.0	-37.8
2	202.66	-47.9	-64.0	5.4	-58.6	-13.0	-45.6
3	324.88	-50.8	-62.0	5.2	-56.8	-13.0	-43.8
4	416.06	-58.4	-66.8	5.2	-61.6	-13.0	-48.6
5	745.86	-63.9	-67.1	4.7	-62.4	-13.0	-49.4
6	788.54	-58.1	-59.0	4.1	-54.9	-13.0	-41.9

Remarks:

- ERP (dBm) = S.G Value (dBm) + Correction Factor (dB).
- Correction Factor (dB) = Substitution Antenna Gain (dB) + Cable Loss (dB).

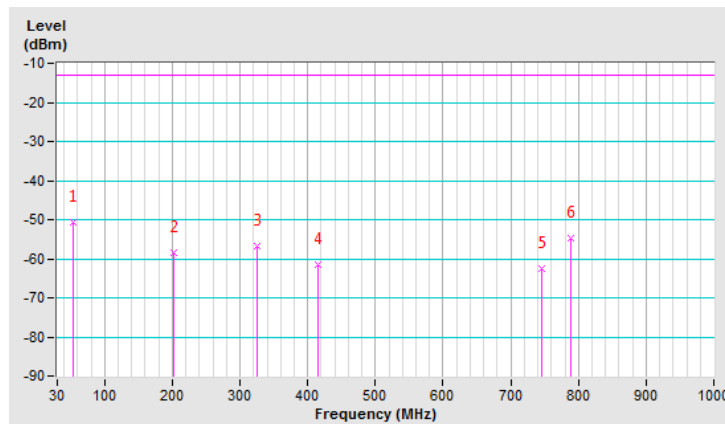

Mode	TX channel 20425 (826.5MHz)	Frequency Range	Below 1000 MHz
Environmental Conditions	25deg. C, 70%RH	Input Power	120Vac, 60Hz
Tested By	Luis Lee		

Antenna Polarity & Test Distance: Vertical at 3 M							
No.	Freq. (MHz)	Reading (dBm)	S.G Power Value (dBm)	Correction Factor (dB)	ERP (dBm)	Limit (dBm)	Margin (dB)
1	94.02	-55.0	-63.4	1.0	-62.4	-13.0	-49.4
2	138.64	-58.0	-63.9	-0.3	-64.2	-13.0	-51.2
3	260.86	-58.2	-64.1	5.3	-58.8	-13.0	-45.8
4	353.98	-61.3	-70.0	5.2	-64.8	-13.0	-51.8
5	582.90	-66.4	-70.4	4.5	-65.9	-13.0	-52.9
6	718.70	-66.8	-68.2	5.0	-63.2	-13.0	-50.2

Remarks:

- ERP (dBm) = S.G Value (dBm) + Correction Factor (dB).
- Correction Factor (dB) = Substitution Antenna Gain (dB) + Cable Loss (dB).

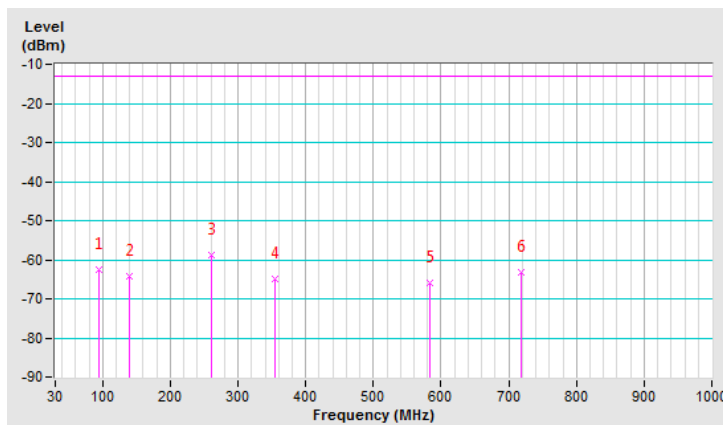

LTE Band 26, Channel Bandwidth 5MHz

Mode	TX channel 26815 (826.5MHz)	Frequency Range	Below 1000 MHz
Environmental Conditions	25deg. C, 70%RH	Input Power	120Vac, 60Hz
Tested By	Luis Lee		

Antenna Polarity & Test Distance: Horizontal at 3 M							
No.	Freq. (MHz)	Reading (dBm)	S.G Power Value (dBm)	Correction Factor (dB)	ERP (dBm)	Limit (dBm)	Margin (dB)
1	41.64	-41.2	-29.8	-10.6	-40.4	-13.0	-27.4
2	132.82	-46.1	-55.1	-0.1	-55.2	-13.0	-42.2
3	375.32	-52.1	-61.3	5.3	-56.0	-13.0	-43.0
4	460.68	-62.7	-70.9	5.0	-65.9	-13.0	-52.9
5	553.80	-65.5	-73.0	4.7	-68.3	-13.0	-55.3
6	691.54	-64.8	-70.3	5.2	-65.1	-13.0	-52.1

Remarks:

- ERP (dBm) = S.G Value (dBm) + Correction Factor (dB).
- Correction Factor (dB) = Substitution Antenna Gain (dB) + Cable Loss (dB).

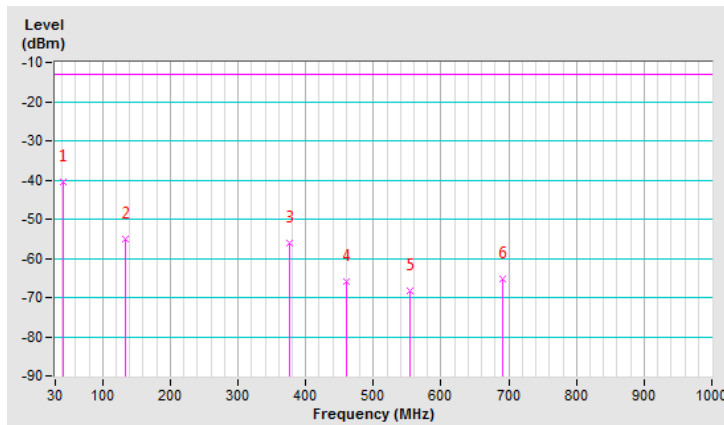

Mode	TX channel 26815 (826.5MHz)	Frequency Range	Below 1000 MHz
Environmental Conditions	25deg. C, 70%RH	Input Power	120Vac, 60Hz
Tested By	Luis Lee		

Antenna Polarity & Test Distance: Vertical at 3 M							
No.	Freq. (MHz)	Reading (dBm)	S.G Power Value (dBm)	Correction Factor (dB)	ERP (dBm)	Limit (dBm)	Margin (dB)
1	53.28	-36.5	-36.6	-8.5	-45.1	-13.0	-32.1
2	97.90	-50.9	-59.6	1.0	-58.6	-13.0	-45.6
3	264.74	-61.2	-66.1	5.3	-60.8	-13.0	-47.8
4	470.38	-60.6	-68.4	5.0	-63.4	-13.0	-50.4
5	767.20	-64.7	-65.1	4.4	-60.7	-13.0	-47.7
6	870.02	-69.1	-68.8	3.9	-64.9	-13.0	-51.9

Remarks:

1. ERP (dBm) = S.G Value (dBm) + Correction Factor (dB).
2. Correction Factor (dB) = Substitution Antenna Gain (dB) + Cable Loss (dB).

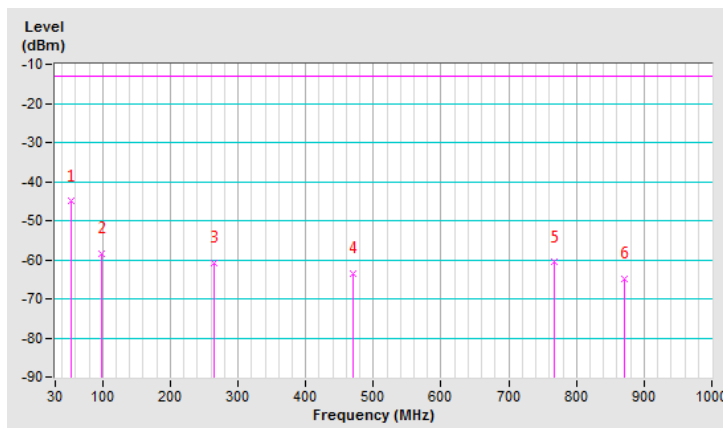

Above 1GHz  
GSM Mode

Mode	TX channel 128 (824.2MHz)	Frequency Range	1GH~10GHz
Environmental Conditions	25deg. C, 70%RH	Input Power	120Vac, 60Hz
Tested By	Luis Lee		

Antenna Polarity & Test Distance: Horizontal at 3 M							
No.	Freq. (MHz)	Reading (dBm)	S.G Power Value (dBm)	Correction Factor (dB)	ERP (dBm)	Limit (dBm)	Margin (dB)
1	1648.40	-55.4	-55.6	5.5	-50.1	-13.0	-37.1
Antenna Polarity & Test Distance: Vertical at 3 M							
No.	Freq. (MHz)	Reading (dBm)	S.G Power Value (dBm)	Correction Factor (dB)	ERP (dBm)	Limit (dBm)	Margin (dB)
1	1648.40	-49.7	-46.7	5.5	-41.2	-13.0	-28.2

Remarks:

1. ERP (dBm) = S.G Value (dBm) + Correction Factor (dB).
2. Correction Factor (dB) = Substitution Antenna Gain (dB) + Cable Loss (dB).

Mode	TX channel 189 (836.4MHz)	Frequency Range	1GH~10GHz
Environmental Conditions	25deg. C, 70%RH	Input Power	120Vac, 60Hz
Tested By	Luis Lee		

Antenna Polarity & Test Distance: Horizontal at 3 M							
No.	Freq. (MHz)	Reading (dBm)	S.G Power Value (dBm)	Correction Factor (dB)	ERP (dBm)	Limit (dBm)	Margin (dB)
1	1672.80	-54.2	-54.5	5.5	-49.0	-13.0	-36.0
Antenna Polarity & Test Distance: Vertical at 3 M							
No.	Freq. (MHz)	Reading (dBm)	S.G Power Value (dBm)	Correction Factor (dB)	ERP (dBm)	Limit (dBm)	Margin (dB)
1	1672.80	-49.8	-46.9	5.5	-41.4	-13.0	-28.4

Remarks:

1. ERP (dBm) = S.G Value (dBm) + Correction Factor (dB).
2. Correction Factor (dB) = Substitution Antenna Gain (dB) + Cable Loss (dB).



Mode	TX channel 251 (848.8MHz)	Frequency Range	1GH~10GHz
Environmental Conditions	25deg. C, 70%RH	Input Power	120Vac, 60Hz
Tested By	Luis Lee		

Antenna Polarity & Test Distance: Horizontal at 3 M							
No.	Freq. (MHz)	Reading (dBm)	S.G Power Value (dBm)	Correction Factor (dB)	ERP (dBm)	Limit (dBm)	Margin (dB)
1	1697.60	-54.5	-54.9	5.6	-49.3	-13.0	-36.3
Antenna Polarity & Test Distance: Vertical at 3 M							
No.	Freq. (MHz)	Reading (dBm)	S.G Power Value (dBm)	Correction Factor (dB)	ERP (dBm)	Limit (dBm)	Margin (dB)
1	1697.60	-49.5	-46.6	5.6	-41.0	-13.0	-28.0

Remarks:

1.  $ERP (dBm) = S.G \text{ Value (dBm)} + \text{Correction Factor (dB)}$ .
2.  $\text{Correction Factor (dB)} = \text{Substitution Antenna Gain (dB)} + \text{Cable Loss (dB)}$ .

CDMA Mode

Mode	TX channel 1013 (824.7MHz)	Frequency Range	1GH~10GHz
Environmental Conditions	25deg. C, 70%RH	Input Power	120Vac, 60Hz
Tested By	Noah Chang		

Antenna Polarity & Test Distance: Horizontal at 3 M							
No.	Freq. (MHz)	Reading (dBm)	S.G Power Value (dBm)	Correction Factor (dB)	ERP (dBm)	Limit (dBm)	Margin (dB)
1	1649.40	-59.4	-62.6	5.5	-57.1	-13.0	-44.1
Antenna Polarity & Test Distance: Vertical at 3 M							
No.	Freq. (MHz)	Reading (dBm)	S.G Power Value (dBm)	Correction Factor (dB)	ERP (dBm)	Limit (dBm)	Margin (dB)
1	1649.40	-58.6	-59.7	5.5	-54.2	-13.0	-41.2

Remarks:

1. ERP (dBm) = S.G Value (dBm) + Correction Factor (dB).
2. Correction Factor (dB) = Substitution Antenna Gain (dB) + Cable Loss (dB).

Mode	TX channel 384 (836.52MHz)	Frequency Range	1GH~10GHz
Environmental Conditions	25deg. C, 70%RH	Input Power	120Vac, 60Hz
Tested By	Noah Chang		

Antenna Polarity & Test Distance: Horizontal at 3 M							
No.	Freq. (MHz)	Reading (dBm)	S.G Power Value (dBm)	Correction Factor (dB)	ERP (dBm)	Limit (dBm)	Margin (dB)
1	1673.04	-59.2	-62.3	5.5	-56.8	-13.0	-43.8
Antenna Polarity & Test Distance: Vertical at 3 M							
No.	Freq. (MHz)	Reading (dBm)	S.G Power Value (dBm)	Correction Factor (dB)	ERP (dBm)	Limit (dBm)	Margin (dB)
1	1673.04	-59.2	-60.0	5.5	-54.5	-13.0	-41.5

Remarks:

1. ERP (dBm) = S.G Value (dBm) + Correction Factor (dB).
2. Correction Factor (dB) = Substitution Antenna Gain (dB) + Cable Loss (dB).

Mode	TX channel 777 848.31MHz)	Frequency Range	1GH~10GHz
Environmental Conditions	25deg. C, 70%RH	Input Power	120Vac, 60Hz
Tested By	Noah Chang		

Antenna Polarity & Test Distance: Horizontal at 3 M							
No.	Freq. (MHz)	Reading (dBm)	S.G Power Value (dBm)	Correction Factor (dB)	ERP (dBm)	Limit (dBm)	Margin (dB)
1	1696.62	-59.5	-62.3	5.6	-56.7	-13.0	-43.7
Antenna Polarity & Test Distance: Vertical at 3 M							
No.	Freq. (MHz)	Reading (dBm)	S.G Power Value (dBm)	Correction Factor (dB)	ERP (dBm)	Limit (dBm)	Margin (dB)
1	1696.62	-59.2	-59.7	5.6	-54.1	-13.0	-41.1

Remarks:

1. ERP (dBm) = S.G Value (dBm) + Correction Factor (dB).
2. Correction Factor (dB) = Substitution Antenna Gain (dB) + Cable Loss (dB).

WCDMA Band 5

Mode	TX channel 4132 (826.4MHz)	Frequency Range	1GH~10GHz
Environmental Conditions	25deg. C, 70%RH	Input Power	120Vac, 60Hz
Tested By	Noah Chang		

Antenna Polarity & Test Distance: Horizontal at 3 M							
No.	Freq. (MHz)	Reading (dBm)	S.G Power Value (dBm)	Correction Factor (dB)	ERP (dBm)	Limit (dBm)	Margin (dB)
1	1652.80	-56.5	-59.7	5.5	-54.2	-13.0	-41.2
Antenna Polarity & Test Distance: Vertical at 3 M							
No.	Freq. (MHz)	Reading (dBm)	S.G Power Value (dBm)	Correction Factor (dB)	ERP (dBm)	Limit (dBm)	Margin (dB)
1	1652.80	-56.0	-57.0	5.5	-51.5	-13.0	-38.5

Remarks:

1. ERP (dBm) = S.G Value (dBm) + Correction Factor (dB).
2. Correction Factor (dB) = Substitution Antenna Gain (dB) + Cable Loss (dB).

Mode	TX channel 4182 (836.4MHz)	Frequency Range	1GH~10GHz
Environmental Conditions	25deg. C, 70%RH	Input Power	120Vac, 60Hz
Tested By	Noah Chang		

Antenna Polarity & Test Distance: Horizontal at 3 M							
No.	Freq. (MHz)	Reading (dBm)	S.G Power Value (dBm)	Correction Factor (dB)	ERP (dBm)	Limit (dBm)	Margin (dB)
1	1672.80	-57.0	-60.0	5.5	-54.5	-13.0	-41.5
Antenna Polarity & Test Distance: Vertical at 3 M							
No.	Freq. (MHz)	Reading (dBm)	S.G Power Value (dBm)	Correction Factor (dB)	ERP (dBm)	Limit (dBm)	Margin (dB)
1	1672.80	-56.2	-57.0	5.5	-51.5	-13.0	-38.5

Remarks:

1. ERP (dBm) = S.G Value (dBm) + Correction Factor (dB).
2. Correction Factor (dB) = Substitution Antenna Gain (dB) + Cable Loss (dB).

Mode	TX channel 4233 (846.6MHz)	Frequency Range	1GH~10GHz
Environmental Conditions	25deg. C, 70%RH	Input Power	120Vac, 60Hz
Tested By	Noah Chang		

Antenna Polarity & Test Distance: Horizontal at 3 M							
No.	Freq. (MHz)	Reading (dBm)	S.G Power Value (dBm)	Correction Factor (dB)	ERP (dBm)	Limit (dBm)	Margin (dB)
1	1693.20	-57.5	-60.4	5.6	-54.8	-13.0	-41.8
Antenna Polarity & Test Distance: Vertical at 3 M							
No.	Freq. (MHz)	Reading (dBm)	S.G Power Value (dBm)	Correction Factor (dB)	ERP (dBm)	Limit (dBm)	Margin (dB)
1	1693.20	-57.0	-57.6	5.6	-52.0	-13.0	-39.0

Remarks:

1.  $ERP (dBm) = S.G \text{ Value (dBm)} + \text{Correction Factor (dB)}$ .
2.  $\text{Correction Factor (dB)} = \text{Substitution Antenna Gain (dB)} + \text{Cable Loss (dB)}$ .

LTE Band 5, Channel Bandwidth: 1.4MHz

Mode	TX channel 20407 (824.7MHz)	Frequency Range	1GH~10GHz
Environmental Conditions	22deg. C, 66%RH	Input Power	120Vac, 60Hz
Tested By	Han Wu		

Antenna Polarity & Test Distance: Horizontal at 3 M

No.	Freq. (MHz)	Reading (dBm)	S.G Power Value (dBm)	Correction Factor (dB)	ERP (dBm)	Limit (dBm)	Margin (dB)
1	1649.40	-53.1	-45.4	0.9	-44.5	-13.0	-31.5

Antenna Polarity & Test Distance: Vertical at 3 M

No.	Freq. (MHz)	Reading (dBm)	S.G Power Value (dBm)	Correction Factor (dB)	ERP (dBm)	Limit (dBm)	Margin (dB)
1	1649.40	-52.4	-45.2	0.9	-44.3	-13.0	-31.3

Remarks:

1. ERP (dBm) = S.G Value (dBm) + Correction Factor (dB).
2. Correction Factor (dB) = Substitution Antenna Gain (dB) + Cable Loss (dB).

Mode	TX channel 20525 (836.5MHz)	Frequency Range	1GH~10GHz
Environmental Conditions	22deg. C, 66%RH	Input Power	120Vac, 60Hz
Tested By	Han Wu		

Antenna Polarity & Test Distance: Horizontal at 3 M

No.	Freq. (MHz)	Reading (dBm)	S.G Power Value (dBm)	Correction Factor (dB)	ERP (dBm)	Limit (dBm)	Margin (dB)
1	1673.00	-53.5	-45.9	0.8	-45.1	-13.0	-32.1

Antenna Polarity & Test Distance: Vertical at 3 M

No.	Freq. (MHz)	Reading (dBm)	S.G Power Value (dBm)	Correction Factor (dB)	ERP (dBm)	Limit (dBm)	Margin (dB)
1	1673.00	-51.9	-44.5	0.8	-43.7	-13.0	-30.7

Remarks:

1. ERP (dBm) = S.G Value (dBm) + Correction Factor (dB).
2. Correction Factor (dB) = Substitution Antenna Gain (dB) + Cable Loss (dB).

Mode	TX channel 20643 (848.3MHz)	Frequency Range	1GH~10GHz
Environmental Conditions	22deg. C, 66%RH	Input Power	120Vac, 60Hz
Tested By	Han Wu		

Antenna Polarity & Test Distance: Horizontal at 3 M							
No.	Freq. (MHz)	Reading (dBm)	S.G Power Value (dBm)	Correction Factor (dB)	ERP (dBm)	Limit (dBm)	Margin (dB)
1	1696.60	-53.2	-45.7	0.7	-45.0	-13.0	-32.0
Antenna Polarity & Test Distance: Vertical at 3 M							
No.	Freq. (MHz)	Reading (dBm)	S.G Power Value (dBm)	Correction Factor (dB)	ERP (dBm)	Limit (dBm)	Margin (dB)
1	1696.60	-51.8	-44.5	0.7	-43.8	-13.0	-30.8

Remarks:

1. ERP (dBm) = S.G Value (dBm) + Correction Factor (dB).
2. Correction Factor (dB) = Substitution Antenna Gain (dB) + Cable Loss (dB).

LTE Band 5, Channel Bandwidth: 5MHz

Mode	TX channel 20425 (826.5MHz)	Frequency Range	1GH~10GHz
Environmental Conditions	22deg. C, 66%RH	Input Power	120Vac, 60Hz
Tested By	Han Wu		

Antenna Polarity & Test Distance: Horizontal at 3 M

No.	Freq. (MHz)	Reading (dBm)	S.G Power Value (dBm)	Correction Factor (dB)	ERP (dBm)	Limit (dBm)	Margin (dB)
1	1653.00	-53.4	-45.7	0.9	-44.8	-13.0	-31.8

Antenna Polarity & Test Distance: Vertical at 3 M

No.	Freq. (MHz)	Reading (dBm)	S.G Power Value (dBm)	Correction Factor (dB)	ERP (dBm)	Limit (dBm)	Margin (dB)
1	1653.00	-51.9	-44.6	0.9	-43.7	-13.0	-30.7

Remarks:

1. ERP (dBm) = S.G Value (dBm) + Correction Factor (dB).
2. Correction Factor (dB) = Substitution Antenna Gain (dB) + Cable Loss (dB).

Mode	TX channel 20525 (836.5MHz)	Frequency Range	1GH~10GHz
Environmental Conditions	22deg. C, 66%RH	Input Power	120Vac, 60Hz
Tested By	Han Wu		

Antenna Polarity & Test Distance: Horizontal at 3 M

No.	Freq. (MHz)	Reading (dBm)	S.G Power Value (dBm)	Correction Factor (dB)	ERP (dBm)	Limit (dBm)	Margin (dB)
1	1673.00	-52.8	-45.2	0.8	-44.4	-13.0	-31.4

Antenna Polarity & Test Distance: Vertical at 3 M

No.	Freq. (MHz)	Reading (dBm)	S.G Power Value (dBm)	Correction Factor (dB)	ERP (dBm)	Limit (dBm)	Margin (dB)
1	1673.00	-51.8	-44.4	0.8	-43.6	-13.0	-30.6

Remarks:

1. ERP (dBm) = S.G Value (dBm) + Correction Factor (dB).
2. Correction Factor (dB) = Substitution Antenna Gain (dB) + Cable Loss (dB).



Mode	TX channel 20625 (846.5MHz)	Frequency Range	1GH~10GHz
Environmental Conditions	22deg. C, 66%RH	Input Power	120Vac, 60Hz
Tested By	Han Wu		

Antenna Polarity & Test Distance: Horizontal at 3 M							
No.	Freq. (MHz)	Reading (dBm)	S.G Power Value (dBm)	Correction Factor (dB)	ERP (dBm)	Limit (dBm)	Margin (dB)
1	1693.00	-52.6	-45.1	0.7	-44.4	-13.0	-31.4
Antenna Polarity & Test Distance: Vertical at 3 M							
No.	Freq. (MHz)	Reading (dBm)	S.G Power Value (dBm)	Correction Factor (dB)	ERP (dBm)	Limit (dBm)	Margin (dB)
1	1693.00	-52.2	-44.9	0.7	-44.2	-13.0	-31.2

Remarks:

1.  $ERP (dBm) = S.G \text{ Value (dBm)} + \text{Correction Factor (dB)}$ .
2.  $\text{Correction Factor (dB)} = \text{Substitution Antenna Gain (dB)} + \text{Cable Loss (dB)}$ .

LTE Band 5, Channel Bandwidth: 10MHz

Mode	TX channel 20450 (829.0MHz)	Frequency Range	1GH~10GHz
Environmental Conditions	22deg. C, 66%RH	Input Power	120Vac, 60Hz
Tested By	Han Wu		

Antenna Polarity & Test Distance: Horizontal at 3 M

No.	Freq. (MHz)	Reading (dBm)	S.G Power Value (dBm)	Correction Factor (dB)	ERP (dBm)	Limit (dBm)	Margin (dB)
1	1658.00	-53.1	-45.5	0.9	-44.6	-13.0	-31.6

Antenna Polarity & Test Distance: Vertical at 3 M

No.	Freq. (MHz)	Reading (dBm)	S.G Power Value (dBm)	Correction Factor (dB)	ERP (dBm)	Limit (dBm)	Margin (dB)
1	1658.00	-52.2	-45.0	0.9	-44.1	-13.0	-31.1

Remarks:

1. ERP (dBm) = S.G Value (dBm) + Correction Factor (dB).
2. Correction Factor (dB) = Substitution Antenna Gain (dB) + Cable Loss (dB).

Mode	TX channel 20525 (836.5MHz)	Frequency Range	1GH~10GHz
Environmental Conditions	22deg. C, 66%RH	Input Power	120Vac, 60Hz
Tested By	Han Wu		

Antenna Polarity & Test Distance: Horizontal at 3 M

No.	Freq. (MHz)	Reading (dBm)	S.G Power Value (dBm)	Correction Factor (dB)	ERP (dBm)	Limit (dBm)	Margin (dB)
1	1673.00	-52.8	-45.2	0.8	-44.4	-13.0	-31.4

Antenna Polarity & Test Distance: Vertical at 3 M

No.	Freq. (MHz)	Reading (dBm)	S.G Power Value (dBm)	Correction Factor (dB)	ERP (dBm)	Limit (dBm)	Margin (dB)
1	1673.00	-52.0	-44.7	0.8	-43.9	-13.0	-30.9

Remarks:

1. ERP (dBm) = S.G Value (dBm) + Correction Factor (dB).
2. Correction Factor (dB) = Substitution Antenna Gain (dB) + Cable Loss (dB).

Mode	TX channel 20600 (844.0MHz)	Frequency Range	1GH~10GHz
Environmental Conditions	22deg. C, 66%RH	Input Power	120Vac, 60Hz
Tested By	Han Wu		

Antenna Polarity & Test Distance: Horizontal at 3 M							
No.	Freq. (MHz)	Reading (dBm)	S.G Power Value (dBm)	Correction Factor (dB)	ERP (dBm)	Limit (dBm)	Margin (dB)
1	1688.00	-53.1	-45.5	0.7	-44.8	-13.0	-31.8
Antenna Polarity & Test Distance: Vertical at 3 M							
No.	Freq. (MHz)	Reading (dBm)	S.G Power Value (dBm)	Correction Factor (dB)	ERP (dBm)	Limit (dBm)	Margin (dB)
1	1688.00	-52.3	-45.0	0.7	-44.3	-13.0	-31.3

Remarks:

1.  $ERP (dBm) = S.G \text{ Value (dBm)} + \text{Correction Factor (dB)}$ .
2.  $\text{Correction Factor (dB)} = \text{Substitution Antenna Gain (dB)} + \text{Cable Loss (dB)}$ .

LTE Band 26, Channel Bandwidth 1.4MHz

Mode	TX channel 26797 (824.7MHz)	Frequency Range	1GH~10GHz
Environmental Conditions	25deg. C, 70%RH	Input Power	120Vac, 60Hz
Tested By	Noah Chang		

Antenna Polarity & Test Distance: Horizontal at 3 M							
No.	Freq. (MHz)	Reading (dBm)	S.G Power Value (dBm)	Correction Factor (dB)	ERP (dBm)	Limit (dBm)	Margin (dB)
1	1649.40	-55.5	-58.7	5.5	-53.2	-13.0	-40.2
Antenna Polarity & Test Distance: Vertical at 3 M							
No.	Freq. (MHz)	Reading (dBm)	S.G Power Value (dBm)	Correction Factor (dB)	ERP (dBm)	Limit (dBm)	Margin (dB)
1	1649.40	-55.6	-56.7	5.5	-51.2	-13.0	-38.2

Remarks:

1. ERP (dBm) = S.G Value (dBm) + Correction Factor (dB).
2. Correction Factor (dB) = Substitution Antenna Gain (dB) + Cable Loss (dB).

Mode	TX channel 26915 (836.5MHz)	Frequency Range	1GH~10GHz
Environmental Conditions	25deg. C, 70%RH	Input Power	120Vac, 60Hz
Tested By	Noah Chang		

Antenna Polarity & Test Distance: Horizontal at 3 M							
No.	Freq. (MHz)	Reading (dBm)	S.G Power Value (dBm)	Correction Factor (dB)	ERP (dBm)	Limit (dBm)	Margin (dB)
1	1673.00	-55.9	-58.9	5.5	-53.4	-13.0	-40.4
Antenna Polarity & Test Distance: Vertical at 3 M							
No.	Freq. (MHz)	Reading (dBm)	S.G Power Value (dBm)	Correction Factor (dB)	ERP (dBm)	Limit (dBm)	Margin (dB)
1	1673.00	-56.0	-56.7	5.5	-51.2	-13.0	-38.2

Remarks:

1. ERP (dBm) = S.G Value (dBm) + Correction Factor (dB).
2. Correction Factor (dB) = Substitution Antenna Gain (dB) + Cable Loss (dB).

Mode	TX channel 27033 (848.3MHz)	Frequency Range	1GH~10GHz
Environmental Conditions	25deg. C, 70%RH	Input Power	120Vac, 60Hz
Tested By	Noah Chang		

Antenna Polarity & Test Distance: Horizontal at 3 M							
No.	Freq. (MHz)	Reading (dBm)	S.G Power Value (dBm)	Correction Factor (dB)	ERP (dBm)	Limit (dBm)	Margin (dB)
1	1696.60	-55.8	-58.6	5.6	-53.0	-13.0	-40.0
Antenna Polarity & Test Distance: Vertical at 3 M							
No.	Freq. (MHz)	Reading (dBm)	S.G Power Value (dBm)	Correction Factor (dB)	ERP (dBm)	Limit (dBm)	Margin (dB)
1	1696.60	-56.0	-56.6	5.6	-51.0	-13.0	-38.0

Remarks:

1.  $ERP (dBm) = S.G \text{ Value (dBm)} + \text{Correction Factor (dB)}$ .
2.  $\text{Correction Factor (dB)} = \text{Substitution Antenna Gain (dB)} + \text{Cable Loss (dB)}$ .

LTE Band 26, Channel Bandwidth 5MHz

Mode	TX channel 26815 (826.5MHz)	Frequency Range	1GH~10GHz
Environmental Conditions	25deg. C, 70%RH	Input Power	120Vac, 60Hz
Tested By	Noah Chang		

Antenna Polarity & Test Distance: Horizontal at 3 M							
No.	Freq. (MHz)	Reading (dBm)	S.G Power Value (dBm)	Correction Factor (dB)	ERP (dBm)	Limit (dBm)	Margin (dB)
1	1653.00	-55.8	-59.0	5.5	-53.5	-13.0	-40.5
Antenna Polarity & Test Distance: Vertical at 3 M							
No.	Freq. (MHz)	Reading (dBm)	S.G Power Value (dBm)	Correction Factor (dB)	ERP (dBm)	Limit (dBm)	Margin (dB)
1	1653.00	-56.2	-57.2	5.5	-51.7	-13.0	-38.7

Remarks:

1. ERP (dBm) = S.G Value (dBm) + Correction Factor (dB).
2. Correction Factor (dB) = Substitution Antenna Gain (dB) + Cable Loss (dB).

Mode	TX channel 26915 (836.5MHz)	Frequency Range	1GH~10GHz
Environmental Conditions	25deg. C, 70%RH	Input Power	120Vac, 60Hz
Tested By	Noah Chang		

Antenna Polarity & Test Distance: Horizontal at 3 M							
No.	Freq. (MHz)	Reading (dBm)	S.G Power Value (dBm)	Correction Factor (dB)	ERP (dBm)	Limit (dBm)	Margin (dB)
1	1673.00	-56.2	-59.3	5.5	-53.8	-13.0	-40.8
Antenna Polarity & Test Distance: Vertical at 3 M							
No.	Freq. (MHz)	Reading (dBm)	S.G Power Value (dBm)	Correction Factor (dB)	ERP (dBm)	Limit (dBm)	Margin (dB)
1	1673.00	-56.0	-56.8	5.5	-51.3	-13.0	-38.3

Remarks:

1. ERP (dBm) = S.G Value (dBm) + Correction Factor (dB).
2. Correction Factor (dB) = Substitution Antenna Gain (dB) + Cable Loss (dB).

Mode	TX channel 27015 (846.5MHz)	Frequency Range	1GH~10GHz
Environmental Conditions	25deg. C, 70%RH	Input Power	120Vac, 60Hz
Tested By	Noah Chang		

Antenna Polarity & Test Distance: Horizontal at 3 M							
No.	Freq. (MHz)	Reading (dBm)	S.G Power Value (dBm)	Correction Factor (dB)	ERP (dBm)	Limit (dBm)	Margin (dB)
1	1693.00	-56.5	-59.4	5.5	-53.9	-13.0	-40.9
Antenna Polarity & Test Distance: Vertical at 3 M							
No.	Freq. (MHz)	Reading (dBm)	S.G Power Value (dBm)	Correction Factor (dB)	ERP (dBm)	Limit (dBm)	Margin (dB)
1	1693.00	-56.8	-57.3	5.5	-51.8	-13.0	-38.8

Remarks:

1.  $ERP (dBm) = S.G \text{ Value (dBm)} + \text{Correction Factor (dB)}$ .
2.  $\text{Correction Factor (dB)} = \text{Substitution Antenna Gain (dB)} + \text{Cable Loss (dB)}$ .

LTE Band 26, Channel Bandwidth 15MHz

Mode	TX channel 26865 (831.5MHz)	Frequency Range	1GH~10GHz
Environmental Conditions	25deg. C, 70%RH	Input Power	120Vac, 60Hz
Tested By	Noah Chang		

Antenna Polarity & Test Distance: Horizontal at 3 M							
No.	Freq. (MHz)	Reading (dBm)	S.G Power Value (dBm)	Correction Factor (dB)	ERP (dBm)	Limit (dBm)	Margin (dB)
1	1663.00	-55.5	-58.7	5.6	-53.1	-13.0	-40.1
Antenna Polarity & Test Distance: Vertical at 3 M							
No.	Freq. (MHz)	Reading (dBm)	S.G Power Value (dBm)	Correction Factor (dB)	ERP (dBm)	Limit (dBm)	Margin (dB)
1	1663.00	-55.8	-56.8	5.6	-51.2	-13.0	-38.2

Remarks:

1. ERP (dBm) = S.G Value (dBm) + Correction Factor (dB).
2. Correction Factor (dB) = Substitution Antenna Gain (dB) + Cable Loss (dB).

Mode	TX channel 26915 (836.5MHz)	Frequency Range	1GH~10GHz
Environmental Conditions	25deg. C, 70%RH	Input Power	120Vac, 60Hz
Tested By	Noah Chang		

Antenna Polarity & Test Distance: Horizontal at 3 M							
No.	Freq. (MHz)	Reading (dBm)	S.G Power Value (dBm)	Correction Factor (dB)	ERP (dBm)	Limit (dBm)	Margin (dB)
1	1673.00	-55.8	-58.8	5.5	-53.3	-13.0	-40.3
Antenna Polarity & Test Distance: Vertical at 3 M							
No.	Freq. (MHz)	Reading (dBm)	S.G Power Value (dBm)	Correction Factor (dB)	ERP (dBm)	Limit (dBm)	Margin (dB)
1	1673.00	-56.4	-57.1	5.5	-51.6	-13.0	-38.6

Remarks:

1. ERP (dBm) = S.G Value (dBm) + Correction Factor (dB).
2. Correction Factor (dB) = Substitution Antenna Gain (dB) + Cable Loss (dB).



Mode	TX channel 26965 (841.5MHz)	Frequency Range	1GH~10GHz
Environmental Conditions	25deg. C, 70%RH	Input Power	120Vac, 60Hz
Tested By	Noah Chang		

Antenna Polarity & Test Distance: Horizontal at 3 M							
No.	Freq. (MHz)	Reading (dBm)	S.G Power Value (dBm)	Correction Factor (dB)	ERP (dBm)	Limit (dBm)	Margin (dB)
1	1683.00	-55.6	-58.5	5.5	-53.0	-13.0	-40.0
Antenna Polarity & Test Distance: Vertical at 3 M							
No.	Freq. (MHz)	Reading (dBm)	S.G Power Value (dBm)	Correction Factor (dB)	ERP (dBm)	Limit (dBm)	Margin (dB)
1	1683.00	-56.4	-57.0	5.5	-51.5	-13.0	-38.5

Remarks:

1.  $ERP (dBm) = S.G \text{ Value (dBm)} + \text{Correction Factor (dB)}$ .
2.  $\text{Correction Factor (dB)} = \text{Substitution Antenna Gain (dB)} + \text{Cable Loss (dB)}$ .

## 5 Pictures of Test Arrangements

Please refer to the attached file (Test Setup Photo).

## Appendix – Information of the Testing Laboratories

We, Bureau Veritas Consumer Products Services (H.K.) Ltd., Taoyuan Branch, were founded in 1988 to provide our best service in EMC, Radio, Telecom and Safety consultation. Our laboratories are FCC recognized accredited test firms and accredited and approved according to ISO/IEC 17025.

If you have any comments, please feel free to contact us at the following:

### Lin Kou EMC/RF Lab

Tel: 886-2-26052180

Fax: 886-2-26051924

### Hsin Chu EMC/RF/Telecom Lab

Tel: 886-3-6668565

Fax: 886-3-6668323

### Hwa Ya EMC/RF/Safety Lab

Tel: 886-3-3183232

Fax: 886-3-3270892

**Email:** [service.adt@tw.bureauveritas.com](mailto:service.adt@tw.bureauveritas.com)

**Web Site:** [www.bureauveritas-adt.com](http://www.bureauveritas-adt.com)

The address and road map of all our labs can be found in our web site also.

--- END ---