

The REIGN Wireless Safety Edge Kit is a revolutionary product that will make any safety edge set up wireless. This kit allows for all major safety edge technology to work with any manufacturers operator. By using the proprietary Reign wireless technology we get extreme range and penetration from the most reliable wireless edge kit on the market.

WHAT'S INCLUDED

There are two pieces that complete the wireless edge kit. This kit includes the transmitter, which is connected to the safety edge, part number XET-100. The second component of the kit is the receiver, which is connected to the operator, part number XER-100.

HOW IT WORKS...

Congratulations on your purchase of the Transmitter Solutions Wireless Safety Edge Kit. It has been designed with state-of-the-art radio technology to allow for extreme range and penetration allowing for maximum reliability.

The wireless safety edge kit comes factory paired with all the necessary components to get the system up and running quickly. Simply install the batteries to the XET-100 and supply 8-24 VAC/DC power to the XER-100 and you will be up and running.

CONTENTS:

1. FCC REGULATORY STATEMENT.....	1
2. SPECIFICATIONS.....	9
3. BOARD CONNECTIONS.....	10
4. POWER DETAILS.....	10
5. LED INDICATORS.....	8
6. WIRING.....	9
7. DIP SWITCHES.....	8
8. JUMPERS.....	9
9. PAIRING IN THE FIELD.....	10
10. TROUBLESHOOTING.....	10

1. FCC REGULATORY STATEMENT

FCC ID: (2ASPOXET100) and (2ASPOXER100): This device complies with part 15 of the FCC rules. Operation is subject to the following two conditions: (1) This device may not cause harmful interference, and (2) this device must accept any interference received, including interference that may cause undesired operation.

IMPORTANT! Any changes or modifications not expressly approved by the party responsible for compliance could void the user's authority to operate this equipment.

NOTE: This equipment has been tested and found to comply with the limits for a Class B digital device, pursuant to part 15 of the FCC Rules. These limits are designed to provide reasonable protection against harmful interference in a

residential installation. This equipment generates, uses and can radiate radio frequency energy and, if not installed and used in accordance with the instructions, may cause harmful interference to radio communications. However, there is no guarantee that interference will not occur in a particular installation. If this equipment does cause harmful interference to radio or television reception, which can be determined by turning the equipment off and on, the user is encouraged to try to correct the interference by one or more of the following measures:

- Reorient or relocate the receiving antenna.
- Increase the separation between the equipment and receiver.
- Connect the equipment into an outlet on a circuit different from that to which the receiver is connected.
- Consult the dealer or an experienced radio/ TV technician for help.

FCC Radiation Exposure Statement

This equipment complies with FCC radiation exposure limits set forth for an uncontrolled environment. This equipment should be installed and operated with minimum distance 20cm between the radiator and your body.

This transmitter must not be co-located or operating in conjunction with any other antenna or transmitter. The antennas used for this transmitter must be installed to provide a separation distance of at least 20 cm from all persons and must not be co-located or operating in conjunction with any other antenna or transmitter.

FCC Caution: To assure continued compliance, any changes or modifications not expressly approved by the party responsible for compliance could void the user's authority to operate this equipment. (Example – use only shielded interface cables when connecting to computer or peripheral devices).

2. SPECIFICATIONS

Power Input: 8-24 Volt AC/DC

Minimum / Maximum Temperature Range:
-40°F to 185°F (-40°C to 85°C)

Security Encryption: AES

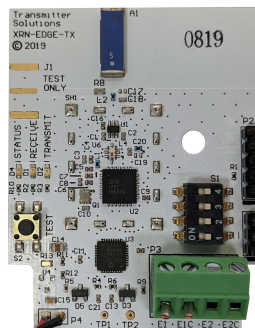
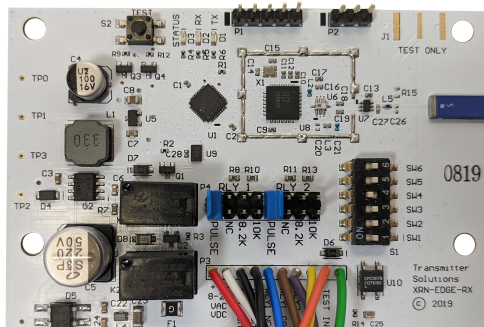

3. BOARD CONNECTIONS

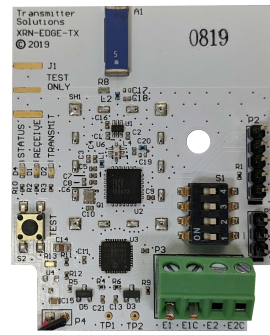
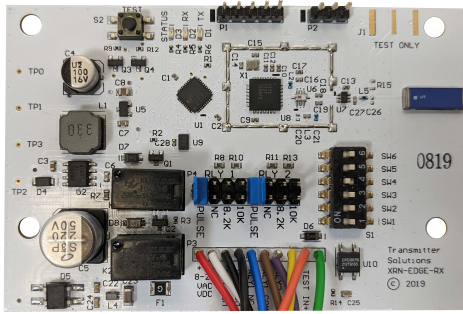

XER-100 OUTPUT CONNECTOR

FUNCTION	COMMENT
1	Input Power +
2	Input Power -
3	POWER COMMON
4	POWER COMMON
5	RELAY1 NC
6	RELAY1 COM
7	RELAY2 NC
8	RELAY2 COM
9	TEST IN+
10	TEST IN COM

XET-100 CONNECTOR

FUNCTION	COMMENT
1	EDGE1 INPUT
2	EDGE1 INPUT
3	EDGE2 INPUT
4	EDGE2 INPUT

4. POWER DETAILS

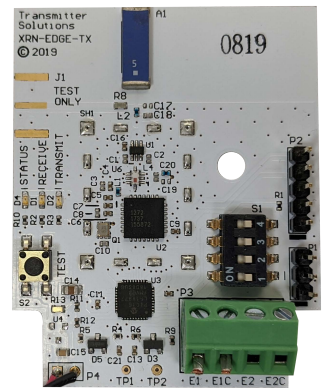
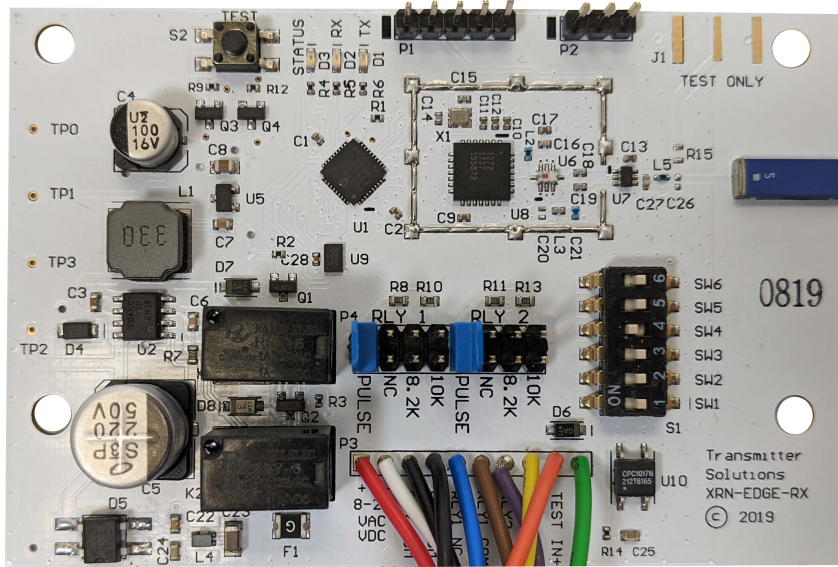

1 POWER INPUT: Power Input: 8 to 24 VOLTS AC/DC. 1 AMP Minimum.

2 BATTERY INPUT:

Battery Input: 2 AA Batteries

5. LED INDICATORS

STATUS LEDs:

1

2

3

4

5

Craig needs to update.

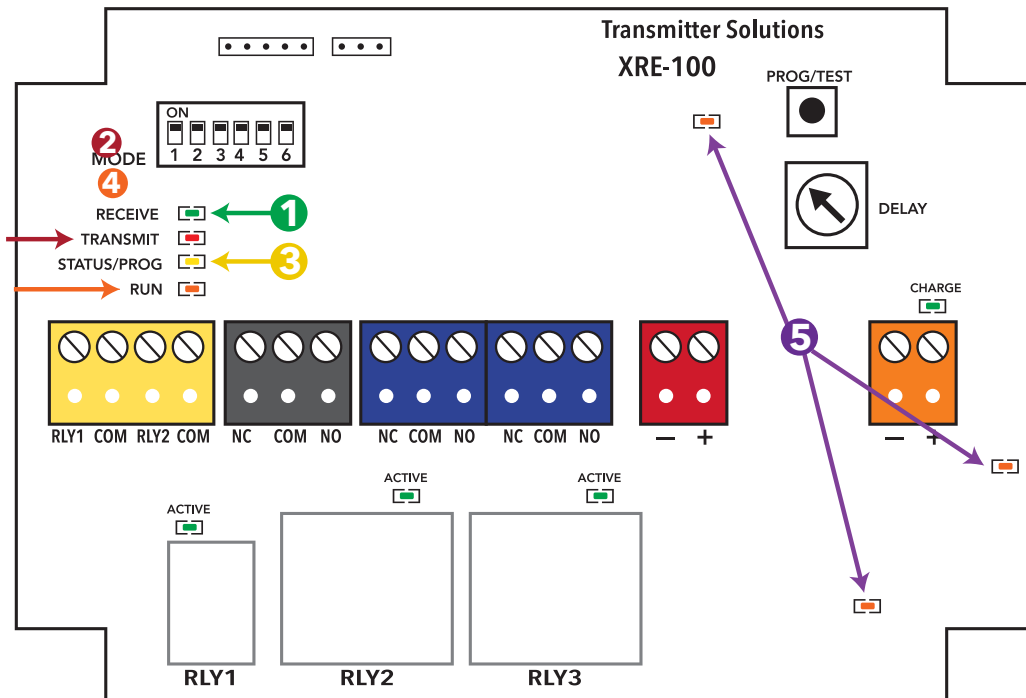

6. RELAY DIAGRAM AND WIRING

XER-100 OUTPUT CONNECTOR

	FUNCTION	COMMENT
1	Input Power +	8-24 VAC/VDC
2	Input Power -	
3	POWER COMMON	Circuit Ground
4	POWER COMMON	Circuit Ground
5	RELAY1 NC	
6	RELAY1 COM	
7	RELAY2 NC	
8	RELAY2 COM	
9	TEST IN+	Auto Test on Open Power
10	TEST IN COM	Auto Test on Open Common Input

XET-100 CONNECTOR

	FUNCTION	COMMENT
1	EDGE1 INPUT	8.2K or 10K
2	EDGE1 INPUT	8.2K or 10K
3	EDGE2 INPUT	DIPSWITCH 3 ON to Activate
4	EDGE2 INPUT	DIPSWITCH 3 ON to Activate



8. DIP SWITCHES

DIP SWITCHES:

XET-100 DIPSWITCHES

	FUNCTION	COMMENT
1	PAIRING MODE	ON to pair with XER-100 – OFF for normal operation
2	LOW POWER	XER-100 must be low power also. Saves Battery, Reduces range
3	CHANNEL 2 ACTIVE	For second edge input. Connects to Relay 2 Output on XER-100
4	SHOW LED's	For install and troubleshooting, turn off for normal use to save battery power

XER-100 DIPSWITCHES

	FUNCTION	COMMENT
1	PAIRING MODE	ON to pair with XET-100 – OFF for normal operation
2	LOW POWER	XER-100 must be low power also. Reduces range
3	8.2K/10K MODE	ON for 8.2K or 10K Output. Select appropriate 8.2K or 10K Jumper
4	PULSED MODE	ON for Pulsed Output. Select appropriate Pulsed Jumper
5	AUTO TEST MODE	ON for systems that require auto test on Open cycle (High Security)
6	RESERVED	ALWAYS OFF

9. JUMPERS

12 Volt Sealed Lead Acid (SLA) battery only. Solid GREEN LED indicates battery charging. Momentarily flashing GREEN LED indicates battery is charged and a trickle/conditioning charge is occurring.

PAIRING IN THE FIELD

PAIRING

MORE INFO NEEDED FROM CRAIG

XER-100 OUTPUT JUMPERS

	FUNCTION	COMMENT
1	PULSED ONE	Short for Pulsed Output on Channel 1
2	NORMALLY CLOSED ONE	Short for Normally Closed on Channel 1
3	8.2K ONE	Short for 8.2K on Channel 1
4	10K ONE	Short for 10K on Channel 1
5	PULSED TWO	Short for Pulsed Output on Channel 2
6	NORMALLY CLOSED TWO	Short for Normally Closed on Channel 2
7	8.2K TWO	Short for 8.2K on Channel 2

8	10K TWO	Short for 10K on Channel 2
---	---------	----------------------------

NOTE: Both channels must be programmed as the same output type.

T



11. TROUBLESHOOTING

XRE-100 units are not communicating:

CRAIG TO FILL OUT

WARRANTY

The warranty period of this product is 24 months, beginning from the manufacturing date. During this period, if the product does not operate correctly, due to a defective component, the product will be repaired or replaced at the sole discretion of Transmitter Solutions. This warranty does not extend to the product casing which can be damaged by conditions outside of the control of Transmitter Solutions.

EXCEPT AS SET FORTH ABOVE, TRANSMITTER SOLUTIONS MAKES NO WARRANTIES REGARDING THE GOODS, EXPRESS OR IMPLIED, INCLUDING WARRANTY OF MERCHANTABILITY OR WARRANTY OF FITNESS FOR A PARTICULAR PURPOSE. BUYER MAKES NO RELIANCE ON ANY REPRESENTATION OF TRANSMITTER SOLUTIONS, EXPRESS OR IMPLIED, WITH REGARD TO THE GOODS AND ACCEPTS THEM "AS-IS/WHERE-IS". TRANSMITTER SOLUTIONS SELLS THE GOODS TO BUYER ON CONDITION THAT TRANSMITTER SOLUTIONS WILL HAVE NO LIABILITY OF ANY KIND AS A RESULT OF THE SALE. BUYER AGREES THAT TRANSMITTER SOLUTIONS SHALL HAVE NO LIABILITY FOR DAMAGES OF ANY KIND, WHETHER DIRECT, INCIDENTAL OR CONSEQUENTIAL DAMAGES, INCLUDING INJURIES TO PERSONS OR PROPERTY, TO BUYER, ITS EMPLOYEES OR AGENTS, AS A RESULT OF THE SALE. BUYER ALSO AGREES TO HOLD TRANSMITTER SOLUTIONS HARMLESS FROM ANY CLAIMS BUYER, OR ANY THIRD PARTY, MAY HAVE AS A RESULT OF BUYER'S USE OR DISPOSAL OF THE GOODS. BUYER HAS READ THIS DISCLAIMER AND AGREES WITH ITS TERMS IN CONSIDERATION OF RECEIVING THE GOODS.



PH 866.975.0101 • FX 866.975.0404
www.transmittersolutions.com