

JTW2G45AN3216A100R

Multilayer Chip Antenna

For 2.4GHz Wireless Communication

Features

- ※ Monolithic SMD with small, low-profile and light-weight type.
- ※ Wide bandwidth
- ※ RoHS compliant

Applications

- ※ Bluetooth/Wireless LAN/Home RF
- ※ ISM band 2.4GHz applications

Antenna Type: Chip Antenna

Specifications

Center frequency	2.45GHz
Bandwidth	100MHz(typ.)
Peak gain	1.5dBi(typ.) (XZ-V)
Average Gain	-0.5dBi(typ.) (XZ-V)
VSWR	2(max)
Impedance	50Ω
Power Capacity	2W(max)
Operation temperature	-40 ~ +85 °C
Storage temperature	+5 ~ +35 °C, Humidity 45~75%RH

Terminal Configuration

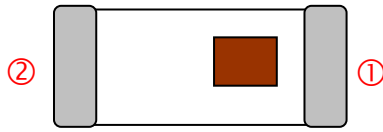

Pin No.	1	2
Pin assignment	Feeding Point	NC

Dimensions and Recommended PC Board Pattern

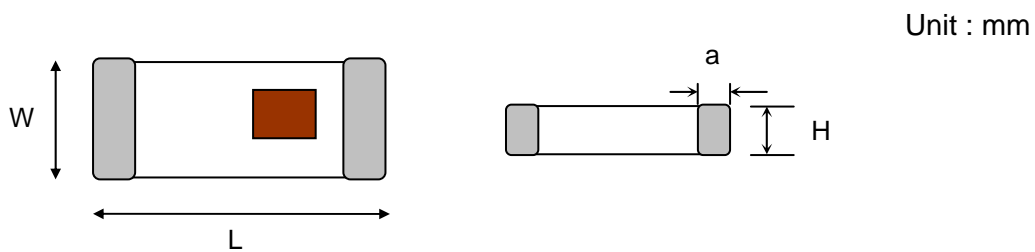

Symbol	L	W	H	a
Dimensions(mm)	3.2±0.2	1.6±0.2	1.3+0.1/-0.2	0.5±0.3

Typical Electrical Characteristics (T=25oC)

※Test Board

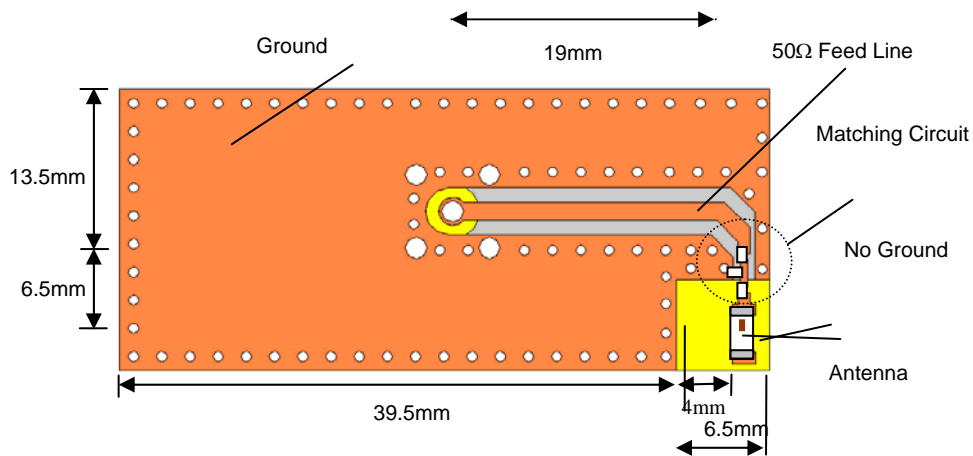

※(a) Without Matching Circuits

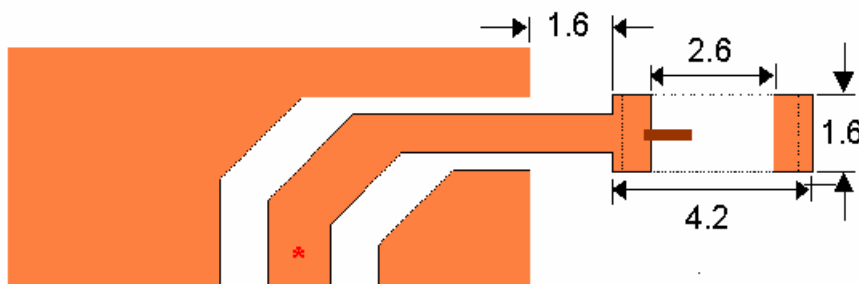

※(b) Without Matching Circuits

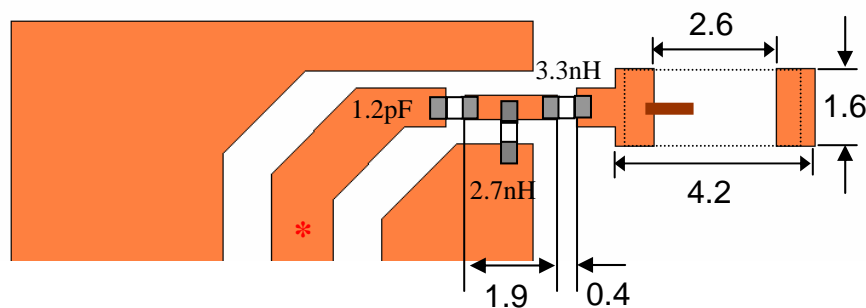

*Line width should be designed to match 50Ω characteristic impedance, depending on PCB material and thickness.

※Return Loss

(a) Without Matching Circuits

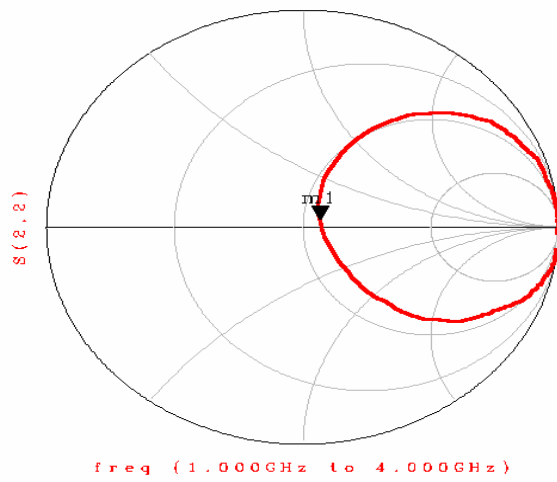
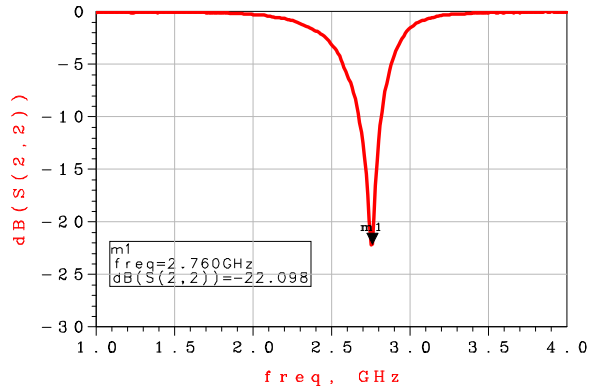

(b) Without Matching Circuits

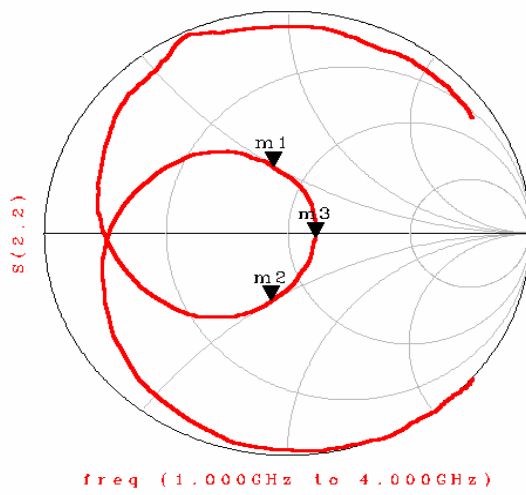
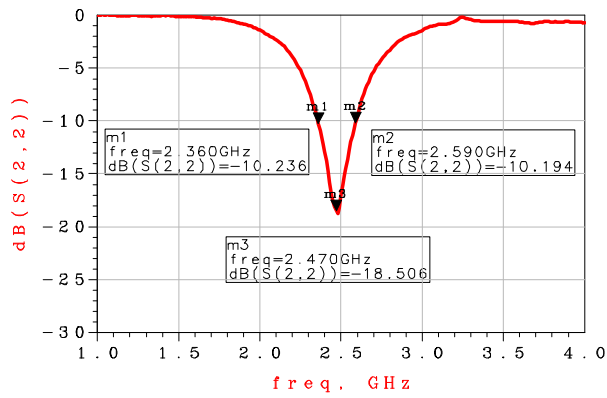

※ Radiation Patterns

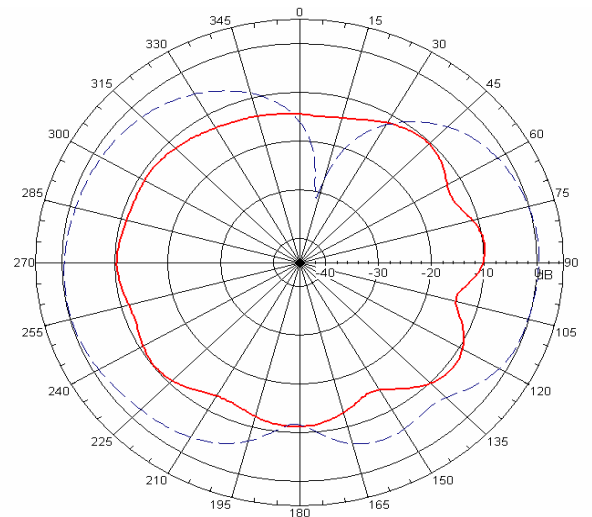
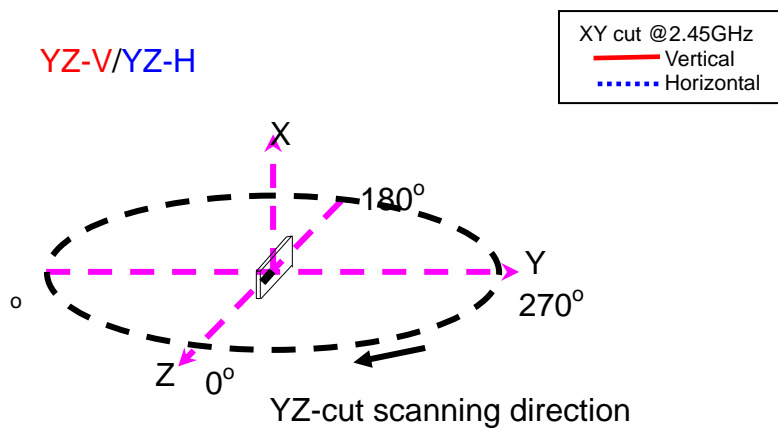
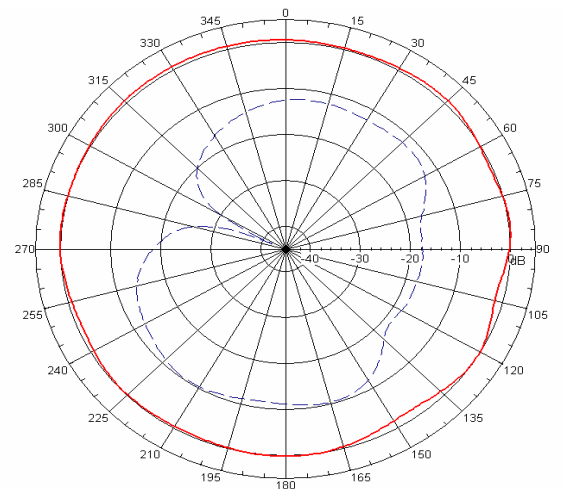
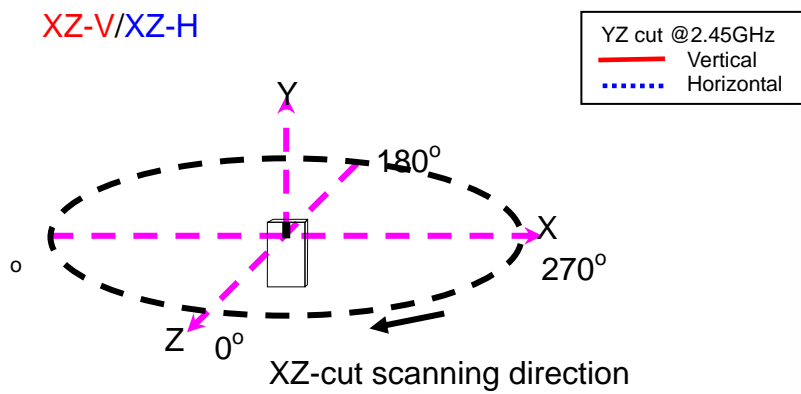
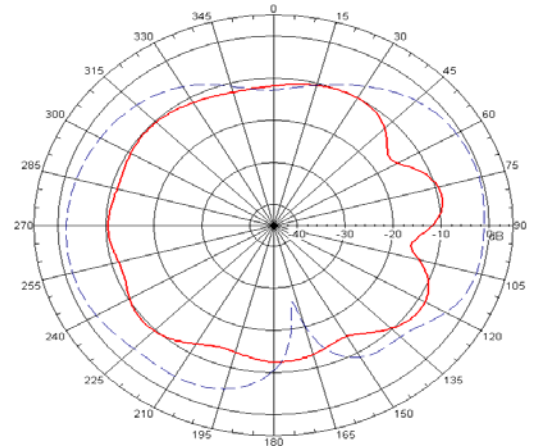
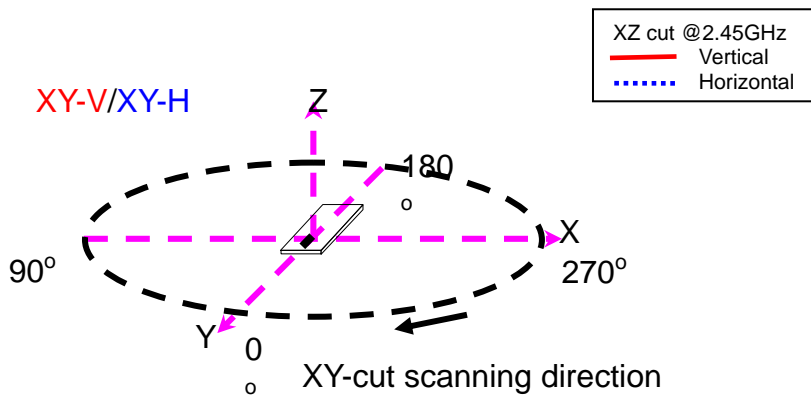

Taping Specifications

※Tape& Dimensions (Unit: mm) vs. Quantity (pcs)

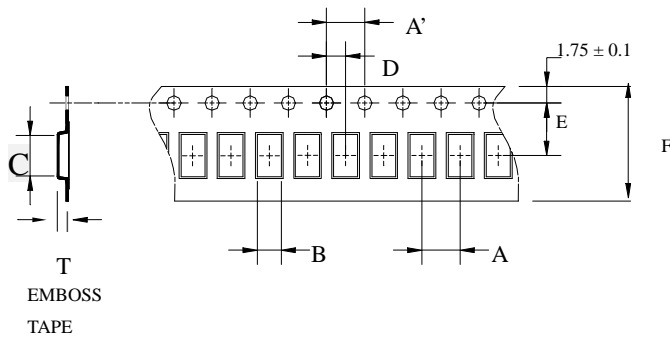

Type	A	A'	B	C	D	E	F	T	Quantity/per reel	Tape material
AN3	4.0 ±	4.0 ±	1.95 ±	3.5 ±	2.0 ±	3.5 ±	8.0 ±	1.5 ±	3000pcs	Plastic (Embossed)
216	0.1	0.05	0.1	0.1	0.05	0.05	0.2	0.1		

※Reel Dimensions (Unit: mm)

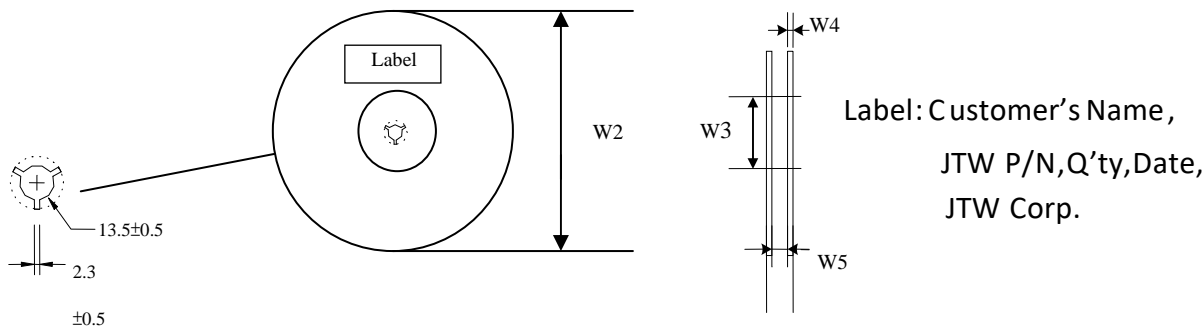

Type	W2	W3	W4	W5
AN3216	178 ± 1	60 ± 1	1.4 ± 0.2	17 ± 0.5

※Leader and Trailer Tape (Plastic material)

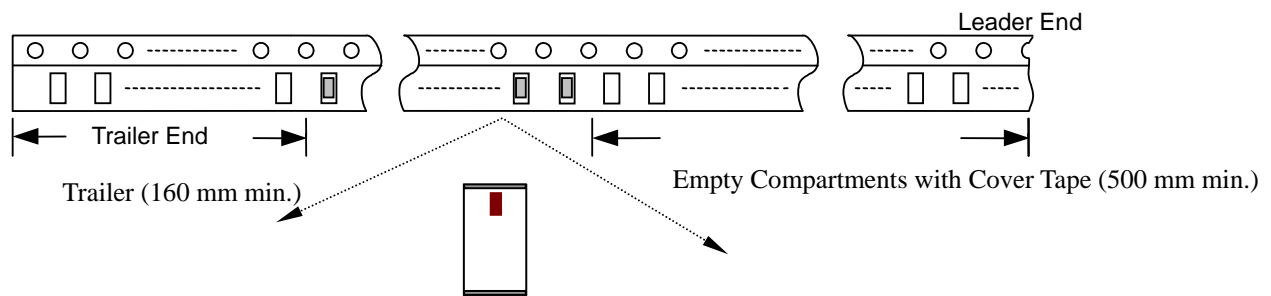

※Peel-off Force

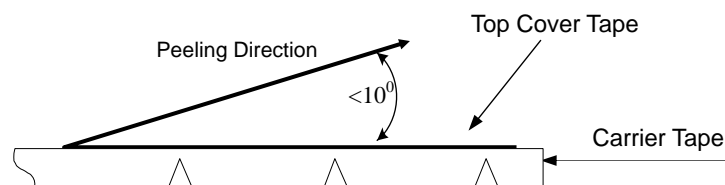

Peel-off force should be in the range of 0.1 – 0.6 N at a peel-off speed of 300 ± 10 mm/min .

※Storage Conditions

- (1) Temperature: 15 ~35°C, relative humidity (RH): 45~75%.
- (2) Non-corrosive environment.

Notes

※The contents of this data sheet are subject to change without notice. Please confirm the specifications and delivery conditions when placing your order.

Mechanical & Environmental Characteristics

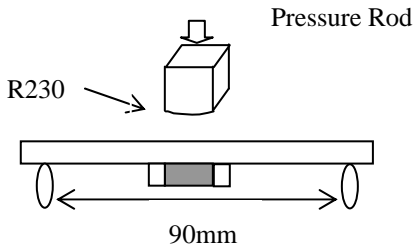
Item	Requirements	Procedure
Solderability	1. No apparent damage 2. More than 95% of the terminal electrode shall be covered with new solder	1. Preheat: $120 \pm 5^{\circ}\text{C}$ 2. Solder: $245 \pm 5^{\circ}\text{C}$ for 5 ± 1 sec
Soldering strength (Termination Adhesion)	1. 1kg minimum	1. Solder specimen onto test jig. 2. Apply push force at 0.5mm/s until electrode pads are peeled off or ceramic are broken. Pushing force is applied to longitude direction
Deflection (Substrate Bending)	1. No apparent damage	1. Solder specimen onto test jig (FR4, 0.8mm) using the recommend soldering profile. 2. Apply a bending force of 2mm deflection 

Heat/Humidity Resistance	<ol style="list-style-type: none"> 1. No apparent damage 2. Fulfill the electrical specification after test 	<ol style="list-style-type: none"> 1. Temperature: $85 \pm 2^{\circ}\text{C}$ 2. Humidity: 90% ~ 95% RH 3. Duration: 1000 ± 48hrs 4. Recovery: 1-2hrs
Thermal shock (Temperature Cycle)	<ol style="list-style-type: none"> 1. No apparent damage 2. Fulfill the electrical specification after test 	<ol style="list-style-type: none"> 1. One cycle/step 1: $125 \pm 5^{\circ}\text{C}$ for 30 min step 2: $-40 \pm 5^{\circ}\text{C}$ for 30 min 2. No of cycles: 100 3. Recovery: 1-2 hrs
Low Temperature Resistance	<ol style="list-style-type: none"> 1. No apparent damage 2. Fulfill the electrical specification after test 	<ol style="list-style-type: none"> 1. Temperature: $-40 \pm 5^{\circ}\text{C}$ 2. Duration: 500 ± 24hrs 3. Recovery: 1-2hrs

Soldering Conditions

※ Typical Soldering Profile for Lead-free Process

Reflow Soldering :

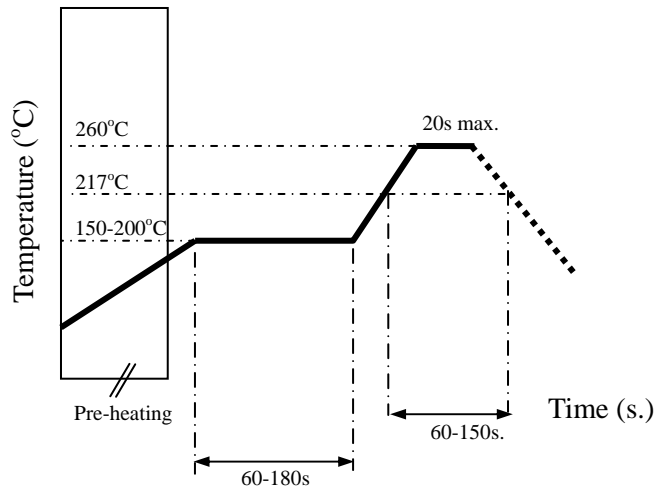

Notes

※ The contents of this data sheet are subject to change without notice. Please confirm the specifications and delivery conditions when placing your order.

Reminders for users of JTW ceramic chip antennas

1. This chip antenna is made of ceramic materials which are relatively more rigid and brittle compared to printed circuit board materials. Bending of circuit board at the locations where chip antenna is mounted may cause the cracking of solder joints or antenna itself.
2. Punching/cutting of the break-off tab of PCB panel may cause severe bending of the circuit board which may result in cracking of solder joints or chip antenna itself. Therefore break-off tab shall be located away from the installation site of chip antenna.
3. Be cautious when ultrasonic welding process needs to be used near the locations where chip antennas are installed. Strong ultrasonic vibration may cause the cracking of chip antenna solder joints.
Presented data were measured on reference PCB (ground) as shown in this specification. When the antenna placement or size of the PCB is changed, antenna performance and values of matching components may differ from data shown here.
4. Information presented in this Reference Specification is believed to be correct as of the date of publishing. JointWel Technologies Corporation reserves the rights to change the Reference Specification without notice due to technical improvements, etc. Please consult with JointWel's engineering team about the latest information before using this product. Per request, we may provide advice and assistance in implementing this antenna to a customer's device by simulation or real measurement of the interested device in our testing facilities.