



中认信通

CHINA CERTIFICATION ICT CO., LTD (DONGGUAN)



TEST REPORT

Applicant: MAXWEST COMMUNICATION LIMITED

Address: FLAT/RM 707 7/F, FORTRESS TOWER 250 KING'S ROAD,NORTH
POINT, HONG KONG

FCC ID: 2ASP8ASTROA65

Product Name: Phone

Standard(s): 47 CFR Part 2, 47 CFR Part 22, Subpart H

47 CFR Part 24, Subpart E

47 CFR Part 27

47 CFR Part 90

ANSI C63.26-2015

KDB 971168 D01 Power Meas License Digital Systems

v03r01

The above equipment has been tested and found compliant with the requirement of the relative standards by China Certification ICT Co., Ltd (Dongguan)

Report Number: CR230636222-00F

Date Of Issue: 2023/7/26

Reviewed By: Calvin Chen

Title: RF Engineer

Approved By: Sun Zhong

Title: Manager

Test Laboratory: China Certification ICT Co., Ltd (Dongguan)

No. 113, Pingkang Road, Dalang Town, Dongguan,
Guangdong, China

Tel: +86-769-82016888

Test Facility

The Test site used by China Certification ICT Co., Ltd (Dongguan) to collect test data is located on the No. 113, Pingkang Road, Dalang Town, Dongguan, Guangdong, China.

The lab has been recognized as the FCC accredited lab under the KDB 974614 D01 and is listed in the FCC Public Access Link (PAL) database, FCC Registration No. : 442868, the FCC Designation No. : CN1314.

The lab has been recognized by Innovation, Science and Economic Development Canada to test to Canadian radio equipment requirements, the CAB identifier: CN0123.

Declarations

China Certification ICT Co., Ltd (Dongguan) is not responsible for the authenticity of any test data provided by the applicant. Data included from the applicant that may affect test results are marked with a triangle symbol “▲”. Customer model name, addresses, names, trademarks etc. are not considered data.

Unless otherwise stated the results shown in this test report refer only to the sample(s) tested.

This report cannot be reproduced except in full, without prior written approval of the Company.

This report is valid only with a valid digital signature. The digital signature may be available only under the Adobe software above version 7.0.

This report may contain data that are not covered by the accreditation scope and shall be marked with an asterisk “★”.

CONTENTS

TEST FACILITY	2
DECLARATIONS.....	2
DOCUMENT REVISION HISTORY	4
1. GENERAL INFORMATION.....	5
1.1 PRODUCT DESCRIPTION FOR EQUIPMENT UNDER TEST (EUT)	5
1.2 DESCRIPTION OF TEST CONFIGURATION.....	6
1.2.2 Support Equipment List and Details	10
1.2.3 Support Cable List and Details	10
1.2.4 Block Diagram of Test Setup.....	10
1.3 MEASUREMENT UNCERTAINTY	11
2. SUMMARY OF TEST RESULTS	12
3. REQUIREMENTS AND TEST PROCEDURES	13
3.1 Applicable Standard For Part 22 Subpart H:.....	13
3.2 Applicable Standard For Part 24 Subpart E:	15
3.3 Applicable Standard For Part 27:.....	16
3.4 Applicable Standard For Part 90:.....	18
3.5 Test Method:.....	19
4. Test DATA AND RESULTS	25
4.1 ANTENNA PORT TEST DATA AND RESULTS FOR GSM 850 BAND:.....	25
4.2 ANTENNA PORT TEST DATA AND RESULTS FOR GSM 1900 BAND:.....	31
4.3 ANTENNA PORT TEST DATA AND RESULTS FOR WCDMA BAND 2:	37
4.4 ANTENNA PORT TEST DATA AND RESULTS FOR WCDMA BAND 4:	44
4.5 ANTENNA PORT TEST DATA AND RESULTS FOR WCDMA BAND 5:.....	51
4.6 ANTENNA PORT TEST DATA AND RESULTS FOR LTE BAND 2.....	58
4.7 ANTENNA PORT TEST DATA AND RESULTS FOR LTE BAND 4.....	79
4.8 ANTENNA PORT TEST DATA AND RESULTS FOR LTE BAND 5.....	100
4.9 ANTENNA PORT TEST DATA AND RESULTS FOR LTE BAND 12.....	116
4.10 ANTENNA PORT TEST DATA AND RESULTS FOR LTE BAND 17.....	132
4.11 ANTENNA PORT TEST DATA AND RESULTS FOR LTE BAND 25.....	142
4.12 ANTENNA PORT TEST DATA AND RESULTS FOR LTE BAND 26.....	165
4.13 ANTENNA PORT TEST DATA AND RESULTS FOR LTE BAND 41.....	199
4.14 ANTENNA PORT TEST DATA AND RESULTS FOR LTE BAND 66.....	215
4.15 ANTENNA PORT TEST DATA AND RESULTS FOR LTE BAND 71.....	236
4.16 RADIATED SPURIOUS EMISSIONS.....	251

DOCUMENT REVISION HISTORY

Revision Number	Report Number	Description of Revision	Date of Revision
1.0	CR230636222-00F	Original Report	2023/7/26

1. GENERAL INFORMATION

1.1 Product Description for Equipment under Test (EUT)

EUT Name:	Phone
EUT Model:	ASTRO A65
Operation Bands and modes:	GSM/GPRS/EDGE: 850/1900 WCDMA: Band 2/4/5 LTE: Band 2/4/5/12/17/25/26/41/66/71
Modulation Type:	GMSK,8PSK, BPSK, QPSK, 16QAM
Rated Input Voltage:	DC 5V from adapter or DC 3.85V from battery
Serial Number:	27A0-1
EUT Received Date:	2023/6/26
EUT Received Status:	Good

Operation Voltage (V_{DC}) ▲:

Lowest:	3.6	Normal:	3.85	Highest:	4.4
---------	-----	---------	------	----------	-----

Transmission Antenna Information ▲:

Antenna Type	Operation Bands	Antenna Frequency Range(MHz)	Antenna Gain (G_r)(dBi)	L_c (dB)
FPC	GSM850	824-849	-0.27	0.2
	PCS1900	1850-1910	0.67	0.3
	WCDMA B2	1850-1910	0.67	0.3
	WCDMA B4	1710-1755	0.58	0.3
	WCDMA B5	824-849	-0.27	0.2
	LTE B2	1850-1910	0.67	0.3
	LTE B4	1710-1755	0.58	0.3
	LTE B5	824-849	-0.27	0.2
	LTE B12	699-716	-0.57	0.1
	LTE B17	704-716	-0.57	0.1
	LTE B25	1850-1915	0.67	0.3
	LTE B26	814-849	-0.27	0.1
	LTE B41	2496-2690	0.88	0.4
	LTE B66	1710-1780	0.58	0.2
LTE B71	663-698	-0.67	0.1	

Note: L_c = Signal Attenuation in the connecting cable between the transmitter and antenna, in dB.

Accessory Information:

Accessory Description	Manufacturer	Model	Specifications
Adapter 1	MAXWEST	ASTRO A65	Input: 100-240V 50/60Hz 0.35A Output: 5.0V=1.5A
Adapter 2	unknown	HJ-0501500-US	Input: 100-240V~50/60Hz 0.3A Output: 5.0V=1.5A 7.5W

1.2 Description of Test Configuration

1.2.1 EUT Operation Condition:

EUT Operation Mode:	The system was configured for testing in each operation mode.
Equipment Modifications:	No
EUT Exercise Software:	No
<p>The maximum power was configured per 3GPP Standard for each operation modes as below setting:</p> <p>GSM/GPRS/EGPRS</p> <p>Function: Menu select > GSM Mobile Station > GSM 850/1900 Press Connection control to choose the different menus Press RESET > choose all the reset all settings Connection Press Signal Off to turn off the signal and change settings Network Support > GSM + GPRS or GSM + EGSM Main Service > Packet Data Service selection > Test Mode A – Auto Slot Config. off MS Signal Press Slot Config Bottom on the right twice to select and change the number of time slots and power setting > Slot configuration > Uplink/Gamma > 33 dBm for GPRS 850 > 30 dBm for GPRS 1900 > 27 dBm for EGPRS 850 > 26 dBm for EGPRS 1900 BS Signal Enter the same channel number for TCH channel (test channel) and BCCH channel Frequency Offset > + 0 Hz Mode > BCCH and TCH BCCH Level > -85 dBm (May need to adjust if link is not stable) BCCH Channel > choose desire test channel [Enter the same channel number for TCH channel (test channel) and BCCH channel] Channel Type > Off P0 > 4 dB Slot Config > Unchanged (if already set under MS signal) TCH > choose desired test channel Hopping > Off Main Timeslot > 3 Network Coding Scheme > CS4 (GPRS) and MCS5 (EGPRS) Bit Stream > 2E9-1 PSR Bit Stream AF/RF Enter appropriate offsets for Ext. Att. Output and Ext. Att. Input Connection Press Signal on to turn on the signal and change settings</p>	

WCDMA

The following tests were conducted according to the test requirements outlines in section 5.2 of the 3GPP TS34.121-1 specification.

	Mode	HSUPA	HSUPA	HSUPA	HSUPA	HSUPA
	Subset	1	2		4	5
WCDMA General Settings	Loopback Mode	Test Mode 1				
	Rel99 RMC	12.2kbps RMC				
	HSDPA FRC	H-Set1				
	HSUPA Test	HSUPA Loopback				
	Power Control Algorithm	Algorithm2				
	β_c	11/15	6/15	15/15	2/15	15/15
	β_d	15/15	15/15	9/15	15/ 5	0
	β_{ec}	209/225	12/15	30 15	2/15	5/15
	β_c/β_d	11/15	6/15	15/9	2/15	-
	β_{hs}	22/15	12/15	30/15	4/15	5/15
CM(dB)	1.0	3.0	2.0	3.0	1.0	
PR(dB)	0	2	1	2	0	
HSDPA Specific Settings	DACK	8				
	DNAK	8				
	DCQI	8				
	Ack-Nack repetition factor	3				
	CQI Feedback	4ms				
	CQI Repetition Factor	2				
	$A_{hs}=\beta_{hs}/\beta_c$	30/15				
HSUPA Specific Settings	DE-DPCCH	6	8	8	5	7
	DHARQ	0	0	0	0	0
	AG Index	20	12	15	17	21
	ETFCI	75	67	92	71	81
	Associated Max UL Data Rate k ps	242.1	174.9	482.8	205.8	308.9
	Reference E_FCI	E-TFCI 11 E E-TFCI PO 4 E-TFCI 67 E-TFCI PO 18 E-TFCI 71 E-TFCI PO23 E-TFCI 75 E-TFCI PO26 E-TFCI 81 E-TFCI PO 27	E-TFCI 11 E-TFCI PO4 E-TFCI 92 E-TFCI PO 18	E-TFCI 11 E E-TFCI PO 4 E-TFCI 67 E-TFCI PO 18 E-TFCI 71 E-TFCI PO23 E-TFCI 75 E-TFCI PO26 E-TFCI 81 E-TFCI PO 27		

LTE (FDD):

The following tests were conducted according to the test requirements in 3GPP TS36.101

The following tests were conducted according to the test requirements outlined in section 6.2 of the 3GPP TS36.101 specification.

UE Power Class: 3 (23 +/- 2dBm). The allowed Maximum Power Reduction (MPR) for the maximum output power due to higher order modulation and transmit bandwidth configuration (resource blocks) is specified in Table 6.2.3-1 of the 3GPP TS36.101.

Table 6.2.3-1: Maximum Power Reduction (MPR) for Power Class 3

Modulation	Channel bandwidth / Transmission bandwidth (RB)						MPR (dB)
	1.4 MHz	3.0 MHz	5 MHz	10 MHz	15 MHz	20 MHz	
QPSK	> 5	> 4	> 8	> 12	> 16	> 18	≤ 1
16 QAM	≤ 5	≤ 4	≤ 8	≤ 12	≤ 16	≤ 18	≤ 1
64 QAM	> 5	> 4	> 8	> 12	> 16	> 18	≤ 2

The allowed A-MPR values specified below in Table 6.2.4.-1 of 3GPP TS36.101 are in addition to the allowed MPR requirements. All the measurements below were performed with A-MPR disabled, by using Network Signaling Value of "NS_01".

Table 6.2.4-1: Additional Maximum Power Reduction (A-MPR)

Network Signalling value	Requirements (sub-clause)	E-UTRA Band	Channel bandwidth (MHz)	Resources Blocks (N_{RB})	A-MPR (dB)
NS_01	6.6.2.1.1	Table 5.5-1	1.4, 3, 5, 10, 15, 20	Table 5.6-1	NA
NS_03	6.6.2.2.1	2, 4, 10, 23, 25, 35, 96	3	>5	≤ 1
			5	>6	≤ 1
			10	>6	≤ 1
			15	>8	≤ 1
			20	>10	≤ 1
NS_04	6.6.2.2.2	41	5	>6	≤ 1
			10, 15, 20	See Table 6.2.4-4	
NS_05	6.6.3.3.1	1	10,15,20	≥ 50	≤ 1
NS_06	6.6.2.2.3	12, 13, 14, 17	1.4, 3, 5, 10	Table 5.6-1	n/a
NS_07	6.6.2.2.3	13	10	Table 6.2.4-2	Table 6.2.4-2
	6.6.3.3.2				
NS_08	6.6.3.3.3	19	10, 15	> 44	≤ 3
NS_09	6.6.3.3.4	21	10, 15	> 40	≤ 1
				> 55	≤ 2
NS_10		20	15, 20	Table 6.2.4-3	Table 6.2.4-3
NS_11	6.6.2.2.1	23 ¹	1.4, 3, 5, 10	Table 6.2.4-5	Table 6.2.4-5
..					
NS_32	-	-	-	-	-

Note 1: Applies to the lower block of Band 23, i.e. a carrier placed in the 2000-2010 MHz region.

LTE(TDD):

Table 4.2-1: Configuration of special subframe (lengths of DwPTS/GP/UpPTS).

Special subframe configuration	Normal cyclic prefix in downlink				Extended cyclic prefix in downlink		
	DwPTS	UpPTS		DwPTS	UpPTS		
		Normal cyclic prefix in uplink	Extended cyclic prefix in uplink		Normal cyclic prefix in uplink	Extended cyclic prefix in uplink	
0	$6592 \cdot T_s$	$2192 \cdot T_s$	$2560 \cdot T_s$	$7680 \cdot T_s$	$2192 \cdot T_s$	$2560 \cdot T_s$	
1	$19760 \cdot T_s$			$20480 \cdot T_s$			
2	$21952 \cdot T_s$			$23040 \cdot T_s$			
3	$24144 \cdot T_s$			$25600 \cdot T_s$			
4	$26336 \cdot T_s$			$7680 \cdot T_s$			
5	$6592 \cdot T_s$	$4384 \cdot T_s$	$5120 \cdot T_s$	$20480 \cdot T_s$	$4384 \cdot T_s$	$5120 \cdot T_s$	
6	$19760 \cdot T_s$			$23040 \cdot T_s$			
7	$21952 \cdot T_s$			$12800 \cdot T_s$			
8	$24144 \cdot T_s$			-			
9	$13168 \cdot T_s$			-			

Table 4.2-2: Uplink-downlink configurations.

Uplink-downlink configuration	Downlink-to-Uplink Switch-point periodicity	Subframe number									
		0	1	2	3	4	5	6	7	8	9
0	5 ms	D	S	U	U	U	D	S	U	U	U
1	5 ms	D	S	U	U	D	D	S	U	U	D
2	5 ms	D	S	U	D	D	D	S	U	D	D
3	10 ms	D	S	U	U	U	D	D	D	D	D
4	10 ms	D	S	U	U	D	D	D	D	D	D
5	10 ms	D	S	U	D	D	D	D	D	D	D
6	5 ms	D	S	U	U	U	D	S	U	U	D

Calculated Duty Cycle

Uplink-Downlink Configuration	Downlink-to-Uplink Switch-point Periodicity	Subframe Number										Calculated Duty Cycle (%)
		0	1	2	3	4	5	6	7	8	9	
0	5 ms	D	S	U	U	U	D	S	U	U	U	63.33
1	5 ms	D	S	U	U	D	D	S	U	U	D	43.33
2	5 ms	D	S	U	D	D	D	S	U	D	D	23.33
3	10 ms	D	S	U	U	U	D	D	D	D	D	31.67
4	10 ms	D	S	U	U	D	D	D	D	D	D	21.67
5	10 ms	D	S	U	D	D	D	D	D	D	D	11.67
6	5 ms	D	S	U	U	U	D	S	U	U	D	53.33

Calculated Duty Cycle = Extended cyclic prefix in uplink x (T_s) x # of S + # of U

Example for Calculated Duty Cycle for Uplink-Downlink Configuration 0:
 Calculated Duty Cycle = $5120 \times [1/(15000 \times 2048)] \times 2 + 6 \text{ ms} = 63.33\%$
 where
 T_s = 1/(15000 x 2048) seconds

1.2.2 Support Equipment List and Details

Manufacturer	Description	Model	Serial Number
IPRO	Earphone	Phonenix 5.0s	EP221126001

1.2.3 Support Cable List and Details

Cable Description	Shielding Type	Ferrite Core	Length (m)	From Port	To
Earphone Cable	NO	NO	0.8	EUT	Earphone Cable

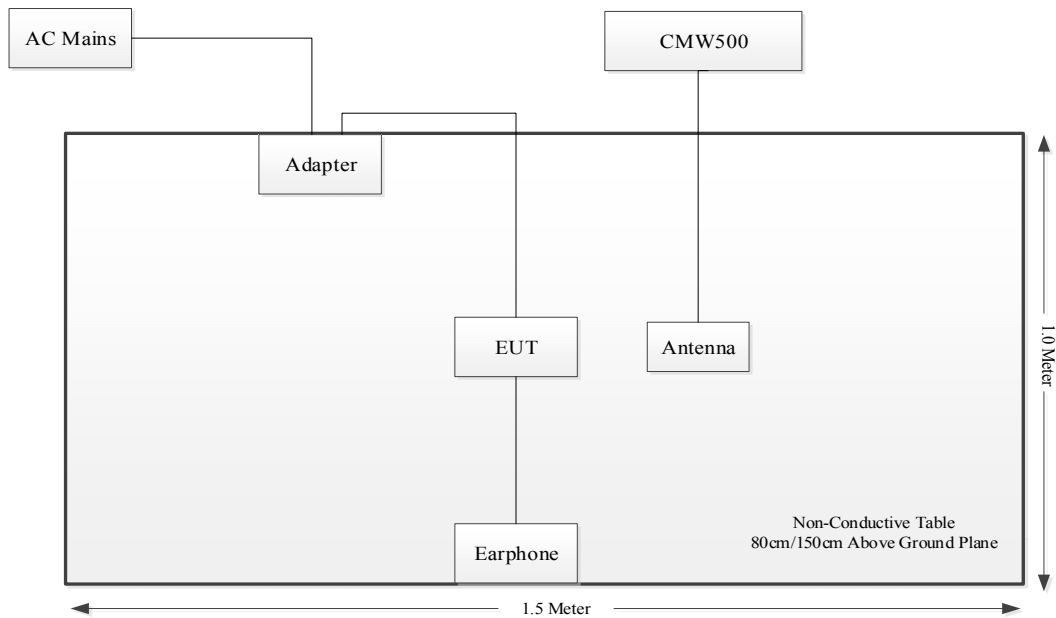
1.2.4 Block Diagram of Test Setup

1.3 Measurement Uncertainty

Otherwise required by the applicant or Product Regulations, Decision Rule in this report did not consider the uncertainty. The extended uncertainty given in this report is obtained by combining the standard uncertainty times the coverage factor K with the 95% confidence interval.

Parameter	Measurement Uncertainty
Occupied Channel Bandwidth	±5 %
RF output power, conducted	±0.61dB
Power Spectral Density, conducted	±0.61 dB
Unwanted Emissions, radiated	30M~200MHz: 4.15 dB,200M~1GHz: 5.61 dB,1G~6GHz: 5.14 dB, 6G~18GHz: 5.93 dB,18G~26.5G:5.47 dB,26.5G~40G:5.63 dB
Unwanted Emissions, conducted	±1.26 dB
Temperature	±1 °C
Humidity	±5%
DC and low frequency voltages	±0.4%
Duty Cycle	1%
RF Frequency	±0.082×10 ⁻⁶

2. SUMMARY OF TEST RESULTS

Rules	Description of Test	Result
FCC§2.1046; § 22.913; § 24.232; §27.50; §90.635	RF Output Power	Compliant
FCC§ 2.1047	Modulation Characteristics	Not Applicable
FCC§ 2.1049; § 22.905; § 22.917; § 24.238; §27.53; §90.209	Occupied Bandwidth	Compliant
FCC§ 2.1051; § 22.917; § 24.238; §27.53; §90.691	Spurious Emissions at Antenna Terminal	Compliant
FCC§ 22.917; § 24.238; §27.53; §90.691	Out of band emission, Band Edge	Compliant
FCC§ 2.1055; § 22.355; § 24.235; §27.54; §90.213	Frequency stability vs. temperature Frequency stability vs. voltage	Compliant
FCC§ 2.1053; § 22.917; § 24.238; §27.53; §90.691	Field Strength of Spurious Radiation	Compliant

3. REQUIREMENTS AND TEST PROCEDURES

3.1 Applicable Standard For Part 22 Subpart H:

3.1.1 RF Output Power

FCC §22.913

(a)(5) The ERP of mobile transmitters and auxiliary test transmitters must not exceed 7watts.

(d) *Power measurement.* Measurement of the ERP of Cellular base transmitters and repeaters must be made using an average power measurement technique. The peak-toaverage ratio (PAR) of the transmission must not exceed 13 dB. Power measurements for base transmitters and repeaters must be made in accordance with either of the following:

- (1) A Commission-approved average power technique (*see* FCC Laboratory's Knowledge Database); or
- (2) For purposes of this section, peak transmit power must be measured over an interval of continuous transmission using instrumentation calibrated in terms of an rmsequivalent voltage. The measurement results shall be properly adjusted for any instrument limitations, such as detector response times, limited resolution bandwidth capability when compared to the emission bandwidth, sensitivity, *etc.*, so as to obtain a true peak measurement for the emission in question over the full bandwidth of the channel.

3.1.2 Spurious Emissions

FCC §22.917

(a) Out of band emissions. The power of any emission outside of the authorized operating frequency ranges must be attenuated below the transmitting power (P) by a factor of at least $43 + 10 \log(P)$ dB.

(b) Measurement procedure. Compliance with these rules is based on the use of measurement instrumentation employing a reference bandwidth as follows:

- (1) In the spectrum below 1 GHz, instrumentation should employ a reference bandwidth of 100 kHz or greater. In the 1 MHz bands immediately outside and adjacent to the frequency block, a resolution bandwidth of at least one percent of the emission bandwidth of the fundamental emission of the transmitter may be employed. A narrower resolution bandwidth is permitted in all cases to improve measurement accuracy, provided that the measured power is integrated over the full required reference bandwidth (i.e., 100 kHz or 1 percent of emission bandwidth, as specified). The emission bandwidth is defined as the width of the signal between two points, one below the carrier center frequency and one above the carrier center frequency, outside of which all emissions are attenuated at least 26 dB below the transmitter power.
- (2) In the spectrum above 1 GHz, instrumentation should employ a reference bandwidth of 1 MHz

3.1.3 Frequency stability

FCC §22.355

Except as otherwise provided in this part, the carrier frequency of each transmitter in the Public Mobile Services must be maintained within the tolerances given in Table C-1 of this section.

Table C-1 - Frequency Tolerance for Transmitters in the Public Mobile Services

Frequency range (MHz)	Base, fixed (ppm)	Mobile >3 watts (ppm)	Mobile \leq3 watts (ppm)
25 to 50	20	20	50
50 to 450	5	5	50
450 to 512	2.5	5	5
821 to 896	1.5	2.5	2.5
928 to 929	5	n/a	n/a
929 to 960	1.5	n/a	n/a
2110 to 2220	10	n/a	n/a

3.2 Applicable Standard For Part 24 Subpart E:

3.2.1 RF Output Power

FCC §24.232

(c) Mobile and portable stations are limited to 2 watts EIRP and the equipment must employ a means for limiting power to the minimum necessary for successful communications.

(d) Power measurements for transmissions by stations authorized under this section may be made either in accordance with a Commission-approved average power technique or in compliance with paragraph (e) of this section. In both instances, equipment employed must be authorized in accordance with the provisions of § 24.51. In measuring transmissions in this band using an average power technique, the peak-to-average ratio (PAR) of the transmission may not exceed 13 dB.

3.2.2 Spurious Emissions

FCC §24.238

The rules in this section govern the spectral characteristics of emissions in the Broadband Personal Communications Service.

(a) Out of band emissions. The power of any emission outside of the authorized operating frequency ranges must be attenuated below the transmitting power (P) by a factor of at least $43 + 10 \log(P)$ dB.

(b) Measurement procedure. Compliance with these rules is based on the use of measurement instrumentation employing a resolution bandwidth of 1 MHz or greater. However, in the 1 MHz bands immediately outside and adjacent to the frequency block a resolution bandwidth of at least one percent of the emission bandwidth of the fundamental emission of the transmitter may be employed. A narrower resolution bandwidth is permitted in all cases to improve measurement accuracy provided the measured power is integrated over the full required measurement bandwidth (i.e. 1 MHz or 1 percent of emission bandwidth, as specified). The emission bandwidth is defined as the width of the signal between two points, one below the carrier center frequency and one above the carrier center frequency, outside of which all emissions are attenuated at least 26 dB below the transmitter power.

(c) Alternative out of band emission limit. Licensees in this service may establish an alternative out of band emission limit to be used at specified band edge(s) in specified geographical areas, in lieu of that set forth in this section, pursuant to a private contractual arrangement of all affected licensees and applicants. In this event, each party to such contract shall maintain a copy of the contract in their station files and disclose it to prospective assignees or transferees and, upon request, to the FCC.

(d) Interference caused by out of band emissions. If any emission from a transmitter operating in this service results in interference to users of another radio service, the FCC may require a greater attenuation of that emission than specified in this section.

3.2.3 Frequency stability

FCC §24.235

The frequency stability shall be sufficient to ensure that the fundamental emission stays within the authorized frequency block.

3.3 Applicable Standard For Part 27:

3.3.1 RF Output Power

FCC §27.50

(a)(3) *Mobile and portable stations.*

(i) For mobile and portable stations transmitting in the 2305-2315 MHz band or the 2350-2360 MHz band, the average EIRP must not exceed 50 milliwatts within any 1 megahertz of authorized bandwidth, *except that* for mobile and portable stations compliant with 3GPP LTE standards or another advanced mobile broadband protocol that avoids concentrating energy at the edge of the operating band the average EIRP must not exceed 250 milliwatts within any 5 megahertz of authorized bandwidth but may exceed 50 milliwatts within any 1 megahertz of authorized bandwidth. For mobile and portable stations using time division duplexing (TDD) technology, the duty cycle must not exceed 38 percent in the 2305-2315 MHz and 2350-2360 MHz bands. Mobile and portable stations using FDD technology are restricted to transmitting in the 2305-2315 MHz band. Power averaging shall not include intervals in which the transmitter is off.

(ii) Mobile and portable stations are not permitted to transmit in the 2315-2320 MHz and 2345-2350 MHz bands.

(iii) *Automatic transmit power control.* Mobile and portable stations transmitting in the 2305-2315 MHz band or in the 2350-2360 MHz band must employ automatic transmit power control when operating so the stations operate with the minimum power necessary for successful communications.

(iv) *Prohibition on external vehicle-mounted antennas.* The use of external vehicle-mounted antennas for mobile and portable stations transmitting in the 2305-2315 MHz band or the 2350-2360 MHz band is prohibited.

(b)(10) Portable stations (hand-held devices) transmitting in the 746-757 MHz, 776-788 MHz, and 805-806 MHz bands are limited to 3 watts ERP.

(c)(10) Portable stations (hand-held devices) in the 600 MHz uplink band and the 698-746 MHz band, and fixed and mobile stations in the 600 MHz uplink band are limited to 3 watts ERP.

(d)(4) Fixed, mobile, and portable (hand-held) stations operating in the 1710-1755 MHz band and mobile and portable stations operating in the 1695-1710 MHz and 1755-1780 MHz bands are limited to 1 watt EIRP. Fixed stations operating in the 1710-1755 MHz band are limited to a maximum antenna height of 10 meters above ground. Mobile and portable stations operating in these bands must employ a means for limiting power to the minimum necessary for successful communications.

(h) The following power limits shall apply in the BRS and EBS:

(2) Mobile and other user stations. Mobile stations are limited to 2.0 watts EIRP. All user stations are limited to 2.0 watts transmitter output power.

3.3.2 Spurious Emissions

FCC §27.53

(a) For operations in the 2305-2320 MHz band and the 2345-2360 MHz band, the power of any emission outside a licensee's frequency band(s) of operation shall be attenuated below the transmitter power P (with averaging performed only during periods of transmission) within the licensed band(s) of operation, in watts, by the following amounts:

(4) For mobile and portable stations operating in the 2305-2315 MHz and 2350-2360 MHz bands:

(i) By a factor of not less than: $43 + 10 \log (P)$ dB on all frequencies between 2305 and 2320 MHz and on all frequencies between 2345 and 2360 MHz that are outside the licensed band(s) of operation, not less than $55 + 10 \log (P)$ dB on all frequencies between 2320 and 2324 MHz and on all frequencies between 2341 and 2345 MHz, not less than $61 + 10 \log (P)$ dB on all frequencies between 2324 and 2328 MHz and on all frequencies between 2337 and 2341 MHz, and not less than $67 + 10 \log (P)$ dB on all frequencies between 2328 and 2337 MHz;

(ii) By a factor of not less than $43 + 10 \log (P)$ dB on all frequencies between 2300 and 2305 MHz, $55 + 10 \log (P)$ dB on all frequencies between 2296 and 2300 MHz, $61 + 10 \log (P)$ dB on all frequencies between 2292 and 2296 MHz, $67 + 10 \log (P)$ dB on all frequencies between 2288 and 2292 MHz, and $70 + 10 \log (P)$ dB below 2288 MHz;

(iii) By a factor of not less than $43 + 10 \log (P)$ dB on all frequencies between 2360 and 2365 MHz, and not less than $70 + 10 \log (P)$ dB above 2365 MHz.

(c) For operations in the 746-758 MHz band and the 776-788 MHz band, the power of any emission outside the licensee's frequency band(s) of operation shall be attenuated below the transmitter power (P) within the licensed band(s) of operation, measured in watts, in accordance with the following:

(1) On any frequency outside the 746-758 MHz band, the power of any emission shall be attenuated outside the band below the transmitter power (P) by at least $43 + 10 \log (P)$ dB;

(2) On any frequency outside the 776-788 MHz band, the power of any emission shall be attenuated outside the band below the transmitter power (P) by at least $43 + 10 \log (P)$ dB;

(3) On all frequencies between 763-775 MHz and 793-805 MHz, by a factor not less than $76 + 10 \log (P)$ dB in a 6.25 kHz band segment, for base and fixed stations;

(4) On all frequencies between 763-775 MHz and 793-805 MHz, by a factor not less than $65 + 10 \log (P)$ dB in a 6.25 kHz band segment, for mobile and portable stations;

(5) Compliance with the provisions of paragraphs (c)(1) and (c)(2) of this section is based on the use of measurement instrumentation employing a resolution bandwidth of 100 kHz or greater. However, in the 100 kHz bands immediately outside and adjacent to the frequency block, a resolution bandwidth of at least 30 kHz may be employed;

(6) Compliance with the provisions of paragraphs (c)(3) and (c)(4) of this section is based on the use of measurement instrumentation such that the reading taken with any resolution bandwidth setting should be adjusted to indicate spectral energy in a 6.25 kHz segment.

(f) For operations in the 746-758 MHz, 775-788 MHz, and 805-806 MHz bands, emissions in the band 1559-1610 MHz shall be limited to - 70 dBW/MHz equivalent isotropically radiated power (EIRP) for wideband signals, and - 80 dBW EIRP for discrete emissions of less than 700 Hz bandwidth. For the purpose of equipment authorization, a transmitter shall be tested with an antenna that is representative of the type that will be used with the equipment in normal operation.

(g) For operations in the 600 MHz band and the 698-746 MHz band, the power of any emission outside a licensee's frequency band(s) of operation shall be attenuated below the transmitter power (P) within the licensed band(s) of operation, measured in watts, by at least $43 + 10 \log (P)$ dB. Compliance with this provision is based on the use of measurement instrumentation employing a resolution bandwidth of 100 kilohertz or greater. However, in the 100 kilohertz bands immediately outside and adjacent to a licensee's frequency block, a resolution bandwidth of at least 30 kHz may be employed.

(h) AWS emission limits

(1) **General protection levels.** Except as otherwise specified below, for operations in the 1695-1710 MHz, 1710-1755 MHz, 1755-1780 MHz, 1915-1920 MHz, 1995-2000 MHz, 2000-2020 MHz, 2110-2155 MHz, 2155-2180 MHz, and 2180-2200 bands, the power of any emission outside a licensee's frequency block shall be attenuated below the transmitter power (P) in watts by at least $43 + 10 \log_{10} (P)$ dB.

(m)(4) For mobile digital stations, the attenuation factor shall be not less than $40 + 10 \log (P)$ dB on all frequencies between the channel edge and 5 megahertz from the channel edge, $43 + 10 \log (P)$ dB on all frequencies between 5 megahertz and X megahertz from the channel edge, and $55 + 10 \log (P)$ dB on all frequencies more than X megahertz from the channel edge, where X is the greater of 6 megahertz or the actual emission bandwidth as defined in paragraph (m)(6) of this section. In addition, the attenuation factor shall not be less than $43 + 10 \log (P)$ dB on all frequencies between 2490.5 MHz and 2496 MHz and $55 + 10 \log (P)$ dB at or below 2490.5 MHz. Mobile Satellite Service licensees operating on frequencies below 2495 MHz may also submit a documented interference complaint against BRS licensees operating on channel BRS Channel 1 on the same terms and conditions as adjacent channel BRS or EBS licensees.

3.3.3 Frequency stability

FCC §27.54

The frequency stability shall be sufficient to ensure that the fundamental emissions stay within the authorized bands of operation.

3.4 Applicable Standard For Part 90:

3.4.1 RF Output Power

FCC §90.635

(b) The maximum output power of the transmitter for mobile stations is 100 watts (20 dBw).

3.4.2 Spurious Emissions

FCC §90.691

(a) Out-of-band emission requirement shall apply only to the “outer” channels included in an EA license and to spectrum adjacent to interior channels used by incumbent licensees. The emission limits are as follows:

(1) For any frequency removed from the EA licensee's frequency block by up to and including 37.5 kHz, the power of any emission shall be attenuated below the transmitter power (P) in watts by at least $116 \text{Log}_{10}(f/6.1)$ decibels or $50 + 10 \text{Log}_{10}(P)$ decibels or 80 decibels, whichever is the lesser attenuation, where f is the frequency removed from the center of the outer channel in the block in kilohertz and where f is greater than 12.5 kHz.

(2) For any frequency removed from the EA licensee's frequency block greater than 37.5 kHz, the power of any emission shall be attenuated below the transmitter power (P) in watts by at least $43 + 10 \text{Log}_{10}(P)$ decibels or 80 decibels, whichever is the lesser attenuation, where f is the frequency removed from the center of the outer channel in the block in kilohertz and where f is greater than 37.5 kHz.

(b) When an emission outside of the authorized bandwidth causes harmful interference, the Commission may, at its discretion, require greater attenuation than specified in this section.

3.5 Test Method:

3.5.1 Transmitter output power, e.r.p. and e.i.r.p

According to CFR Part 2.1046, ANSI C63.26-2015 Section 5.2.5.5 and KDB 971168 D01 Power Meas License Digital Systems v03r01:

The relevant equation for determining the ERP or EIRP from the conducted RF output power measured using the guidance provided above is:

$$\text{ERP or EIRP} = P_{\text{Meas}} + G_T - L_C$$

where:

ERP or EIRP = effective radiated power or equivalent isotropically radiated power, respectively
(expressed in the same units as P_{Meas} , typically dBW or dBm);

P_{Meas} = measured transmitter output power or PSD, in dBm or dBW;

G_T = gain of the transmitting antenna, in dBd (ERP) or dBi (EIRP);

L_C = signal attenuation in the connecting cable between the transmitter and antenna, in dB.

Test Setup Block:

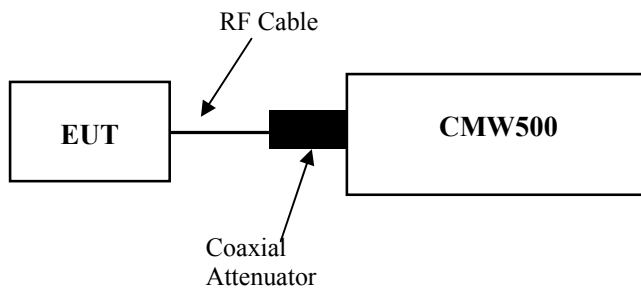

Note: The Insertion loss of the RF cable and coaxial Attenuator was offset into the Reading of CMW500.

3.5.2 Occupied Bandwidth

According to ANSI C63.26-2015 Section 5.4.4

The OBW is the frequency bandwidth such that, below its lower and above its upper frequency limits, the mean powers are each equal to 0.5% of the total mean power of the given emission.

The following procedure shall be used for measuring (99%) power bandwidth:

a) The spectrum analyzer center frequency is set to the nominal EUT channel center frequency. The frequency span for the spectrum analyzer shall be set wide enough to capture all modulation products including the emission skirts (typically a span of $1.5 \times \text{OBW}$ is sufficient).

b) The nominal IF filter 3 dB bandwidth (RBW) shall be in the range of 1% to 5% of the anticipated OBW, and the VBW shall be set $\geq 3 \times \text{RBW}$.

c) Set the reference level of the instrument as required to prevent the signal amplitude from exceeding the maximum spectrum analyzer input mixer level for linear operation. See guidance provided in 4.2.3. NOTE—Step a), step b), and step c) may require iteration to adjust within the specified tolerances.

d) Set the detection mode to peak, and the trace mode to max-hold.

e) If the instrument does not have a 99% OBW function, recover the trace data points and sum directly in linear power terms. Place the recovered amplitude data points, beginning at the lowest frequency, in a running sum until 0.5% of the total is reached. Record that frequency as the lower OBW frequency. Repeat the process until 99.5% of the total is reached and record that frequency as the upper OBW frequency. The 99% power OBW can be determined by computing the difference these two frequencies.

f) The OBW shall be reported and plot(s) of the measuring instrument display shall be provided with the test report. The frequency and amplitude axis and scale shall be clearly labeled. Tabular data can be reported in addition to the plot(s).

Test Setup Block:

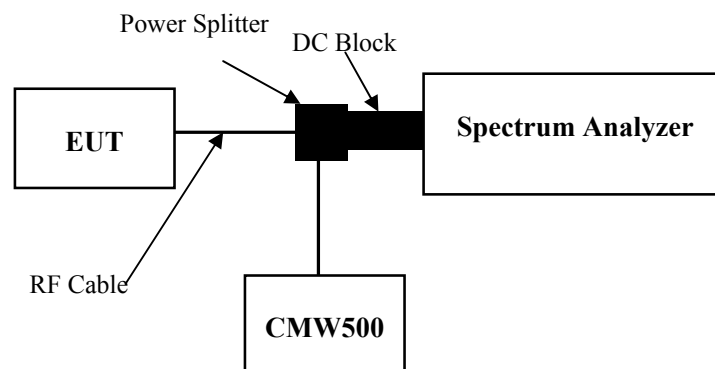

3.5.3 Transmitter unwanted emissions-at antenna terminals

According to ANSI C63.26-2015 Section 5.7.4, KDB 971168 D01 Power Meas License Digital Systems v03r01:

the applicable rule part specifies the reference bandwidth for measuring unwanted emission levels (typically, 100 kHz if the authorized frequency band/block is at or below 1 GHz and 1 MHz if the authorized frequency band/block is above 1 GHz),⁸ effectively depicting the unwanted emission limit in terms of a power spectral density. In those cases where no reference bandwidth is explicitly specified, the values in the preceding sentence should be used.

Test Setup Block:

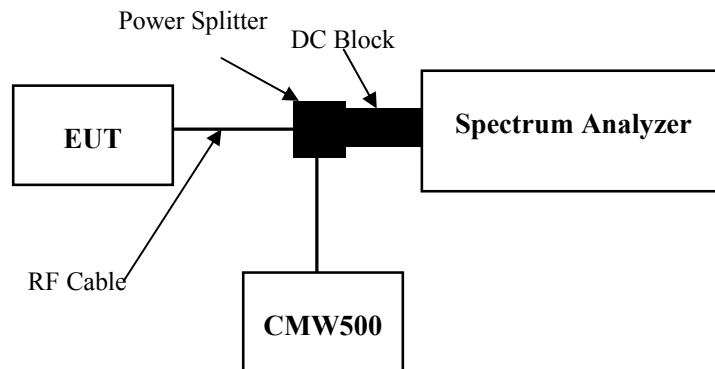

3.5.4 Transmitter unwanted emissions-Out of band emission

According to ANSI C63.26-2015 Section 5.7.3, KDB 971168 D01 Power Meas License Digital Systems v03r01:

Typically, a measurement (resolution) bandwidth smaller than the reference bandwidth is allowed for measurements within a specified frequency range at the edge of the authorized frequency block/band (e.g., within the first Y MHz outside of the authorized frequency band/block, where the value of Y is specified in the relevant rule part). Some FCC out-of-band emission rules permit the use of a narrower RBW (typically limited to a minimum RBW of 1 % of the OBW) for measuring the out-of-band emissions without a requirement to integrate the result over the full reference bandwidth. Beyond the specified frequency range in which this relaxation of the uniform reference bandwidth is permitted, it typically is also acceptable to use a narrower RBW (again limited to a minimum of 1 % of OBW) to increase accuracy, but the measurement result must subsequently be integrated over the full reference bandwidth.

Test Setup Block:

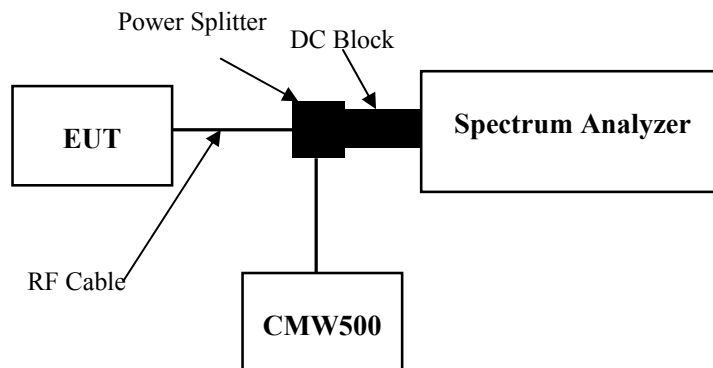

3.5.5 Frequency stability

According to ANSI C63.26-2015 Section 5.6, KDB 971168 D01 Power Meas License Digital Systems v03r01:

Frequency stability is a measure of the frequency drift due to temperature and supply voltage variations, with reference to the frequency measured at +20 °C and rated supply voltage.

The operating carrier frequency shall be set up in accordance with the manufacturer's published operation and instruction manual prior to the commencement of these tests. No adjustment of any frequency determining circuit element shall be made subsequent to this initial set-up. Frequency stability is tested:

- a) At 10 °C intervals of temperatures between –30 °C and +50 °C at the manufacturer's rated supply voltage, and
- b) At +20 °C temperature and ±15% supply voltage variations. If a product is specified to operate over a range of input voltage then the –15% variation is applied to the lowermost voltage and the +15% is applied to the uppermost voltage.

During the test all necessary settings, adjustments and control of the EUT have to be performed without disturbing the test environment, i.e., without opening the environmental chamber. The frequency stabilities can be maintained to a lesser temperature range provided that the transmitter is automatically inhibited from operating outside the lesser temperature range. For handheld equipment that is only capable of operating from internal batteries and the supply voltage cannot be varied, the frequency stability tests shall be performed at the nominal battery voltage and the battery end point voltage specified by the manufacturer. An external supply voltage can be used and set at the internal battery nominal voltage, and again at the battery operating end point voltage which shall be specified by the equipment manufacturer.

If an unmodulated carrier is not available, the mean frequency of a modulated carrier can be obtained by using a frequency counter with gating time set to an appropriately large multiple of bit periods (gating time depending on the required accuracy). Full details on the choice of values shall be included in the test report.

Test Setup Block:

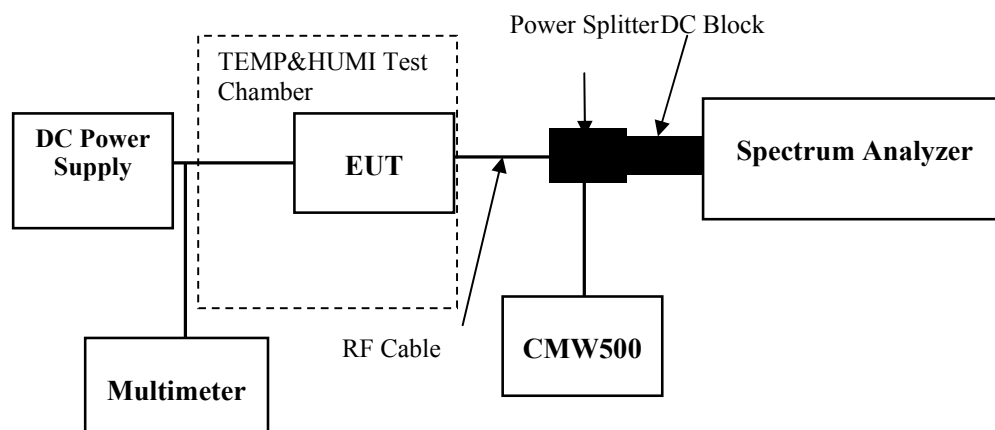

3.5.6 Transmitter unwanted emissions- Radiated Spurious emissions

According to ANSI C63.26-2015 Section 5.5.3:

Test setup:

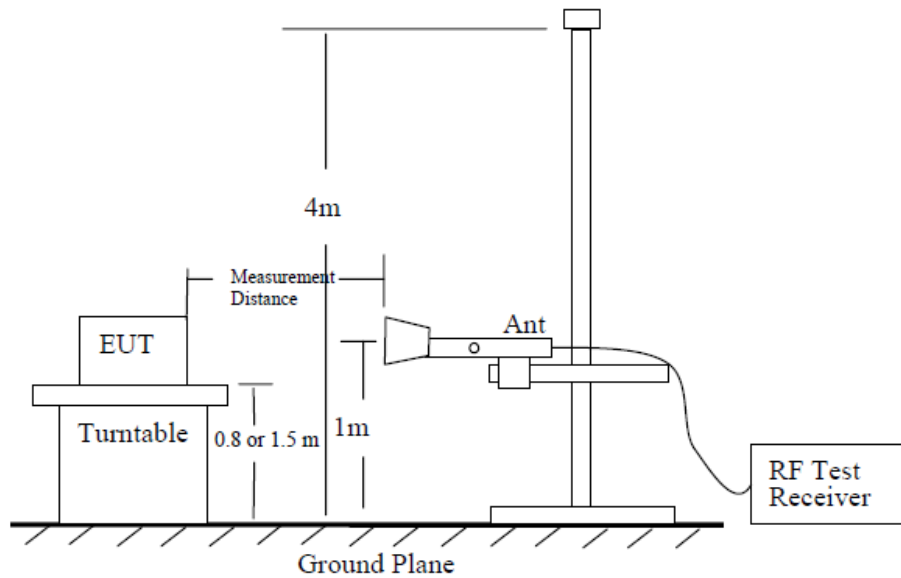

Figure 6—Test site-up for radiated ERP and/or EIRP measurements

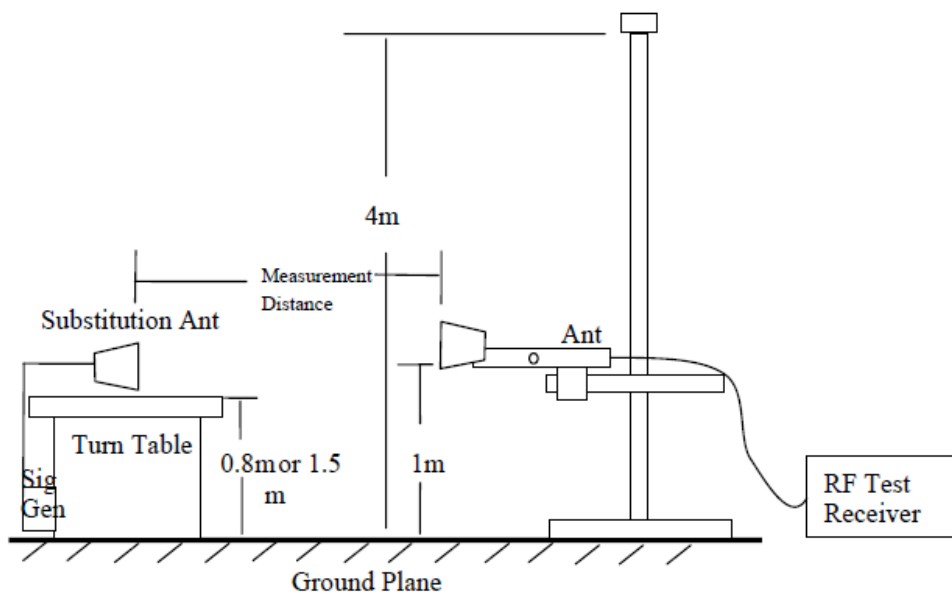

Figure 7—Substitution method set-up for radiated emission

Test Procedure:

- a) Place the EUT in the center of the turntable. The EUT shall be configured to transmit into the standard non-radiating load (for measuring radiated spurious emissions), connected with cables of minimal length unless specified otherwise. If the EUT uses an adjustable antenna, the antenna shall be positioned to the length that produces the worst case emission at the fundamental operating frequency.
- b) Each emission under consideration shall be evaluated:
 - 1) Raise and lower the measurement antenna in accordance 5.5.2, as necessary to enable detection of the maximum emission amplitude relative to measurement antenna height.
 - 2) Rotate the EUT through 360° to determine the maximum emission level relative to the axial position.
 - 3) Return the turntable to the azimuth where the highest emission amplitude level was observed.
 - 4) Vary the measurement antenna height again through 1 m to 4 m again to find the height associated with the maximum emission amplitude.
 - 5) Record the measured emission amplitude level and frequency using the appropriate RBW.
- c) Repeat step b) for each emission frequency with the measurement antenna oriented in both the horizontal and vertical polarizations to determine the orientation that gives the maximum emissions amplitude.
- d) Set-up the substitution measurement with the reference point of the substitution antenna located as near as possible to where the center of the EUT radiating element was located during the initial EUT measurement.
- e) Maintain the previous measurement instrument settings and test set-up, with the exception that the EUT is removed and replaced by the substitution antenna.
- f) Connect a signal generator to the substitution antenna; locate the signal generator so as to minimize any potential influences on the measurement results. Set the signal generator to the frequency where emissions are detected, and set an output power level such that the radiated signal can be detected by the measurement instrument, with sufficient dynamic range relative to the noise floor.
- g) For each emission that was detected and measured in the initial test [i.e., in step b) and step c)]:
 - 1) Vary the measurement antenna height between 1 m to 4 m to maximize the received (measured) signal amplitude.
 - 2) Adjust the signal generator output power level until the amplitude detected by the measurement instrument equals the amplitude level of the emission previously measured directly in step b) and step c).
 - 3) Record the output power level of the signal generator when equivalence is achieved in step 2).
- h) Repeat step e) through step g) with the measurement antenna oriented in the opposite polarization.
- i) Calculate the emission power in dBm referenced to a half-wave dipole using the following equation:

$$P_e = P_s(\text{dBm}) - \text{cable loss (dB)} + \text{antenna gain (dBd)}$$
 where
 - P_e = equivalent emission power in dBm
 - P_s = source (signal generator) power in dBm
 NOTE—dBd refers to the measured antenna gain in decibels relative to a half-wave dipole.
- j) Correct the antenna gain of the substitution antenna if necessary to reference the emission power to a half-wave dipole. When using measurement antennas with the gain specified in dBi, the equivalent dipole-referenced gain can be determined from: $\text{gain (dBd)} = \text{gain (dBi)} - 2.15 \text{ dB}$. If necessary, the antenna gain can be calculated from calibrated antenna factor information
- k) Provide the complete measurement results as a part of the test report.

4. Test DATA AND RESULTS

4.1 Antenna Port Test Data and Results for GSM 850 band:

Serial Number:	27A0-1	Test Date:	2023/6/27-2023/7/3
Test Site:	RF	Test Mode:	Transmitting
Tester:	Claire Liu	Test Result:	Pass

Environmental Conditions:

Temperature: (°C)	24.5-26.3	Relative Humidity: (%)	41-59	ATM Pressure: (kPa)	99.8-100.7
-------------------	-----------	------------------------	-------	---------------------	------------

Test Equipment List and Details:

Manufacturer	Description	Model	Serial Number	Calibration Date	Calibration Due Date
R&S	Spectrum Analyzer	FSU26	200256	2023/3/31	2024/3/30
zhuoxiang	Coaxial Cable	SMA-178	211001	Each time	N/A
YINSAIGE	Coaxial Cable	SS402	SJ0100001	Each time	N/A
Mini-Circuits	DC Block	BLK-18-S+	1554403	Each time	N/A
Weinschel	Power Splitter	1515	RA914	Each time	N/A
R&S	Wideband Radio Communication Tester	CMW500	149218	2023/3/31	2024/3/30
BACL	TEMP&HUMI Test Chamber	BTH-150-40	30174	2022/9/29	2023/9/28
UNI-T	Multimeter	UT39A+	C210582554	2022/9/29	2023/9/28
ZHAOXIN	DC Power Supply	RXN-6010D	21R6010D0912386	2022/7/15	2023/7/14

* Statement of Traceability: China Certification ICT Co., Ltd (Dongguan) attests that all calibrations have been performed, traceable to National Primary Standards and International System of Units (SI).

Test Frequency for Each Mode:

Operation Modes	Lowest Frequency (MHz)	Middle Frequency (MHz)	Highest Frequency (MHz)
GSM	824.2	836.6	848.8
GPRS	824.2	836.6	848.8
EDGE	824.2	836.6	848.8

Test Data:

FCC§2.1046; § 22.913 (a): RF Output Power					
Test Mode	Conducted Peak Output Power(dBm)			Maximum ERP (dBm)	ERP Limit (dBm)
	Lowest Channel	Middle Channel	Highest Channel		
GSM	32.09	32.19	32.20	29.58	38.45
GPRS 1 Slot	32.47	32.61	32.63	30.01	38.45
GPRS 2 Slots	31.39	31.47	31.49	28.87	38.45
GPRS 3 Slots	29.22	29.39	29.41	26.79	38.45
GPRS 4 Slots	28.08	28.12	28.16	25.54	38.45
EDGE 1 Slot	26.57	26.63	26.65	24.03	38.45
EDGE 2 Slots	24.91	24.98	24.97	22.36	38.45
EDGE 3 Slots	22.24	22.33	22.31	19.71	38.45
EDGE 4 Slots	20.61	20.62	20.63	18.01	38.45

Note:
ERP= Conducted Power(dBm) - Lc(dB) + G_r(dBd)
G_r(dBd)=G_r(dBi)-2.15

Result:	Pass
----------------	-------------

FCC §2.1049, §22.917, §22.905:Occupied Bandwidth						
Operation Mode	99% Occupied Bandwidth (MHz)			26 dB Occupied Bandwidth (MHz)		
	Low Channel	Middle channel	High Channel	Low Channel	Middle Channel	High Channel
GSM	0.240	0.240	0.240	0.289	0.278	0.274
EDGE	0.252	0.246	0.252	0.318	0.312	0.318

Note: The test plots please refer to the Plots of Occupied Bandwidth

FCC §2.1051, §22.917(a):Spurious Emissions at Antenna Terminal	
Result:	Pass, Please refer to the test plots of Spurious Emissions at Antenna Terminal.

FCC §2.1051, §22.917(a):Out of band emission, Band Edge	
Result:	Pass, Please refer to the test plots of Out of band emission, Band Edge.

FCC §2.1055, §22.355: Frequency Stability					
Test Modulation:	GMSK		Test Channel:	836.6	MHz
Test Item	Temperature (°C)	Voltage (V _{DC})	Frequency Error		Limit
			(Hz)	(ppm)	(ppm)
Frequency Stability vs. Temperature	-30	3.85	-5.12	-0.006	2.5
	-20	3.85	-3.15	-0.004	2.5
	-10	3.85	13.30	0.016	2.5
	0	3.85	-4.09	-0.005	2.5
	10	3.85	-6.38	-0.008	2.5

	20	3.85	-6.29	-0.008	2.5
	30	3.85	-3.15	-0.004	2.5
	40	3.85	-5.33	-0.006	2.5
	50	3.85	9.20	0.011	2.5
Frequency Stability vs. Voltage	20	3.6	9.58	0.011	2.5
	20	4.35	11.05	0.013	2.5
				Result:	Pass

Test Modulation:	8PSK		Test Channel:	836.6	MHz
Test Item	Temperature (°C)	Voltage (V _{DC})	Frequency Error		Limit
			(Hz)	(ppm)	(ppm)
Frequency Stability vs. Temperature	-30	3.85	-4.13	-0.005	2.5
	-20	3.85	-6.30	-0.008	2.5
	-10	3.85	-2.46	-0.003	2.5
	0	3.85	9.84	0.012	2.5
	10	3.85	11.59	0.014	2.5
	20	3.85	10.13	0.012	2.5
	30	3.85	-2.85	-0.003	2.5
	40	3.85	10.85	0.013	2.5
	50	3.85	-6.03	-0.007	2.5
Frequency Stability vs. Voltage	20	3.6	-4.50	-0.005	2.5
	20	4.35	-3.38	-0.004	2.5
				Result:	Pass

Test Plots (Note: The 14.5 dB is the Insertion loss of the RF cable and Power Splitter, which was offset into the Spectrum Analyzer):

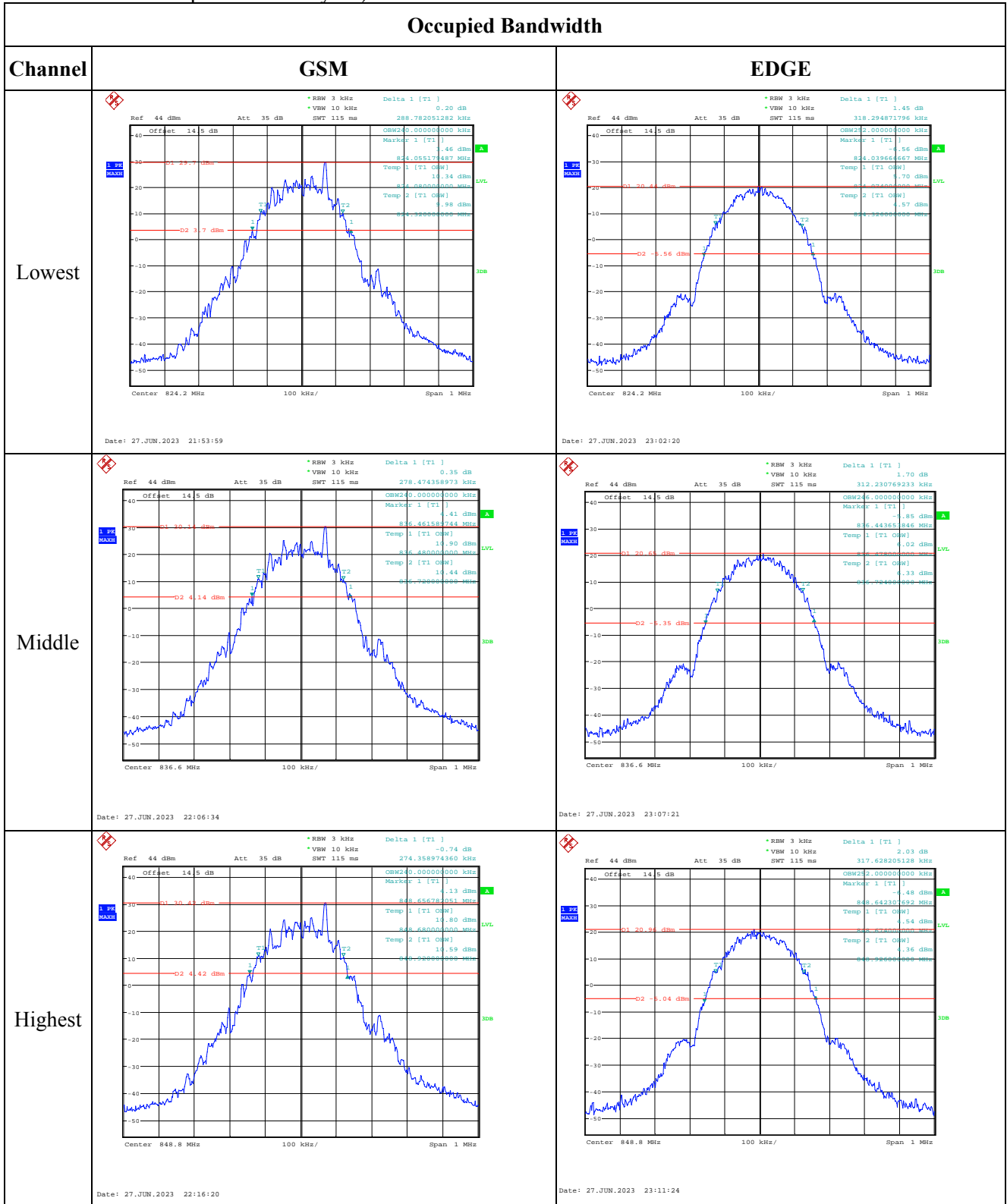

Spurious Emissions at Antenna Terminal

Channel	GSM	
Lowest	<p>Ref 44 dBm *Att 35 dB *RBW 100 kHz *VSW 300 kHz *SWT 100 ms Marker 1 [T1] -29.87 dBm 571.26000000 MHz</p> <p>Offset 14.5 dB</p> <p>D1 -13 dBm</p> <p>Start 30 MHz 97 MHz/ Stop 1 GHz</p> <p>Date: 27.JUN.2023 23:38:55</p>	<p>Ref 44 dBm *Att 35 dB *RBW 1 MHz *VSW 3 MHz *SWT 55 ms Marker 1 [T1] -21.64 dBm 3.149038462 GHz</p> <p>Offset 14.5 dB</p> <p>D1 -13 dBm</p> <p>Start 1 GHz 900 MHz/ Stop 10 GHz</p> <p>Date: 27.JUN.2023 23:39:20</p>
Middle	<p>Ref 44 dBm *Att 35 dB *RBW 100 kHz *VSW 300 kHz *SWT 100 ms Marker 1 [T1] -30.99 dBm 482.02000000 MHz</p> <p>Offset 14.5 dB</p> <p>D1 -13 dBm</p> <p>Start 30 MHz 97 MHz/ Stop 1 GHz</p> <p>Date: 27.JUN.2023 23:40:31</p>	<p>Ref 44 dBm *Att 35 dB *RBW 1 MHz *VSW 3 MHz *SWT 55 ms Marker 1 [T1] -23.52 dBm 3.134615385 GHz</p> <p>Offset 14.5 dB</p> <p>D1 -13 dBm</p> <p>Start 1 GHz 900 MHz/ Stop 10 GHz</p> <p>Date: 27.JUN.2023 23:40:53</p>
Highest	<p>Ref 44 dBm *Att 35 dB *RBW 100 kHz *VSW 300 kHz *SWT 100 ms Marker 1 [T1] -31.56 dBm 650.80000000 MHz</p> <p>Offset 14.5 dB</p> <p>D1 -13 dBm</p> <p>Start 30 MHz 97 MHz/ Stop 1 GHz</p> <p>Date: 27.JUN.2023 23:42:09</p>	<p>Ref 44 dBm *Att 35 dB *RBW 1 MHz *VSW 3 MHz *SWT 55 ms Marker 1 [T1] -23.10 dBm 3.134615385 GHz</p> <p>Offset 14.5 dB</p> <p>D1 -13 dBm</p> <p>Start 1 GHz 900 MHz/ Stop 10 GHz</p> <p>Date: 27.JUN.2023 23:42:35</p>

Out of band emission, Band Edge

Mode	Lowest	Highest
GSM	<p>Ref 34 dBm Att 45 dB RBW 3 kHz VBW 10 MHz SWT 500 ms Marker 1 [T1] -14.20 dBm 823.995512821 MHz</p> <p>Offset 14.5 dB</p> <p>D1 -13 dBm</p> <p>Center 824 MHz 200 kHz/ Span 2 MHz</p> <p>Date: 27.JUN.2023 21:56:24</p>	<p>Ref 34 dBm Att 45 dB RBW 3 kHz VBW 10 MHz SWT 500 ms Marker 1 [T1] -16.74 dBm 849.020512821 MHz</p> <p>Offset 14.5 dB</p> <p>D1 -13 dBm</p> <p>Center 849 MHz 200 kHz/ Span 2 MHz</p> <p>Date: 27.JUN.2023 22:17:28</p>
EDGE	<p>Ref 34 dBm Att 45 dB RBW 3 kHz VBW 10 MHz SWT 225 ms Marker 1 [T1] -25.69 dBm 823.985897436 MHz</p> <p>Offset 14.5 dB</p> <p>D1 -13 dBm</p> <p>Center 824 MHz 200 kHz/ Span 2 MHz</p> <p>Date: 27.JUN.2023 23:03:24</p>	<p>Ref 34 dBm Att 45 dB RBW 3 kHz VBW 10 MHz SWT 225 ms Marker 1 [T1] -24.08 dBm 849.007693308 MHz</p> <p>Offset 14.5 dB</p> <p>D1 -13 dBm</p> <p>Center 849 MHz 200 kHz/ Span 2 MHz</p> <p>Date: 27.JUN.2023 23:12:14</p>

4.2 Antenna Port Test Data and Results for GSM 1900 band:

Serial Number:	27A0-1	Test Date:	2023/6/27-2023/7/3
Test Site:	RF	Test Mode:	Transmitting
Tester:	Claire Liu	Test Result:	Pass

Environmental Conditions:

Temperature: (°C)	24.5-26.3	Relative Humidity: (%)	41-59	ATM Pressure: (kPa)	99.8-100.7
----------------------	-----------	---------------------------	-------	------------------------	------------

Test Equipment List and Details:

Manufacturer	Description	Model	Serial Number	Calibration Date	Calibration Due Date
R&S	Spectrum Analyzer	FSU26	200256	2023/3/31	2024/3/30
zhuoxiang	Coaxial Cable	SMA-178	211001	Each time	N/A
YINSAIGE	Coaxial Cable	SS402	SJ0100001	Each time	N/A
Mini-Circuits	DC Block	BLK-18-S+	1554403	Each time	N/A
Weinschel	Power Splitter	1515	RA914	Each time	N/A
R&S	Wideband Radio Communication Tester	CMW500	149218	2023/3/31	2024/3/30
BACL	TEMP&HUMI Test Chamber	BTH-150-40	30174	2022/9/29	2023/9/28
UNI-T	Multimeter	UT39A+	C210582554	2022/9/29	2023/9/28
ZHAOXIN	DC Power Supply	RXN-6010D	21R6010D0912386	2022/7/15	2023/7/14

* Statement of Traceability: China Certification ICT Co., Ltd (Dongguan) attests that all calibrations have been performed, traceable to National Primary Standards and International System of Units (SI).

Test Frequency for Each Mode:

Operation Modes	Lowest Frequency (MHz)	Middle Frequency (MHz)	Highest Frequency (MHz)
GSM	1850.2	1880	1909.8
GPRS	1850.2	1880	1909.8
EDGE	1850.2	1880	1909.8

Test Data:

FCC§2.1046; § 24.232 (c): RF Output Power					
Test Mode	Conducted Peak Output Power(dBm)			Maximum EIRP (dBm)	EIRP Limit (dBm)
	Lowest Channel	Middle Channel	Highest Channel		
GSM	30.72	30.26	29.69	31.09	33
GPRS 1 Slot	30.75	30.29	29.74	31.12	33
GPRS 2 Slots	30.01	29.56	29.09	30.38	33
GPRS 3 Slots	27.68	27.07	26.98	28.05	33
GPRS 4 Slots	26.51	26.03	25.96	26.88	33
EDGE 1 Slot	24.72	24.21	24.57	25.09	33
EDGE 2 Slots	23.46	23.01	23.27	23.83	33
EDGE 3 Slots	21.04	20.97	21.06	21.43	33
EDGE 4 Slots	19.69	19.21	19.41	20.06	33

Note: EIRP=Conducted Power(dBm) - Lc(dB) + Gr(dBi)

Result:	Pass
----------------	-------------

FCC §2.1049, §24.238:Occupied Bandwidth						
Operation Mode	99% Occupied Bandwidth (MHz)			26 dB Occupied Bandwidth (MHz)		
	Low Channel	Middle channel	High Channel	Low Channel	Middle Channel	High Channel
GSM	0.240	0.240	0.240	0.274	0.266	0.265
EDGE	0.246	0.248	0.25	0.307	0.314	0.319

Note: The test plots please refer to the Plots of Occupied Bandwidth

FCC §2.1051, § 24.238 (a):Spurious Emissions at Antenna Terminal	
Result:	Pass, Please refer to the test plots of Spurious Emissions at Antenna Terminal.

FCC §2.1051, § 24.238 (a):Out of band emission, Band Edge	
Result:	Pass, Please refer to the test plots of Out of band emission, Band Edge.

FCC §2.1055, §24.235: Frequency Stability						
Test Mode:	GMSK	Test Channel: Lowest for Lower Edge,Highest for Upper Edge				
Test Item	Temperature (°C)	Voltage (V _{DC})	Lower Edge (MHz)		Upper Edge (MHz)	
			Result	Limit	Result	Limit
Frequency Stability vs. Temperature	-30	3.85	1850.002	1850.000	1909.991	1910.000
	-20	3.85	1850.068	1850.000	1909.914	1910.000
	-10	3.85	1850.006	1850.000	1909.993	1910.000
	0	3.85	1850.065	1850.000	1909.963	1910.000
	10	3.85	1850.024	1850.000	1909.945	1910.000
	20	3.85	1850.080	1850.000	1909.992	1910.000
	30	3.85	1850.023	1850.000	1909.911	1910.000

Frequency Stability vs. Voltage	40	3.85	1850.040	1850.000	1909.972	1910.000
	50	3.85	1850.048	1850.000	1909.921	1910.000
	20	3.6	1850.053	1850.000	1909.968	1910.000
	20	4.35	1850.027	1850.000	1909.991	1910.000
					Result:	Pass

Test Mode:	8PSK	Test Channel: Lowest for Lower Edge, Highest for Upper Edge				
Test Item	Temperature (°C)	Voltage (V _{DC})	Lower Edge (MHz)		Upper Edge (MHz)	
			Result	Limit	Result	Limit
Frequency Stability vs. Temperature	-30	3.85	1850.079	1850.000	1909.935	1910.000
	-20	3.85	1850.078	1850.000	1909.944	1910.000
	-10	3.85	1850.026	1850.000	1909.980	1910.000
	0	3.85	1850.042	1850.000	1909.950	1910.000
	10	3.85	1850.025	1850.000	1909.911	1910.000
	20	3.85	1850.078	1850.000	1909.926	1910.000
	30	3.85	1850.029	1850.000	1909.954	1910.000
	40	3.85	1850.056	1850.000	1909.936	1910.000
	50	3.85	1850.025	1850.000	1909.948	1910.000
Frequency Stability vs. Voltage	20	3.6	1850.016	1850.000	1909.999	1910.000
	20	4.35	1850.024	1850.000	1909.916	1910.000
					Result:	Pass

Test Plots (Note: The 14.5 dB is the Insertion loss of the RF cable and Power Splitter, which was offset into the Spectrum Analyzer):

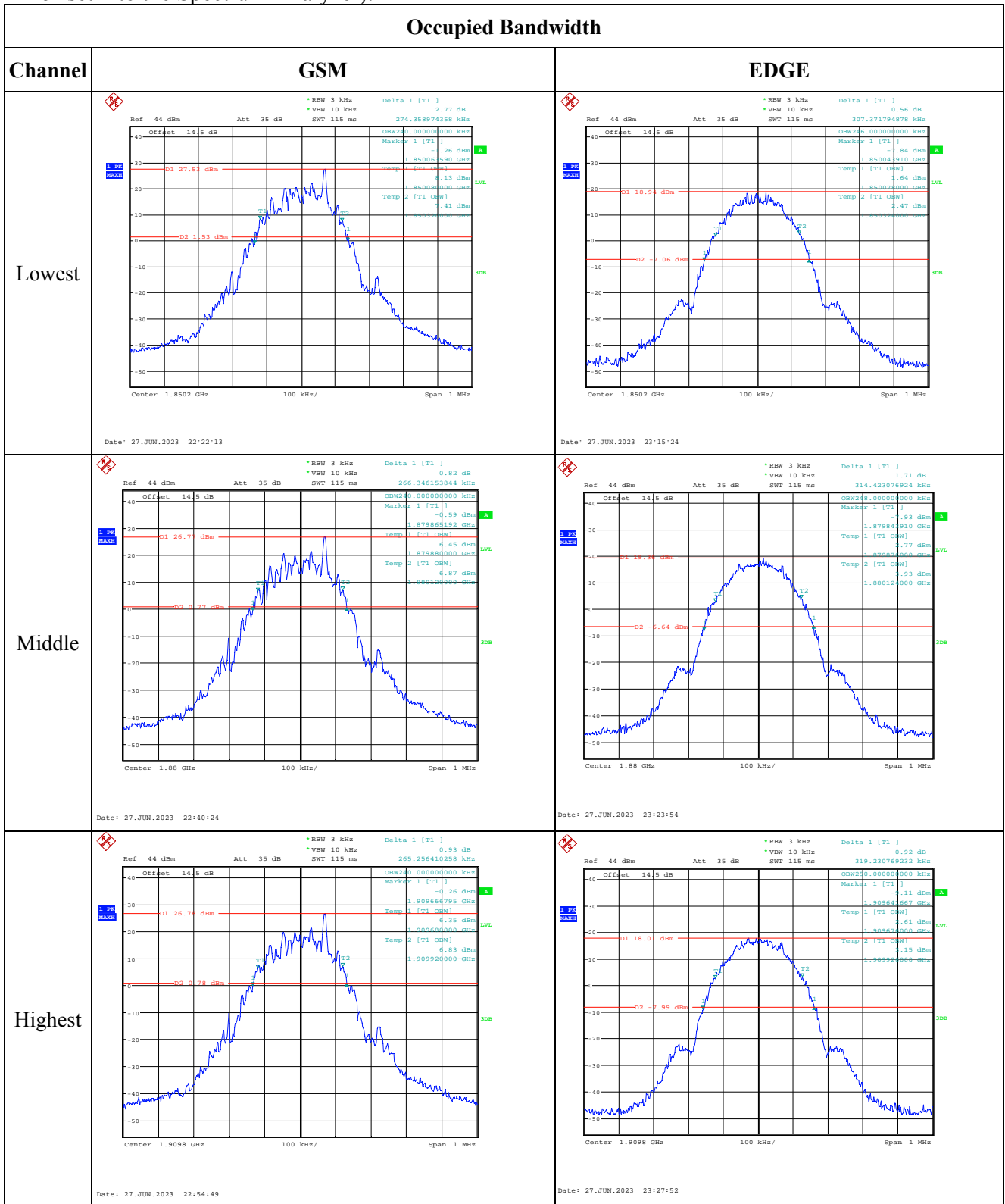

Spurious Emissions at Antenna Terminal

Channel	GSM	
Lowest	<p>Ref 44 dBm Att 35 dB RBW 100 kHz Marker 1 [T1] -30.30 dBm VSW 300 kHz SWT 100 ms 569.320000000 MHz</p> <p>Offset 14.5 dB</p> <p>D1 -13 dBm L1</p> <p>Start 30 MHz 97 MHz/ Stop 1 GHz</p> <p>Date: 27.JUN.2023 23:44:26</p>	<p>Ref 44 dBm Att 35 dB RBW 1 MHz Marker 1 [T1] -23.02 dBm VSW 3 MHz SWT 110 ms 3.134615385 GHz</p> <p>Offset 14.5 dB</p> <p>D1 -13 dBm L1</p> <p>Start 1 GHz 1.9 GHz/ Stop 20 GHz</p> <p>Date: 27.JUN.2023 23:45:42</p>
Middle	<p>Ref 44 dBm Att 35 dB RBW 100 kHz Marker 1 [T1] -31.18 dBm VSW 300 kHz SWT 100 ms 74.620000000 MHz</p> <p>Offset 14.5 dB</p> <p>D1 -13 dBm L1</p> <p>Start 30 MHz 97 MHz/ Stop 1 GHz</p> <p>Date: 27.JUN.2023 23:48:07</p>	<p>Ref 44 dBm Att 35 dB RBW 1 MHz Marker 1 [T1] -23.23 dBm VSW 3 MHz SWT 110 ms 3.134615385 GHz</p> <p>Offset 14.5 dB</p> <p>D1 -13 dBm L1</p> <p>Start 1 GHz 1.9 GHz/ Stop 20 GHz</p> <p>Date: 27.JUN.2023 23:48:27</p>
Highest	<p>Ref 44 dBm Att 35 dB RBW 100 kHz Marker 1 [T1] -30.74 dBm VSW 300 kHz SWT 100 ms 745.860000000 MHz</p> <p>Offset 14.5 dB</p> <p>D1 -13 dBm L1</p> <p>Start 30 MHz 97 MHz/ Stop 1 GHz</p> <p>Date: 27.JUN.2023 23:50:27</p>	<p>Ref 44 dBm Att 35 dB RBW 1 MHz Marker 1 [T1] -24.17 dBm VSW 3 MHz SWT 110 ms 3.134615385 GHz</p> <p>Offset 14.5 dB</p> <p>D1 -13 dBm L1</p> <p>Start 1 GHz 1.9 GHz/ Stop 20 GHz</p> <p>Date: 27.JUN.2023 23:50:40</p>

Out of band emission, Band Edge

Channel	Lowest	Highest
GSM	<p>Ref 34 dBm Att 45 dB RBW 3 kHz VBW 10 MHz SWT 500 ms Marker 1 [T1] -16.25 dBm 1.84997436 GHz</p> <p>Offset 14.5 dB</p> <p>Center 1.85 GHz 200 kHz/ Span 2 MHz</p> <p>Date: 27.JUN.2023 22:23:27</p>	<p>Ref 34 dBm Att 45 dB RBW 3 kHz VBW 10 MHz SWT 500 ms Marker 1 [T1] -19.97 dBm 1.91002436 GHz</p> <p>Offset 14.5 dB</p> <p>Center 1.91 GHz 200 kHz/ Span 2 MHz</p> <p>Date: 27.JUN.2023 22:56:09</p>
EDGE	<p>Ref 34 dBm Att 45 dB RBW 3 kHz VBW 10 MHz SWT 225 ms Marker 1 [T1] -25.43 dBm 1.849966667 GHz</p> <p>Offset 14.5 dB</p> <p>Center 1.85 GHz 200 kHz/ Span 2 MHz</p> <p>Date: 27.JUN.2023 23:16:14</p>	<p>Ref 34 dBm Att 45 dB RBW 3 kHz VBW 10 MHz SWT 225 ms Marker 1 [T1] -25.78 dBm 1.910007692 GHz</p> <p>Offset 14.5 dB</p> <p>Center 1.91 GHz 200 kHz/ Span 2 MHz</p> <p>Date: 27.JUN.2023 23:29:08</p>

4.3 Antenna Port Test Data and Results for WCDMA Band 2:

Serial Number:	27A0-1	Test Date:	2023/6/27-2023/7/3
Test Site:	RF	Test Mode:	Transmitting
Tester:	Claire Liu	Test Result:	Pass

Environmental Conditions:

Temperature: (°C)	24.5-26.3	Relative Humidity: (%)	41-59	ATM Pressure: (kPa)	99.8-100.7
----------------------	-----------	------------------------------	-------	------------------------	------------

Test Equipment List and Details:

Manufacturer	Description	Model	Serial Number	Calibration Date	Calibration Due Date
R&S	Spectrum Analyzer	FSU26	200256	2023/3/31	2024/3/30
zhuoxiang	Coaxial Cable	SMA-178	211001	Each time	N/A
YINSAIGE	Coaxial Cable	SS402	SJ0100001	Each time	N/A
Mini-Circuits	DC Block	BLK-18-S+	1554403	Each time	N/A
Weinschel	Power Splitter	1515	RA914	Each time	N/A
R&S	Wideband Radio Communication Tester	CMW500	149218	2023/3/31	2024/3/30
BACL	TEMP&HUMI Test Chamber	BTH-150-40	30174	2022/9/29	2023/9/28
UNI-T	Multimeter	UT39A+	C210582554	2022/9/29	2023/9/28
ZHAOXIN	DC Power Supply	RXN-6010D	21R6010D0912386	2022/7/15	2023/7/14

* Statement of Traceability: China Certification ICT Co., Ltd (Dongguan) attests that all calibrations have been performed, traceable to National Primary Standards and International System of Units (SI).

Test Frequency for Each Mode:

Operation Modes	Lowest Frequency (MHz)	Middle Frequency (MHz)	Highest Frequency (MHz)
WCDMA Band 2	1852.4	1880	1907.6

Test Data:**FCC§2.1046; § 24.232****RF Output Power:**

Test Mode	Conducted Average Output Power(dBm)			Maximum EIRP (dBm)	EIRP Limit (dBm)
	Lowest Channel	Middle Channel	Highest Channel		
WCDMA R99	22.43	22.23	22.09	22.8	33
HSDPA Subtest 1	21.46	21.34	21.06	21.83	33
HSDPA Subtest 2	21.45	21.38	21.12	21.82	33
HSDPA Subtest 3	21.48	21.37	21.13	21.85	33
HSDPA Subtest 4	21.52	21.36	21.09	21.89	33
HSUPA Subtest 1	21.45	21.34	21.06	21.82	33
HSUPA Subtest 2	21.43	21.38	21.11	21.8	33
HSUPA Subtest 3	21.39	21.42	21.06	21.79	33
HSUPA Subtest 4	21.51	21.41	21.03	21.88	33
HSUPA Subtest 5	21.47	21.39	21.11	21.84	33

Note: EIRP=Conducted Power(dBm) - Lc(dB) + Gr(dBi)

Result:	Pass
----------------	-------------

Peak-to-average Ratio(PAR)

Test Mode	Peak-to-average Ratio(dB)			Limit (dB)
	Lowest Channel	Middle Channel	Highest Channel	
WCDMA R99	3.91	3.94	3.85	13
HSDPA	6.76	6.6	6.7	13
HSUPA	7.28	6.83	6.73	13

Result:	Pass
----------------	-------------

FCC §2.1049, §24.238:Occupied Bandwidth

Operation Mode	99% Occupied Bandwidth (MHz)			26 dB Occupied Bandwidth (MHz)		
	Low Channel	Middle channel	High Channel	Low Channel	Middle Channel	High Channel
WCDMA R99	4.20	4.20	4.22	4.942	4.949	4.854
HSDPA	4.22	4.20	4.22	4.958	4.933	4.951
HSUPA	4.22	4.20	4.22	4.894	4.901	4.951

Note: The test plots please refer to the Plots of Occupied Bandwidth

FCC §2.1051, § 24.238 (a):Spurious Emissions at Antenna Terminal

Result:	Pass, Please refer to the test plots of Spurious Emissions at Antenna Terminal.
----------------	--

FCC §2.1051, § 24.238 (a):Out of band emission, Band Edge

Result:	Pass, Please refer to the test plots of Out of band emission, Band Edge.
----------------	---

FCC §2.1055, §24.235: Frequency Stability						
Test Mode:	WCDMA R99	Test Channel: Lowest for Lower Edge,Highest for Upper Edge				
Test Item	Temperature (°C)	Voltage (V _{DC})	Lower Edge (MHz)		Upper Edge (MHz)	
			Result	Limit	Result	Limit
Frequency Stability vs. Temperature	-30	3.85	1850.392	1850.000	1909.614	1910.000
	-20	3.85	1850.314	1850.000	1909.675	1910.000
	-10	3.85	1850.373	1850.000	1909.624	1910.000
	0	3.85	1850.350	1850.000	1909.638	1910.000
	10	3.85	1850.390	1850.000	1909.683	1910.000
	20	3.85	1850.300	1850.000	1909.700	1910.000
	30	3.85	1850.302	1850.000	1909.676	1910.000
	40	3.85	1850.391	1850.000	1909.685	1910.000
	50	3.85	1850.310	1850.000	1909.612	1910.000
Frequency Stability vs. Voltage	20	3.6	1850.335	1850.000	1909.695	1910.000
	20	4.35	1850.316	1850.000	1909.653	1910.000
					Result:	Pass

Test Plots (Note: The 14.5 dB is the Insertion loss of the RF cable and Power Splitter, which was offset into the Spectrum Analyzer):

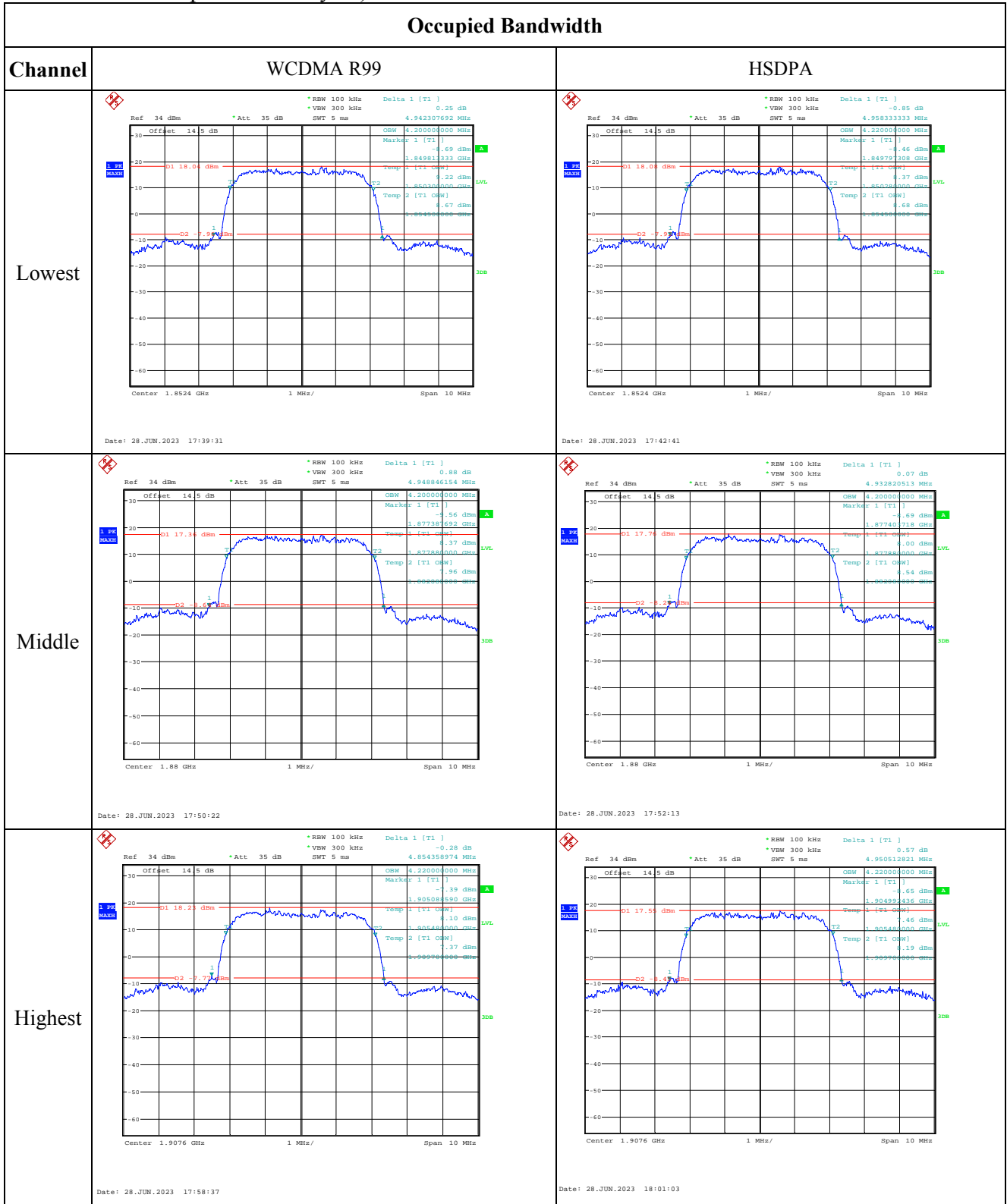

Occupied Bandwidth

Channel

HSUPA

Lowest

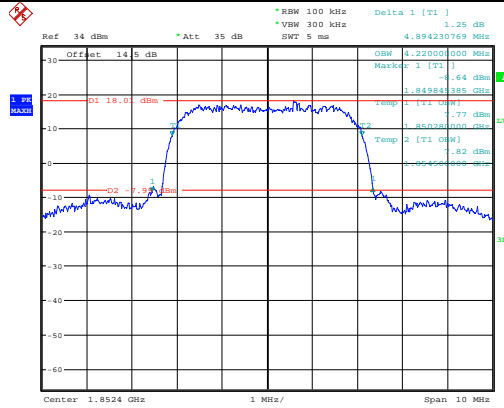

Date: 28 JUN 2023 17:44:03

Middle

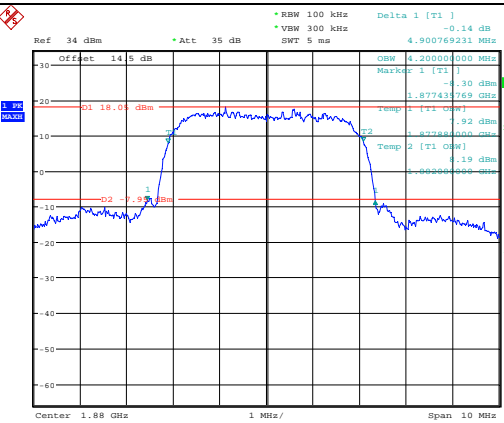

Date: 28 JUN 2023 17:53:31

Highest

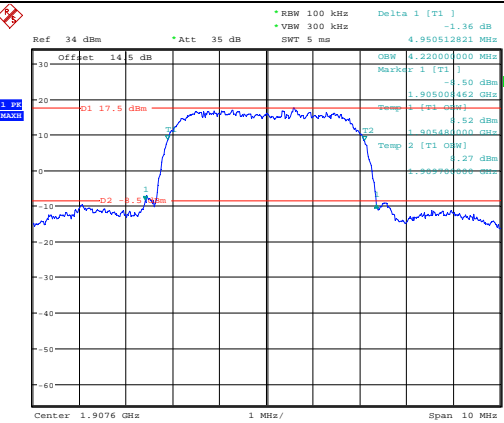

Date: 28 JUN 2023 18:04:26

Spurious Emissions at Antenna Terminal

Channel	WCDMA R99	
Lowest	<p>Ref 44 dBm Att 35 dB *RBW 100 kHz Marker 1 [T1] -30.97 dBm *VSW 300 kHz -30.97 dBm *SWT 100 ms 311.30000000 MHz</p> <p>Offset 14.5 dB</p> <p>Start 30 MHz 97 MHz/ Stop 1 GHz</p> <p>Date: 27.JUN.2023 23:52:43</p>	<p>Ref 44 dBm Att 35 dB *RBW 1 MHz Marker 1 [T1] -24.37 dBm *VSW 3 MHz -24.37 dBm *SWT 110 ms 3.134615385 GHz</p> <p>Offset 14.5 dB</p> <p>Start 1 GHz 1.9 GHz/ Stop 20 GHz</p> <p>Date: 27.JUN.2023 23:53:06</p>
Middle	<p>Ref 44 dBm Att 35 dB *RBW 100 kHz Marker 1 [T1] -29.96 dBm *VSW 300 kHz -29.96 dBm *SWT 100 ms 210.42000000 MHz</p> <p>Offset 14.5 dB</p> <p>Start 30 MHz 97 MHz/ Stop 1 GHz</p> <p>Date: 27.JUN.2023 23:57:44</p>	<p>Ref 44 dBm Att 35 dB *RBW 1 MHz Marker 1 [T1] -23.23 dBm *VSW 3 MHz -23.23 dBm *SWT 110 ms 3.134615385 GHz</p> <p>Offset 14.5 dB</p> <p>Start 1 GHz 1.9 GHz/ Stop 20 GHz</p> <p>Date: 27.JUN.2023 23:58:03</p>
Highest	<p>Ref 44 dBm Att 35 dB *RBW 100 kHz Marker 1 [T1] -32.15 dBm *VSW 300 kHz -32.15 dBm *SWT 100 ms 674.08000000 MHz</p> <p>Offset 14.5 dB</p> <p>Start 30 MHz 97 MHz/ Stop 1 GHz</p> <p>Date: 27.JUN.2023 23:58:41</p>	<p>Ref 44 dBm Att 35 dB *RBW 1 MHz Marker 1 [T1] -23.46 dBm *VSW 3 MHz -23.46 dBm *SWT 110 ms 3.134615385 GHz</p> <p>Offset 14.5 dB</p> <p>Start 1 GHz 1.9 GHz/ Stop 20 GHz</p> <p>Date: 27.JUN.2023 23:58:52</p>

Out of band emission, Band Edge

Mode	Lowest	Highest
R99	<p>Ref 34 dBm Att 35 dB RBW 100 kHz Marker 1 [T1] -14.02 dBm VSW 300 kHz SWT 100 ms 1.849885714 GHz</p> <p>Offset 14.5 dB</p> <p>D1 -13 dBm</p> <p>Center 1.85 GHz 1 MHz/ Span 10 MHz</p> <p>Date: 28.JUN.2023 17:45:29</p>	<p>Ref 34 dBm Att 35 dB RBW 100 kHz Marker 1 [T1] -15.85 dBm VSW 300 kHz SWT 100 ms 1.910114286 GHz</p> <p>Offset 14.5 dB</p> <p>D1 -13 dBm</p> <p>Center 1.91 GHz 1 MHz/ Span 10 MHz</p> <p>Date: 28.JUN.2023 17:59:21</p>
HSUPA	<p>Ref 34 dBm Att 35 dB RBW 100 kHz Marker 1 [T1] -14.31 dBm VSW 300 kHz SWT 100 ms 1.849928571 GHz</p> <p>Offset 14.5 dB</p> <p>D1 -13 dBm</p> <p>Center 1.85 GHz 1 MHz/ Span 10 MHz</p> <p>Date: 28.JUN.2023 17:47:11</p>	<p>Ref 34 dBm Att 35 dB RBW 100 kHz Marker 1 [T1] -15.57 dBm VSW 300 kHz SWT 100 ms 1.910114286 GHz</p> <p>Offset 14.5 dB</p> <p>D1 -13 dBm</p> <p>Center 1.91 GHz 1 MHz/ Span 10 MHz</p> <p>Date: 28.JUN.2023 18:04:38</p>
HSDPA	<p>Ref 34 dBm Att 35 dB RBW 100 kHz Marker 1 [T1] -13.53 dBm VSW 300 kHz SWT 100 ms 1.849871429 GHz</p> <p>Offset 14.5 dB</p> <p>D1 -13 dBm</p> <p>Center 1.85 GHz 1 MHz/ Span 10 MHz</p> <p>Date: 28.JUN.2023 17:46:40</p>	<p>Ref 34 dBm Att 35 dB RBW 100 kHz Marker 1 [T1] -15.33 dBm VSW 300 kHz SWT 100 ms 1.910114286 GHz</p> <p>Offset 14.5 dB</p> <p>D1 -13 dBm</p> <p>Center 1.91 GHz 1 MHz/ Span 10 MHz</p> <p>Date: 28.JUN.2023 18:01:40</p>

4.4 Antenna Port Test Data and Results for WCDMA Band 4:

Serial Number:	27A0-1	Test Date:	2023/6/27-2023/7/3
Test Site:	RF	Test Mode:	Transmitting
Tester:	Claire Liu	Test Result:	Pass

Environmental Conditions:

Temperature: (°C)	24.5-26.3	Relative Humidity: (%)	41-59	ATM Pressure: (kPa)	99.8-100.7
----------------------	-----------	---------------------------	-------	------------------------	------------

Test Equipment List and Details:

Manufacturer	Description	Model	Serial Number	Calibration Date	Calibration Due Date
R&S	Spectrum Analyzer	FSU26	200256	2023/3/31	2024/3/30
zhuoxiang	Coaxial Cable	SMA-178	211001	Each time	N/A
YINSAIGE	Coaxial Cable	SS402	SJ0100001	Each time	N/A
Mini-Circuits	DC Block	BLK-18-S+	1554403	Each time	N/A
Weinschel	Power Splitter	1515	RA914	Each time	N/A
R&S	Wideband Radio Communication Tester	CMW500	149218	2023/3/31	2024/3/30
BACL	TEMP&HUMI Test Chamber	BTH-150-40	30174	2022/9/29	2023/9/28
UNI-T	Multimeter	UT39A+	C210582554	2022/9/29	2023/9/28
ZHAOXIN	DC Power Supply	RXN-6010D	21R6010D0912386	2022/7/15	2023/7/14

* Statement of Traceability: China Certification ICT Co., Ltd (Dongguan) attests that all calibrations have been performed, traceable to National Primary Standards and International System of Units (SI).

Test Frequency for Each Mode:

Operation Modes	Lowest Frequency (MHz)	Middle Frequency (MHz)	Highest Frequency (MHz)
WCDMA Band 4	1712.4	1732.6	1752.6

Test Data:

FCC§2.1046; §27.50(d)(4): RF Output Power:					
Test Mode	Conducted Average Output Power(dBm)			Maximum EIRP (dBm)	EIRP Limit (dBm)
	Lowest Channel	Middle Channel	Highest Channel		
WCDMA R99	22.76	22.58	22.61	23.04	30
HSDPA Subtest 1	21.84	21.51	21.72	22.12	30
HSDPA Subtest 2	21.75	21.52	21.65	22.03	30
HSDPA Subtest 3	21.76	21.56	21.69	22.04	30
HSDPA Subtest 4	21.82	21.56	21.71	22.10	30
HSUPA Subtest 1	21.67	21.52	21.66	21.95	30
HSUPA Subtest 2	21.69	21.61	21.69	21.97	30
HSUPA Subtest 3	21.71	21.48	21.67	21.99	30
HSUPA Subtest 4	21.81	21.49	21.73	22.09	30
HSUPA Subtest 5	21.75	21.51	21.68	22.03	30

Note: EIRP=Conducted Power(dBm) - Lc(dB) + Gr(dBi)

Result:	Pass
----------------	-------------

Peak-to-average Ratio(PAR)				
Test Mode	Peak-to-average Ratio(dB)			Limit (dB)
	Lowest Channel	Middle Channel	Highest Channel	
WCDMA R99	3.46	3.69	3.3	13
HSDPA	5.51	6.03	5.48	13
HSUPA	5.45	6.09	5.26	13

Result:	Pass
----------------	-------------

FCC §2.1049, §27.53:Occupied Bandwidth						
Operation Mode	99% Occupied Bandwidth (MHz)			26 dB Occupied Bandwidth (MHz)		
	Low Channel	Middle channel	High Channel	Low Channel	Middle Channel	High Channel
WCDMA R99	4.2	4.2	4.2	4.897	4.952	4.712
HSDPA	4.2	4.2	4.2	4.705	4.888	4.728
HSUPA	4.2	4.2	4.2	4.705	4.872	4.744

Note: The test plots please refer to the Plots of Occupied Bandwidth

FCC §2.1051, § 27.53:Spurious Emissions at Antenna Terminal	
Result:	Pass, Please refer to the test plots of Spurious Emissions at Antenna Terminal.

FCC §2.1051, § 27.53:Out of band emission, Band Edge	
Result:	Pass, Please refer to the test plots of Out of band emission, Band Edge.

FCC §2.1055, §27.54: Frequency Stability

Test Mode:	WCDMA R99	Test Channel: Lowest for Lower Edge,Highest for Upper Edge				
Test Item	Temperature (°C)	Voltage (V _{DC})	Lower Edge (MHz)		Upper Edge (MHz)	
			Result	Limit	Result	Limit
Frequency Stability vs. Temperature	-30	3.85	1710.354	1710.000	1754.604	1755.000
	-20	3.85	1710.355	1710.000	1754.640	1755.000
	-10	3.85	1710.334	1710.000	1754.630	1755.000
	0	3.85	1710.382	1710.000	1754.643	1755.000
	10	3.85	1710.337	1710.000	1754.625	1755.000
	20	3.85	1710.300	1710.000	1754.700	1755.000
	30	3.85	1710.341	1710.000	1754.643	1755.000
	40	3.85	1710.387	1710.000	1754.690	1755.000
	50	3.85	1710.338	1710.000	1754.677	1755.000
Frequency Stability vs. Voltage	20	3.6	1710.303	1710.000	1754.631	1755.000
	20	4.35	1710.381	1710.000	1754.671	1755.000
					Result:	Pass

Test Plots (Note: The 14.5 dB is the Insertion loss of the RF cable and Power Splitter, which was offset into the Spectrum Analyzer):

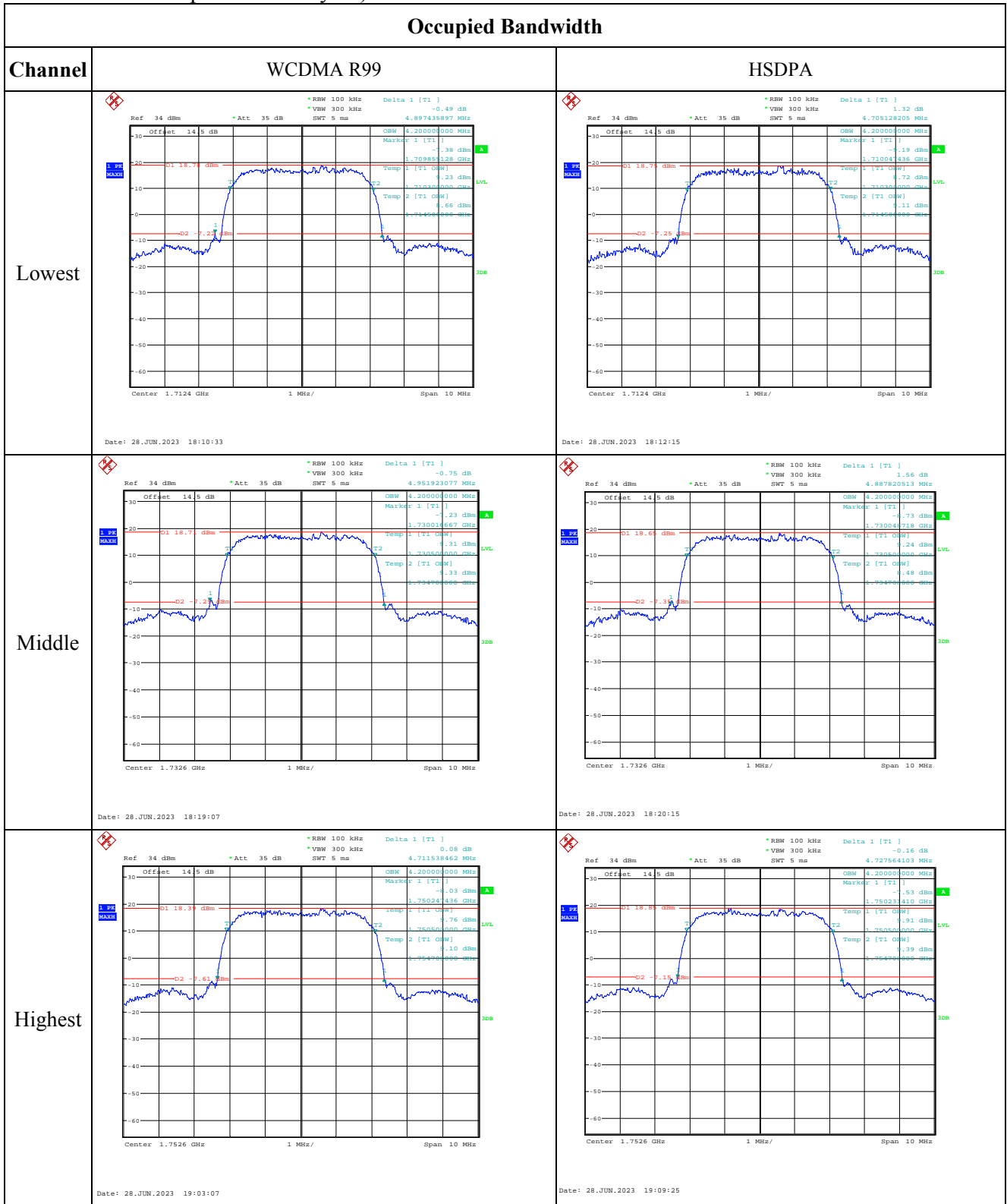

Occupied Bandwidth

Channel	HSUPA
Lowest	<p>Date: 28 JUN 2023 18:13:58</p>
Middle	<p>Date: 28 JUN 2023 18:21:48</p>
Highest	<p>Date: 28 JUN 2023 19:12:45</p>

Spurious Emissions at Antenna Terminal

Channel	WCDMA R99	
Lowest	<p>Ref 44 dBm Att 35 dB RBW 100 kHz Marker 1 [T1] -31.60 dBm VSW 300 kHz SWT 100 ms 970.900000000 MHz</p> <p>Offset 14.5 dB</p> <p>D1 -13 dBm 1</p> <p>Start 30 MHz 97 MHz/ Stop 1 GHz</p> <p>Date: 28.JUN.2023 00:00:15</p>	<p>Ref 44 dBm Att 35 dB RBW 1 MHz Marker 1 [T1] -24.55 dBm VSW 3 MHz SWT 110 ms 3.134615385 GHz</p> <p>Offset 14.5 dB</p> <p>D1 -13 dBm 1</p> <p>Start 1 GHz 1.9 GHz/ Stop 20 GHz</p> <p>Date: 28.JUN.2023 00:00:25</p>
Middle	<p>Ref 44 dBm Att 35 dB RBW 100 kHz Marker 1 [T1] -31.09 dBm VSW 300 kHz SWT 100 ms 650.800000000 MHz</p> <p>Offset 14.5 dB</p> <p>D1 -13 dBm 1</p> <p>Start 30 MHz 97 MHz/ Stop 1 GHz</p> <p>Date: 28.JUN.2023 00:01:03</p>	<p>Ref 44 dBm Att 35 dB RBW 1 MHz Marker 1 [T1] -23.93 dBm VSW 3 MHz SWT 110 ms 18.294871795 GHz</p> <p>Offset 14.5 dB</p> <p>D1 -13 dBm 1</p> <p>Start 1 GHz 1.9 GHz/ Stop 20 GHz</p> <p>Date: 28.JUN.2023 00:01:43</p>
Highest	<p>Ref 44 dBm Att 35 dB RBW 100 kHz Marker 1 [T1] -31.04 dBm VSW 300 kHz SWT 100 ms 951.500000000 MHz</p> <p>Offset 14.5 dB</p> <p>D1 -13 dBm 1</p> <p>Start 30 MHz 97 MHz/ Stop 1 GHz</p> <p>Date: 28.JUN.2023 00:02:11</p>	<p>Ref 44 dBm Att 35 dB RBW 1 MHz Marker 1 [T1] -23.35 dBm VSW 3 MHz SWT 110 ms 3.13410205 GHz</p> <p>Offset 14.5 dB</p> <p>D1 -13 dBm 1</p> <p>Start 1 GHz 1.9 GHz/ Stop 20 GHz</p> <p>Date: 28.JUN.2023 00:02:26</p>

Out of band emission, Band Edge

Mode	Lowest	Highest
R99	<p>Ref 34 dBm Att 35 dB RBW 100 kHz Marker 1 [T1] -15.23 dBm VSW 300 kHz SWT 100 ms 1.709914286 GHz</p> <p>Offset 14.5 dB</p> <p>D1 -13 dBm</p> <p>Center 1.71 GHz 1 MHz/ Span 10 MHz</p> <p>Date: 28.JUN.2023 18:11:03</p>	<p>Ref 34 dBm Att 35 dB RBW 100 kHz Marker 1 [T1] -15.98 dBm VSW 300 kHz SWT 100 ms 1.755142857 GHz</p> <p>Offset 14.5 dB</p> <p>D1 -13 dBm</p> <p>Center 1.755 GHz 1 MHz/ Span 10 MHz</p> <p>Date: 28.JUN.2023 19:03:57</p>
HSUPA	<p>Ref 34 dBm Att 35 dB RBW 100 kHz Marker 1 [T1] -15.84 dBm VSW 300 kHz SWT 100 ms 1.709885714 GHz</p> <p>Offset 14.5 dB</p> <p>D1 -13 dBm</p> <p>Center 1.71 GHz 1 MHz/ Span 10 MHz</p> <p>Date: 28.JUN.2023 18:14:19</p>	<p>Ref 34 dBm Att 35 dB RBW 100 kHz Marker 1 [T1] -16.16 dBm VSW 300 kHz SWT 100 ms 1.755171429 GHz</p> <p>Offset 14.5 dB</p> <p>D1 -13 dBm</p> <p>Center 1.755 GHz 1 MHz/ Span 10 MHz</p> <p>Date: 28.JUN.2023 19:13:13</p>
HSDPA	<p>Ref 34 dBm Att 35 dB RBW 100 kHz Marker 1 [T1] -15.11 dBm VSW 300 kHz SWT 100 ms 1.709914286 GHz</p> <p>Offset 14.5 dB</p> <p>D1 -13 dBm</p> <p>Center 1.71 GHz 1 MHz/ Span 10 MHz</p> <p>Date: 28.JUN.2023 18:12:50</p>	<p>Ref 34 dBm Att 35 dB RBW 100 kHz Marker 1 [T1] -16.11 dBm VSW 300 kHz SWT 100 ms 1.755128571 GHz</p> <p>Offset 14.5 dB</p> <p>D1 -13 dBm</p> <p>Center 1.755 GHz 1 MHz/ Span 10 MHz</p> <p>Date: 28.JUN.2023 19:10:01</p>

4.5 Antenna Port Test Data and Results for WCDMA Band 5:

Serial Number:	27A0-1	Test Date:	2023/6/27-2023/7/3
Test Site:	RF	Test Mode:	Transmitting
Tester:	Claire Liu	Test Result:	Pass

Environmental Conditions:

Temperature: (°C)	24.5-26.3	Relative Humidity: (%)	41-59	ATM Pressure: (kPa)	99.8-100.7
----------------------	-----------	---------------------------	-------	------------------------	------------

Test Equipment List and Details:

Manufacturer	Description	Model	Serial Number	Calibration Date	Calibration Due Date
R&S	Spectrum Analyzer	FSU26	200256	2023/3/31	2024/3/30
zhuoxiang	Coaxial Cable	SMA-178	211001	Each time	N/A
YINSAIGE	Coaxial Cable	SS402	SJ0100001	Each time	N/A
Mini-Circuits	DC Block	BLK-18-S+	1554403	Each time	N/A
Weinschel	Power Splitter	1515	RA914	Each time	N/A
R&S	Wideband Radio Communication Tester	CMW500	149218	2023/3/31	2024/3/30
BACL	TEMP&HUMI Test Chamber	BTH-150-40	30174	2022/9/29	2023/9/28
UNI-T	Multimeter	UT39A+	C210582554	2022/9/29	2023/9/28
ZHAOXIN	DC Power Supply	RXN-6010D	21R6010D0912386	2022/7/15	2023/7/14

* Statement of Traceability: China Certification ICT Co., Ltd (Dongguan) attests that all calibrations have been performed, traceable to National Primary Standards and International System of Units (SI).

Test Frequency:

Operation Modes	Lowest Frequency (MHz)	Middle Frequency (MHz)	Highest Frequency (MHz)
WCDMA Band 5	826.4	836.6	846.6

Test Data:**FCC§2.1046;§ 22.913 (a):RF Output Power:**

Test Mode	Conducted Average Output Power(dBm)			Maximum ERP (dBm)	ERP Limit (dBm)
	Lowest Channel	Middle Channel	Highest Channel		
WCDMA R99	22.81	22.74	22.79	20.19	38.45
HSDPA Subtest 1	21.78	21.76	21.83	19.21	38.45
HSDPA Subtest 2	21.79	21.77	21.76	19.17	38.45
HSDPA Subtest 3	21.76	21.65	21.82	19.20	38.45
HSDPA Subtest 4	21.76	21.73	21.71	19.14	38.45
HSUPA Subtest 1	21.77	21.69	21.76	19.15	38.45
HSUPA Subtest 2	21.79	21.65	21.69	19.17	38.45
HSUPA Subtest 3	21.69	21.81	21.76	19.19	38.45
HSUPA Subtest 4	21.72	21.76	21.74	19.14	38.45
HSUPA Subtest 5	21.68	21.74	21.76	19.14	38.45

Note:

ERP= Conducted Power(dBm) - Lc(dB) + G_T(dBd)G_T(dBd)=G_T(dBi)-2.15**Result:****Pass****Peak-to-average Ratio (PAR)**

Test Mode	Peak-to-average Ratio(dB)			Limit (dB)
	Lowest Channel	Middle Channel	Highest Channel	
WCDMA R99	3.72	3.72	3.85	13
HSDPA	4.71	5.03	5.58	13
HSUPA	4.68	5.16	5.1	13

Result:**Pass****FCC §2.1049, §22.917, §22.905:Occupied Bandwidth**

Operation Mode	99% Occupied Bandwidth (MHz)			26 dB Occupied Bandwidth (MHz)		
	Low Channel	Middle channel	High Channel	Low Channel	Middle Channel	High Channel
WCDMA R99	4.18	4.18	4.18	4.712	4.689	4.808
HSDPA	4.16	4.20	4.20	4.696	4.721	4.888
HSUPA	4.18	4.22	4.18	4.696	4.737	4.920

Note: The test plots please refer to the Plots of Occupied Bandwidth

FCC §2.1051, §22.917(a):Spurious Emissions at Antenna Terminal**Result:** Pass, Please refer to the test plots of Spurious Emissions at Antenna Terminal.

FCC §2.1051, §22.917(a):Out of band emission, Band Edge**Result: Pass, Please refer to the test plots of Out of band emission, Band Edge.****FCC §2.1055, §22.355: Frequency Stability**

Test Modulation:	WCDMA R99		Test Channel:	836.6	MHz
Test Item	Temperature (°C)	Voltage (V _{DC})	Frequency Error		Limit
			(Hz)	(ppm)	(ppm)
Frequency Stability vs. Temperature	-30	3.85	-0.92	-0.001	2.5
	-20	3.85	-4.40	-0.005	2.5
	-10	3.85	12.05	0.014	2.5
	0	3.85	-5.34	-0.006	2.5
	10	3.85	-7.63	-0.009	2.5
	20	3.85	-7.54	-0.009	2.5
	30	3.85	-4.40	-0.005	2.5
	40	3.85	-6.58	-0.008	2.5
Frequency Stability vs. Voltage	50	3.85	7.95	0.010	2.5
	20	3.6	8.33	0.010	2.5
	20	4.35	9.8	0.012	2.5
Result:				Pass	

Test Plots(Note: The 14.5 dB is the Insertion loss of the RF cable and Power Splitter, which was offset into the Spectrum Analyzer):

Occupied Bandwidth		
Channel	WCDMA R99	HSDPA
Lowest		
Middle		
Highest		

Occupied Bandwidth

Channel

HSUPA

Lowest

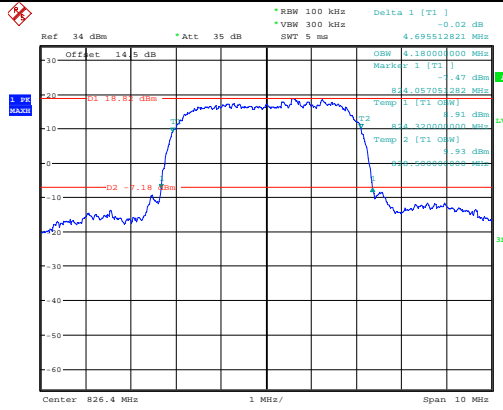

Date: 28 JUN 2023 19:28:11

Middle

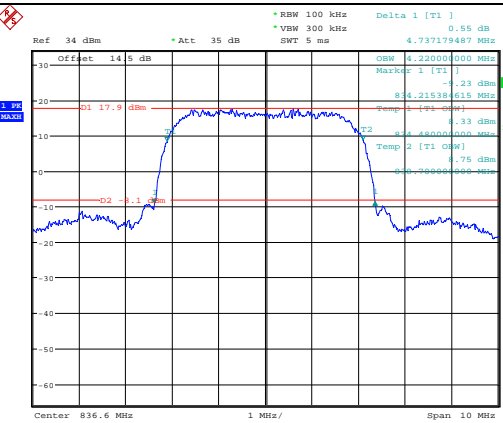

Date: 28 JUN 2023 19:42:58

Highest

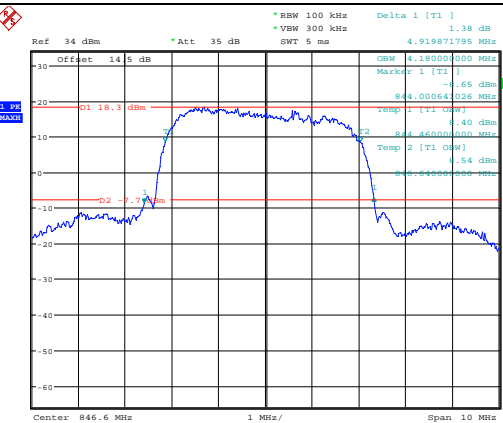

Date: 28 JUN 2023 19:54:44

Spurious Emissions at Antenna Terminal

Channel	WCDMA R99	
Lowest	<p>Ref 34 dBm *Att 35 dB *RBW 100 kHz Marker 1 [T1] -37.13 dBm *VSW 300 kHz SWT 100 ms 610.06000000 MHz</p> <p>Offset 14.5 dB D1 -13 dBm</p> <p>Start 30 MHz 97 MHz/ Stop 1 GHz</p> <p>Date: 28.JUN.2023 00:04:00</p>	<p>Ref 44 dBm *Att 35 dB *RBW 1 MHz Marker 1 [T1] -22.00 dBm *VSW 3 MHz SWT 55 ms 3.134615385 GHz</p> <p>Offset 14.5 dB D1 -13 dBm</p> <p>Start 1 GHz 900 MHz/ Stop 10 GHz</p> <p>Date: 28.JUN.2023 00:04:11</p>
Middle	<p>Ref 34 dBm *Att 35 dB *RBW 100 kHz Marker 1 [T1] -36.49 dBm *VSW 300 kHz SWT 100 ms 433.52000000 MHz</p> <p>Offset 14.5 dB D1 -13 dBm</p> <p>Start 30 MHz 97 MHz/ Stop 1 GHz</p> <p>Date: 28.JUN.2023 00:05:00</p>	<p>Ref 44 dBm *Att 35 dB *RBW 1 MHz Marker 1 [T1] -22.13 dBm *VSW 3 MHz SWT 55 ms 3.134615385 GHz</p> <p>Offset 14.5 dB D1 -13 dBm</p> <p>Start 1 GHz 900 MHz/ Stop 10 GHz</p> <p>Date: 28.JUN.2023 00:05:15</p>
Highest	<p>Ref 34 dBm *Att 35 dB *RBW 100 kHz Marker 1 [T1] -36.43 dBm *VSW 300 kHz SWT 100 ms 565.44000000 MHz</p> <p>Offset 14.5 dB D1 -13 dBm</p> <p>Start 30 MHz 97 MHz/ Stop 1 GHz</p> <p>Date: 28.JUN.2023 00:06:18</p>	<p>Ref 44 dBm *Att 35 dB *RBW 1 MHz Marker 1 [T1] -22.00 dBm *VSW 3 MHz SWT 55 ms 3.134615385 GHz</p> <p>Offset 14.5 dB D1 -13 dBm</p> <p>Start 1 GHz 900 MHz/ Stop 10 GHz</p> <p>Date: 28.JUN.2023 00:06:42</p>

Out of band emission, Band Edge

Mode	Lowest	Highest
R99	<p>Ref 34 dBm Att 35 dB RBW 100 kHz Marker 1 [T1] -16.89 dBm VSW 300 kHz SWT 100 ms 823.971429571 MHz</p> <p>Offset 14.5 dB</p> <p>D1 -13 dBm</p> <p>Center 824 MHz 1 MHz/ Span 10 MHz</p> <p>Date: 28.JUN.2023 19:19:42</p>	<p>Ref 34 dBm Att 35 dB RBW 100 kHz Marker 1 [T1] -17.93 dBm VSW 300 kHz SWT 100 ms 849.100000000 MHz</p> <p>Offset 14.5 dB</p> <p>D1 -13 dBm</p> <p>Center 849 MHz 1 MHz/ Span 10 MHz</p> <p>Date: 28.JUN.2023 19:49:20</p>
HSUPA	<p>Ref 34 dBm Att 35 dB RBW 100 kHz Marker 1 [T1] -16.46 dBm VSW 300 kHz SWT 100 ms 823.900000000 MHz</p> <p>Offset 14.5 dB</p> <p>D1 -13 dBm</p> <p>Center 824 MHz 1 MHz/ Span 10 MHz</p> <p>Date: 28.JUN.2023 19:28:48</p>	<p>Ref 34 dBm Att 35 dB RBW 100 kHz Marker 1 [T1] -17.73 dBm VSW 300 kHz SWT 100 ms 849.114295714 MHz</p> <p>Offset 14.5 dB</p> <p>D1 -13 dBm</p> <p>Center 849 MHz 1 MHz/ Span 10 MHz</p> <p>Date: 28.JUN.2023 19:55:45</p>
HSDPA	<p>Ref 34 dBm Att 35 dB RBW 100 kHz Marker 1 [T1] -17.25 dBm VSW 300 kHz SWT 100 ms 823.900000000 MHz</p> <p>Offset 14.5 dB</p> <p>D1 -13 dBm</p> <p>Center 824 MHz 1 MHz/ Span 10 MHz</p> <p>Date: 28.JUN.2023 19:24:36</p>	<p>Ref 34 dBm Att 35 dB RBW 100 kHz Marker 1 [T1] -17.55 dBm VSW 300 kHz SWT 100 ms 849.071429571 MHz</p> <p>Offset 14.5 dB</p> <p>D1 -13 dBm</p> <p>Center 849 MHz 1 MHz/ Span 10 MHz</p> <p>Date: 28.JUN.2023 19:52:50</p>

4.6 Antenna Port Test Data and Results for LTE Band 2

Serial Number:	27A0-1	Test Date:	2023/6/27-2023/7/3
Test Site:	RF	Test Mode:	Transmitting
Tester:	Claire Liu	Test Result:	Pass

Environmental Conditions:

Temperature: (°C)	24.5-26.3	Relative Humidity: (%)	41-59	ATM Pressure: (kPa)	99.8-100.7
----------------------	-----------	---------------------------	-------	------------------------	------------

Test Equipment List and Details:

Manufacturer	Description	Model	Serial Number	Calibration Date	Calibration Due Date
R&S	Spectrum Analyzer	FSU26	200256	2023/3/31	2024/3/30
zhuoxiang	Coaxial Cable	SMA-178	211001	Each time	N/A
YINSAIGE	Coaxial Cable	SS402	SJ0100001	Each time	N/A
Mini-Circuits	DC Block	BLK-18-S+	1554403	Each time	N/A
Weinschel	Power Splitter	1515	RA914	Each time	N/A
R&S	Wideband Radio Communication Tester	CMW500	149218	2023/3/31	2024/3/30
BACL	TEMP&HUMI Test Chamber	BTH-150-40	30174	2022/9/29	2023/9/28
UNI-T	Multimeter	UT39A+	C210582554	2022/9/29	2023/9/28
ZHAOXIN	DC Power Supply	RXN-6010D	21R6010D0912386	2022/7/15	2023/7/14

* Statement of Traceability: China Certification ICT Co., Ltd (Dongguan) attests that all calibrations have been performed, traceable to National Primary Standards and International System of Units (SI).

Test Frequency for Each Mode:

Operation Bandwidth	Lowest Frequency (MHz)	Middle Frequency (MHz)	Highest Frequency (MHz)
1.4MHz	1850.7	1880	1909.3
3MHz	1851.5	1880	1908.5
5MHz	1852.5	1880	1907.5
10MHz	1855	1880	1905
15MHz	1857.5	1880	1902.5
20MHz	1860	1880	1900

Test Data:

FCC§2.1046; § 24.232						
RF Output Power:						
Test Bandwidth & Modulation	Resource Block & RB offset	Conducted Average Output Power(dBm)			Maximum EIRP (dBm)	EIRP Limit (dBm)
		Lowest Channel	Middle Channel	Highest Channel		
1.4MHz QPSK	RB1#0	22.8	22.33	21.7	23.36	33
	RB1#3	22.99	22.46	21.87		
	RB1#5	22.75	22.31	21.66		
	RB3#0	22.9	22.42	21.8		
	RB3#3	22.95	22.42	21.79		
	RB6#0	21.86	21.39	20.74		
1.4MHz 16QAM	RB1#0	21.79	21.33	20.85	22.44	33
	RB1#3	22.07	21.48	21.04		
	RB1#5	21.87	21.34	20.83		
	RB3#0	22	21.59	20.77		
	RB3#3	21.93	21.57	20.72		
	RB6#0	20.86	20.44	19.88		
3MHz QPSK	RB1#0	22.84	21.79	21.73	23.21	33
	RB1#8	22.8	21.72	21.74		
	RB1#14	22.79	21.68	21.7		
	RB6#0	21.78	20.77	20.74		
	RB6#9	21.74	20.72	20.68		
	RB15#0	21.83	20.77	20.75		
3MHz 16QAM	RB1#0	21.89	21.34	20.89	22.26	33
	RB1#8	21.86	21.31	20.96		
	RB1#14	21.79	21.28	20.82		
	RB6#0	20.8	19.9	19.82		
	RB6#9	20.79	19.83	19.81		
	RB15#0	20.94	19.92	19.78		
5MHz QPSK	RB1#0	22.79	22.4	21.81	23.25	33
	RB1#13	22.88	22.47	21.94		
	RB1#24	22.69	22.33	21.74		
	RB15#0	21.89	21.57	21.06		
	RB15#10	21.8	21.44	20.81		
	RB25#0	21.85	21.46	20.93		
5MHz 16QAM	RB1#0	22.08	21.49	20.77	22.55	33
	RB1#13	22.18	21.58	20.84		
	RB1#24	22.03	21.44	20.66		
	RB15#0	20.92	20.62	20.14		
	RB15#10	20.9	20.52	19.93		
	RB25#0	20.93	20.56	20.06		
10MHz QPSK	RB1#0	22.87	22.64	21.9	23.34	33
	RB1#25	22.97	22.67	21.98		
	RB1#49	22.79	22.45	21.71		

	RB25#0	21.97	21.69	20.99		
	RB25#25	21.84	21.51	20.69		
	RB50#0	21.91	21.63	20.82		
10MHz 16QAM	RB1#0	21.89	22.1	20.96	22.62	33
	RB1#25	22.03	22.25	21.13		
	RB1#49	21.82	22.09	20.86		
	RB25#0	21.09	20.81	19.99		
	RB25#25	21.01	20.59	19.74		
	RB50#0	21.03	20.68	19.87		
15MHz QPSK	RB1#0	22.72	22.58	21.75	23.15	33
	RB1#38	22.78	22.56	21.77		
	RB1#74	22.62	22.31	21.49		
	RB36#0	21.92	21.71	20.81		
	RB36#39	21.86	21.45	20.54		
	RB75#0	21.89	21.57	20.64		
15MHz 16QAM	RB1#0	22.33	21.68	21.01	22.74	33
	RB1#38	22.37	21.7	21.07		
	RB1#74	22.07	21.52	20.97		
	RB36#0	20.92	20.69	19.74		
	RB36#39	20.86	20.49	19.58		
	RB75#0	20.92	20.63	19.65		
20MHz QPSK	RB1#0	22.57	21.56	21.75	23.27	33
	RB1#50	22.9	21.88	21.99		
	RB1#99	22.36	21.28	21.4		
	RB50#0	21.87	20.66	20.74		
	RB50#50	21.79	20.41	20.49		
	RB100#0	21.84	20.6	20.65		
20MHz 16QAM	RB1#0	21.95	20.68	21.3	22.54	33
	RB1#50	22.17	21.04	21.3		
	RB1#99	21.63	20.49	21.03		
	RB50#0	20.94	19.68	19.74		
	RB50#50	20.8	19.49	19.56		
	RB100#0	20.9	19.67	19.7		

Note: EIRP=Conducted Power(dBm) - Lc(dB) + G_T(dBi)**Result:****Pass****Peak-to-average Ratio(PAR)**

Test Bandwidth & Modulation	Resource Block & RB offset	Peak-to-average Ratio(dB)			Limit (dB)
		Lowest Channel	Middle Channel	Highest Channel	
20MHz QPSK	RB1#0	9.97	10.13	10.77	13
	RB100#0	6.54	6.35	6.41	13
20MHz 16QAM	RB1#0	9.90	10.5	10.16	13
	RB100#0	7.24	7.05	7.15	13
				Result:	Pass

FCC §2.1049, §24.238: Occupied Bandwidth						
Operation Mode	99% Occupied Bandwidth (MHz)			26 dB Occupied Bandwidth (MHz)		
	Low Channel	Middle channel	High Channel	Low Channel	Middle Channel	High Channel
1.4MHz QPSK	1.098	1.104	1.104	1.302	1.314	1.296
1.4MHz 16QAM	1.104	1.092	1.098	1.3	1.3	1.3
3MHz QPSK	2.687	2.7	2.687	2.868	2.892	2.904
3MHz 16QAM	2.687	2.687	2.687	2.89	2.89	2.89
5MHz QPSK	4.52	4.52	4.5	4.920	4.940	4.940
5MHz 16QAM	4.52	4.5	4.52	4.9	4.9	4.9
10MHz QPSK	8.96	8.96	8.92	9.600	9.560	9.560
10MHz 16QAM	8.96	8.96	8.96	9.56	9.56	9.52
15MHz QPSK	13.5	13.5	13.44	14.760	14.640	14.640
15MHz 16QAM	13.560	13.5	13.44	14.7	14.8	14.6
20MHz QPSK	18	17.92	17.84	19.440	19.200	19.120
20MHz 16QAM	18	17.92	17.84	19.28	19.28	19.12

Note: The test plots please refer to the Plots of Occupied Bandwidth

FCC §2.1051, § 24.238 (a): Spurious Emissions at Antenna Terminal	
Result:	Pass, Please refer to the test plots of Spurious Emissions at Antenna Terminal.

FCC §2.1051, § 24.238 (a): Out of band emission, Band Edge	
Result:	Pass, Please refer to the test plots of Out of band emission, Band Edge.

FCC §2.1055, §24.235: Frequency Stability						
Test Mode:	20M QPSK	Test Channel: Lowest for Lower Edge, Highest for Upper Edge				
Test Item	Temperature (°C)	Voltage (V _{DC})	Lower Edge (MHz)		Upper Edge (MHz)	
			Result	Limit	Result	Limit
Frequency Stability vs. Temperature	-30	3.85	1851.042	1850.000	1909.028	1910.000
	-20	3.85	1851.021	1850.000	1909.070	1910.000
	-10	3.85	1851.074	1850.000	1909.025	1910.000
	0	3.85	1851.056	1850.000	1909.098	1910.000
	10	3.85	1851.026	1850.000	1909.092	1910.000
	20	3.85	1851.040	1850.000	1908.960	1910.000
	30	3.85	1851.005	1850.000	1909.041	1910.000
	40	3.85	1851.054	1850.000	1909.052	1910.000
Frequency Stability vs. Voltage	20	3.6	1851.009	1850.000	1909.080	1910.000
	20	4.35	1851.060	1850.000	1909.032	1910.000
					Result:	Pass

Test Mode:	20M 16QAM	Test Channel: Lowest for Lower Edge,Highest for Upper Edge				
Test Item	Temperature (°C)	Voltage (V _{DC})	Lower Edge (MHz)		Upper Edge (MHz)	
			Result	Limit	Result	Limit
Frequency Stability vs. Temperature	-30	3.85	1851.074	1850.000	1909.036	1910.000
	-20	3.85	1851.060	1850.000	1909.031	1910.000
	-10	3.85	1851.079	1850.000	1909.002	1910.000
	0	3.85	1851.075	1850.000	1909.030	1910.000
	10	3.85	1851.069	1850.000	1909.053	1910.000
	20	3.85	1851.040	1850.000	1908.960	1910.000
	30	3.85	1851.000	1850.000	1909.053	1910.000
	40	3.85	1851.094	1850.000	1909.097	1910.000
	50	3.85	1851.055	1850.000	1909.037	1910.000
Frequency Stability vs. Voltage	20	3.6	1851.027	1850.000	1909.055	1910.000
	20	4.35	1851.005	1850.000	1909.095	1910.000
					Result:	Pass

Test Plots(Note: The 14.5 dB is the Insertion loss of the RF cable and Power Splitter, which was offset into the Spectrum Analyzer):

Occupied Bandwidth		
Channel	1.4MHz Bandwidth QPSK	1.4MHz Bandwidth 16QAM
Lowest		
Middle		
Highest		

Occupied Bandwidth

Channel	3MHz Bandwidth QPSK	3MHz Bandwidth 16QAM
Lowest		
Middle		
Highest		

Occupied Bandwidth

Channel	5MHz Bandwidth QPSK	5MHz Bandwidth 16QAM
Lowest	<p>Date: 29.JUN.2023 22:21:27</p>	<p>Date: 29.JUN.2023 22:21:48</p>
Middle	<p>Date: 29.JUN.2023 22:22:09</p>	<p>Date: 29.JUN.2023 22:22:29</p>
Highest	<p>Date: 29.JUN.2023 22:22:53</p>	<p>Date: 29.JUN.2023 22:23:16</p>

Occupied Bandwidth

Channel	10MHz Bandwidth QPSK	10MHz Bandwidth 16QAM
Lowest		
Middle		
Highest		

Occupied Bandwidth

Channel	15MHz Bandwidth QPSK	15MHz Bandwidth 16QAM
Lowest	<p>Date: 29.JUN.2023 22:35:35</p>	<p>Date: 29.JUN.2023 22:35:59</p>
Middle	<p>Date: 29.JUN.2023 22:36:21</p>	<p>Date: 29.JUN.2023 22:36:41</p>
Highest	<p>Date: 29.JUN.2023 22:37:02</p>	<p>Date: 29.JUN.2023 22:37:22</p>

Occupied Bandwidth

Channel	20MHz Bandwidth QPSK	20MHz Bandwidth 16QAM
Lowest		
Middle		
Highest		

Spurious Emissions at Antenna Terminal

Channel

1.4MHz Bandwidth QPSK

Lowest

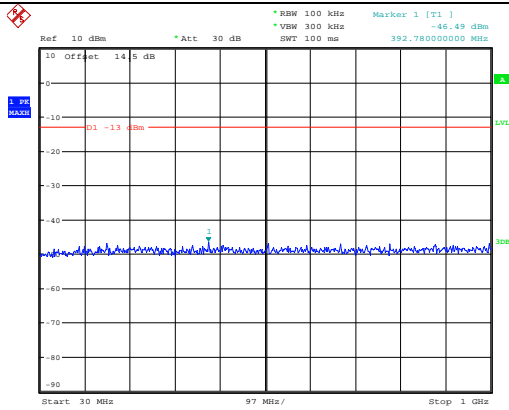

Date: 30.JUN.2023 11:44:47

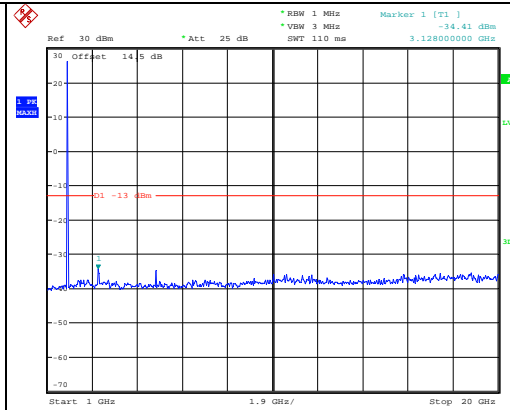

Date: 30.JUN.2023 11:45:00

Middle

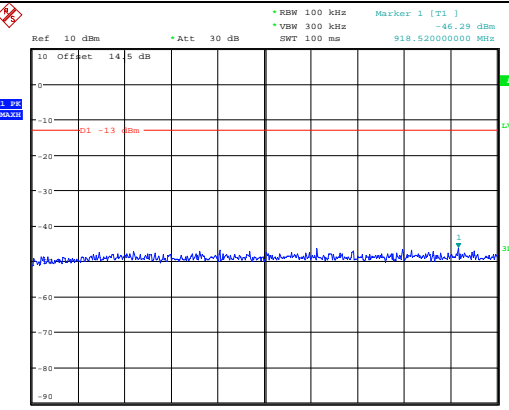

Date: 30.JUN.2023 11:45:15

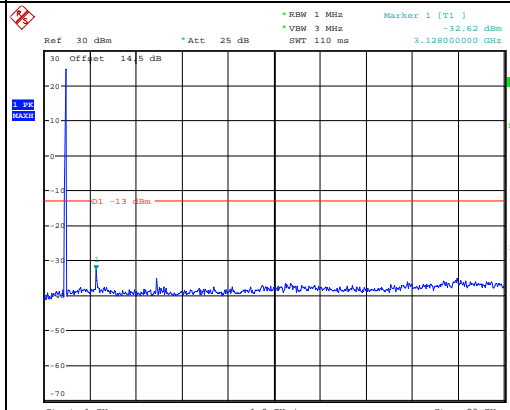

Date: 30.JUN.2023 11:45:28

Highest

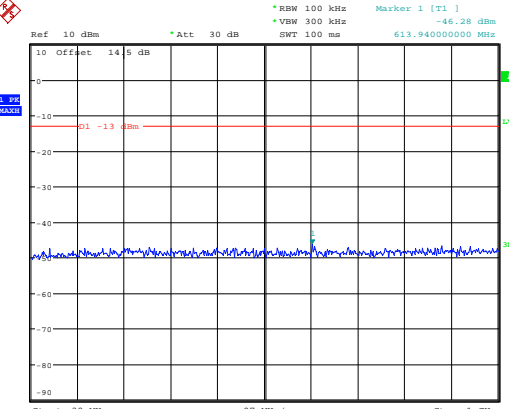

Date: 30.JUN.2023 11:45:46

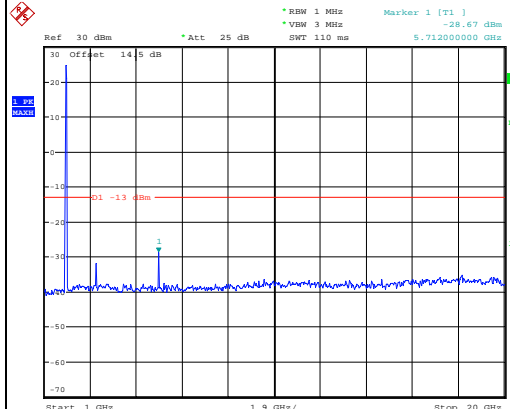

Date: 30.JUN.2023 11:45:59

Spurious Emissions at Antenna Terminal

Channel	3MHz Bandwidth QPSK	
Lowest	<p>Ref 10 dBm *Att 30 dB *RBW 100 kHz *VMW 300 kHz *SWT 100 ms *Marker 1 [T1] -46.39 dBm 813.760000000 MHz</p> <p>10 Offset 14.5 dB -10 D1 -13 dBm -20 -30 -40 -50 -60 -70 -80 -90</p> <p>Start 30 MHz 97 MHz/ Stop 1 GHz</p> <p>Date: 30.JUN.2023 11:47:03</p>	<p>Ref 30 dBm *Att 25 dB *RBW 1 MHz *VMW 3 MHz *SWT 110 ms *Marker 1 [T1] -34.05 dBm 3.128000000 GHz</p> <p>30 Offset 14.5 dB -20 -10 D1 -13 dBm -20 -30 -40 -50 -60 -70</p> <p>Start 1 GHz 1.9 GHz/ Stop 20 GHz</p> <p>Date: 30.JUN.2023 11:47:15</p>
Middle	<p>Ref 10 dBm *Att 30 dB *RBW 100 kHz *VMW 300 kHz *SWT 100 ms *Marker 1 [T1] -46.30 dBm 943.740000000 MHz</p> <p>10 Offset 14.5 dB -10 D1 -13 dBm -20 -30 -40 -50 -60 -70 -80 -90</p> <p>Start 30 MHz 97 MHz/ Stop 1 GHz</p> <p>Date: 30.JUN.2023 11:47:31</p>	<p>Ref 30 dBm *Att 25 dB *RBW 1 MHz *VMW 3 MHz *SWT 110 ms *Marker 1 [T1] -27.70 dBm 1.798000000 GHz</p> <p>30 Offset 14.5 dB -20 -10 D1 -13 dBm -20 -30 -40 -50 -60 -70</p> <p>Start 1 GHz 1.9 GHz/ Stop 20 GHz</p> <p>Date: 30.JUN.2023 11:47:44</p>
Highest	<p>Ref 10 dBm *Att 30 dB *RBW 100 kHz *VMW 300 kHz *SWT 100 ms *Marker 1 [T1] -46.37 dBm 848.680000000 MHz</p> <p>10 Offset 14.5 dB -10 D1 -13 dBm -20 -30 -40 -50 -60 -70 -80 -90</p> <p>Start 30 MHz 97 MHz/ Stop 1 GHz</p> <p>Date: 30.JUN.2023 11:47:59</p>	<p>Ref 30 dBm *Att 25 dB *RBW 1 MHz *VMW 3 MHz *SWT 110 ms *Marker 1 [T1] -32.97 dBm 5.712000000 GHz</p> <p>30 Offset 14.5 dB -20 -10 D1 -13 dBm -20 -30 -40 -50 -60 -70</p> <p>Start 1 GHz 1.9 GHz/ Stop 20 GHz</p> <p>Date: 30.JUN.2023 11:48:11</p>

Spurious Emissions at Antenna Terminal

Channel

5MHz Bandwidth QPSK

Lowest

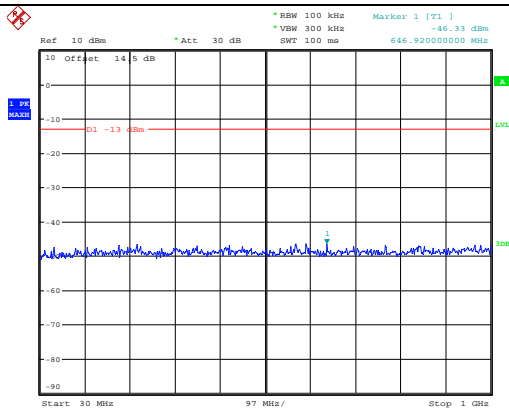

Date: 30.JUN.2023 11:54:14

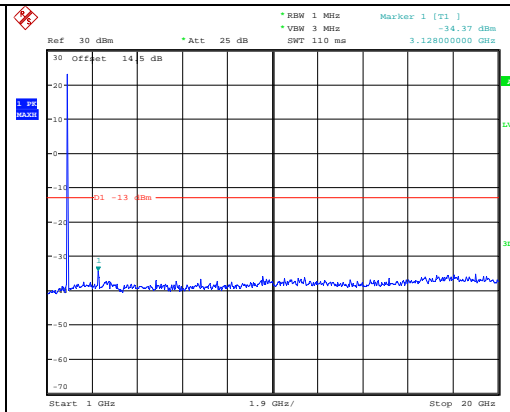

Date: 30.JUN.2023 11:54:27

Middle

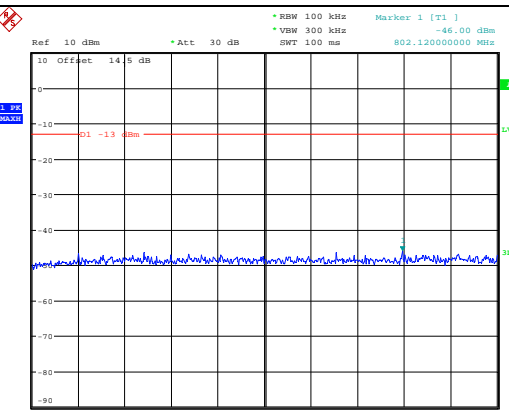

Date: 30.JUN.2023 11:54:45

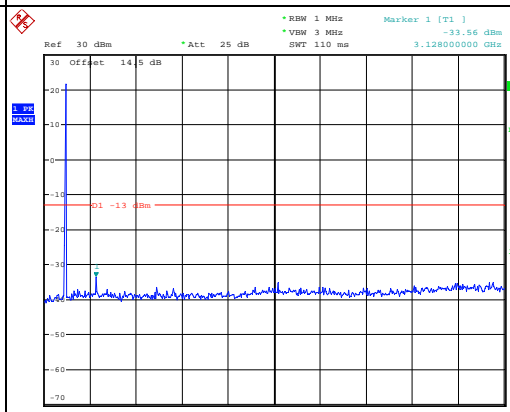

Date: 30.JUN.2023 11:54:58

Highest

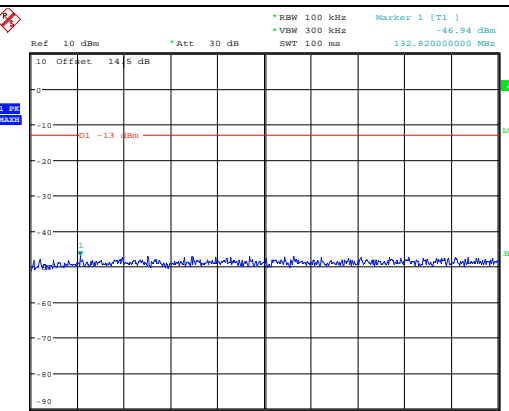

Date: 30.JUN.2023 11:55:13

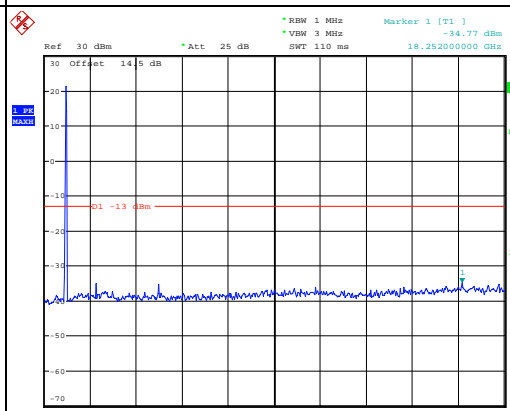

Date: 30.JUN.2023 11:55:27

Spurious Emissions at Antenna Terminal

Channel	10MHz Bandwidth QPSK	
Lowest	<p>Ref: 10 dBm Att: 30 dB RBW: 100 kHz Marker 1 [T1] -46.16 dBm * VSW: 300 kHz * VSW: 300 kHz * VSW: 300 kHz * VSW: 300 kHz * VSW: 300 kHz * SWT: 100 ms * SWT: 100 ms * SWT: 100 ms * SWT: 100 ms * SWT: 100 ms 412.18800000 MHz</p> <p>Start: 30 MHz 97 MHz/ Stop: 1 GHz</p> <p>Date: 30.JUN.2023 12:47:02</p>	<p>Ref: 30 dBm Att: 25 dB RBW: 1 MHz Marker 1 [T1] -32.65 dBm * VSW: 3 MHz * VSW: 3 MHz * VSW: 3 MHz * VSW: 3 MHz * VSW: 3 MHz * SWT: 110 ms * SWT: 110 ms * SWT: 110 ms * SWT: 110 ms * SWT: 110 ms 3.128000000 GHz</p> <p>Start: 1 GHz 1.9 GHz/ Stop: 20 GHz</p> <p>Date: 30.JUN.2023 12:47:15</p>
Middle	<p>Ref: 10 dBm Att: 30 dB RBW: 100 kHz Marker 1 [T1] -46.84 dBm * VSW: 300 kHz * VSW: 300 kHz * VSW: 300 kHz * VSW: 300 kHz * VSW: 300 kHz * SWT: 100 ms * SWT: 100 ms * SWT: 100 ms * SWT: 100 ms * SWT: 100 ms 427.70000000 MHz</p> <p>Start: 30 MHz 97 MHz/ Stop: 1 GHz</p> <p>Date: 30.JUN.2023 12:47:33</p>	<p>Ref: 30 dBm Att: 25 dB RBW: 1 MHz Marker 1 [T1] -33.44 dBm * VSW: 3 MHz * VSW: 3 MHz * VSW: 3 MHz * VSW: 3 MHz * VSW: 3 MHz * SWT: 110 ms * SWT: 110 ms * SWT: 110 ms * SWT: 110 ms * SWT: 110 ms 3.128000000 GHz</p> <p>Start: 1 GHz 1.9 GHz/ Stop: 20 GHz</p> <p>Date: 30.JUN.2023 12:47:46</p>
Highest	<p>Ref: 10 dBm Att: 30 dB RBW: 100 kHz Marker 1 [T1] -46.39 dBm * VSW: 300 kHz * VSW: 300 kHz * VSW: 300 kHz * VSW: 300 kHz * VSW: 300 kHz * SWT: 100 ms * SWT: 100 ms * SWT: 100 ms * SWT: 100 ms * SWT: 100 ms 829.28000000 MHz</p> <p>Start: 30 MHz 97 MHz/ Stop: 1 GHz</p> <p>Date: 30.JUN.2023 12:48:01</p>	<p>Ref: 30 dBm Att: 25 dB RBW: 1 MHz Marker 1 [T1] -34.28 dBm * VSW: 3 MHz * VSW: 3 MHz * VSW: 3 MHz * VSW: 3 MHz * VSW: 3 MHz * SWT: 110 ms * SWT: 110 ms * SWT: 110 ms * SWT: 110 ms * SWT: 110 ms 3.128000000 GHz</p> <p>Start: 1 GHz 1.9 GHz/ Stop: 20 GHz</p> <p>Date: 30.JUN.2023 12:48:14</p>

Spurious Emissions at Antenna Terminal

Channel

15MHz Bandwidth QPSK

Lowest

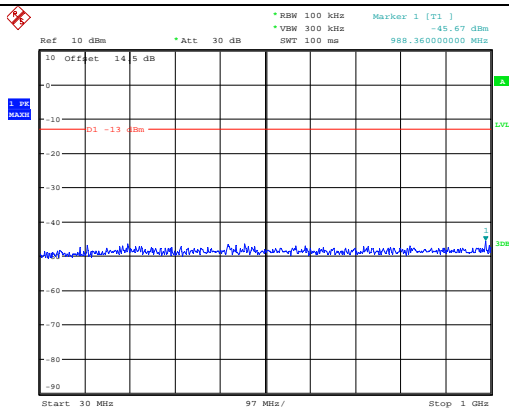

Date: 30.JUN.2023 12:55:41

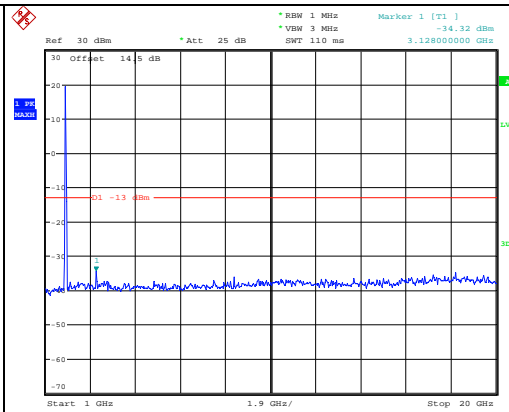

Date: 30.JUN.2023 12:55:54

Middle

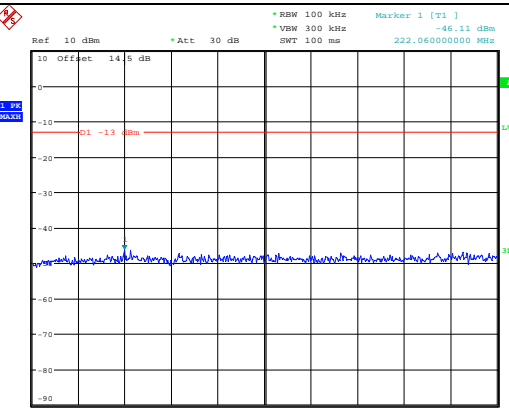

Date: 30.JUN.2023 12:56:09

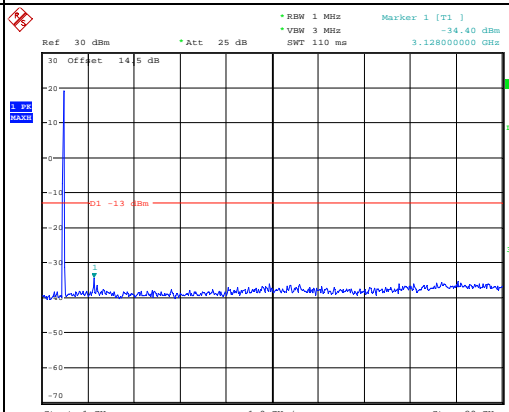

Date: 30.JUN.2023 12:56:22

Highest

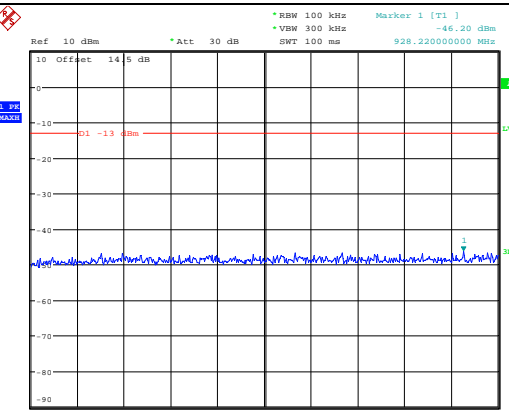

Date: 30.JUN.2023 12:56:40

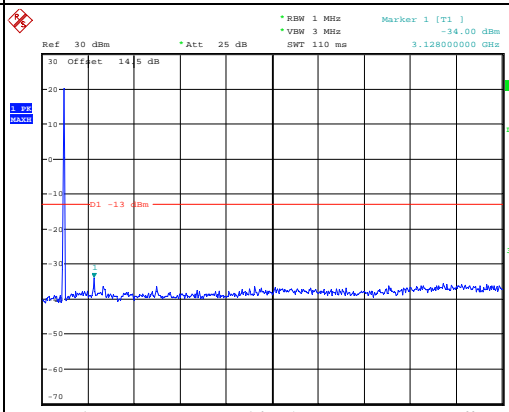

Date: 30.JUN.2023 12:56:53

Spurious Emissions at Antenna Terminal

Channel	20MHz Bandwidth QPSK	
Lowest	<p>Ref 10 dBm Att 30 dB *RBW 100 kHz Marker 1 [T1] -46.33 dBm *VMW 300 kHz -46.33 dBm SWT 100 ms 641.100000000 MHz</p> <p>Start 30 MHz 97 MHz/ Stop 1 GHz</p> <p>Date: 30.JUN.2023 12:57:57</p>	<p>Ref 30 dBm Att 25 dB *RBW 1 MHz Marker 1 [T1] -33.67 dBm *VMW 3 MHz -33.67 dBm SWT 110 ms 3.128000000 GHz</p> <p>Start 1 GHz 1.9 GHz/ Stop 20 GHz</p> <p>Date: 30.JUN.2023 12:58:10</p>
Middle	<p>Ref 10 dBm Att 30 dB *RBW 100 kHz Marker 1 [T1] -46.57 dBm *VMW 300 kHz -46.57 dBm SWT 100 ms 906.880000000 MHz</p> <p>Start 30 MHz 97 MHz/ Stop 1 GHz</p> <p>Date: 30.JUN.2023 12:58:25</p>	<p>Ref 30 dBm Att 25 dB *RBW 1 MHz Marker 1 [T1] -33.28 dBm *VMW 3 MHz -33.28 dBm SWT 110 ms 3.128000000 GHz</p> <p>Start 1 GHz 1.9 GHz/ Stop 20 GHz</p> <p>Date: 30.JUN.2023 12:58:38</p>
Highest	<p>Ref 10 dBm Att 30 dB *RBW 100 kHz Marker 1 [T1] -46.43 dBm *VMW 300 kHz -46.43 dBm SWT 100 ms 183.260000000 MHz</p> <p>Start 30 MHz 97 MHz/ Stop 1 GHz</p> <p>Date: 30.JUN.2023 12:58:53</p>	<p>Ref 30 dBm Att 25 dB *RBW 1 MHz Marker 1 [T1] -33.67 dBm *VMW 3 MHz -33.67 dBm SWT 110 ms 3.128000000 GHz</p> <p>Start 1 GHz 1.9 GHz/ Stop 20 GHz</p> <p>Date: 30.JUN.2023 12:59:06</p>

Out of band emission, Band Edge

Mode	Lowest	Highest
QPSK 1.4MHz	<p>Ref 30 dBm Att 25 dB RBW 30 kHz Marker 1 [T1] -25.86 dBm VSM 100 kHz SWT 35 ms 1.850000000 GHz</p> <p>30 Offset 14.5 dB -10 D1 -13 dBm SWP 50 OF 50</p> <p>Center 1.85 GHz 300 kHz/ Span 3 MHz</p> <p>Date: 30.JUN.2023 09:25:39</p>	<p>Ref 30 dBm Att 25 dB RBW 30 kHz Marker 1 [T1] -25.26 dBm VSM 100 kHz SWT 35 ms 1.910000000 GHz</p> <p>30 Offset 14.5 dB -10 D1 -13 dBm SWP 50 OF 50</p> <p>Center 1.91 GHz 300 kHz/ Span 3 MHz</p> <p>Date: 30.JUN.2023 09:25:56</p>
QPSK 3MHz	<p>Ref 30 dBm Att 25 dB RBW 30 kHz Marker 1 [T1] -32.73 dBm VSM 100 kHz SWT 35 ms 1.850000000 GHz</p> <p>30 Offset 14.5 dB -10 D1 -13 dBm SWP 50 OF 50</p> <p>Center 1.85 GHz 600 kHz/ Span 6 MHz</p> <p>Date: 30.JUN.2023 09:27:36</p>	<p>Ref 30 dBm Att 25 dB RBW 30 kHz Marker 1 [T1] -32.00 dBm VSM 100 kHz SWT 35 ms 1.910000000 GHz</p> <p>30 Offset 14.5 dB -10 D1 -13 dBm SWP 50 OF 50</p> <p>Center 1.91 GHz 600 kHz/ Span 6 MHz</p> <p>Date: 30.JUN.2023 09:27:54</p>
QPSK 5MHz	<p>Ref 30 dBm Att 25 dB RBW 100 kHz Marker 1 [T1] -28.47 dBm VSM 500 kHz SWT 35 ms 1.850000000 GHz</p> <p>30 Offset 14.5 dB -10 D1 -13 dBm SWP 50 OF 50</p> <p>Center 1.85 GHz 1 MHz/ Span 10 MHz</p> <p>Date: 30.JUN.2023 09:28:43</p>	<p>Ref 30 dBm Att 25 dB RBW 100 kHz Marker 1 [T1] -29.09 dBm VSM 500 kHz SWT 35 ms 1.910000000 GHz</p> <p>30 Offset 14.5 dB -10 D1 -13 dBm SWP 50 OF 50</p> <p>Center 1.91 GHz 1 MHz/ Span 10 MHz</p> <p>Date: 30.JUN.2023 09:29:01</p>

Out of band emission, Band Edge

Mode	Lowest	Highest
QPSK 10MHz		
QPSK 15MHz		
QPSK 20MHz		

Out of band emission, Band Edge

Mode	Lowest	Highest
16QAM 1.4MHz	<p>Date: 30.JUN.2023 09:25:47</p>	<p>Date: 30.JUN.2023 09:26:04</p>
16QAM 3MHz	<p>Date: 30.JUN.2023 09:27:44</p>	<p>Date: 30.JUN.2023 09:28:03</p>
16QAM 5MHz	<p>Date: 30.JUN.2023 09:28:51</p>	<p>Date: 30.JUN.2023 09:29:10</p>

Out of band emission, Band Edge

Mode	Lowest	Highest
16QAM 10MHz	<p>Date: 30.JUN.2023 09:30:00</p>	<p>Date: 30.JUN.2023 09:30:20</p>
16QAM 15MHz	<p>Date: 30.JUN.2023 09:32:38</p>	<p>Date: 30.JUN.2023 09:32:58</p>
16QAM 20MHz	<p>Date: 30.JUN.2023 09:41:59</p>	<p>Date: 30.JUN.2023 09:42:18</p>

4.7 Antenna Port Test Data and Results for LTE Band 4

Serial Number:	27A0-1	Test Date:	2023/6/27-2023/7/3
Test Site:	RF	Test Mode:	Transmitting
Tester:	Claire Liu	Test Result:	Pass

Environmental Conditions:

Temperature: (°C)	24.5-26.3	Relative Humidity: (%)	41-59	ATM Pressure: (kPa)	99.8-100.7
----------------------	-----------	---------------------------	-------	------------------------	------------

Test Equipment List and Details:

Manufacturer	Description	Model	Serial Number	Calibration Date	Calibration Due Date
R&S	Spectrum Analyzer	FSU26	200256	2023/3/31	2024/3/30
zhuoxiang	Coaxial Cable	SMA-178	211001	Each time	N/A
YINSAIGE	Coaxial Cable	SS402	SJ0100001	Each time	N/A
Mini-Circuits	DC Block	BLK-18-S+	1554403	Each time	N/A
Weinschel	Power Splitter	1515	RA914	Each time	N/A
R&S	Wideband Radio Communication Tester	CMW500	149218	2023/3/31	2024/3/30
BACL	TEMP&HUMI Test Chamber	BTH-150-40	30174	2022/9/29	2023/9/28
UNI-T	Multimeter	UT39A+	C210582554	2022/9/29	2023/9/28
ZHAOXIN	DC Power Supply	RXN-6010D	21R6010D0912386	2022/7/15	2023/7/14

* Statement of Traceability: China Certification ICT Co., Ltd (Dongguan) attests that all calibrations have been performed, traceable to National Primary Standards and International System of Units (SI).

Test Frequency for Each Mode:

Operation Bandwidth	Lowest Frequency (MHz)	Middle Frequency (MHz)	Highest Frequency (MHz)
1.4MHz	1710.7	1732.5	1754.3
3MHz	1711.5	1732.5	1753.5
5MHz	1712.5	1732.5	1752.5
10MHz	1715	1732.5	1750
15MHz	1717.5	1732.5	1747.5
20MHz	1720	1732.5	1745

Test Data:

FCC§2.1046;§ 27.50(d)(4)						
RF Output Power:						
Test Bandwidth & Modulation	Resource Block & RB offset	Conducted Average Output Power(dBm)			Maximum EIRP (dBm)	EIRP Limit (dBm)
		Lowest Channel	Middle Channel	Highest Channel		
1.4MHz QPSK	RB1#0	23.58	23.35	22.58	24.03	30
	RB1#3	23.75	23.28	22.83		
	RB1#5	23.53	22.82	22.54		
	RB3#0	23.7	22.93	22.72		
	RB3#3	23.71	22.98	22.56		
	RB6#0	22.66	21.93	21.63		
1.4MHz 16QAM	RB1#0	22.71	21.88	21.45	23.22	30
	RB1#3	22.94	22.13	21.68		
	RB1#5	22.67	22.03	21.5		
	RB3#0	22.62	22.04	21.83		
	RB3#3	22.66	22.07	22.14		
	RB6#0	21.74	20.92	20.99		
3MHz QPSK	RB1#0	23.48	22.99	23.59	23.87	30
	RB1#8	23.46	23	23.53		
	RB1#14	23.32	23	23.55		
	RB6#0	22.41	21.93	22.42		
	RB6#9	22.35	21.92	22.43		
	RB15#0	22.43	21.99	22.44		
3MHz 16QAM	RB1#0	23.01	22.13	22.44	23.29	30
	RB1#8	22.96	22.12	22.41		
	RB1#14	22.92	22.11	22.35		
	RB6#0	21.55	21.03	21.38		
	RB6#9	21.48	21.06	21.36		
	RB15#0	21.59	21.01	21.51		
5MHz QPSK	RB1#0	23.35	23.12	22.72	23.73	30
	RB1#13	23.45	23.28	22.81		
	RB1#24	23.31	23.13	22.59		
	RB15#0	22.47	22.19	21.7		
	RB15#10	22.48	22.18	21.83		
	RB25#0	22.43	22.18	21.74		
5MHz 16QAM	RB1#0	22.29	22.35	21.7	22.81	30
	RB1#13	22.33	22.53	21.81		
	RB1#24	22.23	22.35	21.69		
	RB15#0	21.57	21.24	20.85		
	RB15#10	21.59	21.28	20.87		
	RB25#0	21.54	21.24	20.87		
10MHz QPSK	RB1#0	23.49	23.49	23.03	24.01	30
	RB1#25	23.6	23.73	23.28		
	RB1#49	23.32	23.55	23.07		

	RB25#0	22.51	22.55	21.97		
	RB25#25	22.48	22.56	22.01		
	RB50#0	22.49	22.53	21.99		
10MHz 16QAM	RB1#0	23.05	22.64	21.85	23.47	30
	RB1#25	23.19	22.81	22.13		
	RB1#49	22.97	22.62	21.88		
	RB25#0	21.68	21.65	21.1		
	RB25#25	21.62	21.66	21.12		
	RB50#0	21.56	21.64	21.07		
15MHz QPSK	RB1#0	23.43	23.29	22.89	23.73	30
	RB1#38	23.45	23.44	23.09		
	RB1#74	23.29	23.29	22.81		
	RB36#0	22.53	22.44	22.01		
	RB36#39	22.46	22.5	22.08		
	RB75#0	22.5	22.51	22.12		
15MHz 16QAM	RB1#0	22.8	22.85	21.9	23.23	30
	RB1#38	22.88	22.95	22.03		
	RB1#74	22.69	22.66	21.93		
	RB36#0	21.53	21.49	20.99		
	RB36#39	21.47	21.5	21.1		
	RB75#0	21.5	21.53	21.08		
20MHz QPSK	RB1#0	23.22	23.22	22.31	23.88	30
	RB1#50	23.57	23.6	22.72		
	RB1#99	23.1	22.85	22.07		
	RB50#0	22.48	22.2	21.42		
	RB50#50	22.34	21.98	21.65		
	RB100#0	22.43	22.08	21.29		
20MHz 16QAM	RB1#0	22.42	22.06	21.7	23.13	30
	RB1#50	22.85	22.44	22.15		
	RB1#99	22.18	22.03	21.63		
	RB50#0	21.54	21.2	20.61		
	RB50#50	21.41	21.21	20.82		
	RB100#0	21.51	21.41	20.87		

Note: EIRP=Conducted Power(dBm) - Lc(dB) + G_T(dBi)**Result:****Pass****Peak-to-average Ratio(PAR)**

Test Bandwidth & Modulation	Resource Block & RB offset	Peak-to-average Ratio(dB)			Limit (dB)
		Lowest Channel	Middle Channel	Highest Channel	
20MHz QPSK	RB1#0	10.22	10.38	10.77	13
	RB100#0	6.51	6.41	6.47	13
20MHz 16QAM	RB1#0	12.92	10.83	11.22	13
	RB100#0	7.24	7.21	7.18	13
				Result:	Pass

FCC §2.1049, §27.53:Occupied Bandwidth						
Operation Mode	99% Occupied Bandwidth (MHz)			26 dB Occupied Bandwidth (MHz)		
	Low Channel	Middle channel	High Channel	Low Channel	Middle Channel	High Channel
1.4MHz QPSK	1.104	1.11	1.104	1.296	1.30	1.326
1.4MHz 16QAM	1.092	1.092	1.11	1.278	1.302	1.31
3MHz QPSK	2.687	2.687	2.687	2.880	2.856	2.868
3MHz 16QAM	2.687	2.687	2.687	2.868	2.892	2.892
5MHz QPSK	4.52	4.52	4.52	4.94	4.94	4.94
5MHz 16QAM	4.5	4.52	4.52	5.0	4.90	4.96
10MHz QPSK	8.96	8.96	8.96	9.64	9.64	9.60
10MHz 16QAM	8.96	8.96	8.96	9.68	9.52	9.60
15MHz QPSK	13.5	13.5	13.5	14.8	14.8	14.6
15MHz 16QAM	13.5	13.44	13.5	14.7	14.70	14.6
20MHz QPSK	18	17.92	18	20	19.28	19
20MHz 16QAM	18	18	17.92	19	19	19.44

Note: The test plots please refer to the Plots of Occupied Bandwidth

FCC §2.1051, § 27.53:Spurious Emissions at Antenna Terminal	
Result:	Pass, Please refer to the test plots of Spurious Emissions at Antenna Terminal.

FCC §2.1051, § 27.53:Out of band emission, Band Edge	
Result:	Pass, Please refer to the test plots of Out of band emission, Band Edge.

FCC §2.1055, §27.54: Frequency Stability						
Test Mode:	20M QPSK	Test Channel: Lowest for Lower Edge,Highest for Upper Edge				
Test Item	Temperature (°C)	Voltage (V _{DC})	Lower Edge (MHz)		Upper Edge (MHz)	
			Result	Limit	Result	Limit
Frequency Stability vs. Temperature	-30	3.85	1711.049	1710.00	1754.010	1755
	-20	3.85	1711.002	1710.00	1754.047	1755
	-10	3.85	1711.026	1710.00	1754.005	1755
	0	3.85	1711.037	1710.00	1754.063	1755
	10	3.85	1711.062	1710.00	1754.084	1755
	20	3.85	1711.040	1710.00	1754.040	1755
	30	3.85	1711.002	1710.00	1754.030	1755
	40	3.85	1711.016	1710.00	1754.087	1755
	50	3.85	1711.038	1710.00	1754.073	1755
Frequency Stability vs. Voltage	20	3.6	1711.082	1710.00	1754.060	1755
	20	4.35	1711.019	1710.00	1754.061	1755
					Result:	Pass

Test Mode:	20M 16QAM	Test Channel: Lowest for Lower Edge,Highest for Upper Edge				
Test Item	Temperature (°C)	Voltage (V _{DC})	Lower Edge (MHz)		Upper Edge (MHz)	
			Result	Limit	Result	Limit
Frequency Stability vs. Temperature	-30	3.85	1711.055	1710.00	1753.978	1755
	-20	3.85	1711.065	1710.00	1753.928	1755
	-10	3.85	1711.029	1710.00	1753.966	1755
	0	3.85	1711.076	1710.00	1753.921	1755
	10	3.85	1711.083	1710.00	1753.972	1755
	20	3.85	1711.040	1710.00	1753.960	1755
	30	3.85	1711.034	1710.00	1753.969	1755
	40	3.85	1711.099	1710.00	1753.972	1755
	50	3.85	1711.074	1710.00	1753.901	1755
Frequency Stability vs. Voltage	20	3.6	1711.042	1710.00	1753.923	1755
	20	4.35	1711.014	1710.00	1753.948	1755
					Result:	Pass

Test Plots(Note: The 14.5 dB is the Insertion loss of the RF cable and Power Splitter, which was offset into the Spectrum Analyzer):

Occupied Bandwidth		
Channel	1.4MHz Bandwidth QPSK	1.4MHz Bandwidth 16QAM
Lowest		
Middle		
Highest		

Occupied Bandwidth

Channel	3MHz Bandwidth QPSK	3MHz Bandwidth 16QAM
Lowest		
Middle		
Highest		

Occupied Bandwidth

Channel	5MHz Bandwidth QPSK	5MHz Bandwidth 16QAM
Lowest	<p>Ref 30 dBm *Att 25 dB *RBW 100 kHz Delta 1 [T1] *VMW 300 kHz -2.35 dB SWT 5 ms 4.940000000 MHz OSW 4.520000000 MHz Marker 1 [T1] -11.21 dBm D1 16.33 dBm Temp 1 [T1 OSW] Temp 2 [T1 OSW]</p> <p>Center 1.7325 GHz 1 MHz/ Span 10 MHz</p> <p>Date: 29.JUN.2023 22:45:31</p>	<p>Ref 30 dBm *Att 25 dB *RBW 100 kHz Delta 1 [T1] *VMW 300 kHz -0.50 dB SWT 5 ms 4.960000000 MHz OSW 4.960000000 MHz Marker 1 [T1] -11.05 dBm D1 14.92 dBm Temp 1 [T1 OSW] Temp 2 [T1 OSW]</p> <p>Center 1.7325 GHz 1 MHz/ Span 10 MHz</p> <p>Date: 29.JUN.2023 22:45:55</p>
Middle	<p>Ref 30 dBm *Att 25 dB *RBW 100 kHz Delta 1 [T1] *VMW 300 kHz -2.04 dB SWT 5 ms 4.940000000 MHz OSW 4.520000000 MHz Marker 1 [T1] -11.21 dBm D1 16.93 dBm Temp 1 [T1 OSW] Temp 2 [T1 OSW]</p> <p>Center 1.7325 GHz 1 MHz/ Span 10 MHz</p> <p>Date: 29.JUN.2023 22:46:23</p>	<p>Ref 30 dBm *Att 25 dB *RBW 100 kHz Delta 1 [T1] *VMW 300 kHz -0.32 dB SWT 5 ms 4.960000000 MHz OSW 4.960000000 MHz Marker 1 [T1] -11.21 dBm D1 16.57 dBm Temp 1 [T1 OSW] Temp 2 [T1 OSW]</p> <p>Center 1.7325 GHz 1 MHz/ Span 10 MHz</p> <p>Date: 29.JUN.2023 22:46:43</p>
Highest	<p>Ref 30 dBm *Att 25 dB *RBW 100 kHz Delta 1 [T1] *VMW 300 kHz -0.16 dB SWT 5 ms 4.940000000 MHz OSW 4.520000000 MHz Marker 1 [T1] -11.21 dBm D1 16.33 dBm Temp 1 [T1 OSW] Temp 2 [T1 OSW]</p> <p>Center 1.7325 GHz 1 MHz/ Span 10 MHz</p> <p>Date: 29.JUN.2023 22:47:11</p>	<p>Ref 30 dBm *Att 25 dB *RBW 100 kHz Delta 1 [T1] *VMW 300 kHz -0.39 dB SWT 5 ms 4.960000000 MHz OSW 4.960000000 MHz Marker 1 [T1] -10.87 dBm D1 15.14 dBm Temp 1 [T1 OSW] Temp 2 [T1 OSW]</p> <p>Center 1.7325 GHz 1 MHz/ Span 10 MHz</p> <p>Date: 29.JUN.2023 22:47:34</p>

Occupied Bandwidth

Channel	10MHz Bandwidth QPSK	10MHz Bandwidth 16QAM
Lowest	<p>Ref 30 dBm Offset 14.5 dB Att 25 dB *RBW 100 kHz *VBW 300 kHz Delta 1 [T1] 0.91 dB OSW 9.640000000 MHz Marker 1 [T1] 13.94 dBm Temp 1 [T1] OSW 1.715000000 GHz Temp 2 [T1] OSW 1.719480000 GHz Center 1.715 GHz 2 MHz/ Span 20 MHz</p> <p>Date: 29.JUN.2023 22:48:20</p>	<p>Ref 30 dBm Offset 14.5 dB Att 25 dB *RBW 100 kHz *VBW 300 kHz Delta 1 [T1] 0.63 dB OSW 9.680000000 MHz Marker 1 [T1] 12.84 dBm Temp 1 [T1] OSW 1.715000000 GHz Temp 2 [T1] OSW 1.719480000 GHz Center 1.715 GHz 2 MHz/ Span 20 MHz</p> <p>Date: 29.JUN.2023 22:48:40</p>
Middle	<p>Ref 30 dBm Offset 14.5 dB Att 25 dB *RBW 100 kHz *VBW 300 kHz Delta 1 [T1] 0.90 dB OSW 9.640000000 MHz Marker 1 [T1] 14.04 dBm Temp 1 [T1] OSW 1.732500000 GHz Temp 2 [T1] OSW 1.736980000 GHz Center 1.7325 GHz 2 MHz/ Span 20 MHz</p> <p>Date: 29.JUN.2023 22:49:01</p>	<p>Ref 30 dBm Offset 14.5 dB Att 25 dB *RBW 100 kHz *VBW 300 kHz Delta 1 [T1] -0.21 dB OSW 9.520000000 MHz Marker 1 [T1] 12.74 dBm Temp 1 [T1] OSW 1.732500000 GHz Temp 2 [T1] OSW 1.736980000 GHz Center 1.7325 GHz 2 MHz/ Span 20 MHz</p> <p>Date: 29.JUN.2023 22:49:24</p>
Highest	<p>Ref 30 dBm Offset 14.5 dB Att 25 dB *RBW 100 kHz *VBW 300 kHz Delta 1 [T1] -1.29 dB OSW 9.600000000 MHz Marker 1 [T1] 13.04 dBm Temp 1 [T1] OSW 1.745200000 GHz Temp 2 [T1] OSW 1.745520000 GHz Temp 3 [T1] OSW 1.754480000 GHz Center 1.75 GHz 2 MHz/ Span 20 MHz</p> <p>Date: 29.JUN.2023 22:49:45</p>	<p>Ref 30 dBm Offset 14.5 dB Att 25 dB *RBW 100 kHz *VBW 300 kHz Delta 1 [T1] 0.24 dB OSW 9.600000000 MHz Marker 1 [T1] 12.2 dBm Temp 1 [T1] OSW 1.745200000 GHz Temp 2 [T1] OSW 1.745520000 GHz Temp 3 [T1] OSW 1.754480000 GHz Center 1.75 GHz 2 MHz/ Span 20 MHz</p> <p>Date: 29.JUN.2023 22:50:05</p>

Occupied Bandwidth

Channel	15MHz Bandwidth QPSK	15MHz Bandwidth 16QAM
Lowest		
Middle		
Highest		

Occupied Bandwidth

Channel	20MHz Bandwidth QPSK	20MHz Bandwidth 16QAM
Lowest	<p>Ref 30 dBm *Att 25 dB *RBW 300 kHz Delta 1 [T1] -1.24 dB *VSW 1 MHz *SWT 2.5 ms OSW 19.52000000 MHz Marker 1 [T1] -11.62 dBm D1 16.35 dBm D2 -11.62 dBm Temp 1 [T1 OSW] 1.71040000 GHz Temp 2 [T1 OSW] 1.72904000 GHz Center 1.72 GHz 4 MHz/ Span 40 MHz Date: 29.JUN.2023 22:53:30</p>	<p>Ref 30 dBm *Att 25 dB *RBW 300 kHz Delta 1 [T1] -0.84 dB *VSW 1 MHz *SWT 2.5 ms OSW 19.20000000 MHz Marker 1 [T1] -11.67 dBm D1 16.04 dBm D2 -11.67 dBm Temp 1 [T1 OSW] 1.71040000 GHz Temp 2 [T1 OSW] 1.72904000 GHz Center 1.72 GHz 4 MHz/ Span 40 MHz Date: 29.JUN.2023 22:53:56</p>
Middle	<p>Ref 30 dBm *Att 25 dB *RBW 300 kHz Delta 1 [T1] 0.23 dB *VSW 1 MHz *SWT 2.5 ms OSW 19.28000000 MHz Marker 1 [T1] -11.68 dBm D1 15.73 dBm D2 -11.68 dBm Temp 1 [T1 OSW] 1.72290000 GHz Temp 2 [T1 OSW] 1.74146000 GHz Center 1.7329 GHz 4 MHz/ Span 40 MHz Date: 29.JUN.2023 22:54:21</p>	<p>Ref 30 dBm *Att 25 dB *RBW 300 kHz Delta 1 [T1] 1.06 dB *VSW 1 MHz *SWT 2.5 ms OSW 19.20000000 MHz Marker 1 [T1] -11.28 dBm D1 15.09 dBm D2 -11.28 dBm Temp 1 [T1 OSW] 1.72290000 GHz Temp 2 [T1 OSW] 1.74154000 GHz Center 1.7329 GHz 4 MHz/ Span 40 MHz Date: 29.JUN.2023 22:54:44</p>
Highest	<p>Ref 30 dBm *Att 25 dB *RBW 300 kHz Delta 1 [T1] -0.22 dB *VSW 1 MHz *SWT 2.5 ms OSW 19.12000000 MHz Marker 1 [T1] -11.71 dBm D1 17.08 dBm D2 -11.71 dBm Temp 1 [T1 OSW] 1.73604000 GHz Temp 2 [T1 OSW] 1.75404000 GHz Center 1.745 GHz 4 MHz/ Span 40 MHz Date: 29.JUN.2023 22:55:05</p>	<p>Ref 30 dBm *Att 25 dB *RBW 300 kHz Delta 1 [T1] 0.67 dB *VSW 1 MHz *SWT 2.5 ms OSW 19.44000000 MHz Marker 1 [T1] -11.52 dBm D1 15.24 dBm D2 -11.52 dBm Temp 1 [T1 OSW] 1.73604000 GHz Temp 2 [T1 OSW] 1.75396000 GHz Center 1.745 GHz 4 MHz/ Span 40 MHz Date: 29.JUN.2023 22:55:25</p>

Spurious Emissions at Antenna Terminal

Channel

1.4MHz Bandwidth QPSK

Lowest

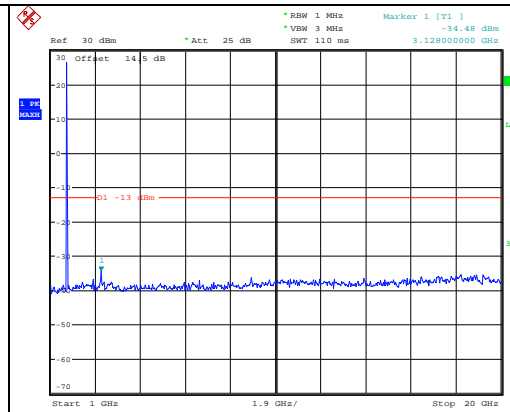
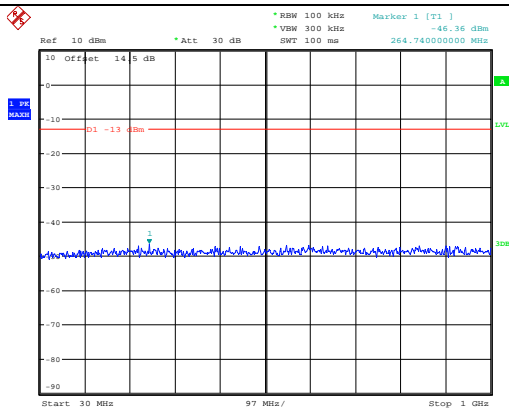

Middle

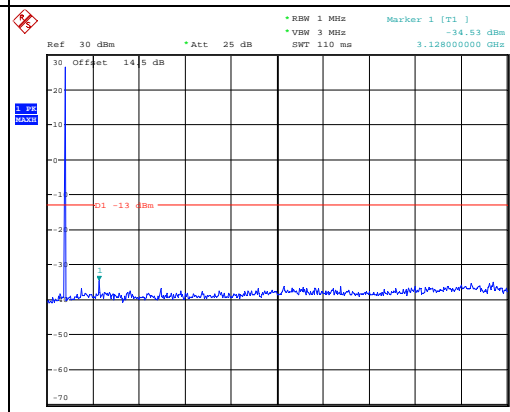
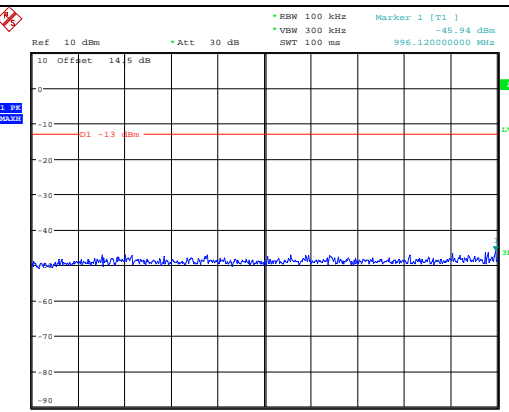

Highest

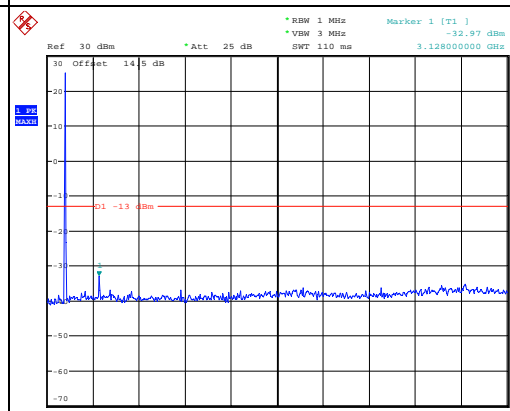
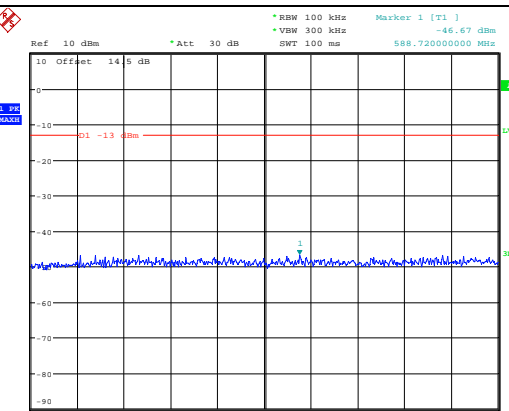

Spurious Emissions at Antenna Terminal

Channel	3MHz Bandwidth QPSK	
Lowest	<p>Date: 30.JUN.2023 13:01:26</p>	<p>Date: 30.JUN.2023 13:01:39</p>
Middle	<p>Date: 30.JUN.2023 13:01:57</p>	<p>Date: 30.JUN.2023 13:02:10</p>
Highest	<p>Date: 30.JUN.2023 13:02:25</p>	<p>Date: 30.JUN.2023 13:02:37</p>

Spurious Emissions at Antenna Terminal

Channel	5MHz Bandwidth QPSK	
Lowest	<p>Date: 30.JUN.2023 13:10:17</p>	<p>Date: 30.JUN.2023 13:10:30</p>
Middle	<p>Date: 30.JUN.2023 13:10:45</p>	<p>Date: 30.JUN.2023 13:10:58</p>
Highest	<p>Date: 30.JUN.2023 13:11:17</p>	<p>Date: 30.JUN.2023 13:11:30</p>

Spurious Emissions at Antenna Terminal

Channel	10MHz Bandwidth QPSK	
Lowest	<p>Ref 10 dBm Att 30 dB RBW 100 kHz VSW 300 kHz SWT 100 ms Marker 1 [T1] -46.24 dBm 837.048000000 MHz</p> <p>Start 30 MHz 97 MHz/ Stop 1 GHz</p> <p>Date: 30.JUN.2023 13:12:28</p>	<p>Ref 30 dBm Att 25 dB RBW 1 MHz VSW 3 MHz SWT 110 ms Marker 1 [T1] -34.61 dBm 18.024000000 GHz</p> <p>Start 1 GHz 1.9 GHz/ Stop 20 GHz</p> <p>Date: 30.JUN.2023 13:12:41</p>
Middle	<p>Ref 10 dBm Att 30 dB RBW 100 kHz VSW 300 kHz SWT 100 ms Marker 1 [T1] -46.30 dBm 978.660000000 MHz</p> <p>Start 30 MHz 97 MHz/ Stop 1 GHz</p> <p>Date: 30.JUN.2023 13:12:57</p>	<p>Ref 30 dBm Att 25 dB RBW 1 MHz VSW 3 MHz SWT 110 ms Marker 1 [T1] -34.13 dBm 3.128000000 GHz</p> <p>Start 1 GHz 1.9 GHz/ Stop 20 GHz</p> <p>Date: 30.JUN.2023 13:13:10</p>
Highest	<p>Ref 10 dBm Att 30 dB RBW 100 kHz VSW 300 kHz SWT 100 ms Marker 1 [T1] -46.08 dBm 262.800000000 MHz</p> <p>Start 30 MHz 97 MHz/ Stop 1 GHz</p> <p>Date: 30.JUN.2023 13:13:29</p>	<p>Ref 30 dBm Att 25 dB RBW 1 MHz VSW 3 MHz SWT 110 ms Marker 1 [T1] -34.96 dBm 3.128000000 GHz</p> <p>Start 1 GHz 1.9 GHz/ Stop 20 GHz</p> <p>Date: 30.JUN.2023 13:13:42</p>

Spurious Emissions at Antenna Terminal

Channel

15MHz Bandwidth QPSK

Lowest

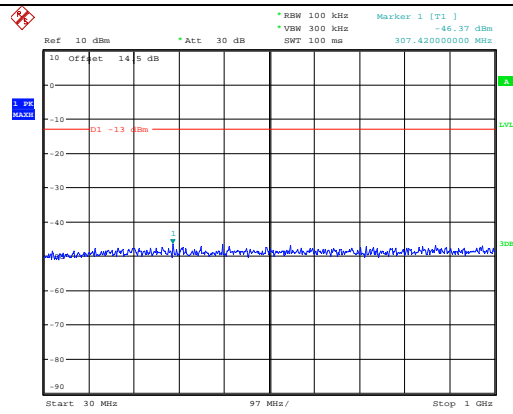

Date: 30.JUN.2023 13:14:23

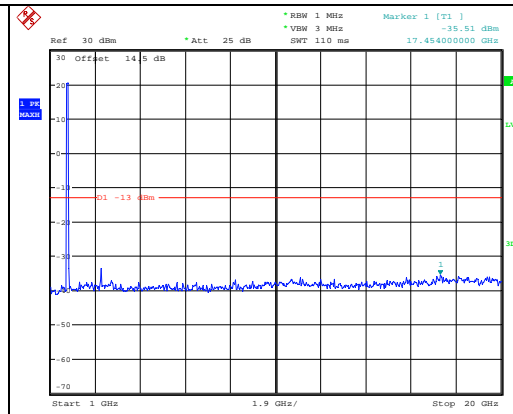

Date: 30.JUN.2023 13:14:33

Middle

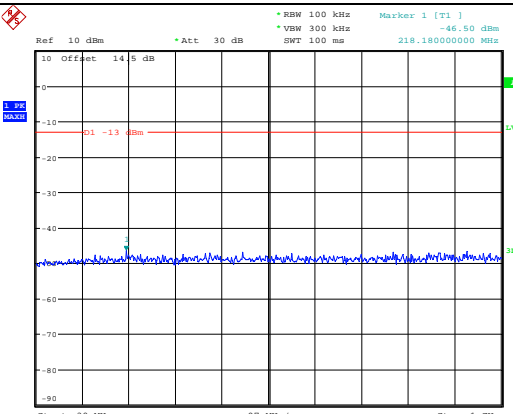

Date: 30.JUN.2023 13:14:50

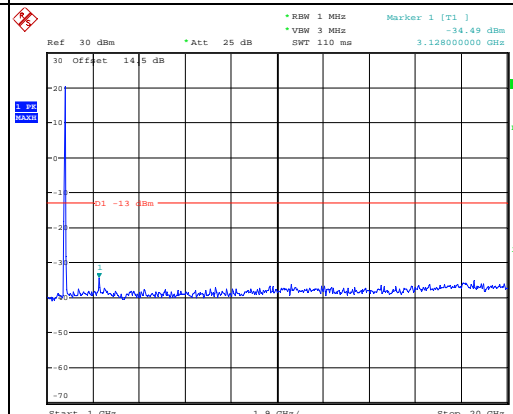

Date: 30.JUN.2023 13:15:03

Highest

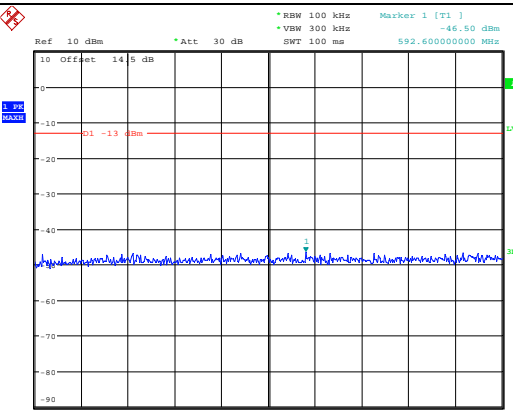

Date: 30.JUN.2023 13:15:24

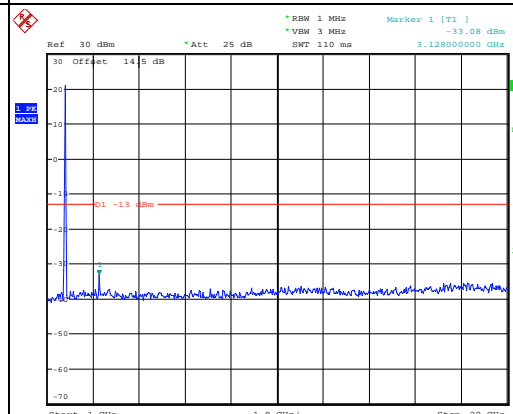

Date: 30.JUN.2023 13:15:37

Spurious Emissions at Antenna Terminal

Channel	20MHz Bandwidth QPSK	
Lowest	<p>Ref 10 dBm Att 30 dB RBW 100 kHz Marker 1 [T1] -46.87 dBm VSW 300 kHz SWT 100 ms 914.64000000 MHz</p> <p>Date: 30.JUN.2023 13:16:18</p>	<p>Ref 30 dBm Att 25 dB RBW 1 MHz Marker 1 [T1] -34.31 dBm VSW 3 MHz SWT 110 ms 3.128000000 GHz</p> <p>Date: 30.JUN.2023 13:16:32</p>
Middle	<p>Ref 10 dBm Att 30 dB RBW 100 kHz Marker 1 [T1] -46.18 dBm VSW 300 kHz SWT 100 ms 998.060000000 MHz</p> <p>Date: 30.JUN.2023 13:16:52</p>	<p>Ref 30 dBm Att 25 dB RBW 1 MHz Marker 1 [T1] -33.67 dBm VSW 3 MHz SWT 110 ms 3.128000000 GHz</p> <p>Date: 30.JUN.2023 13:17:05</p>
Highest	<p>Ref 10 dBm Att 30 dB RBW 100 kHz Marker 1 [T1] -45.86 dBm VSW 300 kHz SWT 100 ms 749.740000000 MHz</p> <p>Date: 30.JUN.2023 13:17:25</p>	<p>Ref 30 dBm Att 25 dB RBW 1 MHz Marker 1 [T1] -34.19 dBm VSW 3 MHz SWT 110 ms 18.290000000 GHz</p> <p>Date: 30.JUN.2023 13:17:38</p>

Out of band emission, Band Edge

Mode	Lowest	Highest
QPSK 1.4MHz	<p>Date: 30.JUN.2023 09:42:32</p>	<p>Date: 30.JUN.2023 09:42:49</p>
QPSK 3MHz	<p>Date: 30.JUN.2023 09:43:31</p>	<p>Date: 30.JUN.2023 09:43:48</p>
QPSK 5MHz	<p>Date: 30.JUN.2023 09:44:38</p>	<p>Date: 30.JUN.2023 09:44:56</p>

Out of band emission, Band Edge

Mode	Lowest	Highest
QPSK 10MHz	<p>Ref 30 dBm Att 25 dB RBW 100 kHz Marker 1 [T1] -24.98 dBm VSW 1 MHz SWT 35 ms 1.710000000 GHz</p> <p>30 Offset 14.5 dB -20 -10 0 -10 -20 -30 -40 -50 -60 -70</p> <p>D1 -13 dBm</p> <p>SWP 50 OF 50</p> <p>Center 1.71 GHz 2 MHz/ Span 20 MHz</p> <p>Date: 30.JUN.2023 09:46:02</p>	<p>Ref 30 dBm Att 25 dB RBW 100 kHz Marker 1 [T1] -29.15 dBm VSW 1 MHz SWT 35 ms 1.755000000 GHz</p> <p>30 Offset 14.5 dB -20 -10 0 -10 -20 -30 -40 -50 -60 -70</p> <p>D1 -13 dBm</p> <p>SWP 50 OF 50</p> <p>Center 1.755 GHz 2 MHz/ Span 20 MHz</p> <p>Date: 30.JUN.2023 09:46:22</p>
QPSK 15MHz	<p>Ref 30 dBm Att 25 dB RBW 300 kHz Marker 1 [T1] -23.98 dBm VSW 1 MHz SWT 35 ms 1.710000000 GHz</p> <p>30 Offset 14.5 dB -20 -10 0 -10 -20 -30 -40 -50 -60 -70</p> <p>D1 -13 dBm</p> <p>SWP 50 OF 50</p> <p>Center 1.71 GHz 3 MHz/ Span 30 MHz</p> <p>Date: 30.JUN.2023 09:47:05</p>	<p>Ref 30 dBm Att 25 dB RBW 300 kHz Marker 1 [T1] -24.44 dBm VSW 1 MHz SWT 35 ms 1.755000000 GHz</p> <p>30 Offset 14.5 dB -20 -10 0 -10 -20 -30 -40 -50 -60 -70</p> <p>D1 -13 dBm</p> <p>SWP 50 OF 50</p> <p>Center 1.755 GHz 3 MHz/ Span 30 MHz</p> <p>Date: 30.JUN.2023 09:47:24</p>
QPSK 20MHz	<p>Ref 30 dBm Att 25 dB RBW 300 kHz Marker 1 [T1] -23.99 dBm VSW 1 MHz SWT 35 ms 1.710000000 GHz</p> <p>30 Offset 14.5 dB -20 -10 0 -10 -20 -30 -40 -50 -60 -70</p> <p>D1 -13 dBm</p> <p>SWP 50 OF 50</p> <p>Center 1.71 GHz 4 MHz/ Span 40 MHz</p> <p>Date: 30.JUN.2023 09:56:52</p>	<p>Ref 30 dBm Att 25 dB RBW 300 kHz Marker 1 [T1] -29.12 dBm VSW 1 MHz SWT 35 ms 1.755000000 GHz</p> <p>30 Offset 14.5 dB -20 -10 0 -10 -20 -30 -40 -50 -60 -70</p> <p>D1 -13 dBm</p> <p>SWP 50 OF 50</p> <p>Center 1.755 GHz 4 MHz/ Span 40 MHz</p> <p>Date: 30.JUN.2023 09:57:11</p>

Out of band emission, Band Edge

Mode	Lowest	Highest
16QAM 1.4MHz	<p>Date: 30.JUN.2023 09:42:41</p>	<p>Date: 30.JUN.2023 09:42:56</p>
16QAM 3MHz	<p>Date: 30.JUN.2023 09:43:40</p>	<p>Date: 30.JUN.2023 09:43:56</p>
16QAM 5MHz	<p>Date: 30.JUN.2023 09:44:46</p>	<p>Date: 30.JUN.2023 09:45:04</p>

Out of band emission, Band Edge

Mode	Lowest	Highest
16QAM 10MHz	<p>Date: 30.JUN.2023 09:46:12</p>	<p>Date: 30.JUN.2023 09:46:31</p>
16QAM 15MHz	<p>Date: 30.JUN.2023 09:47:14</p>	<p>Date: 30.JUN.2023 09:47:33</p>
16QAM 20MHz	<p>Date: 30.JUN.2023 09:57:01</p>	<p>Date: 30.JUN.2023 09:57:21</p>

4.8 Antenna Port Test Data and Results for LTE Band 5

Serial Number:	27A0-1	Test Date:	2023/6/27-2023/7/3
Test Site:	RF	Test Mode:	Transmitting
Tester:	Claire Liu	Test Result:	Pass

Environmental Conditions:

Temperature: (°C)	24.5-26.3	Relative Humidity: (%)	41-59	ATM Pressure: (kPa)	99.8-100.7
----------------------	-----------	---------------------------	-------	------------------------	------------

Test Equipment List and Details:

Manufacturer	Description	Model	Serial Number	Calibration Date	Calibration Due Date
R&S	Spectrum Analyzer	FSU26	200256	2023/3/31	2024/3/30
zhuoxiang	Coaxial Cable	SMA-178	211001	Each time	N/A
YINSAIGE	Coaxial Cable	SS402	SJ0100001	Each time	N/A
Mini-Circuits	DC Block	BLK-18-S+	1554403	Each time	N/A
Weinschel	Power Splitter	1515	RA914	Each time	N/A
R&S	Wideband Radio Communication Tester	CMW500	149218	2023/3/31	2024/3/30
BACL	TEMP&HUMI Test Chamber	BTH-150-40	30174	2022/9/29	2023/9/28
UNI-T	Multimeter	UT39A+	C210582554	2022/9/29	2023/9/28
ZHAOXIN	DC Power Supply	RXN-6010D	21R6010D0912386	2022/7/15	2023/7/14

* Statement of Traceability: China Certification ICT Co., Ltd (Dongguan) attests that all calibrations have been performed, traceable to National Primary Standards and International System of Units (SI).

Test Frequency for Each Mode:

Operation Bandwidth	Lowest Frequency (MHz)	Middle Frequency (MHz)	Highest Frequency (MHz)
1.4MHz	824.7	836.5	848.3
3MHz	825.5	836.5	847.5
5MHz	826.5	836.5	846.5
10MHz	829	836.5	844

Test Data:

FCC§2.1046;§ 22.913 (a)						
RF Output Power:						
Test Bandwidth & Modulation	Resource Block & RB offset	Conducted Average Output Power(dBm)			Maximum ERP (dBm)	ERP Limit (dBm)
		Lowest Channel	Middle Channel	Highest Channel		
1.4MHz QPSK	RB1#0	24.96	24.72	24.59	22.47	38.45
	RB1#3	25.09	24.8	24.61		
	RB1#5	24.91	24.71	24.41		
	RB3#0	25.07	24.68	24.47		
	RB3#3	25.03	24.75	24.55		
	RB6#0	23.98	23.47	23.48		
1.4MHz 16QAM	RB1#0	23.97	23.61	23.41	21.62	38.45
	RB1#3	24.18	23.58	23.66		
	RB1#5	23.91	23.56	23.42		
	RB3#0	24.24	23.3	23.56		
	RB3#3	24.22	23.74	23.55		
	RB6#0	23.05	22.66	22.5		
3MHz QPSK	RB1#0	25.07	24.29	24.43	22.45	38.45
	RB1#8	24.97	24.17	24.45		
	RB1#14	24.92	24.21	24.42		
	RB6#0	23.52	23.18	23.46		
	RB6#9	23.48	23.13	23.35		
	RB15#0	23.52	23.24	23.55		
3MHz 16QAM	RB1#0	23.57	23.88	23.55	21.26	38.45
	RB1#8	23.55	23.79	23.56		
	RB1#14	23.42	23.84	23.55		
	RB6#0	22.41	22.27	22.54		
	RB6#9	22.38	22.26	22.41		
	RB15#0	22.7	22.36	22.45		
5MHz QPSK	RB1#0	24.86	24.22	24.33	22.34	38.45
	RB1#13	24.96	24.25	24.44		
	RB1#24	24.74	24.15	24.32		
	RB15#0	23.91	23.39	23.57		
	RB15#10	23.92	23.16	23.17		
	RB25#0	23.71	23.28	23.31		
5MHz 16QAM	RB1#0	23.33	23.51	23.43	20.92	38.45
	RB1#13	23.36	23.54	23.53		
	RB1#24	23.2	23.49	23.38		
	RB15#0	22.52	22.38	22.61		
	RB15#10	22.6	22.18	22.22		
	RB25#0	22.53	22.34	22.36		
10MHz QPSK	RB1#0	24.99	24.72	24.23	22.37	38.45
	RB1#25	24.93	24.83	24.37		
	RB1#49	24.79	24.82	24.36		

	RB25#0	23.8	23.98	23.11		
	RB25#25	23.91	23.71	23.07		
	RB50#0	23.91	23.91	23.08		
10MHz 16QAM	RB1#0	24.01	24.29	23.39	21.8	38.45
	RB1#25	24.07	24.42	23.6		
	RB1#49	23.77	23.91	23.5		
	RB25#0	23.02	22.6	22.2		
	RB25#25	23.07	22.46	22.07		
	RB50#0	22.95	22.48	22.11		

Note:

ERP= Conducted Power(dBm) - Lc(dB) + Gr(dBd)

Gr(dBd)=Gr(dBi)-2.15

Result:**Pass****Peak-to-average Ratio(PAR)**

Test Bandwidth & Modulation	Resource Block & RB offset	Peak-to-average Ratio(dB)			Limit(dB)
		Lowest Channel	Middle Channel	Highest Channel	
10MHz QPSK	RB1#0	5.71	5.99	5.83	13
	RB50#0	5.58	5.96	5.45	13
10MHz 16QAM	RB1#0	6.19	6.99	6.96	13
	RB50#0	6.51	6.7	6.54	13

Result:**Pass****FCC §2.1049, §22.905:Occupied Bandwidth**

Operation Mode	99% Occupied Bandwidth (MHz)			26 dB Occupied Bandwidth (MHz)		
	Low Channel	Middle channel	High Channel	Low Channel	Middle Channel	High Channel
1.4MHz QPSK	1.104	1.104	1.098	1.320	1.290	1.296
1.4MHz 16QAM	1.092	1.098	1.104	1.290	1.296	1.302
3MHz QPSK	2.676	2.687	2.687	2.856	2.892	2.892
3MHz 16QAM	2.676	2.676	2.687	2.904	2.868	2.880
5MHz QPSK	4.52	4.52	4.48	4.94	4.92	4.90
5MHz 16QAM	4.5	4.52	4.48	4.9	4.94	4.90
10MHz QPSK	8.96	9	8.96	9.56	10	9.44
10MHz 16QAM	8.92	9	8.92	9.48	10	9.44

Note: The test plots please refer to the Plots of Occupied Bandwidth

FCC §2.1051, §22.917(a):Spurious Emissions at Antenna Terminal**Result:****Pass, Please refer to the test plots of Spurious Emissions at Antenna Terminal.**

FCC §2.1051, §22.917(a):Out of band emission, Band Edge	
Result:	Pass, Please refer to the test plots of Out of band emission, Band Edge.

FCC §2.1055, §22.355: Frequency Stability					
Test Modulation:	10 MHz QPSK		Test Channel:	836.5	MHz
Test Item	Temperature (°C)	Voltage (V _{DC})	Frequency Error		Limit
			(Hz)	(ppm)	(ppm)
Frequency Stability vs. Temperature	-30	3.85	-4.9	-0.006	2.5
	-20	3.85	10.69	0.013	2.5
	-10	3.85	-3.39	-0.004	2.5
	0	3.85	-4.64	-0.006	2.5
	10	3.85	-2.95	-0.004	2.5
	20	3.85	10.29	0.012	2.5
	30	3.85	-5.63	-0.007	2.5
	40	3.85	10.29	0.012	2.5
Frequency Stability vs. Voltage	20	3.6	7.88	0.009	2.5
	20	4.35	-4.32	-0.005	2.5
				Result:	Pass

Test Modulation:	10 MHz 16QAM		Test Channel:	836.5	MHz
Test Item	Temperature(°C)	Voltage(V _{DC})	Frequency Error		Limit
			(Hz)	(ppm)	(ppm)
Frequency Stability vs. Temperature	-30	3.85	-2	-0.002	2.5
	-20	3.85	9	0.011	2.5
	-10	3.85	-4.19	-0.005	2.5
	0	3.85	8.5	0.010	2.5
	10	3.85	-6.43	-0.008	2.5
	20	3.85	10.32	0.012	2.5
	30	3.85	-5.34	-0.006	2.5
	40	3.85	11.91	0.014	2.5
Frequency Stability vs. Voltage	20	3.6	-4.15	-0.005	2.5
	20	4.35	12.59	0.015	2.5
				Result:	Pass

Test Plots(Note: The 14.5 dB is the Insertion loss of the RF cable and Power Splitter, which was offset into the Spectrum Analyzer):

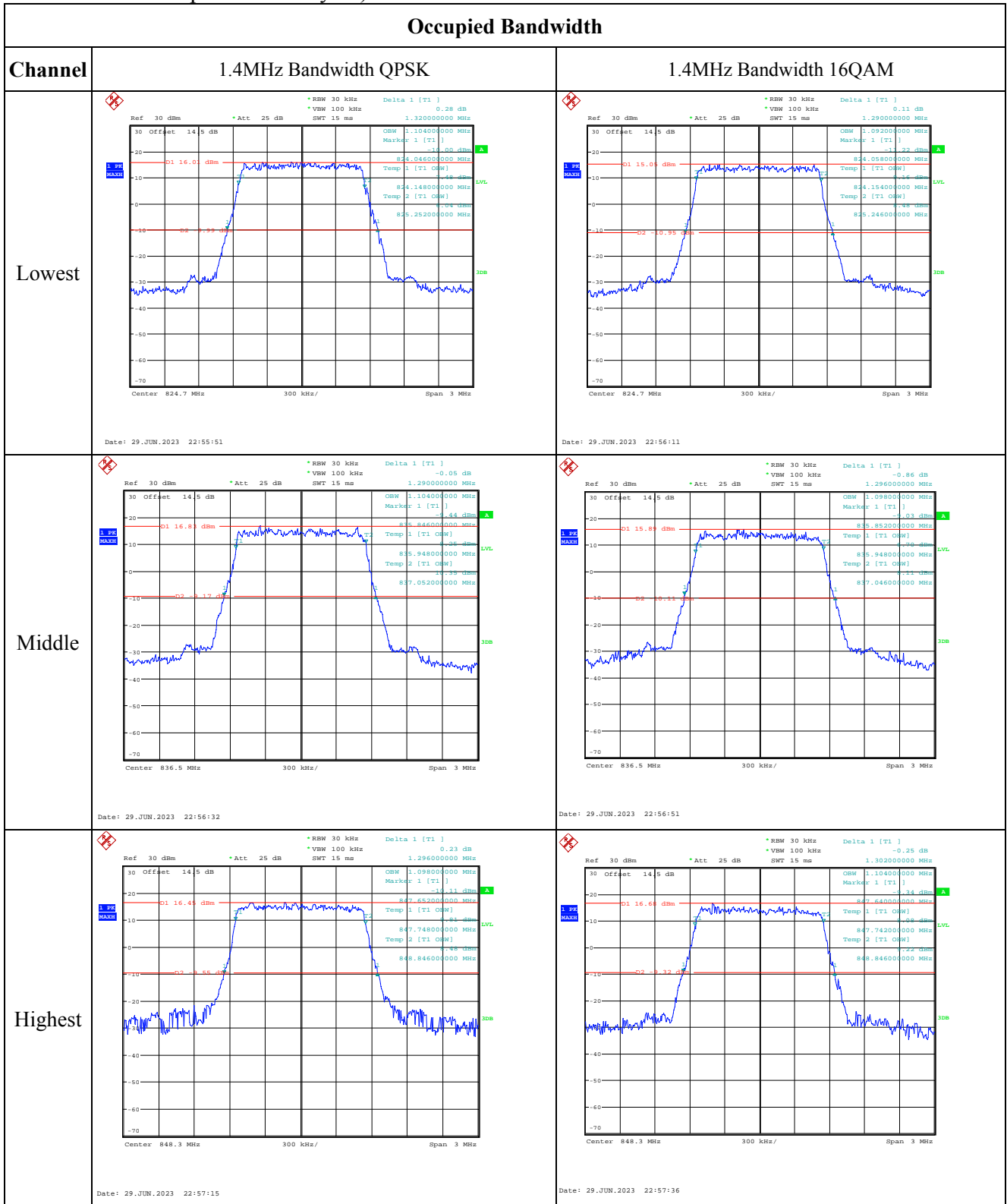

Occupied Bandwidth

Channel	3MHz Bandwidth QPSK	3MHz Bandwidth 16QAM
Lowest	<p>Ref 30 dBm *Att 25 dB *RBW 30 kHz Delta 1 [T1] 0.79 dB *VBW 100 kHz *SWT 30 ms 2.856000000 MHz OSW 2.876000000 MHz Marker 1 [T1] -11.66 dBm 824.072000000 MHz Temp 1 [T1 OSW] 824.168000000 MHz Temp 2 [T1 OSW] 826.844000000 MHz</p> <p>Center 825.5 MHz 600 kHz/ Span 6 MHz Date: 29.JUN.2023 22:58:51</p>	<p>Ref 30 dBm *Att 25 dB *RBW 30 kHz Delta 1 [T1] 0.86 dB *VBW 100 kHz *SWT 30 ms 2.804000000 MHz OSW 2.876000000 MHz Marker 1 [T1] -11.76 dBm 824.060000000 MHz Temp 1 [T1 OSW] 824.168000000 MHz Temp 2 [T1 OSW] 826.844000000 MHz</p> <p>Center 825.5 MHz 600 kHz/ Span 6 MHz Date: 29.JUN.2023 22:59:11</p>
Middle	<p>Ref 30 dBm *Att 25 dB *RBW 30 kHz Delta 1 [T1] 1.13 dB *VBW 100 kHz *SWT 30 ms 2.892000000 MHz OSW 2.898000000 MHz Marker 1 [T1] -11.45 dBm 835.048000000 MHz Temp 1 [T1 OSW] 836.156000000 MHz Temp 2 [T1 OSW] 837.844000000 MHz</p> <p>Center 836.5 MHz 600 kHz/ Span 6 MHz Date: 29.JUN.2023 22:59:29</p>	<p>Ref 30 dBm *Att 25 dB *RBW 30 kHz Delta 1 [T1] 2.93 dB *VBW 100 kHz *SWT 30 ms 2.868000000 MHz OSW 2.876000000 MHz Marker 1 [T1] -11.38 dBm 835.060000000 MHz Temp 1 [T1 OSW] 836.156000000 MHz Temp 2 [T1 OSW] 837.832000000 MHz</p> <p>Center 836.5 MHz 600 kHz/ Span 6 MHz Date: 29.JUN.2023 22:59:49</p>
Highest	<p>Ref 30 dBm *Att 25 dB *RBW 30 kHz Delta 1 [T1] 0.38 dB *VBW 100 kHz *SWT 30 ms 2.892000000 MHz OSW 2.898000000 MHz Marker 1 [T1] -11.80 dBm 846.036000000 MHz Temp 1 [T1 OSW] 846.156000000 MHz Temp 2 [T1 OSW] 848.844000000 MHz</p> <p>Center 847.5 MHz 600 kHz/ Span 6 MHz Date: 29.JUN.2023 23:00:10</p>	<p>Ref 30 dBm *Att 25 dB *RBW 30 kHz Delta 1 [T1] 1.11 dB *VBW 100 kHz *SWT 30 ms 2.880000000 MHz OSW 2.876000000 MHz Marker 1 [T1] -11.52 dBm 846.048000000 MHz Temp 1 [T1 OSW] 846.156000000 MHz Temp 2 [T1 OSW] 848.832000000 MHz</p> <p>Center 847.5 MHz 600 kHz/ Span 6 MHz Date: 29.JUN.2023 23:00:30</p>

Occupied Bandwidth

Channel	5MHz Bandwidth QPSK	5MHz Bandwidth 16QAM
Lowest	<p>Ref 30 dBm *Att 25 dB *RBW 100 kHz Delta 1 [T1] 0.40 dB *VSW 300 kHz *SWT 5 ms 4.940000000 MHz OBSW 4.520000000 MHz Marker 1 [T1] -16.74 dBm Temp 1 [T1 OSW] -10.21 dBm 824.240000000 MHz Temp 2 [T1 OSW] -10.21 dBm 828.760000000 MHz Center 826.5 MHz 1 MHz/ Span 10 MHz Date: 29.JUN.2023 23:01:40</p>	<p>Ref 30 dBm *Att 25 dB *RBW 100 kHz Delta 1 [T1] 0.78 dB *VSW 300 kHz *SWT 5 ms 4.900000000 MHz OBSW 4.500000000 MHz Marker 1 [T1] -15.24 dBm Temp 1 [T1 OSW] -10.77 dBm 824.060000000 MHz Temp 2 [T1 OSW] -10.77 dBm 828.760000000 MHz Center 826.5 MHz 1 MHz/ Span 10 MHz Date: 29.JUN.2023 23:02:00</p>
Middle	<p>Ref 30 dBm *Att 25 dB *RBW 100 kHz Delta 1 [T1] 1.32 dB *VSW 300 kHz *SWT 5 ms 4.920000000 MHz OBSW 4.500000000 MHz Marker 1 [T1] -15.63 dBm Temp 1 [T1 OSW] -10.14 dBm 824.240000000 MHz Temp 2 [T1 OSW] -10.14 dBm 828.760000000 MHz Center 826.5 MHz 1 MHz/ Span 10 MHz Date: 29.JUN.2023 23:02:24</p>	<p>Ref 30 dBm *Att 25 dB *RBW 100 kHz Delta 1 [T1] 1.15 dB *VSW 300 kHz *SWT 5 ms 4.940000000 MHz OBSW 4.520000000 MHz Marker 1 [T1] -15.27 dBm Temp 1 [T1 OSW] -10.77 dBm 824.060000000 MHz Temp 2 [T1 OSW] -10.77 dBm 828.760000000 MHz Center 826.5 MHz 1 MHz/ Span 10 MHz Date: 29.JUN.2023 23:02:50</p>
Highest	<p>Ref 30 dBm *Att 25 dB *RBW 100 kHz Delta 1 [T1] 0.32 dB *VSW 300 kHz *SWT 5 ms 4.900000000 MHz OBSW 4.480000000 MHz Marker 1 [T1] -16.63 dBm Temp 1 [T1 OSW] -10.37 dBm 824.240000000 MHz Temp 2 [T1 OSW] -10.37 dBm 828.720000000 MHz Center 826.5 MHz 1 MHz/ Span 10 MHz Date: 29.JUN.2023 23:03:11</p>	<p>Ref 30 dBm *Att 25 dB *RBW 100 kHz Delta 1 [T1] 2.74 dB *VSW 300 kHz *SWT 5 ms 4.900000000 MHz OBSW 4.500000000 MHz Marker 1 [T1] -15.01 dBm Temp 1 [T1 OSW] -10.97 dBm 824.040000000 MHz Temp 2 [T1 OSW] -10.97 dBm 828.740000000 MHz Center 826.5 MHz 1 MHz/ Span 10 MHz Date: 29.JUN.2023 23:03:27</p>

Occupied Bandwidth

Channel	10MHz Bandwidth QPSK	10MHz Bandwidth 16QAM
Lowest	<p>Ref 30 dBm *Att 25 dB *RBW 100 kHz Delta 1 [T1] 0.63 dB *VMW 300 kHz *SWT 10 ms 9.560000000 MHz OSW 9.560000000 MHz Marker 1 [T1] -11.68 dBm 824.200000000 MHz 824.520000000 MHz Temp 1 [T1 OSW] 1.77 dBm Temp 2 [T1 OSW] 1.78 dBm 823.480000000 MHz Center 829 MHz 2 MHz/ Span 20 MHz Date: 29.JUN.2023 23:04:45</p>	<p>Ref 30 dBm *Att 25 dB *RBW 100 kHz Delta 1 [T1] 0.85 dB *VMW 300 kHz *SWT 10 ms 9.480000000 MHz OSW 9.480000000 MHz Marker 1 [T1] -11.33 dBm 824.240000000 MHz Temp 1 [T1 OSW] 1.77 dBm Temp 2 [T1 OSW] 1.78 dBm 823.480000000 MHz Center 829 MHz 2 MHz/ Span 20 MHz Date: 29.JUN.2023 23:05:05</p>
Middle	<p>Ref 30 dBm *Att 25 dB *RBW 100 kHz Delta 1 [T1] -2.60 dB *VMW 300 kHz *SWT 10 ms 9.600000000 MHz OSW 9.600000000 MHz Marker 1 [T1] -11.78 dBm 831.660000000 MHz Temp 1 [T1 OSW] 1.77 dBm Temp 2 [T1 OSW] 1.78 dBm 830.980000000 MHz Center 836.5 MHz 2 MHz/ Span 20 MHz Date: 29.JUN.2023 23:05:29</p>	<p>Ref 30 dBm *Att 25 dB *RBW 100 kHz Delta 1 [T1] -1.35 dB *VMW 300 kHz *SWT 10 ms 9.640000000 MHz OSW 9.640000000 MHz Marker 1 [T1] -11.96 dBm 831.660000000 MHz Temp 1 [T1 OSW] 1.77 dBm Temp 2 [T1 OSW] 1.78 dBm 830.980000000 MHz Center 836.5 MHz 2 MHz/ Span 20 MHz Date: 29.JUN.2023 23:05:49</p>
Highest	<p>Ref 30 dBm *Att 25 dB *RBW 100 kHz Delta 1 [T1] -0.18 dB *VMW 300 kHz *SWT 10 ms 9.440000000 MHz OSW 9.440000000 MHz Marker 1 [T1] -11.81 dBm 839.240000000 MHz Temp 1 [T1 OSW] 1.77 dBm Temp 2 [T1 OSW] 1.78 dBm 838.480000000 MHz Center 844 MHz 2 MHz/ Span 20 MHz Date: 29.JUN.2023 23:06:09</p>	<p>Ref 30 dBm *Att 25 dB *RBW 100 kHz Delta 1 [T1] 0.58 dB *VMW 300 kHz *SWT 10 ms 9.440000000 MHz OSW 9.440000000 MHz Marker 1 [T1] -11.78 dBm 839.280000000 MHz Temp 1 [T1 OSW] 1.77 dBm Temp 2 [T1 OSW] 1.78 dBm 838.440000000 MHz Center 844 MHz 2 MHz/ Span 20 MHz Date: 29.JUN.2023 23:06:32</p>

Spurious Emissions at Antenna Terminal

Channel	1.4MHz Bandwidth QPSK	
Lowest	<p>Ref 30 dBm Att 25 dB *RBW 100 kHz Marker 1 [T1] -44.66 dBm *VBW 300 kHz *SWT 100 ms 943.740000000 MHz</p> <p>Date: 30.JUN.2023 13:17:56</p>	<p>Ref 10 dBm Att 30 dB *RBW 1 MHz Marker 1 [T1] -28.77 dBm *VBW 3 MHz *SWT 55 ms 3.142000000 GHz</p> <p>Date: 30.JUN.2023 13:18:07</p>
Middle	<p>Ref 30 dBm Att 25 dB *RBW 100 kHz Marker 1 [T1] -28.35 dBm *VBW 300 kHz *SWT 100 ms 844.800000000 MHz</p> <p>Date: 30.JUN.2023 13:18:23</p>	<p>Ref 10 dBm Att 30 dB *RBW 1 MHz Marker 1 [T1] -28.15 dBm *VBW 3 MHz *SWT 55 ms 3.142000000 GHz</p> <p>Date: 30.JUN.2023 13:18:33</p>
Highest	<p>Ref 30 dBm Att 25 dB *RBW 100 kHz Marker 1 [T1] -44.43 dBm *VBW 300 kHz *SWT 100 ms 932.100000000 MHz</p> <p>Date: 30.JUN.2023 13:18:47</p>	<p>Ref 10 dBm Att 30 dB *RBW 1 MHz Marker 1 [T1] -28.88 dBm *VBW 3 MHz *SWT 55 ms 3.142000000 GHz</p> <p>Date: 30.JUN.2023 13:18:57</p>

Spurious Emissions at Antenna Terminal

Channel	3MHz Bandwidth QPSK	
Lowest	<p>Ref 30 dBm *Att 25 dB *RBW 100 kHz *VSW 300 kHz SWT 100 ms Marker 1 [T1] -44.44 dBm 272.50000000 MHz</p> <p>Start 30 MHz 97 MHz/ Stop 1 GHz</p> <p>Date: 30.JUN.2023 13:23:30</p>	<p>Ref 10 dBm *Att 30 dB *RBW 1 MHz *VSW 3 MHz SWT 55 ms Marker 1 [T1] -29.42 dBm 3.124000000 GHz</p> <p>Start 1 GHz 900 MHz/ Stop 10 GHz</p> <p>Date: 30.JUN.2023 13:23:46</p>
	<p>Ref 30 dBm *Att 25 dB *RBW 100 kHz *VSW 300 kHz SWT 100 ms Marker 1 [T1] -43.42 dBm 945.68000000 MHz</p> <p>Start 30 MHz 97 MHz/ Stop 1 GHz</p> <p>Date: 30.JUN.2023 13:24:02</p>	<p>Ref 10 dBm *Att 30 dB *RBW 1 MHz *VSW 3 MHz SWT 55 ms Marker 1 [T1] -28.94 dBm 3.142000000 GHz</p> <p>Start 1 GHz 900 MHz/ Stop 10 GHz</p> <p>Date: 30.JUN.2023 13:24:15</p>
Highest	<p>Ref 30 dBm *Att 25 dB *RBW 100 kHz *VSW 300 kHz SWT 100 ms Marker 1 [T1] -27.56 dBm 837.04000000 MHz</p> <p>Start 30 MHz 97 MHz/ Stop 1 GHz</p> <p>Date: 30.JUN.2023 13:24:33</p>	<p>Ref 10 dBm *Att 30 dB *RBW 1 MHz *VSW 3 MHz SWT 55 ms Marker 1 [T1] -27.52 dBm 3.142000000 GHz</p> <p>Start 1 GHz 900 MHz/ Stop 10 GHz</p> <p>Date: 30.JUN.2023 13:24:46</p>

Spurious Emissions at Antenna Terminal

Channel	5MHz Bandwidth QPSK	
Lowest	<p>Ref 30 dBm Att 25 dB *RBW 100 kHz Marker 1 [T1] -43.31 dBm *VSW 300 kHz -43.31 dBm *SWT 100 ms 241.46000000 MHz</p> <p>Start 30 MHz 97 MHz/ Stop 1 GHz</p> <p>Date: 30.JUN.2023 13:26:36</p>	<p>Ref 10 dBm Att 30 dB *RBW 1 MHz Marker 1 [T1] -28.14 dBm *VSW 3 MHz -28.14 dBm *SWT 55 ms 3.142000000 GHz</p> <p>Start 1 GHz 900 MHz/ Stop 10 GHz</p> <p>Date: 30.JUN.2023 13:26:46</p>
Middle	<p>Ref 30 dBm Att 25 dB *RBW 100 kHz Marker 1 [T1] -43.99 dBm *VSW 300 kHz -43.99 dBm *SWT 100 ms 800.18000000 MHz</p> <p>Start 30 MHz 97 MHz/ Stop 1 GHz</p> <p>Date: 30.JUN.2023 13:27:00</p>	<p>Ref 10 dBm Att 30 dB *RBW 1 MHz Marker 1 [T1] -29.12 dBm *VSW 3 MHz -29.12 dBm *SWT 55 ms 3.142000000 GHz</p> <p>Start 1 GHz 900 MHz/ Stop 10 GHz</p> <p>Date: 30.JUN.2023 13:27:10</p>
Highest	<p>Ref 30 dBm Att 25 dB *RBW 100 kHz Marker 1 [T1] -44.60 dBm *VSW 300 kHz -44.60 dBm *SWT 100 ms 410.24000000 MHz</p> <p>Start 30 MHz 97 MHz/ Stop 1 GHz</p> <p>Date: 30.JUN.2023 13:27:26</p>	<p>Ref 10 dBm Att 30 dB *RBW 1 MHz Marker 1 [T1] -29.12 dBm *VSW 3 MHz -29.12 dBm *SWT 55 ms 3.124000000 GHz</p> <p>Start 1 GHz 900 MHz/ Stop 10 GHz</p> <p>Date: 30.JUN.2023 13:27:37</p>

Spurious Emissions at Antenna Terminal

Channel	10MHz Bandwidth QPSK	
Lowest	<p>Ref 30 dBm *Att 25 dB *RBW 100 kHz *VSW 300 kHz *SWT 100 ms Marker 1 [T1] -44.11 dBm 289.02000000 MHz</p> <p>Start 30 MHz 97 MHz/ Stop 1 GHz</p> <p>Date: 30.JUN.2023 13:28:25</p>	<p>Ref 10 dBm *Att 30 dB *RBW 1 MHz *VSW 3 MHz *SWT 55 ms Marker 1 [T1] -27.86 dBm 3.142000000 GHz</p> <p>Start 1 GHz 900 MHz/ Stop 10 GHz</p> <p>Date: 30.JUN.2023 13:28:35</p>
Middle	<p>Ref 30 dBm *Att 25 dB *RBW 100 kHz *VSW 300 kHz *SWT 100 ms Marker 1 [T1] -31.67 dBm 317.64000000 MHz</p> <p>Start 30 MHz 97 MHz/ Stop 1 GHz</p> <p>Date: 30.JUN.2023 13:28:53</p>	<p>Ref 10 dBm *Att 30 dB *RBW 1 MHz *VSW 3 MHz *SWT 55 ms Marker 1 [T1] -29.19 dBm 3.142000000 GHz</p> <p>Start 1 GHz 900 MHz/ Stop 10 GHz</p> <p>Date: 30.JUN.2023 13:29:03</p>
Highest	<p>Ref 30 dBm *Att 25 dB *RBW 100 kHz *VSW 300 kHz *SWT 100 ms Marker 1 [T1] -41.48 dBm 237.58000000 MHz</p> <p>Start 30 MHz 97 MHz/ Stop 1 GHz</p> <p>Date: 30.JUN.2023 13:29:17</p>	<p>Ref 10 dBm *Att 30 dB *RBW 1 MHz *VSW 3 MHz *SWT 55 ms Marker 1 [T1] -28.77 dBm 3.142000000 GHz</p> <p>Start 1 GHz 900 MHz/ Stop 10 GHz</p> <p>Date: 30.JUN.2023 13:29:28</p>

Out of band emission, Band Edge

Mode	Lowest	Highest
QPSK 1.4MHz	<p>Ref 30 dBm Att 25 dB RBW 30 kHz Marker 1 [T1] -29.12 dBm VSM 100 kHz SWT 35 ms Center 824 MHz</p> <p>Date: 30.JUN.2023 09:57:35</p>	<p>Ref 30 dBm Att 25 dB RBW 30 kHz Marker 1 [T1] -30.50 dBm VSM 100 kHz SWT 35 ms Center 849 MHz</p> <p>Date: 30.JUN.2023 09:57:52</p>
QPSK 3MHz	<p>Ref 30 dBm Att 25 dB RBW 30 kHz Marker 1 [T1] -31.92 dBm VSM 100 kHz SWT 35 ms Center 824 MHz</p> <p>Date: 30.JUN.2023 09:59:08</p>	<p>Ref 30 dBm Att 25 dB RBW 30 kHz Marker 1 [T1] -36.22 dBm VSM 100 kHz SWT 35 ms Center 849 MHz</p> <p>Date: 30.JUN.2023 09:59:25</p>
QPSK 5MHz	<p>Ref 30 dBm Att 25 dB RBW 100 kHz Marker 1 [T1] -30.50 dBm VSM 500 kHz SWT 35 ms Center 824 MHz</p> <p>Date: 30.JUN.2023 10:00:43</p>	<p>Ref 30 dBm Att 25 dB RBW 100 kHz Marker 1 [T1] -31.86 dBm VSM 500 kHz SWT 35 ms Center 849 MHz</p> <p>Date: 30.JUN.2023 10:01:00</p>

Out of band emission, Band Edge

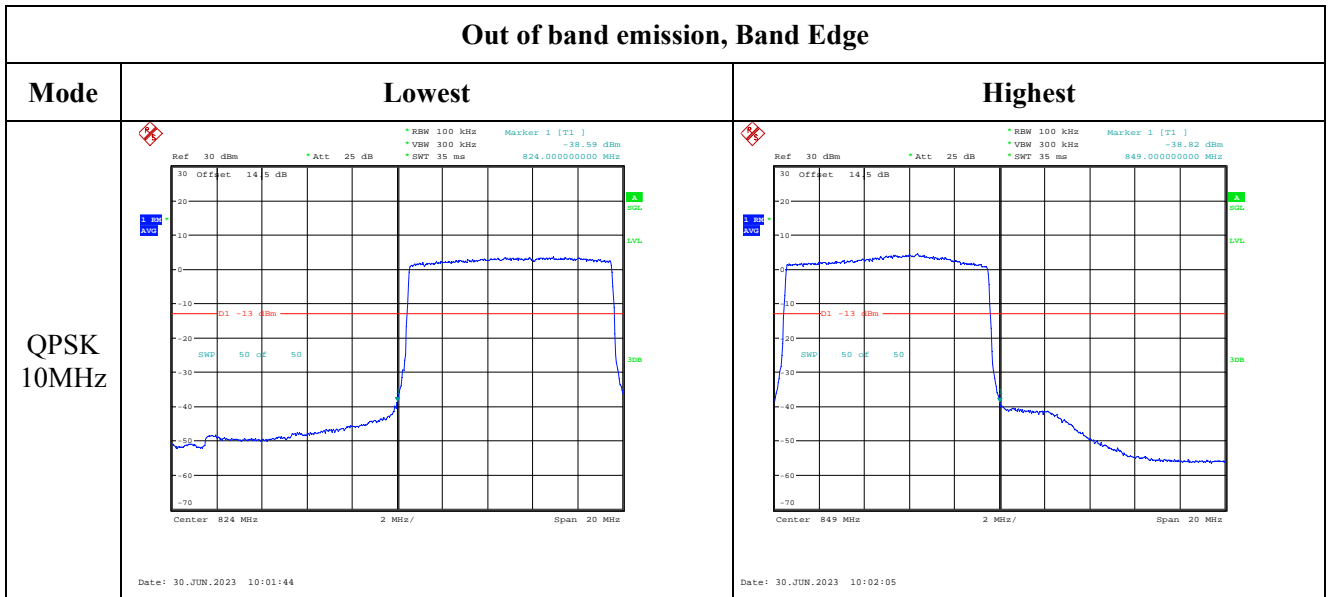

Out of band emission, Band Edge

Mode	Lowest	Highest
16QAM 1.4MHz	<p>Date: 30.JUN.2023 09:57:43</p>	<p>Date: 30.JUN.2023 09:58:00</p>
16QAM 3MHz	<p>Date: 30.JUN.2023 09:59:16</p>	<p>Date: 30.JUN.2023 09:59:34</p>
16QAM 5MHz	<p>Date: 30.JUN.2023 10:00:51</p>	<p>Date: 30.JUN.2023 10:01:09</p>

Out of band emission, Band Edge

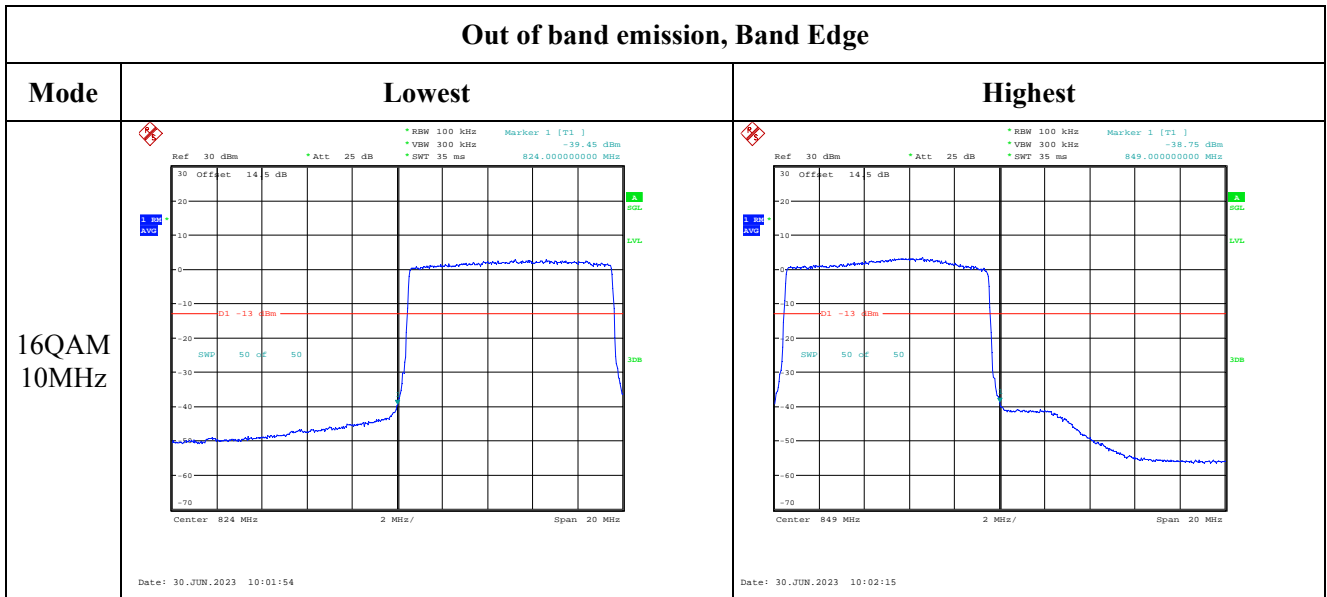

4.9 Antenna Port Test Data and Results for LTE Band 12

Serial Number:	27A0-1	Test Date:	2023/6/27-2023/7/3
Test Site:	RF	Test Mode:	Transmitting
Tester:	Claire Liu	Test Result:	Pass

Environmental Conditions:

Temperature: (°C)	24.5-26.3	Relative Humidity: (%)	41-59	ATM Pressure: (kPa)	99.8-100.7
----------------------	-----------	---------------------------	-------	------------------------	------------

Test Equipment List and Details:

Manufacturer	Description	Model	Serial Number	Calibration Date	Calibration Due Date
R&S	Spectrum Analyzer	FSU26	200256	2023/3/31	2024/3/30
zhuoxiang	Coaxial Cable	SMA-178	211001	Each time	N/A
YINSAIGE	Coaxial Cable	SS402	SJ0100001	Each time	N/A
Mini-Circuits	DC Block	BLK-18-S+	1554403	Each time	N/A
Weinschel	Power Splitter	1515	RA914	Each time	N/A
R&S	Wideband Radio Communication Tester	CMW500	149218	2023/3/31	2024/3/30
BACL	TEMP&HUMI Test Chamber	BTH-150-40	30174	2022/9/29	2023/9/28
UNI-T	Multimeter	UT39A+	C210582554	2022/9/29	2023/9/28
ZHAOXIN	DC Power Supply	RXN-6010D	21R6010D0912386	2022/7/15	2023/7/14

* Statement of Traceability: China Certification ICT Co., Ltd (Dongguan) attests that all calibrations have been performed, traceable to National Primary Standards and International System of Units (SI).

Test Frequency for Each Mode:

Operation Bandwidth	Lowest Frequency (MHz)	Middle Frequency (MHz)	Highest Frequency (MHz)
1.4MHz	699.7	707.5	715.3
3MHz	700.5	707.5	714.5
5MHz	701.5	707.5	713.5
10MHz	704	707.5	711

Test Data:

FCC§2.1046;§ 27.50(c) (10)						
RF Output Power:						
Test Bandwidth & Modulation	Resource Block & RB offset	Conducted Average Output Power(dBm)			Maximum ERP (dBm)	ERP Limit (dBm)
		Lowest Channel	Middle Channel	Highest Channel		
1.4MHz QPSK	RB1#0	25.93	25.18	25.17	23.11	34.77
	RB1#3	25.55	25.33	25.32		
	RB1#5	25.42	25.18	25.15		
	RB3#0	25.48	25.26	25.29		
	RB3#3	25.47	25.29	25.25		
	RB6#0	24.44	24.26	24.24		
1.4MHz 16QAM	RB1#0	24.52	24.18	24.15	21.87	34.77
	RB1#3	24.69	24.39	24.36		
	RB1#5	24.5	24.23	24.18		
	RB3#0	24.44	24.35	24.41		
	RB3#3	24.46	24.36	24.42		
	RB6#0	23.5	23.22	23.26		
3MHz QPSK	RB1#0	25.98	25.81	25.8	23.16	34.77
	RB1#8	25.94	25.78	25.75		
	RB1#14	25.87	25.74	25.76		
	RB6#0	24.89	24.74	24.7		
	RB6#9	24.91	24.75	24.7		
	RB15#0	24.99	24.8	24.75		
3MHz 16QAM	RB1#0	25.54	24.94	24.8	22.72	34.77
	RB1#8	25.45	24.89	24.75		
	RB1#14	25.43	24.94	24.73		
	RB6#0	24.03	23.72	23.65		
	RB6#9	23.95	23.82	23.65		
	RB15#0	24	23.76	23.81		
5MHz QPSK	RB1#0	25.91	25.71	25.64	23.14	34.77
	RB1#13	25.96	25.77	25.78		
	RB1#24	25.78	25.68	25.64		
	RB15#0	24.97	24.71	24.82		
	RB15#10	24.86	24.81	24.7		
	RB25#0	24.92	24.75	24.69		
5MHz 16QAM	RB1#0	25.16	24.76	24.54	22.4	34.77
	RB1#13	25.22	24.83	24.66		
	RB1#24	25.03	24.74	24.53		
	RB15#0	23.97	23.75	23.85		
	RB15#10	23.85	23.84	23.68		
	RB25#0	23.94	23.79	23.78		
10MHz QPSK	RB1#0	25.97	25.89	25.74	23.2	34.77
	RB1#25	26.02	25.92	25.9		
	RB1#49	25.81	25.77	25.73		

	RB25#0	25.07	24.81	24.46		
	RB25#25	24.94	24.88	24.64		
	RB50#0	25.01	24.83	24.67		
10MHz 16QAM	RB1#0	25.11	24.91	25.35	22.54	34.77
	RB1#25	25.15	24.98	25.36		
	RB1#49	24.93	24.77	25.26		
	RB25#0	24.09	23.87	23.72		
	RB25#25	23.96	23.99	23.72		
	RB50#0	24.02	23.89	23.71		

Note:

ERP= Conducted Power(dBm) - Lc(dB) + Gr(dBd)

Gr(dBd)=Gr(dBi)-2.15

Result:	Pass
----------------	-------------

Peak-to-average Ratio(PAR)					
Test Bandwidth & Modulation	Resource Block & RB offset	Peak-to-average Ratio(dB)			Limit(dB)
		Lowest Channel	Middle Channel	Highest Channel	
10MHz QPSK	RB1#0	5.10	5.1	5.22	13
	RB50#0	5.74	5.67	5.32	13
10MHz 16QAM	RB1#0	5.71	6.03	6.03	13
	RB50#0	6.51	6.44	6.31	13
Result:					Pass

FCC §2.1049, §27.53:Occupied Bandwidth						
Operation Mode	99% Occupied Bandwidth (MHz)			26 dB Occupied Bandwidth (MHz)		
	Low Channel	Middle channel	High Channel	Low Channel	Middle Channel	High Channel
1.4MHz QPSK	1.104	1.104	1.098	1.302	1.302	1.302
1.4MHz 16QAM	1.098	1.098	1.104	1.290	1.314	1.314
3MHz QPSK	2.687	2.687	2.687	2.892	2.880	2.892
3MHz 16QAM	2.687	2.676	2.687	2.880	2.892	2.880
5MHz QPSK	4.52	4.52	4.52	5.16	5.10	5.14
5MHz 16QAM	4.54	4.52	4.560	5.24	5.16	5.160
10MHz QPSK	8.96	9	8.92	9.88	10	9.80
10MHz 16QAM	9	8.96	8.96	10	9.72	9.60

Note: The test plots please refer to the Plots of Occupied Bandwidth

FCC §2.1051, §27.53:Spurious Emissions at Antenna Terminal	
Result:	Pass, Please refer to the test plots of Spurious Emissions at Antenna Terminal.

FCC §2.1051, §27.53: Out of band emission, Band Edge	
Result:	Pass, Please refer to the test plots of Out of band emission, Band Edge.

FCC §2.1055, §27.54: Frequency Stability						
Test Mode:	10M QPSK	Test Channel: Lowest for Lower Edge, Highest for Upper Edge				
Test Item	Temperature (°C)	Voltage (V _{DC})	Lower Edge (MHz)		Upper Edge (MHz)	
			Result	Limit	Result	Limit
Frequency Stability vs. Temperature	-30	3.85	699.551	699.00	715.503	716.00
	-20	3.85	699.514	699.00	715.484	716.00
	-10	3.85	699.566	699.00	715.513	716.00
	0	3.85	699.561	699.00	715.499	716.00
	10	3.85	699.540	699.00	715.494	716.00
	20	3.85	699.520	699.00	715.440	716.00
	30	3.85	699.557	699.00	715.474	716.00
	40	3.85	699.553	699.00	715.472	716.00
Frequency Stability vs. Voltage	20	3.6	699.512	699.00	715.460	716.00
	20	4.35	699.544	699.00	715.451	716.00
					Result:	Pass

Test Mode:	10M 16QAM	Test Channel: Lowest for Lower Edge, Highest for Upper Edge				
Test Item	Temperature (°C)	Voltage (V _{DC})	Lower Edge (MHz)		Upper Edge (MHz)	
			Result	Limit	Result	Limit
Frequency Stability vs. Temperature	-30	3.85	699.493	699.00	715.479	716.00
	-20	3.85	699.534	699.00	715.462	716.00
	-10	3.85	699.528	699.00	715.472	716.00
	0	3.85	699.457	699.00	715.456	716.00
	10	3.85	699.477	699.00	715.421	716.00
	20	3.85	699.520	699.00	715.480	716.00
	30	3.85	699.449	699.00	715.457	716.00
	40	3.85	699.442	699.00	715.459	716.00
Frequency Stability vs. Voltage	20	3.6	699.466	699.00	715.445	716.00
	20	4.35	699.461	699.00	715.449	716.00
					Result:	Pass

Test Plots(Note: The 14.5 dB is the Insertion loss of the RF cable and Power Splitter, which was offset into the Spectrum Analyzer):

Occupied Bandwidth		
Channel	1.4MHz Bandwidth QPSK	1.4MHz Bandwidth 16QAM
Lowest	<p>Ref 30 dBm *Att 25 dB *RBW 30 kHz *VBW 100 kHz SWT 15 ms Delta 1 [T1] -0.67 dB OBW 1.302000000 MHz Marker 1 [T1] -70 dBm Temp 1 [T1 OSW] 699.148000000 MHz Temp 2 [T1 OSW] 700.252000000 MHz</p> <p>Center 699.7 MHz 300 kHz/ Span 3 MHz Date: 29.JUN.2023 23:07:01</p>	<p>Ref 30 dBm *Att 25 dB *RBW 30 kHz *VBW 100 kHz SWT 15 ms Delta 1 [T1] -0.52 dB OBW 1.290000000 MHz Marker 1 [T1] -70 dBm Temp 1 [T1 OSW] 699.052000000 MHz Temp 2 [T1 OSW] 700.246000000 MHz</p> <p>Center 699.7 MHz 300 kHz/ Span 3 MHz Date: 29.JUN.2023 23:07:21</p>
Middle	<p>Ref 30 dBm *Att 25 dB *RBW 30 kHz *VBW 100 kHz SWT 15 ms Delta 1 [T1] -0.16 dB OBW 1.104000000 MHz Marker 1 [T1] -70 dBm Temp 1 [T1 OSW] 706.948000000 MHz Temp 2 [T1 OSW] 708.052000000 MHz</p> <p>Center 707.5 MHz 300 kHz/ Span 3 MHz Date: 29.JUN.2023 23:07:42</p>	<p>Ref 30 dBm *Att 25 dB *RBW 30 kHz *VBW 100 kHz SWT 15 ms Delta 1 [T1] -0.67 dB OBW 1.314000000 MHz Marker 1 [T1] -70 dBm Temp 1 [T1 OSW] 706.846000000 MHz Temp 2 [T1 OSW] 708.052000000 MHz</p> <p>Center 707.5 MHz 300 kHz/ Span 3 MHz Date: 29.JUN.2023 23:08:02</p>
Highest	<p>Ref 30 dBm *Att 25 dB *RBW 30 kHz *VBW 100 kHz SWT 15 ms Delta 1 [T1] 0.88 dB OBW 1.098000000 MHz Marker 1 [T1] -70 dBm Temp 1 [T1 OSW] 714.748000000 MHz Temp 2 [T1 OSW] 715.846000000 MHz</p> <p>Center 715.3 MHz 300 kHz/ Span 3 MHz Date: 29.JUN.2023 23:08:23</p>	<p>Ref 30 dBm *Att 25 dB *RBW 30 kHz *VBW 100 kHz SWT 15 ms Delta 1 [T1] 1.38 dB OBW 1.104000000 MHz Marker 1 [T1] -70 dBm Temp 1 [T1 OSW] 714.824000000 MHz Temp 2 [T1 OSW] 715.846000000 MHz</p> <p>Center 715.3 MHz 300 kHz/ Span 3 MHz Date: 29.JUN.2023 23:08:43</p>

Occupied Bandwidth

Channel	3MHz Bandwidth QPSK	3MHz Bandwidth 16QAM
Lowest		
Middle		
Highest		

Occupied Bandwidth

Channel	5MHz Bandwidth QPSK	5MHz Bandwidth 16QAM
Lowest		
Middle		
Highest		

Occupied Bandwidth

Channel	10MHz Bandwidth QPSK	10MHz Bandwidth 16QAM
Lowest	<p>Ref 30 dBm *Att 25 dB *RBW 100 kHz Delta 1 [T1] 0.58 dB *VBW 300 kHz *SWT 10 ms 9.880000000 MHz Marker 1 [T1] 699.120000000 MHz -11.61 dBm Temp 1 [T1 OSW] 699.520000000 MHz -11.70 dBm Temp 2 [T1 OSW] 708.480000000 MHz -11.70 dBm Center 704 MHz 2 MHz/ Span 20 MHz Date: 29.JUN.2023 23:15:19</p>	<p>Ref 30 dBm *Att 25 dB *RBW 100 kHz Delta 1 [T1] -2.44 dB *VBW 300 kHz *SWT 10 ms 9.880000000 MHz Marker 1 [T1] 699.120000000 MHz -11.75 dBm Temp 1 [T1 OSW] 699.520000000 MHz -12.74 dBm Temp 2 [T1 OSW] 708.520000000 MHz -12.74 dBm Center 704 MHz 2 MHz/ Span 20 MHz Date: 29.JUN.2023 23:15:43</p>
Middle	<p>Ref 30 dBm *Att 25 dB *RBW 100 kHz Delta 1 [T1] -3.17 dB *VBW 300 kHz *SWT 10 ms 9.800000000 MHz Marker 1 [T1] 702.620000000 MHz -11.14 dBm Temp 1 [T1 OSW] 703.020000000 MHz -11.57 dBm Temp 2 [T1 OSW] 712.020000000 MHz -11.57 dBm Center 707.5 MHz 2 MHz/ Span 20 MHz Date: 29.JUN.2023 23:16:06</p>	<p>Ref 30 dBm *Att 25 dB *RBW 100 kHz Delta 1 [T1] 2.28 dB *VBW 300 kHz *SWT 10 ms 9.720000000 MHz Marker 1 [T1] 702.660000000 MHz -11.25 dBm Temp 1 [T1 OSW] 703.020000000 MHz -12.43 dBm Temp 2 [T1 OSW] 711.980000000 MHz -12.43 dBm Center 707.5 MHz 2 MHz/ Span 20 MHz Date: 29.JUN.2023 23:16:26</p>
Highest	<p>Ref 30 dBm *Att 25 dB *RBW 100 kHz Delta 1 [T1] 0.74 dB *VBW 300 kHz *SWT 10 ms 9.800000000 MHz Marker 1 [T1] 706.080000000 MHz -11.06 dBm Temp 1 [T1 OSW] 706.520000000 MHz -12.07 dBm Temp 2 [T1 OSW] 715.440000000 MHz -12.07 dBm Center 711 MHz 2 MHz/ Span 20 MHz Date: 29.JUN.2023 23:16:50</p>	<p>Ref 30 dBm *Att 25 dB *RBW 100 kHz Delta 1 [T1] 0.11 dB *VBW 300 kHz *SWT 10 ms 9.600000000 MHz Marker 1 [T1] 706.160000000 MHz -11.47 dBm Temp 1 [T1 OSW] 706.520000000 MHz -12.57 dBm Temp 2 [T1 OSW] 715.480000000 MHz -12.57 dBm Center 711 MHz 2 MHz/ Span 20 MHz Date: 29.JUN.2023 23:17:10</p>

Spurious Emissions at Antenna Terminal

Channel

1.4MHz Bandwidth QPSK

Lowest

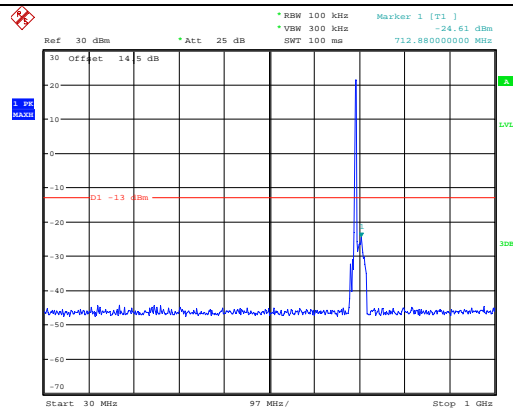

Date: 30.JUN.2023 13:29:49

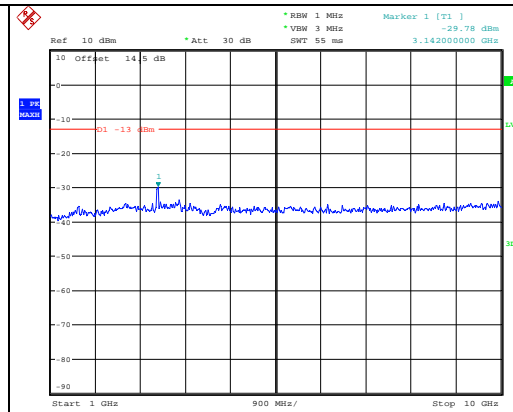

Date: 30.JUN.2023 13:29:59

Middle

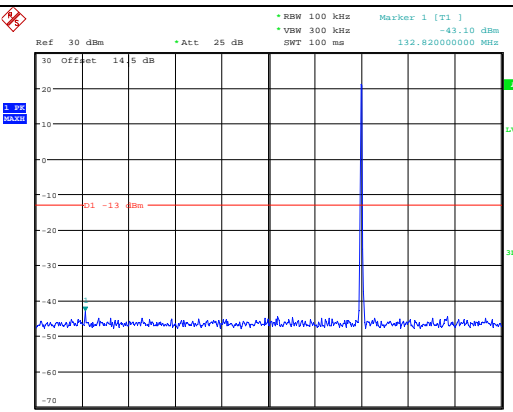

Date: 30.JUN.2023 13:30:13

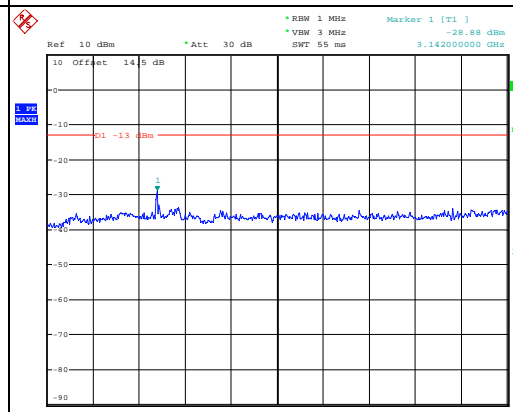

Date: 30.JUN.2023 13:30:23

Highest

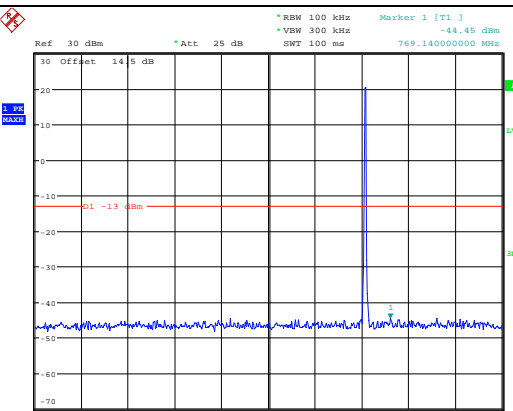

Date: 30.JUN.2023 13:30:36

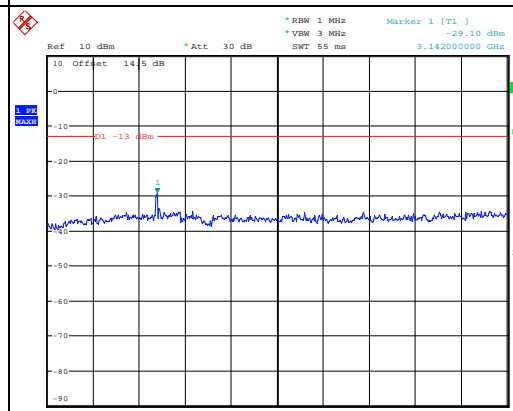

Date: 30.JUN.2023 13:30:46

Spurious Emissions at Antenna Terminal

Channel

3MHz Bandwidth QPSK

Lowest

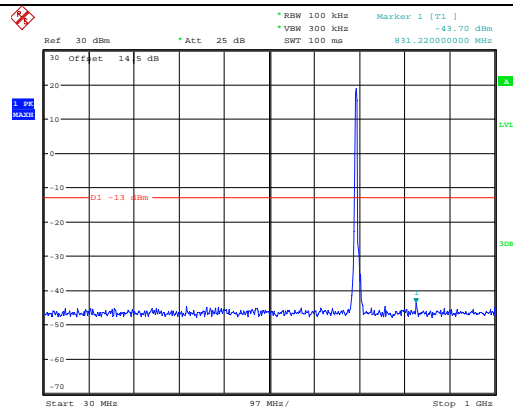

Date: 30.JUN.2023 13:31:53

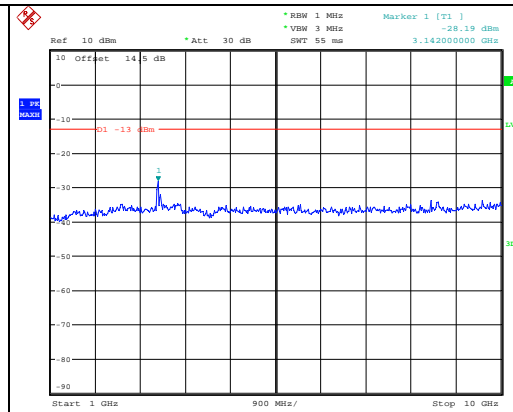

Date: 30.JUN.2023 13:32:04

Middle

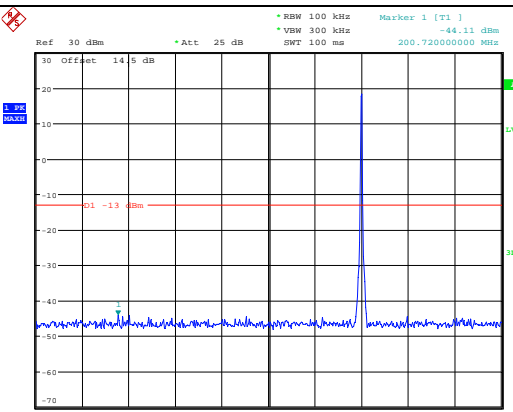

Date: 30.JUN.2023 13:32:19

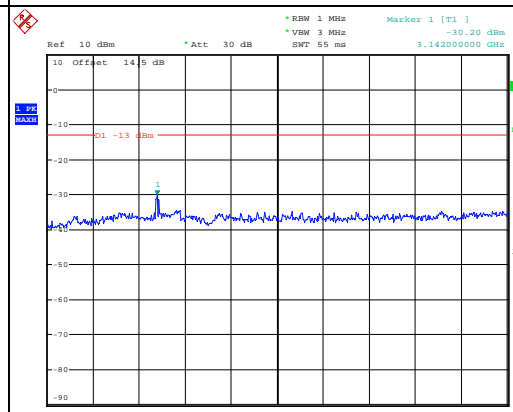

Date: 30.JUN.2023 13:32:32

Highest

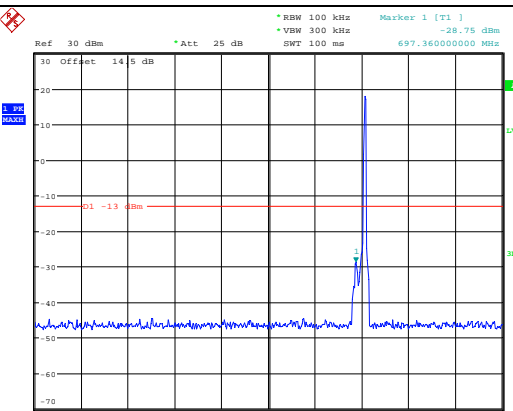

Date: 30.JUN.2023 13:32:51

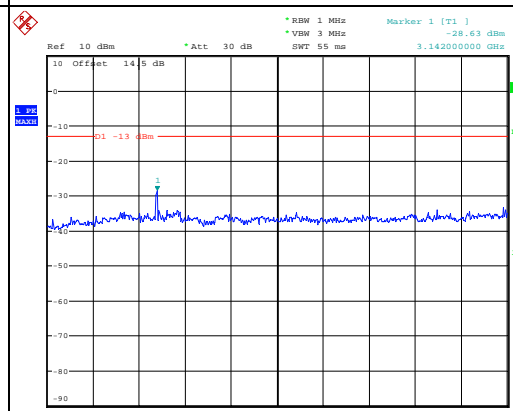

Date: 30.JUN.2023 13:33:03

Spurious Emissions at Antenna Terminal

Channel

5MHz Bandwidth QPSK

Lowest

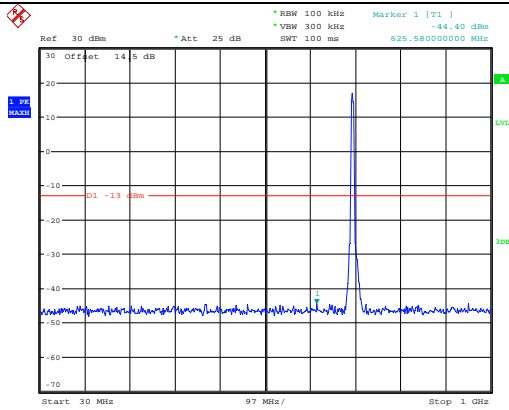

Date: 30.JUN.2023 13:42:01

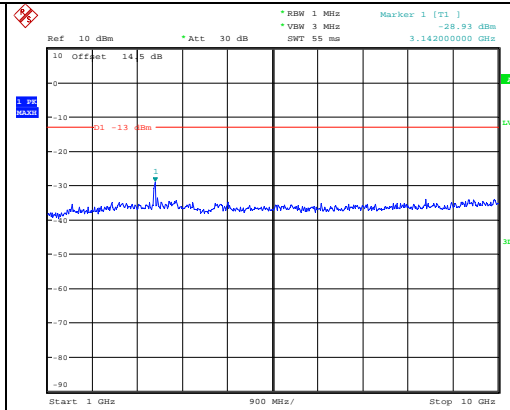

Date: 30.JUN.2023 13:42:12

Middle

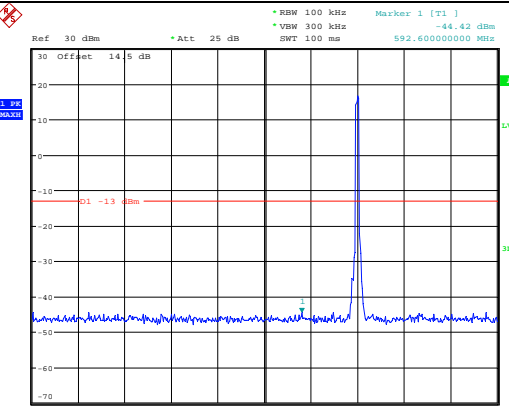

Date: 30.JUN.2023 13:42:28

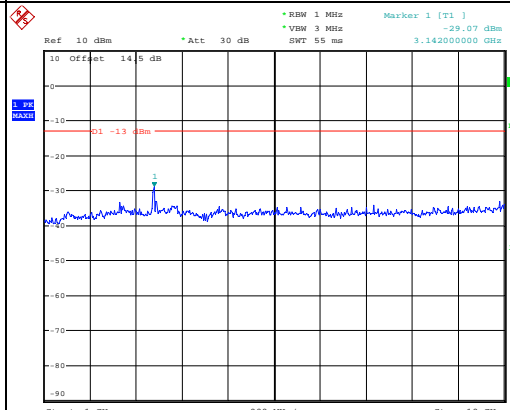

Date: 30.JUN.2023 13:42:39

Highest

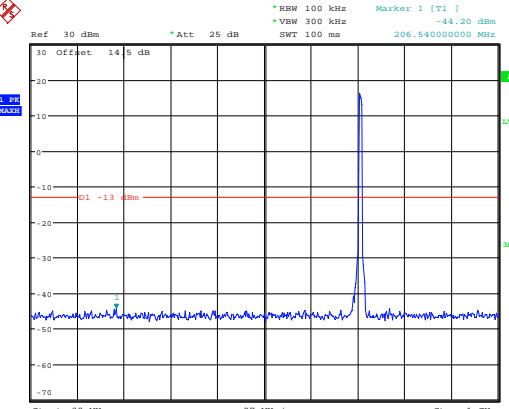

Date: 30.JUN.2023 13:42:55

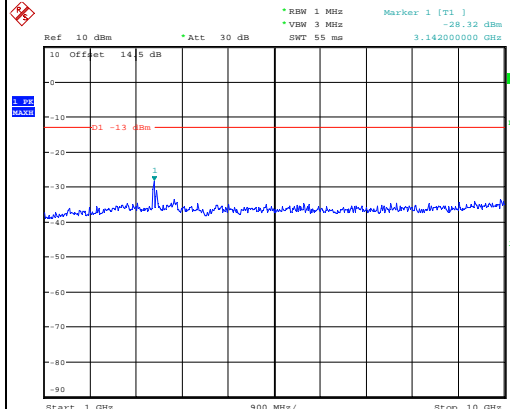

Date: 30.JUN.2023 13:43:06

Spurious Emissions at Antenna Terminal

Channel	10MHz Bandwidth QPSK	
Lowest	<p>Ref 30 dBm Att 25 dB RBW 100 kHz Marker 1 [T1] -44.22 dBm VSW 300 kHz SWT 100 ms 156.798000000 MHz</p> <p>Start 30 MHz 97 MHz/ Stop 1 GHz</p> <p>Date: 30.JUN.2023 13:44:23</p>	<p>Ref 10 dBm Att 30 dB RBW 1 MHz Marker 1 [T1] -28.59 dBm VSW 3 MHz SWT 55 ms 3.142000000 GHz</p> <p>Start 1 GHz 900 MHz/ Stop 10 GHz</p> <p>Date: 30.JUN.2023 13:44:36</p>
	Middle	<p>Ref 30 dBm Att 25 dB RBW 100 kHz Marker 1 [T1] -43.90 dBm VSW 300 kHz SWT 100 ms 511.120000000 MHz</p> <p>Start 30 MHz 97 MHz/ Stop 1 GHz</p> <p>Date: 30.JUN.2023 13:44:52</p>
Highest		<p>Ref 30 dBm Att 25 dB RBW 100 kHz Marker 1 [T1] -41.16 dBm VSW 300 kHz SWT 100 ms 743.920000000 MHz</p> <p>Start 30 MHz 97 MHz/ Stop 1 GHz</p> <p>Date: 30.JUN.2023 13:45:24</p>

Out of band emission, Band Edge

Mode	Lowest	Highest
QPSK 1.4MHz	<p>Date: 30.JUN.2023 10:02:28</p>	<p>Date: 30.JUN.2023 10:02:45</p>
QPSK 3MHz	<p>Date: 30.JUN.2023 10:10:24</p>	<p>Date: 30.JUN.2023 10:10:41</p>
QPSK 5MHz	<p>Date: 30.JUN.2023 10:11:51</p>	<p>Date: 30.JUN.2023 10:12:10</p>

Out of band emission, Band Edge

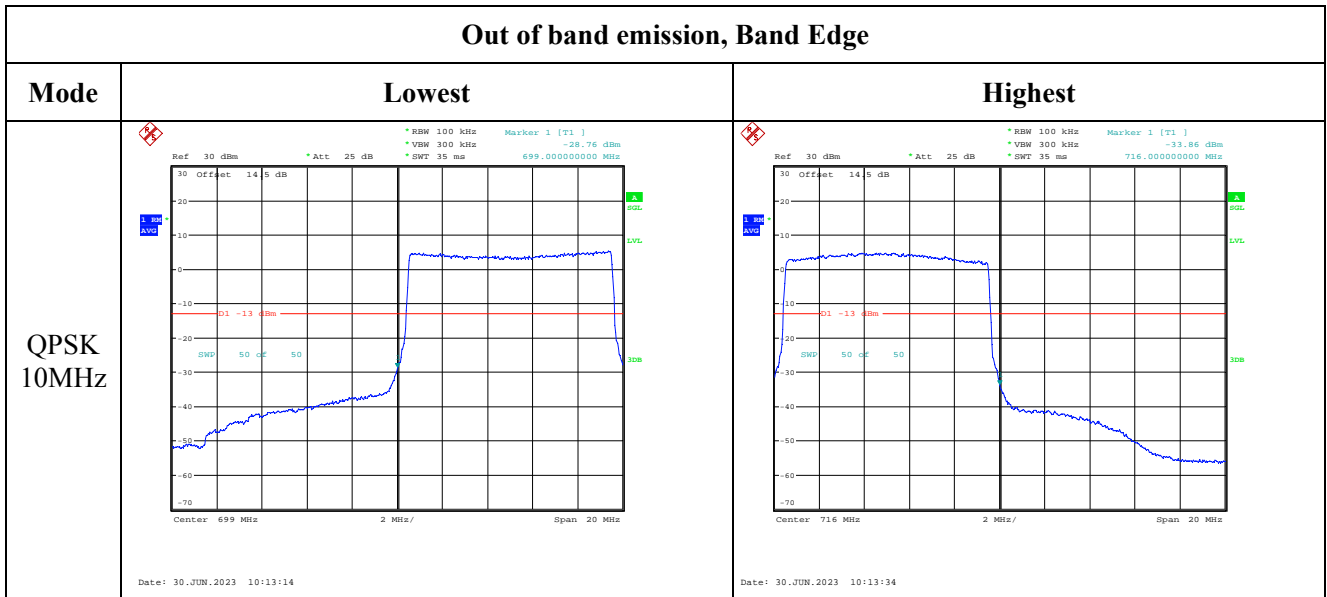

Out of band emission, Band Edge

Mode	Lowest	Highest
16QAM 1.4MHz	<p>Date: 30.JUN.2023 10:02:52</p>	<p>Date: 30.JUN.2023 10:02:52</p>
16QAM 3MHz	<p>Date: 30.JUN.2023 10:10:32</p>	<p>Date: 30.JUN.2023 10:10:48</p>
16QAM 5MHz	<p>Date: 30.JUN.2023 10:12:01</p>	<p>Date: 30.JUN.2023 10:12:17</p>

Out of band emission, Band Edge

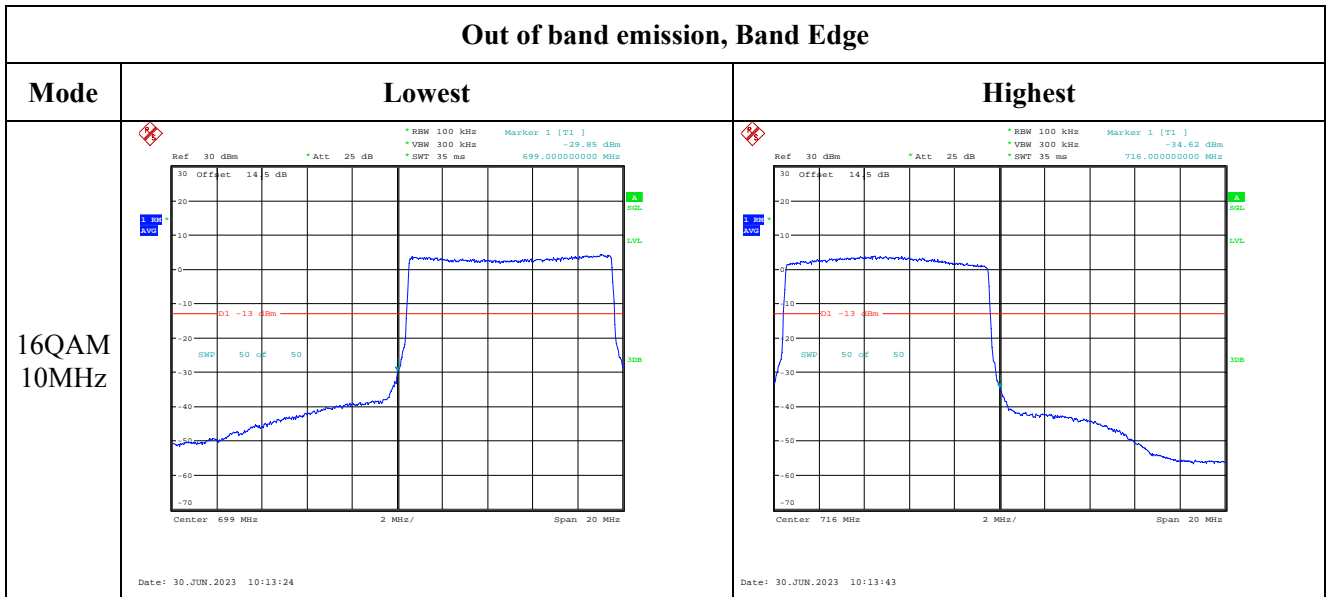

4.10 Antenna Port Test Data and Results for LTE Band 17

Serial Number:	27A0-1	Test Date:	2023/6/27-2023/7/3
Test Site:	RF	Test Mode:	Transmitting
Tester:	Claire Liu	Test Result:	Pass

Environmental Conditions:

Temperature: (°C)	24.5-26.3	Relative Humidity: (%)	41-59	ATM Pressure: (kPa)	99.8-100.7
----------------------	-----------	---------------------------	-------	------------------------	------------

Test Equipment List and Details:

Manufacturer	Description	Model	Serial Number	Calibration Date	Calibration Due Date
R&S	Spectrum Analyzer	FSU26	200256	2023/3/31	2024/3/30
zhuoxiang	Coaxial Cable	SMA-178	211001	Each time	N/A
YINSAIGE	Coaxial Cable	SS402	SJ0100001	Each time	N/A
Mini-Circuits	DC Block	BLK-18-S+	1554403	Each time	N/A
Weinschel	Power Splitter	1515	RA914	Each time	N/A
R&S	Wideband Radio Communication Tester	CMW500	149218	2023/3/31	2024/3/30
BACL	TEMP&HUMI Test Chamber	BTH-150-40	30174	2022/9/29	2023/9/28
UNI-T	Multimeter	UT39A+	C210582554	2022/9/29	2023/9/28
ZHAOXIN	DC Power Supply	RXN-6010D	21R6010D0912386	2022/7/15	2023/7/14

* Statement of Traceability: China Certification ICT Co., Ltd (Dongguan) attests that all calibrations have been performed, traceable to National Primary Standards and International System of Units (SI).

Test Frequency for Each Mode:

Operation Bandwidth	Lowest Frequency (MHz)	Middle Frequency (MHz)	Highest Frequency (MHz)
5MHz	706.5	710	713.5
10MHz	709	710	711

Test Data:

FCC§2.1046;§ 27.50(c) (10)						
RF Output Power:						
Test Bandwidth & Modulation	Resource Block & RB offset	Conducted Average Output Power(dBm)			Maximum ERP (dBm)	ERP Limit (dBm)
		Lowest Channel	Middle Channel	Highest Channel		
5MHz QPSK	RB1#0	25.12	25.2	25.18	22.49	34.77
	RB1#13	25.24	25.24	25.31		
	RB1#24	25.16	25.2	25.25		
	RB15#0	24.14	24.17	24.37		
	RB15#10	24.28	24.26	24.24		
	RB25#0	24.18	24.22	24.26		
5MHz 16QAM	RB1#0	24.36	24.22	24.06	21.71	34.77
	RB1#13	24.53	24.33	24.22		
	RB1#24	24.47	24.28	24.14		
	RB15#0	23.12	23.23	23.39		
	RB15#10	23.24	23.27	23.26		
	RB25#0	23.22	23.25	23.34		
10MHz QPSK	RB1#0	25.13	25.21	25.21	22.55	34.77
	RB1#25	25.27	25.34	25.37		
	RB1#49	25.27	25.27	25.3		
	RB25#0	24.11	24.1	24.1		
	RB25#25	24.22	24.2	24.17		
	RB50#0	24.21	24.15	24.13		
10MHz 16QAM	RB1#0	24.71	24.32	24.19	22.13	34.77
	RB1#25	24.95	24.47	24.32		
	RB1#49	24.81	24.39	24.32		
	RB25#0	23.18	23.18	23.23		
	RB25#25	23.31	23.21	23.27		
	RB50#0	23.2	23.19	23.2		

Note:

ERP= Conducted Power(dBm) - Lc(dB) + Gr(dBd)

Gr(dBd)=Gr(dBi)-2.15

Result:**Pass****Peak-to-average Ratio(PAR)**

Test Bandwidth & Modulation	Resource Block & RB offset	Peak-to-average Ratio(dB)			Limit (dB)
		Lowest Channel	Middle Channel	Highest Channel	
10MHz QPSK	RB1#0	5.29	5.51	5.48	13
	RB50#0	5.45	5.48	5.35	13
10MHz 16QAM	RB1#0	5.87	6.19	6.57	13
	RB50#0	6.41	6.35	6.35	13
Result:					Pass

FCC §2.1049, §27.53:Occupied Bandwidth						
Operation Mode	99% Occupied Bandwidth (MHz)			26 dB Occupied Bandwidth (MHz)		
	Low Channel	Middle channel	High Channel	Low Channel	Middle Channel	High Channel
5MHz QPSK	4.54	4.52	4.560	5.14	5.08	5.180
5MHz 16QAM	4.54	4.54	4.52	5.18	5.16	5.12
10MHz QPSK	8.92	8.96	8.92	9.80	9.84	9.72
10MHz 16QAM	8.96	8.96	8.96	9.72	9.68	9.80

Note: The test plots please refer to the Plots of Occupied Bandwidth

FCC §2.1051, §27.53:Spurious Emissions at Antenna Terminal	
Result:	Pass, Please refer to the test plots of Spurious Emissions at Antenna Terminal.

FCC §2.1051, §27.53:Out of band emission, Band Edge	
Result:	Pass, Please refer to the test plots of Out of band emission, Band Edge.

FCC §2.1055, §27.54: Frequency Stability						
Test Mode:	10M QPSK	Test Channel: Lowest for Lower Edge,Highest for Upper Edge				
Test Item	Temperature (°C)	Voltage (V _{DC})	Lower Edge (MHz)		Upper Edge (MHz)	
			Result	Limit	Result	Limit
Frequency Stability vs. Temperature	-30	3.85	704.590	704.00	715.441	716.00
	-20	3.85	704.525	704.00	715.414	716.00
	-10	3.85	704.526	704.00	715.497	716.00
	0	3.85	704.540	704.00	715.419	716.00
	10	3.85	704.556	704.00	715.497	716.00
	20	3.85	704.560	704.00	715.440	716.00
	30	3.85	704.501	704.00	715.411	716.00
	40	3.85	704.502	704.00	715.484	716.00
Frequency Stability vs. Voltage	20	3.6	704.542	704.00	715.469	716.00
	20	4.35	704.549	704.00	715.430	716.00
					Result:	Pass

Test Mode:	10M 16QAM	Test Channel: Lowest for Lower Edge,Highest for Upper Edge				
Test Item	Temperature (°C)	Voltage (V _{DC})	Lower Edge (MHz)		Upper Edge (MHz)	
			Result	Limit	Result	Limit
Frequency Stability vs. Temperature	-30	3.85	704.580	704.00	715.408	716.00
	-20	3.85	704.570	704.00	715.490	716.00
	-10	3.85	704.578	704.00	715.466	716.00
	0	3.85	704.554	704.00	715.445	716.00
	10	3.85	704.518	704.00	715.412	716.00
	20	3.85	704.520	704.00	715.480	716.00
	30	3.85	704.548	704.00	715.409	716.00
	40	3.85	704.587	704.00	715.442	716.00
	50	3.85	704.516	704.00	715.480	716.00
Frequency Stability vs. Voltage	20	3.6	704.525	704.00	715.401	716.00
	20	4.35	704.569	704.00	715.418	716.00
					Result:	Pass

Test Plots(Note: The 14.5 dB is the Insertion loss of the RF cable and Power Splitter, which was offset into the Spectrum Analyzer):

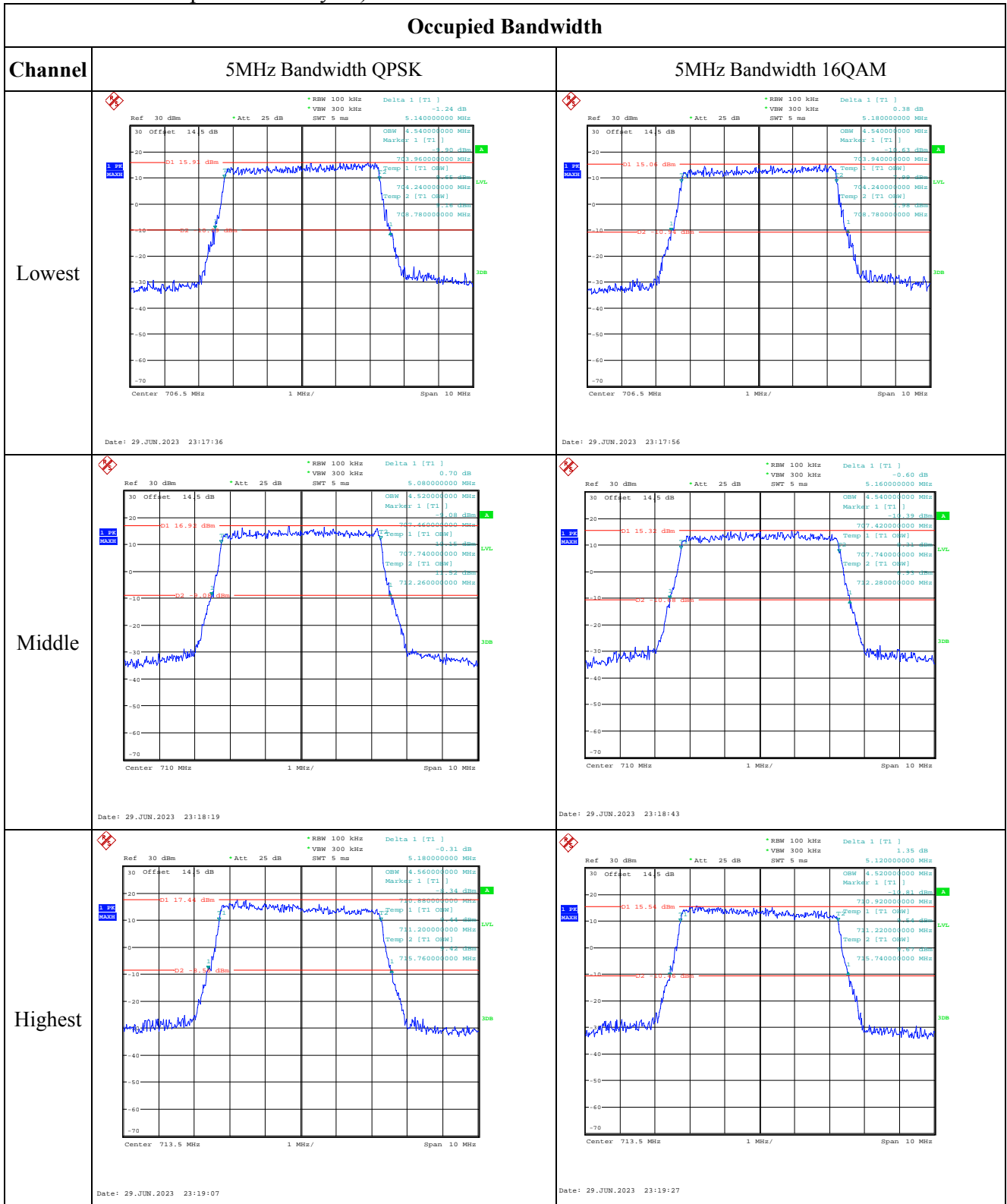

Occupied Bandwidth

Channel	10MHz Bandwidth QPSK	10MHz Bandwidth 16QAM
Lowest	<p>Date: 29.JUN.2023 23:20:17</p>	<p>Date: 29.JUN.2023 23:20:37</p>
Middle	<p>Date: 29.JUN.2023 23:21:01</p>	<p>Date: 29.JUN.2023 23:21:21</p>
Highest	<p>Date: 29.JUN.2023 23:21:45</p>	<p>Date: 29.JUN.2023 23:22:05</p>

Spurious Emissions at Antenna Terminal

Channel

5MHz Bandwidth QPSK

Lowest

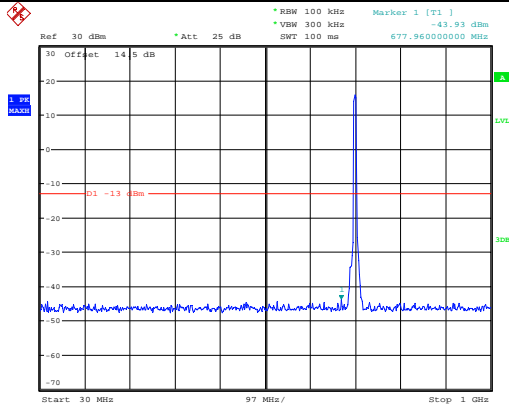

Date: 30.JUN.2023 13:46:01

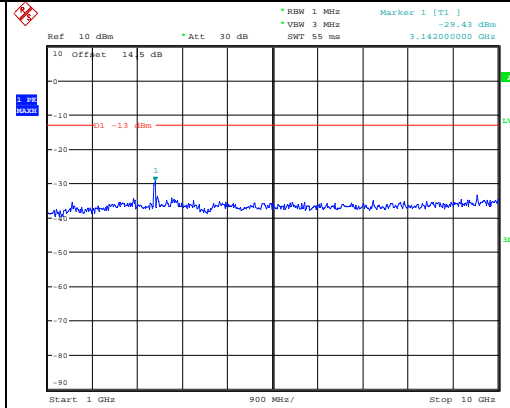

Date: 30.JUN.2023 13:46:14

Middle

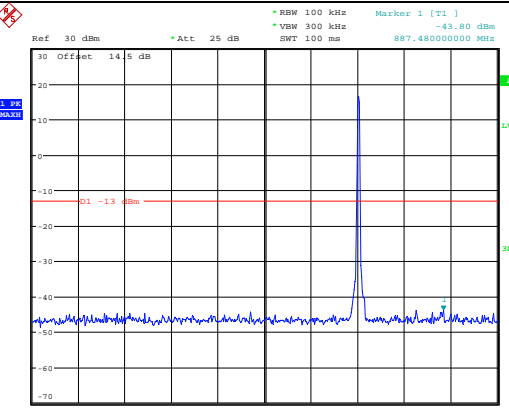

Date: 30.JUN.2023 13:46:29

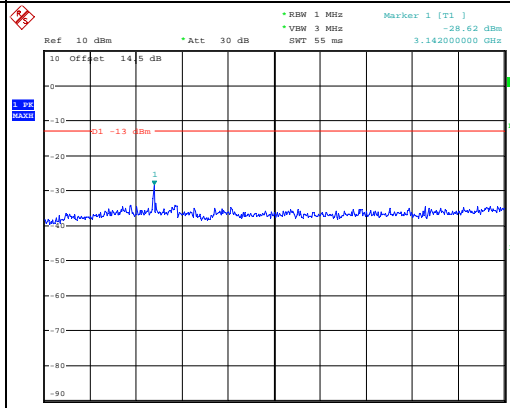

Date: 30.JUN.2023 13:46:42

Highest

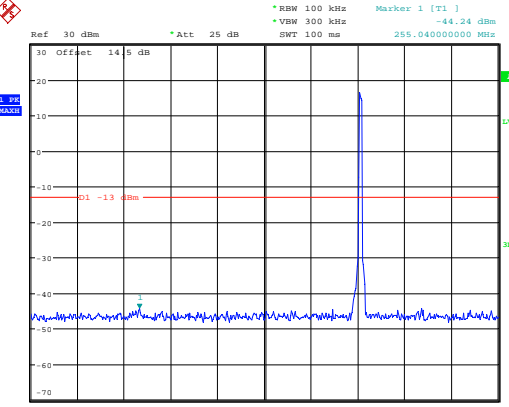

Date: 30.JUN.2023 13:46:57

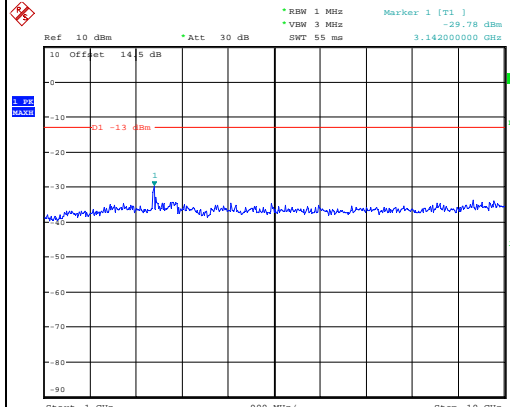

Date: 30.JUN.2023 13:47:10

Spurious Emissions at Antenna Terminal

Channel	10MHz Bandwidth QPSK	
Lowest	<p>Ref 30 dBm *Att 25 dB *RBW 100 kHz Marker 1 [T1] -43.51 dBm *VSW 300 kHz 220.12000000 MHz *SWT 100 ms</p> <p>Start 30 MHz 97 MHz/ Stop 1 GHz</p> <p>Date: 30.JUN.2023 14:02:06</p>	<p>Ref 10 dBm *Att 30 dB *RBW 1 MHz Marker 1 [T1] -29.51 dBm *VSW 3 MHz 3.142000000 GHz *SWT 55 ms</p> <p>Start 1 GHz 900 MHz/ Stop 10 GHz</p> <p>Date: 30.JUN.2023 14:02:19</p>
Middle	<p>Ref 30 dBm *Att 25 dB *RBW 100 kHz Marker 1 [T1] -44.34 dBm *VSW 300 kHz 200.72000000 MHz *SWT 100 ms</p> <p>Start 30 MHz 97 MHz/ Stop 1 GHz</p> <p>Date: 30.JUN.2023 14:02:38</p>	<p>Ref 10 dBm *Att 30 dB *RBW 1 MHz Marker 1 [T1] -28.44 dBm *VSW 3 MHz 3.142000000 GHz *SWT 55 ms</p> <p>Start 1 GHz 900 MHz/ Stop 10 GHz</p> <p>Date: 30.JUN.2023 14:02:51</p>
Highest	<p>Ref 30 dBm *Att 25 dB *RBW 100 kHz Marker 1 [T1] -44.71 dBm *VSW 300 kHz 674.08000000 MHz *SWT 100 ms</p> <p>Start 30 MHz 97 MHz/ Stop 1 GHz</p> <p>Date: 30.JUN.2023 14:03:07</p>	<p>Ref 10 dBm *Att 30 dB *RBW 1 MHz Marker 1 [T1] -28.35 dBm *VSW 3 MHz 3.142000000 GHz *SWT 55 ms</p> <p>Start 1 GHz 900 MHz/ Stop 10 GHz</p> <p>Date: 30.JUN.2023 14:03:19</p>

Out of band emission, Band Edge

Mode	Lowest	Highest
QPSK 5MHz		
QPSK 10MHz		

Out of band emission, Band Edge

Mode	Lowest	Highest
16QAM 5MHz	<p>Date: 30.JUN.2023 10:14:06</p>	<p>Date: 30.JUN.2023 10:14:23</p>
16QAM 10MHz	<p>Date: 30.JUN.2023 10:15:44</p>	<p>Date: 30.JUN.2023 10:16:02</p>

4.11 Antenna Port Test Data and Results for LTE Band 25

Serial Number:	27A0-1	Test Date:	2023/6/27-2023/7/26
Test Site:	RF	Test Mode:	Transmitting
Tester:	Claire Liu	Test Result:	Pass

Environmental Conditions:

Temperature: (°C)	24.5-26.8	Relative Humidity: (%)	41-62	ATM Pressure: (kPa)	99.8-100.9
----------------------	-----------	---------------------------	-------	------------------------	------------

Test Equipment List and Details:

Manufacturer	Description	Model	Serial Number	Calibration Date	Calibration Due Date
R&S	Spectrum Analyzer	FSU26	200256	2023/3/31	2024/3/30
zhuoxiang	Coaxial Cable	SMA-178	211001	Each time	N/A
YINSAIGE	Coaxial Cable	SS402	SJ0100001	Each time	N/A
Mini-Circuits	DC Block	BLK-18-S+	1554403	Each time	N/A
Weinschel	Power Splitter	1515	RA914	Each time	N/A
R&S	Wideband Radio Communication Tester	CMW500	149218	2023/3/31	2024/3/30
BACL	TEMP&HUMI Test Chamber	BTH-150-40	30174	2022/9/29	2023/9/28
UNI-T	Multimeter	UT39A+	C210582554	2022/7/15	2023/7/14
ZHAOXIN	DC Power Supply	RXN-6010D	21R6010D0912386	2022/7/15	2023/7/14
UNI-T	Multimeter	UT39A+	C210582554	2022/9/29	2023/9/28

* Statement of Traceability: China Certification ICT Co., Ltd (Dongguan) attests that all calibrations have been performed, traceable to National Primary Standards and International System of Units (SI).

Test Frequency for Each Mode:

Operation Bandwidth	Lowest Frequency (MHz)	Middle Frequency (MHz)	Highest Frequency (MHz)
1.4MHz	1850.7	1882.5	1914.3
3MHz	1851.5	1882.5	1913.5
5MHz	1852.5	1882.5	1912.5
10MHz	1855	1882.5	1910
15MHz	1857.5	1882.5	1907.5
20MHz	1860	1882.5	1905

Test Data:

FCC§2.1046;§ 24.232						
RF Output Power:						
Test Bandwidth & Modulation	Resource Block & RB offset	Conducted Average Output Power(dBm)			Maximum EIRP(dBm)	EIRP Limit(dBm)
		Lowest Channel	Middle Channel	Highest Channel		
1.4MHz QPSK	RB1#0	22.13	22.24	22.09	22.77	33
	RB1#3	22.32	22.4	22.23		
	RB1#5	22.12	22.2	22.05		
	RB3#0	22.26	22.35	21.87		
	RB3#3	22.26	22.34	21.85		
	RB6#0	21.24	21.29	21.19		
1.4MHz 16QAM	RB1#0	21.28	21.25	20.83	21.89	33
	RB1#3	21.48	21.52	20.98		
	RB1#5	21.28	21.25	20.81		
	RB3#0	21.22	21.47	20.85		
	RB3#3	21.26	21.38	20.88		
	RB6#0	20.29	20.29	19.99		
3MHz QPSK	RB1#0	22.87	21.83	21.2	23.25	33
	RB1#8	22.88	21.81	21.19		
	RB1#14	22.79	21.73	21.14		
	RB6#0	21.81	20.85	20.19		
	RB6#9	21.76	20.78	20.18		
	RB15#0	21.84	20.82	20.04		
3MHz 16QAM	RB1#0	21.87	21.45	20.16	22.24	33
	RB1#8	21.86	21.38	20.09		
	RB1#14	21.8	21.41	20.06		
	RB6#0	20.81	19.98	19.07		
	RB6#9	20.81	19.9	19.04		
	RB15#0	20.95	19.98	18.95		
5MHz QPSK	RB1#0	22.79	22.33	21.77	23.18	33
	RB1#13	22.81	22.41	21.92		
	RB1#24	22.68	22.28	21.75		
	RB15#0	21.9	21.48	20.76		
	RB15#10	21.83	21.4	20.81		
	RB25#0	21.82	21.43	20.73		
5MHz 16QAM	RB1#0	21.83	21.26	20.99	22.29	33
	RB1#13	21.92	21.36	20.95		
	RB1#24	21.75	21.23	20.79		
	RB15#0	20.96	20.57	19.77		
	RB15#10	20.9	20.46	19.74		
	RB25#0	20.9	20.52	19.71		
10MHz QPSK	RB1#0	22.86	21.91	21.9	23.35	33
	RB1#25	22.98	22.02	22.04		
	RB1#49	22.72	21.76	21.87		

	RB25#0	21.92	21.05	21.14		
	RB25#25	21.83	20.81	20.94		
	RB50#0	21.9	20.97	21.01		
10MHz 16QAM	RB1#0	21.92	21.4	21.05	22.34	33
	RB1#25	21.97	21.64	21.18		
	RB1#49	21.74	21.4	20.79		
	RB25#0	21.1	20.17	20.17		
	RB25#25	20.96	19.92	19.94		
	RB50#0	20.99	20.03	20.07		
15MHz QPSK	RB1#0	22.78	22.46	22.16	23.15	33
	RB1#38	22.78	22.42	22.05		
	RB1#74	22.63	22.2	21.98		
	RB36#0	21.93	21.61	21.34		
	RB36#39	21.88	21.36	21.13		
	RB75#0	21.91	21.54	21.25		
15MHz 16QAM	RB1#0	22.33	21.53	21.36	22.7	33
	RB1#38	22.31	21.6	21.48		
	RB1#74	22.05	21.38	20.95		
	RB36#0	20.97	20.6	20.3		
	RB36#39	20.84	20.4	20.09		
	RB75#0	20.95	20.49	20.2		
20MHz QPSK	RB1#0	22.64	21.61	22.03	23.29	33
	RB1#50	22.92	21.87	22.22		
	RB1#99	22.4	21.34	21.71		
	RB50#0	21.88	20.79	21.05		
	RB50#50	21.74	20.48	20.88		
	RB100#0	21.85	20.69	21.04		
20MHz 16QAM	RB1#0	21.97	20.69	21.39	22.54	33
	RB1#50	22.17	21.06	21.75		
	RB1#99	21.53	20.52	20.97		
	RB50#0	20.93	19.84	20.03		
	RB50#50	20.75	19.58	19.94		
	RB100#0	20.92	19.73	20.06		

Note: EIRP=Conducted Power(dBm) - Lc(dB) + G_T(dBi)**Result:****Pass**

Peak-to-average Ratio(PAR)					
Test Bandwidth & Modulation	Resource Block & RB offset	Peak-to-average Ratio(dB)			Limit (dB)
		Lowest Channel	Middle Channel	Highest Channel	
20MHz QPSK	RB1#0	10.13	9.97	10.3	13
	RB100#0	6.57	6.38	6.44	13
20MHz 16QAM	RB1#0	9.78	9.36	9.74	13
	RB100#0	7.15	7.24	7.18	13
				Result:	Pass

FCC §2.1049, §24.238: Occupied Bandwidth						
Operation Mode	99% Occupied Bandwidth (MHz)			26 dB Occupied Bandwidth (MHz)		
	Low Channel	Middle channel	High Channel	Low Channel	Middle Channel	High Channel
1.4MHz QPSK	1.098	1.104	1.104	1.314	1.296	1.410
1.4MHz 16QAM	1.092	1.098	1.11	1.302	1.302	1.31
3MHz QPSK	2.687	2.687	2.7	2.880	2.868	2.9
3MHz 16QAM	2.676	2.687	2.687	2.880	2.892	3.036
5MHz QPSK	4.52	4.52	4.54	5.16	5.14	5.24
5MHz 16QAM	4.54	4.54	4.54	5.22	5.08	5.16
10MHz QPSK	9.00	9	8.96	9.92	10	10.08
10MHz 16QAM	8.96	9	9	9.80	10	10
15MHz QPSK	13.560	13.5	13.560	15.240	15.0	15.300
15MHz 16QAM	13.560	13.5	13.560	15.180	15.0	15.240
20MHz QPSK	18	18	18	20	20	20
20MHz 16QAM	18	18	18	20	20	19

Note: The test plots please refer to the Plots of Occupied Bandwidth

FCC §2.1051, § 24.238 (a): Spurious Emissions at Antenna Terminal	
Result:	Pass, Please refer to the test plots of Spurious Emissions at Antenna Terminal.

FCC §2.1051, § 24.238 (a): Out of band emission, Band Edge	
Result:	Pass, Please refer to the test plots of Out of band emission, Band Edge.

FCC §2.1055, §24.235: Frequency Stability						
Test Mode:	20M QPSK	Test Channel: Lowest for Lower Edge, Highest for Upper Edge				
Test Item	Temperature (°C)	Voltage (V _{DC})	Lower Edge (MHz)		Upper Edge (MHz)	
			Result	Limit	Result	Limit
Frequency Stability vs. Temperature	-30	3.85	1851.069	1850.000	1914.032	1915.000
	-20	3.85	1851.092	1850.000	1914.053	1915.000
	-10	3.85	1851.092	1850.000	1914.065	1915.000
	0	3.85	1851.056	1850.000	1914.002	1915.000
	10	3.85	1851.053	1850.000	1914.092	1915.000
	20	3.85	1851.040	1850.000	1914.040	1915.000
	30	3.85	1851.054	1850.000	1914.074	1915.000
	40	3.85	1851.064	1850.000	1914.043	1915.000
	50	3.85	1851.066	1850.000	1914.016	1915.000
Frequency Stability vs. Voltage	20	3.6	1851.071	1850.000	1914.001	1915.000
	20	4.35	1851.021	1850.000	1914.039	1915.000
					Result:	Pass

Test Mode:	20M 16QAM	Test Channel: Lowest for Lower Edge,Highest for Upper Edge				
Test Item	Temperature (°C)	Voltage (V _{DC})	Lower Edge (MHz)		Upper Edge (MHz)	
			Result	Limit	Result	Limit
Frequency Stability vs. Temperature	-30	3.85	1851.084	1850.000	1914.015	1915.000
	-20	3.85	1851.082	1850.000	1914.092	1915.000
	-10	3.85	1851.048	1850.000	1914.029	1915.000
	0	3.85	1851.063	1850.000	1914.062	1915.000
	10	3.85	1851.049	1850.000	1914.017	1915.000
	20	3.85	1851.040	1850.000	1914.040	1915.000
	30	3.85	1851.036	1850.000	1914.024	1915.000
	40	3.85	1851.056	1850.000	1914.089	1915.000
	50	3.85	1851.017	1850.000	1914.069	1915.000
Frequency Stability vs. Voltage	20	3.6	1851.088	1850.000	1914.056	1915.000
	20	4.35	1851.046	1850.000	1914.075	1915.000
					Result:	Pass

Test Plots (Note: The 14.5 dB is the Insertion loss of the RF cable and Power Splitter, which was offset into the Spectrum Analyzer):

Occupied Bandwidth		
Channel	1.4MHz Bandwidth QPSK	1.4MHz Bandwidth 16QAM
Lowest		
Middle		
Highest		

Occupied Bandwidth

Channel	3MHz Bandwidth QPSK	3MHz Bandwidth 16QAM
Lowest	<p>Date: 29.JUN.2023 23:25:02</p>	<p>Date: 29.JUN.2023 23:25:22</p>
Middle	<p>Date: 29.JUN.2023 23:25:43</p>	<p>Date: 29.JUN.2023 23:26:03</p>
Highest	<p>Date: 29.JUN.2023 23:26:24</p>	<p>Date: 29.JUN.2023 23:26:47</p>

Occupied Bandwidth

Channel	5MHz Bandwidth QPSK	5MHz Bandwidth 16QAM
Lowest	<p>Ref 30 dBm Att 25 dB RBW 100 kHz Delta 1 [T1] -0.88 dB VBW 300 kHz SWT 5 ms OSW 4.52000000 MHz Marker 1 [T1] -5.11 dBm OSW 4.52000000 MHz Temp 1 [T1 OSW] 1.84884000 GHz Temp 2 [T1 OSW] 1.85024000 GHz Temp 3 [T1 OSW] 1.85476000 GHz Center 1.8525 GHz 1 MHz/ Span 10 MHz</p> <p>Date: 29.JUN.2023 23:27:33</p>	<p>Ref 30 dBm Att 25 dB RBW 100 kHz Delta 1 [T1] -0.34 dB VBW 300 kHz SWT 5 ms OSW 4.54000000 MHz Marker 1 [T1] -10.76 dBm OSW 4.54000000 MHz Temp 1 [T1 OSW] 1.84986000 GHz Temp 2 [T1 OSW] 1.85024000 GHz Temp 3 [T1 OSW] 1.85476000 GHz Center 1.8525 GHz 1 MHz/ Span 10 MHz</p> <p>Date: 29.JUN.2023 23:27:53</p>
Middle	<p>Ref 30 dBm Att 25 dB RBW 100 kHz Delta 1 [T1] 0.68 dB VBW 300 kHz SWT 5 ms OSW 4.52000000 MHz Marker 1 [T1] -10.86 dBm OSW 4.52000000 MHz Temp 1 [T1 OSW] 1.87952000 GHz Temp 2 [T1 OSW] 1.88024000 GHz Temp 3 [T1 OSW] 1.88476000 GHz Center 1.8825 GHz 1 MHz/ Span 10 MHz</p> <p>Date: 29.JUN.2023 23:28:14</p>	<p>Ref 30 dBm Att 25 dB RBW 100 kHz Delta 1 [T1] 0.01 dB VBW 300 kHz SWT 5 ms OSW 4.54000000 MHz Marker 1 [T1] -10.31 dBm OSW 4.54000000 MHz Temp 1 [T1 OSW] 1.87956000 GHz Temp 2 [T1 OSW] 1.88022000 GHz Temp 3 [T1 OSW] 1.88476000 GHz Center 1.8825 GHz 1 MHz/ Span 10 MHz</p> <p>Date: 29.JUN.2023 23:28:34</p>
Highest	<p>Ref 30 dBm Att 25 dB RBW 100 kHz Delta 1 [T1] -0.23 dB VBW 300 kHz SWT 5 ms OSW 4.54000000 MHz Marker 1 [T1] -10.81 dBm OSW 4.54000000 MHz Temp 1 [T1 OSW] 1.90992000 GHz Temp 2 [T1 OSW] 1.91024000 GHz Temp 3 [T1 OSW] 1.91478000 GHz Center 1.9125 GHz 1 MHz/ Span 10 MHz</p> <p>Date: 29.JUN.2023 23:28:58</p>	<p>Ref 30 dBm Att 25 dB RBW 100 kHz Delta 1 [T1] 0.71 dB VBW 300 kHz SWT 5 ms OSW 4.54000000 MHz Marker 1 [T1] -10.64 dBm OSW 4.54000000 MHz Temp 1 [T1 OSW] 1.90994000 GHz Temp 2 [T1 OSW] 1.91024000 GHz Temp 3 [T1 OSW] 1.91478000 GHz Center 1.9125 GHz 1 MHz/ Span 10 MHz</p> <p>Date: 29.JUN.2023 23:29:21</p>

Occupied Bandwidth

Channel	10MHz Bandwidth QPSK	10MHz Bandwidth 16QAM
Lowest	<p>Ref 30 dBm *Att 25 dB *RBW 100 kHz Delta 1 [T1] -0.42 dB *VSW 300 kHz SWT 10 ms 9.91666667 MHz</p> <p>OSW 9.90000000 MHz Marker 1 [T1] -11.48 dBm Temp 1 [T1 OSW] 1.85000795 GHz Temp 2 [T1 OSW] 1.85948000 GHz</p> <p>D1 7.22 dBm D2 -18.70 dBm</p> <p>Center 1.855 GHz 2 MHz/ Span 20 MHz</p> <p>Date: 26.JUL.2023 08:26:47</p>	<p>Ref 30 dBm *Att 25 dB *RBW 100 kHz Delta 1 [T1] 0.17 dB *VSW 300 kHz SWT 10 ms 9.80000000 MHz</p> <p>OSW 9.90000000 MHz Marker 1 [T1] -11.50 dBm Temp 1 [T1 OSW] 1.85012000 GHz Temp 2 [T1 OSW] 1.85052000 GHz Temp 3 [T1 OSW] 1.85948000 GHz</p> <p>D1 12.14 dBm D2 -13.67 dBm</p> <p>Center 1.855 GHz 2 MHz/ Span 20 MHz</p> <p>Date: 29.JUN.2023 23:31:16</p>
Middle	<p>Ref 30 dBm *Att 25 dB *RBW 100 kHz Delta 1 [T1] 0.35 dB *VSW 300 kHz SWT 10 ms 9.84000000 MHz</p> <p>OSW 9.90000000 MHz Marker 1 [T1] -11.39 dBm Temp 1 [T1 OSW] 1.87758000 GHz Temp 2 [T1 OSW] 1.87798000 GHz Temp 3 [T1 OSW] 1.88698000 GHz</p> <p>D1 13.74 dBm D2 -12.27 dBm</p> <p>Center 1.8825 GHz 2 MHz/ Span 20 MHz</p> <p>Date: 29.JUN.2023 23:31:37</p>	<p>Ref 30 dBm *Att 25 dB *RBW 100 kHz Delta 1 [T1] -1.15 dB *VSW 300 kHz SWT 10 ms 9.84000000 MHz</p> <p>OSW 9.90000000 MHz Marker 1 [T1] -11.87 dBm Temp 1 [T1 OSW] 1.87758000 GHz Temp 2 [T1 OSW] 1.87798000 GHz Temp 3 [T1 OSW] 1.88698000 GHz</p> <p>D1 12.68 dBm D2 -13.13 dBm</p> <p>Center 1.8825 GHz 2 MHz/ Span 20 MHz</p> <p>Date: 29.JUN.2023 23:32:00</p>
Highest	<p>Ref 30 dBm *Att 25 dB *RBW 100 kHz Delta 1 [T1] 0.93 dB *VSW 300 kHz SWT 10 ms 10.08000000 MHz</p> <p>OSW 9.96000000 MHz Marker 1 [T1] -11.87 dBm Temp 1 [T1 OSW] 1.90896000 GHz Temp 2 [T1 OSW] 1.90552000 GHz Temp 3 [T1 OSW] 1.91448000 GHz</p> <p>D1 12.94 dBm D2 -13.07 dBm</p> <p>Center 1.91 GHz 2 MHz/ Span 20 MHz</p> <p>Date: 29.JUN.2023 23:32:21</p>	<p>Ref 30 dBm *Att 25 dB *RBW 100 kHz Delta 1 [T1] 0.33 dB *VSW 300 kHz SWT 10 ms 10.04000000 MHz</p> <p>OSW 9.90000000 MHz Marker 1 [T1] -11.74 dBm Temp 1 [T1 OSW] 1.90500000 GHz Temp 2 [T1 OSW] 1.90552000 GHz Temp 3 [T1 OSW] 1.91452000 GHz</p> <p>D1 11.71 dBm D2 -14.25 dBm</p> <p>Center 1.91 GHz 2 MHz/ Span 20 MHz</p> <p>Date: 29.JUN.2023 23:32:41</p>

Occupied Bandwidth

Channel	15MHz Bandwidth QPSK	15MHz Bandwidth 16QAM
Lowest	<p>Ref 30 dBm *Att 25 dB *RBW 300 kHz Delta 1 [T1] 4.14 dB *VMW 1 MHz *SWT 2.5 ms 15.24000000 MHz Marker 1 [T1] 16.85 dBm Marker 2 [T1] 15.24000000 MHz Marker 3 [T1] 1.85750000 GHz Marker 4 [T1] 1.86428000 GHz Temp 1 [T1] 16.85 dBm Temp 2 [T1] 15.24000000 MHz Temp 3 [T1] 1.85750000 GHz Temp 4 [T1] 1.86428000 GHz Center 1.8575 GHz 3 MHz/ Span 30 MHz Date: 29.JUN.2023 23:33:30</p>	<p>Ref 30 dBm *Att 25 dB *RBW 300 kHz Delta 1 [T1] 1.30 dB *VMW 1 MHz *SWT 2.5 ms 15.18000000 MHz Marker 1 [T1] 16.29 dBm Marker 2 [T1] 15.18000000 MHz Marker 3 [T1] 1.85750000 GHz Marker 4 [T1] 1.86428000 GHz Temp 1 [T1] 16.29 dBm Temp 2 [T1] 15.18000000 MHz Temp 3 [T1] 1.85750000 GHz Temp 4 [T1] 1.86428000 GHz Center 1.8575 GHz 3 MHz/ Span 30 MHz Date: 29.JUN.2023 23:33:54</p>
Middle	<p>Ref 30 dBm *Att 25 dB *RBW 300 kHz Delta 1 [T1] -0.41 dB *VMW 1 MHz *SWT 2.5 ms 15.00000000 MHz Marker 1 [T1] 16.33 dBm Marker 2 [T1] 15.00000000 MHz Marker 3 [T1] 1.88250000 GHz Marker 4 [T1] 1.88922000 GHz Temp 1 [T1] 16.33 dBm Temp 2 [T1] 15.00000000 MHz Temp 3 [T1] 1.88250000 GHz Temp 4 [T1] 1.88922000 GHz Center 1.8825 GHz 3 MHz/ Span 30 MHz Date: 29.JUN.2023 23:34:15</p>	<p>Ref 30 dBm *Att 25 dB *RBW 300 kHz Delta 1 [T1] -0.37 dB *VMW 1 MHz *SWT 2.5 ms 15.00000000 MHz Marker 1 [T1] 16 dBm Marker 2 [T1] 15.00000000 MHz Marker 3 [T1] 1.88250000 GHz Marker 4 [T1] 1.88922000 GHz Temp 1 [T1] 16 dBm Temp 2 [T1] 15.00000000 MHz Temp 3 [T1] 1.88250000 GHz Temp 4 [T1] 1.88922000 GHz Center 1.8825 GHz 3 MHz/ Span 30 MHz Date: 29.JUN.2023 23:34:32</p>
Highest	<p>Ref 30 dBm *Att 25 dB *RBW 300 kHz Delta 1 [T1] -3.27 dB *VMW 1 MHz *SWT 2.5 ms 15.30000000 MHz Marker 1 [T1] 16.99 dBm Marker 2 [T1] 15.30000000 MHz Marker 3 [T1] 1.90750000 GHz Marker 4 [T1] 1.91428000 GHz Temp 1 [T1] 16.99 dBm Temp 2 [T1] 15.30000000 MHz Temp 3 [T1] 1.90750000 GHz Temp 4 [T1] 1.91428000 GHz Center 1.9075 GHz 3 MHz/ Span 30 MHz Date: 29.JUN.2023 23:34:53</p>	<p>Ref 30 dBm *Att 25 dB *RBW 300 kHz Delta 1 [T1] -1.02 dB *VMW 1 MHz *SWT 2.5 ms 15.24000000 MHz Marker 1 [T1] 15.63 dBm Marker 2 [T1] 15.24000000 MHz Marker 3 [T1] 1.90750000 GHz Marker 4 [T1] 1.91428000 GHz Temp 1 [T1] 15.63 dBm Temp 2 [T1] 15.24000000 MHz Temp 3 [T1] 1.90750000 GHz Temp 4 [T1] 1.91428000 GHz Center 1.9075 GHz 3 MHz/ Span 30 MHz Date: 29.JUN.2023 23:35:17</p>

Occupied Bandwidth

Channel	20MHz Bandwidth QPSK	20MHz Bandwidth 16QAM
Lowest	<p>Ref 30 dBm Off/Att 14.5 dB Att 25 dB *RBW 300 kHz Delta 1 [T1] -4.57 dB *VMW 1 MHz SWT 2.5 ms 19.760000000 MHz OSW 16.000000000 MHz Marker 1 [T1] -11.88 dBm D1 15.63 dBm D2 10.07 dBm Temp 1 [T1 OSW] 1.850240000 GHz Temp 2 [T1 OSW] 1.851040000 GHz Temp 3 [T1 OSW] 1.869040000 GHz Center 1.86 GHz 4 MHz/ Span 40 MHz Date: 29.JUN.2023 23:36:07</p>	<p>Ref 30 dBm Off/Att 14.5 dB Att 25 dB *RBW 300 kHz Delta 1 [T1] -0.23 dB *VMW 1 MHz SWT 2.5 ms 19.520000000 MHz OSW 16.000000000 MHz Marker 1 [T1] -11.00 dBm D1 15.44 dBm D2 10.87 dBm Temp 1 [T1 OSW] 1.850320000 GHz Temp 2 [T1 OSW] 1.851040000 GHz Temp 3 [T1 OSW] 1.869040000 GHz Center 1.86 GHz 4 MHz/ Span 40 MHz Date: 29.JUN.2023 23:36:27</p>
Middle	<p>Ref 30 dBm Off/Att 14.5 dB Att 25 dB *RBW 300 kHz Delta 1 [T1] 0.50 dB *VMW 1 MHz SWT 2.5 ms 19.520000000 MHz OSW 16.000000000 MHz Marker 1 [T1] -11.47 dBm D1 16.34 dBm D2 10.64 dBm Temp 1 [T1 OSW] 1.872660000 GHz Temp 2 [T1 OSW] 1.873460000 GHz Temp 3 [T1 OSW] 1.891460000 GHz Center 1.8825 GHz 4 MHz/ Span 40 MHz Date: 29.JUN.2023 23:36:48</p>	<p>Ref 30 dBm Off/Att 14.5 dB Att 25 dB *RBW 300 kHz Delta 1 [T1] 0.82 dB *VMW 1 MHz SWT 2.5 ms 19.680000000 MHz OSW 16.000000000 MHz Marker 1 [T1] -11.50 dBm D1 14.21 dBm D2 11.17 dBm Temp 1 [T1 OSW] 1.872660000 GHz Temp 2 [T1 OSW] 1.873460000 GHz Temp 3 [T1 OSW] 1.891460000 GHz Center 1.8825 GHz 4 MHz/ Span 40 MHz Date: 29.JUN.2023 23:37:11</p>
Highest	<p>Ref 30 dBm Off/Att 14.5 dB Att 25 dB *RBW 300 kHz Delta 1 [T1] 0.63 dB *VMW 1 MHz SWT 2.5 ms 19.520000000 MHz OSW 16.000000000 MHz Marker 1 [T1] -11.22 dBm D1 14.63 dBm D2 11.37 dBm Temp 1 [T1 OSW] 1.895400000 GHz Temp 2 [T1 OSW] 1.896040000 GHz Temp 3 [T1 OSW] 1.914040000 GHz Center 1.905 GHz 4 MHz/ Span 40 MHz Date: 29.JUN.2023 23:37:33</p>	<p>Ref 30 dBm Off/Att 14.5 dB Att 25 dB *RBW 300 kHz Delta 1 [T1] 0.82 dB *VMW 1 MHz SWT 2.5 ms 19.440000000 MHz OSW 16.000000000 MHz Marker 1 [T1] -11.61 dBm D1 15.3 dBm D2 10.7 dBm Temp 1 [T1 OSW] 1.895320000 GHz Temp 2 [T1 OSW] 1.896040000 GHz Temp 3 [T1 OSW] 1.914040000 GHz Center 1.905 GHz 4 MHz/ Span 40 MHz Date: 29.JUN.2023 23:37:56</p>

Spurious Emissions at Antenna Terminal

Channel

1.4MHz Bandwidth QPSK

Lowest

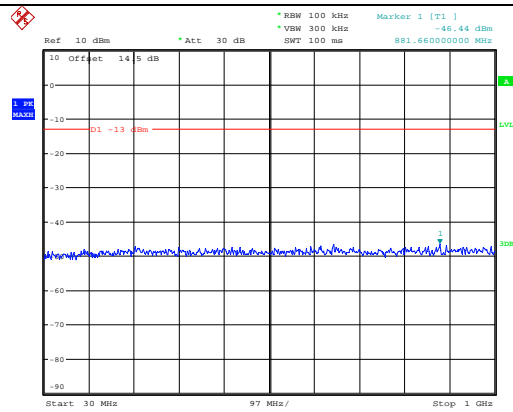

Date: 30.JUN.2023 14:03:40

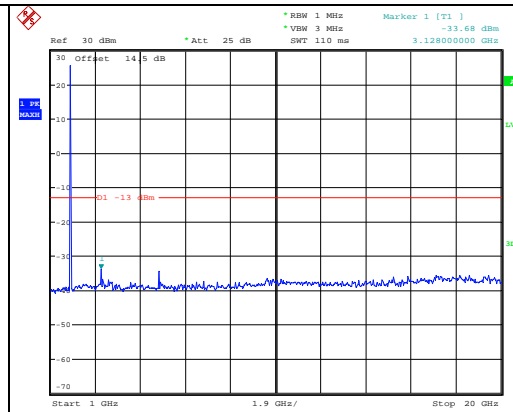

Date: 30.JUN.2023 14:03:53

Middle

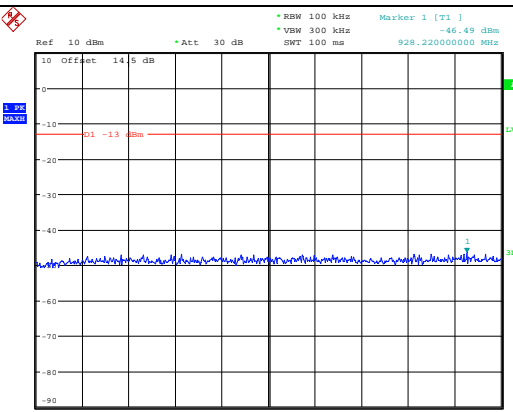

Date: 30.JUN.2023 14:04:12

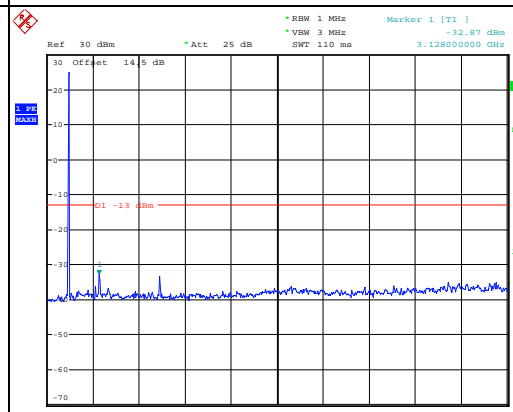

Date: 30.JUN.2023 14:04:25

Highest

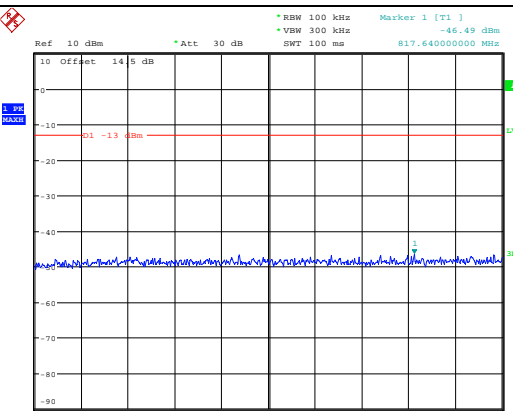

Date: 30.JUN.2023 14:04:44

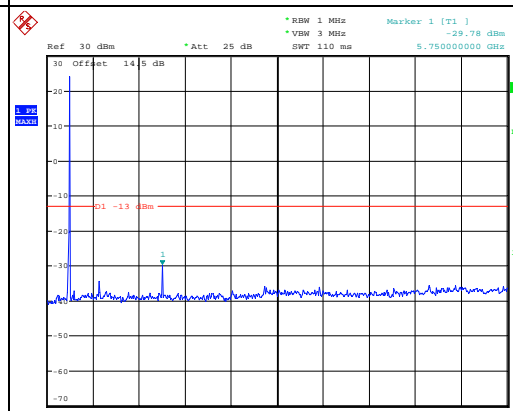

Date: 30.JUN.2023 14:04:57

Spurious Emissions at Antenna Terminal

Channel	3MHz Bandwidth QPSK	
Lowest	<p>Ref 10 dBm Att 30 dB RBW 100 kHz Marker 1 [T1] -46.10 dBm VSW 300 kHz SWT 100 ms 613.940000000 MHz</p> <p>Date: 30.JUN.2023 14:11:59</p>	<p>Ref 30 dBm Att 25 dB RBW 1 MHz Marker 1 [T1] -33.23 dBm VSW 3 MHz SWT 110 ms 3.128000000 GHz</p> <p>Date: 30.JUN.2023 14:12:12</p>
Middle	<p>Ref 10 dBm Att 30 dB RBW 100 kHz Marker 1 [T1] -46.28 dBm VSW 300 kHz SWT 100 ms 980.600000000 MHz</p> <p>Date: 30.JUN.2023 14:12:31</p>	<p>Ref 30 dBm Att 25 dB RBW 1 MHz Marker 1 [T1] -32.91 dBm VSW 3 MHz SWT 110 ms 3.128000000 GHz</p> <p>Date: 30.JUN.2023 14:12:44</p>
Highest	<p>Ref 10 dBm Att 30 dB RBW 100 kHz Marker 1 [T1] -45.95 dBm VSW 300 kHz SWT 100 ms 827.340000000 MHz</p> <p>Date: 30.JUN.2023 14:13:02</p>	<p>Ref 30 dBm Att 25 dB RBW 1 MHz Marker 1 [T1] -31.90 dBm VSW 3 MHz SWT 110 ms 3.128000000 GHz</p> <p>Date: 30.JUN.2023 14:13:16</p>

Spurious Emissions at Antenna Terminal

Channel

5MHz Bandwidth QPSK

Lowest

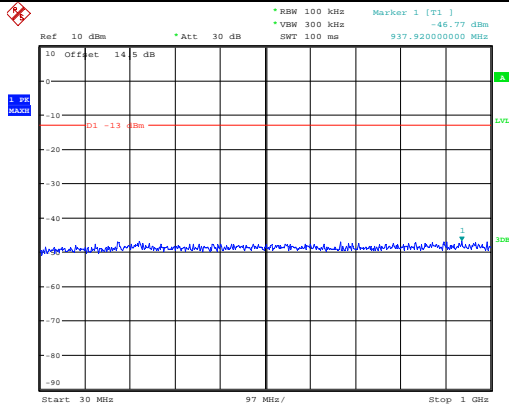

Date: 30.JUN.2023 14:14:06

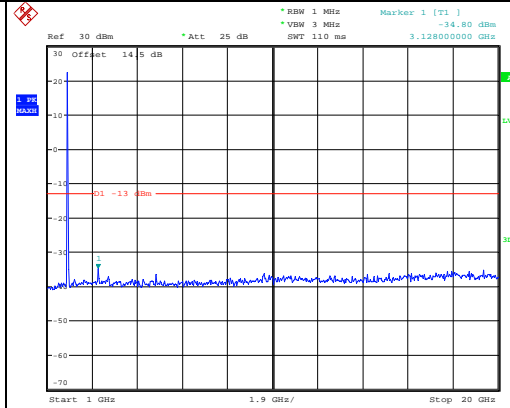

Date: 30.JUN.2023 14:14:19

Middle

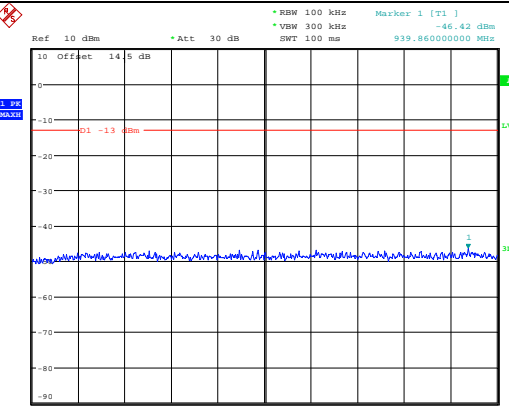

Date: 30.JUN.2023 14:14:38

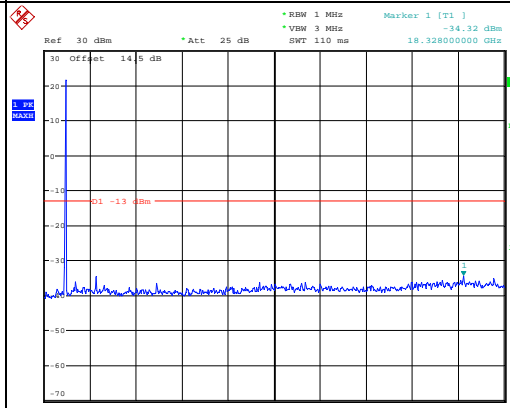

Date: 30.JUN.2023 14:14:51

Highest

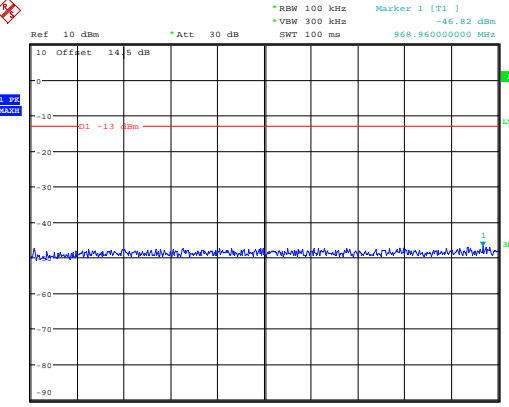

Date: 30.JUN.2023 14:15:10

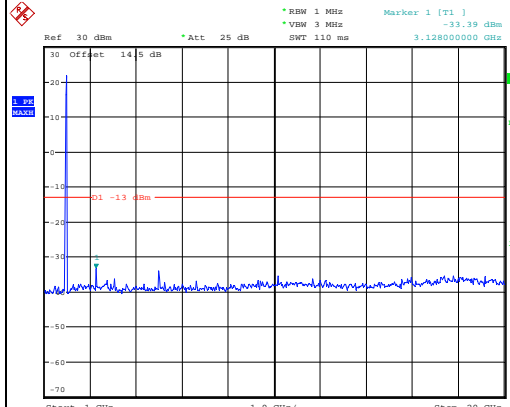

Date: 30.JUN.2023 14:15:23

Spurious Emissions at Antenna Terminal

Channel	10 MHz Bandwidth QPSK	
Lowest	<p>Ref 10 dBm Att 30 dB RBW 100 kHz Marker 1 [T1] -46.88 dBm VSW 300 kHz SWT 100 ms 982.548000000 MHz</p> <p>Date: 30.JUN.2023 14:16:18</p>	<p>Ref 30 dBm Att 25 dB RBW 1 MHz Marker 1 [T1] -32.71 dBm VSW 3 MHz SWT 110 ms 3.128000000 GHz</p> <p>Date: 30.JUN.2023 14:16:31</p>
Middle	<p>Ref 10 dBm Att 30 dB RBW 100 kHz Marker 1 [T1] -45.70 dBm VSW 300 kHz SWT 100 ms 926.280000000 MHz</p> <p>Date: 30.JUN.2023 14:16:47</p>	<p>Ref 30 dBm Att 25 dB RBW 1 MHz Marker 1 [T1] -32.15 dBm VSW 3 MHz SWT 110 ms 3.128000000 GHz</p> <p>Date: 30.JUN.2023 14:17:00</p>
Highest	<p>Ref 10 dBm Att 30 dB RBW 100 kHz Marker 1 [T1] -45.70 dBm VSW 300 kHz SWT 100 ms 990.300000000 MHz</p> <p>Date: 30.JUN.2023 14:17:19</p>	<p>Ref 30 dBm Att 25 dB RBW 1 MHz Marker 1 [T1] -33.04 dBm VSW 3 MHz SWT 110 ms 3.128000000 GHz</p> <p>Date: 30.JUN.2023 14:17:31</p>

Spurious Emissions at Antenna Terminal

Channel	15MHz Bandwidth QPSK	
Lowest	<p>Ref 10 dBm Att 30 dB RBW 100 kHz Marker 1 [T1] -46.51 dBm VSW 300 kHz SWT 100 ms 932.100000000 MHz</p> <p>Date: 30.JUN.2023 14:30:09</p>	<p>Ref 30 dBm Att 25 dB RBW 1 MHz Marker 1 [T1] -34.48 dBm VSW 3 MHz SWT 110 ms 17.340000000 GHz</p> <p>Date: 30.JUN.2023 14:30:22</p>
Middle	<p>Ref 10 dBm Att 30 dB RBW 100 kHz Marker 1 [T1] -46.16 dBm VSW 300 kHz SWT 100 ms 268.620000000 MHz</p> <p>Date: 30.JUN.2023 14:30:38</p>	<p>Ref 30 dBm Att 25 dB RBW 1 MHz Marker 1 [T1] -35.28 dBm VSW 3 MHz SWT 110 ms 18.176000000 GHz</p> <p>Date: 30.JUN.2023 14:30:51</p>
Highest	<p>Ref 10 dBm Att 30 dB RBW 100 kHz Marker 1 [T1] -45.98 dBm VSW 300 kHz SWT 100 ms 191.020000000 MHz</p> <p>Date: 30.JUN.2023 14:31:06</p>	<p>Ref 30 dBm Att 25 dB RBW 1 MHz Marker 1 [T1] -33.17 dBm VSW 3 MHz SWT 110 ms 3.128000000 GHz</p> <p>Date: 30.JUN.2023 14:31:19</p>

Spurious Emissions at Antenna Terminal

Channel	20MHz Bandwidth QPSK	
Lowest		
Middle		
Highest		

Out of band emission, Band Edge

Mode	Lowest	Highest
<p>QPSK 1.4MHz</p>		
<p>QPSK 3MHz</p>		

Out of band emission, Band Edge

Mode	Lowest	Highest
QPSK 5MHz	<p>Ref 30 dBm Att 25 dB RBW 100 kHz Marker 1 [T1] -24.03 dBm VSW 300 kHz SWT 35 ms Center 1.85000000 GHz</p> <p>Offset 14.5 dB</p> <p>Center 1.85 GHz 1 MHz/ Span 10 MHz</p> <p>Date: 30.JUN.2023 10:27:06</p>	<p>Ref 30 dBm Att 25 dB RBW 100 kHz Marker 1 [T1] -19.65 dBm VSW 300 kHz SWT 35 ms Center 1.91500000 GHz</p> <p>Offset 14.5 dB</p> <p>Center 1.915 GHz 1 MHz/ Span 10 MHz</p> <p>Date: 30.JUN.2023 10:27:24</p>
QPSK 10MHz	<p>Ref 30 dBm Att 25 dB RBW 100 kHz Marker 1 [T1] -30.10 dBm VSW 300 kHz SWT 35 ms Center 1.84960000 GHz</p> <p>Offset 14.5 dB</p> <p>Center 1.85 GHz 2 MHz/ Span 20 MHz</p> <p>Date: 30.JUN.2023 10:28:07</p>	<p>Ref 30 dBm Att 25 dB RBW 100 kHz Marker 1 [T1] -25.59 dBm VSW 300 kHz SWT 35 ms Center 1.91500000 GHz</p> <p>Offset 14.5 dB</p> <p>Center 1.915 GHz 2 MHz/ Span 20 MHz</p> <p>Date: 30.JUN.2023 10:28:27</p>