



中认信通

CHINA CERTIFICATION ICT CO., LTD (DONGGUAN)



TEST REPORT

Applicant: MAXWEST COMMUNICATION LIMITED

Address: FLAT/RM 707 7/F, FORTRESS TOWER 250 KING'S ROAD,NORTH
POINT, HONG KONG

FCC ID: 2ASP8ASTROA64

Product Name: Phone

Standard(s): 47 CFR Part 15, Subpart C(15.247)
ANSI C63.10-2013
KDB 558074 D01 15.247 Meas Guidance v05r02

The above device has been tested and found compliant with the requirement of the relative standards by China Certification ICT Co., Ltd (Dongguan)

Report Number: CR231169741-00C

Date Of Issue: 2023/12/8

Reviewed By: Calvin Chen

Calvin Chen

Title: RF Engineer

Reviewed By: Sun Zhong

Sun Zhong

Title: Manager

Test Laboratory: China Certification ICT Co., Ltd (Dongguan)

No. 113, Pingkang Road, Dalang Town, Dongguan,

Guangdong, China

Tel: +86-769-82016888

Test Facility

The Test site used by China Certification ICT Co., Ltd (Dongguan) to collect test data is located on the No. 113, Pingkang Road, Dalang Town, Dongguan, Guangdong, China.

The lab has been recognized as the FCC accredited lab under the KDB 974614 D01 and is listed in the FCC Public Access Link (PAL) database, FCC Registration No. : 442868, the FCC Designation No. : CN1314.

The lab has been recognized by Innovation, Science and Economic Development Canada to test to Canadian radio equipment requirements, the CAB identifier: CN0123.

Declarations

China Certification ICT Co., Ltd (Dongguan) is not responsible for the authenticity of any test data provided by the applicant. Data included from the applicant that may affect test results are marked with a triangle symbol “▲”. Customer model name, addresses, names, trademarks etc. are not considered data.

Unless otherwise stated the results shown in this test report refer only to the sample(s) tested.

This report cannot be reproduced except in full, without prior written approval of the Company.

This report is valid only with a valid digital signature. The digital signature may be available only under the Adobe software above version 7.0.

This report may contain data that are not covered by the accreditation scope and shall be marked with an asterisk “★”.

CONTENTS

DOCUMENT REVISION HISTORY	5
1. GENERAL INFORMATION	6
1.1 PRODUCT DESCRIPTION FOR EQUIPMENT UNDER TEST (EUT)	6
1.2 DESCRIPTION OF TEST CONFIGURATION.....	8
1.2.1 EUT Operation Condition:.....	8
1.2.2 Support Equipment List and Details	8
1.2.3 Support Cable List and Details	8
1.2.4 Block Diagram of Test Setup.....	9
1.3 Measurement Uncertainty	10
2. SUMMARY OF TEST RESULTS	11
3. REQUIREMENTS AND TEST PROCEDURES	12
3.1 AC LINE CONDUCTED EMISSIONS.....	12
3.1.1 Applicable Standard.....	12
3.1.2 EUT Setup.....	13
3.1.3 EMI Test Receiver Setup	13
3.1.4 Test Procedure	14
3.1.5 Corrected Amplitude & Margin Calculation.....	14
3.2 RADIATION SPURIOUS EMISSIONS	15
3.2.1 Applicable Standard.....	15
3.2.2 EUT Setup.....	15
3.2.3 EMI Test Receiver & Spectrum Analyzer Setup	16
3.2.4 Test Procedure	17
3.2.5 Corrected Amplitude & Margin Calculation.....	17
3.3 MINIMUM 6 DB BANDWIDTH:	18
3.3.1 Applicable Standard.....	18
3.3.2 EUT Setup.....	18
3.3.3 Test Procedure	18
3.4 99% OCCUPIED BANDWIDTH:	19
3.4.1 EUT Setup.....	19
3.4.2 Test Procedure	19
3.5 MAXIMUM CONDUCTED OUTPUT POWER:	20
3.5.1 Applicable Standard.....	20
3.5.2 EUT Setup.....	20
3.5.3 Test Procedure	20
3.6 MAXIMUM POWER SPECTRAL DENSITY:	21
3.6.1 Applicable Standard.....	21
3.6.2 EUT Setup.....	21
3.6.3 Test Procedure	21
3.7 100 KHZ BANDWIDTH OF FREQUENCY BAND EDGE:	22
3.7.1 Applicable Standard.....	22
3.7.2 EUT Setup.....	22
3.7.3 Test Procedure	22

3.8 DUTY CYCLE:.....23
 3.8.1 EUT Setup.....23
 3.8.2 Test Procedure23
3.9 ANTENNA REQUIREMENT.....23
 3.9.1 Applicable Standard.....23
 3.9.2 Judgment.....23
4. Test DATA AND RESULTS 24
 4.1 AC LINE CONDUCTED EMISSIONS.....24
 4.2 RADIATION SPURIOUS EMISSIONS27
 4.3 MINIMUM 6 DB EMISSION BANDWIDTH45
 4.4 99% OCCUPIED BANDWIDTH.....50
 4.5 MAXIMUM CONDUCTED OUTPUT POWER.....55
 4.6 MAXIMUM POWER SPECTRAL DENSITY56
 4.7 100 KHZ BANDWIDTH OF FREQUENCY BAND EDGE.....61
 4.8 DUTY CYCLE66
5. EUT PHOTOGRAPHS 68
6. TEST SETUP PHOTOGRAPHS 69

DOCUMENT REVISION HISTORY

Revision Number	Report Number	Description of Revision	Date of Revision
1.0	CR231169741-00C	Original Report	2023/12/8

1. GENERAL INFORMATION

1.1 Product Description for Equipment under Test (EUT)

EUT Name:	Phone
EUT Model:	ASTRO A64
Operation Frequency:	2412-2462 MHz (802.11b/g/n ht20) 2422-2452 MHz (802.11n ht40)
Maximum Peak Output Power (Conducted):	23.02 dBm
Modulation Type:	802.11b: DSSS-DBPSK, DQPSK, CCK 802.11g/n: OFDM-BPSK, QPSK, 16QAM, 64QAM
Rated Input Voltage:	DC 5V from adapter (for charging) or DC 3.8V from battery
Serial Number:	2E5M-1 (for RF Conducted Test) 2E5M-2 (for Emissions Test)
EUT Received Date:	2023/11/25
EUT Received Status:	Good
Note: These two adapters of product were evaluated in the CR231169741-00B report for the AC Line Conducted Emissions Test and Radiation Spurious Emissions Test. The report showed that product equipped with adapter 1 had worse emissions in AC Line Conducted Emissions Test and Radiation Spurious Emissions Test. Therefore, only the test results of product equipped with worst case adapter are reflected in this report.	

Operation Frequency Detail:

For 802.11b/g/n ht20:

Channel	Frequency (MHz)	Channel	Frequency (MHz)
1	2412	7	2442
2	2417	8	2447
3	2422	9	2452
4	2427	10	2457
5	2432	11	2462
6	2437	/	/
Per section 15.31(m), the below frequencies were performed to test:			
Test Channel		Frequency (MHz)	
Lowest		2412	
Middle		2437	
Highest		2462	

For 802.11n ht40:

Channel	Frequency (MHz)	Channel	Frequency (MHz)
3	2422	7	2442
4	2427	8	2447
5	2432	9	2452
6	2437	/	/
Per section 15.31(m), the below frequencies were performed to test:			
Test Channel		Frequency (MHz)	
Lowest		2422	
Middle		2437	
Highest		2452	

Antenna Information Detail ▲:

Antenna Type	Input Impedance (Ohm)	Frequency Range	Antenna Gain
FPC Antenna	50	2400~2500	0.88
		5180~5825	-0.57

The Method of §15.203 Compliance:

- Antenna was permanently attached to the unit.
 Antenna use a unique type of connector to attach to the EUT.
 Unit was professionally installed, and installer shall be responsible for verifying that the correct antenna is employed with the unit.

Accessory Information:

Accessory Description	Manufacturer	Model	Parameters
Adapter 1	MAXWEST	ASTRO A64	Input: 100-240V~50/60Hz 0.2A Output: 5.0V = 1.0A
Adapter 2	MAXWEST	HJ-0501000E1-US	Input: 100-240V~50/60Hz 0.2A Output: 5.0V = 1.0A 5.0W
USB-C Cable	/	/	Unshielded without ferrite, 1.0 Meter

1.2 Description of Test Configuration

1.2.1 EUT Operation Condition:

EUT Operation Mode:	The system was configured for testing in Engineering Mode, which was provided by the manufacturer.			
Equipment Modifications:	No			
EUT Exercise Software:	Engineer Mode			
The software was provided by manufacturer. The maximum power was configured as below, that was provided by the manufacturer▲:				
Mode	Channel	Frequency (MHz)	Data Rate	Power Level Setting
802.11b	Lowest	2412	1Mbps	19.5
	Middle	2437	1Mbps	19.5
	Highest	2462	1Mbps	19.5
802.11g	Lowest	2412	6Mbps	17.5
	Middle	2437	6Mbps	17.5
	Highest	2462	6Mbps	17.5
802.11n ht20	Lowest	2412	MCS0	17.5
	Middle	2437	MCS0	17.5
	Highest	2462	MCS0	17.5
802.11n ht40	Lowest	2422	MCS0	16.5
	Middle	2437	MCS0	16.5
	Highest	2452	MCS0	16.5
Note:				
1. The above are the worst-case data rates, which are determined for each mode based upon investigations by measuring the power and PSD across all data rates, bandwidths, and modulations.				

1.2.2 Support Equipment List and Details

Manufacturer	Description	Model	Serial Number
IPRO	Earphone	Phonenix 5.0s	EP221126001

1.2.3 Support Cable List and Details

Cable Description	Shielding Type	Ferrite Core	Length (m)	From Port	To
Earphone Cable	NO	NO	1.2	EUT	Earphone
USB-C Cable	NO	NO	1.0	Adapter	EUT

1.2.4 Block Diagram of Test Setup

AC Line Conducted Emissions:

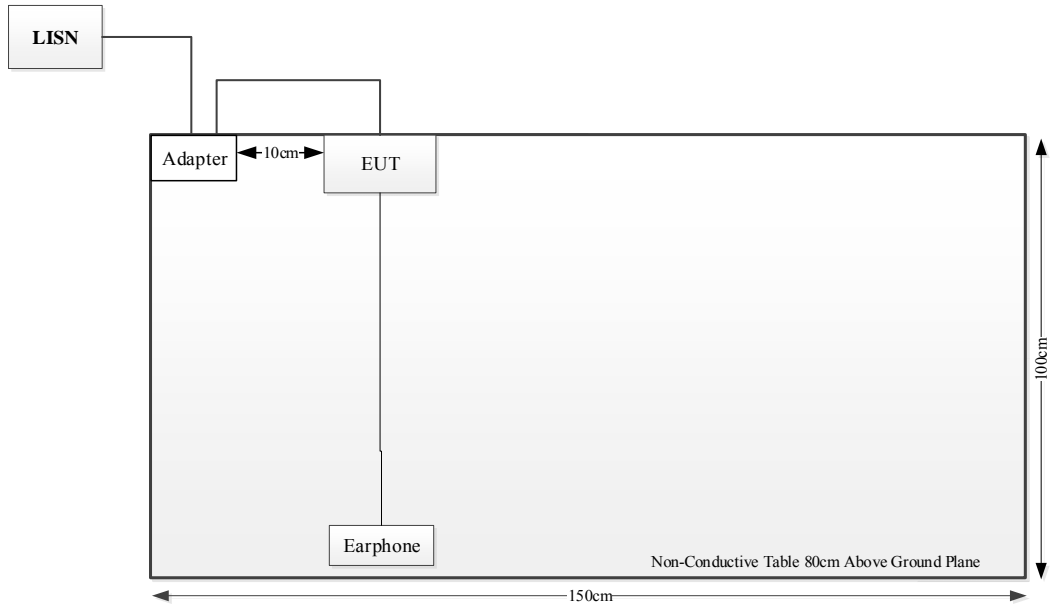

Radiation Spurious Emissions:

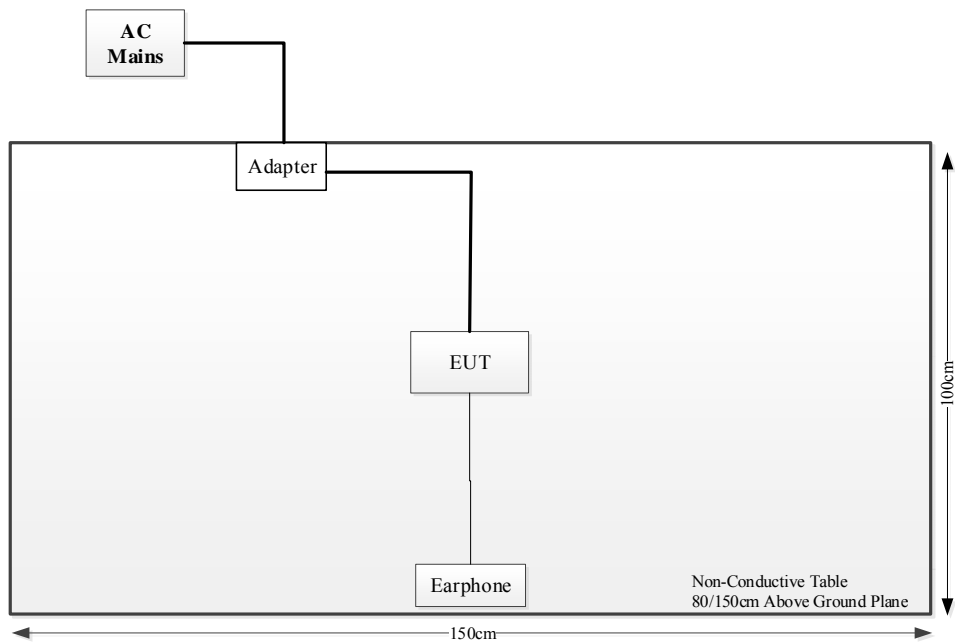

1.3 Measurement Uncertainty

Otherwise required by the applicant or Product Regulations, Decision Rule in this report did not consider the uncertainty. The extended uncertainty given in this report is obtained by combining the standard uncertainty times the coverage factor K with the 95% confidence interval.

Parameter	Measurement Uncertainty
Occupied Channel Bandwidth	±5 %
RF output power, conducted	±0.61dB
Power Spectral Density, conducted	±0.61 dB
Unwanted Emissions, radiated	9kHz~30MHz: 4.12dB, 30M~200MHz: 4.15 dB, 200M~1GHz: 5.61 dB,1G~6GHz: 5.14 dB, 6G~18GHz: 5.93 dB, 18G~26.5G:5.47 dB,26.5G~40G:5.63 dB
Unwanted Emissions, conducted	±1.26 dB
Temperature	±1 °C
Humidity	±5%
DC and low frequency voltages	±0.4%
Duty Cycle	1%
AC Power Lines Conducted Emission	2.8 dB (150 kHz to 30 MHz)

2. SUMMARY OF TEST RESULTS

Standard(s) Section	Test Items	Result
§15.207(a)	AC line conducted emissions	Compliant
§15.205, §15.209, §15.247(d)	Radiated Spurious Emissions	Compliant
§15.247 (a)(2)	Minimum 6 dB Bandwidth	Compliant
§15.247(b)(3)	Maximum Conducted Output Power	Compliant
§15.247(e)	Power Spectral Density	Compliant
§15.247(d)	100 kHz Bandwidth of Frequency Band Edge	Compliant
§15.203	Antenna Requirement	Compliant

3. REQUIREMENTS AND TEST PROCEDURES

3.1 AC Line Conducted Emissions

3.1.1 Applicable Standard

FCC§15.207(a).

(a) Except as shown in paragraphs (b) and (c) of this section, for an intentional radiator that is designed to be connected to the public utility (AC) power line, the radio frequency voltage that is conducted back onto the AC power line on any frequency or frequencies, within the band 150 kHz to 30 MHz, shall not exceed the limits in the following table, as measured using a 50 μ H/50 ohms line impedance stabilization network (LISN). Compliance with the provisions of this paragraph shall be based on the measurement of the radio frequency voltage between each power line and ground at the power terminal. The lower limit applies at the boundary between the frequency ranges.

Frequency of emission (MHz)	Conducted limit (dB μ V)	
	Quasi-peak	Average
0.15-0.5	66 to 56*	56 to 46*
0.5-5	56	46
5-30	60	50

*Decreases with the logarithm of the frequency.

(b) The limit shown in paragraph (a) of this section shall not apply to carrier current systems operating as intentional radiators on frequencies below 30 MHz. In lieu thereof, these carrier current systems shall be subject to the following standards:

(1) For carrier current system containing their fundamental emission within the frequency band 535-1705 kHz and intended to be received using a standard AM broadcast receiver: no limit on conducted emissions.

(2) For all other carrier current systems: 1000 μ V within the frequency band 535-1705 kHz, as measured using a 50 μ H/50 ohms LISN.

(3) Carrier current systems operating below 30 MHz are also subject to the radiated emission limits in §15.205, §15.209, §15.221, §15.223, or §15.227, as appropriate.

(c) Measurements to demonstrate compliance with the conducted limits are not required for devices which only employ battery power for operation and which do not operate from the AC power lines or contain provisions for operation while connected to the AC power lines. Devices that include, or make provisions for, the use of battery chargers which permit operating while charging, AC adapters or battery eliminators or that connect to the AC power lines indirectly, obtaining their power through another device which is connected to the AC power lines, shall be tested to demonstrate compliance with the conducted limits.

3.1.2 EUT Setup

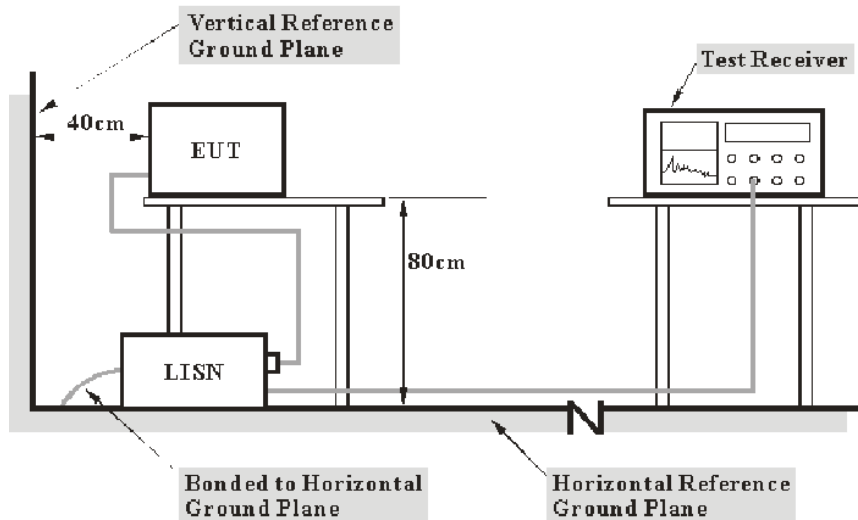

- Note: 1. Support units were connected to second LISN.
 2. Both of LISNs (AMN) 80 cm from EUT and at the least 80 cm from other units and other metal planes support units.

The setup of EUT is according with per ANSI C63.10-2013 measurement procedure. The specification used was with the FCC Part 15.207 limits.

The spacing between the peripherals was 10 cm.

The adapter or EUT was connected to the main LISN with a 120 V/60 Hz AC power source.

3.1.3 EMI Test Receiver Setup

The EMI test receiver was set to investigate the spectrum from 150 kHz to 30 MHz.

During the conducted emission test, the EMI test receiver was set with the following configurations:

Frequency Range	IF B/W
150 kHz – 30 MHz	9 kHz

3.1.4 Test Procedure

The frequency and amplitude of the six highest ac power-line conducted emissions relative to the limit, measured over all the current-carrying conductors of the EUT power cords, and the operating frequency or frequency to which the EUT is tuned (if appropriate), should be reported, unless such emissions are more than 20 dB below the limit. AC power-line conducted emissions measurements are to be separately carried out only on each of the phase (“hot”) line(s) and (if used) on the neutral line(s), but not on the ground [protective earth] line(s). If less than six emission frequencies are within 20 dB of the limit, then the noise level of the measuring instrument at representative frequencies should be reported. The specific conductor of the power-line cord for each of the reported emissions should be identified. Measure the six highest emissions with respect to the limit on each current-carrying conductor of each power cord associated with the EUT (but not the power cords of associated or peripheral equipment that are part of the test configuration). Then, report the six highest emissions with respect to the limit from among all the measurements identifying the frequency and specific current-carrying conductor identified with the emission. The six highest emissions should be reported for each of the current-carrying conductors, or the six highest emissions may be reported over all the current-carrying conductors.

3.1.5 Corrected Amplitude & Margin Calculation

The basic equation is as follows:

Result = Reading + Factor

Factor = attenuation caused by cable loss + voltage division factor of AMN

The “**Margin**” column of the following data tables indicates the degree of compliance within the applicable limit. The equation for margin calculation is as follows:

Margin = Limit – Result

3.2 Radiation Spurious Emissions

3.2.1 Applicable Standard

FCC §15.247 (d)

In any 100 kHz bandwidth outside the frequency band in which the spread spectrum or digitally modulated intentional radiator is operating, the radio frequency power that is produced by the intentional radiator shall be at least 20 dB below that in the 100 kHz bandwidth within the band that contains the highest level of the desired power, based on either an RF conducted or a radiated measurement, provided the transmitter demonstrates compliance with the peak conducted power limits. If the transmitter complies with the conducted power limits based on the use of RMS averaging over a time interval, as permitted under paragraph (b)(3) of this section, the attenuation required under this paragraph shall be 30 dB instead of 20 dB. Attenuation below the general limits specified in §15.209(a) is not required. In addition, radiated emissions which fall in the restricted bands, as defined in §15.205(a), must also comply with the radiated emission limits specified in §15.209(a) (see §15.205(c)).

3.2.2 EUT Setup

9kHz~30MHz:

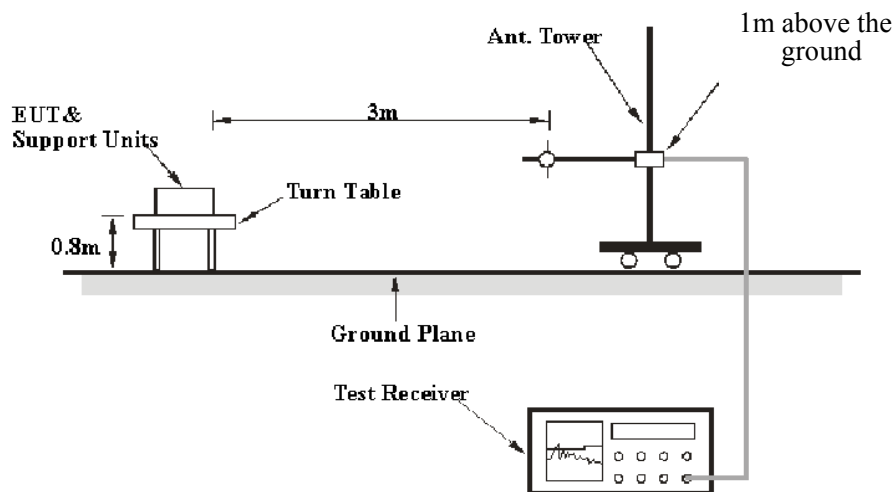

30MHz~1GHz:

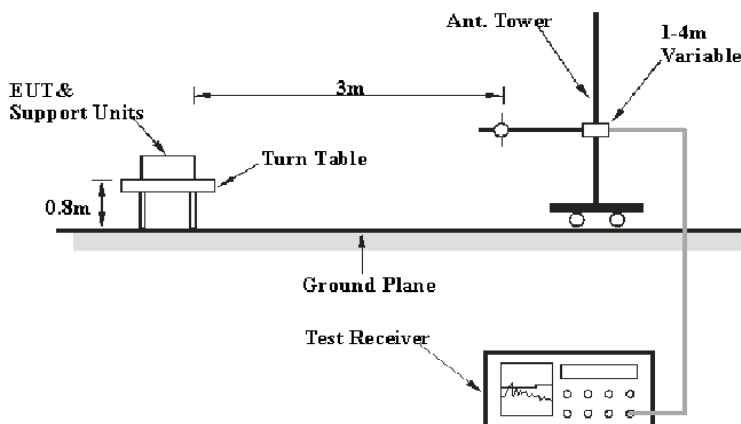

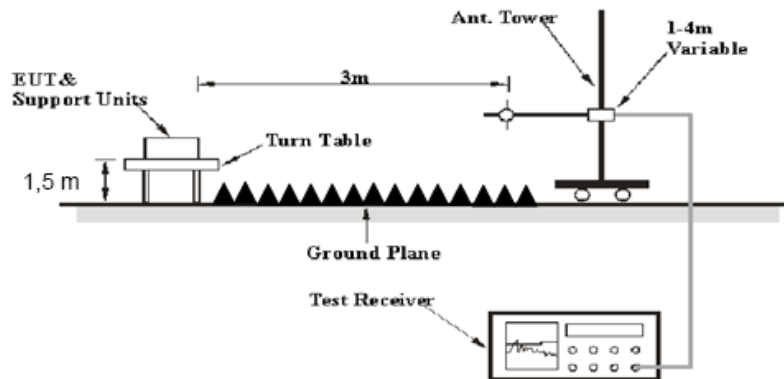
Above 1GHz:

The radiated emissions were performed in the 3 meters distance, using the setup accordance with the ANSI C63.10-2013. The specification used was the FCC 15.209, and FCC 15.247 limits.

The external I/O cables were draped along the test table and formed a bundle 30 to 40 cm long in the middle.

The spacing between the peripherals was 10 cm.

For 9kHz-30MHz test, the lowest height of the magnetic antenna shall be 1 m above the ground and three antenna orientations (parallel, perpendicular, and ground-parallel) shall be measured.

3.2.3 EMI Test Receiver & Spectrum Analyzer Setup

The system was investigated from 9kHz to 25 GHz.

During the radiated emission test, the EMI test receiver & Spectrum Analyzer Setup were set with the following configurations:

9kHz-1000MHz:

Frequency Range	RBW	Video B/W	IF B/W	Measurement
9 kHz – 150 kHz	300 Hz	1 kHz	200 Hz	QP/AV
150 kHz – 30 MHz	10 kHz	30 kHz	9 kHz	QP/AV
30 MHz – 1000 MHz	100 kHz	300 kHz	---	PK
	---	---	120 kHz	QP

1GHz- 25GHz:

Measurement	Duty cycle	RBW	Video B/W
PK	Any	1MHz	3 MHz
AV	>98%	1MHz	10 Hz
	<98%	1MHz	1/T

Note: T is minimum transmission duration

If the maximized peak measured value complies with under the QP/Average limit more than 6dB, then it is unnecessary to perform an QP/Average measurement.

3.2.4 Test Procedure

Maximizing procedure was performed on the highest emissions to ensure that the EUT complied with all installation combinations.

Data was recorded in Quasi-peak detection mode for frequency range of 30 MHz-1 GHz, peak and Average detection modes for frequencies above 1 GHz.

All emissions under the average limit and under the noise floor have not recorded in the report.

3.2.5 Corrected Amplitude & Margin Calculation

The basic equation is as follows:

Result = Reading + Factor

Factor = Antenna Factor + Cable Loss- Amplifier Gain

The “**Margin**” column of the following data tables indicates the degree of compliance within the applicable limit. The equation for margin calculation is as follows:

Margin = Limit – Result

3.3 Minimum 6 dB Bandwidth:

3.3.1 Applicable Standard

FCC §15.247 (a)(2)

Systems using digital modulation techniques may operate in the 902-928 MHz, 2400-2483.5 MHz, and 5725-5850 MHz bands. The minimum 6 dB bandwidth shall be at least 500 kHz.

3.3.2 EUT Setup

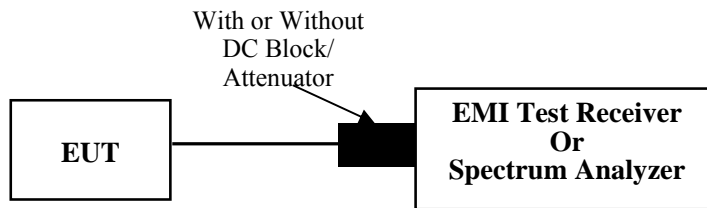

3.3.3 Test Procedure

According to ANSI C63.10-2013 Section 11.8

- a) Set RBW = 100 kHz.
- b) Set the video bandwidth (VBW) $\geq 3 \times$ RBW.
- c) Detector = Peak.
- d) Trace mode = max hold.
- e) Sweep = auto couple.
- f) Allow the trace to stabilize.
- g) Measure the maximum width of the emission that is constrained by the frequencies associated with the two outermost amplitude points (upper and lower frequencies) that are attenuated by 6 dB relative to the maximum level measured in the fundamental emission.

3.4 99% Occupied Bandwidth:

3.4.1 EUT Setup

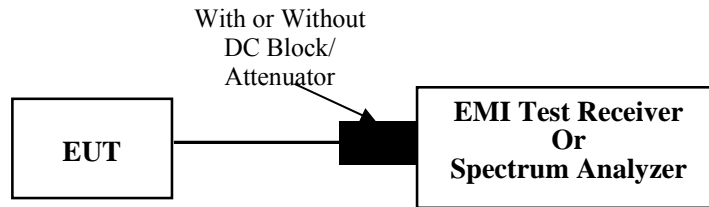

3.4.2 Test Procedure

According to ANSI C63.10-2013 Section 6.9.3

The occupied bandwidth is the frequency bandwidth such that, below its lower and above its upper frequency limits, the mean powers are each equal to 0.5% of the total mean power of the given emission. The following procedure shall be used for measuring 99% power bandwidth:

- a) The instrument center frequency is set to the nominal EUT channel center frequency. The frequency span for the spectrum analyzer shall be between 1.5 times and 5.0 times the OBW.
- b) The nominal IF filter bandwidth (3 dB RBW) shall be in the range of 1% to 5% of the OBW, and VBW shall be approximately three times the RBW, unless otherwise specified by the applicable requirement.
- c) Set the reference level of the instrument as required, keeping the signal from exceeding the maximum input mixer level for linear operation. In general, the peak of the spectral envelope shall be more than $[10 \log (OBW/RBW)]$ below the reference level. Specific guidance is given in 4.1.5.2.
- d) Step a) through step c) might require iteration to adjust within the specified range.
- e) Video averaging is not permitted. Where practical, a sample detection and single sweep mode shall be used. Otherwise, peak detection and max hold mode (until the trace stabilizes) shall be used.
- f) Use the 99% power bandwidth function of the instrument (if available) and report the measured bandwidth.
- g) If the instrument does not have a 99% power bandwidth function, then the trace data points are recovered and directly summed in linear power terms. The recovered amplitude data points, beginning at the lowest frequency, are placed in a running sum until 0.5% of the total is reached; that frequency is recorded as the lower frequency. The process is repeated until 99.5% of the total is reached; that frequency is recorded as the upper frequency. The 99% power bandwidth is the difference between these two frequencies.
- h) The occupied bandwidth shall be reported by providing plot(s) of the measuring instrument display; the plot axes and the scale units per division shall be clearly labeled. Tabular data may be reported in addition to the plot(s).

3.5 Maximum Conducted Output Power:

3.5.1 Applicable Standard

FCC §15.247 (b)(3)

For systems using digital modulation in the 902-928 MHz, 2400-2483.5 MHz, and 5725-5850 MHz bands: 1 Watt. As an alternative to a peak power measurement, compliance with the one Watt limit can be based on a measurement of the maximum conducted output power. Maximum Conducted Output Power is defined as the total transmit power delivered to all antennas and antenna elements averaged across all symbols in the signaling alphabet when the transmitter is operating at its maximum power control level. Power must be summed across all antennas and antenna elements. The average must not include any time intervals during which the transmitter is off or is transmitting at a reduced power level. If multiple modes of operation are possible (e.g., alternative modulation methods), the maximum conducted output power is the highest total transmit power occurring in any mode.

3.5.2 EUT Setup

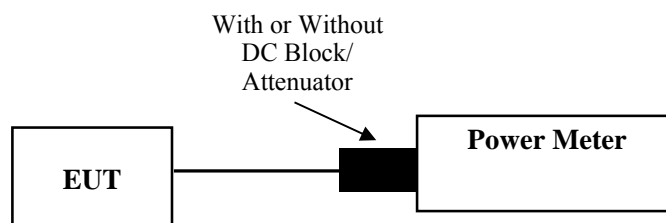

3.5.3 Test Procedure

According to ANSI C63.10-2013 Section 11.9.2.3.2

Method AVGPM-G is a measurement using a gated RF average power meter.

Alternatively, measurements may be performed using a wideband gated RF power meter provided that the gate parameters are adjusted such that the power is measured only when the EUT is transmitting at its maximum power control level. Because the measurement is made only during the ON time of the transmitter, no duty cycle correction factor is required.

According to ANSI C63.10-2013 Section 11.9.1.3

The maximum peak conducted output power may be measured using a broadband peak RF power meter. The power meter shall have a video bandwidth that is greater than or equal to the DTS bandwidth and shall use a fast-responding diode detector.

- a) Set the EUT in transmitting mode.
- b) Remove the antenna from the EUT and then connect a low loss RF cable from the antenna port to test equipment.
- c) Add a correction factor to the display.
- d) Set the power meter to test peak output power, record the result.

3.6 Maximum Power Spectral Density:

3.6.1 Applicable Standard

FCC §15.247 (e)

For digitally modulated systems, the power spectral density conducted from the intentional radiator to the antenna shall not be greater than 8 dBm in any 3 kHz band during any time interval of continuous transmission. This power spectral density shall be determined in accordance with the provisions of paragraph (b) of this section. The same method of determining the conducted output power shall be used to determine the power spectral density.

3.6.2 EUT Setup

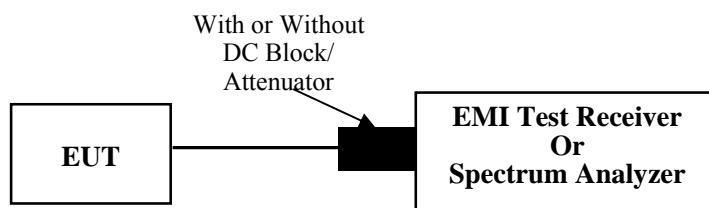

3.6.3 Test Procedure

According to ANSI C63.10-2013 Section 11.10.2

- a) Set analyzer center frequency to DTS channel center frequency.
- b) Set the span to 1.5 times the DTS bandwidth.
- c) Set the RBW to $3 \text{ kHz} \leq \text{RBW} \leq 100 \text{ kHz}$.
- d) Set the VBW $\geq [3 \cdot \text{RBW}]$.
- e) Detector = peak.
- f) Sweep time = auto couple.
- g) Trace mode = max hold.
- h) Allow trace to fully stabilize.
- i) Use the peak marker function to determine the maximum amplitude level within the RBW.
- j) If measured value exceeds requirement, then reduce RBW (but no less than 3 kHz) and repeat.

3.7 100 kHz Bandwidth of Frequency Band Edge:

3.7.1 Applicable Standard

FCC §15.247 (d);

In any 100 kHz bandwidth outside the frequency band in which the spread spectrum or digitally modulated intentional radiator is operating, the radio frequency power that is produced by the intentional radiator shall be at least 20 dB below that in the 100 kHz bandwidth within the band that contains the highest level of the desired power, based on either an RF conducted or a radiated measurement, provided the transmitter demonstrates compliance with the peak conducted power limits. If the transmitter complies with the conducted power limits based on the use of RMS averaging over a time interval, as permitted under paragraph (b)(3) of this section, the attenuation required under this paragraph shall be 30 dB instead of 20 dB. Attenuation below the general limits specified in §15.209(a) is not required. In addition, radiated emissions which fall in the restricted bands, as defined in §15.205(a), must also comply with the radiated emission limits specified in §15.209(a) (see §15.205(c)).

3.7.2 EUT Setup

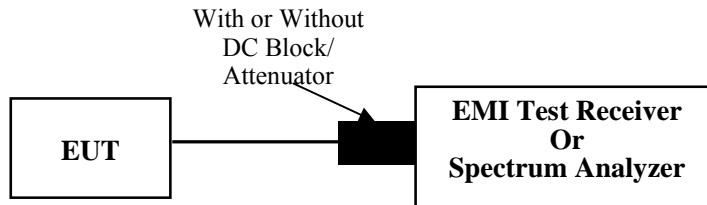

3.7.3 Test Procedure

According to ANSI C63.10-2013 Section 11.11

- a) Set the center frequency and span to encompass frequency range to be measured.
- b) Set the RBW = 100 kHz.
- c) Set the VBW $\geq [3 \times \text{RBW}]$.
- d) Detector = peak.
- e) Sweep time = auto couple.
- f) Trace mode = max hold.
- g) Allow trace to fully stabilize.
- h) Use the peak marker function to determine the maximum amplitude level.

Ensure that the amplitude of all unwanted emissions outside of the authorized frequency band (excluding restricted frequency bands) is attenuated by at least the minimum requirements specified in 11.11. Report the three highest emissions relative to the limit.

3.8 Duty Cycle:

3.8.1 EUT Setup

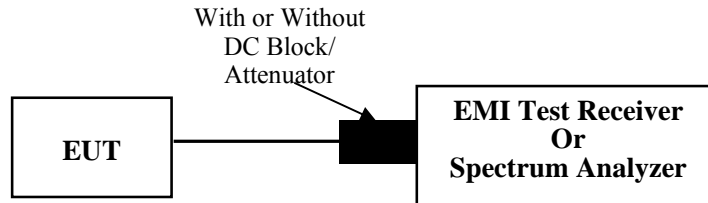

3.8.2 Test Procedure

According to ANSI C63.10-2013 Section 11.6

The zero-span mode on a spectrum analyzer or EMI receiver if the response time and spacing between bins on the sweep are sufficient to permit accurate measurements of the ON and OFF times of the transmitted signal:

- 1) Set the center frequency of the instrument to the center frequency of the transmission.
- 2) Set $RBW \geq OBW$ if possible; otherwise, set RBW to the largest available value.
- 3) Set $VBW \geq RBW$. Set detector = peak or average.
- 4) The zero-span measurement method shall not be used unless both RBW and VBW are $> 50/T$ and the number of sweep points across duration T exceeds 100. (For example, if VBW and/or RBW are limited to 3 MHz, then the zero-span method of measuring the duty cycle shall not be used if $T \leq 16.7 \mu s$.)

3.9 Antenna Requirement

3.9.1 Applicable Standard

FCC §15.203

An intentional radiator shall be designed to ensure that no antenna other than that furnished by the responsible party shall be used with the device. The use of a permanently attached antenna or of an antenna that uses a unique coupling to the intentional radiator shall be considered sufficient to comply with the provisions of this section. The manufacturer may design the unit so that a broken antenna can be replaced by the user, but the use of a standard antenna jack or electrical connector is prohibited. This requirement does not apply to carrier current devices or to devices operated under the provisions of §§15.211, 15.213, 15.217, 15.219, 15.221, or §15.236. Further, this requirement does not apply to intentional radiators that must be professionally installed, such as perimeter protection systems and some field disturbance sensors, or to other intentional radiators which, in accordance with §15.31(d), must be measured at the installation site. However, the installer shall be responsible for ensuring that the proper antenna is employed so that the limits in this part are not exceeded.

3.9.2 Judgment

Compliant. Please refer to the Antenna Information detail in Section 1.

4. Test DATA AND RESULTS

4.1 AC Line Conducted Emissions

Serial Number:	2E5M-2	Test Date:	2023/12/07
Test Site:	CE	Test Mode:	Transmitting (Tested at maximum output power mode: 802.11g, Lowest channel)
Tester:	David Huang	Test Result:	Pass

Environmental Conditions:

Temperature: (°C)	25.9	Relative Humidity: (%)	42	ATM Pressure: (kPa)	101.5
----------------------	------	---------------------------	----	------------------------	-------

Test Equipment List and Details:

Manufacturer	Description	Model	Serial Number	Calibration Date	Calibration Due Date
R&S	LISN	ENV216	101134	2023/03/31	2024/03/30
R&S	EMI Test Receiver	ESR3	102726	2023/03/31	2024/03/30
MICRO-COAX	Coaxial Cable	UTIFLEX	C-0200-01	2023/08/06	2024/08/05
Audix	Test Software	E3	190306 (V9)	N/A	N/A

* Statement of Traceability: China Certification ICT Co., Ltd (Dongguan) attests that all calibrations have been performed, traceable to National Primary Standards and International System of Units (SI).

Test Data:

(Adapter 1 Power Supply mode was the worst)

Please refer to the below table and plots.

Project No.: CR231169741-RF
 Tester: David Huang
 Port: Line
 Note: Transmitting(2.4G WIFI Adapter1)

Date: 2023-12-07

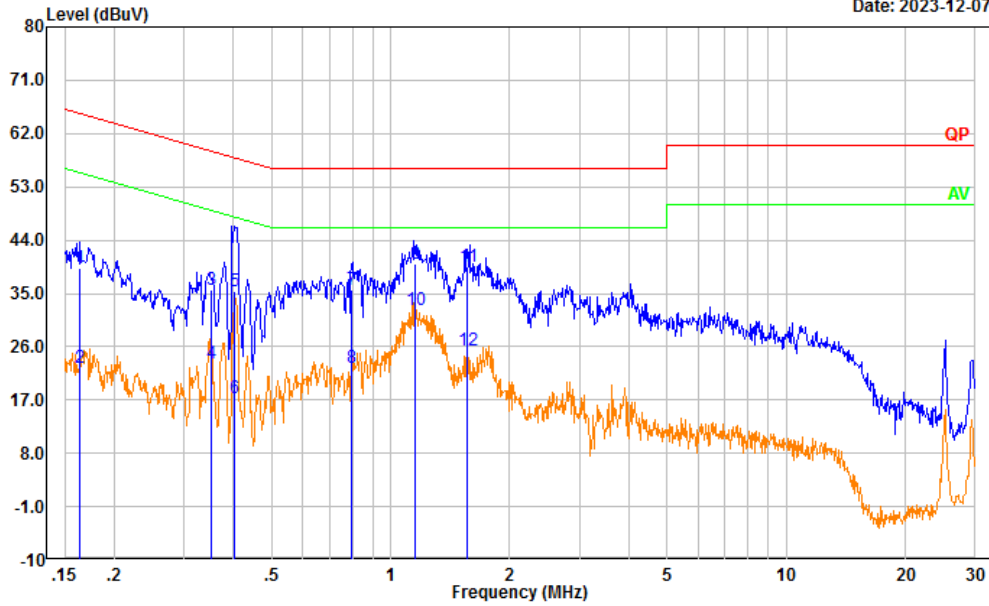

No.	Frequency (MHz)	Reading (dBμV)	Factor (dB)	Result (dBμV)	Limit (dBμV)	Margin (dB)	Detector
1	0.164	29.71	9.61	39.32	65.27	25.95	QP
2	0.164	12.88	9.61	22.49	55.27	32.78	Average
3	0.353	25.96	9.61	35.57	58.90	23.33	QP
4	0.353	13.65	9.61	23.26	48.90	25.64	Average
5	0.403	25.69	9.61	35.30	57.80	22.50	QP
6	0.403	7.80	9.61	17.41	47.80	30.39	Average
7	0.796	25.93	9.62	35.55	56.00	20.45	QP
8	0.796	12.81	9.62	22.43	46.00	23.57	Average
9	1.156	30.33	9.62	39.95	56.00	16.05	QP
10	1.156	22.69	9.62	32.31	46.00	13.69	Average
11	1.565	30.00	9.63	39.63	56.00	16.37	QP
12	1.565	15.83	9.63	25.46	46.00	20.54	Average

Project No.: CR231169741-RF
 Tester: David Huang
 Port: neutral
 Note: Transmitting(2.4G WIFI Adapter1)

Date: 2023-12-07

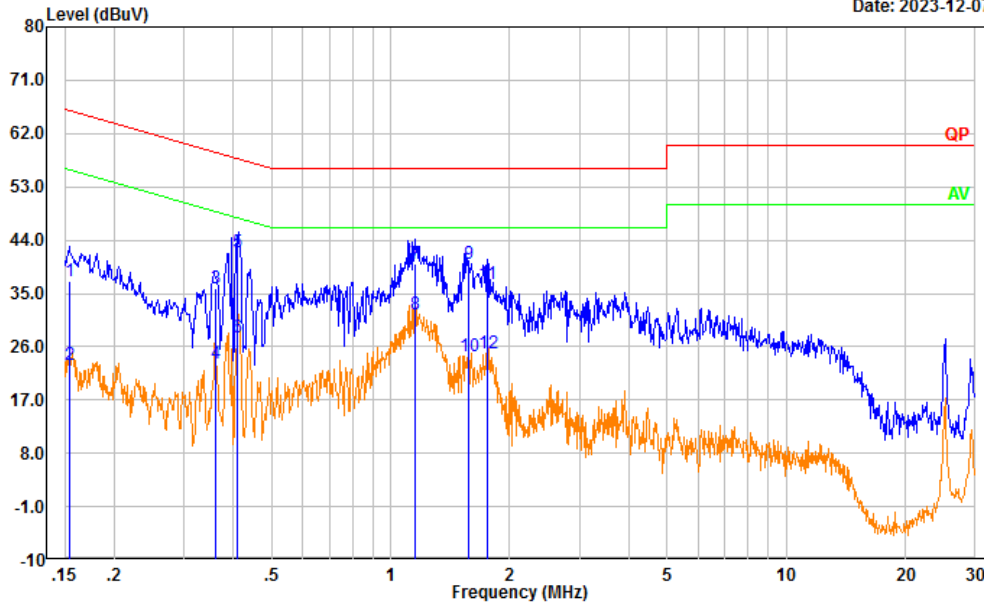

No.	Frequency (MHz)	Reading (dBμV)	Factor (dB)	Result (dBμV)	Limit (dBμV)	Margin (dB)	Detector
1	0.155	27.44	9.61	37.05	65.74	28.69	QP
2	0.155	13.28	9.61	22.89	55.74	32.85	Average
3	0.361	26.17	9.61	35.78	58.70	22.92	QP
4	0.361	13.57	9.61	23.18	48.70	25.52	Average
5	0.411	32.29	9.61	41.90	57.63	15.73	QP
6	0.411	17.87	9.61	27.48	47.63	20.15	Average
7	1.157	30.40	9.62	40.02	56.00	15.98	QP
8	1.157	21.83	9.62	31.45	46.00	14.55	Average
9	1.578	30.44	9.63	40.07	56.00	15.93	QP
10	1.578	14.65	9.63	24.28	46.00	21.72	Average
11	1.758	26.90	9.63	36.53	56.00	19.47	QP
12	1.758	15.29	9.63	24.92	46.00	21.08	Average

4.2 Radiation Spurious Emissions

Serial Number:	2E5M -2	Test Date:	2023/12/03~2023/12/05
Test Site:	966-2, 966-1	Test Mode:	Transmitting
Tester:	Carl Xue, Tao Zhu	Test Result:	Pass

Environmental Conditions:

Temperature: (°C)	25.1~25.6	Relative Humidity: (%)	41~53	ATM Pressure: (kPa)	101.4~101.6
----------------------	-----------	---------------------------	-------	------------------------	-------------

Test Equipment List and Details:

Manufacturer	Description	Model	Serial Number	Calibration Date	Calibration Due Date
Radiation Spurious Emissions Below 1GHz					
Sunol Sciences	Antenna	JB6	A082520-6	2023/09/18	2026/09/17
BACL	Loop Antenna	1313-1P	3092721	2023/10/20	2026/10/19
R&S	EMI Test Receiver	ESR3	102724	2023/03/31	2024/03/30
TIMES MICROWAVE	Coaxial Cable	LMR-600- UltraFlex	C-0470-02	2023/07/16	2024/07/15
TIMES MICROWAVE	Coaxial Cable	LMR-600- UltraFlex	C-0780-01	2023/07/16	2024/07/15
Sonoma	Amplifier	310N	186165	2023/07/16	2024/07/15
Audix	Test Software	E3	201021 (V9)	N/A	N/A
Radiation Spurious Emissions Above 1GHz					
AH	Double Ridge Guide Horn Antenna	SAS-571	1394	2023/02/22	2026/02/21
R&S	Spectrum Analyzer	FSV40	101591	2023/03/31	2024/03/30
MICRO-COAX	Coaxial Cable	UFA210A-1-1200- 70U300	217423-008	2023/08/06	2024/08/05
MICRO-COAX	Coaxial Cable	UFA210A-1-2362- 300300	235780-001	2023/08/06	2024/08/05
Mini	Pre-amplifier	ZVA-183-S+	5969001149	2023/11/08	2024/11/07
Audix	Test Software	E3	201021 (V9)	N/A	N/A
PASTERNAK	Horn Antenna	PE9852/2F-20	112002	2021/02/05	2024/02/04
Quinstar	Preamplifier	QLW-18405536-JO	15964001005	2023/09/15	2024/09/14
MICRO-COAX	Coaxial Cable	UFB142A-1-2362- 200200	235772-001	2023/08/06	2024/08/05
E-Microwave	Band Rejection Filter	2400-2483.5MHz	OE01902424	2023/08/06	2024/08/05
Mini Circuits	High Pass Filter	VHF-6010+	31119	2023/08/06	2024/08/05

* Statement of Traceability: China Certification ICT Co., Ltd (Dongguan) attests that all calibrations have been performed, traceable to National Primary Standards and International System of Units (SI).

Test Data:

Please refer to the below table and plots.

After pre-scan in the X, Y and Z axes of orientation, the worst case is below:

1) 9kHz~30MHz

The amplitude of spurious emissions attenuated more than 20 dB below the permissible value is not required to be report.

**2) 30MHz-1GHz (Tested at Maximum Output Power Mode: 802.11g)
(Adapter 1 Power Supply mode was the worst)**

802.11g _ Low Channel _ Horizontal

Project No.: CR231169741-RF
 Tester: Carl Xue
 Polarization: horizontal
 Note: Transmitting(802.11g Low Channel Adapter1)

Date: 2023-12-03

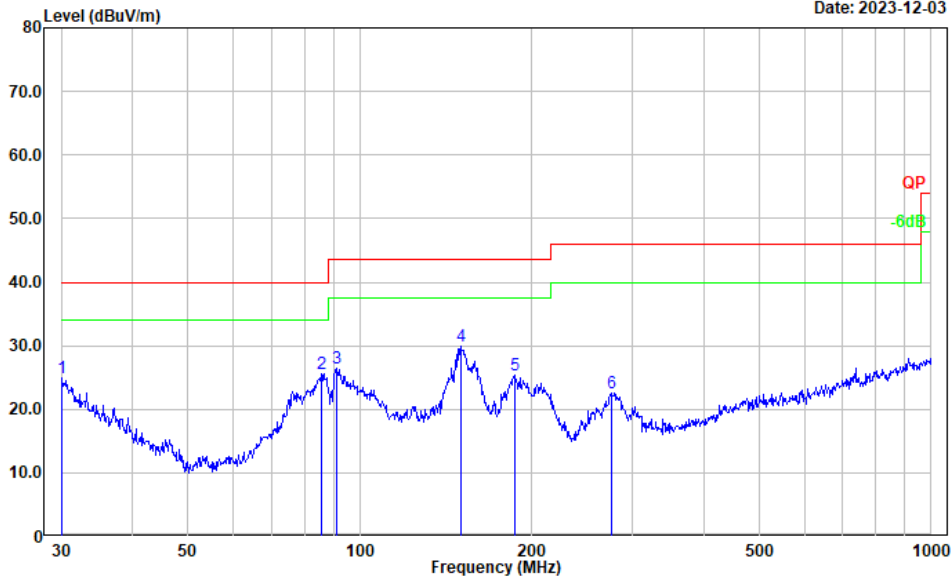

No.	Frequency (MHz)	Reading (dBμV)	Factor (dB/m)	Result (dBμV/m)	Limit (dBμV/m)	Margin (dB)	Detector
1	30.000	28.81	-3.80	25.01	40.00	14.99	Peak
2	85.598	42.79	-17.15	25.64	40.00	14.36	Peak
3	90.855	43.18	-16.72	26.46	43.50	17.04	Peak
4	150.011	41.73	-11.90	29.83	43.50	13.67	Peak
5	186.441	38.98	-13.53	25.45	43.50	18.05	Peak
6	275.157	34.55	-11.94	22.61	46.00	23.39	Peak

802.11g _ Low Channel _ Vertical

Project No.: CR231169741-RF
 Tester: Carl Xue
 Polarization: vertical
 Note: Transmitting(802.11g Low Channel Adapter1)

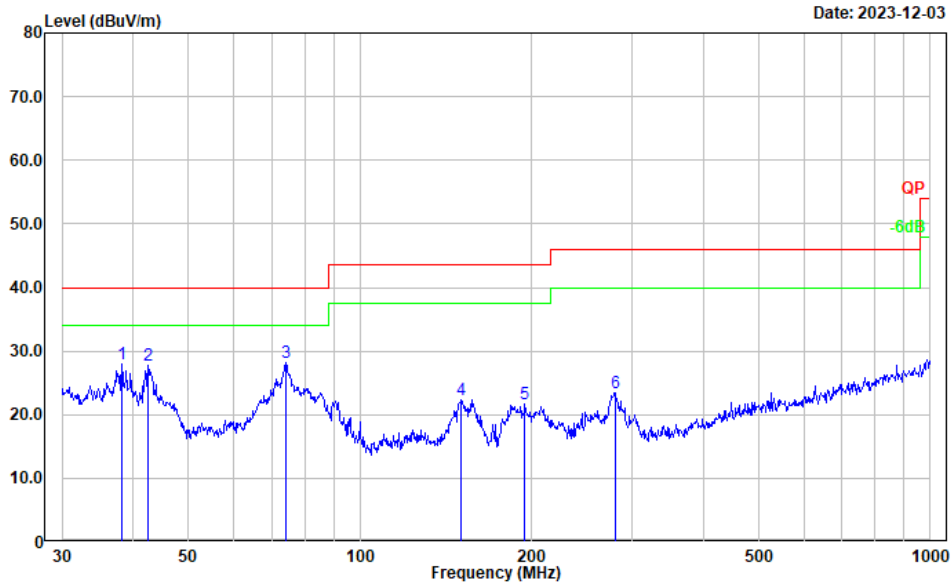

No.	Frequency (MHz)	Reading (dBμV)	Factor (dB/m)	Result (dBμV/m)	Limit (dBμV/m)	Margin (dB)	Detector
1	38.212	37.93	-10.02	27.91	40.00	12.09	Peak
2	42.451	40.56	-12.78	27.78	40.00	12.22	Peak
3	74.135	45.07	-16.96	28.11	40.00	11.89	Peak
4	150.538	34.25	-11.93	22.32	43.50	21.18	Peak
5	194.453	34.61	-12.87	21.74	43.50	21.76	Peak
6	280.024	35.21	-11.70	23.51	46.00	22.49	Peak

802.11g _ Middle Channel _ Horizontal

Project No.: CR231169741-RF
 Tester: Carl Xue
 Polarization: horizontal
 Note: Transmitting(802.11g Middle Channel Adapter1)

Date: 2023-12-03

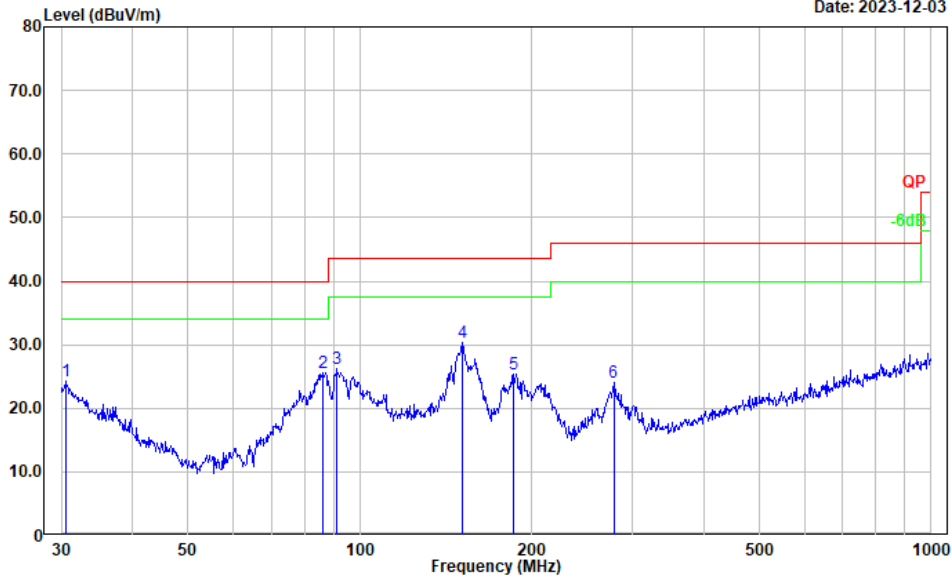

No.	Frequency (MHz)	Reading (dBμV)	Factor (dB/m)	Result (dBμV/m)	Limit (dBμV/m)	Margin (dB)	Detector
1	30.531	28.48	-4.20	24.28	40.00	15.72	Peak
2	86.200	42.75	-17.13	25.62	40.00	14.38	Peak
3	91.175	42.80	-16.64	26.16	43.50	17.34	Peak
4	151.067	42.28	-11.95	30.33	43.50	13.17	Peak
5	185.788	38.90	-13.52	25.38	43.50	18.12	Peak
6	278.067	35.76	-11.80	23.96	46.00	22.04	Peak

802.11g _ Middle Channel _ Vertical

Project No.: CR231169741-RF
 Tester: Carl Xue
 Polarization: vertical
 Note: Transmitting(802.11g Middle Channel Adapter1)

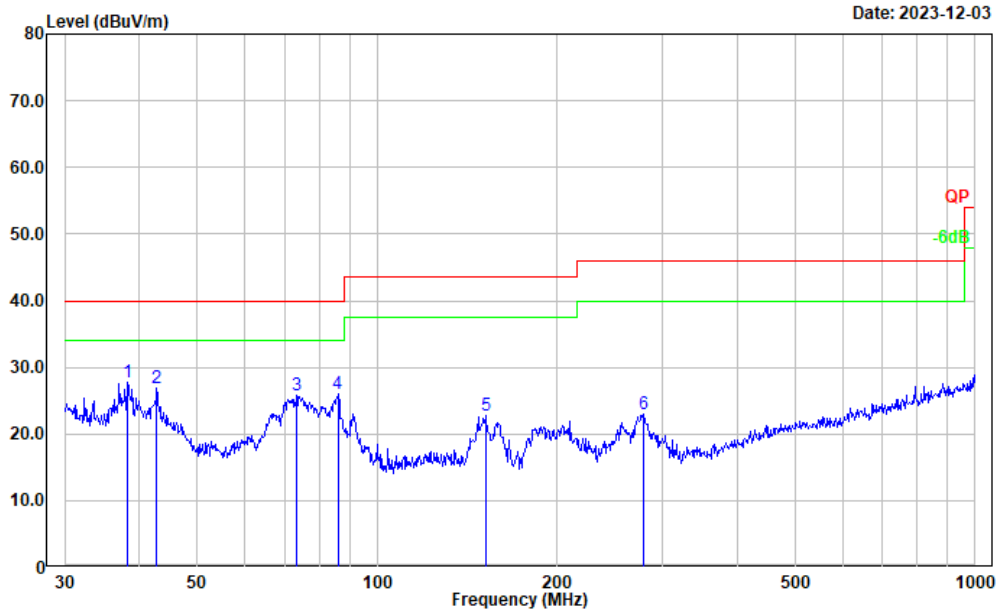

No.	Frequency (MHz)	Reading (dBμV)	Factor (dB/m)	Result (dBμV/m)	Limit (dBμV/m)	Margin (dB)	Detector
1	38.212	37.84	-10.02	27.82	40.00	12.18	Peak
2	42.750	39.88	-12.96	26.92	40.00	13.08	Peak
3	73.359	42.65	-16.86	25.79	40.00	14.21	Peak
4	85.898	43.10	-17.15	25.95	40.00	14.05	Peak
5	151.597	34.77	-11.93	22.84	43.50	20.66	Peak
6	279.044	34.84	-11.75	23.09	46.00	22.91	Peak

802.11g _ High Channel _ Horizontal

Project No.: CR231169741-RF
 Tester: Carl Xue
 Polarization: horizontal
 Note: Transmitting(802.11g High Channel Adapter1)

Date: 2023-12-03

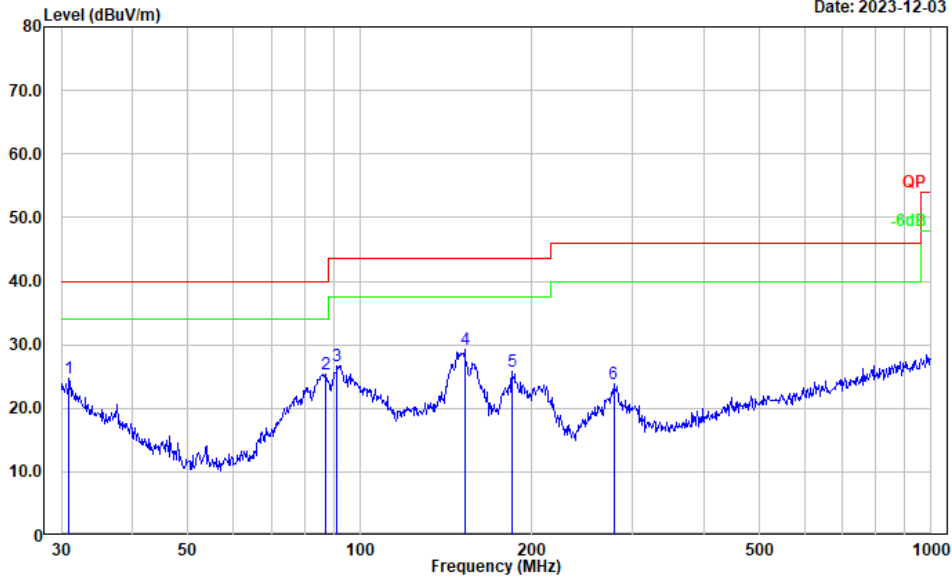

No.	Frequency (MHz)	Reading (dBμV)	Factor (dB/m)	Result (dBμV/m)	Limit (dBμV/m)	Margin (dB)	Detector
1	30.962	29.31	-4.53	24.78	40.00	15.22	Peak
2	87.112	42.46	-17.08	25.38	40.00	14.62	Peak
3	91.175	43.35	-16.64	26.71	43.50	16.79	Peak
4	152.664	41.11	-11.92	29.19	43.50	14.31	Peak
5	184.490	39.22	-13.52	25.70	43.50	17.80	Peak
6	278.067	35.70	-11.80	23.90	46.00	22.10	Peak

802.11g _ High Channel _ Vertical

Project No.: CR231169741-RF
 Tester: Carl Xue
 Polarization: vertical
 Note: Transmitting(802.11g High Channel Adapter1)

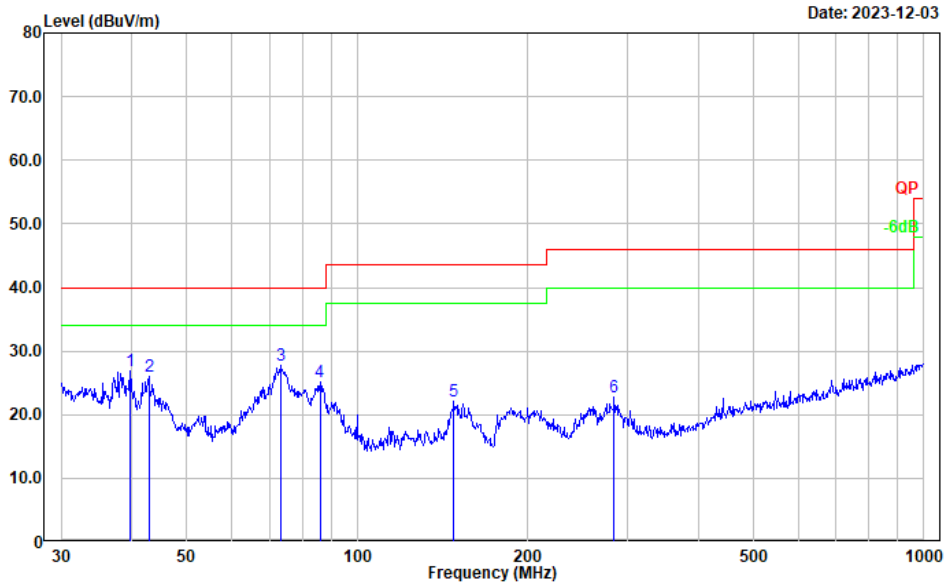

No.	Frequency (MHz)	Reading (dBμV)	Factor (dB/m)	Result (dBμV/m)	Limit (dBμV/m)	Margin (dB)	Detector
1	39.715	38.17	-11.19	26.98	40.00	13.02	Peak
2	42.900	39.12	-13.05	26.07	40.00	13.93	Peak
3	73.103	44.49	-16.82	27.67	40.00	12.33	Peak
4	85.898	42.28	-17.15	25.13	40.00	14.87	Peak
5	147.921	34.04	-11.89	22.15	43.50	21.35	Peak
6	283.979	34.10	-11.43	22.67	46.00	23.33	Peak

3) 1-25GHz:

Note: The EUT equipped with Adapter 1 was performed to 1~25GHz Radiated Emission test.

802.11b Mode:

Frequency (MHz)	Receiver		Polar (H/V)	Factor (dB/m)	Result (dB μ V/m)	Limit (dB μ V/m)	Margin (dB)
	Reading (dB μ V)	Detector					
Low Channel: 2412 MHz							
2390.000	26.63	PK	H	31.71	58.34	74.00	15.66
2390.000	13.74	AV	H	31.71	45.45	54.00	8.55
2390.000	26.55	PK	V	31.71	58.26	74.00	15.74
2390.000	13.62	AV	V	31.71	45.33	54.00	8.67
4824.000	39.63	PK	H	11.26	50.89	74.00	23.11
4824.000	26.63	AV	H	11.26	37.89	54.00	16.11
4824.000	37.84	PK	V	11.26	49.10	74.00	24.90
4824.000	24.63	AV	V	11.26	35.89	54.00	18.11
7236.000	34.56	PK	H	15.24	49.80	74.00	24.20
7236.000	21.19	AV	H	15.24	36.43	54.00	17.57
7236.000	34.52	PK	V	15.24	49.76	74.00	24.24
7236.000	21.16	AV	V	15.24	36.40	54.00	17.60
Middle Channel: 2437 MHz							
4874.000	38.96	PK	H	11.45	50.41	74.00	23.59
4874.000	26.46	AV	H	11.45	37.91	54.00	16.09
4874.000	37.21	PK	V	11.45	48.66	74.00	25.34
4874.000	24.33	AV	V	11.45	35.78	54.00	18.22
7311.000	34.63	PK	H	15.58	50.21	74.00	23.79
7311.000	21.55	AV	H	15.58	37.13	54.00	16.87
7311.000	34.59	PK	V	15.58	50.17	74.00	23.83
7311.000	21.19	AV	V	15.58	36.77	54.00	17.23
High Channel: 2462 MHz							
2483.500	26.53	PK	H	32.19	58.72	74.00	15.28
2483.500	13.62	AV	H	32.19	45.81	54.00	8.19
2483.500	26.46	PK	V	32.19	58.65	74.00	15.35
2483.500	13.55	AV	V	32.19	45.74	54.00	8.26
4924.000	38.63	PK	H	11.67	50.30	74.00	23.70
4924.000	25.47	AV	H	11.67	37.14	54.00	16.86
4924.000	36.86	PK	V	11.67	48.53	74.00	25.47
4924.000	23.55	AV	V	11.67	35.22	54.00	18.78
7386.000	34.63	PK	H	15.63	50.26	74.00	23.74
7386.000	21.28	AV	H	15.63	36.91	54.00	17.09
7386.000	34.39	PK	V	15.63	50.02	74.00	23.98
7386.000	21.25	AV	V	15.63	36.88	54.00	17.12

802.11g Mode:

Frequency (MHz)	Receiver		Polar (H/V)	Factor (dB/m)	Result (dB μ V/m)	Limit (dB μ V/m)	Margin (dB)
	Reading (dB μ V)	Detector					
Low Channel: 2412 MHz							
2390.000	35.47	PK	H	31.71	67.18	74.00	6.82
2390.000	17.63	AV	H	31.71	49.34	54.00	4.66
2390.000	34.69	PK	V	31.71	66.40	74.00	7.60
2390.000	16.52	AV	V	31.71	48.23	54.00	5.77
4824.000	36.46	PK	H	11.26	47.72	74.00	26.28
4824.000	23.41	AV	H	11.26	34.67	54.00	19.33
4824.000	35.36	PK	V	11.26	46.62	74.00	27.38
4824.000	22.47	AV	V	11.26	33.73	54.00	20.27
7236.000	34.58	PK	H	15.24	49.82	74.00	24.18
7236.000	21.50	AV	H	15.24	36.74	54.00	17.26
7236.000	34.36	PK	V	15.24	49.60	74.00	24.40
7236.000	21.41	AV	V	15.24	36.65	54.00	17.35
Middle Channel: 2437 MHz							
4874.000	36.33	PK	H	11.45	47.78	74.00	26.22
4874.000	23.41	AV	H	11.45	34.86	54.00	19.14
4874.000	35.74	PK	V	11.45	47.19	74.00	26.81
4874.000	22.63	AV	V	11.45	34.08	54.00	19.92
7311.000	34.34	PK	H	15.58	49.92	74.00	24.08
7311.000	21.63	AV	H	15.58	37.21	54.00	16.79
7311.000	34.24	PK	V	15.58	49.82	74.00	24.18
7311.000	21.55	AV	V	15.58	37.13	54.00	16.87
High Channel: 2462 MHz							
2483.500	30.90	PK	H	32.19	63.09	74.00	10.91
2483.500	16.11	AV	H	32.19	48.30	54.00	5.70
2483.500	28.66	PK	V	32.19	60.85	74.00	13.15
2483.500	15.41	AV	V	32.19	47.60	54.00	6.40
4924.000	36.39	PK	H	11.67	48.06	74.00	25.94
4924.000	23.42	AV	H	11.67	35.09	54.00	18.91
4924.000	35.20	PK	V	11.67	46.87	74.00	27.13
4924.000	22.48	AV	V	11.67	34.15	54.00	19.85
7386.000	34.39	PK	H	15.63	50.02	74.00	23.98
7386.000	21.41	AV	H	15.63	37.04	54.00	16.96
7386.000	33.96	PK	V	15.63	49.59	74.00	24.41
7386.000	20.88	AV	V	15.63	36.51	54.00	17.49

802.11n ht20 Mode:

Frequency (MHz)	Receiver		Polar (H/V)	Factor (dB/m)	Result (dB μ V/m)	Limit (dB μ V/m)	Margin (dB)
	Reading (dB μ V)	Detector					
Low Channel:				2412	MHz		
2390.000	38.67	PK	H	31.71	70.38	74.00	3.62
2390.000	18.51	AV	H	31.71	50.22	54.00	3.78
2390.000	37.62	PK	V	31.71	69.33	74.00	4.67
2390.000	17.23	AV	V	31.71	48.94	54.00	5.06
4824.000	38.63	PK	H	11.26	49.89	74.00	24.11
4824.000	25.47	AV	H	11.26	36.73	54.00	17.27
4824.000	37.32	PK	V	11.26	48.58	74.00	25.42
4824.000	24.52	AV	V	11.26	35.78	54.00	18.22
7236.000	34.32	PK	H	15.24	49.56	74.00	24.44
7236.000	21.42	AV	H	15.24	36.66	54.00	17.34
7236.000	34.30	PK	V	15.24	49.54	74.00	24.46
7236.000	21.40	AV	V	15.24	36.64	54.00	17.36
Middle Channel:				2437	MHz		
4874.000	38.32	PK	H	11.45	49.77	74.00	24.23
4874.000	25.36	AV	H	11.45	36.81	54.00	17.19
4874.000	37.30	PK	V	11.45	48.75	74.00	25.25
4874.000	24.33	AV	V	11.45	35.78	54.00	18.22
7311.000	34.26	PK	H	15.58	49.84	74.00	24.16
7311.000	21.30	AV	H	15.58	36.88	54.00	17.12
7311.000	34.21	PK	V	15.58	49.79	74.00	24.21
7311.000	21.25	AV	V	15.58	36.83	54.00	17.17
High Channel:				2462	MHz		
2483.500	31.59	PK	H	32.19	63.78	74.00	10.22
2483.500	15.66	AV	H	32.19	47.85	54.00	6.15
2483.500	30.14	PK	V	32.19	62.33	74.00	11.67
2483.500	14.77	AV	V	32.19	46.96	54.00	7.04
4924.000	37.86	PK	H	11.67	49.53	74.00	24.47
4924.000	24.63	AV	H	11.67	36.30	54.00	17.70
4924.000	36.86	PK	V	11.67	48.53	74.00	25.47
4924.000	23.77	AV	V	11.67	35.44	54.00	18.56
7386.000	34.66	PK	H	15.63	50.29	74.00	23.71
7386.000	21.58	AV	H	15.63	37.21	54.00	16.79
7386.000	34.39	PK	V	15.63	50.02	74.00	23.98
7386.000	21.41	AV	V	15.63	37.04	54.00	16.96

802.11n ht40 Mode:

Frequency (MHz)	Receiver		Polar (H/V)	Factor (dB/m)	Result (dB μ V/m)	Limit (dB μ V/m)	Margin (dB)
	Reading (dB μ V)	Detector					
Low Channel:				2422	MHz		
2390.000	39.71	PK	H	31.71	71.42	74.00	2.58
2390.000	21.12	AV	H	31.71	52.83	54.00	1.17
2390.000	37.59	PK	V	31.71	69.30	74.00	4.70
2390.000	19.78	AV	V	31.71	51.49	54.00	2.51
4844.000	34.69	PK	H	11.31	46.00	74.00	28.00
4844.000	21.41	AV	H	11.31	32.72	54.00	21.28
4844.000	34.57	PK	V	11.31	45.88	74.00	28.12
4844.000	21.38	AV	V	11.31	32.69	54.00	21.31
7266.000	34.33	PK	H	15.43	49.76	74.00	24.24
7266.000	21.59	AV	H	15.43	37.02	54.00	16.98
7266.000	34.28	PK	V	15.43	49.71	74.00	24.29
7266.000	21.47	AV	V	15.43	36.90	54.00	17.10
Middle Channel:				2437	MHz		
4874.000	34.52	PK	H	11.45	45.97	74.00	28.03
4874.000	21.47	AV	H	11.45	32.92	54.00	21.08
4874.000	34.46	PK	V	11.45	45.91	74.00	28.09
4874.000	21.26	AV	V	11.45	32.71	54.00	21.29
7311.000	34.50	PK	H	15.58	50.08	74.00	23.92
7311.000	21.36	AV	H	15.58	36.94	54.00	17.06
7311.000	34.33	PK	V	15.58	49.91	74.00	24.09
7311.000	21.28	AV	V	15.58	36.86	54.00	17.14
High Channel:				2452	MHz		
2483.500	33.50	PK	H	32.19	65.69	74.00	8.31
2483.500	17.29	AV	H	32.19	49.48	54.00	4.52
2483.500	31.41	PK	V	32.19	63.60	74.00	10.40
2483.500	16.62	AV	V	32.19	48.81	54.00	5.19
4904.000	34.66	PK	H	11.58	46.24	74.00	27.76
4904.000	21.52	AV	H	11.58	33.10	54.00	20.90
4904.000	34.58	PK	V	11.58	46.16	74.00	27.84
4904.000	21.43	AV	V	11.58	33.01	54.00	20.99
7356.000	34.33	PK	H	15.55	49.88	74.00	24.12
7356.000	21.21	AV	H	15.55	36.76	54.00	17.24
7356.000	34.28	PK	V	15.55	49.83	74.00	24.17
7356.000	21.19	AV	V	15.55	36.74	54.00	17.26

Worst Radiation Spurious Emissions Margin Test plots (802.11b Middle Channel was the worst):

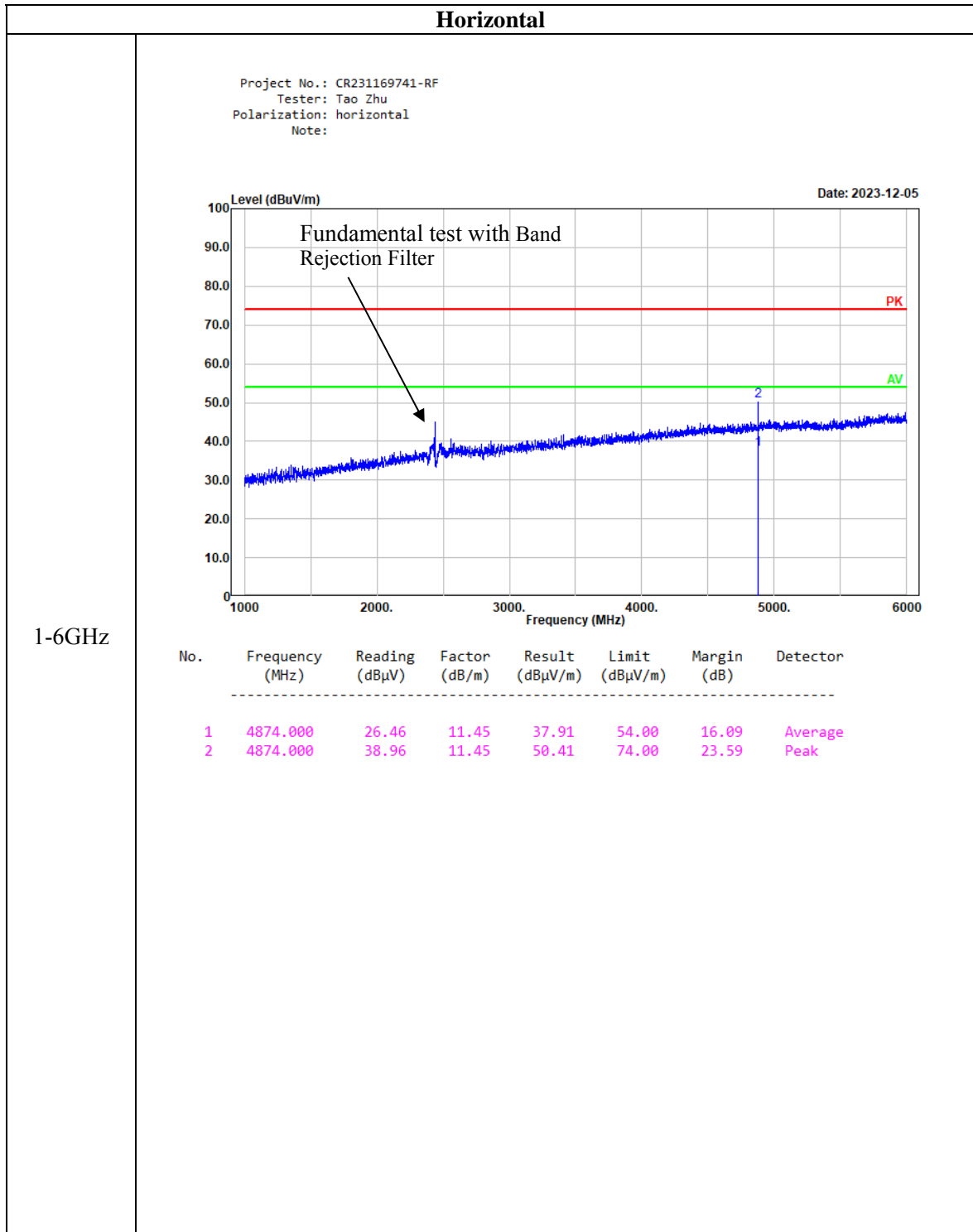

Horizontal

Project No.: CR231169741-RF
 Tester: Tao Zhu
 Polarization: horizontal
 Note:

Date: 2023-12-05

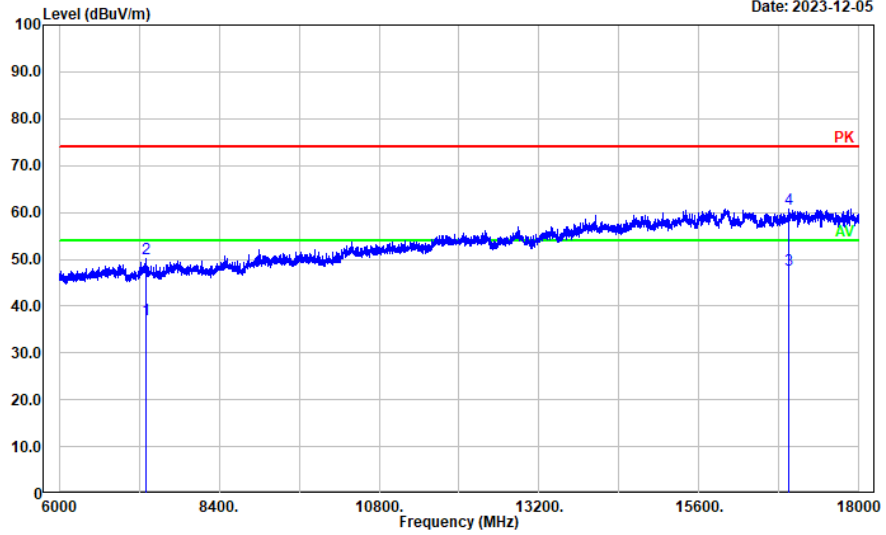

6-18GHz

No.	Frequency (MHz)	Reading (dBuV)	Factor (dB/m)	Result (dBuV/m)	Limit (dBuV/m)	Margin (dB)	Detector
1	7311.000	21.55	15.58	37.13	54.00	16.87	Average
2	7311.000	34.63	15.58	50.21	74.00	23.79	Peak
3	16950.990	19.76	27.87	47.63	54.00	6.37	Average
4	16950.990	32.93	27.87	60.80	74.00	13.20	Peak

Horizontal

Project No.: CR231169741-RF
 Tester: Tao Zhu
 Polarization: Horizontal
 Note:

Date: 2023-12-05

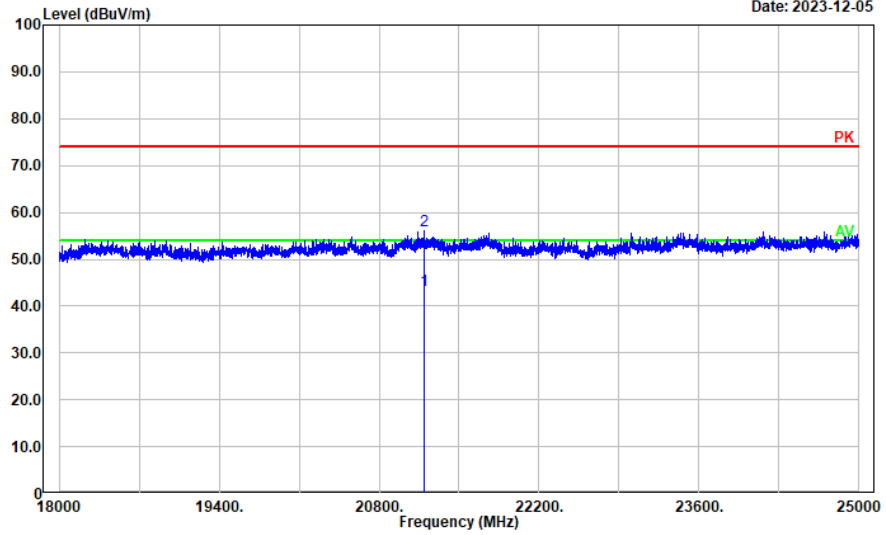

18-25GHz

No.	Frequency (MHz)	Reading (dBμV)	Factor (dB/m)	Result (dBμV/m)	Limit (dBμV/m)	Margin (dB)	Detector
1	21189.840	38.53	4.80	43.33	54.00	10.67	Average
2	21189.840	51.38	4.80	56.18	74.00	17.82	Peak

Vertical

Project No.: CR231169741-RF
 Tester: Tao Zhu
 Polarization: vertical
 Note:

Date: 2023-12-05

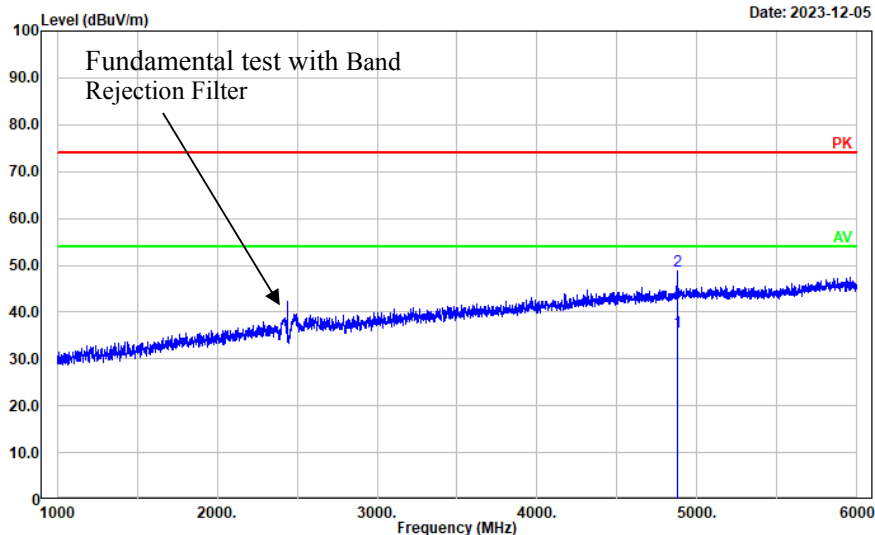

1-6GHz

No.	Frequency (MHz)	Reading (dBμV)	Factor (dB/m)	Result (dBμV/m)	Limit (dBμV/m)	Margin (dB)	Detector
1	4874.000	24.33	11.45	35.78	54.00	18.22	Average
2	4874.000	37.21	11.45	48.66	74.00	25.34	Peak

Vertical

Project No.: CR231169741-RF
 Tester: Tao Zhu
 Polarization: vertical
 Note:

Date: 2023-12-05

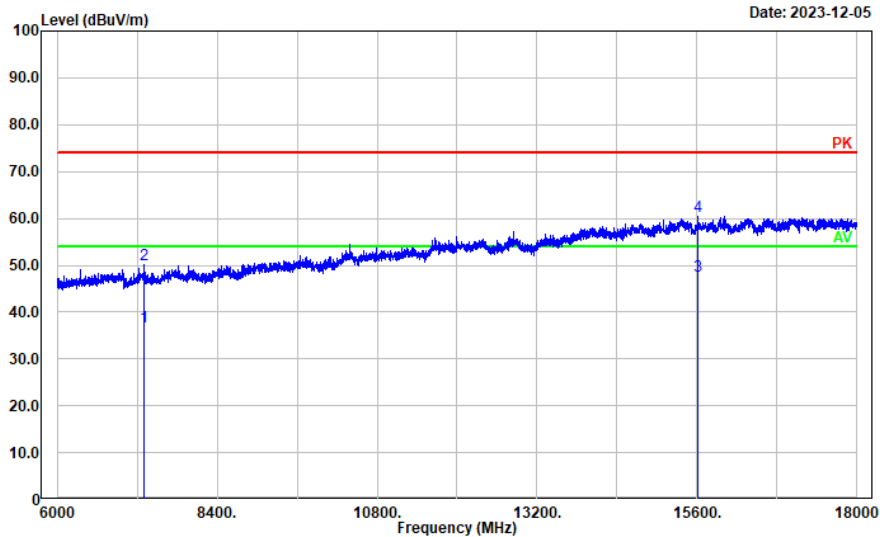

6-18GHz

No.	Frequency (MHz)	Reading (dBμV)	Factor (dB/m)	Result (dBμV/m)	Limit (dBμV/m)	Margin (dB)	Detector
1	7311.000	21.19	15.58	36.77	54.00	17.23	Average
2	7311.000	34.59	15.58	50.17	74.00	23.83	Peak
3	15616.320	22.93	24.72	47.65	54.00	6.35	Average
4	15616.320	35.66	24.72	60.38	74.00	13.62	Peak

Vertical

Project No.: CR231169741-RF
 Tester: Tao Zhu
 Polarization: vertical
 Note:

Date: 2023-12-05

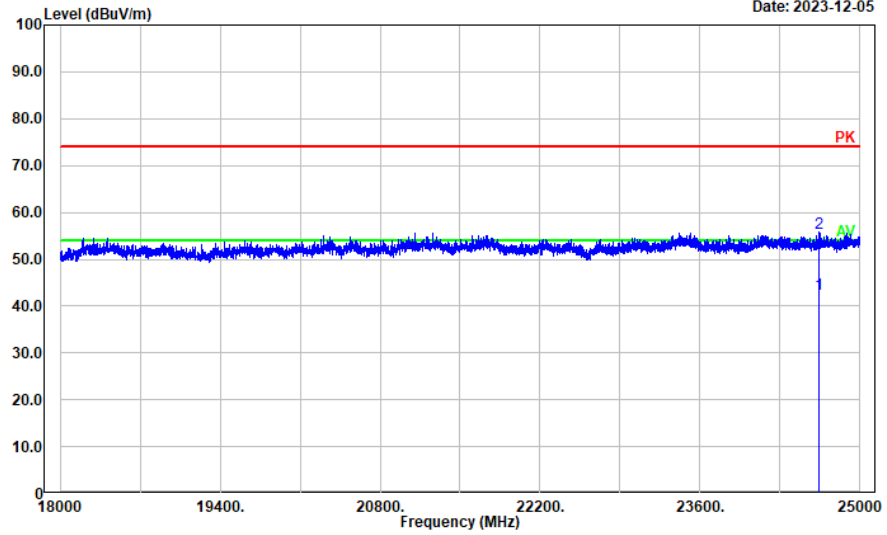

18-25GHz

No.	Frequency (MHz)	Reading (dBμV)	Factor (dB/m)	Result (dBμV/m)	Limit (dBμV/m)	Margin (dB)	Detector
1	24642.930	37.18	5.39	42.57	54.00	11.43	Average
2	24642.930	50.30	5.39	55.69	74.00	18.31	Peak

4.3 Minimum 6 dB Emission Bandwidth

Serial Number:	2E5M-1	Test Date:	2023/11/28
Test Site:	RF	Test Mode:	Transmitting
Tester:	Arthur Su	Test Result:	Pass

Environmental Conditions:					
Temperature: (°C)	25.3	Relative Humidity: (%)	53	ATM Pressure: (kPa)	101.3

Test Equipment List and Details:

Manufacturer	Description	Model	Serial Number	Calibration Date	Calibration Due Date
R&S	Spectrum Analyzer	FSU26	200256	2023/03/31	2024/03/30
zhuoxiang	Coaxial Cable	SMA-178	211001	Each time	N/A
eastsheep	Coaxial Attenuator	2W-SMA-JK-18G	21060301	Each time	N/A

* Statement of Traceability: China Certification ICT Co., Ltd (Dongguan) attests that all calibrations have been performed, traceable to National Primary Standards and International System of Units (SI).

Test Data:

Test Modes	Test Frequency (MHz)	6 dB Bandwidth (MHz)	Limit (MHz)
802.11b	2412	8.56	0.5
	2437	8.64	0.5
	2462	7.60	0.5
802.11g	2412	15.60	0.5
	2437	16.48	0.5
	2462	15.76	0.5
802.11n ht20	2412	17.12	0.5
	2437	17.68	0.5
	2462	16.96	0.5
802.11n ht40	2422	36.64	0.5
	2437	36.16	0.5
	2452	26.08	0.5

6dB Emission Bandwidth	
802.11b Lowest Channel	<p>ProjectNo.:CR231169741-RF Tester:Arthur Su Date: 28.NOV.2023 20:55:22</p>
802.11b Middle Channel	<p>ProjectNo.:CR231169741-RF Tester:Arthur Su Date: 28.NOV.2023 20:58:19</p>
802.11b Highest Channel	<p>ProjectNo.:CR231169741-RF Tester:Arthur Su Date: 28.NOV.2023 21:00:25</p>

6dB Emission Bandwidth	
<p>802.11g Lowest Channel</p>	<p>ProjectNo.:CR231169741-RF Tester:Arthur Su Date: 28.NOV.2023 21:05:09</p>
<p>802.11g Middle Channel</p>	<p>ProjectNo.:CR231169741-RF Tester:Arthur Su Date: 28.NOV.2023 21:06:50</p>
<p>802.11g Highest Channel</p>	<p>ProjectNo.:CR231169741-RF Tester:Arthur Su Date: 28.NOV.2023 21:09:31</p>

6dB Emission Bandwidth	
802.11n ht20 Lowest Channel	<p>ProjectNo.:CR231169741-RF Tester:Arthur Su Date: 28.NOV.2023 21:13:39</p>
802.11n ht20 Middle Channel	<p>ProjectNo.:CR231169741-RF Tester:Arthur Su Date: 28.NOV.2023 21:15:30</p>
802.11n ht20 Highest Channel	<p>ProjectNo.:CR231169741-RF Tester:Arthur Su Date: 28.NOV.2023 21:16:50</p>

6dB Emission Bandwidth	
802.11n ht40 Lowest Channel	<p>ProjectNo.:CR231169741-RF Tester:Arthur Su Date: 28.NOV.2023 21:19:09</p>
802.11n ht40 Middle Channel	<p>ProjectNo.:CR231169741-RF Tester:Arthur Su Date: 28.NOV.2023 21:22:38</p>
802.11n ht40 Highest Channel	<p>ProjectNo.:CR231169741-RF Tester:Arthur Su Date: 28.NOV.2023 21:27:25</p>

4.4 99% Occupied Bandwidth

Serial Number:	2E5M-1	Test Date:	2023/11/28
Test Site:	RF	Test Mode:	Transmitting
Tester:	Arthur Su	Test Result:	N/A

Environmental Conditions:

Temperature: (°C)	25.3	Relative Humidity: (%)	53	ATM Pressure: (kPa)	101.3
----------------------	------	---------------------------	----	------------------------	-------

Test Equipment List and Details:

Manufacturer	Description	Model	Serial Number	Calibration Date	Calibration Due Date
R&S	Spectrum Analyzer	FSU26	200256	2023/03/31	2024/03/30
zhuoxiang	Coaxial Cable	SMA-178	211001	Each time	N/A
eastsheep	Coaxial Attenuator	2W-SMA-JK-18G	21060301	Each time	N/A

* Statement of Traceability: China Certification ICT Co., Ltd (Dongguan) attests that all calibrations have been performed, traceable to National Primary Standards and International System of Units (SI).

Test Data:

Test Modes	Test Channel	Test Frequency (MHz)	99% Occupied Bandwidth (MHz)
802.11b	Lowest	2412	13.04
	Middle	2437	13.20
	Highest	2462	12.72
802.11g	Lowest	2412	16.88
	Middle	2437	16.96
	Highest	2462	16.64
802.11n ht20	Lowest	2412	17.84
	Middle	2437	18.00
	Highest	2462	17.68
802.11n ht40	Lowest	2422	36.64
	Middle	2437	36.64
	Highest	2452	35.68

99% Occupied Bandwidth

<p>802.11b Lowest Channel</p>	<p>ProjectNo.:CR231169741-RF Tester:Arthur Su Date: 28.NOV.2023 20:55:35</p>
<p>802.11b Middle Channel</p>	<p>ProjectNo.:CR231169741-RF Tester:Arthur Su Date: 28.NOV.2023 20:58:32</p>
<p>802.11b Highest Channel</p>	<p>ProjectNo.:CR231169741-RF Tester:Arthur Su Date: 28.NOV.2023 21:00:38</p>

99% Occupied Bandwidth

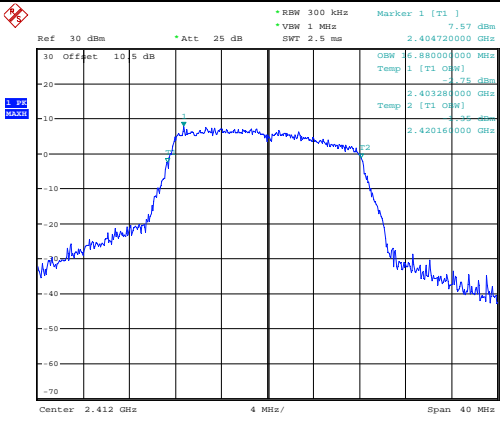
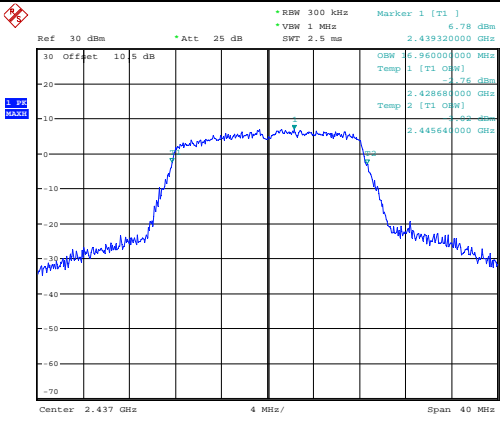
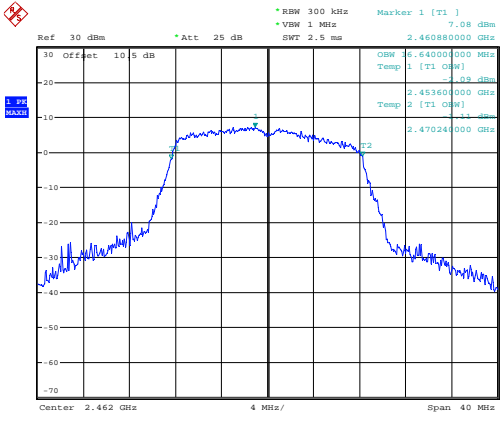
<p>802.11g Lowest Channel</p>	 <p>ProjectNo.:CR231169741-RF Tester:Arthur Su Date: 28.NOV.2023 21:05:26</p>
<p>802.11g Middle Channel</p>	 <p>ProjectNo.:CR231169741-RF Tester:Arthur Su Date: 28.NOV.2023 21:07:06</p>
<p>802.11g Highest Channel</p>	 <p>ProjectNo.:CR231169741-RF Tester:Arthur Su Date: 28.NOV.2023 21:09:47</p>

99% Occupied Bandwidth

802.11n ht20
Lowest Channel

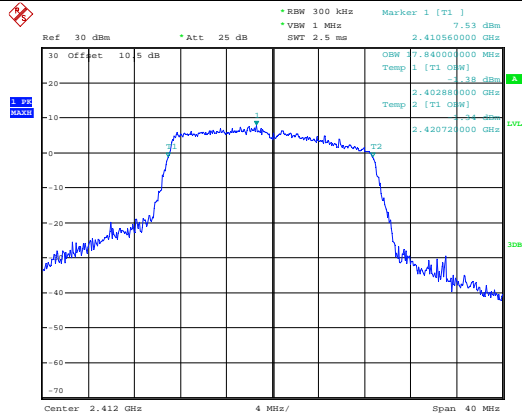

ProjectNo.:CR231169741-RF Tester:Arthur Su
Date: 28.NOV.2023 21:13:56

802.11n ht20
Middle Channel

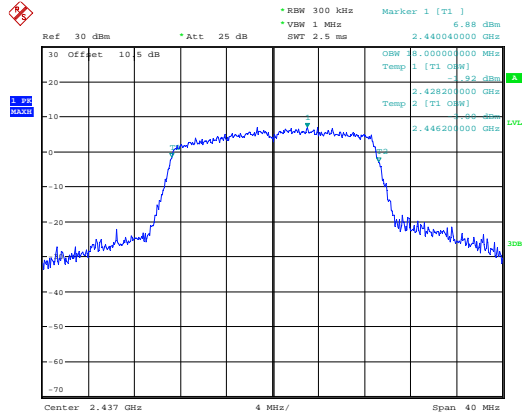

ProjectNo.:CR231169741-RF Tester:Arthur Su
Date: 28.NOV.2023 21:15:47

802.11n ht20
Highest Channel

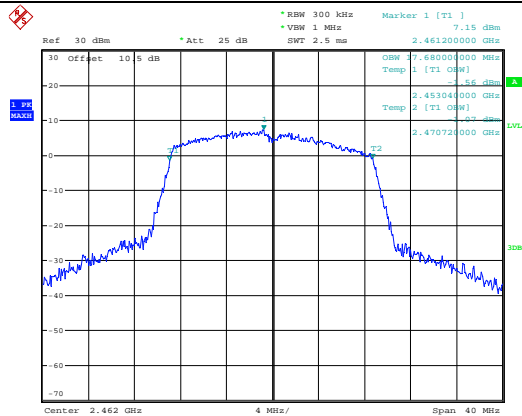

ProjectNo.:CR231169741-RF Tester:Arthur Su
Date: 28.NOV.2023 21:17:09

99% Occupied Bandwidth

802.11n ht40
Lowest Channel

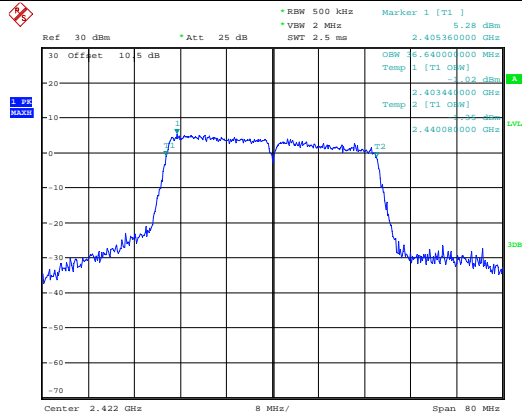

ProjectNo.:CR231169741-RF Tester:Arthur Su
Date: 28.NOV.2023 21:19:25

802.11n ht40
Middle Channel

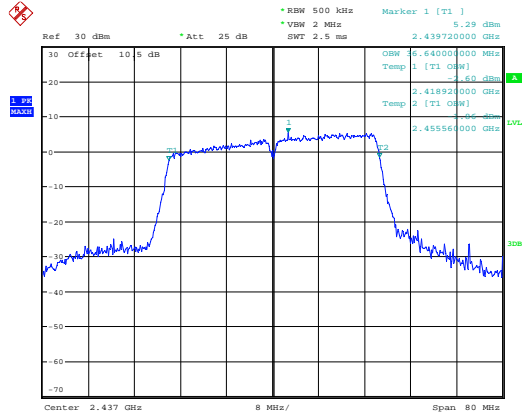

ProjectNo.:CR231169741-RF Tester:Arthur Su
Date: 28.NOV.2023 21:22:54

802.11n ht40
Highest Channel

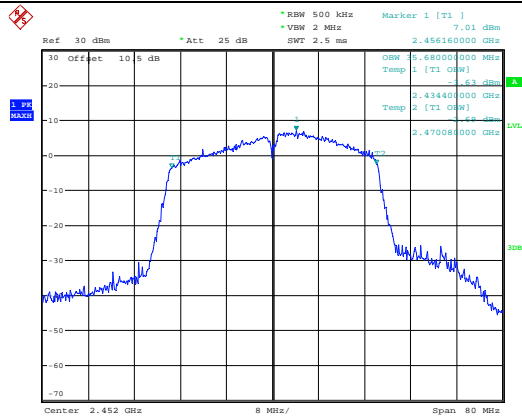

ProjectNo.:CR231169741-RF Tester:Arthur Su
Date: 28.NOV.2023 21:27:41

4.5 Maximum Conducted Output Power

Serial Number:	2E5M-1	Test Date:	2023/11/28
Test Site:	RF	Test Mode:	Transmitting
Tester:	Arthur Su	Test Result:	Pass

Environmental Conditions:

Temperature: (°C)	25.3	Relative Humidity: (%)	53	ATM Pressure: (kPa)	101.3
----------------------	------	---------------------------	----	------------------------	-------

Test Equipment List and Details:

Manufacturer	Description	Model	Serial Number	Calibration Date	Calibration Due Date
zhuoxiang	Coaxial Cable	SMA-178	211001	Each time	N/A
eastsheep	Coaxial Attenuator	2W-SMA-JK-18G	21060301	Each time	N/A
Anritsu	Power Meter	ML2495A	1106009	2023/08/04	2024/08/03
Anritsu	Pulse Power Sensor	MA2411A	10780	2023/08/04	2024/08/03

* Statement of Traceability: China Certification ICT Co., Ltd (Dongguan) attests that all calibrations have been performed, traceable to National Primary Standards and International System of Units (SI).

Test Data:

Test Modes	Test Frequency (MHz)	Maximum Conducted Peak Output Power (dBm)	Maximum Conducted Average Output Power (dBm)	Limit (dBm)
802.11b	2412	20.16	16.74	30
	2437	20.41	17.01	30
	2462	20.52	17.09	30
802.11g	2412	23.02	14.78	30
	2437	22.86	14.59	30
	2462	22.93	14.65	30
802.11n ht20	2412	22.97	14.71	30
	2437	22.94	14.68	30
	2462	22.98	14.73	30
802.11n ht40	2422	21.95	13.56	30
	2437	21.93	13.51	30
	2452	22.06	13.78	30

4.6 Maximum Power Spectral Density

Serial Number:	2E5M-1	Test Date:	2023/11/28
Test Site:	RF	Test Mode:	Transmitting
Tester:	Arthur Su	Test Result:	Pass

Environmental Conditions:

Temperature: (°C)	25.3	Relative Humidity: (%)	53	ATM Pressure: (kPa)	101.3
----------------------	------	---------------------------	----	------------------------	-------

Test Equipment List and Details:

Manufacturer	Description	Model	Serial Number	Calibration Date	Calibration Due Date
R&S	Spectrum Analyzer	FSU26	200256	2023/03/31	2024/03/30
zhuoxiang	Coaxial Cable	SMA-178	211001	Each time	N/A
eastsheep	Coaxial Attenuator	2W-SMA-JK-18G	21060301	Each time	N/A

* Statement of Traceability: China Certification ICT Co., Ltd (Dongguan) attests that all calibrations have been performed, traceable to National Primary Standards and International System of Units (SI).

Test Data:

Test Modes	Test Frequency (MHz)	Power Spectral Density (dBm/3kHz)	Limit (dBm/3kHz)
802.11b	2412	-4.64	8.00
	2437	-5.21	8.00
	2462	-4.97	8.00
802.11g	2412	-9.83	8.00
	2437	-10.41	8.00
	2462	-10.12	8.00
802.11n ht20	2412	-9.98	8.00
	2437	-10.06	8.00
	2462	-9.86	8.00
802.11n ht40	2422	-14.02	8.00
	2437	-13.44	8.00
	2452	-12.31	8.00

Maximum Power Spectral Density

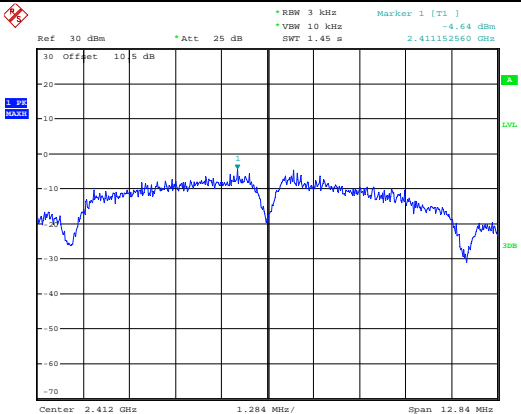
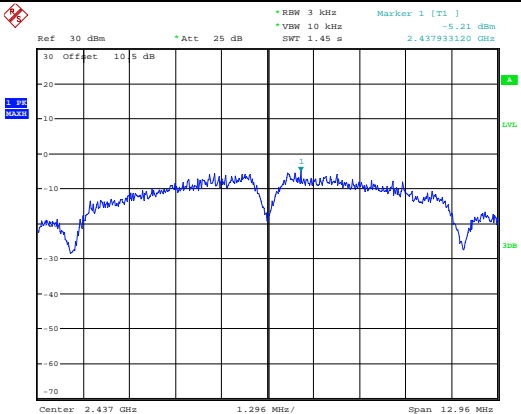
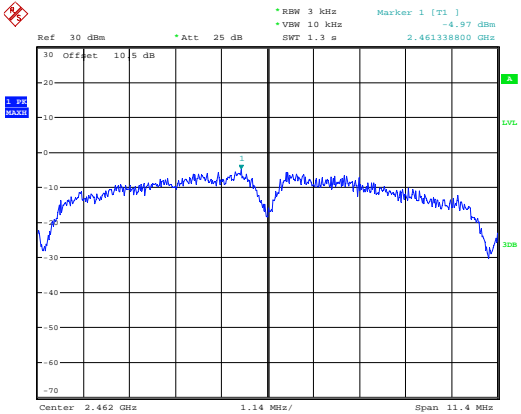
<p>802.11b Lowest Channel</p>	 <p>ProjectNo.:CR231169741-RF Tester:Arthur Su Date: 28.NOV.2023 20:55:56</p>
<p>802.11b Middle Channel</p>	 <p>ProjectNo.:CR231169741-RF Tester:Arthur Su Date: 28.NOV.2023 20:58:58</p>
<p>802.11b Highest Channel</p>	 <p>ProjectNo.:CR231169741-RF Tester:Arthur Su Date: 28.NOV.2023 21:00:57</p>

Maximum Power Spectral Density

<p>802.11g Lowest Channel</p>	<p>ProjectNo.:CR231169741-RF Tester:Arthur Su Date: 28.NOV.2023 21:06:07</p>
<p>802.11g Middle Channel</p>	<p>ProjectNo.:CR231169741-RF Tester:Arthur Su Date: 28.NOV.2023 21:07:40</p>
<p>802.11g Highest Channel</p>	<p>ProjectNo.:CR231169741-RF Tester:Arthur Su Date: 28.NOV.2023 21:10:21</p>

Maximum Power Spectral Density

802.11n ht20
Lowest Channel

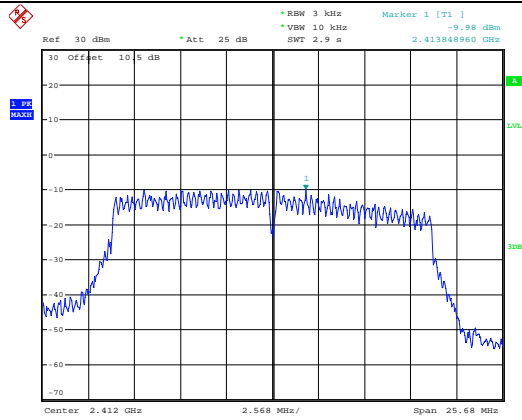

ProjectNo.:CR231169741-RF Tester:Arthur Su
 Date: 28.NOV.2023 21:14:31

802.11n ht20
Middle Channel

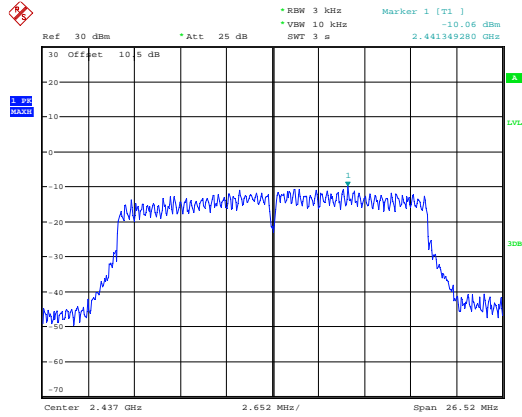

ProjectNo.:CR231169741-RF Tester:Arthur Su
 Date: 28.NOV.2023 21:16:23

802.11n ht20
Highest Channel

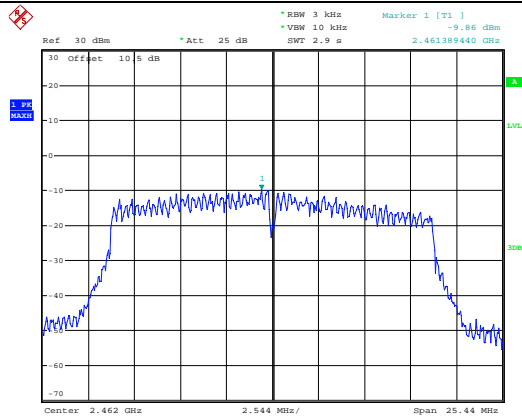

ProjectNo.:CR231169741-RF Tester:Arthur Su
 Date: 28.NOV.2023 21:17:44

Maximum Power Spectral Density

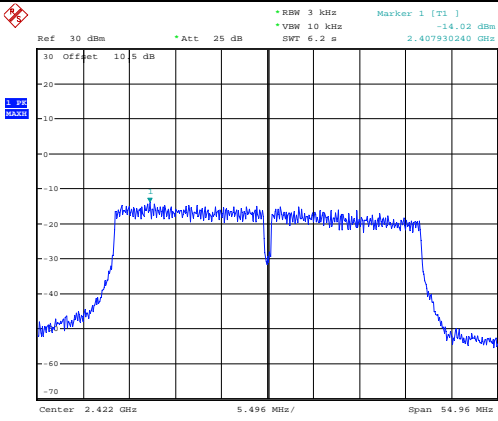
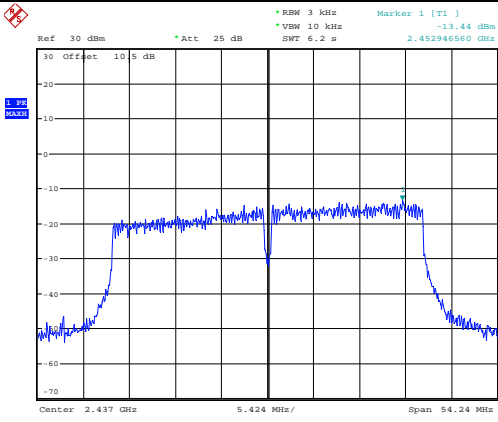
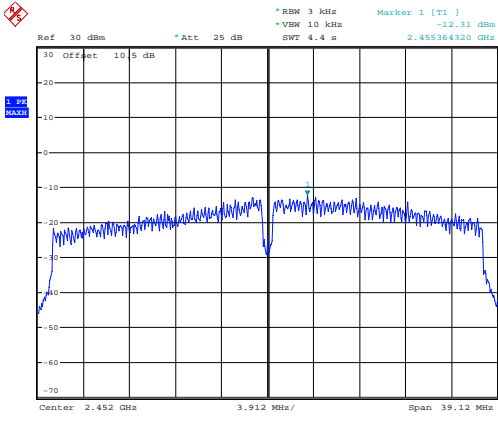
<p>802.11n ht40 Lowest Channel</p>	 <p>ProjectNo.:CR231169741-RF Tester:Arthur Su Date: 28.NOV.2023 21:20:34</p>
<p>802.11n ht40 Middle Channel</p>	 <p>ProjectNo.:CR231169741-RF Tester:Arthur Su Date: 28.NOV.2023 21:24:02</p>
<p>802.11n ht40 Highest Channel</p>	 <p>ProjectNo.:CR231169741-RF Tester:Arthur Su Date: 28.NOV.2023 21:28:31</p>

4.7 100 kHz Bandwidth of Frequency Band Edge

Serial Number:	2E5M-1	Test Date:	2023/11/28
Test Site:	RF	Test Mode:	Transmitting
Tester:	Arthur Su	Test Result:	Pass

Environmental Conditions:

Temperature: (°C)	25.3	Relative Humidity: (%)	53	ATM Pressure: (kPa)	101.3
----------------------	------	---------------------------	----	------------------------	-------

Test Equipment List and Details:

Manufacturer	Description	Model	Serial Number	Calibration Date	Calibration Due Date
R&S	Spectrum Analyzer	FSU26	200256	2023/03/31	2024/03/30
zhuoxiang	Coaxial Cable	SMA-178	211001	Each time	N/A
eastsheep	Coaxial Attenuator	2W-SMA-JK-18G	21060301	Each time	N/A

* *Statement of Traceability: China Certification ICT Co., Ltd (Dongguan) attests that all calibrations have been performed, traceable to National Primary Standards and International System of Units (SI).*

Test Data:

100 kHz Bandwidth of Frequency Band Edge

802.11b
Lowest Band edge

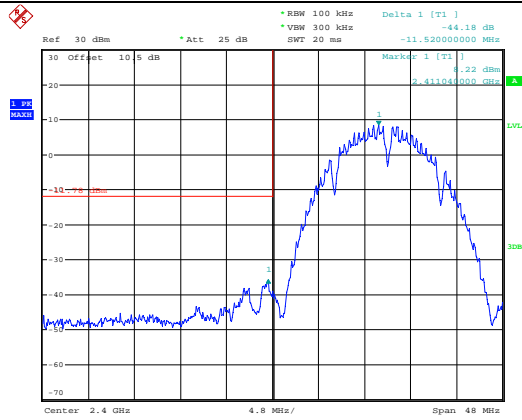

ProjectNo.:CR231169741-RF Tester:Arthur Su
 Date: 28.NOV.2023 20:56:09

802.11b
Highest Band edge

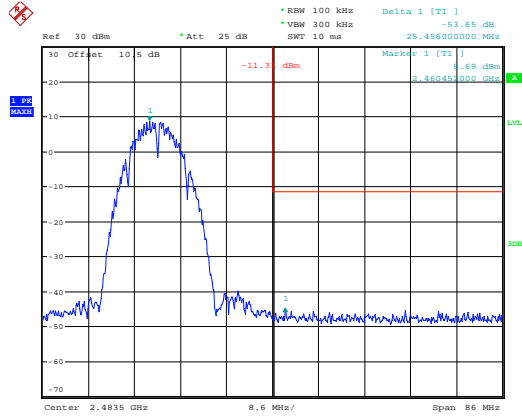

ProjectNo.:CR231169741-RF Tester:Arthur Su
 Date: 28.NOV.2023 21:01:14

100 kHz Bandwidth of Frequency Band Edge

802.11g
Lowest Band edge

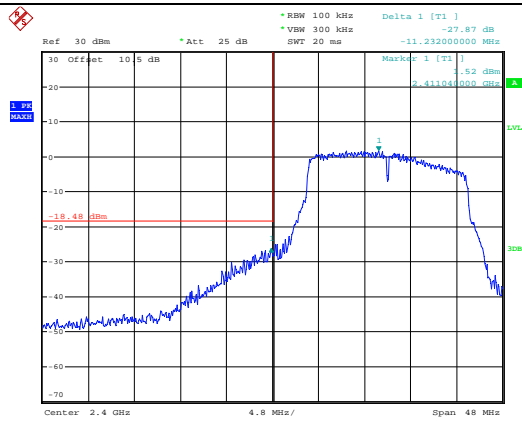

ProjectNo.:CR231169741-RF Tester:Arthur Su
 Date: 28.NOV.2023 21:06:20

802.11g
Highest Band edge

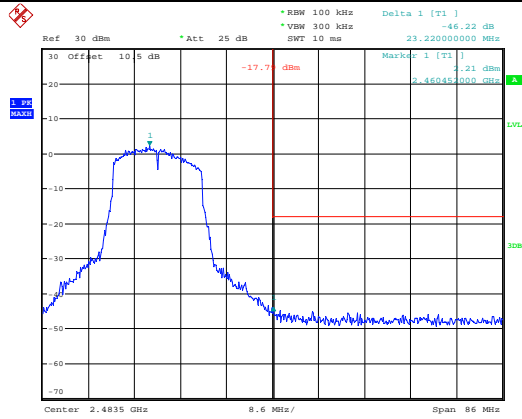

ProjectNo.:CR231169741-RF Tester:Arthur Su
 Date: 28.NOV.2023 21:10:38

100 kHz Bandwidth of Frequency Band Edge

802.11n ht20
Lowest Band edge

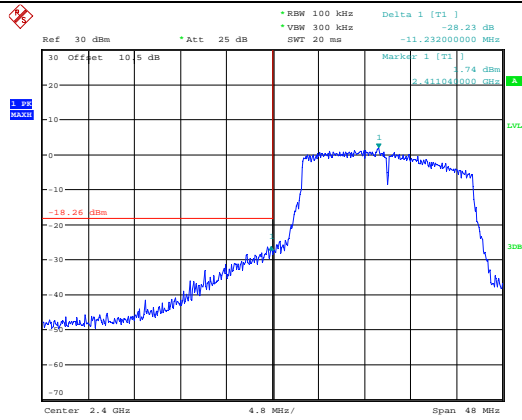

ProjectNo.:CR231169741-RF Tester:Arthur Su
Date: 28.NOV.2023 21:14:44

802.11n ht20
Highest Band edge

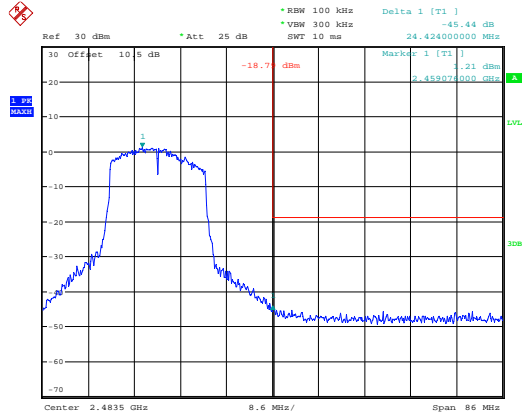

ProjectNo.:CR231169741-RF Tester:Arthur Su
Date: 28.NOV.2023 21:18:01

100 kHz Bandwidth of Frequency Band Edge

802.11n ht40
Lowest Band edge

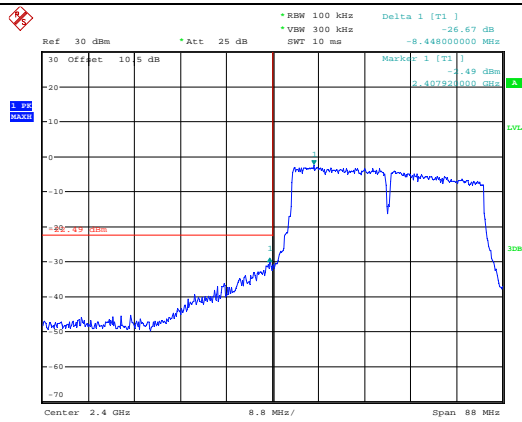

ProjectNo.:CR231169741-RF Tester:Arthur Su
 Date: 28.NOV.2023 21:20:47

802.11n ht40
Highest Band edge

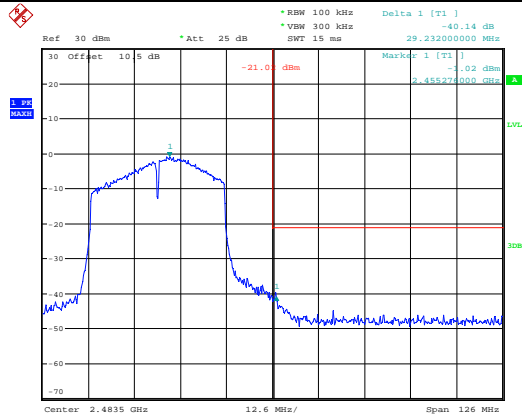

ProjectNo.:CR231169741-RF Tester:Arthur Su
 Date: 28.NOV.2023 21:28:45

4.8 Duty Cycle

Serial Number:	2E5M-1	Test Date:	2023/11/28
Test Site:	RF	Test Mode:	Transmitting
Tester:	Arthur Su	Test Result:	N/A

Environmental Conditions:					
Temperature: (°C)	25.3	Relative Humidity: (%)	53	ATM Pressure: (kPa)	101.3

Test Equipment List and Details:

Manufacturer	Description	Model	Serial Number	Calibration Date	Calibration Due Date
R&S	Spectrum Analyzer	FSU26	200256	2023/03/31	2024/03/30
zhuoxiang	Coaxial Cable	SMA-178	211001	Each time	N/A
eastsheep	Coaxial Attenuator	2W-SMA-JK-18G	21060301	Each time	N/A

* Statement of Traceability: China Certification ICT Co., Ltd (Dongguan) attests that all calibrations have been performed, traceable to National Primary Standards and International System of Units (SI).

Test Data:

Test Modes	Ton (ms)	Ton+off (ms)	Duty cycle (%)	1/T (Hz)	Duty Factor (dB)	VBW Setting (kHz)
802.11b	100	100	100.00	/	/	0.01
802.11g	100	100	100.00	/	/	0.01
802.11n ht20	100	100	100.00	/	/	0.01
802.11n ht40	100	100	100.00	/	/	0.01

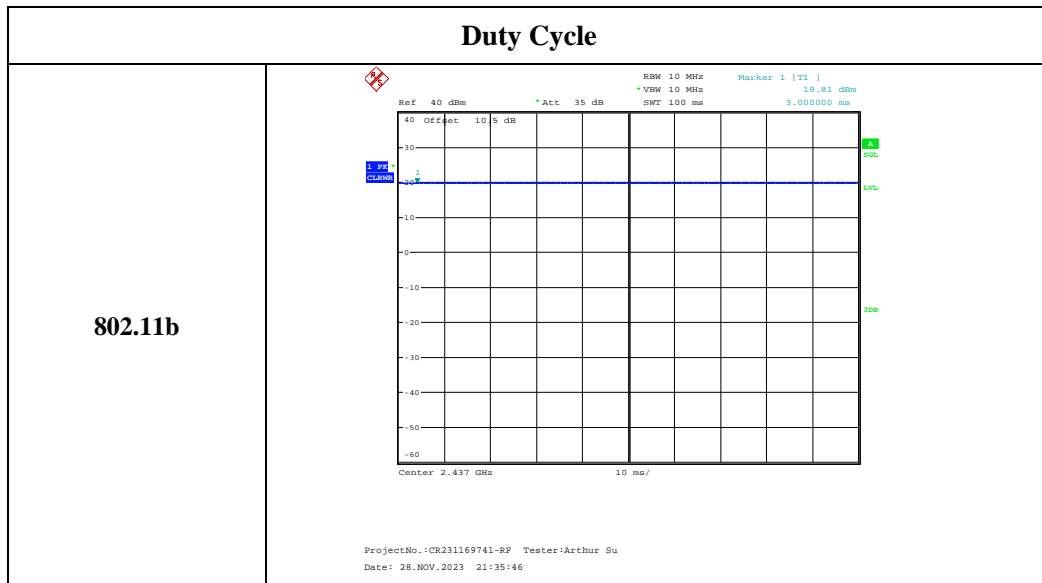

802.11g

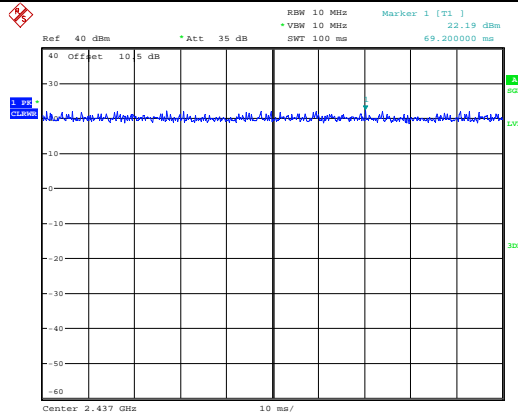

ProjectNo.:CR231169741-RP Tester:Arthur Su
 Date: 28.NOV.2023 21:35:18

802.11n ht20

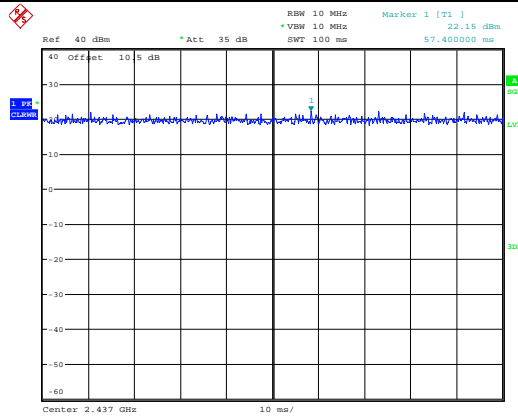

ProjectNo.:CR231169741-RP Tester:Arthur Su
 Date: 28.NOV.2023 21:34:39

802.11n ht40

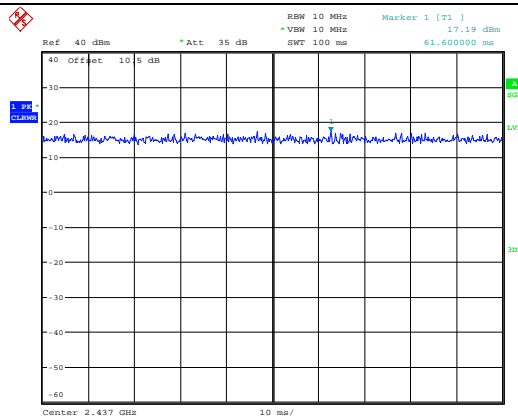

ProjectNo.:CR231169741-RP Tester:Arthur Su
 Date: 28.NOV.2023 21:34:08

5. EUT PHOTOGRAPHS

Please refer to the attachment CR231169741-EXP EUT EXTERNAL PHOTOGRAPHS and CR231169741-INP EUT INTERNAL PHOTOGRAPHS.

6. TEST SETUP PHOTOGRAPHS

Please refer to the attachment CR231169741-00C-TSP TEST SETUP PHOTOGRAPHS.

===== END OF REPORT =====