



中认信通
CHINA CERTIFICATION ICT CO., LTD (DONGGUAN)



TEST REPORT

Applicant: MAXWEST COMMUNICATION LIMITED

Address: FLAT/RM 707 7/F, FORTRESS TOWER 250 KING'S ROAD,NORTH
POINT, HONG KONG

FCC ID: 2ASP8ASTROA64

Product Name: Phone

Standard(s): 47 CFR Part 15, Subpart C (15.247)
ANSI C63.10-2013
KDB 558074 D01 15.247 Meas Guidance v05r02

The above device has been tested and found compliant with the requirement of the relative standards by China Certification ICT Co., Ltd (Dongguan)

Report Number: CR231169741-00A

Date Of Issue: 2023/12/8

Reviewed By: Calvin Chen

Title: RF Engineer

Approved By: Sun Zhong

Title: Manager

Test Laboratory: China Certification ICT Co., Ltd (Dongguan)

No. 113, Pingkang Road, Dalang Town, Dongguan,
Guangdong, China
Tel: +86-769-82016888

Test Facility

The Test site used by China Certification ICT Co., Ltd (Dongguan) to collect test data is located on the No. 113, Pingkang Road, Dalang Town, Dongguan, Guangdong, China.

The lab has been recognized as the FCC accredited lab under the KDB 974614 D01 and is listed in the FCC Public Access Link (PAL) database, FCC Registration No.: 442868, the FCC Designation No.: CN1314.

The lab has been recognized by Innovation, Science and Economic Development Canada to test to Canadian radio equipment requirements, the CAB identifier: CN0123.

Declarations

China Certification ICT Co., Ltd (Dongguan) is not responsible for the authenticity of any test data provided by the applicant. Data included from the applicant that may affect test results are marked with a triangle symbol “▲”. Customer model name, addresses, names, trademarks etc. are not considered data.

Unless otherwise stated the results shown in this test report refer only to the sample(s) tested.

This report cannot be reproduced except in full, without prior written approval of the Company.

This report is valid only with a valid digital signature. The digital signature may be available only under the Adobe software above version 7.0.

This report may contain data that are not covered by the accreditation scope and shall be marked with an asterisk “★”.

CONTENTS

DOCUMENT REVISION HISTORY	5
1. GENERAL INFORMATION	6
1.1 PRODUCT DESCRIPTION FOR EQUIPMENT UNDER TEST (EUT)	6
1.2 DESCRIPTION OF TEST CONFIGURATION.....	7
1.2.1 EUT Operation Condition:.....	7
1.2.2 Support Equipment List and Details	7
1.2.3 Support Cable List and Details	7
1.2.4 Block Diagram of Test Setup.....	8
1.3 MEASUREMENT UNCERTAINTY	9
2. SUMMARY OF TEST RESULTS	10
3. REQUIREMENTS AND TEST PROCEDURES	11
3.1 AC LINE CONDUCTED EMISSIONS.....	11
3.1.1 Applicable Standard.....	11
3.1.2 EUT Setup.....	12
3.1.3 EMI Test Receiver Setup	12
3.1.4 Test Procedure	13
3.1.5 Corrected Amplitude & Margin Calculation.....	13
3.2 RADIATION SPURIOUS EMISSIONS.....	14
3.2.1 Applicable Standard.....	14
3.2.2 EUT Setup.....	14
3.2.3 EMI Test Receiver & Spectrum Analyzer Setup	15
3.2.4 Test Procedure	16
3.2.5 Corrected Amplitude & Margin Calculation.....	16
3.3 MINIMUM 6 DB BANDWIDTH.....	17
3.3.1 Applicable Standard.....	17
3.3.2 EUT Setup.....	17
3.3.3 Test Procedure	17
3.4 MAXIMUM CONDUCTED OUTPUT POWER.....	18
3.4.1 Applicable Standard.....	18
3.4.2 EUT Setup.....	18
3.4.3 Test Procedure	18
3.5 MAXIMUM POWER SPECTRAL DENSITY	19
3.5.1 Applicable Standard.....	19
3.5.2 EUT Setup.....	19
3.5.3 Test Procedure	19
3.6 100 KHZ BANDWIDTH OF FREQUENCY BAND EDGE.....	20
3.6.1 Applicable Standard.....	20
3.6.2 EUT Setup.....	20
3.6.3 Test Procedure	20
3.7 DUTY CYCLE	21
3.7.1 EUT Setup.....	21
3.7.2 Test Procedure	21

3.8 ANTENNA REQUIREMENT.....22
 3.8.1 Applicable Standard.....22
 3.8.2 Judgment.....22

4. Test DATA AND RESULTS 23
 4.1 AC LINE CONDUCTED EMISSIONS.....23
 4.2 RADIATION SPURIOUS EMISSIONS26
 4.3 6 dB EMISSION BANDWIDTH41
 4.4 MAXIMUM CONDUCTED OUTPUT POWER.....43
 4.5 MAXIMUM POWER SPECTRAL DENSITY45
 4.6 100 kHz BANDWIDTH OF FREQUENCY BAND EDGE.....47
 4.7 DUTY CYCLE49

5. RF EXPOSURE EVALUATION 50
 5.1 APPLICABLE STANDARD.....50
 5.2 MEASUREMENT RESULT50

6. EUT PHOTOGRAPHS 51

7. TEST SETUP PHOTOGRAPHS 52

DOCUMENT REVISION HISTORY

Revision Number	Report Number	Description of Revision	Date of Revision
1.0	CR231169741-00A	Original Report	2023/12/8

1. GENERAL INFORMATION

1.1 Product Description for Equipment under Test (EUT)

EUT Name:	Phone
EUT Model:	ASTRO A64
Operation Frequency:	2402-2480 MHz
Maximum Peak Output Power (Conducted):	-2.02dBm
Modulation Type:	GFSK
Rated Input Voltage:	DC 5V from adapter (for charging) or DC 3.8V from battery
Serial Number:	2E5M-1 (for RF Conducted Test) 2E5M-2 (for Emissions Test)
EUT Received Date:	2023/11/25
EUT Received Status:	Good
Note: These two adapters of product were evaluated in the CR231169741-00B report for the AC Line Conducted Emissions Test and Radiation Spurious Emissions Test. The report showed that product equipped with adapter 1 had worse emissions in AC Line Conducted Emissions Test and Radiation Spurious Emissions Test. Therefore, only the test results of product equipped with worst case adapter are reflected in this report.	

Operation Frequency Detail:

Channel	Frequency (MHz)	Channel	Frequency (MHz)
0	2402	20	2442
1	2404
...
...
..	...	38	2478
19	2440	39	2480
Per section 15.31(m), the below frequencies were performed to test:			
Test Channel		Frequency (MHz)	
Lowest		2402	
Middle		2440	
Highest		2480	

Antenna Information Detail▲:

Antenna Type	input impedance (Ohm)	Frequency Range	Antenna Gain
FPC Antenna	50	2400~2500	0.88
		5180~5825	-0.57

The Method of §15.203 Compliance:

- Antenna was permanently attached to the unit.
- Antenna use a unique type of connector to attach to the EUT.
- Unit was professionally installed, and installer shall be responsible for verifying that the correct antenna is employed with the unit.

Accessory Information:

Accessory Description	Manufacturer	Model	Parameters
Adapter 1	MAXWEST	ASTRO A64	Input: 100-240V~50/60Hz 0.2A Output: 5.0V = 1A
Adapter 2	MAXWEST	HJ-0501000E1-US	Input: 100-240V~50/60Hz 0.2A Output: 5.0V = 1A
USB-C Cable	/	/	Unshielded without ferrite, 1.0 Meter

1.2 Description of Test Configuration**1.2.1 EUT Operation Condition:**

EUT Operation Mode:	The system was configured for testing in Engineering Mode, which was provided by the manufacturer.		
Equipment Modifications:	No		
EUT Exercise Software:	Engineer Mode		
The software was provided by manufacturer. The maximum power was configured as below, that was provided by the manufacturer▲:			
Test Modes	Power Level Setting		
	Lowest Channel	Middle Channel	Highest Channel
BLE 1Mbps	default	default	default

1.2.2 Support Equipment List and Details

Manufacturer	Description	Model	Serial Number
IPRO	Earphone	Phonenix 5.0s	EP221126001

1.2.3 Support Cable List and Details

Cable Description	Shielding Type	Ferrite Core	Length (m)	From Port	To
Earphone Cable	NO	NO	1.2	EUT	Earphone
USB-C Cable	NO	NO	1.0	Adapter	EUT

1.2.4 Block Diagram of Test Setup

AC Line Conducted Emissions:

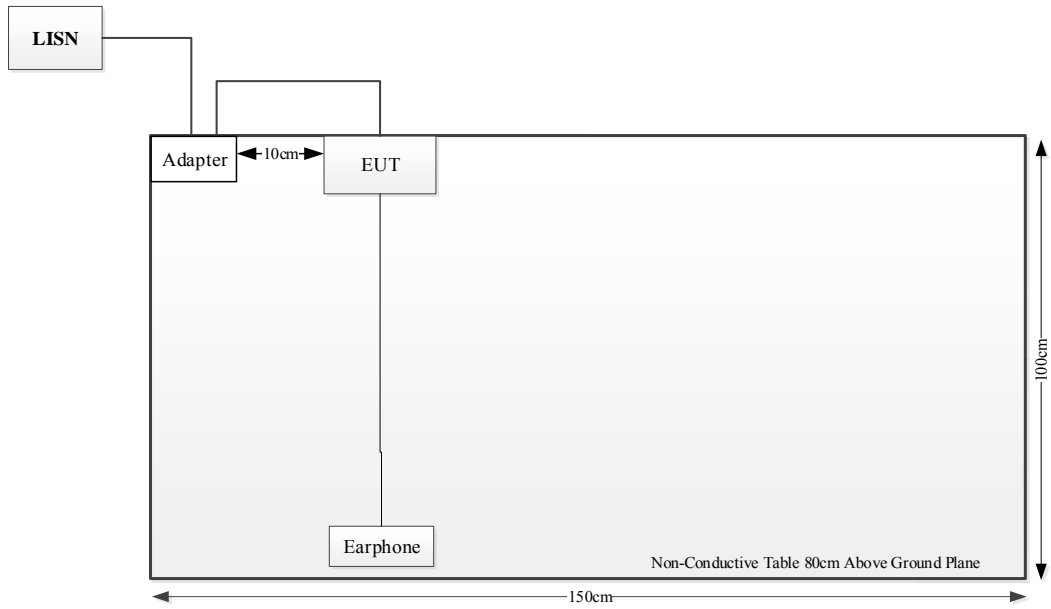

Radiation Spurious Emissions:

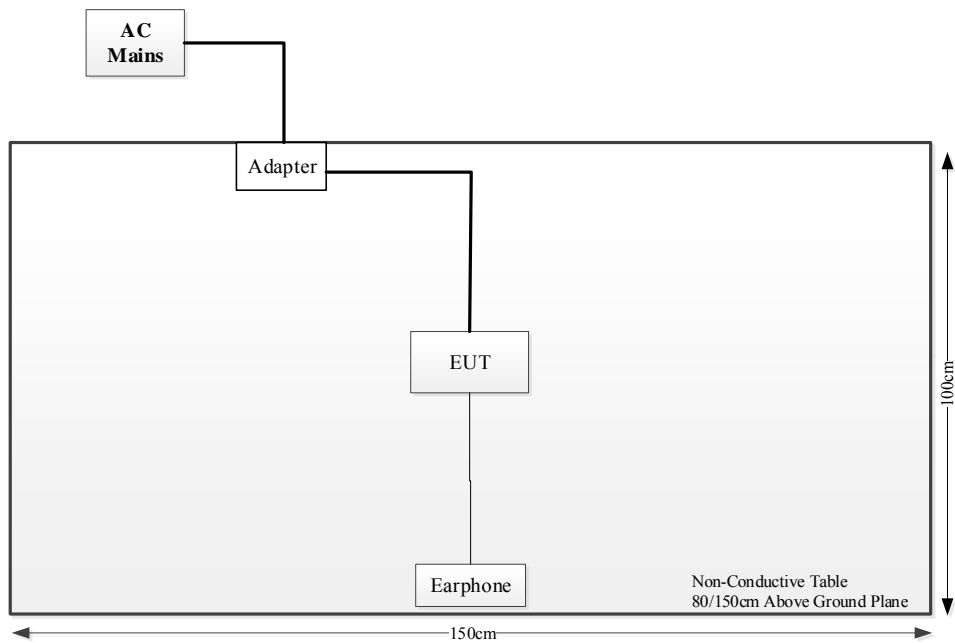

1.3 Measurement Uncertainty

Otherwise required by the applicant or Product Regulations, Decision Rule in this report did not consider the uncertainty. The extended uncertainty given in this report is obtained by combining the standard uncertainty times the coverage factor K with the 95% confidence interval.

Parameter	Measurement Uncertainty
Occupied Channel Bandwidth	±5 %
RF output power, conducted	±0.61dB
Power Spectral Density, conducted	±0.61 dB
Unwanted Emissions, radiated	9kHz~30MHz: 4.12dB, 30MHz~200MHz: 4.15 dB, 200MHz~1GHz: 5.61 dB, 1GHz~6GHz: 5.14 dB, 6GHz~18GHz: 5.93 dB, 18GHz~26.5GHz: 5.47 dB, 26.5GHz~40GHz: 5.63 dB
Unwanted Emissions, conducted	±1.26 dB
Temperature	±1 °C
Humidity	±5%
DC and low frequency voltages	±0.4%
Duty Cycle	1%
AC Power Lines Conducted Emission	2.8 dB (150 kHz to 30 MHz)

2. SUMMARY OF TEST RESULTS

Standard(s) Section	Test Items	Result
§15.207(a)	AC line conducted emissions	Compliant
§15.205, §15.209, §15.247(d)	Radiated Spurious Emissions	Compliant
§15.247 (a)(2)	Minimum 6 dB Bandwidth	Compliant
§15.247(b)(3)	Maximum Conducted Output Power	Compliant
§15.247(e)	Power Spectral Density	Compliant
§15.247(d)	100 kHz Bandwidth of Frequency Band Edge	Compliant
§15.203	Antenna Requirement	Compliant
§15.247(i), §1.1310	RF Exposure Evaluation	Compliant

3. REQUIREMENTS AND TEST PROCEDURES

3.1 AC Line Conducted Emissions

3.1.1 Applicable Standard

FCC§15.207(a).

(a) Except as shown in paragraphs (b) and (c) of this section, for an intentional radiator that is designed to be connected to the public utility (AC) power line, the radio frequency voltage that is conducted back onto the AC power line on any frequency or frequencies, within the band 150 kHz to 30 MHz, shall not exceed the limits in the following table, as measured using a 50 μ H/50 ohms line impedance stabilization network (LISN). Compliance with the provisions of this paragraph shall be based on the measurement of the radio frequency voltage between each power line and ground at the power terminal. The lower limit applies at the boundary between the frequency ranges.

Frequency of emission (MHz)	Conducted limit (dB μ V)	
	Quasi-peak	Average
0.15-0.5	66 to 56*	56 to 46*
0.5-5	56	46
5-30	60	50

*Decreases with the logarithm of the frequency.

(b) The limit shown in paragraph (a) of this section shall not apply to carrier current systems operating as intentional radiators on frequencies below 30 MHz. In lieu thereof, these carrier current systems shall be subject to the following standards:

(1) For carrier current system containing their fundamental emission within the frequency band 535-1705 kHz and intended to be received using a standard AM broadcast receiver: no limit on conducted emissions.

(2) For all other carrier current systems: 1000 μ V within the frequency band 535-1705 kHz, as measured using a 50 μ H/50 ohms LISN.

(3) Carrier current systems operating below 30 MHz are also subject to the radiated emission limits in §15.205, §15.209, §15.221, §15.223, or §15.227, as appropriate.

(c) Measurements to demonstrate compliance with the conducted limits are not required for devices which only employ battery power for operation and which do not operate from the AC power lines or contain provisions for operation while connected to the AC power lines. Devices that include, or make provisions for, the use of battery chargers which permit operating while charging, AC adapters or battery eliminators or that connect to the AC power lines indirectly, obtaining their power through another device which is connected to the AC power lines, shall be tested to demonstrate compliance with the conducted limits.

3.1.2 EUT Setup



- Note: 1. Support units were connected to second LISN.
 2. Both of LISNs (AMN) 80 cm from EUT and at the least 80 cm from other units and other metal planes support units.

The setup of EUT is according with per ANSI C63.10-2013 measurement procedure. The specification used was with the FCC Part 15.207 limits.

The spacing between the peripherals was 10 cm.

The adapter or EUT was connected to the main LISN with a 120 V/60 Hz AC power source.

3.1.3 EMI Test Receiver Setup

The EMI test receiver was set to investigate the spectrum from 150 kHz to 30 MHz.

During the conducted emission test, the EMI test receiver was set with the following configurations:

Frequency Range	IF B/W
150 kHz – 30 MHz	9 kHz

3.1.4 Test Procedure

The frequency and amplitude of the six highest ac power-line conducted emissions relative to the limit, measured over all the current-carrying conductors of the EUT power cords, and the operating frequency or frequency to which the EUT is tuned (if appropriate), should be reported, unless such emissions are more than 20 dB below the limit. AC power-line conducted emissions measurements are to be separately carried out only on each of the phase (“hot”) line(s) and (if used) on the neutral line(s), but not on the ground [protective earth] line(s). If less than six emission frequencies are within 20 dB of the limit, then the noise level of the measuring instrument at representative frequencies should be reported. The specific conductor of the power-line cord for each of the reported emissions should be identified. Measure the six highest emissions with respect to the limit on each current-carrying conductor of each power cord associated with the EUT (but not the power cords of associated or peripheral equipment that are part of the test configuration). Then, report the six highest emissions with respect to the limit from among all the measurements identifying the frequency and specific current-carrying conductor identified with the emission. The six highest emissions should be reported for each of the current-carrying conductors, or the six highest emissions may be reported over all the current-carrying conductors.

3.1.5 Corrected Amplitude & Margin Calculation

The basic equation is as follows:

Result = Reading + Factor

Factor = attenuation caused by cable loss + voltage division factor of AMN

The “**Margin**” column of the following data tables indicates the degree of compliance within the applicable limit. The equation for margin calculation is as follows:

Margin = Limit – Result

3.2 Radiation Spurious Emissions

3.2.1 Applicable Standard

FCC §15.247 (d);

In any 100 kHz bandwidth outside the frequency band in which the spread spectrum or digitally modulated intentional radiator is operating, the radio frequency power that is produced by the intentional radiator shall be at least 20 dB below that in the 100 kHz bandwidth within the band that contains the highest level of the desired power, based on either an RF conducted or a radiated measurement, provided the transmitter demonstrates compliance with the peak conducted power limits. If the transmitter complies with the conducted power limits based on the use of RMS averaging over a time interval, as permitted under paragraph (b)(3) of this section, the attenuation required under this paragraph shall be 30 dB instead of 20 dB. Attenuation below the general limits specified in §15.209(a) is not required. In addition, radiated emissions which fall in the restricted bands, as defined in §15.205(a), must also comply with the radiated emission limits specified in §15.209(a) (see §15.205(c)).

3.2.2 EUT Setup

9kHz~30MHz:

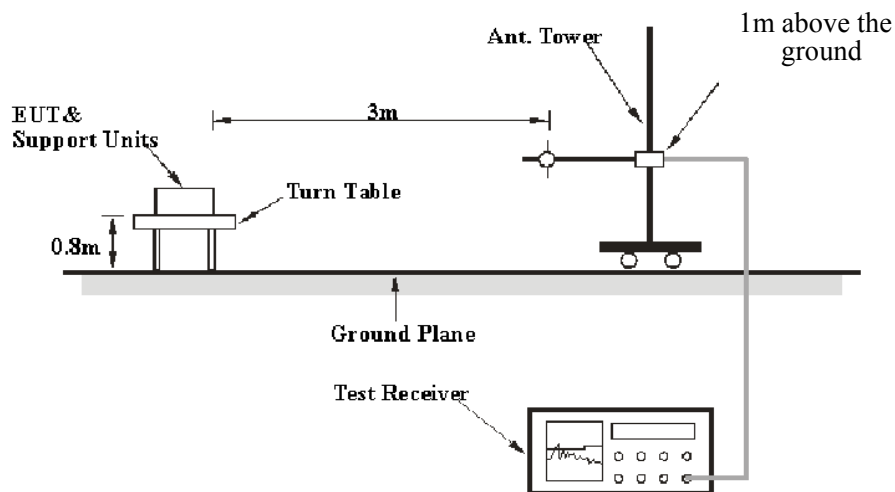

30MHz~1GHz:

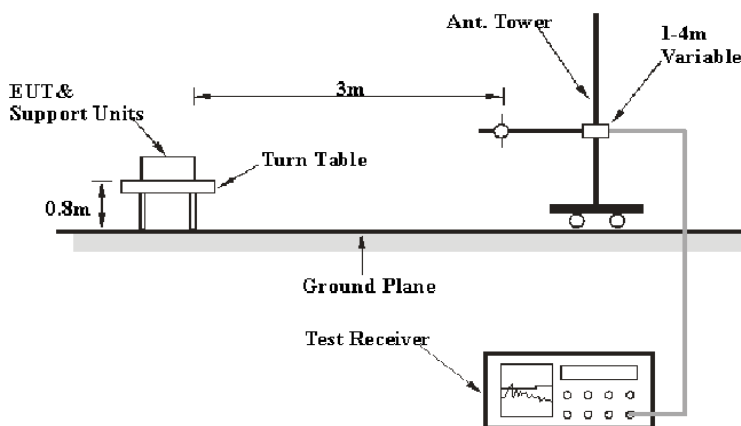

Above 1GHz:

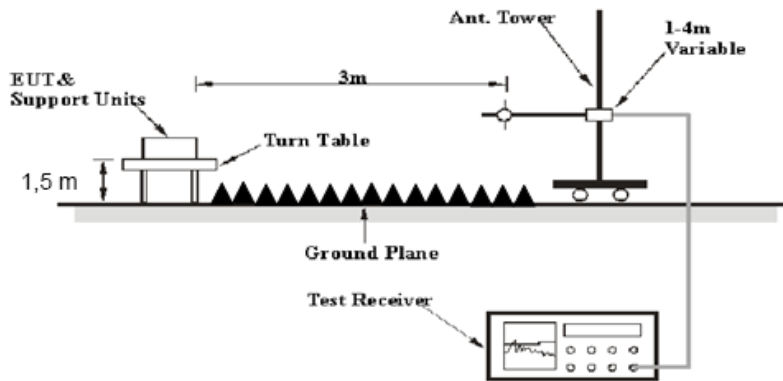

The radiated emissions were performed in the 3 meters distance, using the setup accordance with the ANSI C63.10-2013. The specification used was the FCC 15.209, and FCC 15.247 limits.

The external I/O cables were draped along the test table and formed a bundle 30 to 40 cm long in the middle.

The spacing between the peripherals was 10 cm.

For 9kHz-30MHz test, the lowest height of the magnetic antenna shall be 1 m above the ground and three antenna orientations (parallel, perpendicular, and ground-parallel) shall be measured.

3.2.3 EMI Test Receiver & Spectrum Analyzer Setup

The system was investigated from 9kHz to 25 GHz.

During the radiated emission test, the EMI test receiver & Spectrum Analyzer Setup were set with the following configurations:

9kHz-1000MHz:

Frequency Range	RBW	Video B/W	IF B/W	Measurement
9 kHz – 150 kHz	300 Hz	1 kHz	200 Hz	QP/AV
150 kHz – 30 MHz	10 kHz	30 kHz	9 kHz	QP/AV
30 MHz – 1000 MHz	100 kHz	300 kHz	---	PK
	---	---	120 kHz	QP

1GHz- 25GHz:

Measurement	Duty cycle	RBW	Video B/W
PK	Any	1MHz	3 MHz
Ave.	>98%	1MHz	10 Hz
	<98%	1MHz	≥1/T

Note: T is minimum transmission duration

If the maximized peak measured value complies with under the QP/Average limit more than 6dB, then it is unnecessary to perform an QP/Average measurement.

3.2.4 Test Procedure

Maximizing procedure was performed on the highest emissions to ensure that the EUT complied with all installation combinations.

Data was recorded in Quasi-peak detection mode for frequency range of 30 MHz-1 GHz, peak and Average detection modes for frequencies above 1 GHz.

All emissions under the average limit and under the noise floor have not recorded in the report.

3.2.5 Corrected Amplitude & Margin Calculation

The basic equation is as follows:

Result = Reading + Factor

Factor = Antenna Factor + Cable Loss- Amplifier Gain

The “**Margin**” column of the following data tables indicates the degree of compliance within the applicable limit. The equation for margin calculation is as follows:

Margin = Limit – Result

3.3 Minimum 6 dB Bandwidth

3.3.1 Applicable Standard

FCC §15.247 (a)(2)

Systems using digital modulation techniques may operate in the 902-928 MHz, 2400-2483.5 MHz, and 5725-5850 MHz bands. The minimum 6 dB bandwidth shall be at least 500 kHz.

3.3.2 EUT Setup

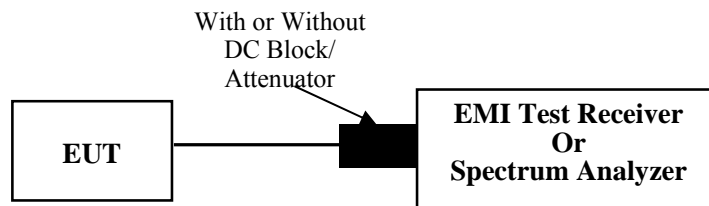

3.3.3 Test Procedure

According to ANSI C63.10-2013 Section 11.8

- a) Set RBW = 100 kHz.
- b) Set the video bandwidth (VBW) $\geq 3 \times$ RBW.
- c) Detector = Peak.
- d) Trace mode = max hold.
- e) Sweep = auto couple.
- f) Allow the trace to stabilize.
- g) Measure the maximum width of the emission that is constrained by the frequencies associated with the two outermost amplitude points (upper and lower frequencies) that are attenuated by 6 dB relative to the maximum level measured in the fundamental emission.

3.4 Maximum Conducted Output Power

3.4.1 Applicable Standard

FCC §15.247 (b)(3)

For systems using digital modulation in the 902-928 MHz, 2400-2483.5 MHz, and 5725-5850 MHz bands: 1 Watt. As an alternative to a peak power measurement, compliance with the one Watt limit can be based on a measurement of the maximum conducted output power. Maximum Conducted Output Power is defined as the total transmit power delivered to all antennas and antenna elements averaged across all symbols in the signaling alphabet when the transmitter is operating at its maximum power control level. Power must be summed across all antennas and antenna elements. The average must not include any time intervals during which the transmitter is off or is transmitting at a reduced power level. If multiple modes of operation are possible (e.g., alternative modulation methods), the maximum conducted output power is the highest total transmit power occurring in any mode.

3.4.2 EUT Setup

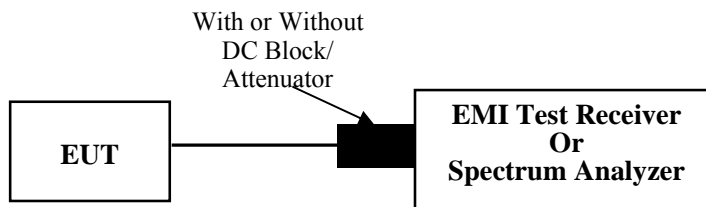

3.4.3 Test Procedure

According to ANSI C63.10-2013 Section 11.9.1.1

The following procedure shall be used when an instrument with a resolution bandwidth that is greater than the DTS bandwidth is available to perform the measurement:

- a) Set the RBW \geq DTS bandwidth.
- b) Set VBW \geq $[3 \times \text{RBW}]$.
- c) Set span \geq $[3 \times \text{RBW}]$.
- d) Sweep time = auto couple.
- e) Detector = peak.
- f) Trace mode = max hold.
- g) Allow trace to fully stabilize.
- h) Use peak marker function to determine the peak amplitude level.

3.5 Maximum Power Spectral Density

3.5.1 Applicable Standard

FCC §15.247 (e)

For digitally modulated systems, the power spectral density conducted from the intentional radiator to the antenna shall not be greater than 8 dBm in any 3 kHz band during any time interval of continuous transmission. This power spectral density shall be determined in accordance with the provisions of paragraph (b) of this section. The same method of determining the conducted output power shall be used to determine the power spectral density.

3.5.2 EUT Setup

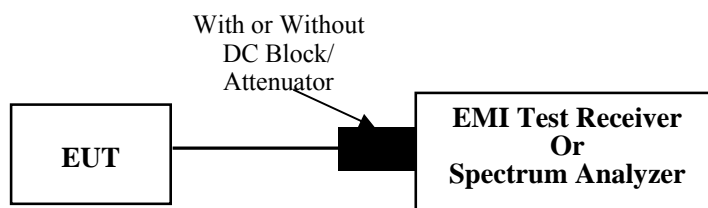

3.5.3 Test Procedure

According to ANSI C63.10-2013 Section 11.10.2

- a) Set analyzer center frequency to DTS channel center frequency.
- b) Set the span to 1.5 times the DTS bandwidth.
- c) Set the RBW to $3 \text{ kHz} \leq \text{RBW} \leq 100 \text{ kHz}$.
- d) Set the VBW $\geq [3 \times \text{RBW}]$.
- e) Detector = peak.
- f) Sweep time = auto couple.
- g) Trace mode = max hold.
- h) Allow trace to fully stabilize.
- i) Use the peak marker function to determine the maximum amplitude level within the RBW.
- j) If measured value exceeds requirement, then reduce RBW (but no less than 3 kHz) and repeat.

3.6 100 kHz Bandwidth of Frequency Band Edge

3.6.1 Applicable Standard

FCC §15.247 (d);

In any 100 kHz bandwidth outside the frequency band in which the spread spectrum or digitally modulated intentional radiator is operating, the radio frequency power that is produced by the intentional radiator shall be at least 20 dB below that in the 100 kHz bandwidth within the band that contains the highest level of the desired power, based on either an RF conducted or a radiated measurement, provided the transmitter demonstrates compliance with the peak conducted power limits. If the transmitter complies with the conducted power limits based on the use of RMS averaging over a time interval, as permitted under paragraph (b)(3) of this section, the attenuation required under this paragraph shall be 30 dB instead of 20 dB. Attenuation below the general limits specified in §15.209(a) is not required. In addition, radiated emissions which fall in the restricted bands, as defined in §15.205(a), must also comply with the radiated emission limits specified in §15.209(a) (see §15.205(c)).

3.6.2 EUT Setup

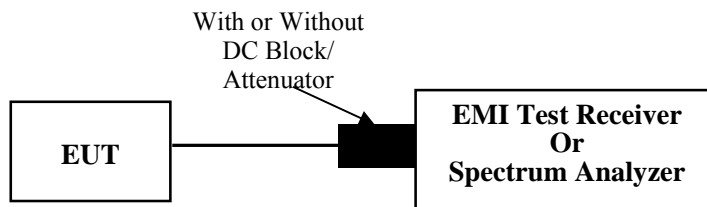

3.6.3 Test Procedure

According to ANSI C63.10-2013 Section 11.11

- a) Set the center frequency and span to encompass frequency range to be measured.
- b) Set the RBW = 100 kHz.
- c) Set the VBW $\geq [3 \times \text{RBW}]$.
- d) Detector = peak.
- e) Sweep time = auto couple.
- f) Trace mode = max hold.
- g) Allow trace to fully stabilize.
- h) Use the peak marker function to determine the maximum amplitude level.

Ensure that the amplitude of all unwanted emissions outside of the authorized frequency band (excluding restricted frequency bands) is attenuated by at least the minimum requirements specified in 11.11. Report the three highest emissions relative to the limit.

3.7 Duty Cycle

3.7.1 EUT Setup

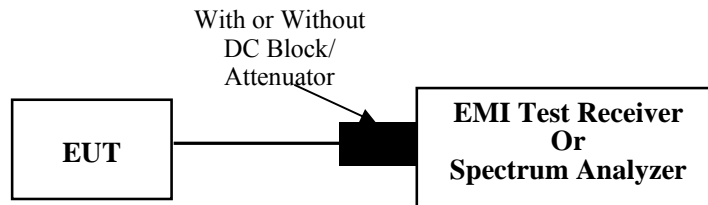

3.7.2 Test Procedure

According to ANSI C63.10-2013 Section 11.6

The zero-span mode on a spectrum analyzer or EMI receiver if the response time and spacing between bins on the sweep are sufficient to permit accurate measurements of the ON and OFF times of the transmitted signal:

- 1) Set the center frequency of the instrument to the center frequency of the transmission.
- 2) Set $RBW \geq OBW$ if possible; otherwise, set RBW to the largest available value.
- 3) Set $VBW \geq RBW$. Set detector = peak or average.
- 4) The zero-span measurement method shall not be used unless both RBW and VBW are $> 50/T$ and the number of sweep points across duration T exceeds 100. (For example, if VBW and/or RBW are limited to 3 MHz, then the zero-span method of measuring the duty cycle shall not be used if $T \leq 16.7 \mu s$.)

3.8 Antenna Requirement

3.8.1 Applicable Standard

FCC §15.203

An intentional radiator shall be designed to ensure that no antenna other than that furnished by the responsible party shall be used with the device. The use of a permanently attached antenna or of an antenna that uses a unique coupling to the intentional radiator shall be considered sufficient to comply with the provisions of this section. The manufacturer may design the unit so that a broken antenna can be replaced by the user, but the use of a standard antenna jack or electrical connector is prohibited. This requirement does not apply to carrier current devices or to devices operated under the provisions of §§15.211, 15.213, 15.217, 15.219, 15.221, or §15.236. Further, this requirement does not apply to intentional radiators that must be professionally installed, such as perimeter protection systems and some field disturbance sensors, or to other intentional radiators which, in accordance with §15.31(d), must be measured at the installation site. However, the installer shall be responsible for ensuring that the proper antenna is employed so that the limits in this part are not exceeded.

3.8.2 Judgment

Compliant. Please refer to the Antenna Information detail in Section 1.

4. Test DATA AND RESULTS

4.1 AC Line Conducted Emissions

Serial Number:	2E5M-2	Test Date:	2023/12/07
Test Site:	CE	Test Mode:	Transmitting (Tested at Lowest Channel)
Tester:	David Huang	Test Result:	Pass

Environmental Conditions:

Temperature: (°C)	25.9	Relative Humidity: (%)	42	ATM Pressure: (kPa)	101.5
----------------------	------	---------------------------	----	------------------------	-------

Test Equipment List and Details:

Manufacturer	Description	Model	Serial Number	Calibration Date	Calibration Due Date
R&S	LISN	ENV216	101134	2023/03/31	2024/03/30
R&S	EMI Test Receiver	ESR3	102726	2023/03/31	2024/03/30
MICRO-COAX	Coaxial Cable	UTIFLEX	C-0200-01	2023/08/06	2024/08/05
Audix	Test Software	E3	190306 (V9)	N/A	N/A

* Statement of Traceability: China Certification ICT Co., Ltd (Dongguan) attests that all calibrations have been performed, traceable to National Primary Standards and International System of Units (SI).

Test Data:

(Adapter 1 Power Supply mode was the worst)

Please refer to the below table and plots.

Project No.: CR231169741-RF
 Tester: David Huang
 Port: Line
 Note: Transmitting(BLE Adapter1)

Date: 2023-12-07

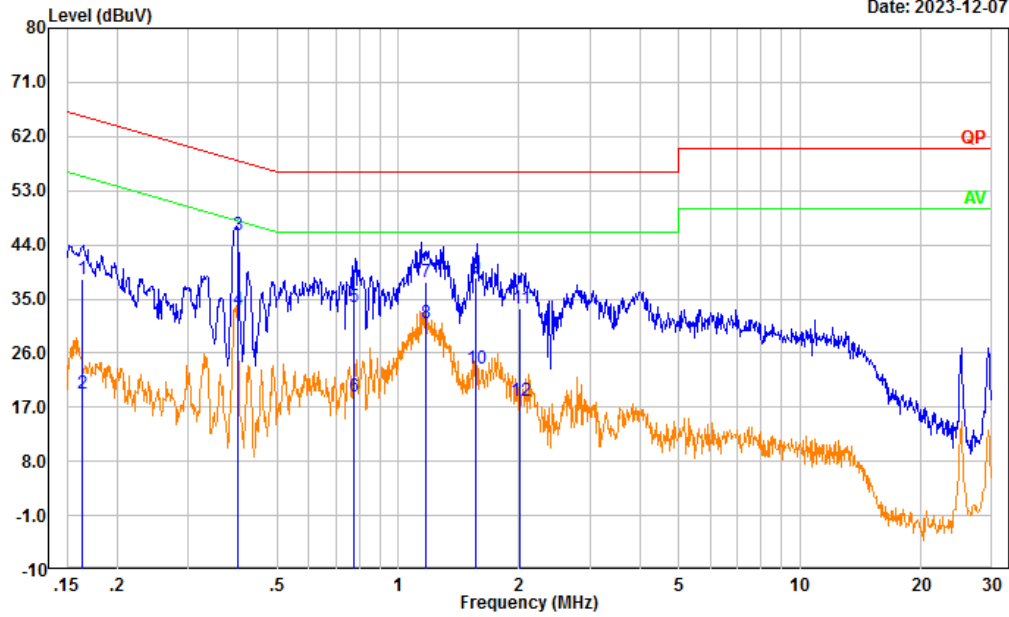

No.	Frequency (MHz)	Reading (dBuV)	Factor (dB)	Result (dBuV)	Limit (dBuV)	Margin (dB)	Detector
1	0.163	28.60	9.61	38.21	65.29	27.08	QP
2	0.163	9.74	9.61	19.35	55.29	35.94	Average
3	0.400	35.97	9.61	45.58	57.85	12.27	QP
4	0.400	23.47	9.61	33.08	47.85	14.77	Average
5	0.779	24.03	9.62	33.65	56.00	22.35	QP
6	0.779	9.26	9.62	18.88	46.00	27.12	Average
7	1.169	28.16	9.62	37.78	56.00	18.22	QP
8	1.169	21.29	9.62	30.91	46.00	15.09	Average
9	1.561	28.99	9.63	38.62	56.00	17.38	QP
10	1.561	13.78	9.63	23.41	46.00	22.59	Average
11	2.014	23.75	9.63	33.38	56.00	22.62	QP
12	2.014	8.47	9.63	18.10	46.00	27.90	Average

Project No.: CR231169741-RF
 Tester: David Huang
 Port: neutral
 Note: Transmitting(BLE Adapter1)

Date: 2023-12-07

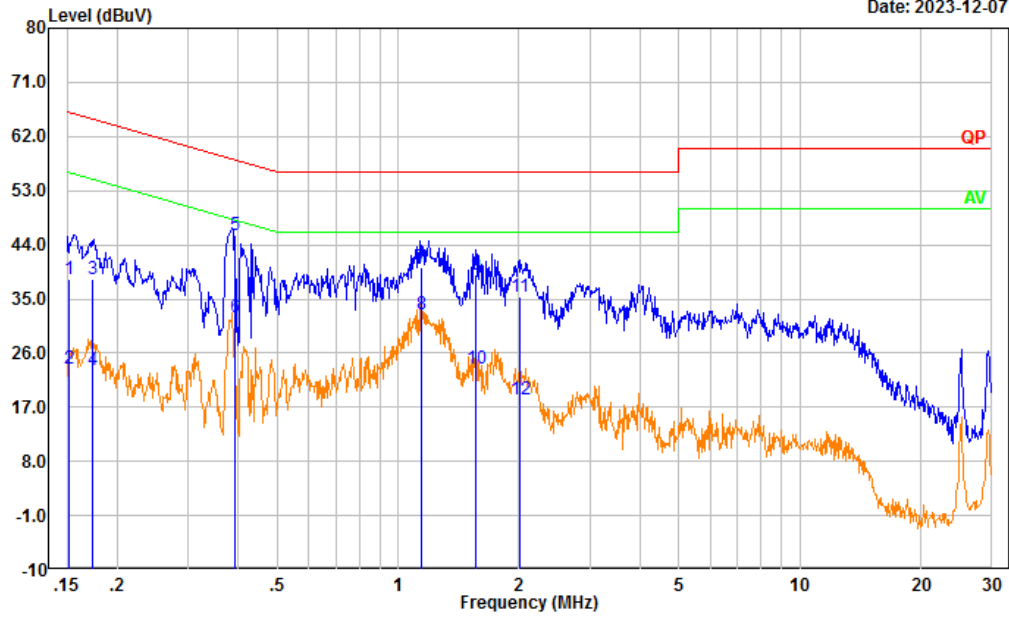

No.	Frequency (MHz)	Reading (dBuV)	Factor (dB)	Result (dBuV)	Limit (dBuV)	Margin (dB)	Detector
1	0.151	28.77	9.61	38.38	65.93	27.55	QP
2	0.151	13.79	9.61	23.40	55.93	32.53	Average
3	0.173	28.65	9.61	38.26	64.79	26.53	QP
4	0.173	13.58	9.61	23.19	54.79	31.60	Average
5	0.392	35.90	9.61	45.51	58.02	12.51	QP
6	0.392	22.31	9.61	31.92	48.02	16.10	Average
7	1.144	30.66	9.62	40.28	56.00	15.72	QP
8	1.144	22.85	9.62	32.47	46.00	13.53	Average
9	1.564	29.43	9.63	39.06	56.00	16.94	QP
10	1.564	13.83	9.63	23.46	46.00	22.54	Average
11	2.002	25.62	9.63	35.25	56.00	20.75	QP
12	2.002	8.64	9.63	18.27	46.00	27.73	Average

4.2 Radiation Spurious Emissions

Serial Number:	2E5M-2	Test Date:	2023/12/03~2023/12/05
Test Site:	966-2, 966-1	Test Mode:	Transmitting
Tester:	Carl Xue, Tao Zhu	Test Result:	Pass

Environmental Conditions:

Temperature: (°C)	25.1~25.6	Relative Humidity: (%)	41~53	ATM Pressure: (kPa)	101.4~101.6
----------------------	-----------	---------------------------	-------	------------------------	-------------

Test Equipment List and Details:

Manufacturer	Description	Model	Serial Number	Calibration Date	Calibration Due Date
Radiation Spurious Emissions Below 1GHz					
Sunol Sciences	Antenna	JB6	A082520-6	2023/09/18	2026/09/17
BACL	Loop Antenna	1313-1P	3092721	2023/10/20	2026/10/19
R&S	EMI Test Receiver	ESR3	102724	2023/03/31	2024/03/30
TIMES MICROWAVE	Coaxial Cable	LMR-600-UltraFlex	C-0470-02	2023/07/16	2024/07/15
TIMES MICROWAVE	Coaxial Cable	LMR-600-UltraFlex	C-0780-01	2023/07/16	2024/07/15
Sonoma	Amplifier	310N	186165	2023/07/16	2024/07/15
Audix	Test Software	E3	201021 (V9)	N/A	N/A
Radiation Spurious Emissions Above 1GHz					
AH	Double Ridge Guide Horn Antenna	SAS-571	1394	2023/02/22	2026/02/21
R&S	Spectrum Analyzer	FSV40	101591	2023/03/31	2024/03/30
MICRO-COAX	Coaxial Cable	UFA210A-1-1200-70U300	217423-008	2023/08/06	2024/08/05
MICRO-COAX	Coaxial Cable	UFA210A-1-2362-300300	235780-001	2023/08/06	2024/08/05
Mini	Pre-amplifier	ZVA-183-S+	5969001149	2023/11/08	2024/11/07
Audix	Test Software	E3	201021 (V9)	N/A	N/A
PASTERNAK	Horn Antenna	PE9852/2F-20	112002	2021/02/05	2024/02/04
Quinstar	Preamplifier	QLW-18405536-JO	15964001005	2023/09/15	2024/09/14
MICRO-COAX	Coaxial Cable	UFB142A-1-2362-200200	235772-001	2023/08/06	2024/08/05
E-Microwave	Band Rejection Filter	2400-2483.5MHz	OE01902424	2023/08/06	2024/08/05
Mini Circuits	High Pass Filter	VHF-6010+	31119	2023/08/06	2024/08/05

* Statement of Traceability: China Certification ICT Co., Ltd (Dongguan) attests that all calibrations have been performed, traceable to National Primary Standards and International System of Units (SI).

Test Data:

Please refer to the below table and plots.

After pre-scan in the X, Y and Z axes of orientation, the worst case is below:

1) 9kHz~30MHz

The amplitude of spurious emissions attenuated more than 20 dB below the permissible value is not required to be report.

2) 30MHz-1GHz
(Adapter 1 Power Supply mode was the worst)

BLE 1Mbps Low Channel _ Horizontal

Project No.: CR231169741-RF
 Tester: Carl Xue
 Polarization: horizontal
 Note: Transmitting(BLE 1M Low Channel Adapter1)

Date: 2023-12-03

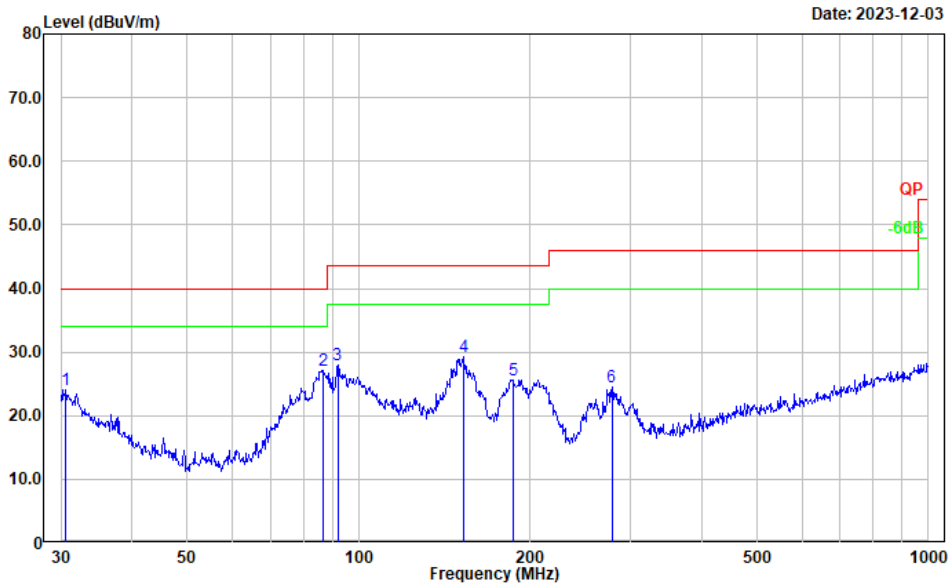

No.	Frequency (MHz)	Reading (dBμV)	Factor (dB/m)	Result (dBμV/m)	Limit (dBμV/m)	Margin (dB)	Detector
1	30.638	28.44	-4.28	24.16	40.00	15.84	Peak
2	86.807	44.31	-17.10	27.21	40.00	12.79	Peak
3	91.816	44.55	-16.50	28.05	43.50	15.45	Peak
4	152.664	41.28	-11.92	29.36	43.50	14.14	Peak
5	187.096	39.22	-13.54	25.68	43.50	17.82	Peak
6	278.067	36.35	-11.80	24.55	46.00	21.45	Peak

BLE 1Mbps Low Channel _ Vertical

Project No.: CR231169741-RF
 Tester: Carl Xue
 Polarization: vertical
 Note: Transmitting(BLE 1M Low Channel Adapter1)

Date: 2023-12-03

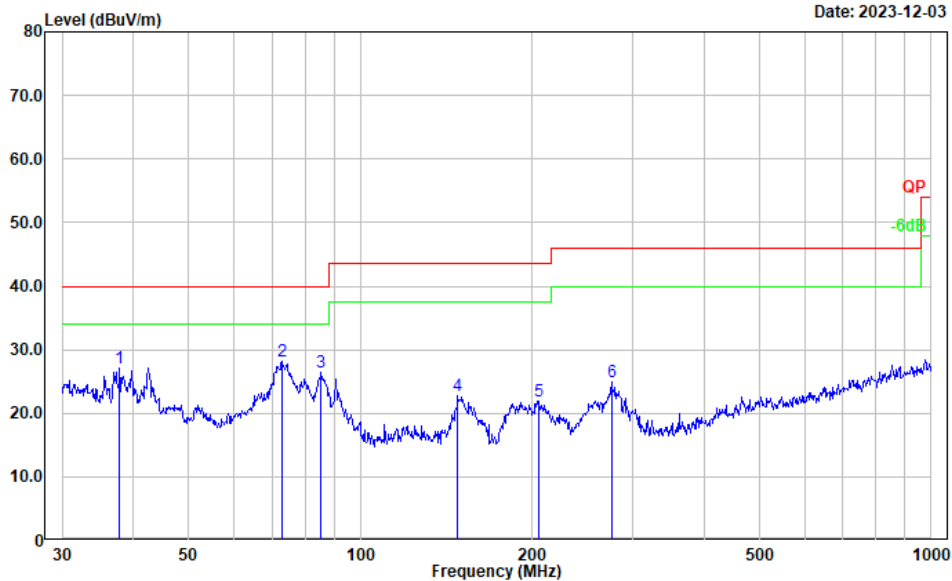

No.	Frequency (MHz)	Reading (dBμV)	Factor (dB/m)	Result (dBμV/m)	Limit (dBμV/m)	Margin (dB)	Detector
1	37.812	36.86	-9.72	27.14	40.00	12.86	Peak
2	72.847	44.93	-16.80	28.13	40.00	11.87	Peak
3	85.298	43.58	-17.19	26.39	40.00	13.61	Peak
4	147.921	34.67	-11.89	22.78	43.50	20.72	Peak
5	205.675	34.36	-12.38	21.98	43.50	21.52	Peak
6	275.157	36.90	-11.94	24.96	46.00	21.04	Peak

BLE 1Mbps Middle Channel _ Horizontal

Project No.: CR231169741-RF
 Tester: Carl Xue
 Polarization: horizontal
 Note: Transmitting(BLE 1M Middle Channel Adapter1)

Date: 2023-12-03

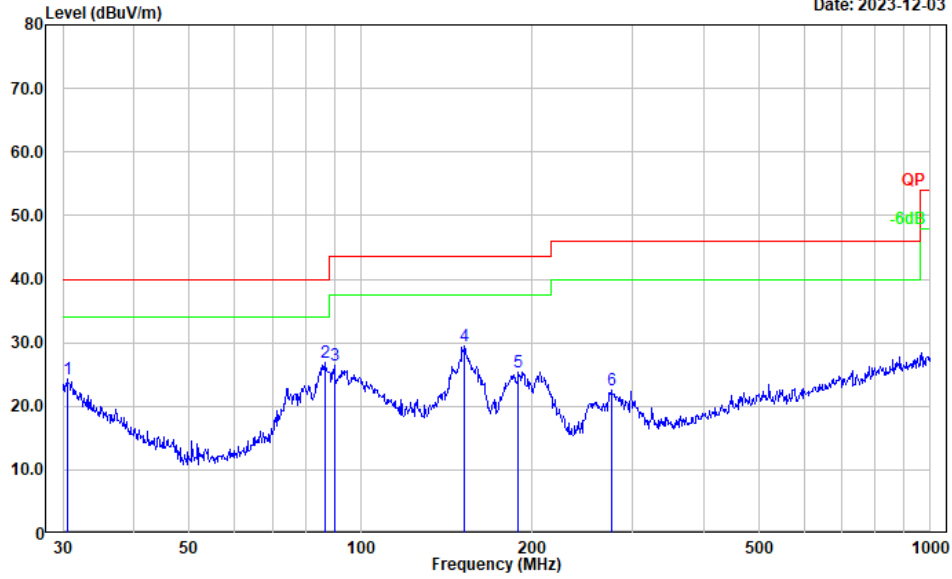

No.	Frequency (MHz)	Reading (dBuV)	Factor (dB/m)	Result (dBuV/m)	Limit (dBuV/m)	Margin (dB)	Detector
1	30.531	28.57	-4.20	24.37	40.00	15.63	Peak
2	86.807	43.97	-17.10	26.87	40.00	13.13	Peak
3	89.905	43.32	-16.93	26.39	43.50	17.11	Peak
4	152.130	41.34	-11.92	29.42	43.50	14.08	Peak
5	189.074	38.83	-13.47	25.36	43.50	18.14	Peak
6	275.157	34.54	-11.94	22.60	46.00	23.40	Peak

BLE 1Mbps Middle Channel _ Vertical

Project No.: CR231169741-RF
 Tester: Carl Xue
 Polarization: vertical
 Note: Transmitting(BLE 1M Middle Channel Adapter1)

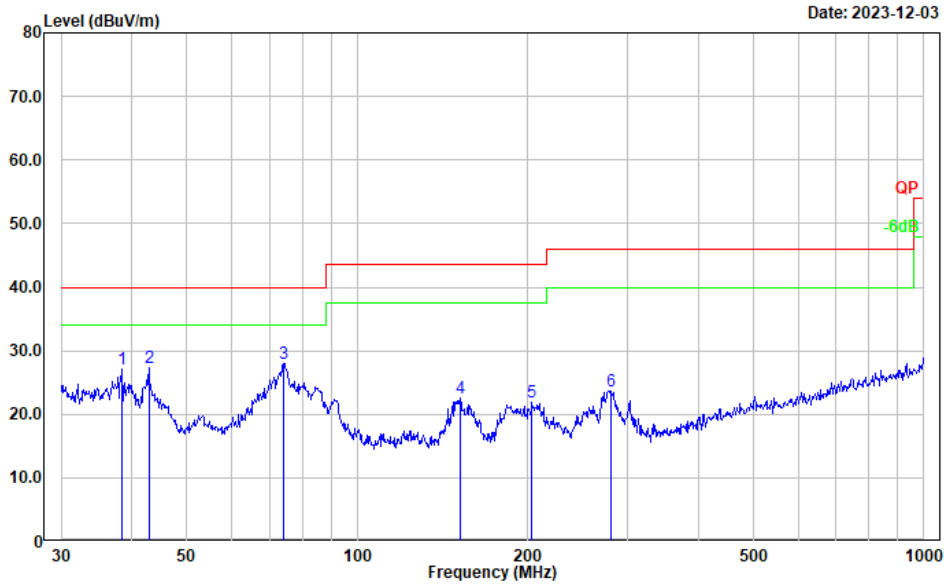

No.	Frequency (MHz)	Reading (dBμV)	Factor (dB/m)	Result (dBμV/m)	Limit (dBμV/m)	Margin (dB)	Detector
1	38.481	37.39	-10.22	27.17	40.00	12.83	Peak
2	42.900	40.44	-13.05	27.39	40.00	12.61	Peak
3	74.135	44.86	-16.96	27.90	40.00	12.10	Peak
4	151.597	34.40	-11.93	22.47	43.50	21.03	Peak
5	203.523	34.21	-12.33	21.88	43.50	21.62	Peak
6	281.008	35.34	-11.64	23.70	46.00	22.30	Peak

BLE 1Mbps High Channel _ Horizontal

Project No.: CR231169741-RF
 Tester: Carl Xue
 Polarization: horizontal
 Note: Transmitting(BLE 1M High Channel Adapter1)

Date: 2023-12-03

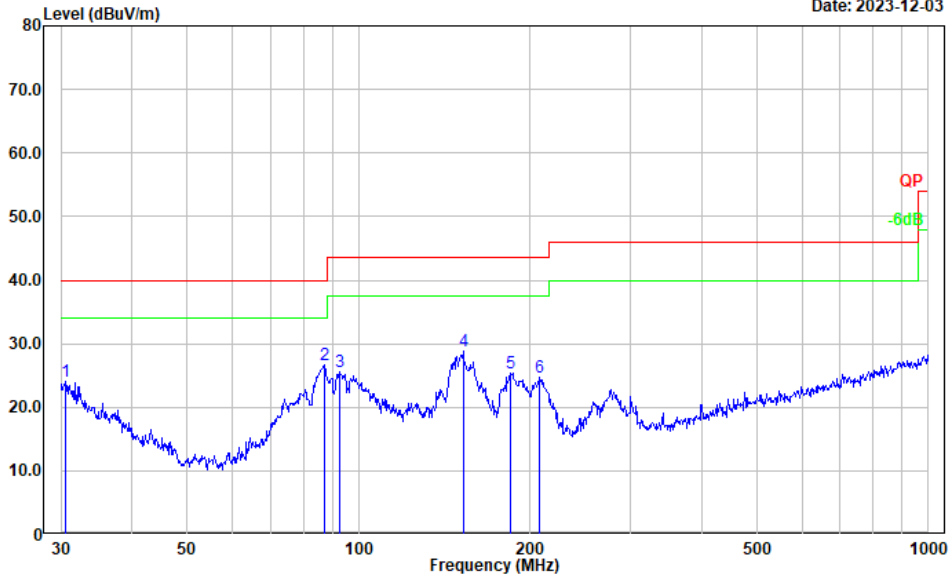

No.	Frequency (MHz)	Reading (dB μ V)	Factor (dB/m)	Result (dB μ V/m)	Limit (dB μ V/m)	Margin (dB)	Detector
1	30.638	28.29	-4.28	24.01	40.00	15.99	Peak
2	87.112	43.64	-17.08	26.56	40.00	13.44	Peak
3	92.787	41.76	-16.22	25.54	43.50	17.96	Peak
4	152.664	40.73	-11.92	28.81	43.50	14.69	Peak
5	184.490	38.86	-13.52	25.34	43.50	18.16	Peak
6	207.850	37.15	-12.45	24.70	43.50	18.80	Peak

BLE 1Mbps High Channel _ Vertical

Project No.: CR231169741-RF
 Tester: Carl Xue
 Polarization: vertical
 Note: Transmitting(BLE 1M High Channel Adapter1)

Date: 2023-12-03

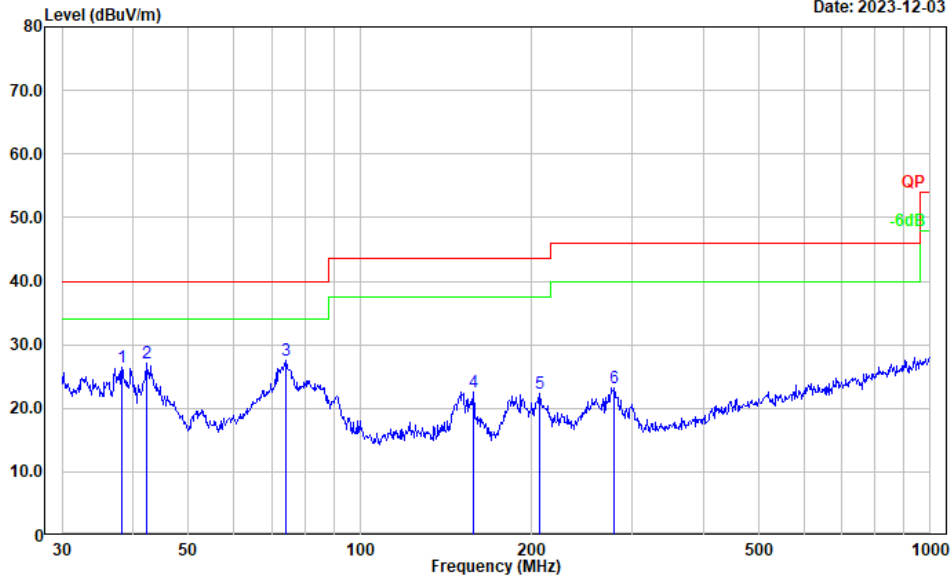

No.	Frequency (MHz)	Reading (dBμV)	Factor (dB/m)	Result (dBμV/m)	Limit (dBμV/m)	Margin (dB)	Detector
1	38.212	36.38	-10.02	26.36	40.00	13.64	Peak
2	42.154	39.77	-12.60	27.17	40.00	12.83	Peak
3	74.135	44.43	-16.96	27.47	40.00	12.53	Peak
4	158.112	34.50	-11.96	22.54	43.50	20.96	Peak
5	206.398	34.66	-12.40	22.26	43.50	21.24	Peak
6	279.044	35.04	-11.75	23.29	46.00	22.71	Peak

3) 1-25GHz:

Note: The EUT equipped with Adapter 1 was performed to 1~25GHz Radiated Emission test.

BLE 1Mbps:

Frequency (MHz)	Receiver		Polar (H/V)	Factor (dB/m)	Result (dB μ V/m)	Limit (dB μ V/m)	Margin (dB)
	Reading (dB μ V)	Detector					
Low Channel: 2402 MHz							
2390.000	26.75	PK	H	31.71	58.46	74.00	15.54
2390.000	13.69	AV	H	31.71	45.40	54.00	8.60
2390.000	26.56	PK	V	31.71	58.27	74.00	15.73
2390.000	13.47	AV	V	31.71	45.18	54.00	8.82
4804.000	34.58	PK	H	11.19	45.77	74.00	28.23
4804.000	21.34	AV	H	11.19	32.53	54.00	21.47
4804.000	34.32	PK	V	11.19	45.51	74.00	28.49
4804.000	21.30	AV	V	11.19	32.49	54.00	21.51
7206.000	34.58	PK	H	15.03	49.61	74.00	24.39
7206.000	21.47	AV	H	15.03	36.50	54.00	17.50
7206.000	34.36	PK	V	15.03	49.39	74.00	24.61
7206.000	21.42	AV	V	15.03	36.45	54.00	17.55
Middle Channel: 2440 MHz							
4880.000	34.68	PK	H	11.48	46.16	74.00	27.84
4880.000	21.44	AV	H	11.48	32.92	54.00	21.08
4880.000	34.62	PK	V	11.48	46.10	74.00	27.90
4880.000	21.29	AV	V	11.48	32.77	54.00	21.23
7320.000	34.60	PK	H	15.58	50.18	74.00	23.82
7320.000	21.38	AV	H	15.58	36.96	54.00	17.04
7320.000	34.54	PK	V	15.58	50.12	74.00	23.88
7320.000	21.36	AV	V	15.58	36.94	54.00	17.06
High Channel: 2480 MHz							
2483.500	26.84	PK	H	32.19	59.03	74.00	14.97
2483.500	13.57	AV	V	32.19	45.76	54.00	8.24
2483.500	26.63	PK	V	32.19	58.82	74.00	15.18
2483.500	13.55	AV	V	32.19	45.74	54.00	8.26
4960.000	34.69	PK	H	11.77	46.46	74.00	27.54
4960.000	21.57	AV	H	11.77	33.34	54.00	20.66
4960.000	34.39	PK	V	11.77	46.16	74.00	27.84
4960.000	21.44	AV	V	11.77	33.21	54.00	20.79
7440.000	34.37	PK	H	15.98	50.35	74.00	23.65
7440.000	21.66	AV	H	15.98	37.64	54.00	16.36
7440.000	34.35	PK	V	15.98	50.33	74.00	23.67
7440.000	21.43	AV	V	15.98	37.41	54.00	16.59

Worst Radiation Spurious Emissions Margin Test plots (BLE 1Mbps High Channel was the worst)

Horizontal

Project No.: CR231169741-RF
 Tester: Tao Zhu
 Polarization: horizontal
 Note:

Date: 2023-12-05

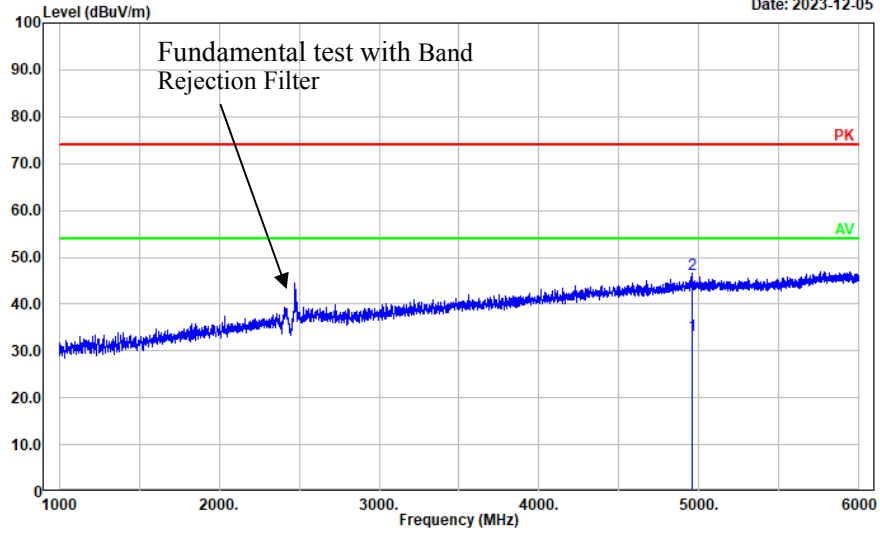

1-6GHz

No.	Frequency (MHz)	Reading (dBμV)	Factor (dB/m)	Result (dBμV/m)	Limit (dBμV/m)	Margin (dB)	Detector
1	4960.000	21.57	11.77	33.34	54.00	20.66	Average
2	4960.000	34.69	11.77	46.46	74.00	27.54	Peak

Horizontal

Project No.: CR231169741-RF
 Tester: Tao Zhu
 Polarization: horizontal
 Note:

Date: 2023-12-05

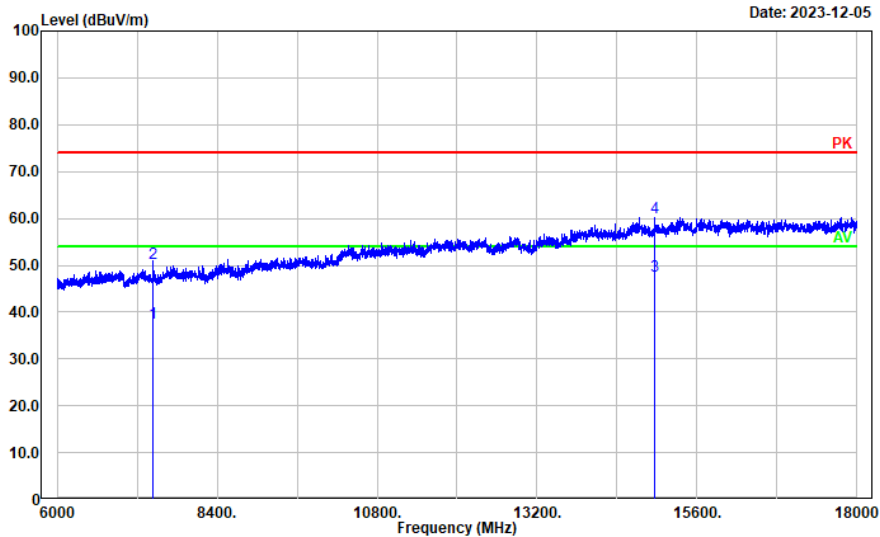

6-18GHz

No.	Frequency (MHz)	Reading (dBμV)	Factor (dB/m)	Result (dBμV/m)	Limit (dBμV/m)	Margin (dB)	Detector
1	7440.000	21.66	15.98	37.64	54.00	16.36	Average
2	7440.000	34.37	15.98	50.35	74.00	23.65	Peak
3	14960.990	22.12	25.52	47.64	54.00	6.36	Average
4	14960.990	34.59	25.52	60.11	74.00	13.89	Peak

Horizontal

Project No.: CR231169741-RF
 Tester: Tao Zhu
 Polarization: Horizontal
 Note:

Date: 2023-12-05

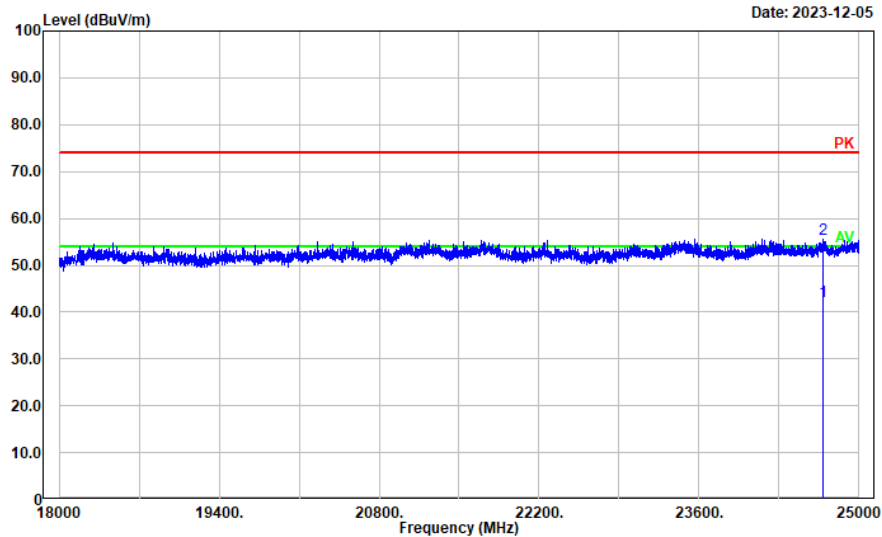

18-25GHz

No.	Frequency (MHz)	Reading (dBμV)	Factor (dB/m)	Result (dBμV/m)	Limit (dBμV/m)	Margin (dB)	Detector
1	24686.340	36.96	5.40	42.36	54.00	11.64	Average
2	24686.340	50.25	5.40	55.65	74.00	18.35	Peak

Vertical

Project No.: CR231169741-RF
 Tester: Tao Zhu
 Polarization: vertical
 Note:

Date: 2023-12-05

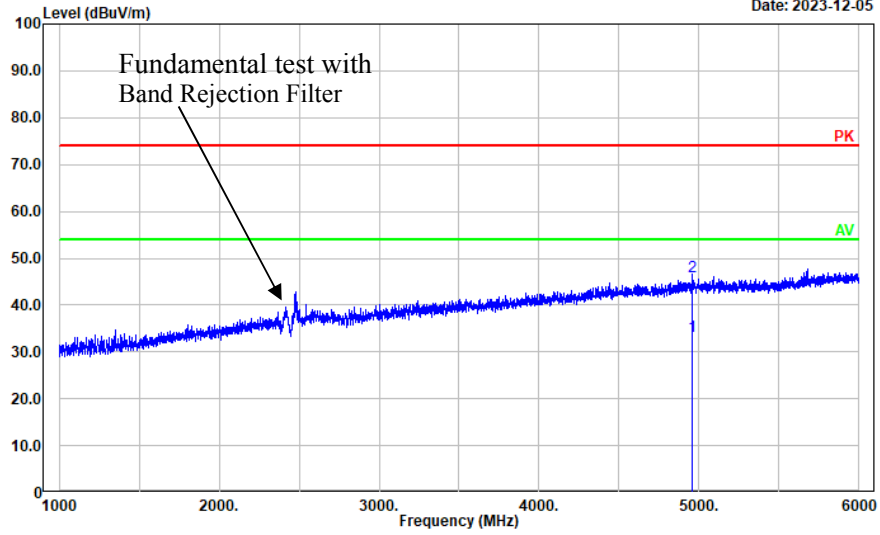

1-6GHz

No.	Frequency (MHz)	Reading (dBμV)	Factor (dB/m)	Result (dBμV/m)	Limit (dBμV/m)	Margin (dB)	Detector
1	4960.000	21.44	11.77	33.21	54.00	20.79	Average
2	4960.000	34.39	11.77	46.16	74.00	27.84	Peak

Vertical

Project No.: CR231169741-RF
 Tester: Tao Zhu
 Polarization: vertical
 Note:

Date: 2023-12-05

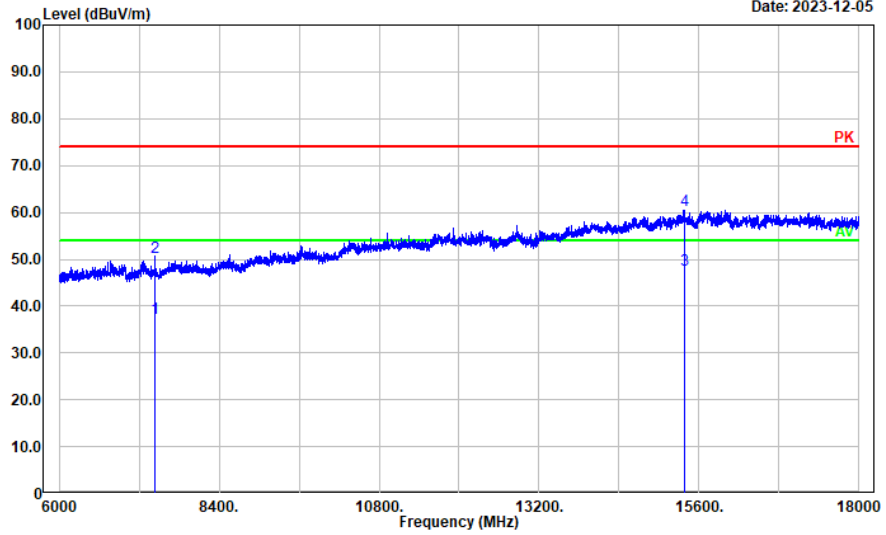

6-18GHz

No.	Frequency (MHz)	Reading (dBμV)	Factor (dB/m)	Result (dBμV/m)	Limit (dBμV/m)	Margin (dB)	Detector
1	7440.000	21.43	15.98	37.41	54.00	16.59	Average
2	7440.000	34.35	15.98	50.33	74.00	23.67	Peak
3	15383.480	22.84	24.74	47.58	54.00	6.42	Average
4	15383.480	35.74	24.74	60.48	74.00	13.52	Peak

Vertical

Project No.: CR231169741-RF
 Tester: Tao Zhu
 Polarization: vertical
 Note:

Date: 2023-12-05

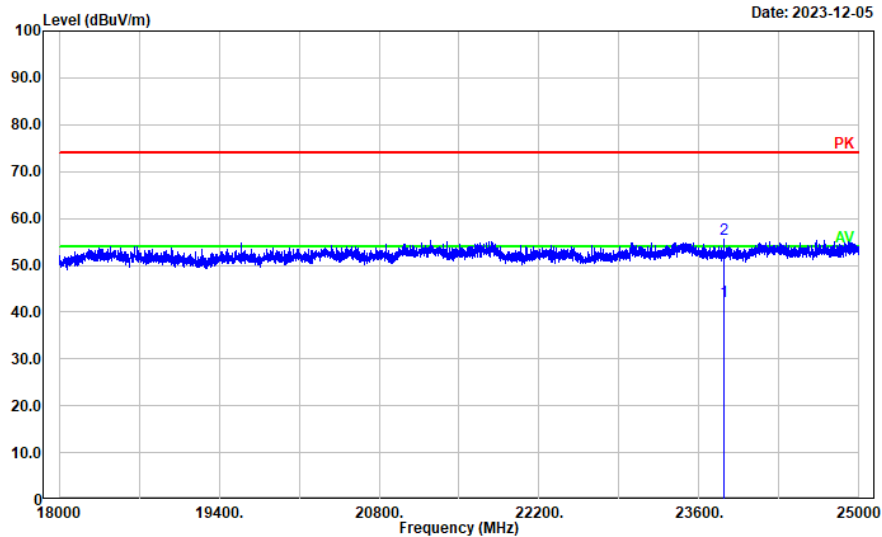

18-25GHz

No.	Frequency (MHz)	Reading (dBμV)	Factor (dB/m)	Result (dBμV/m)	Limit (dBμV/m)	Margin (dB)	Detector
1	23818.160	37.79	4.59	42.38	54.00	11.62	Average
2	23818.160	50.88	4.59	55.47	74.00	18.53	Peak

4.3 6 dB Emission Bandwidth

Serial Number:	2E5M-1	Test Date:	2023/11/28
Test Site:	RF	Test Mode:	Transmitting
Tester:	Arthur Su	Test Result:	Pass

Environmental Conditions:

Temperature: (°C)	25.3	Relative Humidity: (%)	53	ATM Pressure: (kPa)	101.3
----------------------	------	---------------------------	----	------------------------	-------

Test Equipment List and Details:

Manufacturer	Description	Model	Serial Number	Calibration Date	Calibration Due Date
R&S	Spectrum Analyzer	FSU26	200256	2023/03/31	2024/03/30
zhuoxiang	Coaxial Cable	SMA-178	211001	Each time	N/A

* Statement of Traceability: China Certification ICT Co., Ltd (Dongguan) attests that all calibrations have been performed, traceable to National Primary Standards and International System of Units (SI).

Test Data:

Test Modes	Test Frequency (MHz)	6 dB Bandwidth (MHz)	Limit (MHz)
BLE 1Mbps	2402	0.680	≥ 0.5
	2440	0.668	≥ 0.5
	2480	0.664	≥ 0.5

6dB Emission Bandwidth	
BLE 1Mbps Lowest Channel	<p>ProjectNo.:CR231169741-RF Tester:Arthur Su Date: 28.NOV.2023 19:06:23</p>
BLE 1Mbps Middle Channel	<p>ProjectNo.:CR231169741-RF Tester:Arthur Su Date: 28.NOV.2023 19:09:10</p>
BLE 1Mbps Highest Channel	<p>ProjectNo.:CR231169741-RF Tester:Arthur Su Date: 28.NOV.2023 19:07:48</p>

4.4 Maximum Conducted Output Power

Serial Number:	2E5M-1	Test Date:	2023/11/28
Test Site:	RF	Test Mode:	Transmitting
Tester:	Arthur Su	Test Result:	Pass

Environmental Conditions:

Temperature: (°C)	25.3	Relative Humidity: (%)	53	ATM Pressure: (kPa)	101.3
----------------------	------	---------------------------	----	------------------------	-------

Test Equipment List and Details:

Manufacturer	Description	Model	Serial Number	Calibration Date	Calibration Due Date
R&S	Spectrum Analyzer	FSU26	200256	2023/03/31	2024/03/30
zhuoxiang	Coaxial Cable	SMA-178	211001	Each time	N/A

* Statement of Traceability: China Certification ICT Co., Ltd (Dongguan) attests that all calibrations have been performed, traceable to National Primary Standards and International System of Units (SI).

Test Data:

Test Modes	Test Frequency (MHz)	Maximum Peak Conducted Output Power (dBm)	Limit (dBm)
BLE 1Mbps	2402	-2.02	≤30
	2440	-3.48	≤30
	2480	-3.10	≤30

Maximum Conducted Peak Output Power

BLE 1Mbps
Lowest Channel

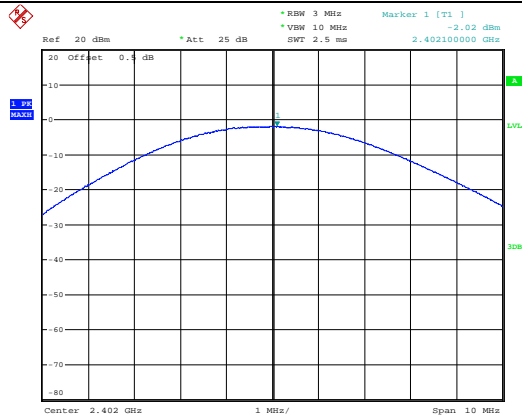

ProjectNo.:CR231169741-RF Tester:Arthur Su
Date: 28.NOV.2023 19:06:51

BLE 1Mbps
Middle Channel

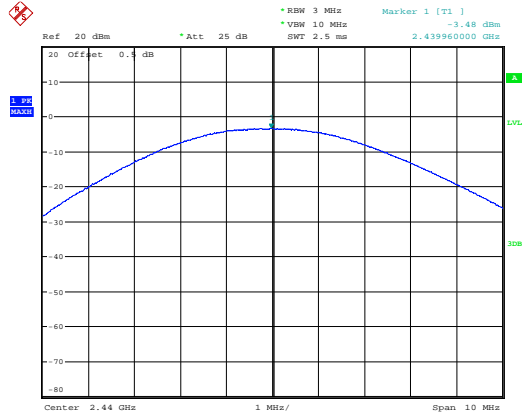

ProjectNo.:CR231169741-RF Tester:Arthur Su
Date: 28.NOV.2023 19:09:38

BLE 1Mbps
Highest Channel

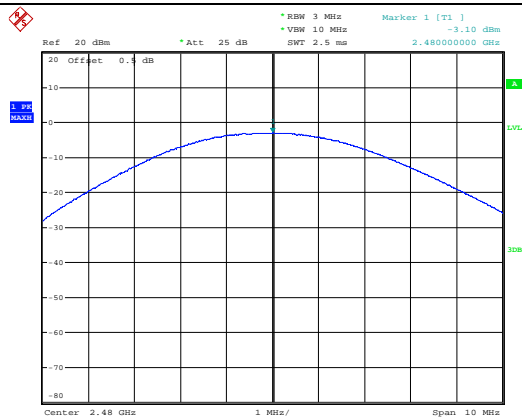

ProjectNo.:CR231169741-RF Tester:Arthur Su
Date: 28.NOV.2023 19:08:16

4.5 Maximum Power Spectral Density

Serial Number:	2E5M-1	Test Date:	2023/11/28
Test Site:	RF	Test Mode:	Transmitting
Tester:	Arthur Su	Test Result:	Pass

Environmental Conditions:

Temperature: (°C)	25.3	Relative Humidity: (%)	53	ATM Pressure: (kPa)	101.3
----------------------	------	---------------------------	----	------------------------	-------

Test Equipment List and Details:

Manufacturer	Description	Model	Serial Number	Calibration Date	Calibration Due Date
R&S	Spectrum Analyzer	FSU26	200256	2023/03/31	2024/03/30
zhuoxiang	Coaxial Cable	SMA-178	211001	Each time	N/A

* Statement of Traceability: China Certification ICT Co., Ltd (Dongguan) attests that all calibrations have been performed, traceable to National Primary Standards and International System of Units (SI).

Test Data:

Test Modes	Test Frequency (MHz)	Power Spectral Density (dBm/3kHz)	Limit (dBm/3kHz)
BLE 1Mbps	2402	-19.26	≤8.00
	2440	-20.44	≤8.00
	2480	-19.96	≤8.00

Maximum Power Spectral Density	
<p>BLE 1Mbps Lowest Channel</p>	<p>ProjectNo.:CR231169741-RF Tester:Arthur Su Date: 28.NOV.2023 19:07:01</p>
<p>BLE 1Mbps Middle Channel</p>	<p>ProjectNo.:CR231169741-RF Tester:Arthur Su Date: 28.NOV.2023 19:09:47</p>
<p>BLE 1Mbps Highest Channel</p>	<p>ProjectNo.:CR231169741-RF Tester:Arthur Su Date: 28.NOV.2023 19:08:26</p>

4.6 100 kHz Bandwidth of Frequency Band Edge

Serial Number:	2E5M-1	Test Date:	2023/11/28
Test Site:	RF	Test Mode:	Transmitting
Tester:	Arthur Su	Test Result:	Pass

Environmental Conditions:

Temperature: (°C)	25.3	Relative Humidity: (%)	53	ATM Pressure: (kPa)	101.3
----------------------	------	---------------------------	----	------------------------	-------

Test Equipment List and Details:

Manufacturer	Description	Model	Serial Number	Calibration Date	Calibration Due Date
R&S	Spectrum Analyzer	FSU26	200256	2023/03/31	2024/03/30
zhuoxiang	Coaxial Cable	SMA-178	211001	Each time	N/A

* Statement of Traceability: China Certification ICT Co., Ltd (Dongguan) attests that all calibrations have been performed, traceable to National Primary Standards and International System of Units (SI).

Test Data:

100 kHz Bandwidth of Frequency Band Edge

BLE 1Mbps
Lowest Band edge

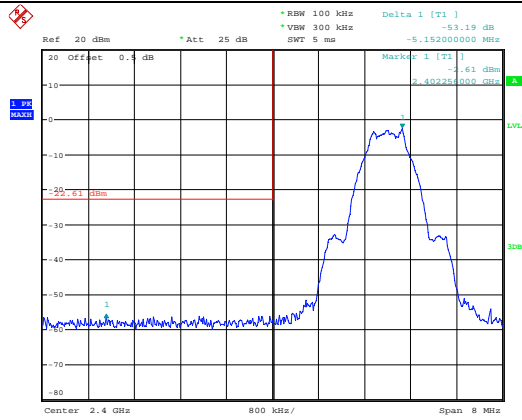

ProjectNo.:CR231169741-RF Tester:Arthur Su
 Date: 28.NOV.2023 19:07:15

BLE 1Mbps
Highest Band edge

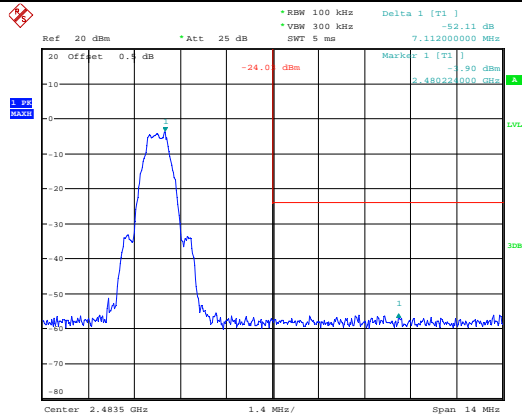

ProjectNo.:CR231169741-RF Tester:Arthur Su
 Date: 28.NOV.2023 23:04:08

4.7 Duty Cycle

Serial Number:	2E5M-1	Test Date:	2023/11/28
Test Site:	RF	Test Mode:	Transmitting
Tester:	Arthur Su	Test Result:	N/A

Environmental Conditions:

Temperature: (°C)	25.3	Relative Humidity: (%)	53	ATM Pressure: (kPa)	101.3
----------------------	------	---------------------------	----	------------------------	-------

Test Equipment List and Details:

Manufacturer	Description	Model	Serial Number	Calibration Date	Calibration Due Date
R&S	Spectrum Analyzer	FSU26	200256	2023/03/31	2024/03/30
zhuoxiang	Coaxial Cable	SMA-178	211001	Each time	N/A

* Statement of Traceability: China Certification ICT Co., Ltd (Dongguan) attests that all calibrations have been performed, traceable to National Primary Standards and International System of Units (SI).

Test Data:

Test Channel	Ton (ms)	Ton+off (ms)	Duty cycle (%)	1/T (Hz)	VBW Setting (kHz)
Middle	2.167	2.504	86.54	461	0.5

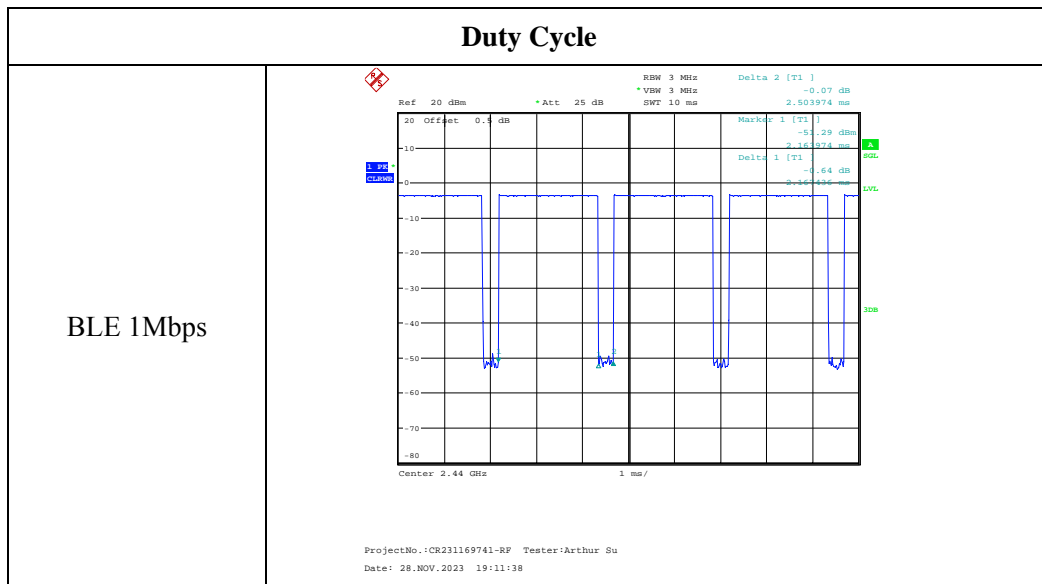

5. RF EXPOSURE EVALUATION

5.1 Applicable Standard

According to §15.247(i) and §1.1310, systems operating under the provisions of this section shall be operated in a manner that ensure that the public is not exposed to radio frequency energy level in excess of the Commission's guideline.

According to KDB447498 D01 General RF Exposure Guidance v06:

The 1-g and 10-g SAR test exclusion thresholds for 100 MHz to 6 GHz at test separation distances ≤ 50 mm are determined by:

$[(\text{max. power of channel, including tune-up tolerance, mW})/(\text{min. test separation distance, mm})] \cdot [\sqrt{f(\text{GHz})}] \leq 3.0$ for 1-g SAR and ≤ 7.5 for 10-g extremity SAR, where

- $f(\text{GHz})$ is the RF channel transmit frequency in GHz
- Power and distance are rounded to the nearest mW and mm before calculation
- The result is rounded to one decimal place for comparison
- 3.0 and 7.5 are referred to as the numeric thresholds in the step 2 below

The test exclusions are applicable only when the minimum test separation distance is ≤ 50 mm and for transmission frequencies between 100 MHz and 6 GHz. When the minimum test separation distance is < 5 mm, a distance of 5 mm according to 5) in section 4.1 is applied to determine SAR test exclusion.

5.2 Measurement Result

The max conducted power including tune-up tolerance is -2.0 dBm (0.63mW).
 $[(\text{max. power of channel, mW})/(\text{min. test separation distance, mm})][\sqrt{f(\text{GHz})}]$
 $= 0.63/5 \cdot (\sqrt{2.480}) = 0.2 < 3.0$

Result: Compliant. The stand-alone SAR evaluation is not necessary.

6. EUT PHOTOGRAPHS

Please refer to the attachment CR231169741-EXP EUT EXTERNAL PHOTOGRAPHS and CR231169741-INP EUT INTERNAL PHOTOGRAPHS

7. TEST SETUP PHOTOGRAPHS

Please refer to the attachment CR231169741-00A-TSP TEST SETUP PHOTOGRAPHS.

===== END OF REPORT =====