



中认信通

CHINA CERTIFICATION ICT CO., LTD (DONGGUAN)



TEST REPORT

Applicant: MAXWEST COMMUNICATION LIMITED

Address: FLAT/RM 707 7/F, FORTRESS TOWER 250 KING'S ROAD,NORTH POINT,
HONG KONG

FCC ID: 2ASP8ASTROA64

Product Name: Phone

**Standard(s): 47 CFR Part 2, 47 CFR Part 22, Subpart H
47 CFR Part 24, Subpart E
47 CFR Part 27**

ANSI C63.26-2015

**KDB 971168 D01 Power Meas License Digital Systems
v03r01**

KDB 971168 D02 Misc Rev Approv License Devices v02r02

The above device has been tested and found compliant with the requirement of the relative standards by
China Certification ICT Co., Ltd (Dongguan)

Report Number: CR231169741-00F

Date Of Issue: 2023/12/19

Reviewed By: Calvin Chen

Calvin Chen

Title: RF Engineer

Approved By: Sun Zhong

Sun Zhong

Title: Manager

Test Laboratory: China Certification ICT Co., Ltd (Dongguan)

No. 113, Pingkang Road, Dalang Town, Dongguan,

Guangdong, China

Tel: +86-769-82016888

Test Facility

The Test site used by China Certification ICT Co., Ltd (Dongguan) to collect test data is located on the No. 113, Pingkang Road, Dalang Town, Dongguan, Guangdong, China.

The lab has been recognized as the FCC accredited lab under the KDB 974614 D01 and is listed in the FCC Public Access Link (PAL) database, FCC Registration No. : 442868, the FCC Designation No. : CN1314.

The lab has been recognized by Innovation, Science and Economic Development Canada to test to Canadian radio equipment requirements, the CAB identifier: CN0123.

Declarations

China Certification ICT Co., Ltd (Dongguan) is not responsible for the authenticity of any test data provided by the applicant. Data included from the applicant that may affect test results are marked with a triangle symbol “▲”. Customer model name, addresses, names, trademarks etc. are not considered data.

Unless otherwise stated the results shown in this test report refer only to the sample(s) tested.

This report cannot be reproduced except in full, without prior written approval of the Company.

This report is valid only with a valid digital signature. The digital signature may be available only under the Adobe software above version 7.0.

This report may contain data that are not covered by the accreditation scope and shall be marked with an asterisk “★”.

CONTENTS

DOCUMENT REVISION HISTORY	4
1. GENERAL INFORMATION	5
1.1 PRODUCT DESCRIPTION FOR EQUIPMENT UNDER TEST (EUT)	5
1.2 DESCRIPTION OF TEST CONFIGURATION.....	6
1.2.1 EUT Operation Condition:.....	6
1.2.2 Support Equipment List and Details	10
1.2.3 Support Cable List and Details	10
1.2.4 Block Diagram of Test Setup.....	10
1.3 MEASUREMENT UNCERTAINTY	11
2. SUMMARY OF TEST RESULTS	12
3. REQUIREMENTS AND TEST PROCEDURES	13
3.1 Applicable Standard For Part 22 Subpart H.....	13
3.2 Applicable Standard For Part 24 Subpart E.....	15
3.3 Applicable Standard For Part 27.....	16
3.4 Test Method	19
4. Test DATA AND RESULTS	26
4.1 ANTENNA PORT TEST DATA AND RESULTS FOR GSM 850 BAND.....	26
4.2 ANTENNA PORT TEST DATA AND RESULTS FOR GSM 1900 BAND.....	32
4.3 ANTENNA PORT TEST DATA AND RESULTS FOR WCDMA BAND 2	38
4.4 ANTENNA PORT TEST DATA AND RESULTS FOR WCDMA BAND 4	45
4.5 ANTENNA PORT TEST DATA AND RESULTS FOR WCDMA BAND 5:.....	52
4.6 ANTENNA PORT TEST DATA AND RESULTS FOR LTE BAND 2.....	59
4.7 ANTENNA PORT TEST DATA AND RESULTS FOR LTE BAND 4.....	84
4.8 ANTENNA PORT TEST DATA AND RESULTS FOR LTE BAND 5.....	109
4.9 ANTENNA PORT TEST DATA AND RESULTS FOR LTE BAND 12.....	129
4.10 ANTENNA PORT TEST DATA AND RESULTS FOR LTE BAND 17.....	149
4.11 ANTENNA PORT TEST DATA AND RESULTS FOR LTE BAND 41.....	161
4.12 ANTENNA PORT TEST DATA AND RESULTS FOR LTE BAND 66.....	181
4.13 ANTENNA PORT TEST DATA AND RESULTS FOR LTE BAND 71.....	206
4.14 RADIATED SPURIOUS EMISSIONS.....	226
5. EUT PHOTOGRAPHS	240
6. TEST SETUP PHOTOGRAPHS	241

DOCUMENT REVISION HISTORY

Revision Number	Report Number	Description of Revision	Date of Revision
1.0	CR231169741-00F	Original Report	2023/12/19

1. GENERAL INFORMATION

1.1 Product Description for Equipment under Test (EUT)

EUT Name:	Phone
EUT Model:	ASTRO A64
Operation Bands and modes:	GSM/GPRS/EDGE: 850/1900 WCDMA: Band 2/4/5 LTE: Band 2/4/5/12/17/41/66/71
Modulation Type:	GMSK, 8PSK, BPSK, QPSK, 16QAM
Rated Input Voltage:	DC 5V from adapter (for charging) or DC 3.8V from battery
Serial Number:	2E5M-1 (for RF Conducted Test) 2E5M-2 (for Emissions Test)
EUT Received Date:	2023/11/25
EUT Received Status:	Good

Operation Voltage (V_{DC}) ▲:

Lowest:	3.6	Normal:	3.8	Highest:	4.35
---------	-----	---------	-----	----------	------

Transmission Antenna Information ▲:

Antenna Type	Operation Bands	Antenna Frequency Range (MHz)	Antenna Gain (G _T) (dBi)	L _c (dB)
FPC Antenna	GSM850	824-849	-0.27	0.1
	PCS1900	1850-1910	0.67	0.2
	WCDMA B2	1850-1910	0.67	0.2
	WCDMA B4	1710-1755	0.58	0.2
	WCDMA B5	824-849	-0.27	0.1
	LTE B2	1850-1910	0.67	0.2
	LTE B4	1710-1755	0.58	0.2
	LTE B5	824-849	-0.27	0.1
	LTE B12	699-716	-0.57	0.1
	LTE B17	704-716	-0.57	0.1
	LTE B41	2535-2655	0.88	0.4
	LTE B66	1710-1780	0.58	0.2
LTE B71	663-698	-0.57	0.1	

Note:

1. L_c= Signal Attenuation in the connecting cable between the transmitter and antenna, in dB; which declared by the manufacturer.

Accessory Information:

Accessory Description	Manufacturer	Model	Parameters
Adapter 1	MAXWEST	ASTRO A64	Input: 100-240V~50/60Hz 0.2A Output: 5.0V = 1.0A
Adapter 2	MAXWEST	HJ-0501000E1-US	Input: 100-240V~50/60Hz 0.2A Output: 5.0V = 1.0A 5.0W
USB-C Cable	/	/	Unshielded without ferrite, 1.0 Meter

1.2 Description of Test Configuration

1.2.1 EUT Operation Condition:

EUT Operation Mode:	The system was configured for testing in each operation mode.
Equipment Modifications:	No
EUT Exercise Software:	No
The maximum power was configured per 3GPP Standard for each operation modes as below setting:	
GSM/GPRS/EGPRS	
Function: Menu select > GSM Mobile Station > GSM 850/1900	
Press Connection control to choose the different menus	
Press RESET > choose all the reset all settings	
Connection Press Signal Off to turn off the signal and change settings	
Network Support > GSM + GPRS or GSM + EGSM	
Main Service > Packet Data	
Service selection > Test Mode A – Auto Slot Config. off	
MS Signal Press Slot Config Bottom on the right twice to select and change the number of time slots and power setting	
> Slot configuration > Uplink/Gamma	
> 33 dBm for GPRS 850	
> 30 dBm for GPRS 1900	
> 27 dBm for EGPRS 850	
> 26 dBm for EGPRS 1900	
BS Signal Enter the same channel number for TCH channel (test channel) and BCCH channel	
Frequency Offset > + 0 Hz	
Mode > BCCH and TCH	
BCCH Level > -85 dBm (May need to adjust if link is not stable)	
BCCH Channel > choose desire test channel [Enter the same channel number for TCH channel (test channel) and BCCH channel]	
Channel Type > Off	
P0 > 4 dB	
Slot Config > Unchanged (if already set under MS signal)	
TCH > choose desired test channel	
Hopping > Off	
Main Timeslot > 3	
Network Coding Scheme > CS4 (GPRS) and MCS5 (EGPRS)	
Bit Stream > 2E9-1 PSR Bit Stream	
AF/RF Enter appropriate offsets for Ext. Att. Output and Ext. Att. Input	
Connection Press Signal on to turn on the signal and change settings	

WCDMA

The following tests were conducted according to the test requirements outlines in section 5.2 of the 3GPP TS34.121-1 specification.

	Mode	HSUPA	HSUPA	HSUPA	HSUPA	HSUPA
	Subset	1	2	3	4	5
WCDMA General Settings	Loopback Mode	Test Mode 1				
	Rel99 RMC	12.2kbps RMC				
	HSDPA FRC	H-Set1				
	HSUPA Test	HSUPA Loopback				
	Power Control Algorithm	Algorithm2				
	β_c	11/15	6/15	15/15	2/15	15/15
	β_d	15/15	15/15	9/15	15/ 5	0
	β_{ec}	209/225	12/15	30 15	2/15	5/15
	β_c/β_d	11/15	6/15	15/9	2/15	-
	β_{hs}	22/15	12/15	30/15	4/15	5/15
CM (dB)	1.0	3.0	2.0	3.0	1.0	
PR(dB)	0	2	1	2	0	
HSDPA Specific Settings	DACK	8				
	DNAK	8				
	DCQI	8				
	Ack-Nack repetition factor	3				
	CQI Feedback	4ms				
	CQI Repetition Factor	2				
	$A_{hs}=\beta_{hs}/\beta_c$	30/15				
HSUPA Specific Settings	DE-DPCCH	6	8	8	5	7
	DHARQ	0	0	0	0	0
	AG Index	20	12	15	17	21
	ETFCI	75	67	92	71	81
	Associated Max UL Data Rate k ps	242.1	174.9	482.8	205.8	308.9
	Reference E_FCI	E-TFCI 11 E E-TFCI PO 4 E-TFCI 67 E-TFCI PO 18 E-TFCI 71 E-TFCI PO23 E-TFCI 75 E-TFCI PO26 E-TFCI 81 E-TFCI PO 27	E-TFCI 11 E-TFCI PO4 E-TFCI 92 E-TFCI PO 18	E-TFCI 11 E E-TFCI PO 4 E-TFCI 67 E-TFCI PO 18 E-TFCI 71 E-TFCI PO23 E-TFCI 75 E-TFCI PO26 E-TFCI 81 E-TFCI PO 27		

LTE (FDD):

The following tests were conducted according to the test requirements in 3GPP TS36.101

The following tests were conducted according to the test requirements outlined in section 6.2 of the 3GPP TS36.101 specification.

UE Power Class: 3 (23 +/- 2dBm). The allowed Maximum Power Reduction (MPR) for the maximum output power due to higher order modulation and transmit bandwidth configuration (resource blocks) is specified in Table 6.2.3-1 of the 3GPP TS36.101.

Table 6.2.3-1: Maximum Power Reduction (MPR) for Power Class 3

Modulation	Channel bandwidth / Transmission bandwidth (RB)						MPR (dB)
	1.4 MHz	3.0 MHz	5 MHz	10 MHz	15 MHz	20 MHz	
QPSK	> 5	> 4	> 8	> 12	> 16	> 18	≤ 1
16 QAM	≤ 5	≤ 4	≤ 8	≤ 12	≤ 16	≤ 18	≤ 1
64 QAM	> 5	> 4	> 8	> 12	> 16	> 18	≤ 2

The allowed A-MPR values specified below in Table 6.2.4.-1 of 3GPP TS36.101 are in addition to the allowed MPR requirements. All the measurements below were performed with A-MPR disabled, by using Network Signaling Value of "NS_01".

Table 6.2.4-1: Additional Maximum Power Reduction (A-MPR)

Network Signalling value	Requirements (sub-clause)	E-UTRA Band	Channel bandwidth (MHz)	Resources Blocks (N_{RB})	A-MPR (dB)
NS_01	6.6.2.1.1	Table 5.5-1	1.4, 3, 5, 10, 15, 20	Table 5.6-1	NA
NS_03	6.6.2.2.1	2, 4, 10, 23, 25, 35, 96	3	>5	≤ 1
			5	>6	≤ 1
			10	>6	≤ 1
			15	>8	≤ 1
			20	>10	≤ 1
NS_04	6.6.2.2.2	41	5	>6	≤ 1
			10, 15, 20	See Table 6.2.4-4	
NS_05	6.6.3.3.1	1	10,15,20	≥ 50	≤ 1
NS_06	6.6.2.2.3	12, 13, 14, 17	1.4, 3, 5, 10	Table 5.6-1	n/a
NS_07	6.6.2.2.3	13	10	Table 6.2.4-2	Table 6.2.4-2
	6.6.3.3.2				
NS_08	6.6.3.3.3	19	10, 15	> 44	≤ 3
NS_09	6.6.3.3.4	21	10, 15	> 40	≤ 1
				> 55	≤ 2
NS_10		20	15, 20	Table 6.2.4-3	Table 6.2.4-3
NS_11	6.6.2.2.1	23 ¹	1.4, 3, 5, 10	Table 6.2.4-5	Table 6.2.4-5
..					
NS_32	-	-	-	-	-

Note 1: Applies to the lower block of Band 23, i.e. a carrier placed in the 2000-2010 MHz region.

LTE(TDD):

Table 4.2-1: Configuration of special subframe (lengths of DwPTS/GP/UpPTS).

Special subframe configuration	Normal cyclic prefix in downlink			Extended cyclic prefix in downlink		
	DwPTS	UpPTS		DwPTS	UpPTS	
		Normal cyclic prefix in uplink	Extended cyclic prefix in uplink		Normal cyclic prefix in uplink	Extended cyclic prefix in uplink
0	$6592 \cdot T_s$	$2192 \cdot T_s$	$2560 \cdot T_s$	$7680 \cdot T_s$	$2192 \cdot T_s$	$2560 \cdot T_s$
1	$19760 \cdot T_s$			$20480 \cdot T_s$		
2	$21952 \cdot T_s$			$23040 \cdot T_s$		
3	$24144 \cdot T_s$			$25600 \cdot T_s$		
4	$26336 \cdot T_s$			$7680 \cdot T_s$		
5	$6592 \cdot T_s$	$4384 \cdot T_s$	$5120 \cdot T_s$	$20480 \cdot T_s$	$4384 \cdot T_s$	$5120 \cdot T_s$
6	$19760 \cdot T_s$			$23040 \cdot T_s$		
7	$21952 \cdot T_s$			$12800 \cdot T_s$		
8	$24144 \cdot T_s$			-		
9	$13168 \cdot T_s$			-		

Table 4.2-2: Uplink-downlink configurations.

Uplink-downlink configuration	Downlink-to-Uplink Switch-point periodicity	Subframe number										
		0	1	2	3	4	5	6	7	8	9	
0	5 ms	D	S	U	U	U	U	D	S	U	U	U
1	5 ms	D	S	U	U	D	D	S	U	U	D	
2	5 ms	D	S	U	D	D	D	S	U	D	D	
3	10 ms	D	S	U	U	U	D	D	D	D	D	
4	10 ms	D	S	U	U	D	D	D	D	D	D	
5	10 ms	D	S	U	D	D	D	D	D	D	D	
6	5 ms	D	S	U	U	U	D	S	U	U	D	

Calculated Duty Cycle

Uplink-Downlink Configuration	Downlink-to-Uplink Switch-point Periodicity	Subframe Number										Calculated Duty Cycle (%)	
		0	1	2	3	4	5	6	7	8	9		
0	5 ms	D	S	U	U	U	U	D	S	U	U	U	63.33
1	5 ms	D	S	U	U	D	D	S	U	U	D		43.33
2	5 ms	D	S	U	D	D	D	S	U	D	D		23.33
3	10 ms	D	S	U	U	U	D	D	D	D	D		31.67
4	10 ms	D	S	U	U	D	D	D	D	D	D		21.67
5	10 ms	D	S	U	D	D	D	D	D	D	D		11.67
6	5 ms	D	S	U	U	U	D	S	U	U	D		53.33

Calculated Duty Cycle = Extended cyclic prefix in uplink x (T_s) x # of S + # of U

Example for Calculated Duty Cycle for Uplink-Downlink Configuration 0:
 Calculated Duty Cycle = $5120 \times [1/(15000 \times 2048)] \times 2 + 6 \text{ ms} = 63.33\%$
 where
 T_s = 1/(15000 x 2048) seconds

1.2.2 Support Equipment List and Details

Manufacturer	Description	Model	Serial Number
IPRO	Earphone	Phonenix 5.0s	EP221126001
R&S	Wideband Radio Communication Tester	CMW500	149218
/	Antenna	/	/

1.2.3 Support Cable List and Details

Cable Description	Shielding Type	Ferrite Core	Length (m)	From Port	To
Earphone Cable	NO	NO	0.8	EUT	Earphone
USB-C Cable	NO	NO	0.8	Adapter	EUT
Coaxial Cable	Yes	NO	10	CMW500	Antenna

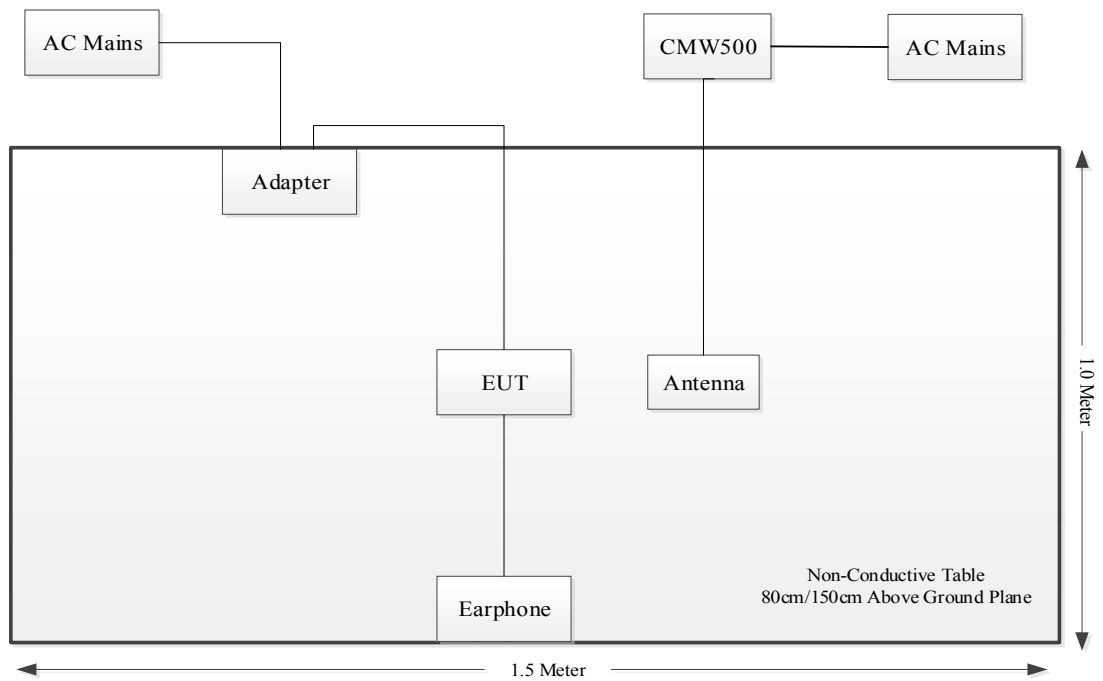
1.2.4 Block Diagram of Test Setup

1.3 Measurement Uncertainty

Otherwise required by the applicant or Product Regulations, Decision Rule in this report did not consider the uncertainty. The extended uncertainty given in this report is obtained by combining the standard uncertainty times the coverage factor K with the 95% confidence interval.

Parameter	Measurement Uncertainty
Occupied Channel Bandwidth	±5 %
RF output power, conducted	±0.61dB
Power Spectral Density, conducted	±0.61 dB
Unwanted Emissions, radiated	9kHz~30MHz: 4.12dB, 30M~200MHz: 4.15 dB, 200M~1GHz: 5.61 dB,1G~6GHz: 5.14 dB, 6G~18GHz: 5.93 dB, 18G~26.5G:5.47 dB,26.5G~40G:5.63 dB
Unwanted Emissions, conducted	±1.26 dB
Temperature	±1°C
Humidity	±5%
DC and low frequency voltages	±0.4%
Duty Cycle	1%
RF Frequency	±0.082×10 ⁻⁶

2. SUMMARY OF TEST RESULTS

Rules	Description of Test	Result
FCC§2.1046; § 22.913; § 24.232; §27.50	RF Output Power	Compliant
FCC§ 2.1047	Modulation Characteristics	Not Applicable
FCC§ 2.1049; § 22.905; § 22.917; § 24.238; §27.53	Occupied Bandwidth	Compliant
FCC§ 2.1051; § 22.917; § 24.238; §27.53	Spurious Emissions at Antenna Terminal	Compliant
FCC§ 22.917; § 24.238; §27.53	Out of band emission, Band Edge	Compliant
FCC§ 2.1055; § 22.355; § 24.235; §27.54	Frequency stability vs. temperature Frequency stability vs. voltage	Compliant
FCC§ 2.1053; § 22.917; § 24.238; §27.53	Field Strength of Spurious Radiation	Compliant

3. REQUIREMENTS AND TEST PROCEDURES

3.1 Applicable Standard For Part 22 Subpart H

3.1.1 RF Output Power

FCC §22.913

(a)(5) The ERP of mobile transmitters and auxiliary test transmitters must not exceed 7watts.

(d) *Power measurement.* Measurement of the ERP of Cellular base transmitters and repeaters must be made using an average power measurement technique. The peak-to-average ratio (PAR) of the transmission must not exceed 13 dB. Power measurements for base transmitters and repeaters must be made in accordance with either of the following:

- (1) A Commission-approved average power technique (*see* FCC Laboratory's Knowledge Database); or
- (2) For purposes of this section, peak transmit power must be measured over an interval of continuous transmission using instrumentation calibrated in terms of an rmsequivalent voltage. The measurement results shall be properly adjusted for any instrument limitations, such as detector response times, limited resolution bandwidth capability when compared to the emission bandwidth, sensitivity, *etc.*, so as to obtain a true peak measurement for the emission in question over the full bandwidth of the channel.

3.1.2 Spurious Emissions

FCC §22.917

(a) Out of band emissions. The power of any emission outside of the authorized operating frequency ranges must be attenuated below the transmitting power (P) by a factor of at least $43 + 10 \log(P)$ dB.

(b) Measurement procedure. Compliance with these rules is based on the use of measurement instrumentation employing a reference bandwidth as follows:

- (1) In the spectrum below 1 GHz, instrumentation should employ a reference bandwidth of 100 kHz or greater. In the 1 MHz bands immediately outside and adjacent to the frequency block, a resolution bandwidth of at least one percent of the emission bandwidth of the fundamental emission of the transmitter may be employed. A narrower resolution bandwidth is permitted in all cases to improve measurement accuracy, provided that the measured power is integrated over the full required reference bandwidth (i.e., 100 kHz or 1 percent of emission bandwidth, as specified). The emission bandwidth is defined as the width of the signal between two points, one below the carrier center frequency and one above the carrier center frequency, outside of which all emissions are attenuated at least 26 dB below the transmitter power.
- (2) In the spectrum above 1 GHz, instrumentation should employ a reference bandwidth of 1 MHz

3.1.3 Frequency stability

FCC §22.355

Except as otherwise provided in this part, the carrier frequency of each transmitter in the Public Mobile Services must be maintained within the tolerances given in Table C-1 of this section.

Table C-1 - Frequency Tolerance for Transmitters in the Public Mobile Services

Frequency range (MHz)	Base, fixed (ppm)	Mobile >3 watts (ppm)	Mobile \leq3 watts (ppm)
25 to 50	20	20	50
50 to 450	5	5	50
450 to 512	2.5	5	5
821 to 896	1.5	2.5	2.5
928 to 929	5	n/a	n/a
929 to 960	1.5	n/a	n/a
2110 to 2220	10	n/a	n/a

3.2 Applicable Standard For Part 24 Subpart E

3.2.1 RF Output Power

FCC §24.232

(c) Mobile and portable stations are limited to 2 watts EIRP and the equipment must employ a means for limiting power to the minimum necessary for successful communications.

(d) Power measurements for transmissions by stations authorized under this section may be made either in accordance with a Commission-approved average power technique or in compliance with paragraph (e) of this section. In both instances, equipment employed must be authorized in accordance with the provisions of § 24.51. In measuring transmissions in this band using an average power technique, the peak-to-average ratio (PAR) of the transmission may not exceed 13 dB.

3.2.2 Spurious Emissions

FCC §24.238

The rules in this section govern the spectral characteristics of emissions in the Broadband Personal Communications Service.

(a) Out of band emissions. The power of any emission outside of the authorized operating frequency ranges must be attenuated below the transmitting power (P) by a factor of at least $43 + 10 \log(P)$ dB.

(b) Measurement procedure. Compliance with these rules is based on the use of measurement instrumentation employing a resolution bandwidth of 1 MHz or greater. However, in the 1 MHz bands immediately outside and adjacent to the frequency block a resolution bandwidth of at least one percent of the emission bandwidth of the fundamental emission of the transmitter may be employed. A narrower resolution bandwidth is permitted in all cases to improve measurement accuracy provided the measured power is integrated over the full required measurement bandwidth (i.e. 1 MHz or 1 percent of emission bandwidth, as specified). The emission bandwidth is defined as the width of the signal between two points, one below the carrier center frequency and one above the carrier center frequency, outside of which all emissions are attenuated at least 26 dB below the transmitter power.

(c) Alternative out of band emission limit. Licensees in this service may establish an alternative out of band emission limit to be used at specified band edge(s) in specified geographical areas, in lieu of that set forth in this section, pursuant to a private contractual arrangement of all affected licensees and applicants. In this event, each party to such contract shall maintain a copy of the contract in their station files and disclose it to prospective assignees or transferees and, upon request, to the FCC.

(d) Interference caused by out of band emissions. If any emission from a transmitter operating in this service results in interference to users of another radio service, the FCC may require a greater attenuation of that emission than specified in this section.

3.2.3 Frequency stability

FCC §24.235

The frequency stability shall be sufficient to ensure that the fundamental emission stays within the authorized frequency block.

3.3 Applicable Standard For Part 27

3.3.1 RF Output Power

FCC §27.50

(a)(3) *Mobile and portable stations.*

(i) For mobile and portable stations transmitting in the 2305-2315 MHz band or the 2350-2360 MHz band, the average EIRP must not exceed 50 milliwatts within any 1 megahertz of authorized bandwidth, *except that* for mobile and portable stations compliant with 3GPP LTE standards or another advanced mobile broadband protocol that avoids concentrating energy at the edge of the operating band the average EIRP must not exceed 250 milliwatts within any 5 megahertz of authorized bandwidth but may exceed 50 milliwatts within any 1 megahertz of authorized bandwidth. For mobile and portable stations using time division duplexing (TDD) technology, the duty cycle must not exceed 38 percent in the 2305-2315 MHz and 2350-2360 MHz bands. Mobile and portable stations using FDD technology are restricted to transmitting in the 2305-2315 MHz band. Power averaging shall not include intervals in which the transmitter is off.

(ii) Mobile and portable stations are not permitted to transmit in the 2315-2320 MHz and 2345-2350 MHz bands.

(iii) *Automatic transmit power control.* Mobile and portable stations transmitting in the 2305-2315 MHz band or in the 2350-2360 MHz band must employ automatic transmit power control when operating so the stations operate with the minimum power necessary for successful communications.

(iv) *Prohibition on external vehicle-mounted antennas.* The use of external vehicle-mounted antennas for mobile and portable stations transmitting in the 2305-2315 MHz band or the 2350-2360 MHz band is prohibited.

(b)(10) Portable stations (hand-held devices) transmitting in the 746-757 MHz, 776-788 MHz, and 805-806 MHz bands are limited to 3 watts ERP.

(c)(10) Portable stations (hand-held devices) in the 600 MHz uplink band and the 698-746 MHz band, and fixed and mobile stations in the 600 MHz uplink band are limited to 3 watts ERP.

(d)(4) Fixed, mobile, and portable (hand-held) stations operating in the 1710-1755 MHz band and mobile and portable stations operating in the 1695-1710 MHz and 1755-1780 MHz bands are limited to 1 watt EIRP. Fixed stations operating in the 1710-1755 MHz band are limited to a maximum antenna height of 10 meters above ground. Mobile and portable stations operating in these bands must employ a means for limiting power to the minimum necessary for successful communications.

(d)(5) Equipment employed must be authorized in accordance with the provisions of § 24.51. Power measurements for transmissions by stations authorized under this section may be made either in accordance with a Commission-approved average power technique or in compliance with paragraph (d)(6) of this section. In measuring transmissions in this band using an average power technique, the peak-to-average ratio (PAR) of the transmission may not exceed 13 dB.

(h) The following power limits shall apply in the BRS and EBS:

(2) Mobile and other user stations. Mobile stations are limited to 2.0 watts EIRP. All user stations are limited to 2.0 watts transmitter output power.

3.3.2 Spurious Emissions

FCC §27.53

(a) For operations in the 2305-2320 MHz band and the 2345-2360 MHz band, the power of any emission outside a licensee's frequency band(s) of operation shall be attenuated below the transmitter power P (with averaging performed only during periods of transmission) within the licensed band(s) of operation, in watts, by the following amounts:

(4) For mobile and portable stations operating in the 2305-2315 MHz and 2350-2360 MHz bands:

(i) By a factor of not less than: $43 + 10 \log (P)$ dB on all frequencies between 2305 and 2320 MHz and on all frequencies between 2345 and 2360 MHz that are outside the licensed band(s) of operation, not less than $55 + 10 \log (P)$ dB on all frequencies between 2320 and 2324 MHz and on all frequencies between 2341 and 2345 MHz, not less than $61 + 10 \log (P)$ dB on all frequencies between 2324 and 2328 MHz and on all frequencies between 2337 and 2341 MHz, and not less than $67 + 10 \log (P)$ dB on all frequencies between 2328 and 2337 MHz;

(ii) By a factor of not less than $43 + 10 \log (P)$ dB on all frequencies between 2300 and 2305 MHz, $55 + 10 \log (P)$ dB on all frequencies between 2296 and 2300 MHz, $61 + 10 \log (P)$ dB on all frequencies between 2292 and 2296 MHz, $67 + 10 \log (P)$ dB on all frequencies between 2288 and 2292 MHz, and $70 + 10 \log (P)$ dB below 2288 MHz;

(iii) By a factor of not less than $43 + 10 \log (P)$ dB on all frequencies between 2360 and 2365 MHz, and not less than $70 + 10 \log (P)$ dB above 2365 MHz.

(c) For operations in the 746-758 MHz band and the 776-788 MHz band, the power of any emission outside the licensee's frequency band(s) of operation shall be attenuated below the transmitter power (P) within the licensed band(s) of operation, measured in watts, in accordance with the following:

(1) On any frequency outside the 746-758 MHz band, the power of any emission shall be attenuated outside the band below the transmitter power (P) by at least $43 + 10 \log (P)$ dB;

(2) On any frequency outside the 776-788 MHz band, the power of any emission shall be attenuated outside the band below the transmitter power (P) by at least $43 + 10 \log (P)$ dB;

(3) On all frequencies between 763-775 MHz and 793-805 MHz, by a factor not less than $76 + 10 \log (P)$ dB in a 6.25 kHz band segment, for base and fixed stations;

(4) On all frequencies between 763-775 MHz and 793-805 MHz, by a factor not less than $65 + 10 \log (P)$ dB in a 6.25 kHz band segment, for mobile and portable stations;

(5) Compliance with the provisions of paragraphs (c)(1) and (c)(2) of this section is based on the use of measurement instrumentation employing a resolution bandwidth of 100 kHz or greater. However, in the 100 kHz bands immediately outside and adjacent to the frequency block, a resolution bandwidth of at least 30 kHz may be employed;

(6) Compliance with the provisions of paragraphs (c)(3) and (c)(4) of this section is based on the use of measurement instrumentation such that the reading taken with any resolution bandwidth setting should be adjusted to indicate spectral energy in a 6.25 kHz segment.

(f) For operations in the 746-758 MHz, 775-788 MHz, and 805-806 MHz bands, emissions in the band 1559-1610 MHz shall be limited to - 70 dBW/MHz equivalent isotropically radiated power (EIRP) for wideband signals, and - 80 dBW EIRP for discrete emissions of less than 700 Hz bandwidth. For the purpose of equipment authorization, a transmitter shall be tested with an antenna that is representative of the type that will be used with the equipment in normal operation.

(g) For operations in the 600 MHz band and the 698-746 MHz band, the power of any emission outside a licensee's frequency band(s) of operation shall be attenuated below the transmitter power (P) within the licensed band(s) of operation, measured in watts, by at least $43 + 10 \log(P)$ dB. Compliance with this provision is based on the use of measurement instrumentation employing a resolution bandwidth of 100 kilohertz or greater. However, in the 100 kilohertz bands immediately outside and adjacent to a licensee's frequency block, a resolution bandwidth of at least 30 kHz may be employed.

(h) AWS emission limits

(1) **General protection levels.** Except as otherwise specified below, for operations in the 1695-1710 MHz, 1710-1755 MHz, 1755-1780 MHz, 1915-1920 MHz, 1995-2000 MHz, 2000-2020 MHz, 2110-2155 MHz, 2155-2180 MHz, and 2180-2200 bands, the power of any emission outside a licensee's frequency block shall be attenuated below the transmitter power (P) in watts by at least $43 + 10 \log_{10}(P)$ dB.

(m)(4) For mobile digital stations, the attenuation factor shall be not less than $40 + 10 \log(P)$ dB on all frequencies between the channel edge and 5 megahertz from the channel edge, $43 + 10 \log(P)$ dB on all frequencies between 5 megahertz and X megahertz from the channel edge, and $55 + 10 \log(P)$ dB on all frequencies more than X megahertz from the channel edge, where X is the greater of 6 megahertz or the actual emission bandwidth as defined in paragraph (m)(6) of this section. In addition, the attenuation factor shall not be less than $43 + 10 \log(P)$ dB on all frequencies between 2490.5 MHz and 2496 MHz and $55 + 10 \log(P)$ dB at or below 2490.5 MHz. Mobile Satellite Service licensees operating on frequencies below 2495 MHz may also submit a documented interference complaint against BRS licensees operating on channel BRS Channel 1 on the same terms and conditions as adjacent channel BRS or EBS licensees.

3.3.3 Frequency stability

FCC §27.54

The frequency stability shall be sufficient to ensure that the fundamental emissions stay within the authorized bands of operation.

3.4 Test Method

3.4.1 Transmitter output power, e.r.p. and e.i.r.p

According to CFR Part 2.1046, ANSI C63.26-2015 Section 5.2.5.5 and KDB 971168 D01 Power Meas License Digital Systems v03r01:

The relevant equation for determining the ERP or EIRP from the conducted RF output power measured using the guidance provided above is:

$$\text{ERP or EIRP} = P_{\text{Meas}} + G_T - L_C$$

where:

ERP or EIRP = effective radiated power or equivalent isotropically radiated power, respectively
(expressed in the same units as P_{Meas} , typically dBW or dBm);

P_{Meas} = measured transmitter output power or PSD, in dBm or dBW;

G_T = gain of the transmitting antenna, in dBd (ERP) or dBi (EIRP);

L_C = signal attenuation in the connecting cable between the transmitter and antenna, in dB.

Test Setup Block:

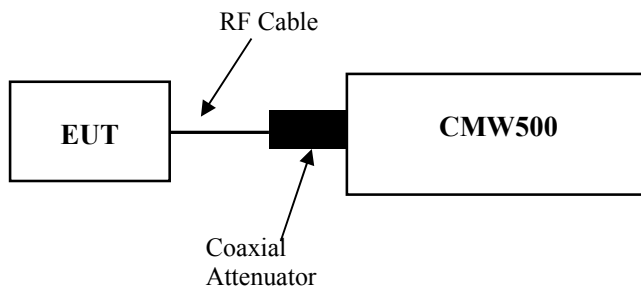

Note: The Insertion loss of the RF cable and coaxial Attenuator was offset into the Reading of CMW500.

3.4.2 Occupied Bandwidth

According to ANSI C63.26-2015 Section 5.4.4

The OBW is the frequency bandwidth such that, below its lower and above its upper frequency limits, the mean powers are each equal to 0.5% of the total mean power of the given emission.

The following procedure shall be used for measuring (99%) power bandwidth:

- a) The spectrum analyzer center frequency is set to the nominal EUT channel center frequency. The frequency span for the spectrum analyzer shall be set wide enough to capture all modulation products including the emission skirts (typically a span of $1.5 \times \text{OBW}$ is sufficient).
- b) The nominal IF filter 3 dB bandwidth (RBW) shall be in the range of 1% to 5% of the anticipated OBW, and the VBW shall be set $\geq 3 \times \text{RBW}$.
- c) Set the reference level of the instrument as required to prevent the signal amplitude from exceeding the maximum spectrum analyzer input mixer level for linear operation. See guidance provided in 4.2.3.
NOTE—Step a), step b), and step c) may require iteration to adjust within the specified tolerances.
- d) Set the detection mode to peak, and the trace mode to max-hold.
- e) If the instrument does not have a 99% OBW function, recover the trace data points and sum directly in linear power terms. Place the recovered amplitude data points, beginning at the lowest frequency, in a running sum until 0.5% of the total is reached. Record that frequency as the lower OBW frequency. Repeat the process until 99.5% of the total is reached and record that frequency as the upper OBW frequency. The 99% power OBW can be determined by computing the difference these two frequencies.
- f) The OBW shall be reported and plot(s) of the measuring instrument display shall be provided with the test report. The frequency and amplitude axis and scale shall be clearly labeled. Tabular data can be reported in addition to the plot(s).

Test Setup Block:

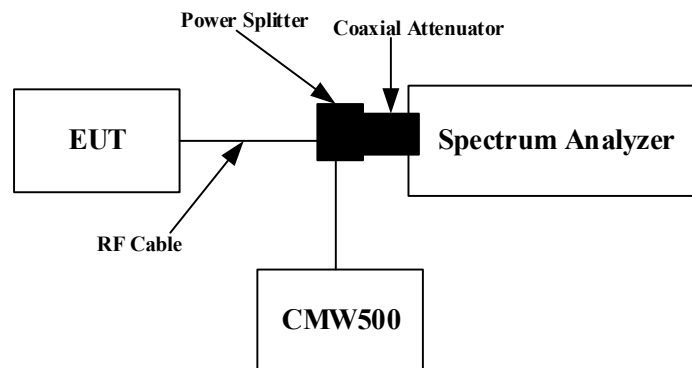

3.4.3 Transmitter unwanted emissions-at antenna terminals

According to ANSI C63.26-2015 Section 5.7.4, KDB 971168 D01 Power Meas License Digital Systems v03r01:

the applicable rule part specifies the reference bandwidth for measuring unwanted emission levels (typically, 100 kHz if the authorized frequency band/block is at or below 1 GHz and 1 MHz if the authorized frequency band/block is above 1 GHz),8 effectively depicting the unwanted emission limit in terms of a power spectral density. In those cases where no reference bandwidth is explicitly specified, the values in the preceding sentence should be used.

Test Setup Block:

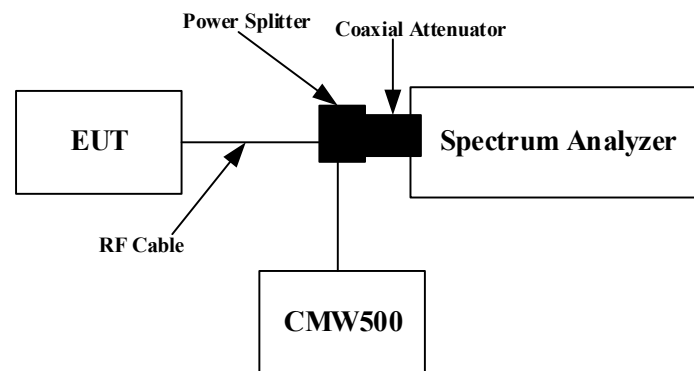

3.4.4 Transmitter unwanted emissions-Out of band emission

According to ANSI C63.26-2015 Section 5.7.3, KDB 971168 D01 Power Meas License Digital Systems v03r01:

Typically, a measurement (resolution) bandwidth smaller than the reference bandwidth is allowed for measurements within a specified frequency range at the edge of the authorized frequency block/band (e.g., within the first Y MHz outside of the authorized frequency band/block, where the value of Y is specified in the relevant rule part). Some FCC out-of-band emission rules permit the use of a narrower RBW (typically limited to a minimum RBW of 1 % of the OBW) for measuring the out-of-band emissions without a requirement to integrate the result over the full reference bandwidth. Beyond the specified frequency range in which this relaxation of the uniform reference bandwidth is permitted, it typically is also acceptable to use a narrower RBW (again limited to a minimum of 1 % of OBW) to increase accuracy, but the measurement result must subsequently be integrated over the full reference bandwidth.

Test Setup Block:

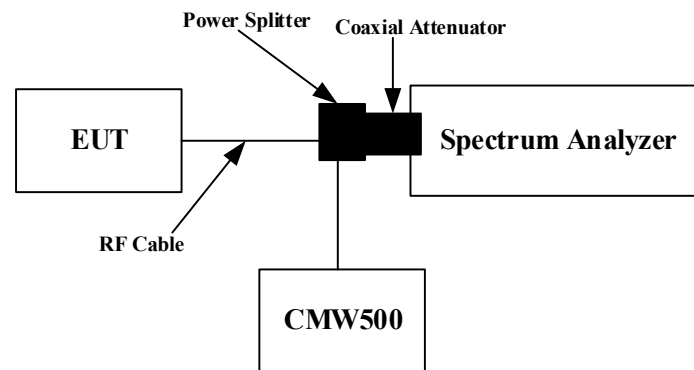

3.4.5 Frequency stability

According to ANSI C63.26-2015 Section 5.6, KDB 971168 D01 Power Meas License Digital Systems v03r01:

Frequency stability is a measure of the frequency drift due to temperature and supply voltage variations, with reference to the frequency measured at +20 °C and rated supply voltage.

The operating carrier frequency shall be set up in accordance with the manufacturer's published operation and instruction manual prior to the commencement of these tests. No adjustment of any frequency determining circuit element shall be made subsequent to this initial set-up. Frequency stability is tested:

- a) At 10 °C intervals of temperatures between –30 °C and +50 °C at the manufacturer's rated supply voltage, and
- b) At +20 °C temperature and ±15% supply voltage variations. If a product is specified to operate over a range of input voltage then the –15% variation is applied to the lowermost voltage and the +15% is applied to the uppermost voltage.

During the test all necessary settings, adjustments and control of the EUT have to be performed without disturbing the test environment, i.e., without opening the environmental chamber. The frequency stabilities can be maintained to a lesser temperature range provided that the transmitter is automatically inhibited from operating outside the lesser temperature range. For handheld equipment that is only capable of operating from internal batteries and the supply voltage cannot be varied, the frequency stability tests shall be performed at the nominal battery voltage and the battery end point voltage specified by the manufacturer. An external supply voltage can be used and set at the internal battery nominal voltage, and again at the battery operating end point voltage which shall be specified by the equipment manufacturer.

If an unmodulated carrier is not available, the mean frequency of a modulated carrier can be obtained by using a frequency counter with gating time set to an appropriately large multiple of bit periods (gating time depending on the required accuracy). Full details on the choice of values shall be included in the test report.

Test Setup Block:

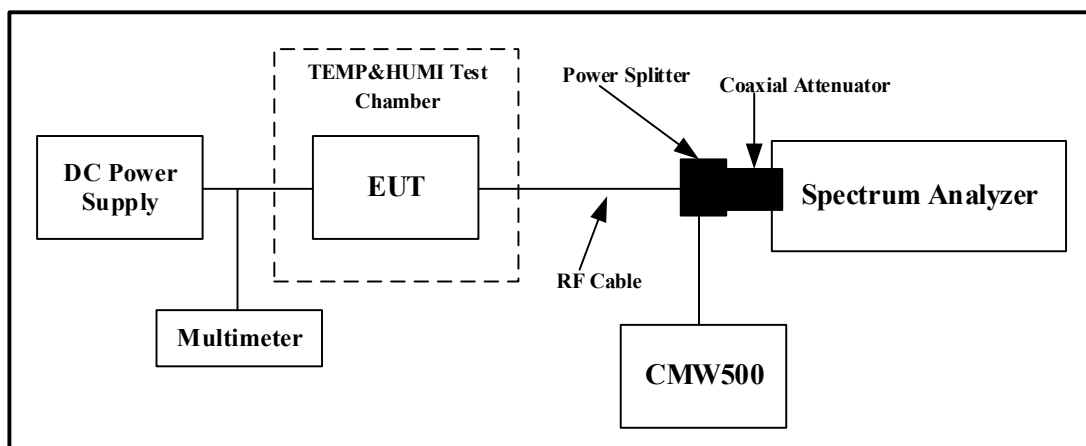

3.4.6 Transmitter unwanted emissions- Radiated Spurious emissions

According to ANSI C63.26-2015 Section 5.5.3:

Test setup:

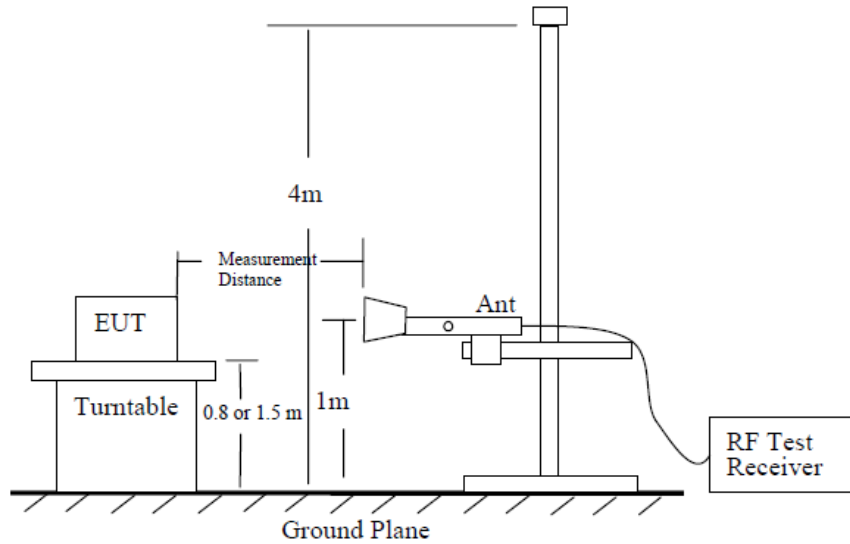

Figure 6—Test site-up for radiated ERP and/or EIRP measurements

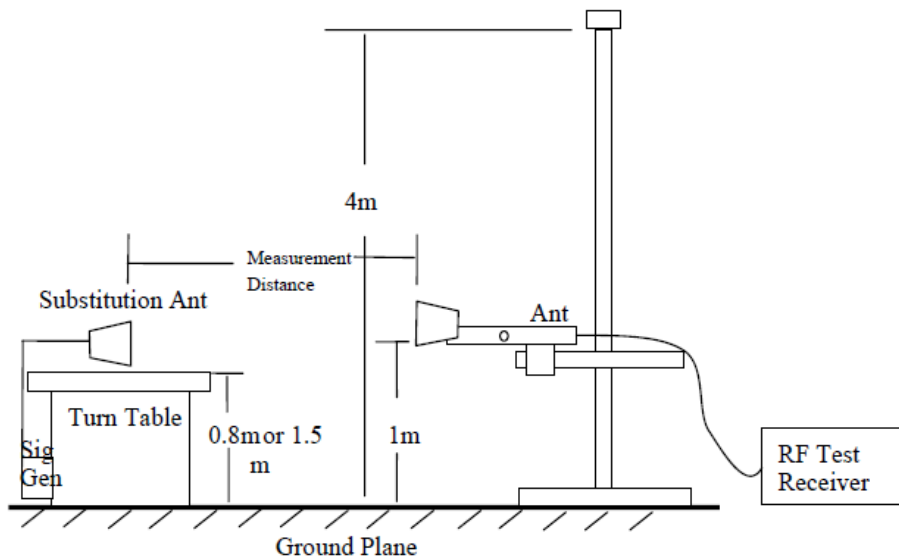

Figure 7—Substitution method set-up for radiated emission

Test Procedure:

- a) Place the EUT in the center of the turntable. The EUT shall be configured to transmit into the standard non-radiating load (for measuring radiated spurious emissions), connected with cables of minimal length unless specified otherwise. If the EUT uses an adjustable antenna, the antenna shall be positioned to the length that produces the worst case emission at the fundamental operating frequency.
- b) Each emission under consideration shall be evaluated:
 - 1) Raise and lower the measurement antenna in accordance 5.5.2, as necessary to enable detection of the maximum emission amplitude relative to measurement antenna height.
 - 2) Rotate the EUT through 360° to determine the maximum emission level relative to the axial position.
 - 3) Return the turntable to the azimuth where the highest emission amplitude level was observed.
 - 4) Vary the measurement antenna height again through 1 m to 4 m again to find the height associated with the maximum emission amplitude.
 - 5) Record the measured emission amplitude level and frequency using the appropriate RBW.
- c) Repeat step b) for each emission frequency with the measurement antenna oriented in both the horizontal and vertical polarizations to determine the orientation that gives the maximum emissions amplitude.
- d) Set-up the substitution measurement with the reference point of the substitution antenna located as near as possible to where the center of the EUT radiating element was located during the initial EUT measurement.
- e) Maintain the previous measurement instrument settings and test set-up, with the exception that the EUT is removed and replaced by the substitution antenna.
- f) Connect a signal generator to the substitution antenna; locate the signal generator so as to minimize any potential influences on the measurement results. Set the signal generator to the frequency where emissions are detected, and set an output power level such that the radiated signal can be detected by the measurement instrument, with sufficient dynamic range relative to the noise floor.
- g) For each emission that was detected and measured in the initial test [i.e., in step b) and step c)]:
 - 1) Vary the measurement antenna height between 1 m to 4 m to maximize the received (measured) signal amplitude.
 - 2) Adjust the signal generator output power level until the amplitude detected by the measurement instrument equals the amplitude level of the emission previously measured directly in step b) and step c).
 - 3) Record the output power level of the signal generator when equivalence is achieved in step 2).
- h) Repeat step e) through step g) with the measurement antenna oriented in the opposite polarization.
- i) Calculate the emission power in dBm referenced to a half-wave dipole using the following equation:

$$P_e = P_s(\text{dBm}) - \text{cable loss (dB)} + \text{antenna gain (dBd)}$$
 where
 - P_e = equivalent emission power in dBm
 - P_s = source (signal generator) power in dBm
 NOTE—dBd refers to the measured antenna gain in decibels relative to a half-wave dipole.
- j) Correct the antenna gain of the substitution antenna if necessary to reference the emission power to a half-wave dipole. When using measurement antennas with the gain specified in dBi, the equivalent dipole-referenced gain can be determined from: $\text{gain (dBd)} = \text{gain (dBi)} - 2.15 \text{ dB}$. If necessary, the antenna gain can be calculated from calibrated antenna factor information
- k) Provide the complete measurement results as a part of the test report.

4. Test DATA AND RESULTS

4.1 Antenna Port Test Data and Results for GSM 850 band

Serial Number:	2E5M-1	Test Date:	2023/12/1-2023/12/5
Test Site:	RF	Test Mode:	Transmitting
Tester:	Claire Liu/Arthur Su	Test Result:	Pass

Environmental Conditions:

Temperature: (°C)	24.3-25.8	Relative Humidity: (%)	52-61	ATM Pressure: (kPa)	101-101.4
----------------------	-----------	---------------------------	-------	------------------------	-----------

Test Equipment List and Details:

Manufacturer	Description	Model	Serial Number	Calibration Date	Calibration Due Date
R&S	Spectrum Analyzer	FSU26	200256	2023/3/31	2024/3/30
zhuoxiang	Coaxial Cable	SMA-178	211002	Each time	N/A
YINSAIGE	Coaxial Cable	SS402	SJ0100002	Each time	N/A
eastsheep	Coaxial Attenuator	2W-SMA-JK-18G	21060301	Each time	N/A
R&S	Wideband Radio Communication Tester	CMW500	143458	2023/3/31	2024/3/30
BACL	TEMP&HUMI Test Chamber	BTH-150-40	30174	2023/3/31	2024/3/30
UNI-T	Multimeter	UT39A+	C210582554	2023/9/28	2024/9/27
ZHAOXIN	DC Power Supply	RXN-6010D	21R6010D0912386	N/A	N/A
Unknown	Coaxial tee connector	Unknown	2204005	Each time	N/A

* Statement of Traceability: China Certification ICT Co., Ltd (Dongguan) attests that all calibrations have been performed, traceable to National Primary Standards and International System of Units (SI).

Test Frequency for Each Mode:

Operation Modes	Lowest Frequency (MHz)	Middle Frequency (MHz)	Highest Frequency (MHz)
GSM	824.2	836.6	848.8
GPRS	824.2	836.6	848.8
EDGE	824.2	836.6	848.8

Test Data:

RF Output Power					
Test Mode	Conducted Peak Output Power(dBm)			Maximum ERP (dBm)	ERP Limit (dBm)
	Lowest Channel	Middle Channel	Highest Channel		
GSM	32.36	32.21	31.82	29.84	38.45
GPRS 1 Slot	31.42	31.16	30.92	28.9	38.45
GPRS 2 Slots	30.52	30.26	30.07	28.00	38.45
GPRS 3 Slots	28.75	28.46	28.26	26.23	38.45
GPRS 4 Slots	27.37	27.28	26.98	24.85	38.45
EDGE 1 Slot	25.87	25.82	25.45	23.35	38.45
EDGE 2 Slots	25.66	25.57	25.21	23.14	38.45
EDGE 3 Slots	25.48	25.43	25.12	22.96	38.45
EDGE 4 Slots	25.36	25.15	24.88	22.84	38.45

Note:
 $ERP = \text{Conducted Power(dBm)} - L_c \text{ (dB)} + G_T \text{ (dBd)}$
 $G_T \text{ (dBd)} = G_T \text{ (dBi)} - 2.15$

Result:	Pass
----------------	-------------

Occupied Bandwidth

Operation Mode	99% Occupied Bandwidth (MHz)			26 dB Occupied Bandwidth (MHz)		
	Low Channel	Middle channel	High Channel	Low Channel	Middle Channel	High Channel
GSM	0.244	0.242	0.247	0.316	0.313	0.319
EDGE	0.245	0.245	0.245	0.319	0.315	0.315

Note: The test plots please refer to the Plots of Occupied Bandwidth

Spurious Emissions at Antenna Terminal

Result:	Pass, Please refer to the test plots of Spurious Emissions at Antenna Terminal.
----------------	--

Out of band emission, Band Edge

Result:	Pass, Please refer to the test plots of Out of band emission, Band Edge.
----------------	---

Frequency Stability					
Test Modulation:	GMSK		Test Channel:	836.6	MHz
Test Item	Temperature (°C)	Voltage (V _{DC})	Frequency Error		Limit
			(Hz)	(ppm)	(ppm)
Frequency Stability vs. Temperature	-30	3.8	-8.65	-0.010	2.5
	-20	3.8	-6.68	-0.008	2.5
	-10	3.8	9.77	0.012	2.5
	0	3.8	-7.62	-0.009	2.5
	10	3.8	-9.91	-0.012	2.5
	20	3.8	-9.82	-0.012	2.5
	30	3.8	-6.68	-0.008	2.5
	40	3.8	-8.86	-0.011	2.5
Frequency Stability vs. Voltage	20	3.6	6.05	0.007	2.5
	20	4.35	7.52	0.009	2.5
				Result:	Pass

Test Modulation:	8PSK		Test Channel:	836.6	MHz
Test Item	Temperature (°C)	Voltage (V _{DC})	Frequency Error		Limit
			(Hz)	(ppm)	(ppm)
Frequency Stability vs. Temperature	-30	3.8	-7.80	-0.009	2.5
	-20	3.8	-9.97	-0.012	2.5
	-10	3.8	-6.13	-0.007	2.5
	0	3.8	6.17	0.007	2.5
	10	3.8	7.92	0.009	2.5
	20	3.8	6.46	0.008	2.5
	30	3.8	-6.52	-0.008	2.5
	40	3.8	7.18	0.009	2.5
Frequency Stability vs. Voltage	20	3.6	-8.17	-0.010	2.5
	20	4.35	-7.05	-0.008	2.5
				Result:	Pass

Test Plots (Note: The 14.5 dB is the Insertion loss of the RF cable and Power Splitter, which was offset into the Spectrum Analyzer):

Occupied Bandwidth	
Channel	Modulation
Lowest	GSM
	EDGE
Middle	GSM
	EDGE
Highest	GSM
	EDGE

Spurious Emissions at Antenna Terminal

Channel	GSM	
Lowest	<p>Ref 40 dBm *Att 35 dB *RBW 100 kHz *VSW 300 kHz SWT 100 ms Marker 1 [T1] -33.91 dBm 392.78000000 MHz</p> <p>Center 515 MHz 97 MHz/ Span 970 MHz</p> <p>ProjectNo.:CR231169741-RF Tester:Arthur Su Date: 5.DEC.2023 18:33:05</p>	<p>Ref 40 dBm *Att 35 dB *RBW 1 MHz *VSW 3 MHz SWT 55 ms Marker 1 [T1] -22.35 dBm 3.134615385 GHz</p> <p>Start 1 GHz 900 MHz/ Stop 10 GHz</p> <p>ProjectNo.:CR231169741-RF Tester:Arthur Su Date: 5.DEC.2023 18:33:32</p>
Middle	<p>Ref 40 dBm *Att 35 dB *RBW 100 kHz *VSW 300 kHz SWT 100 ms Marker 1 [T1] -34.13 dBm 264.74000000 MHz</p> <p>Start 30 MHz 97 MHz/ Stop 1 GHz</p> <p>ProjectNo.:CR231169741-RF Tester:Arthur Su Date: 5.DEC.2023 18:34:16</p>	<p>Ref 40 dBm *Att 35 dB *RBW 1 MHz *VSW 3 MHz SWT 55 ms Marker 1 [T1] -23.01 dBm 3.149038462 GHz</p> <p>Start 1 GHz 900 MHz/ Stop 10 GHz</p> <p>ProjectNo.:CR231169741-RF Tester:Arthur Su Date: 5.DEC.2023 18:34:41</p>
Highest	<p>Ref 40 dBm *Att 35 dB *RBW 100 kHz *VSW 300 kHz SWT 100 ms Marker 1 [T1] -34.19 dBm 338.46000000 MHz</p> <p>Start 30 MHz 97 MHz/ Stop 1 GHz</p> <p>ProjectNo.:CR231169741-RF Tester:Arthur Su Date: 5.DEC.2023 18:35:54</p>	<p>Ref 40 dBm *Att 35 dB *RBW 1 MHz *VSW 3 MHz SWT 55 ms Marker 1 [T1] -23.73 dBm 3.149038462 GHz</p> <p>Start 1 GHz 900 MHz/ Stop 10 GHz</p> <p>ProjectNo.:CR231169741-RF Tester:Arthur Su Date: 5.DEC.2023 18:36:21</p>

Out of band emission, Band Edge

Mode	Lowest	Highest
GSM	<p>ProjectNo.:CR231169741-RF Tester:Arthur Su Date: 5.DEC.2023 18:57:16</p>	<p>ProjectNo.:CR231169741-RF Tester:Arthur Su Date: 5.DEC.2023 19:02:00</p>
EDGE	<p>ProjectNo.:CR231169741-RF Tester:Arthur Su Date: 5.DEC.2023 19:17:48</p>	<p>ProjectNo.:CR231169741-RF Tester:Arthur Su Date: 5.DEC.2023 19:23:00</p>

4.2 Antenna Port Test Data and Results for GSM 1900 band

Serial Number:	2E5M-1	Test Date:	2023/12/1-2023/12/5
Test Site:	RF	Test Mode:	Transmitting
Tester:	Claire Liu/Arthur Su	Test Result:	Pass

Environmental Conditions:

Temperature: (°C)	24.3-25.8	Relative Humidity: (%)	52-61	ATM Pressure: (kPa)	101-101.4
----------------------	-----------	---------------------------	-------	------------------------	-----------

Test Equipment List and Details:

Manufacturer	Description	Model	Serial Number	Calibration Date	Calibration Due Date
R&S	Spectrum Analyzer	FSU26	200256	2023/3/31	2024/3/30
zhuoxiang	Coaxial Cable	SMA-178	211002	Each time	N/A
YINSAIGE	Coaxial Cable	SS402	SJ0100002	Each time	N/A
eastsheep	Coaxial Attenuator	2W-SMA-JK-18G	21060301	Each time	N/A
R&S	Wideband Radio Communication Tester	CMW500	143458	2023/3/31	2024/3/30
BACL	TEMP&HUMI Test Chamber	BTH-150-40	30174	2023/3/31	2024/3/30
UNI-T	Multimeter	UT39A+	C210582554	2023/9/28	2024/9/27
ZHAOXIN	DC Power Supply	RXN-6010D	21R6010D0912386	N/A	N/A
Unknown	Coaxial tee connector	Unknown	2204005	Each time	N/A

* Statement of Traceability: China Certification ICT Co., Ltd (Dongguan) attests that all calibrations have been performed, traceable to National Primary Standards and International System of Units (SI).

Test Frequency for Each Mode:

Operation Modes	Lowest Frequency (MHz)	Middle Frequency (MHz)	Highest Frequency (MHz)
GSM	1850.2	1880	1909.8
GPRS	1850.2	1880	1909.8
EDGE	1850.2	1880	1909.8

Test Data:

RF Output Power					
Test Mode	Conducted Peak Output Power(dBm)			Maximum EIRP (dBm)	EIRP Limit (dBm)
	Lowest Channel	Middle Channel	Highest Channel		
GSM	28.61	28.64	28.48	29.11	33
GPRS 1 Slot	28.65	25.54	28.53	29.12	33
GPRS 2 Slots	27.54	27.44	27.42	28.01	33
GPRS 3 Slots	25..36	25.31	25.23	25.78	33
GPRS 4 Slots	24.21	24.25	24.11	24.72	33
EDGE 1 Slot	24.64	24.61	24.50	25.11	33
EDGE 2 Slots	24.58	24.49	24.42	25.05	33
EDGE 3 Slots	24.47	24.41	24.34	24.94	33
EDGE 4 Slots	24.33	24.32	24.20	24.80	33

Note: EIRP=Conducted Power(dBm) - Lc(dB) + Gr(dBi)

Result:	Pass
----------------	-------------

Occupied Bandwidth						
Operation Mode	99% Occupied Bandwidth (MHz)			26 dB Occupied Bandwidth (MHz)		
	Low Channel	Middle channel	High Channel	Low Channel	Middle Channel	High Channel
GSM	0.245	0.245	0.245	0.318	0.317	0.318
EDGE	0.247	0.248	0.247	0.315	0.320	0.313

Note: The test plots please refer to the Plots of Occupied Bandwidth

Spurious Emissions at Antenna Terminal	
Result:	Pass, Please refer to the test plots of Spurious Emissions at Antenna Terminal.

Out of band emission, Band Edge	
Result:	Pass, Please refer to the test plots of Out of band emission, Band Edge.

Frequency Stability						
Test Mode:	GMSK	Test Channel: Lowest for Lower Edge, Highest for Upper Edge				
Test Item	Temperature (°C)	Voltage (V _{DC})	Lower Edge (MHz)		Upper Edge (MHz)	
			Result	Limit	Result	Limit
Frequency Stability vs. Temperature	-30	3.8	1850.054	1850.000	1909.934	1910.000
	-20	3.8	1850.077	1850.000	1909.928	1910.000
	-10	3.8	1850.073	1850.000	1909.939	1910.000
	0	3.8	1850.059	1850.000	1909.943	1910.000
	10	3.8	1850.052	1850.000	1909.929	1910.000
	20	3.8	1850.078	1850.000	1909.925	1910.000
	30	3.8	1850.073	1850.000	1909.926	1910.000
	40	3.8	1850.077	1850.000	1909.929	1910.000
Frequency Stability vs. Voltage	20	3.6	1850.060	1850.000	1909.943	1910.000
	20	4.35	1850.076	1850.000	1909.946	1910.000
					Result:	Pass

Test Mode:	8PSK	Test Channel: Lowest for Lower Edge, Highest for Upper Edge				
Test Item	Temperature (°C)	Voltage (V _{DC})	Lower Edge (MHz)		Upper Edge (MHz)	
			Result	Limit	Result	Limit
Frequency Stability vs. Temperature	-30	3.8	1850.064	1850.000	1909.947	1910.000
	-20	3.8	1850.076	1850.000	1909.950	1910.000
	-10	3.8	1850.060	1850.000	1909.925	1910.000
	0	3.8	1850.054	1850.000	1909.936	1910.000
	10	3.8	1850.060	1850.000	1909.926	1910.000
	20	3.8	1850.078	1850.000	1909.925	1910.000
	30	3.8	1850.057	1850.000	1909.951	1910.000
	40	3.8	1850.073	1850.000	1909.932	1910.000
Frequency Stability vs. Voltage	20	3.6	1850.064	1850.000	1909.943	1910.000
	20	4.35	1850.061	1850.000	1909.951	1910.000
					Result:	Pass

Test Plots (Note: The 14.5 dB is the Insertion loss of the RF cable and Power Splitter, which was offset into the Spectrum Analyzer):

Occupied Bandwidth		
Channel	GSM	EDGE
Lowest	<p>ProjectNo.:CR231169741-RF Tester:Arthur Su Date: 5.DEC.2023 18:52:52</p>	<p>ProjectNo.:CR231169741-RF Tester:Arthur Su Date: 5.DEC.2023 19:05:44</p>
Middle	<p>ProjectNo.:CR231169741-RF Tester:Arthur Su Date: 5.DEC.2023 18:50:37</p>	<p>ProjectNo.:CR231169741-RF Tester:Arthur Su Date: 5.DEC.2023 19:08:15</p>
Highest	<p>ProjectNo.:CR231169741-RF Tester:Arthur Su Date: 5.DEC.2023 18:47:07</p>	<p>ProjectNo.:CR231169741-RF Tester:Arthur Su Date: 5.DEC.2023 19:12:34</p>

Spurious Emissions at Antenna Terminal

Channel	GSM	
Lowest	<p>Ref 40 dBm *Att 35 dB *RBW 100 kHz *VSW 300 kHz *SWT 100 ms Marker 1 [T1] -24.13 dBm 313.24000000 MHz</p> <p>Start 30 MHz 97 MHz/ Stop 1 GHz</p> <p>ProjectNo.:CR231169741-RF Tester:Arthur Su Date: 5.DEC.2023 18:37:46</p>	<p>Ref 40 dBm *Att 35 dB *RBW 3 MHz *VSW 3 MHz *SWT 110 ms Marker 1 [T1] -23.06 dBm 3.131410256 GHz</p> <p>Start 1 GHz 1.9 GHz/ Stop 20 GHz</p> <p>ProjectNo.:CR231169741-RF Tester:Arthur Su Date: 5.DEC.2023 18:38:12</p>
Middle	<p>Ref 40 dBm *Att 35 dB *RBW 100 kHz *VSW 300 kHz *SWT 100 ms Marker 1 [T1] -33.93 dBm 858.38000000 MHz</p> <p>Start 30 MHz 97 MHz/ Stop 1 GHz</p> <p>ProjectNo.:CR231169741-RF Tester:Arthur Su Date: 5.DEC.2023 18:38:52</p>	<p>Ref 40 dBm *Att 35 dB *RBW 3 MHz *VSW 3 MHz *SWT 110 ms Marker 1 [T1] -22.67 dBm 3.161858974 GHz</p> <p>Start 1 GHz 1.9 GHz/ Stop 20 GHz</p> <p>ProjectNo.:CR231169741-RF Tester:Arthur Su Date: 5.DEC.2023 18:39:22</p>
Highest	<p>Ref 40 dBm *Att 35 dB *RBW 100 kHz *VSW 300 kHz *SWT 100 ms Marker 1 [T1] -34.09 dBm 530.52000000 MHz</p> <p>Start 30 MHz 97 MHz/ Stop 1 GHz</p> <p>ProjectNo.:CR231169741-RF Tester:Arthur Su Date: 5.DEC.2023 18:40:03</p>	<p>Ref 40 dBm *Att 35 dB *RBW 3 MHz *VSW 3 MHz *SWT 110 ms Marker 1 [T1] -24.22 dBm 3.131410256 GHz</p> <p>Start 1 GHz 1.9 GHz/ Stop 20 GHz</p> <p>ProjectNo.:CR231169741-RF Tester:Arthur Su Date: 5.DEC.2023 18:40:44</p>

Out of band emission, Band Edge

Channel	Lowest	Highest
GSM	<p>ProjectNo.:CR231169741-RF Tester:Arthur Su Date: 5.DEC.2023 18:53:46</p>	<p>ProjectNo.:CR231169741-RF Tester:Arthur Su Date: 5.DEC.2023 18:47:47</p>
EDGE	<p>ProjectNo.:CR231169741-RF Tester:Arthur Su Date: 5.DEC.2023 19:09:23</p>	<p>ProjectNo.:CR231169741-RF Tester:Arthur Su Date: 5.DEC.2023 19:10:27</p>

4.3 Antenna Port Test Data and Results for WCDMA Band 2

Serial Number:	2E5M-1	Test Date:	2023/12/1-2023/12/5
Test Site:	RF	Test Mode:	Transmitting
Tester:	Claire Liu/Arthur Su	Test Result:	Pass

Environmental Conditions:

Temperature: (°C)	24.3-25.8	Relative Humidity: (%)	52-61	ATM Pressure: (kPa)	101-101.4
----------------------	-----------	---------------------------	-------	------------------------	-----------

Test Equipment List and Details:

Manufacturer	Description	Model	Serial Number	Calibration Date	Calibration Due Date
R&S	Spectrum Analyzer	FSU26	200256	2023/3/31	2024/3/30
zhuoxiang	Coaxial Cable	SMA-178	211002	Each time	N/A
YINSAIGE	Coaxial Cable	SS402	SJ0100002	Each time	N/A
eastsheep	Coaxial Attenuator	2W-SMA-JK-18G	21060301	Each time	N/A
R&S	Wideband Radio Communication Tester	CMW500	143458	2023/3/31	2024/3/30
BACL	TEMP&HUMI Test Chamber	BTH-150-40	30174	2023/3/31	2024/3/30
UNI-T	Multimeter	UT39A+	C210582554	2023/9/28	2024/9/27
ZHAOXIN	DC Power Supply	RXN-6010D	21R6010D0912386	N/A	N/A
Unknown	Coaxial tee connector	Unknown	2204005	Each time	N/A

* Statement of Traceability: China Certification ICT Co., Ltd (Dongguan) attests that all calibrations have been performed, traceable to National Primary Standards and International System of Units (SI).

Test Frequency for Each Mode:

Operation Modes	Lowest Frequency (MHz)	Middle Frequency (MHz)	Highest Frequency (MHz)
WCDMA Band 2	1852.4	1880	1907.6

Test Data:

RF Output Power					
Test Mode	Conducted Average Output Power(dBm)			Maximum EIRP (dBm)	EIRP Limit (dBm)
	Lowest Channel	Middle Channel	Highest Channel		
WCDMA R99	23.22	23.19	23.14	23.69	33
HSDPA Subtest 1	22.23	22.14	22.12	22.70	33
HSDPA Subtest 2	22.04	22.19	22.09	22.66	33
HSDPA Subtest 3	22.15	22.03	22.17	22.64	33
HSDPA Subtest 4	22.13	22.19	22.16	22.66	33
HSUPA Subtest 1	22.23	22.07	22.18	22.70	33
HSUPA Subtest 2	22.06	22.09	22.15	22.62	33
HSUPA Subtest 3	22.15	22.18	22.19	22.66	33
HSUPA Subtest 4	22.11	22.13	22.05	22.60	33
HSUPA Subtest 5	22.07	22.01	22.02	22.54	33

Note: EIRP=Conducted Power(dBm) - Lc(dB) + Gr(dBi)

Result:	Pass
----------------	-------------

Peak-to-average Ratio (PAR)				
Test Mode	Peak-to-average Ratio(dB)			Limit (dB)
	Lowest Channel	Middle Channel	Highest Channel	
WCDMA R99	2.85	2.95	2.50	13
HSDPA	3.81	3.91	3.85	13
HSUPA	3.81	4.33	3.72	13

Result:	Pass
----------------	-------------

Occupied Bandwidth						
Operation Mode	99% Occupied Bandwidth (MHz)			26 dB Occupied Bandwidth (MHz)		
	Low Channel	Middle channel	High Channel	Low Channel	Middle Channel	High Channel
WCDMA R99	4.183	4.183	4.199	4.744	4.721	4.760
HSDPA	4.199	4.183	4.167	4.747	4.769	4.747
HSUPA	4.183	4.199	4.199	4.763	4.747	4.731

Note: The test plots please refer to the Plots of Occupied Bandwidth

Spurious Emissions at Antenna Terminal	
Result:	Pass, Please refer to the test plots of Spurious Emissions at Antenna Terminal.

Out of band emission, Band Edge	
Result:	Pass, Please refer to the test plots of Out of band emission, Band Edge.

Frequency Stability						
Test Mode:	WCDMA R99	Test Channel: Lowest for Lower Edge, Highest for Upper Edge				
Test Item	Temperature (°C)	Voltage (V _{DC})	Lower Edge (MHz)		Upper Edge (MHz)	
			Result	Limit	Result	Limit
Frequency Stability vs. Temperature	-30	3.8	1850.286	1850.000	1909.693	1910.000
	-20	3.8	1850.285	1850.000	1909.683	1910.000
	-10	3.8	1850.292	1850.000	1909.691	1910.000
	0	3.8	1850.277	1850.000	1909.690	1910.000
	10	3.8	1850.296	1850.000	1909.700	1910.000
	20	3.8	1850.301	1850.000	1909.683	1910.000
	30	3.8	1850.291	1850.000	1909.691	1910.000
	40	3.8	1850.287	1850.000	1909.692	1910.000
	50	3.8	1850.273	1850.000	1909.684	1910.000
Frequency Stability vs. Voltage	20	3.6	1850.272	1850.000	1909.684	1910.000
	20	4.35	1850.297	1850.000	1909.688	1910.000
Result:					Pass	

Test Plots (Note: The 14.5 dB is the Insertion loss of the RF cable and Power Splitter, which was offset into the Spectrum Analyzer):

Occupied Bandwidth		
Channel	WCDMA R99	HSDPA
Lowest	<p>ProjectNo.:CR231169741-RF Tester:Arthur Su Date: 5.DEC.2023 19:27:14</p>	<p>ProjectNo.:CR231169741-RF Tester:Arthur Su Date: 5.DEC.2023 19:51:24</p>
Middle	<p>ProjectNo.:CR231169741-RF Tester:Arthur Su Date: 5.DEC.2023 19:31:23</p>	<p>ProjectNo.:CR231169741-RF Tester:Arthur Su Date: 5.DEC.2023 19:54:09</p>
Highest	<p>ProjectNo.:CR231169741-RF Tester:Arthur Su Date: 5.DEC.2023 19:33:23</p>	<p>ProjectNo.:CR231169741-RF Tester:Arthur Su Date: 5.DEC.2023 19:55:25</p>

Occupied Bandwidth

Channel

HSUPA

Lowest

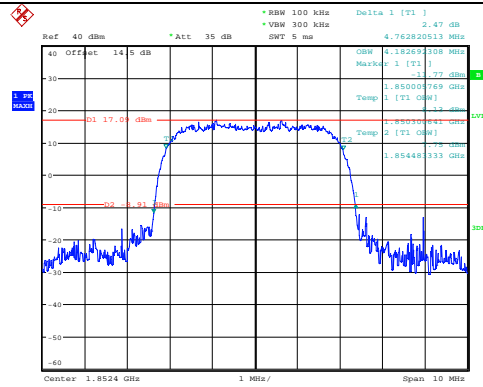

ProjectNo.:CR231169741-RF Tester:Arthur Su
 Date: 5.DEC.2023 20:22:49

Middle

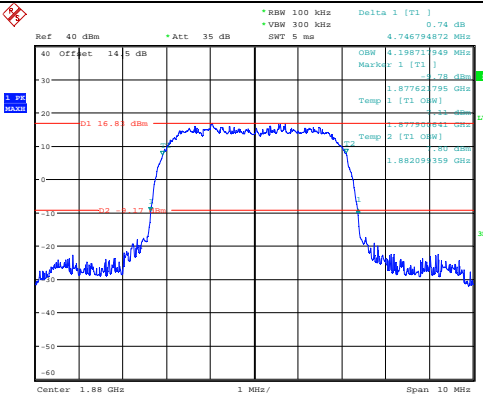

ProjectNo.:CR231169741-RF Tester:Arthur Su
 Date: 5.DEC.2023 20:25:15

Highest

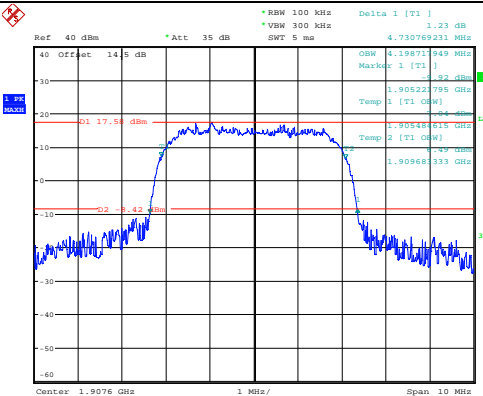

ProjectNo.:CR231169741-RF Tester:Arthur Su
 Date: 5.DEC.2023 20:26:36

Spurious Emissions at Antenna Terminal

Channel	WCDMA R99	
Lowest	<p>Ref 40 dBm *Att 35 dB *RBW 100 kHz *VSW 300 kHz *SWT 100 ms Marker 1 [T1] -23.76 dBm</p> <p>Start 30 MHz 97 MHz/ Stop 1 GHz</p> <p>ProjectNo.:CR231169741-RF Tester:Arthur Su Date: 5.DEC.2023 17:52:24</p>	<p>Ref 40 dBm *Att 35 dB *RBW 3 MHz *VSW 3 MHz *SWT 110 ms Marker 1 [T1] -23.71 dBm</p> <p>Start 1 GHz 1.9 GHz/ Stop 20 GHz</p> <p>ProjectNo.:CR231169741-RF Tester:Arthur Su Date: 5.DEC.2023 17:53:10</p>
Middle	<p>Ref 40 dBm *Att 35 dB *RBW 100 kHz *VSW 300 kHz *SWT 100 ms Marker 1 [T1] -33.87 dBm</p> <p>Start 30 MHz 97 MHz/ Stop 1 GHz</p> <p>ProjectNo.:CR231169741-RF Tester:Arthur Su Date: 5.DEC.2023 17:53:55</p>	<p>Ref 40 dBm *Att 35 dB *RBW 3 MHz *VSW 3 MHz *SWT 110 ms Marker 1 [T1] -21.97 dBm</p> <p>Start 1 GHz 1.9 GHz/ Stop 20 GHz</p> <p>ProjectNo.:CR231169741-RF Tester:Arthur Su Date: 5.DEC.2023 17:54:23</p>
Highest	<p>Ref 40 dBm *Att 35 dB *RBW 100 kHz *VSW 300 kHz *SWT 100 ms Marker 1 [T1] -33.90 dBm</p> <p>Start 30 MHz 97 MHz/ Stop 1 GHz</p> <p>ProjectNo.:CR231169741-RF Tester:Arthur Su Date: 5.DEC.2023 17:54:58</p>	<p>Ref 40 dBm *Att 35 dB *RBW 3 MHz *VSW 3 MHz *SWT 110 ms Marker 1 [T1] -24.52 dBm</p> <p>Start 1 GHz 1.9 GHz/ Stop 20 GHz</p> <p>ProjectNo.:CR231169741-RF Tester:Arthur Su Date: 5.DEC.2023 17:55:44</p>

Out of band emission, Band Edge

Mode	Lowest	Highest
R99	<p>ProjectNo.:CR231169741-RF Tester:Arthur Su Date: 5.DEC.2023 19:28:57</p>	<p>ProjectNo.:CR231169741-RF Tester:Arthur Su Date: 5.DEC.2023 19:34:04</p>
HSUPA	<p>ProjectNo.:CR231169741-RF Tester:Arthur Su Date: 5.DEC.2023 20:23:26</p>	<p>ProjectNo.:CR231169741-RF Tester:Arthur Su Date: 5.DEC.2023 20:27:02</p>
HSDPA	<p>ProjectNo.:CR231169741-RF Tester:Arthur Su Date: 5.DEC.2023 19:52:10</p>	<p>ProjectNo.:CR231169741-RF Tester:Arthur Su Date: 5.DEC.2023 19:56:08</p>

4.4 Antenna Port Test Data and Results for WCDMA Band 4

Serial Number:	2E5M-1	Test Date:	2023/12/1-2023/12/5
Test Site:	RF	Test Mode:	Transmitting
Tester:	Claire Liu/Arthur Su	Test Result:	Pass

Environmental Conditions:

Temperature: (°C)	24.3-25.8	Relative Humidity: (%)	52-61	ATM Pressure: (kPa)	101-101.4
----------------------	-----------	---------------------------	-------	------------------------	-----------

Test Equipment List and Details:

Manufacturer	Description	Model	Serial Number	Calibration Date	Calibration Due Date
R&S	Spectrum Analyzer	FSU26	200256	2023/3/31	2024/3/30
zhuoxiang	Coaxial Cable	SMA-178	211002	Each time	N/A
YINSAIGE	Coaxial Cable	SS402	SJ0100002	Each time	N/A
eastsheep	Coaxial Attenuator	2W-SMA-JK-18G	21060301	Each time	N/A
R&S	Wideband Radio Communication Tester	CMW500	143458	2023/3/31	2024/3/30
BACL	TEMP&HUMI Test Chamber	BTH-150-40	30174	2023/3/31	2024/3/30
UNI-T	Multimeter	UT39A+	C210582554	2023/9/28	2024/9/27
ZHAOXIN	DC Power Supply	RXN-6010D	21R6010D0912386	N/A	N/A
Unknown	Coaxial tee connector	Unknown	2204005	Each time	N/A

* Statement of Traceability: China Certification ICT Co., Ltd (Dongguan) attests that all calibrations have been performed, traceable to National Primary Standards and International System of Units (SI).

Test Frequency:

Operation Modes	Lowest Frequency (MHz)	Middle Frequency (MHz)	Highest Frequency (MHz)
WCDMA Band 4	1712.4	1732.6	1752.6

Test Data:

RF Output Power					
Test Mode	Conducted Average Output Power(dBm)			Maximum EIRP (dBm)	EIRP Limit (dBm)
	Lowest Channel	Middle Channel	Highest Channel		
WCDMA R99	23.38	23.26	23.21	23.76	30
HSDPA Subtest 1	22.28	22.17	22.18	22.66	30
HSDPA Subtest 2	22.21	22.04	22.04	22.59	30
HSDPA Subtest 3	22.14	22.19	22.13	22.57	30
HSDPA Subtest 4	22.11	22.15	22.01	22.53	30
HSUPA Subtest 1	22.34	22.21	22.22	22.72	30
HSUPA Subtest 2	22.28	22.05	22.07	22.66	30
HSUPA Subtest 3	22.15	22.15	22.13	22.53	30
HSUPA Subtest 4	22.24	22.24	22.09	22.62	30
HSUPA Subtest 5	22.11	22.08	22.01	22.49	30

Note: EIRP=Conducted Power(dBm) - Lc(dB) + Gr(dBi)

Result:	Pass
----------------	-------------

Peak-to-average Ratio (PAR)				
Test Mode	Peak-to-average Ratio(dB)			Limit (dB)
	Lowest Channel	Middle Channel	Highest Channel	
WCDMA R99	2.53	3.04	2.69	13
HSDPA	3.69	4.01	3.72	13
HSUPA	3.69	4.17	3.81	13

Result:	Pass
----------------	-------------

Occupied Bandwidth						
Operation Mode	99% Occupied Bandwidth (MHz)			26 dB Occupied Bandwidth (MHz)		
	Low Channel	Middle channel	High Channel	Low Channel	Middle Channel	High Channel
WCDMA R99	4.183	4.199	4.183	4.737	4.728	4.728
HSDPA	4.199	4.199	4.183	4.744	4.731	4.737
HSUPA	4.199	4.199	4.183	4.747	4.747	4.728

Note: The test plots please refer to the Plots of Occupied Bandwidth

Spurious Emissions at Antenna Terminal	
Result:	Pass, Please refer to the test plots of Spurious Emissions at Antenna Terminal.

Out of band emission, Band Edge	
Result:	Pass, Please refer to the test plots of Out of band emission, Band Edge.

Frequency Stability

Test Mode:	WCDMA R99	Test Channel: Lowest for Lower Edge,Highest for Upper Edge				
Test Item	Temperature (°C)	Voltage (V _{DC})	Lower Edge (MHz)		Upper Edge (MHz)	
			Result	Limit	Result	Limit
Frequency Stability vs. Temperature	-30	3.8	1710.279	1710.000	1754.703	1755.000
	-20	3.8	1710.290	1710.000	1754.685	1755.000
	-10	3.8	1710.290	1710.000	1754.710	1755.000
	0	3.8	1710.294	1710.000	1754.708	1755.000
	10	3.8	1710.291	1710.000	1754.706	1755.000
	20	3.8	1710.301	1710.000	1754.683	1755.000
	30	3.8	1710.290	1710.000	1754.710	1755.000
	40	3.8	1710.289	1710.000	1754.686	1755.000
	50	3.8	1710.299	1710.000	1754.711	1755.000
Frequency Stability vs. Voltage	20	3.6	1710.300	1710.000	1754.700	1755.000
	20	4.35	1710.290	1710.000	1754.697	1755.000
					Result:	Pass

Test Plots (Note: The 14.5 dB is the Insertion loss of the RF cable and Power Splitter, which was offset into the Spectrum Analyzer):

Occupied Bandwidth		
Channel	WCDMA R99	HSDPA
Lowest	<p>ProjectNo.:CR231169741-RF Tester:Arthur Su Date: 5.DEC.2023 19:36:09</p>	<p>ProjectNo.:CR231169741-RF Tester:Arthur Su Date: 5.DEC.2023 19:58:16</p>
Middle	<p>ProjectNo.:CR231169741-RF Tester:Arthur Su Date: 5.DEC.2023 19:38:25</p>	<p>ProjectNo.:CR231169741-RF Tester:Arthur Su Date: 5.DEC.2023 20:00:52</p>
Highest	<p>ProjectNo.:CR231169741-RF Tester:Arthur Su Date: 5.DEC.2023 19:39:55</p>	<p>ProjectNo.:CR231169741-RF Tester:Arthur Su Date: 5.DEC.2023 20:02:35</p>

Occupied Bandwidth

Channel

HSUPA

Lowest

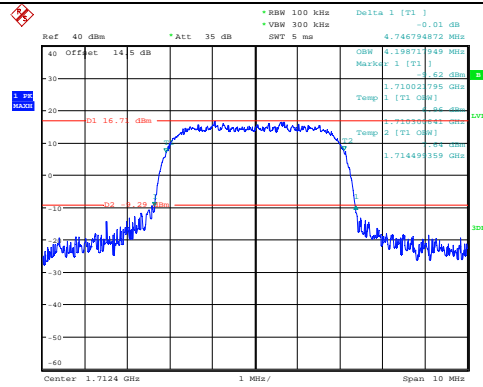

ProjectNo.:CR231169741-RF Tester:Arthur Su
 Date: 5.DEC.2023 20:29:14

Middle

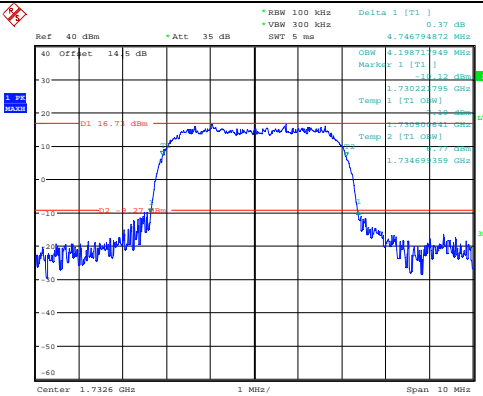

ProjectNo.:CR231169741-RF Tester:Arthur Su
 Date: 5.DEC.2023 20:31:35

Highest

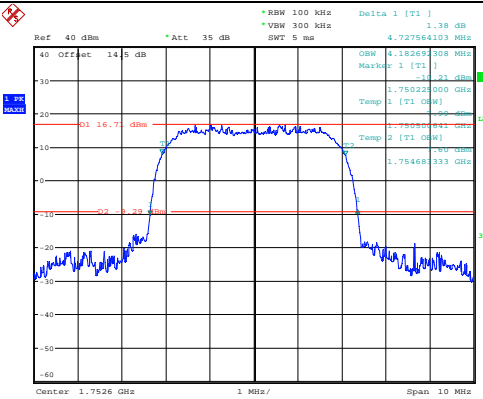

ProjectNo.:CR231169741-RF Tester:Arthur Su
 Date: 5.DEC.2023 20:33:17

Spurious Emissions at Antenna Terminal

Channel	WCDMA R99	
Lowest	<p>ProjectNo.:CR231169741-RF Tester:Arthur Su Date: 5.DEC.2023 17:56:45</p>	<p>ProjectNo.:CR231169741-RF Tester:Arthur Su Date: 5.DEC.2023 17:57:16</p>
Middle	<p>ProjectNo.:CR231169741-RF Tester:Arthur Su Date: 5.DEC.2023 17:57:44</p>	<p>ProjectNo.:CR231169741-RF Tester:Arthur Su Date: 5.DEC.2023 17:58:10</p>
Highest	<p>ProjectNo.:CR231169741-RF Tester:Arthur Su Date: 5.DEC.2023 17:58:44</p>	<p>ProjectNo.:CR231169741-RF Tester:Arthur Su Date: 5.DEC.2023 17:59:01</p>

Out of band emission, Band Edge

Mode	Lowest	Highest
R99	<p>ProjectNo.:CR231169741-RF Tester:Arthur Su Date: 5.DEC.2023 19:36:31</p>	<p>ProjectNo.:CR231169741-RF Tester:Arthur Su Date: 5.DEC.2023 19:40:16</p>
HSUPA	<p>ProjectNo.:CR231169741-RF Tester:Arthur Su Date: 5.DEC.2023 20:29:32</p>	<p>ProjectNo.:CR231169741-RF Tester:Arthur Su Date: 5.DEC.2023 20:34:52</p>
HSDPA	<p>ProjectNo.:CR231169741-RF Tester:Arthur Su Date: 5.DEC.2023 19:59:01</p>	<p>ProjectNo.:CR231169741-RF Tester:Arthur Su Date: 5.DEC.2023 20:03:05</p>

4.5 Antenna Port Test Data and Results for WCDMA Band 5:

Serial Number:	2E5M-1	Test Date:	2023/12/1-2023/12/5
Test Site:	RF	Test Mode:	Transmitting
Tester:	Claire Liu/Arthur Su	Test Result:	Pass

Environmental Conditions:

Temperature: (°C)	24.3-25.8	Relative Humidity: (%)	52-61	ATM Pressure: (kPa)	101-101.4
----------------------	-----------	------------------------------	-------	------------------------	-----------

Test Equipment List and Details:

Manufacturer	Description	Model	Serial Number	Calibration Date	Calibration Due Date
R&S	Spectrum Analyzer	FSU26	200256	2023/3/31	2024/3/30
zhuoxiang	Coaxial Cable	SMA-178	211002	Each time	N/A
YINSAIGE	Coaxial Cable	SS402	SJ0100002	Each time	N/A
eastsheep	Coaxial Attenuator	2W-SMA-JK-18G	21060301	Each time	N/A
R&S	Wideband Radio Communication Tester	CMW500	143458	2023/3/31	2024/3/30
BACL	TEMP&HUMI Test Chamber	BTH-150-40	30174	2023/3/31	2024/3/30
UNI-T	Multimeter	UT39A+	C210582554	2023/9/28	2024/9/27
ZHAOXIN	DC Power Supply	RXN-6010D	21R6010D0912386	N/A	N/A
Unknown	Coaxial tee connector	Unknown	2204005	Each time	N/A

* Statement of Traceability: China Certification ICT Co., Ltd (Dongguan) attests that all calibrations have been performed, traceable to National Primary Standards and International System of Units (SI).

Test Frequency:

Operation Modes	Lowest Frequency (MHz)	Middle Frequency (MHz)	Highest Frequency (MHz)
WCDMA Band 5	826.4	836.6	846.6

Test Data:

RF Output Power					
Test Mode	Conducted Average Output Power(dBm)			Maximum ERP (dBm)	ERP Limit (dBm)
	Lowest Channel	Middle Channel	Highest Channel		
WCDMA R99	23.41	23.52	23.46	21.00	38.45
HSDPA Subtest 1	22.34	22.01	22.23	19.82	38.45
HSDPA Subtest 2	22.24	22.06	22.17	19.72	38.45
HSDPA Subtest 3	22.18	22.11	22.14	19.66	38.45
HSDPA Subtest 4	22.11	22.17	22.16	19.65	38.45
HSUPA Subtest 1	22.14	22.18	22.04	19.66	38.45
HSUPA Subtest 2	22.06	22.23	22.09	19.71	38.45
HSUPA Subtest 3	22.17	22.19	22.01	19.67	38.45
HSUPA Subtest 4	22.19	22.24	22.06	19.72	38.45
HSUPA Subtest 5	22.04	22.07	22.19	19.67	38.45

Note:
 ERP= Conducted Power(dBm) - Lc(dB) + G_T(dBd)
 G_T(dBd)=G_T(dBi)-2.15

Result:	Pass
----------------	-------------

Peak-to-average Ratio(PAR)				
Test Mode	Peak-to-average Ratio(dB)			Limit (dB)
	Lowest Channel	Middle Channel	Highest Channel	
WCDMA R99	3.04	2.95	3.01	13
HSDPA	4.10	4.46	4.07	13
HSUPA	4.10	4.20	3.88	13

Result:	Pass
----------------	-------------

Occupied Bandwidth						
Operation Mode	99% Occupied Bandwidth (MHz)			26 dB Occupied Bandwidth (MHz)		
	Low Channel	Middle channel	High Channel	Low Channel	Middle Channel	High Channel
WCDMA R99	4.135	4.199	4.151	4.711	4.760	4.728
HSDPA	4.151	4.183	4.167	4.760	4.731	5.042
HSUPA	4.183	4.199	4.199	4.731	4.747	5.542

Note: The test plots please refer to the Plots of Occupied Bandwidth

Spurious Emissions at Antenna Terminal	
Result:	Pass, Please refer to the test plots of Spurious Emissions at Antenna Terminal.

Out of band emission, Band Edge	
Result:	Pass, Please refer to the test plots of Out of band emission, Band Edge.

Frequency Stability					
Test Modulation:	WCDMA R99		Test Channel:	836.6	MHz
Test Item	Temperature (°C)	Voltage (V _{DC})	Frequency Error		Limit
			(Hz)	(ppm)	(ppm)
Frequency Stability vs. Temperature	-30	3.8	-3.20	-0.004	2.5
	-20	3.8	-6.68	-0.008	2.5
	-10	3.8	9.77	0.012	2.5
	0	3.8	-7.62	-0.009	2.5
	10	3.8	-9.91	-0.012	2.5
	20	3.8	-9.82	-0.012	2.5
	30	3.8	-6.68	-0.008	2.5
	40	3.8	-8.86	-0.011	2.5
	50	3.8	5.67	0.007	2.5
Frequency Stability vs. Voltage	20	3.6	6.05	0.007	2.5
	20	4.35	7.52	0.009	2.5
				Result:	Pass

Test Plots (Note: The 14.5 dB is the Insertion loss of the RF cable and Power Splitter, which was offset into the Spectrum Analyzer):

Occupied Bandwidth		
Channel	WCDMA R99	HSDPA
Lowest	<p>ProjectNo.:CR231169741-RF Tester:Arthur Su Date: 5.DEC.2023 19:42:47</p>	<p>ProjectNo.:CR231169741-RF Tester:Arthur Su Date: 5.DEC.2023 20:05:34</p>
Middle	<p>ProjectNo.:CR231169741-RF Tester:Arthur Su Date: 5.DEC.2023 19:45:25</p>	<p>ProjectNo.:CR231169741-RF Tester:Arthur Su Date: 5.DEC.2023 20:05:09</p>
Highest	<p>ProjectNo.:CR231169741-RF Tester:Arthur Su Date: 5.DEC.2023 19:47:38</p>	<p>ProjectNo.:CR231169741-RF Tester:Arthur Su Date: 5.DEC.2023 20:09:57</p>

Occupied Bandwidth

Channel

HSUPA

Lowest

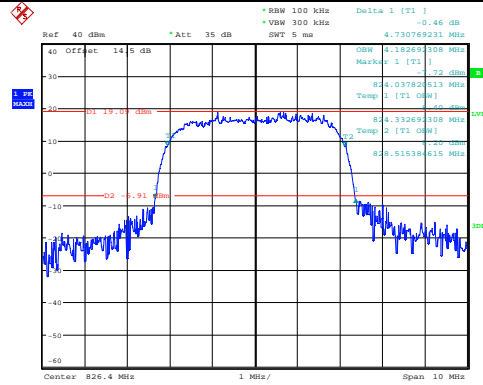

Middle

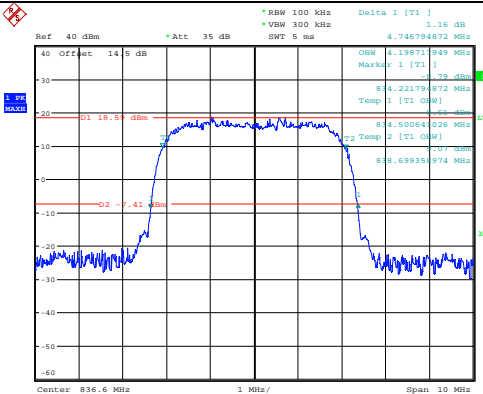

Highest

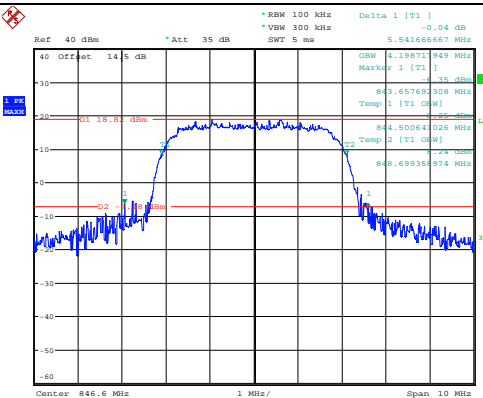

Spurious Emissions at Antenna Terminal

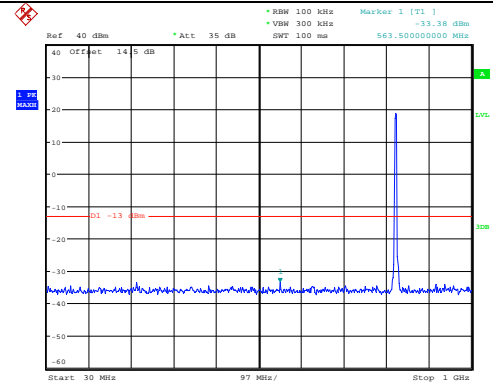
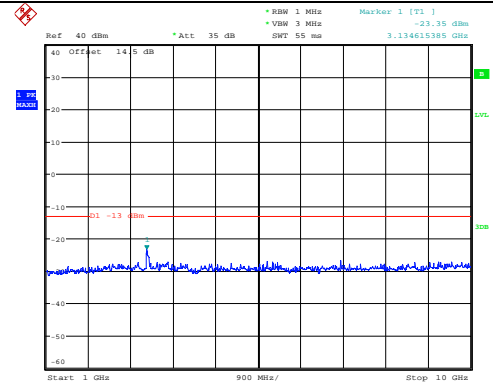
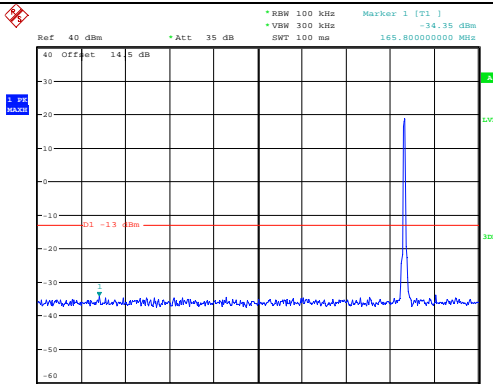
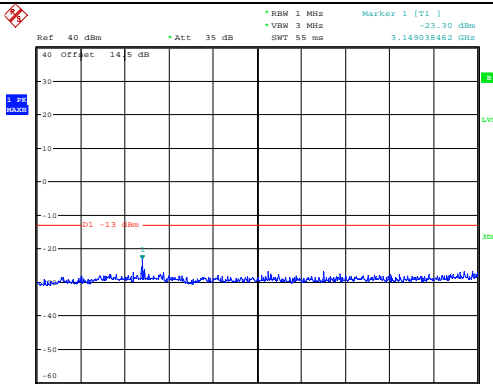
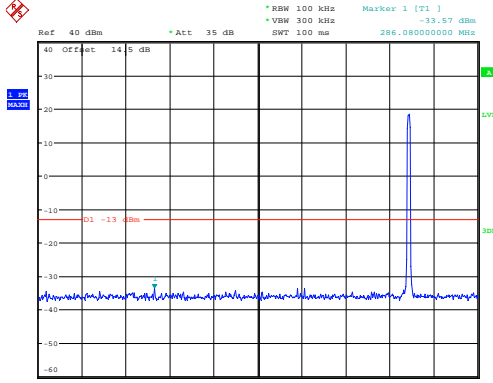
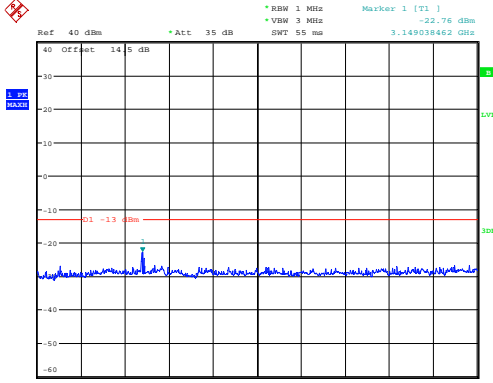
Channel	WCDMA R99	
Lowest	 <p>Ref 40 dBm *Att 35 dB *RBW 100 kHz *VSW 300 kHz Marker 1 [T1] -33.38 dBm SWT 100 ms 563.500000000 MHz</p> <p>Start 30 MHz 97 MHz/ Stop 1 GHz</p> <p>ProjectNo.:CR231169741-RF Tester:Arthur Su Date: 5.DEC.2023 18:26:07</p>	 <p>Ref 40 dBm *Att 35 dB *RBW 1 MHz *VSW 3 MHz Marker 1 [T1] -23.35 dBm SWT 55 ms 3.134615385 GHz</p> <p>Start 1 GHz 900 MHz/ Stop 10 GHz</p> <p>ProjectNo.:CR231169741-RF Tester:Arthur Su Date: 5.DEC.2023 18:26:28</p>
Middle	 <p>Ref 40 dBm *Att 35 dB *RBW 100 kHz *VSW 300 kHz Marker 1 [T1] -34.35 dBm SWT 100 ms 165.800000000 MHz</p> <p>Start 30 MHz 97 MHz/ Stop 1 GHz</p> <p>ProjectNo.:CR231169741-RF Tester:Arthur Su Date: 5.DEC.2023 18:27:36</p>	 <p>Ref 40 dBm *Att 35 dB *RBW 1 MHz *VSW 3 MHz Marker 1 [T1] -22.30 dBm SWT 55 ms 3.149038462 GHz</p> <p>Start 1 GHz 900 MHz/ Stop 10 GHz</p> <p>ProjectNo.:CR231169741-RF Tester:Arthur Su Date: 5.DEC.2023 18:27:57</p>
Highest	 <p>Ref 40 dBm *Att 35 dB *RBW 100 kHz *VSW 300 kHz Marker 1 [T1] -33.57 dBm SWT 100 ms 286.080000000 MHz</p> <p>Start 30 MHz 97 MHz/ Stop 1 GHz</p> <p>ProjectNo.:CR231169741-RF Tester:Arthur Su Date: 5.DEC.2023 18:28:58</p>	 <p>Ref 40 dBm *Att 35 dB *RBW 1 MHz *VSW 3 MHz Marker 1 [T1] -22.76 dBm SWT 55 ms 3.149038462 GHz</p> <p>Start 1 GHz 900 MHz/ Stop 10 GHz</p> <p>ProjectNo.:CR231169741-RF Tester:Arthur Su Date: 5.DEC.2023 18:29:27</p>

Out of band emission, Band Edge

Mode	Lowest	Highest
R99	<p>ProjectNo.:CR231169741-RF Tester:Arthur Su Date: 5.DEC.2023 19:43:10</p>	<p>ProjectNo.:CR231169741-RF Tester:Arthur Su Date: 5.DEC.2023 19:47:57</p>
HSUPA	<p>ProjectNo.:CR231169741-RF Tester:Arthur Su Date: 5.DEC.2023 20:36:53</p>	<p>ProjectNo.:CR231169741-RF Tester:Arthur Su Date: 5.DEC.2023 20:42:15</p>
HSDPA	<p>ProjectNo.:CR231169741-RF Tester:Arthur Su Date: 5.DEC.2023 20:06:14</p>	<p>ProjectNo.:CR231169741-RF Tester:Arthur Su Date: 5.DEC.2023 20:11:11</p>

4.6 Antenna Port Test Data and Results for LTE Band 2

Serial Number:	2E5M-1	Test Date:	2023/12/1-2023/12/5
Test Site:	RF	Test Mode:	Transmitting
Tester:	Claire Liu/Arthur Su	Test Result:	Pass

Environmental Conditions:

Temperature: (°C)	24.3-25.8	Relative Humidity: (%)	52-61	ATM Pressure: (kPa)	101-101.4
----------------------	-----------	---------------------------	-------	------------------------	-----------

Test Equipment List and Details:

Manufacturer	Description	Model	Serial Number	Calibration Date	Calibration Due Date
R&S	Spectrum Analyzer	FSU26	200256	2023/3/31	2024/3/30
zhuoxiang	Coaxial Cable	SMA-178	211002	Each time	N/A
YINSAIGE	Coaxial Cable	SS402	SJ0100002	Each time	N/A
eastsheep	Coaxial Attenuator	2W-SMA-JK-18G	21060301	Each time	N/A
R&S	Wideband Radio Communication Tester	CMW500	143458	2023/3/31	2024/3/30
BACL	TEMP&HUMI Test Chamber	BTH-150-40	30174	2023/3/31	2024/3/30
UNI-T	Multimeter	UT39A+	C210582554	2023/9/28	2024/9/27
ZHAOXIN	DC Power Supply	RXN-6010D	21R6010D0912386	N/A	N/A
Unknown	Coaxial tee connector	Unknown	2204005	Each time	N/A

* Statement of Traceability: China Certification ICT Co., Ltd (Dongguan) attests that all calibrations have been performed, traceable to National Primary Standards and International System of Units (SI).

Test Frequency for Each Mode:

Operation Bandwidth	Lowest Frequency (MHz)	Middle Frequency (MHz)	Highest Frequency (MHz)
1.4MHz	1850.7	1880	1909.3
3MHz	1851.5	1880	1908.5
5MHz	1852.5	1880	1907.5
10MHz	1855	1880	1905
15MHz	1857.5	1880	1902.5
20MHz	1860	1880	1900

Test Data:

RF Output Power						
Test Bandwidth & Modulation	Resource Block & RB offset	Conducted Average Output Power(dBm)			Maximum EIRP (dBm)	EIRP Limit (dBm)
		Lowest Channel	Middle Channel	Highest Channel		
1.4MHz QPSK	RB1#0	21.93	20.96	21.24	22.52	33
	RB1#3	22.05	21.11	21.44		
	RB1#5	21.89	20.94	21.23		
	RB3#0	21.95	21.05	21.05		
	RB3#3	21.92	21.01	21.10		
	RB6#0	20.99	20.05	20.27		
1.4MHz 16QAM	RB1#0	20.85	20.06	20.02	21.55	33
	RB1#3	20.99	20.27	20.20		
	RB1#5	20.84	20.05	20.05		
	RB3#0	21.08	19.99	20.05		
	RB3#3	21.06	20.02	19.98		
	RB6#0	19.96	19.07	19.03		
3MHz QPSK	RB1#0	22.12	21.80	21.27	22.59	33
	RB1#8	22.04	21.66	21.30		
	RB1#14	21.85	21.66	21.33		
	RB6#0	21.06	20.62	20.25		
	RB6#9	20.89	20.61	20.26		
	RB15#0	21.00	20.68	20.18		
3MHz 16QAM	RB1#0	21.21	20.75	20.62	21.68	33
	RB1#8	21.14	20.68	20.53		
	RB1#14	21.09	20.66	20.50		
	RB6#0	19.91	19.59	19.22		
	RB6#9	20.00	19.59	19.14		
	RB15#0	20.03	19.70	19.17		
5MHz QPSK	RB1#0	22.02	21.01	20.97	22.59	33
	RB1#13	22.12	20.95	21.12		
	RB1#24	21.93	20.73	21.03		
	RB15#0	21.14	19.82	19.99		
	RB15#10	21.15	19.86	19.88		
	RB25#0	20.99	19.83	19.84		
5MHz 16QAM	RB1#0	21.05	19.70	20.22	21.52	33
	RB1#13	21.00	19.83	20.22		
	RB1#24	20.96	19.63	20.07		
	RB15#0	19.93	18.92	18.92		
	RB15#10	20.00	18.89	18.81		
	RB25#0	20.04	18.89	18.86		
10MHz QPSK	RB1#0	21.97	21.43	21.43	22.45	33
	RB1#25	21.98	21.53	21.52		
	RB1#49	21.77	21.35	21.47		

	RB25#0	20.81	20.38	20.39		
	RB25#25	20.71	20.37	20.30		
	RB50#0	20.77	20.38	20.33		
10MHz 16QAM	RB1#0	20.85	21.05	20.59	21.53	33
	RB1#25	20.89	21.06	20.64		
	RB1#49	20.74	20.82	20.41		
	RB25#0	19.91	19.47	19.46		
	RB25#25	19.79	19.44	19.32		
	RB50#0	19.77	19.42	19.34		
15MHz QPSK	RB1#0	21.86	21.58	21.57	22.33	33
	RB1#38	21.80	21.52	21.56		
	RB1#74	21.64	21.31	21.47		
	RB36#0	20.95	20.66	20.67		
	RB36#39	20.78	20.61	20.56		
	RB75#0	20.88	20.57	20.60		
15MHz 16QAM	RB1#0	21.13	21.18	20.71	21.65	33
	RB1#38	21.13	21.11	20.69		
	RB1#74	21.07	20.89	20.43		
	RB36#0	19.81	19.64	19.65		
	RB36#39	19.68	19.54	19.52		
	RB75#0	19.79	19.60	19.64		
20MHz QPSK	RB1#0	21.67	20.87	20.47	22.36	33
	RB1#50	21.89	21.07	20.82		
	RB1#99	21.45	20.65	20.41		
	RB50#0	20.92	19.97	19.80		
	RB50#50	20.69	19.85	19.66		
	RB100#0	20.82	19.92	19.77		
20MHz 16QAM	RB1#0	21.16	20.18	19.66	21.87	33
	RB1#50	21.40	20.42	20.00		
	RB1#99	21.03	19.91	19.40		
	RB50#0	19.90	18.96	18.85		
	RB50#50	19.68	18.82	18.66		
	RB100#0	19.83	18.95	18.79		

Note: EIRP=Conducted Power(dBm) - Lc(dB) + G_T(dBi)

Result:

Pass

Peak-to-average Ratio (PAR)

Test Bandwidth & Modulation	Resource Block & RB offset	Peak-to-average Ratio(dB)			Limit (dB)
		Lowest Channel	Middle Channel	Highest Channel	
20MHz QPSK	RB1#0	8.21	8.33	8.37	13
	RB100#0	6.38	6.38	6.57	13
20MHz 16QAM	RB1#0	8.01	8.3	8.33	13
	RB100#0	7.12	7.08	7.21	13
Result:				Pass	

Occupied Bandwidth						
Operation Mode	99% Occupied Bandwidth (MHz)			26 dB Occupied Bandwidth (MHz)		
	Low Channel	Middle channel	High Channel	Low Channel	Middle Channel	High Channel
1.4MHz QPSK	1.098	1.104	1.104	1.302	1.308	1.326
1.4MHz 16QAM	1.098	1.110	1.098	1.296	1.326	1.290
3MHz QPSK	2.687	2.687	2.687	2.940	2.880	2.868
3MHz 16QAM	2.687	2.687	2.687	2.892	2.880	2.892
5MHz QPSK	4.520	4.520	4.520	4.900	4.960	4.980
5MHz 16QAM	4.520	4.500	4.520	4.960	4.920	4.920
10MHz QPSK	8.960	8.960	8.960	9.640	9.600	9.440
10MHz 16QAM	8.960	8.960	8.960	9.520	9.600	9.480
15MHz QPSK	13.560	13.500	13.500	14.880	14.700	14.820
15MHz 16QAM	13.560	13.500	13.500	14.760	14.820	14.820
20MHz QPSK	17.920	18.000	18.000	19.280	19.280	19.600
20MHz 16QAM	18.000	17.920	18.000	19.280	19.440	19.360

Note: The test plots please refer to the Plots of Occupied Bandwidth

Spurious Emissions at Antenna Terminal	
Result:	Pass, Please refer to the test plots of Spurious Emissions at Antenna Terminal.

Out of band emission, Band Edge	
Result:	Pass, Please refer to the test plots of Out of band emission, Band Edge.

Frequency Stability						
Test Mode:	20M QPSK	Test Channel: Lowest for Lower Edge, Highest for Upper Edge				
Test Item	Temperature (°C)	Voltage (V _{DC})	Lower Edge (MHz)		Upper Edge (MHz)	
			Result	Limit	Result	Limit
Frequency Stability vs. Temperature	-30	3.8	1851.030	1850.000	1909.050	1910.000
	-20	3.8	1851.022	1850.000	1909.061	1910.000
	-10	3.8	1851.022	1850.000	1909.062	1910.000
	0	3.8	1851.018	1850.000	1909.040	1910.000
	10	3.8	1851.039	1850.000	1909.061	1910.000
	20	3.8	1851.040	1850.000	1909.040	1910.000
	30	3.8	1851.017	1850.000	1909.042	1910.000
	40	3.8	1851.030	1850.000	1909.057	1910.000
Frequency Stability vs. Voltage	20	3.6	1851.016	1850.000	1909.052	1910.000
	20	4.35	1851.021	1850.000	1909.041	1910.000
					Result:	Pass

Test Mode:	20M 16QAM	Test Channel: Lowest for Lower Edge, Highest for Upper Edge				
Test Item	Temperature (°C)	Voltage (V _{DC})	Lower Edge (MHz)		Upper Edge (MHz)	
			Result	Limit	Result	Limit
Frequency Stability vs. Temperature	-30	3.8	1851.017	1850.000	1909.060	1910.000
	-20	3.8	1851.036	1850.000	1909.041	1910.000
	-10	3.8	1851.028	1850.000	1909.067	1910.000
	0	3.8	1851.035	1850.000	1909.048	1910.000
	10	3.8	1851.026	1850.000	1909.041	1910.000
	20	3.8	1851.040	1850.000	1909.040	1910.000
	30	3.8	1851.015	1850.000	1909.065	1910.000
	40	3.8	1851.016	1850.000	1909.065	1910.000
	50	3.8	1851.036	1850.000	1909.060	1910.000
Frequency Stability vs. Voltage	20	3.6	1851.024	1850.000	1909.063	1910.000
	20	4.35	1851.025	1850.000	1909.066	1910.000
					Result:	Pass

Test Plots:

Please refer to the below plots.

Note: The 14.5 dB is the Insertion loss of the RF cable and Power Splitter, which was offset into the Spectrum Analyzer.

Test Plots for Occupied Bandwidth:
Note: The test is performed in full RB mode.

Occupied Bandwidth

Channel	1.4MHz Bandwidth QPSK	1.4MHz Bandwidth 16QAM
Lowest	<p>ProjectNo.:CR231169741-RF Tester: Claire Liu Date: 1.DEC.2023 22:40:15</p>	<p>ProjectNo.:CR231169741-RF Tester: Claire Liu Date: 1.DEC.2023 22:40:35</p>
Middle	<p>ProjectNo.:CR231169741-RF Tester: Claire Liu Date: 1.DEC.2023 22:40:59</p>	<p>ProjectNo.:CR231169741-RF Tester: Claire Liu Date: 1.DEC.2023 22:41:16</p>
Highest	<p>ProjectNo.:CR231169741-RF Tester: Claire Liu Date: 1.DEC.2023 22:41:33</p>	<p>ProjectNo.:CR231169741-RF Tester: Claire Liu Date: 1.DEC.2023 22:41:50</p>

Occupied Bandwidth

Channel	3MHz Bandwidth QPSK	3MHz Bandwidth 16QAM
Lowest	<p>ProjectNo.:CR231169741-RF Tester: Claire Liu Date: 1.DEC.2023 22:44:08</p>	<p>ProjectNo.:CR231169741-RF Tester: Claire Liu Date: 1.DEC.2023 22:44:25</p>
Middle	<p>ProjectNo.:CR231169741-RF Tester: Claire Liu Date: 1.DEC.2023 22:44:39</p>	<p>ProjectNo.:CR231169741-RF Tester: Claire Liu Date: 1.DEC.2023 22:44:52</p>
Highest	<p>ProjectNo.:CR231169741-RF Tester: Claire Liu Date: 1.DEC.2023 22:45:10</p>	<p>ProjectNo.:CR231169741-RF Tester: Claire Liu Date: 1.DEC.2023 22:45:23</p>

Occupied Bandwidth

Channel	5MHz Bandwidth QPSK	5MHz Bandwidth 16QAM
Lowest	<p>ProjectNo.:CR231169741-RF Tester: Claire Liu Date: 1.DEC.2023 22:55:08</p>	<p>ProjectNo.:CR231169741-RF Tester: Claire Liu Date: 1.DEC.2023 22:55:22</p>
Middle	<p>ProjectNo.:CR231169741-RF Tester: Claire Liu Date: 1.DEC.2023 22:55:19</p>	<p>ProjectNo.:CR231169741-RF Tester: Claire Liu Date: 1.DEC.2023 22:55:16</p>
Highest	<p>ProjectNo.:CR231169741-RF Tester: Claire Liu Date: 1.DEC.2023 22:56:13</p>	<p>ProjectNo.:CR231169741-RF Tester: Claire Liu Date: 1.DEC.2023 22:56:30</p>

Occupied Bandwidth

Channel	10MHz Bandwidth QPSK	10MHz Bandwidth 16QAM
Lowest	<p>ProjectNo.:CR231169741-RF Tester: Claire Liu Date: 1.DEC.2023 22:57:25</p>	<p>ProjectNo.:CR231169741-RF Tester: Claire Liu Date: 1.DEC.2023 22:57:42</p>
Middle	<p>ProjectNo.:CR231169741-RF Tester: Claire Liu Date: 1.DEC.2023 22:58:56</p>	<p>ProjectNo.:CR231169741-RF Tester: Claire Liu Date: 1.DEC.2023 22:58:13</p>
Highest	<p>ProjectNo.:CR231169741-RF Tester: Claire Liu Date: 1.DEC.2023 22:58:27</p>	<p>ProjectNo.:CR231169741-RF Tester: Claire Liu Date: 1.DEC.2023 22:58:43</p>

Occupied Bandwidth

Channel	15MHz Bandwidth QPSK	15MHz Bandwidth 16QAM
Lowest	<p>ProjectNo.:CR231169741-RF Tester: Claire Liu Date: 1.DEC.2023 22:59:43</p>	<p>ProjectNo.:CR231169741-RF Tester: Claire Liu Date: 1.DEC.2023 22:59:57</p>
Middle	<p>ProjectNo.:CR231169741-RF Tester: Claire Liu Date: 1.DEC.2023 23:00:11</p>	<p>ProjectNo.:CR231169741-RF Tester: Claire Liu Date: 1.DEC.2023 23:00:28</p>
Highest	<p>ProjectNo.:CR231169741-RF Tester: Claire Liu Date: 1.DEC.2023 23:00:42</p>	<p>ProjectNo.:CR231169741-RF Tester: Claire Liu Date: 1.DEC.2023 23:00:55</p>

Occupied Bandwidth

Channel	20MHz Bandwidth QPSK	20MHz Bandwidth 16QAM
Lowest	<p>ProjectNo.:CR231169741-RF Tester: Claire Liu Date: 1.DEC.2023 23:10:23</p>	<p>ProjectNo.:CR231169741-RF Tester: Claire Liu Date: 1.DEC.2023 23:10:40</p>
Middle	<p>ProjectNo.:CR231169741-RF Tester: Claire Liu Date: 1.DEC.2023 23:10:57</p>	<p>ProjectNo.:CR231169741-RF Tester: Claire Liu Date: 1.DEC.2023 23:11:14</p>
Highest	<p>ProjectNo.:CR231169741-RF Tester: Claire Liu Date: 1.DEC.2023 23:11:28</p>	<p>ProjectNo.:CR231169741-RF Tester: Claire Liu Date: 1.DEC.2023 23:11:45</p>

Test Plots for Spurious Emissions at Antenna Terminal:
Note: The test is performed in IRB mode.

Spurious Emissions at Antenna Terminal

Channel	1.4MHz Bandwidth QPSK	
Lowest	<p>Ref: 40 dBm *Att: 35 dB *RBW 100 kHz Marker 1 [T1] -34.14 dBm *VSW 300 kHz *SWT 100 ms 629.460000000 MHz</p> <p>Start: 30 MHz 97 MHz/ Stop: 1 GHz</p> <p>ProjectNo.:CR231169741-RF Tester: Claire Liu Date: 4.DEC.2023 09:59:45</p>	<p>Ref: 40 dBm *Att: 35 dB *RBW 3 MHz Marker 1 [T1] -23.00 dBm *VSW 3 MHz *SWT 110 ms 2.400641026 GHz</p> <p>Start: 1 GHz 1.9 GHz/ Stop: 20 GHz</p> <p>ProjectNo.:CR231169741-RF Tester: Claire Liu Date: 4.DEC.2023 09:58:18</p>
Middle	<p>Ref: 40 dBm *Att: 35 dB *RBW 100 kHz Marker 1 [T1] -33.76 dBm *VSW 300 kHz *SWT 100 ms 159.980000000 MHz</p> <p>Start: 30 MHz 97 MHz/ Stop: 1 GHz</p> <p>ProjectNo.:CR231169741-RF Tester: Claire Liu Date: 4.DEC.2023 10:00:36</p>	<p>Ref: 40 dBm *Att: 35 dB *RBW 3 MHz Marker 1 [T1] -23.03 dBm *VSW 3 MHz *SWT 110 ms 3.174038462 GHz</p> <p>Start: 1 GHz 1.9 GHz/ Stop: 20 GHz</p> <p>ProjectNo.:CR231169741-RF Tester: Claire Liu Date: 4.DEC.2023 10:05:13</p>
Highest	<p>Ref: 40 dBm *Att: 35 dB *RBW 100 kHz Marker 1 [T1] -34.33 dBm *VSW 300 kHz *SWT 100 ms 670.200000000 MHz</p> <p>Start: 30 MHz 97 MHz/ Stop: 1 GHz</p> <p>ProjectNo.:CR231169741-RF Tester: Claire Liu Date: 4.DEC.2023 10:07:20</p>	<p>Ref: 40 dBm *Att: 35 dB *RBW 3 MHz Marker 1 [T1] -23.37 dBm *VSW 3 MHz *SWT 110 ms 3.161858974 GHz</p> <p>Start: 1 GHz 1.9 GHz/ Stop: 20 GHz</p> <p>ProjectNo.:CR231169741-RF Tester: Claire Liu Date: 4.DEC.2023 10:06:10</p>

Spurious Emissions at Antenna Terminal

Channel	3MHz Bandwidth QPSK	
Lowest	<p>ProjectNo.:CR231169741-RF Tester:Clair Liu Date: 4.DEC.2023 10:07:48</p>	<p>ProjectNo.:CR231169741-RF Tester:Clair Liu Date: 4.DEC.2023 10:19:34</p>
Middle	<p>ProjectNo.:CR231169741-RF Tester:Clair Liu Date: 4.DEC.2023 10:26:08</p>	<p>ProjectNo.:CR231169741-RF Tester:Clair Liu Date: 4.DEC.2023 10:26:59</p>
Highest	<p>ProjectNo.:CR231169741-RF Tester:Clair Liu Date: 4.DEC.2023 10:28:37</p>	<p>ProjectNo.:CR231169741-RF Tester:Clair Liu Date: 4.DEC.2023 10:28:06</p>

Spurious Emissions at Antenna Terminal

Channel	5MHz Bandwidth QPSK	
Lowest	<p>Ref 40 dBm *Att 35 dB *RBW 100 kHz *VSW 100 kHz *SWT 100 ms Marker 1 [T1] -34.20 dBm</p> <p>Start 30 MHz 97 MHz/ Stop 1 GHz</p> <p>ProjectNo.:CR231169741-RF Tester:Clair Liu Date: 4.DEC.2023 10:33:51</p>	<p>Ref 40 dBm *Att 35 dB *RBW 3 MHz *VSW 3 MHz *SWT 110 ms Marker 1 [T1] -22.98 dBm</p> <p>Start 1 GHz 1.9 GHz/ Stop 20 GHz</p> <p>ProjectNo.:CR231169741-RF Tester:Clair Liu Date: 4.DEC.2023 10:34:19</p>
Middle	<p>Ref 40 dBm *Att 35 dB *RBW 100 kHz *VSW 100 kHz *SWT 100 ms Marker 1 [T1] -34.35 dBm</p> <p>Start 30 MHz 97 MHz/ Stop 1 GHz</p> <p>ProjectNo.:CR231169741-RF Tester:Clair Liu Date: 4.DEC.2023 10:35:49</p>	<p>Ref 40 dBm *Att 35 dB *RBW 3 MHz *VSW 3 MHz *SWT 110 ms Marker 1 [T1] -22.30 dBm</p> <p>Start 1 GHz 1.9 GHz/ Stop 20 GHz</p> <p>ProjectNo.:CR231169741-RF Tester:Clair Liu Date: 4.DEC.2023 10:35:06</p>
Highest	<p>Ref 40 dBm *Att 35 dB *RBW 100 kHz *VSW 300 kHz *SWT 100 ms Marker 1 [T1] -33.80 dBm</p> <p>Start 30 MHz 97 MHz/ Stop 1 GHz</p> <p>ProjectNo.:CR231169741-RF Tester:Clair Liu Date: 4.DEC.2023 10:36:18</p>	<p>Ref 40 dBm *Att 35 dB *RBW 3 MHz *VSW 3 MHz *SWT 110 ms Marker 1 [T1] -24.19 dBm</p> <p>Start 1 GHz 1.9 GHz/ Stop 20 GHz</p> <p>ProjectNo.:CR231169741-RF Tester:Clair Liu Date: 4.DEC.2023 10:37:02</p>

Spurious Emissions at Antenna Terminal

Channel

10MHz Bandwidth QPSK

Lowest

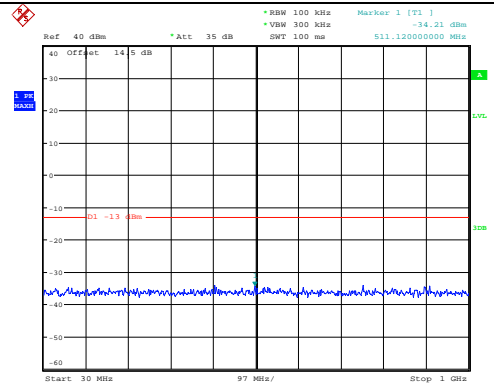

ProjectNo.:CR231169741-RF Tester:Clair Liu
Date: 4.DEC.2023 10:49:55

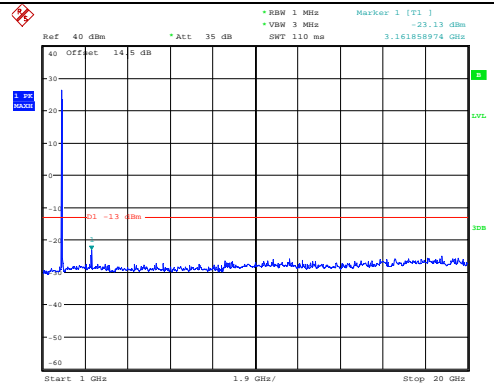

ProjectNo.:CR231169741-RF Tester:Clair Liu
Date: 4.DEC.2023 10:49:10

Middle

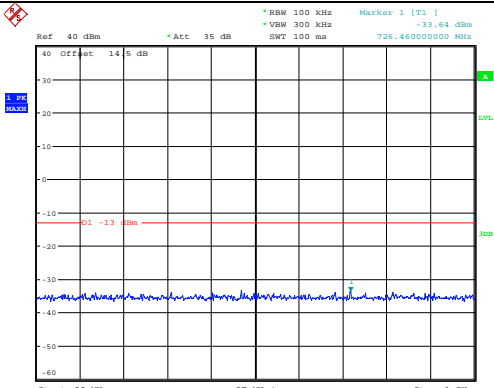

ProjectNo.:CR231169741-RF Tester:Clair Liu
Date: 4.DEC.2023 10:51:00

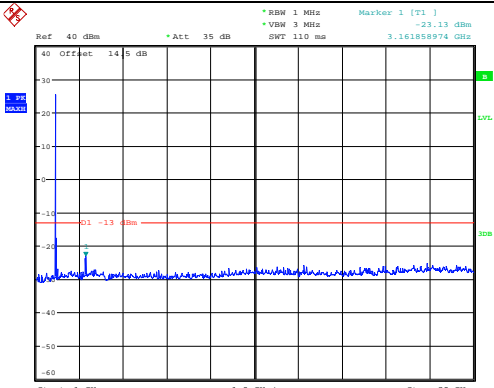

ProjectNo.:CR231169741-RF Tester:Clair Liu
Date: 4.DEC.2023 10:51:48

Highest

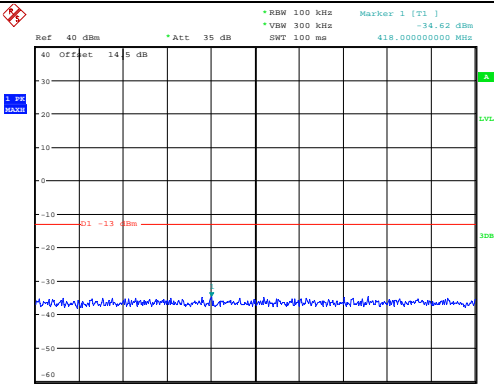

ProjectNo.:CR231169741-RF Tester:Clair Liu
Date: 4.DEC.2023 10:53:09

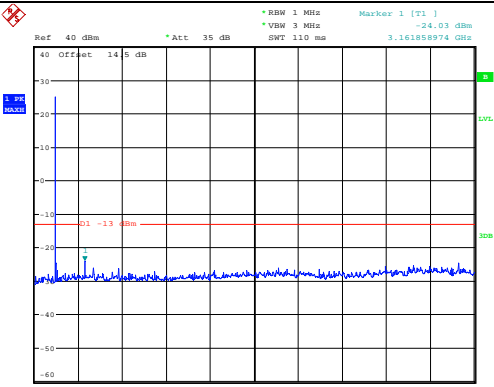

ProjectNo.:CR231169741-RF Tester:Clair Liu
Date: 4.DEC.2023 10:52:41

Spurious Emissions at Antenna Terminal

Channel

15MHz Bandwidth QPSK

Lowest

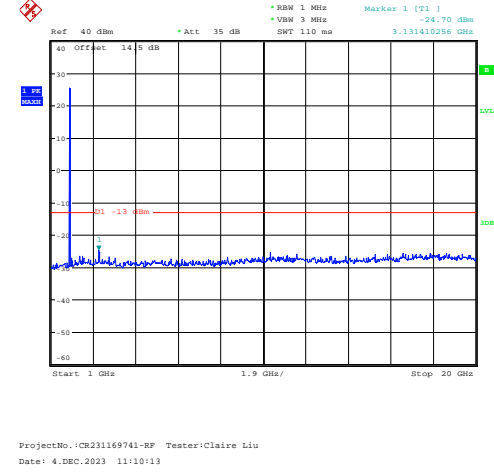
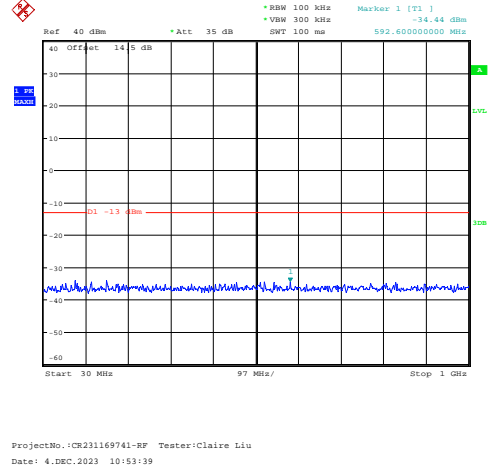

Middle

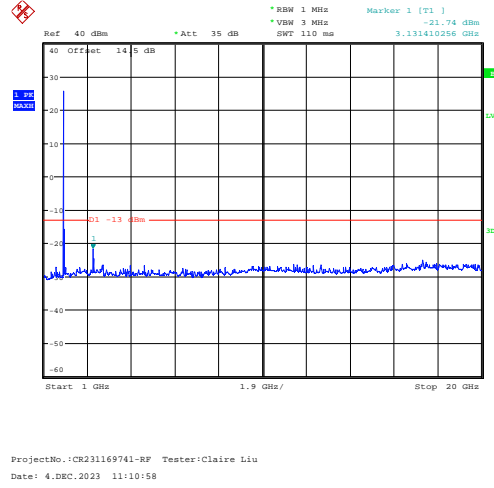
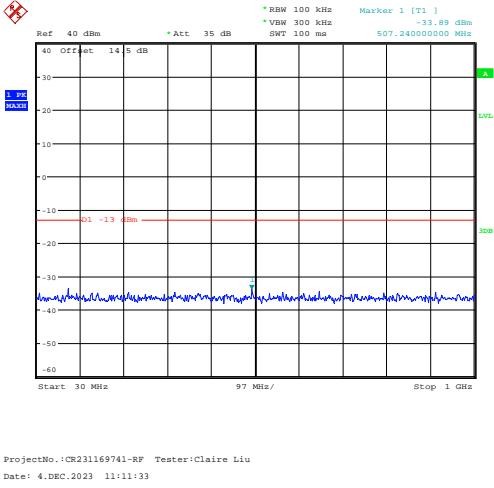

Highest

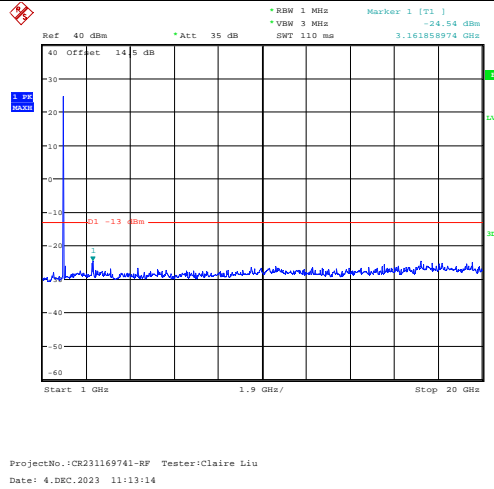
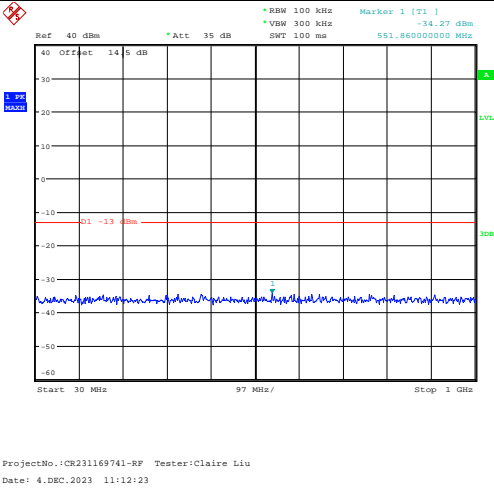

Spurious Emissions at Antenna Terminal

Channel

20MHz Bandwidth QPSK

Lowest

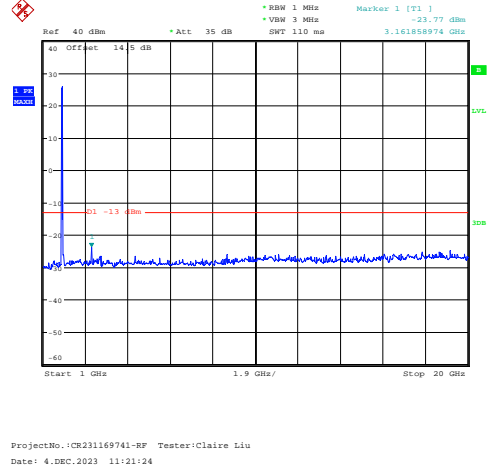
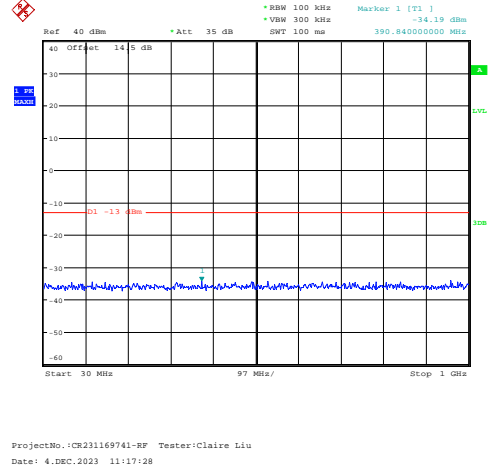

Middle

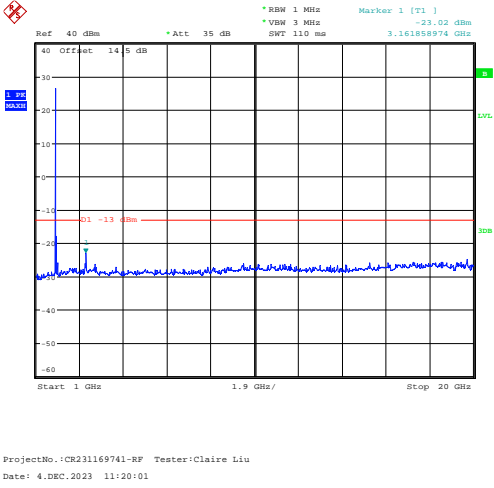
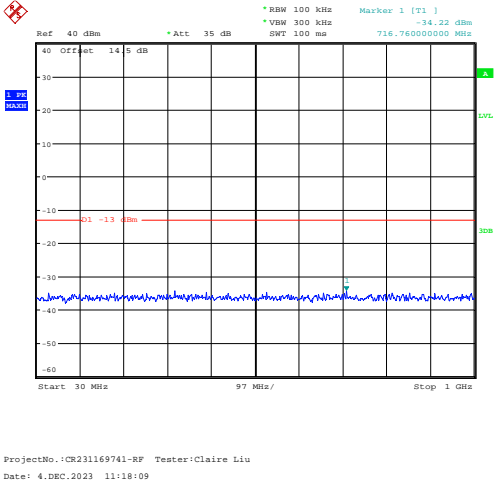

Highest

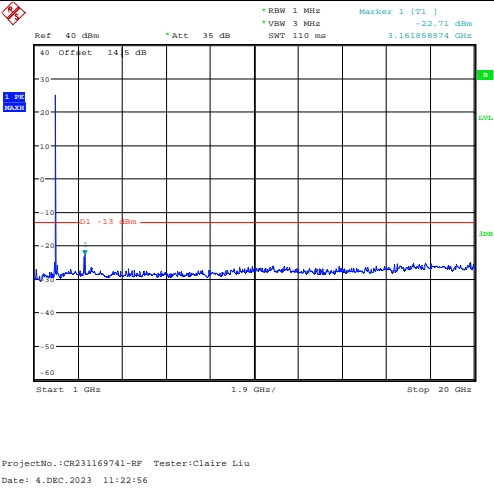
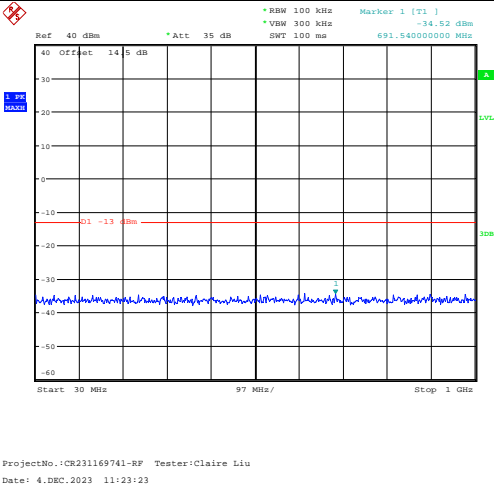

Test Plots for Out of band emission, Band Edge:
Note: The test is performed in full RB mode.

Out of band emission, Band Edge

Mode	Lowest	Highest
<p>QPSK 1.4MHz</p>	<p>ProjectNo.:CR231169741-RF Tester:Clair Liu Date: 2.DEC.2023 10:46:25</p>	<p>ProjectNo.:CR231169741-RF Tester:Clair Liu Date: 2.DEC.2023 10:46:41</p>
<p>QPSK 3MHz</p>	<p>ProjectNo.:CR231169741-RF Tester:Clair Liu Date: 2.DEC.2023 10:48:11</p>	<p>ProjectNo.:CR231169741-RF Tester:Clair Liu Date: 2.DEC.2023 10:48:28</p>
<p>QPSK 5MHz</p>	<p>ProjectNo.:CR231169741-RF Tester:Clair Liu Date: 2.DEC.2023 10:58:44</p>	<p>ProjectNo.:CR231169741-RF Tester:Clair Liu Date: 2.DEC.2023 10:59:00</p>

Out of band emission, Band Edge

Mode	Lowest	Highest
QPSK 10MHz	<p>ProjectNo.:CR231169741-RF Tester: Claire Liu Date: 2.DEC.2023 11:00:03</p>	<p>ProjectNo.:CR231169741-RF Tester: Claire Liu Date: 2.DEC.2023 11:00:21</p>
QPSK 15MHz	<p>ProjectNo.:CR231169741-RF Tester: Claire Liu Date: 2.DEC.2023 11:01:17</p>	<p>ProjectNo.:CR231169741-RF Tester: Claire Liu Date: 2.DEC.2023 11:01:32</p>
QPSK 20MHz	<p>ProjectNo.:CR231169741-RF Tester: Claire Liu Date: 2.DEC.2023 11:02:25</p>	<p>ProjectNo.:CR231169741-RF Tester: Claire Liu Date: 2.DEC.2023 11:02:40</p>

Out of band emission, Band Edge

Mode	Lowest	Highest
16QAM 1.4MHz	<p>ProjectNo.:CR231169741-RF Tester: Claire Liu Date: 2.DEC.2023 10:46:32</p>	<p>ProjectNo.:CR231169741-RF Tester: Claire Liu Date: 2.DEC.2023 10:46:49</p>
16QAM 3MHz	<p>ProjectNo.:CR231169741-RF Tester: Claire Liu Date: 2.DEC.2023 10:48:19</p>	<p>ProjectNo.:CR231169741-RF Tester: Claire Liu Date: 2.DEC.2023 10:48:36</p>
16QAM 5MHz	<p>ProjectNo.:CR231169741-RF Tester: Claire Liu Date: 2.DEC.2023 10:58:51</p>	<p>ProjectNo.:CR231169741-RF Tester: Claire Liu Date: 2.DEC.2023 10:59:09</p>

Out of band emission, Band Edge

Mode	Lowest	Highest
16QAM 10MHz	<p>ProjectNo.:CR231169741-RF Tester:Clair Liu Date: 2.DEC.2023 11:00:12</p>	<p>ProjectNo.:CR231169741-RF Tester:Clair Liu Date: 2.DEC.2023 11:00:29</p>
16QAM 15MHz	<p>ProjectNo.:CR231169741-RF Tester:Clair Liu Date: 2.DEC.2023 11:01:24</p>	<p>ProjectNo.:CR231169741-RF Tester:Clair Liu Date: 2.DEC.2023 11:01:39</p>
16QAM 20MHz	<p>ProjectNo.:CR231169741-RF Tester:Clair Liu Date: 2.DEC.2023 11:02:32</p>	<p>ProjectNo.:CR231169741-RF Tester:Clair Liu Date: 2.DEC.2023 11:02:47</p>

Test Plots for Out of band emission, Band Edge:
Note: The test is performed in 1 RB mode.

Out of band emission, Band Edge

Mode	Lowest	Highest
<p>QPSK 1.4MHz</p>	<p>ProjectNo.:CR231169741-RF Tester:Arthur Su Date: 4.DEC.2023 19:43:44</p>	<p>ProjectNo.:CR231169741-RF Tester:Arthur Su Date: 4.DEC.2023 19:46:00</p>
<p>QPSK 3MHz</p>	<p>ProjectNo.:CR231169741-RF Tester:Arthur Su Date: 4.DEC.2023 19:48:55</p>	<p>ProjectNo.:CR231169741-RF Tester:Arthur Su Date: 4.DEC.2023 19:51:06</p>
<p>QPSK 5MHz</p>	<p>ProjectNo.:CR231169741-RF Tester:Arthur Su Date: 4.DEC.2023 19:54:20</p>	<p>ProjectNo.:CR231169741-RF Tester:Arthur Su Date: 4.DEC.2023 19:55:59</p>

Out of band emission, Band Edge

Mode	Lowest	Highest
QPSK 10MHz	<p>ProjectNo.:CR231169741-RF Tester:Arthur Su Date: 4.DEC.2023 19:59:47</p>	<p>ProjectNo.:CR231169741-RF Tester:Arthur Su Date: 4.DEC.2023 20:03:04</p>
QPSK 15MHz	<p>ProjectNo.:CR231169741-RF Tester:Arthur Su Date: 4.DEC.2023 20:13:51</p>	<p>ProjectNo.:CR231169741-RF Tester:Arthur Su Date: 4.DEC.2023 20:15:51</p>
QPSK 20MHz	<p>ProjectNo.:CR231169741-RF Tester:Arthur Su Date: 4.DEC.2023 20:19:28</p>	<p>ProjectNo.:CR231169741-RF Tester:Arthur Su Date: 4.DEC.2023 20:22:19</p>

Out of band emission, Band Edge

Mode	Lowest	Highest
16QAM 1.4MHz	<p>ProjectNo.:CR231169741-RF Tester:Arthur Su Date: 4.DEC.2023 19:42:57</p>	<p>ProjectNo.:CR231169741-RF Tester:Arthur Su Date: 4.DEC.2023 19:46:40</p>
16QAM 3MHz	<p>ProjectNo.:CR231169741-RF Tester:Arthur Su Date: 4.DEC.2023 19:49:43</p>	<p>ProjectNo.:CR231169741-RF Tester:Arthur Su Date: 4.DEC.2023 19:51:54</p>
16QAM 5MHz	<p>ProjectNo.:CR231169741-RF Tester:Arthur Su Date: 4.DEC.2023 19:54:56</p>	<p>ProjectNo.:CR231169741-RF Tester:Arthur Su Date: 4.DEC.2023 19:56:42</p>

Out of band emission, Band Edge

Mode	Lowest	Highest
16QAM 10MHz	<p>ProjectNo.:CR231169741-RF Tester:Arthur Su Date: 4.DEC.2023 20:00:19</p>	<p>ProjectNo.:CR231169741-RF Tester:Arthur Su Date: 4.DEC.2023 20:03:35</p>
16QAM 15MHz	<p>ProjectNo.:CR231169741-RF Tester:Arthur Su Date: 4.DEC.2023 20:14:20</p>	<p>ProjectNo.:CR231169741-RF Tester:Arthur Su Date: 4.DEC.2023 20:16:15</p>
16QAM 20MHz	<p>ProjectNo.:CR231169741-RF Tester:Arthur Su Date: 4.DEC.2023 20:20:21</p>	<p>ProjectNo.:CR231169741-RF Tester:Arthur Su Date: 4.DEC.2023 20:22:59</p>

4.7 Antenna Port Test Data and Results for LTE Band 4

Serial Number:	2E5M-1	Test Date:	2023/12/1-2023/12/19
Test Site:	RF	Test Mode:	Transmitting
Tester:	Claire Liu/Arthur Su	Test Result:	Pass

Environmental Conditions:

Temperature: (°C)	24.3-26.2	Relative Humidity: (%)	52-65	ATM Pressure: (kPa)	101.0-101.7
----------------------	-----------	---------------------------	-------	------------------------	-------------

Test Equipment List and Details:

Manufacturer	Description	Model	Serial Number	Calibration Date	Calibration Due Date
R&S	Spectrum Analyzer	FSU26	200256	2023/3/31	2024/3/30
zhuoxiang	Coaxial Cable	SMA-178	211002	Each time	N/A
YINSAIGE	Coaxial Cable	SS402	SJ0100002	Each time	N/A
eastsheep	Coaxial Attenuator	2W-SMA-JK-18G	21060301	Each time	N/A
R&S	Wideband Radio Communication Tester	CMW500	143458	2023/3/31	2024/3/30
BACL	TEMP&HUMI Test Chamber	BTH-150-40	30174	2023/3/31	2024/3/30
UNI-T	Multimeter	UT39A+	C210582554	2023/9/28	2024/9/27
ZHAOXIN	DC Power Supply	RXN-6010D	21R6010D0912386	N/A	N/A
Unknown	Coaxial tee connector	Unknown	2204005	Each time	N/A

* Statement of Traceability: China Certification ICT Co., Ltd (Dongguan) attests that all calibrations have been performed, traceable to National Primary Standards and International System of Units (SI).

Test Frequency for Each Mode:

Operation Bandwidth	Lowest Frequency (MHz)	Middle Frequency (MHz)	Highest Frequency (MHz)
1.4MHz	1710.7	1732.5	1754.3
3MHz	1711.5	1732.5	1753.5
5MHz	1712.5	1732.5	1752.5
10MHz	1715	1732.5	1750
15MHz	1717.5	1732.5	1747.5
20MHz	1720	1732.5	1745

Test Data:

RF Output Power						
Test Bandwidth & Modulation	Resource Block & RB offset	Conducted Average Output Power(dBm)			Maximum EIRP (dBm)	EIRP Limit (dBm)
		Lowest Channel	Middle Channel	Highest Channel		
1.4MHz QPSK	RB1#0	18.81	18.21	18.64	19.41	30
	RB1#3	19.03	18.50	18.72		
	RB1#5	18.81	18.22	18.58		
	RB3#0	18.85	18.33	18.66		
	RB3#3	18.90	18.36	18.65		
	RB6#0	17.87	17.28	17.64		
1.4MHz 16QAM	RB1#0	17.93	17.27	17.61	18.51	30
	RB1#3	18.13	17.43	17.76		
	RB1#5	17.93	17.27	17.64		
	RB3#0	17.81	17.40	17.82		
	RB3#3	17.85	17.37	17.84		
	RB6#0	16.93	16.26	16.71		
3MHz QPSK	RB1#0	18.92	17.98	18.62	19.3	30
	RB1#8	18.86	17.99	18.61		
	RB1#14	18.82	17.92	18.58		
	RB6#0	17.81	17.00	17.60		
	RB6#9	17.84	16.99	17.56		
	RB15#0	17.85	17.02	17.61		
3MHz 16QAM	RB1#0	17.90	17.64	17.73	18.28	30
	RB1#8	17.87	17.61	17.73		
	RB1#14	17.86	17.57	17.75		
	RB6#0	16.79	16.12	16.65		
	RB6#9	16.81	16.09	16.61		
	RB15#0	16.94	16.12	16.59		
5MHz QPSK	RB1#0	18.77	18.86	18.10	19.3	30
	RB1#13	18.89	18.92	18.17		
	RB1#24	18.76	18.82	18.11		
	RB15#0	17.89	17.92	17.17		
	RB15#10	17.85	17.90	17.12		
	RB25#0	17.84	17.90	17.12		
5MHz 16QAM	RB1#0	17.87	17.82	17.37	18.33	30
	RB1#13	17.95	17.85	17.48		
	RB1#24	17.87	17.72	17.38		
	RB15#0	16.94	17.02	16.17		
	RB15#10	16.93	16.96	16.13		
	RB25#0	16.91	16.99	16.16		
10MHz QPSK	RB1#0	18.82	18.66	18.76	19.41	30
	RB1#25	19.03	18.77	18.89		
	RB1#49	18.80	18.54	18.72		

	RB25#0	17.87	17.68	17.76		
	RB25#25	17.79	17.65	17.73		
	RB50#0	17.86	17.72	17.72		
10MHz 16QAM	RB1#0	17.87	18.30	17.91	18.79	30
	RB1#25	17.99	18.41	18.03		
	RB1#49	17.83	18.16	17.85		
	RB25#0	17.00	16.76	16.80		
	RB25#25	16.91	16.74	16.76		
	RB50#0	16.92	16.74	16.75		
15MHz QPSK	RB1#0	18.81	18.30	18.67	19.23	30
	RB1#38	18.85	18.25	18.73		
	RB1#74	18.67	18.12	18.56		
	RB36#0	17.87	17.30	17.74		
	RB36#39	17.87	17.30	17.67		
	RB75#0	17.86	17.31	17.70		
15MHz 16QAM	RB1#0	18.45	17.41	18.11	18.83	30
	RB1#38	18.45	17.41	18.12		
	RB1#74	18.31	17.28	17.96		
	RB36#0	16.89	16.33	16.71		
	RB36#39	16.85	16.33	16.67		
	RB75#0	16.91	16.34	16.71		
20MHz QPSK	RB1#0	18.71	17.97	18.57	19.4	30
	RB1#50	19.02	18.26	18.94		
	RB1#99	18.68	17.87	18.49		
	RB50#0	17.95	17.24	17.76		
	RB50#50	17.86	17.21	17.69		
	RB100#0	17.92	17.24	17.75		
20MHz 16QAM	RB1#0	17.91	17.54	17.87	18.62	30
	RB1#50	18.20	17.90	18.24		
	RB1#99	17.82	17.45	17.82		
	RB50#0	16.97	16.27	16.74		
	RB50#50	16.89	16.25	16.73		
	RB100#0	16.94	16.26	16.79		

Note: EIRP=Conducted Power(dBm) - Lc(dB) + G_T(dBi)

Result:

Pass

Peak-to-average Ratio (PAR)

Test Bandwidth & Modulation	Resource Block & RB offset	Peak-to-average Ratio(dB)			Limit (dB)
		Lowest Channel	Middle Channel	Highest Channel	
20MHz QPSK	RB1#0	8.59	8.88	8.30	13
	RB100#0	6.31	6.44	6.47	13
20MHz 16QAM	RB1#0	8.46	8.72	8.56	13
	RB100#0	7.02	7.18	7.05	13
				Result:	Pass

Occupied Bandwidth						
Operation Mode	99% Occupied Bandwidth (MHz)			26 dB Occupied Bandwidth (MHz)		
	Low Channel	Middle channel	High Channel	Low Channel	Middle Channel	High Channel
1.4MHz QPSK	1.104	1.098	1.098	1.308	1.284	1.302
1.4MHz 16QAM	1.092	1.092	1.110	1.296	1.296	1.314
3MHz QPSK	2.687	2.687	2.687	2.868	2.880	2.892
3MHz 16QAM	2.687	2.687	2.687	2.892	2.880	2.868
5MHz QPSK	4.500	4.520	4.520	4.900	4.920	4.940
5MHz 16QAM	4.500	4.500	4.520	4.960	4.900	4.960
10MHz QPSK	8.960	8.960	8.960	9.600	9.640	9.560
10MHz 16QAM	8.960	8.960	8.960	9.600	9.560	9.680
15MHz QPSK	13.500	13.500	13.500	14.760	14.760	14.904
15MHz 16QAM	13.560	13.500	13.500	14.820	14.820	14.640
20MHz QPSK	18.000	18.000	17.920	19.520	19.280	19.360
20MHz 16QAM	18.000	18.000	18.000	19.440	19.280	19.360

Note: The test plots please refer to the Plots of Occupied Bandwidth

Spurious Emissions at Antenna Terminal	
Result:	Pass, Please refer to the test plots of Spurious Emissions at Antenna Terminal.

Out of band emission, Band Edge	
Result:	Pass, Please refer to the test plots of Out of band emission, Band Edge.

Frequency Stability						
Test Mode:	20M QPSK	Test Channel: Lowest for Lower Edge, Highest for Upper Edge				
Test Item	Temperature (°C)	Voltage (V _{DC})	Lower Edge (MHz)		Upper Edge (MHz)	
			Result	Limit	Result	Limit
Frequency Stability vs. Temperature	-30	3.8	1711.033	1710.00	1754.045	1755
	-20	3.8	1711.039	1710.00	1754.066	1755
	-10	3.8	1711.017	1710.00	1754.057	1755
	0	3.8	1711.014	1710.00	1754.062	1755
	10	3.8	1711.015	1710.00	1754.048	1755
	20	3.8	1711.040	1710.00	1754.040	1755
	30	3.8	1711.027	1710.00	1754.042	1755
	40	3.8	1711.018	1710.00	1754.041	1755
Frequency Stability vs. Voltage	20	3.6	1711.022	1710.00	1754.041	1755
	20	4.35	1711.011	1710.00	1754.058	1755
					Result:	Pass

Test Mode:	20M 16QAM	Test Channel: Lowest for Lower Edge, Highest for Upper Edge				
Test Item	Temperature (°C)	Voltage (V _{DC})	Lower Edge (MHz)		Upper Edge (MHz)	
			Result	Limit	Result	Limit
Frequency Stability vs. Temperature	-30	3.8	1711.021	1710.00	1754.047	1755
	-20	3.8	1711.019	1710.00	1754.046	1755
	-10	3.8	1711.012	1710.00	1754.044	1755
	0	3.8	1711.022	1710.00	1754.068	1755
	10	3.8	1711.033	1710.00	1754.067	1755
	20	3.8	1711.040	1710.00	1754.040	1755
	30	3.8	1711.028	1710.00	1754.050	1755
	40	3.8	1711.013	1710.00	1754.057	1755
	50	3.8	1711.033	1710.00	1754.043	1755
Frequency Stability vs. Voltage	20	3.6	1711.024	1710.00	1754.047	1755
	20	4.35	1711.030	1710.00	1754.046	1755
					Result:	Pass

Test Plots:

Please refer to the below plots.

Note: The 14.5 dB is the Insertion loss of the RF cable and Power Splitter, which was offset into the Spectrum Analyzer.

Test Plots for Occupied Bandwidth:
Note: The test is performed in full RB mode.

Occupied Bandwidth

Channel	1.4MHz Bandwidth QPSK	1.4MHz Bandwidth 16QAM
Lowest	<p>ProjectNo.:CR231169741-RF Tester: Claire Liu Date: 1.DEC.2023 23:12:04</p>	<p>ProjectNo.:CR231169741-RF Tester: Claire Liu Date: 1.DEC.2023 23:12:17</p>
Middle	<p>ProjectNo.:CR231169741-RF Tester: Claire Liu Date: 1.DEC.2023 23:12:32</p>	<p>ProjectNo.:CR231169741-RF Tester: Claire Liu Date: 1.DEC.2023 23:12:45</p>
Highest	<p>ProjectNo.:CR231169741-RF Tester: Claire Liu Date: 1.DEC.2023 23:12:59</p>	<p>ProjectNo.:CR231169741-RF Tester: Claire Liu Date: 1.DEC.2023 23:13:12</p>

Occupied Bandwidth

Channel	3MHz Bandwidth QPSK	3MHz Bandwidth 16QAM
Lowest	<p>ProjectNo.:CR231169741-RF Tester: Claire Liu Date: 1.DEC.2023 23:13:55</p>	<p>ProjectNo.:CR231169741-RF Tester: Claire Liu Date: 1.DEC.2023 23:14:11</p>
Middle	<p>ProjectNo.:CR231169741-RF Tester: Claire Liu Date: 1.DEC.2023 23:14:25</p>	<p>ProjectNo.:CR231169741-RF Tester: Claire Liu Date: 1.DEC.2023 23:14:42</p>
Highest	<p>ProjectNo.:CR231169741-RF Tester: Claire Liu Date: 1.DEC.2023 23:14:59</p>	<p>ProjectNo.:CR231169741-RF Tester: Claire Liu Date: 1.DEC.2023 23:15:12</p>

Occupied Bandwidth

Channel	5MHz Bandwidth QPSK	5MHz Bandwidth 16QAM
Lowest	<p>ProjectNo.:CR231169741-RF Tester:Clair Liu Date: 1.DEC.2023 23:15:55</p>	<p>ProjectNo.:CR231169741-RF Tester:Clair Liu Date: 1.DEC.2023 23:16:11</p>
Middle	<p>ProjectNo.:CR231169741-RF Tester:Clair Liu Date: 1.DEC.2023 23:16:25</p>	<p>ProjectNo.:CR231169741-RF Tester:Clair Liu Date: 1.DEC.2023 23:16:42</p>
Highest	<p>ProjectNo.:CR231169741-RF Tester:Clair Liu Date: 1.DEC.2023 23:16:59</p>	<p>ProjectNo.:CR231169741-RF Tester:Clair Liu Date: 1.DEC.2023 23:17:15</p>

Occupied Bandwidth

Channel	10MHz Bandwidth QPSK	10MHz Bandwidth 16QAM
Lowest	<p>ProjectNo.:CR231169741-RF Tester: Claire Liu Date: 1.DEC.2023 23:17:55</p>	<p>ProjectNo.:CR231169741-RF Tester: Claire Liu Date: 1.DEC.2023 23:18:08</p>
Middle	<p>ProjectNo.:CR231169741-RF Tester: Claire Liu Date: 1.DEC.2023 23:18:22</p>	<p>ProjectNo.:CR231169741-RF Tester: Claire Liu Date: 1.DEC.2023 23:18:36</p>
Highest	<p>ProjectNo.:CR231169741-RF Tester: Claire Liu Date: 1.DEC.2023 23:18:53</p>	<p>ProjectNo.:CR231169741-RF Tester: Claire Liu Date: 1.DEC.2023 23:19:10</p>

Occupied Bandwidth

Channel	15MHz Bandwidth QPSK	15MHz Bandwidth 16QAM
Lowest	<p>ProjectNo.:CR231169741-RF Tester: Claire Liu Date: 1.DEC.2023 23:19:49</p>	<p>ProjectNo.:CR231169741-RF Tester: Claire Liu Date: 1.DEC.2023 23:20:02</p>
Middle	<p>ProjectNo.:CR231169741-RF Tester: Claire Liu Date: 1.DEC.2023 23:20:17</p>	<p>ProjectNo.:CR231169741-RF Tester: Claire Liu Date: 1.DEC.2023 23:20:31</p>
Highest	<p>ProjectNo.:CR231169741-RF Tester: Claire Liu Date: 19.DEC.2023 10:42:31</p>	<p>ProjectNo.:CR231169741-RF Tester: Claire Liu Date: 1.DEC.2023 23:21:02</p>

Occupied Bandwidth

Channel	20MHz Bandwidth QPSK	20MHz Bandwidth 16QAM
Lowest	<p>ProjectNo.:CR231169741-RF Tester: Claire Liu Date: 1.DEC.2023 23:21:41</p>	<p>ProjectNo.:CR231169741-RF Tester: Claire Liu Date: 1.DEC.2023 23:21:55</p>
Middle	<p>ProjectNo.:CR231169741-RF Tester: Claire Liu Date: 1.DEC.2023 23:22:09</p>	<p>ProjectNo.:CR231169741-RF Tester: Claire Liu Date: 1.DEC.2023 23:22:22</p>
Highest	<p>ProjectNo.:CR231169741-RF Tester: Claire Liu Date: 1.DEC.2023 23:22:37</p>	<p>ProjectNo.:CR231169741-RF Tester: Claire Liu Date: 1.DEC.2023 23:22:55</p>

Test Plots for Spurious Emissions at Antenna Terminal:
Note: The test is performed in 1 RB mode.

Spurious Emissions at Antenna Terminal

Channel	1.4MHz Bandwidth QPSK	
Lowest	<p>Ref: 40 dBm *Att: 35 dB *RBW 100 kHz Marker 1 [T1] -34.29 dBm *VSW 300 kHz *SWT 100 ms 365.62000000 MHz</p> <p>Start: 30 MHz 97 MHz/ Stop: 1 GHz</p> <p>ProjectNo.:CR231169741-RF Tester: Claire Liu Date: 4.DEC.2023 11:29:19</p>	<p>Ref: 40 dBm *Att: 35 dB *RBW 3 MHz Marker 1 [T1] -22.22 dBm *VSW 3 MHz *SWT 110 ms 3.161858974 GHz</p> <p>Start: 1 GHz 1.9 GHz/ Stop: 20 GHz</p> <p>ProjectNo.:CR231169741-RF Tester: Claire Liu Date: 4.DEC.2023 11:30:11</p>
Middle	<p>Ref: 40 dBm *Att: 35 dB *RBW 100 kHz Marker 1 [T1] -34.39 dBm *VSW 300 kHz *SWT 100 ms 563.50000000 MHz</p> <p>Start: 30 MHz 97 MHz/ Stop: 1 GHz</p> <p>ProjectNo.:CR231169741-RF Tester: Claire Liu Date: 4.DEC.2023 11:32:10</p>	<p>Ref: 40 dBm *Att: 35 dB *RBW 3 MHz Marker 1 [T1] -23.45 dBm *VSW 3 MHz *SWT 110 ms 3.161858974 GHz</p> <p>Start: 1 GHz 1.9 GHz/ Stop: 20 GHz</p> <p>ProjectNo.:CR231169741-RF Tester: Claire Liu Date: 4.DEC.2023 11:31:40</p>
Highest	<p>Ref: 40 dBm *Att: 35 dB *RBW 100 kHz Marker 1 [T1] -34.35 dBm *VSW 300 kHz *SWT 100 ms 125.06000000 MHz</p> <p>Start: 30 MHz 97 MHz/ Stop: 1 GHz</p> <p>ProjectNo.:CR231169741-RF Tester: Claire Liu Date: 4.DEC.2023 11:32:37</p>	<p>Ref: 40 dBm *Att: 35 dB *RBW 3 MHz Marker 1 [T1] -23.55 dBm *VSW 3 MHz *SWT 110 ms 3.161858974 GHz</p> <p>Start: 1 GHz 1.9 GHz/ Stop: 20 GHz</p> <p>ProjectNo.:CR231169741-RF Tester: Claire Liu Date: 4.DEC.2023 11:33:42</p>

Spurious Emissions at Antenna Terminal

Channel

3MHz Bandwidth QPSK

Lowest

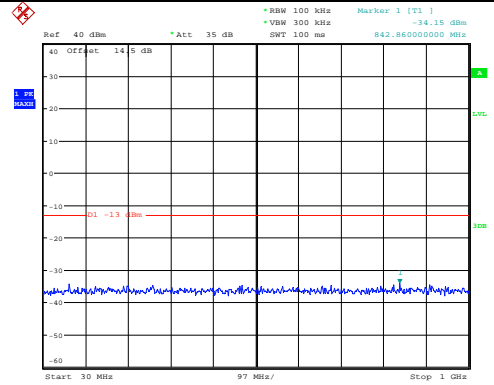

ProjectNo.:CR231169741-RF Tester:Clair Liu
Date: 4.DEC.2023 11:36:03

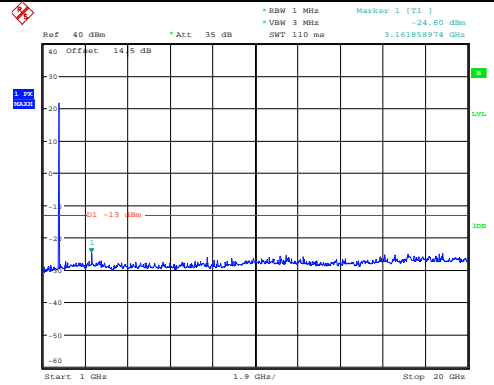

ProjectNo.:CR231169741-RF Tester:Clair Liu
Date: 4.DEC.2023 11:35:36

Middle

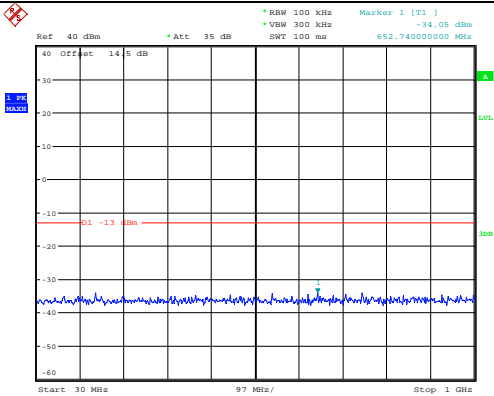

ProjectNo.:CR231169741-RF Tester:Clair Liu
Date: 4.DEC.2023 11:36:35

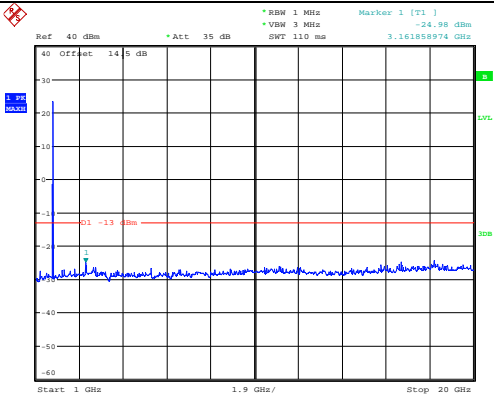

ProjectNo.:CR231169741-RF Tester:Clair Liu
Date: 4.DEC.2023 11:37:33

Highest

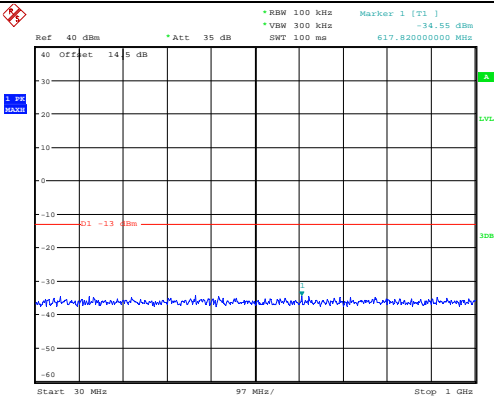

ProjectNo.:CR231169741-RF Tester:Clair Liu
Date: 4.DEC.2023 11:40:40

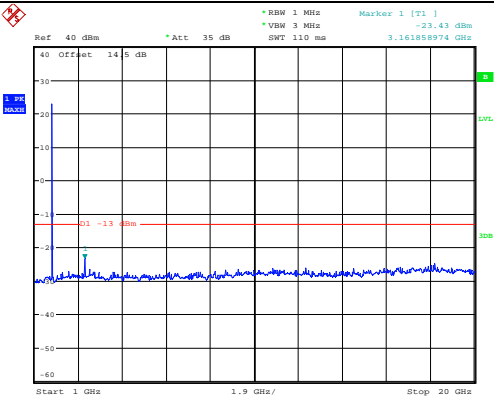

ProjectNo.:CR231169741-RF Tester:Clair Liu
Date: 4.DEC.2023 11:38:50

Spurious Emissions at Antenna Terminal

Channel	5MHz Bandwidth QPSK	
Lowest	<p>Ref 40 dBm *Att 35 dB *RBW 100 kHz *VSW 300 kHz *SWT 100 ms Marker 1 [T1] -23.22 dBm 740.04000000 MHz</p> <p>Start 30 MHz 97 MHz/ Stop 1 GHz</p> <p>ProjectNo.:CR231169741-RF Tester: Claire Liu Date: 4.DEC.2023 11:41:40</p>	<p>Ref 40 dBm *Att 35 dB *RBW 3 MHz *VSW 3 MHz *SWT 110 ms Marker 1 [T1] -23.09 dBm 3.161858974 GHz</p> <p>Start 1 GHz 1.9 GHz/ Stop 20 GHz</p> <p>ProjectNo.:CR231169741-RF Tester: Claire Liu Date: 4.DEC.2023 11:42:45</p>
Middle	<p>Ref 40 dBm *Att 35 dB *RBW 100 kHz *VSW 300 kHz *SWT 100 ms Marker 1 [T1] -34.75 dBm 509.18000000 MHz</p> <p>Start 30 MHz 97 MHz/ Stop 1 GHz</p> <p>ProjectNo.:CR231169741-RF Tester: Claire Liu Date: 4.DEC.2023 11:44:21</p>	<p>Ref 40 dBm *Att 35 dB *RBW 3 MHz *VSW 3 MHz *SWT 110 ms Marker 1 [T1] -23.30 dBm 3.161858974 GHz</p> <p>Start 1 GHz 1.9 GHz/ Stop 20 GHz</p> <p>ProjectNo.:CR231169741-RF Tester: Claire Liu Date: 4.DEC.2023 11:43:56</p>
Highest	<p>Ref 40 dBm *Att 35 dB *RBW 100 kHz *VSW 300 kHz *SWT 100 ms Marker 1 [T1] -34.19 dBm 262.80000000 MHz</p> <p>Start 30 MHz 97 MHz/ Stop 1 GHz</p> <p>ProjectNo.:CR231169741-RF Tester: Claire Liu Date: 4.DEC.2023 11:44:51</p>	<p>Ref 40 dBm *Att 35 dB *RBW 3 MHz *VSW 3 MHz *SWT 110 ms Marker 1 [T1] -22.43 dBm 3.161858974 GHz</p> <p>Start 1 GHz 1.9 GHz/ Stop 20 GHz</p> <p>ProjectNo.:CR231169741-RF Tester: Claire Liu Date: 4.DEC.2023 11:45:52</p>

Spurious Emissions at Antenna Terminal

Channel

10MHz Bandwidth QPSK

Lowest

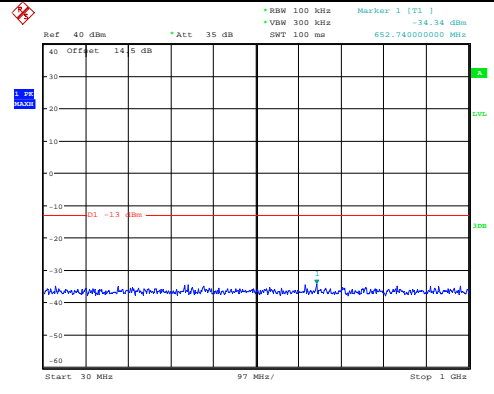

ProjectNo.:CR231169741-RF Tester:Clair Liu
Date: 4.DEC.2023 11:48:22

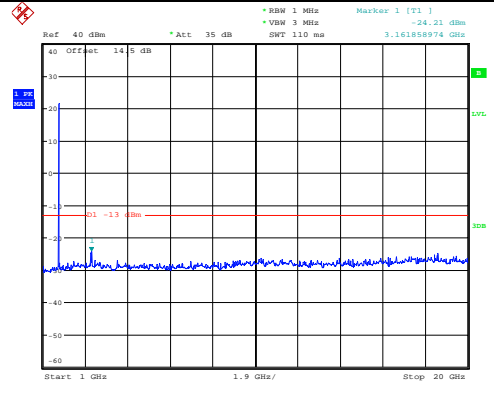

ProjectNo.:CR231169741-RF Tester:Clair Liu
Date: 4.DEC.2023 11:47:43

Middle

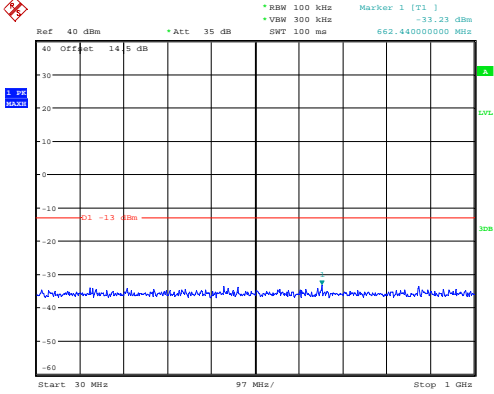

ProjectNo.:CR231169741-RF Tester:Clair Liu
Date: 4.DEC.2023 11:48:46

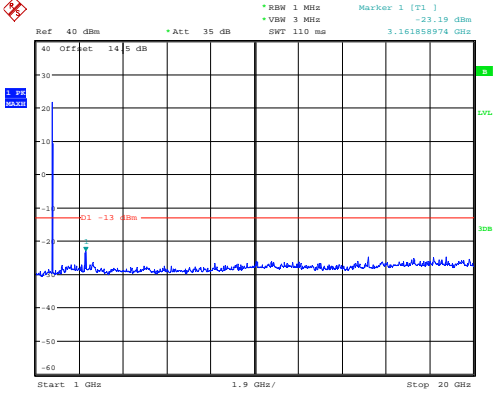

ProjectNo.:CR231169741-RF Tester:Clair Liu
Date: 4.DEC.2023 11:49:25

Highest

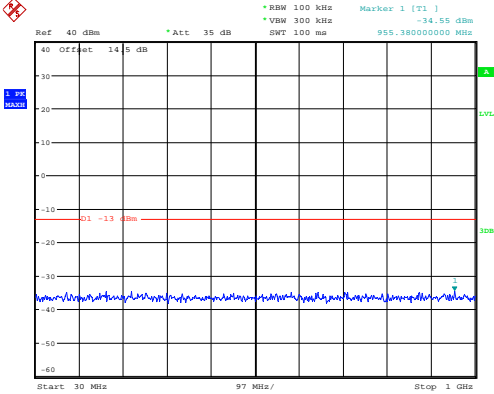

ProjectNo.:CR231169741-RF Tester:Clair Liu
Date: 4.DEC.2023 11:51:03

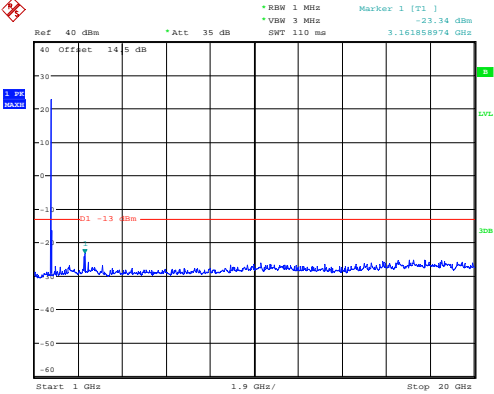

ProjectNo.:CR231169741-RF Tester:Clair Liu
Date: 4.DEC.2023 11:50:40

Spurious Emissions at Antenna Terminal

Channel

15MHz Bandwidth QPSK

Lowest

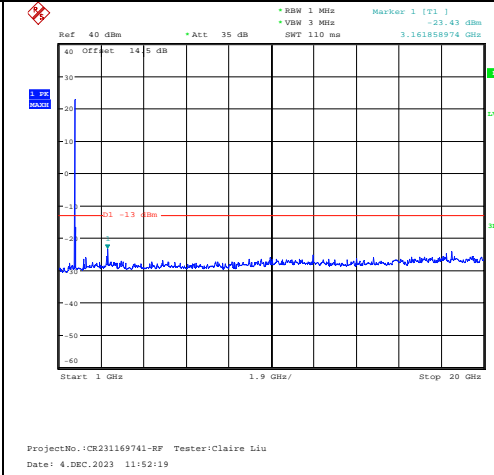
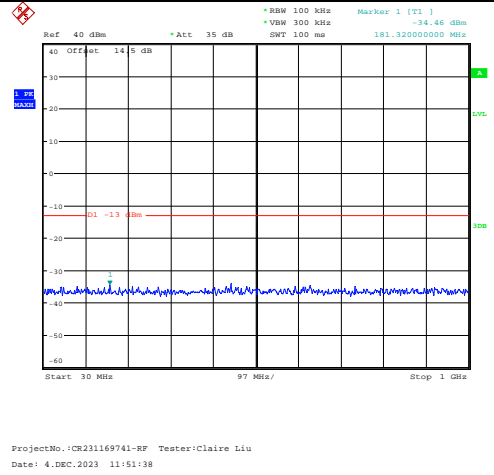

Middle

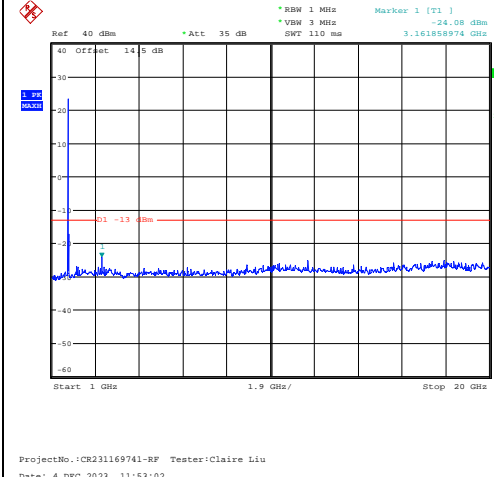
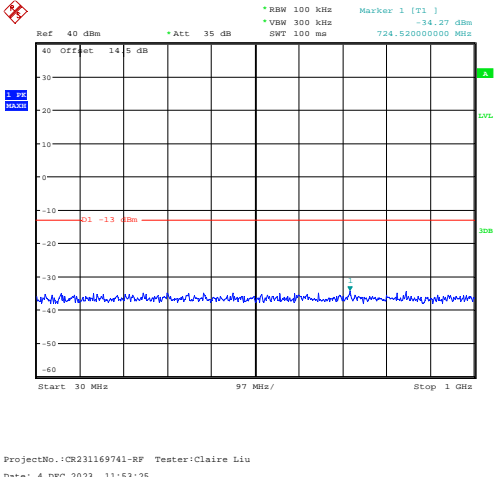

Highest

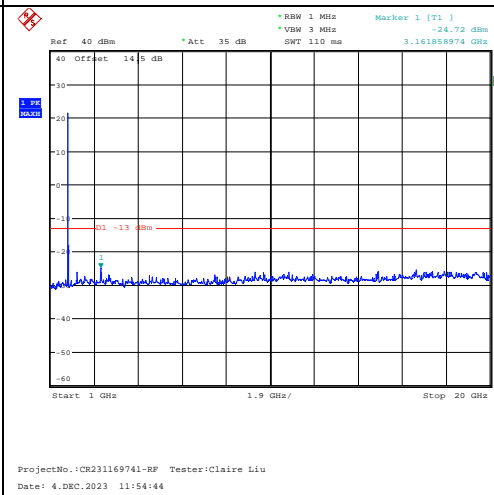
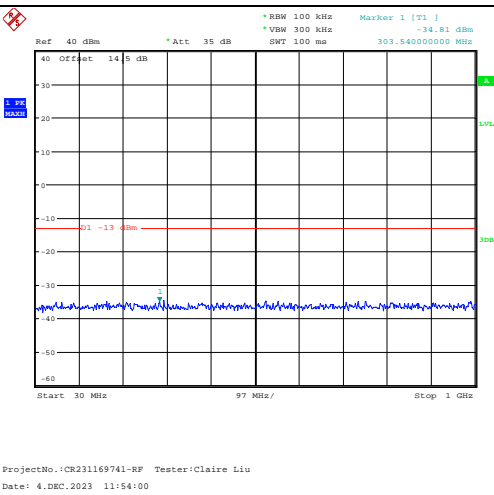

Spurious Emissions at Antenna Terminal

Channel

20MHz Bandwidth QPSK

Lowest

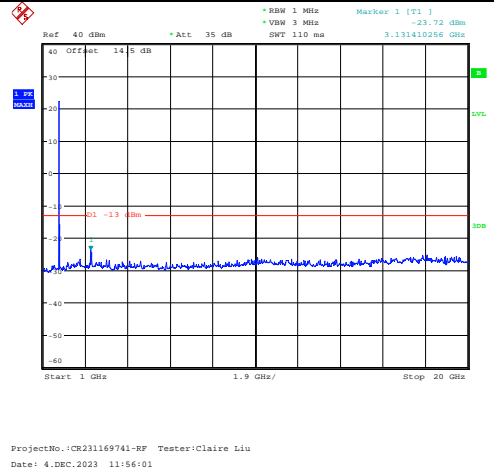
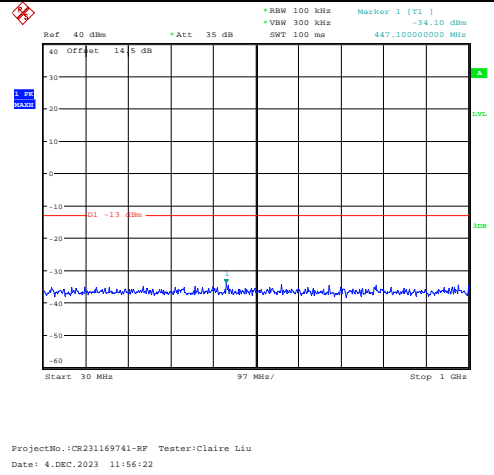

Middle

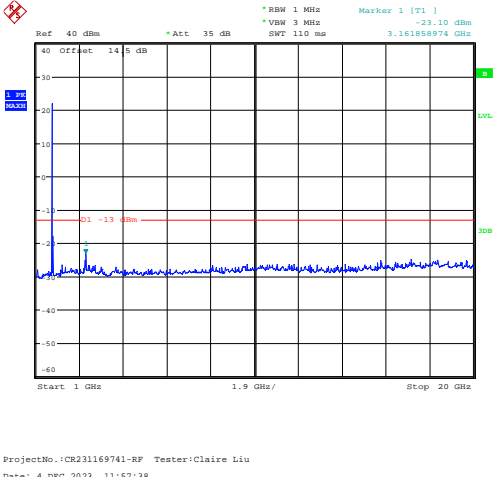
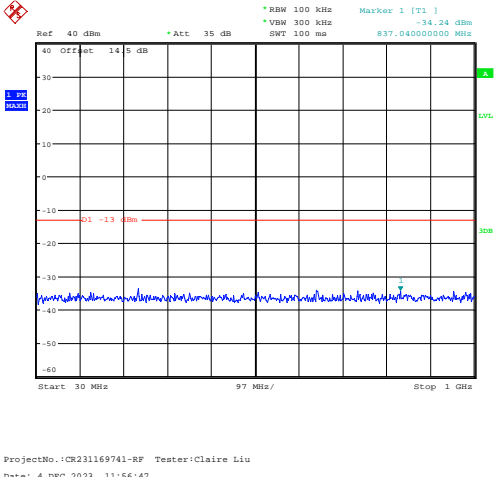

Highest

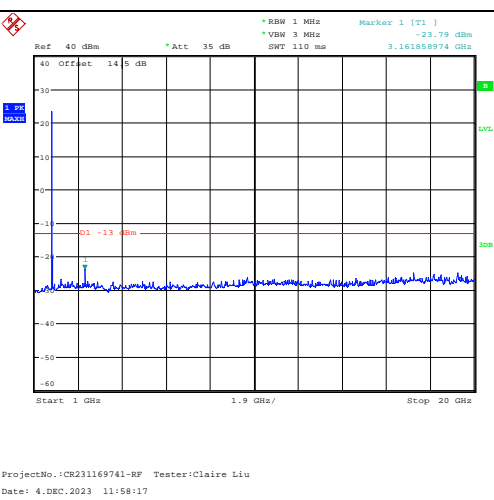
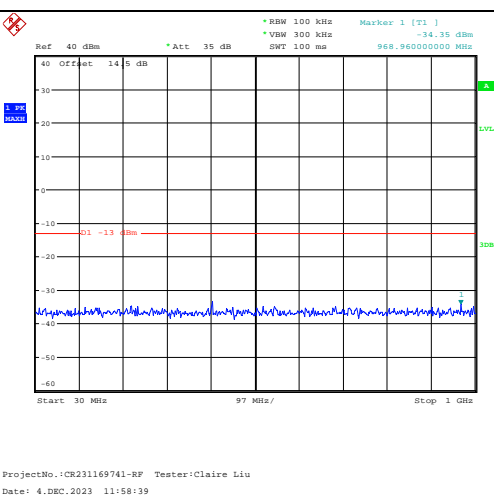

Test Plots for Out of band emission, Band Edge:
Note: The test is performed in 1 RB mode.

Out of band emission, Band Edge

Mode	Lowest	Highest
QPSK 1.4MHz	<p>ProjectNo.:CR231169741-RF Tester:Arthur Su Date: 4.DEC.2023 20:26:06</p>	<p>ProjectNo.:CR231169741-RF Tester:Arthur Su Date: 4.DEC.2023 20:27:45</p>
QPSK 3MHz	<p>ProjectNo.:CR231169741-RF Tester:Arthur Su Date: 4.DEC.2023 20:37:01</p>	<p>ProjectNo.:CR231169741-RF Tester:Arthur Su Date: 4.DEC.2023 20:39:17</p>
QPSK 5MHz	<p>ProjectNo.:CR231169741-RF Tester:Arthur Su Date: 4.DEC.2023 20:41:20</p>	<p>ProjectNo.:CR231169741-RF Tester:Arthur Su Date: 4.DEC.2023 20:43:38</p>

Out of band emission, Band Edge

Mode	Lowest	Highest
QPSK 10MHz	<p>ProjectNo.:CR231169741-RF Tester:Arthur Su Date: 4.DEC.2023 20:45:51</p>	<p>ProjectNo.:CR231169741-RF Tester:Arthur Su Date: 4.DEC.2023 20:47:27</p>
QPSK 15MHz	<p>ProjectNo.:CR231169741-RF Tester:Arthur Su Date: 4.DEC.2023 20:50:13</p>	<p>ProjectNo.:CR231169741-RF Tester:Arthur Su Date: 4.DEC.2023 20:51:52</p>
QPSK 20MHz	<p>ProjectNo.:CR231169741-RF Tester:Arthur Su Date: 4.DEC.2023 20:59:31</p>	<p>ProjectNo.:CR231169741-RF Tester:Arthur Su Date: 4.DEC.2023 21:00:44</p>

Out of band emission, Band Edge

Mode	Lowest	Highest
16QAM 1.4MHz	<p>ProjectNo.:CR231169741-RF Tester:Arthur Su Date: 4.DEC.2023 20:26:38</p>	<p>ProjectNo.:CR231169741-RF Tester:Arthur Su Date: 4.DEC.2023 20:28:11</p>
16QAM 3MHz	<p>ProjectNo.:CR231169741-RF Tester:Arthur Su Date: 4.DEC.2023 20:37:38</p>	<p>ProjectNo.:CR231169741-RF Tester:Arthur Su Date: 4.DEC.2023 20:39:44</p>
16QAM 5MHz	<p>ProjectNo.:CR231169741-RF Tester:Arthur Su Date: 4.DEC.2023 20:42:02</p>	<p>ProjectNo.:CR231169741-RF Tester:Arthur Su Date: 4.DEC.2023 20:44:08</p>

Out of band emission, Band Edge

Mode	Lowest	Highest
16QAM 10MHz	<p>Ref 40 dBm *Att 35 dB *RBW 100 kHz *VSW 300 kHz *SWT 35 ms *Marker 1 [T1] -29.82 dBm 1.710000000 GHz</p> <p>Center 1.71 GHz 2 MHz/ Span 20 MHz</p> <p>ProjectNo.:CR231169741-RF Tester:Arthur Su Date: 4.DEC.2023 20:46:32</p>	<p>Ref 40 dBm *Att 35 dB *RBW 100 kHz *VSW 300 kHz *SWT 35 ms *Marker 1 [T1] -27.59 dBm 1.755000000 GHz</p> <p>Center 1.755 GHz 2 MHz/ Span 20 MHz</p> <p>ProjectNo.:CR231169741-RF Tester:Arthur Su Date: 4.DEC.2023 20:48:07</p>
16QAM 15MHz	<p>Ref 40 dBm *Att 35 dB *RBW 300 kHz *VSW 1 MHz *SWT 35 ms *Marker 1 [T1] -20.41 dBm 1.710000000 GHz</p> <p>Center 1.71 GHz 3 MHz/ Span 30 MHz</p> <p>ProjectNo.:CR231169741-RF Tester:Arthur Su Date: 4.DEC.2023 20:50:44</p>	<p>Ref 40 dBm *Att 35 dB *RBW 300 kHz *VSW 1 MHz *SWT 35 ms *Marker 1 [T1] -18.62 dBm 1.755000000 GHz</p> <p>Center 1.755 GHz 3 MHz/ Span 30 MHz</p> <p>ProjectNo.:CR231169741-RF Tester:Arthur Su Date: 4.DEC.2023 20:52:21</p>
16QAM 20MHz	<p>Ref 40 dBm *Att 35 dB *RBW 300 kHz *VSW 1 MHz *SWT 35 ms *Marker 1 [T1] -28.63 dBm 1.710000000 GHz</p> <p>Center 1.71 GHz 4 MHz/ Span 40 MHz</p> <p>ProjectNo.:CR231169741-RF Tester:Arthur Su Date: 4.DEC.2023 20:59:54</p>	<p>Ref 40 dBm *Att 35 dB *RBW 300 kHz *VSW 1 MHz *SWT 35 ms *Marker 1 [T1] -26.31 dBm 1.755000000 GHz</p> <p>Center 1.755 GHz 4 MHz/ Span 40 MHz</p> <p>ProjectNo.:CR231169741-RF Tester:Arthur Su Date: 4.DEC.2023 21:01:12</p>

Test Plots for Out of band emission, Band Edge:
Note: The test is performed in full RB mode.

Out of band emission, Band Edge

Mode	Lowest	Highest
QPSK 1.4MHz	<p>ProjectNo.:CR231169741-RF Tester: Claire Liu Date: 2.DEC.2023 11:03:01</p>	<p>ProjectNo.:CR231169741-RF Tester: Claire Liu Date: 2.DEC.2023 11:03:18</p>
QPSK 3MHz	<p>ProjectNo.:CR231169741-RF Tester: Claire Liu Date: 2.DEC.2023 11:14:55</p>	<p>ProjectNo.:CR231169741-RF Tester: Claire Liu Date: 2.DEC.2023 11:15:11</p>
QPSK 5MHz	<p>ProjectNo.:CR231169741-RF Tester: Claire Liu Date: 2.DEC.2023 11:16:20</p>	<p>ProjectNo.:CR231169741-RF Tester: Claire Liu Date: 2.DEC.2023 11:16:36</p>

Out of band emission, Band Edge

Mode	Lowest	Highest
QPSK 10MHz	<p>ProjectNo.:CR231169741-RF Tester: Claire Liu Date: 2.DEC.2023 11:17:18</p>	<p>ProjectNo.:CR231169741-RF Tester: Claire Liu Date: 2.DEC.2023 11:17:36</p>
QPSK 15MHz	<p>ProjectNo.:CR231169741-RF Tester: Claire Liu Date: 2.DEC.2023 11:30:49</p>	<p>ProjectNo.:CR231169741-RF Tester: Claire Liu Date: 2.DEC.2023 11:31:04</p>
QPSK 20MHz	<p>ProjectNo.:CR231169741-RF Tester: Claire Liu Date: 2.DEC.2023 11:33:02</p>	<p>ProjectNo.:CR231169741-RF Tester: Claire Liu Date: 2.DEC.2023 11:33:17</p>

Out of band emission, Band Edge

Mode	Lowest	Highest
16QAM 1.4MHz	<p>ProjectNo.:CR231169741-RF Tester:Clair Liu Date: 2.DEC.2023 11:03:09</p>	<p>ProjectNo.:CR231169741-RF Tester:Clair Liu Date: 2.DEC.2023 11:03:26</p>
16QAM 3MHz	<p>ProjectNo.:CR231169741-RF Tester:Clair Liu Date: 2.DEC.2023 11:15:03</p>	<p>ProjectNo.:CR231169741-RF Tester:Clair Liu Date: 2.DEC.2023 11:15:18</p>
16QAM 5MHz	<p>ProjectNo.:CR231169741-RF Tester:Clair Liu Date: 2.DEC.2023 11:16:28</p>	<p>ProjectNo.:CR231169741-RF Tester:Clair Liu Date: 2.DEC.2023 11:16:44</p>

Out of band emission, Band Edge

Mode	Lowest	Highest
16QAM 10MHz	<p>ProjectNo.:CR231169741-RF Tester: Claire Liu Date: 2.DEC.2023 11:17:27</p>	<p>ProjectNo.:CR231169741-RF Tester: Claire Liu Date: 2.DEC.2023 11:17:44</p>
16QAM 15MHz	<p>ProjectNo.:CR231169741-RF Tester: Claire Liu Date: 2.DEC.2023 11:30:56</p>	<p>ProjectNo.:CR231169741-RF Tester: Claire Liu Date: 2.DEC.2023 11:31:11</p>
16QAM 20MHz	<p>ProjectNo.:CR231169741-RF Tester: Claire Liu Date: 2.DEC.2023 11:33:09</p>	<p>ProjectNo.:CR231169741-RF Tester: Claire Liu Date: 2.DEC.2023 11:33:24</p>

4.8 Antenna Port Test Data and Results for LTE Band 5

Serial Number:	2E5M-1	Test Date:	2023/12/1-2023/12/5
Test Site:	RF	Test Mode:	Transmitting
Tester:	Claire Liu/Arthur Su	Test Result:	Pass

Environmental Conditions:

Temperature: (°C)	24.3-25.8	Relative Humidity: (%)	52-61	ATM Pressure: (kPa)	101-101.4
----------------------	-----------	---------------------------	-------	------------------------	-----------

Test Equipment List and Details:

Manufacturer	Description	Model	Serial Number	Calibration Date	Calibration Due Date
R&S	Spectrum Analyzer	FSU26	200256	2023/3/31	2024/3/30
zhuoxiang	Coaxial Cable	SMA-178	211002	Each time	N/A
YINSAIGE	Coaxial Cable	SS402	SJ0100002	Each time	N/A
eastsheep	Coaxial Attenuator	2W-SMA-JK-18G	21060301	Each time	N/A
R&S	Wideband Radio Communication Tester	CMW500	143458	2023/3/31	2024/3/30
BACL	TEMP&HUMI Test Chamber	BTH-150-40	30174	2023/3/31	2024/3/30
UNI-T	Multimeter	UT39A+	C210582554	2023/9/28	2024/9/27
ZHAOXIN	DC Power Supply	RXN-6010D	21R6010D0912386	N/A	N/A
Unknown	Coaxial tee connector	Unknown	2204005	Each time	N/A

* Statement of Traceability: China Certification ICT Co., Ltd (Dongguan) attests that all calibrations have been performed, traceable to National Primary Standards and International System of Units (SI).

Test Frequency for Each Mode:

Operation Bandwidth	Lowest Frequency (MHz)	Middle Frequency (MHz)	Highest Frequency (MHz)
1.4MHz	824.7	836.5	848.3
3MHz	825.5	836.5	847.5
5MHz	826.5	836.5	846.5
10MHz	829	836.5	844

Test Data:

RF Output Power						
Test Bandwidth & Modulation	Resource Block & RB offset	Conducted Average Output Power(dBm)			Maximum ERP (dBm)	ERP Limit (dBm)
		Lowest Channel	Middle Channel	Highest Channel		
1.4MHz QPSK	RB1#0	24.28	23.70	23.88	21.92	38.45
	RB1#3	24.44	23.89	24.04		
	RB1#5	24.28	23.67	23.89		
	RB3#0	24.38	23.77	23.98		
	RB3#3	24.34	23.81	23.93		
	RB6#0	23.34	22.77	22.90		
1.4MHz 16QAM	RB1#0	23.42	22.71	22.88	21.07	38.45
	RB1#3	23.59	22.90	23.00		
	RB1#5	23.38	22.70	22.84		
	RB3#0	23.35	22.87	23.15		
	RB3#3	23.35	22.85	23.17		
	RB6#0	22.36	21.71	21.93		
3MHz QPSK	RB1#0	24.42	24.35	24.18	21.9	38.45
	RB1#8	24.36	24.29	24.12		
	RB1#14	24.37	24.33	24.10		
	RB6#0	23.25	23.21	23.15		
	RB6#9	23.29	23.30	23.04		
	RB15#0	23.33	23.30	23.16		
3MHz 16QAM	RB1#0	23.53	23.36	23.79	21.27	38.45
	RB1#8	23.49	23.28	23.72		
	RB1#14	23.52	23.27	23.70		
	RB6#0	22.32	22.18	22.26		
	RB6#9	22.36	22.21	22.14		
	RB15#0	22.33	22.36	22.23		
5MHz QPSK	RB1#0	24.26	24.01	24.02	21.84	38.45
	RB1#13	24.36	24.13	24.09		
	RB1#24	24.27	23.98	23.97		
	RB15#0	23.25	23.12	23.14		
	RB15#10	23.23	23.17	22.92		
	RB25#0	23.20	23.15	22.97		
5MHz 16QAM	RB1#0	23.37	22.89	23.28	20.93	38.45
	RB1#13	23.45	23.02	23.41		
	RB1#24	23.36	22.88	23.26		
	RB15#0	22.31	22.15	22.12		
	RB15#10	22.28	22.20	21.92		
	RB25#0	22.28	22.21	22.01		
10MHz QPSK	RB1#0	24.37	24.31	23.94	22.04	38.45
	RB1#25	24.56	24.42	24.05		
	RB1#49	24.33	24.24	23.88		
	RB25#0	23.44	23.53	22.67		

	RB25#25	23.10	23.55	22.86		
	RB50#0	23.34	23.52	22.79		
10MHz 16QAM	RB1#0	23.35	23.95	23.11	21.51	38.45
	RB1#25	23.54	24.03	23.20		
	RB1#49	23.34	23.83	23.00		
	RB25#0	22.56	22.59	21.74		
	RB25#25	22.21	22.60	21.90		
	RB50#0	22.39	22.54	21.80		

Note:

ERP= Conducted Power(dBm) - Lc(dB) + G_T(dBd)G_T(dBd)=G_T(dBi)-2.15**Result:****Pass****Peak-to-average Ratio (PAR)**

Test Bandwidth & Modulation	Resource Block & RB offset	Peak-to-average Ratio(dB)			Limit (dB)
		Lowest Channel	Middle Channel	Highest Channel	
10MHz QPSK	RB1#0	4.90	5.38	5.26	13
	RB50#0	5.35	5.83	5.61	13
10MHz 16QAM	RB1#0	6.09	5.96	6.25	13
	RB50#0	6.35	6.63	6.57	13
				Result:	Pass

Occupied Bandwidth

Operation Mode	99% Occupied Bandwidth (MHz)			26 dB Occupied Bandwidth (MHz)		
	Low Channel	Middle channel	High Channel	Low Channel	Middle Channel	High Channel
1.4MHz QPSK	1.110	1.104	1.098	1.362	1.302	1.308
1.4MHz 16QAM	1.092	1.098	1.104	1.290	1.296	1.302
3MHz QPSK	2.687	2.687	2.687	2.880	2.880	2.868
3MHz 16QAM	2.687	2.687	2.676	2.868	2.892	2.868
5MHz QPSK	4.500	4.520	4.500	4.880	4.980	4.920
5MHz 16QAM	4.500	4.520	4.500	4.940	4.920	4.960
10MHz QPSK	8.920	9.000	8.920	9.480	9.640	9.480
10MHz 16QAM	8.920	8.960	8.920	9.560	9.600	9.440

Note: The test plots please refer to the Plots of Occupied Bandwidth

Spurious Emissions at Antenna Terminal**Result:****Pass, Please refer to the test plots of Spurious Emissions at Antenna Terminal.****Out of band emission, Band Edge****Result:****Pass, Please refer to the test plots of Out of band emission, Band Edge.**

Frequency Stability					
Test Modulation:	10 MHz QPSK		Test Channel:	836.5	MHz
Test Item	Temperature (°C)	Voltage (V _{DC})	Frequency Error		Limit
			(Hz)	(ppm)	(ppm)
Frequency Stability vs. Temperature	-30	3.8	38	0.045	2.5
	-20	3.8	4	0.004	2.5
	-10	3.8	13	0.015	2.5
	0	3.8	18	0.021	2.5
	10	3.8	1	0.001	2.5
	20	3.8	3	0.003	2.5
	30	3.8	6	0.007	2.5
	40	3.8	22	0.027	2.5
Frequency Stability vs. Voltage	50	3.8	39	0.046	2.5
	20	3.6	29	0.034	2.5
	20	4.35	27	0.032	2.5
				Result:	Pass

Test Modulation:	10 MHz 16QAM		Test Channel:	836.5	MHz
Test Item	Temperature (°C)	Voltage (V _{DC})	Frequency Error		Limit
			(Hz)	(ppm)	(ppm)
Frequency Stability vs. Temperature	-30	3.8	8	0.010	2.5
	-20	3.8	36	0.043	2.5
	-10	3.8	16	0.019	2.5
	0	3.8	7	0.008	2.5
	10	3.8	3	0.004	2.5
	20	3.8	2	0.002	2.5
	30	3.8	20	0.024	2.5
	40	3.8	31	0.037	2.5
Frequency Stability vs. Voltage	50	3.8	50	0.060	2.5
	20	3.6	10	0.012	2.5
	20	4.35	34	0.041	2.5
				Result:	Pass

Test Plots:

Please refer to the below plots.

Note: The 14.5 dB is the Insertion loss of the RF cable and Power Splitter, which was offset into the Spectrum Analyzer.

Test Plots for Occupied Bandwidth:
Note: The test is performed in full RB mode.

Occupied Bandwidth

Channel	1.4MHz Bandwidth QPSK	1.4MHz Bandwidth 16QAM
Lowest	<p>ProjectNo.:CR231169741-RF Tester: Claire Liu Date: 1.DEC.2023 23:23:27</p>	<p>ProjectNo.:CR231169741-RF Tester: Claire Liu Date: 1.DEC.2023 23:23:47</p>
Middle	<p>ProjectNo.:CR231169741-RF Tester: Claire Liu Date: 1.DEC.2023 23:24:04</p>	<p>ProjectNo.:CR231169741-RF Tester: Claire Liu Date: 1.DEC.2023 23:24:21</p>
Highest	<p>ProjectNo.:CR231169741-RF Tester: Claire Liu Date: 1.DEC.2023 23:24:42</p>	<p>ProjectNo.:CR231169741-RF Tester: Claire Liu Date: 1.DEC.2023 23:24:59</p>

Occupied Bandwidth

Channel	3MHz Bandwidth QPSK	3MHz Bandwidth 16QAM
Lowest	<p>ProjectNo.:CR231169741-RF Tester:Claire Liu Date: 1.DEC.2023 23:25:58</p>	<p>ProjectNo.:CR231169741-RF Tester:Claire Liu Date: 1.DEC.2023 23:26:15</p>
Middle	<p>ProjectNo.:CR231169741-RF Tester:Claire Liu Date: 1.DEC.2023 23:26:32</p>	<p>ProjectNo.:CR231169741-RF Tester:Claire Liu Date: 1.DEC.2023 23:26:49</p>
Highest	<p>ProjectNo.:CR231169741-RF Tester:Claire Liu Date: 1.DEC.2023 23:27:06</p>	<p>ProjectNo.:CR231169741-RF Tester:Claire Liu Date: 1.DEC.2023 23:27:23</p>

Occupied Bandwidth

Channel	5MHz Bandwidth QPSK	5MHz Bandwidth 16QAM
Lowest	<p>Ref 40 dBm *Att 35 dB *RSW 100 kHz Delta 1 [T1] 1.26 dB *VSW 300 kHz *OSW 4.880000000 MHz 40 Offset 14.5 dB Marker 1 [T1] 17.4 dB 844.040000000 MHz Temp 1 [T1 OSW] 17.4 dB Temp 2 [T1 OSW] 17.4 dB 848.760000000 MHz</p> <p>Center 826.5 MHz 1 MHz/ Span 10 MHz</p> <p>ProjectNo.:CR231169741-RF Tester:Clair Liu Date: 1.DEC.2023 23:28:13</p>	<p>Ref 40 dBm *Att 35 dB *RSW 100 kHz Delta 1 [T1] 0.13 dB *VSW 300 kHz *OSW 4.940000000 MHz 40 Offset 14.5 dB Marker 1 [T1] 16.0 dB 844.040000000 MHz Temp 1 [T1 OSW] 16.0 dB Temp 2 [T1 OSW] 16.0 dB 848.760000000 MHz</p> <p>Center 826.5 MHz 1 MHz/ Span 10 MHz</p> <p>ProjectNo.:CR231169741-RF Tester:Clair Liu Date: 1.DEC.2023 23:28:34</p>
Middle	<p>Ref 40 dBm *Att 35 dB *RSW 100 kHz Delta 1 [T1] 1.42 dB *VSW 300 kHz *OSW 4.980000000 MHz 40 Offset 14.5 dB Marker 1 [T1] 17.1 dB 844.040000000 MHz Temp 1 [T1 OSW] 17.1 dB Temp 2 [T1 OSW] 17.1 dB 848.760000000 MHz</p> <p>Center 836.5 MHz 1 MHz/ Span 10 MHz</p> <p>ProjectNo.:CR231169741-RF Tester:Clair Liu Date: 1.DEC.2023 23:28:51</p>	<p>Ref 40 dBm *Att 35 dB *RSW 100 kHz Delta 1 [T1] 0.51 dB *VSW 300 kHz *OSW 4.920000000 MHz 40 Offset 14.5 dB Marker 1 [T1] 16.7 dB 844.040000000 MHz Temp 1 [T1 OSW] 16.7 dB Temp 2 [T1 OSW] 16.7 dB 848.760000000 MHz</p> <p>Center 836.5 MHz 1 MHz/ Span 10 MHz</p> <p>ProjectNo.:CR231169741-RF Tester:Clair Liu Date: 1.DEC.2023 23:29:07</p>
Highest	<p>Ref 40 dBm *Att 35 dB *RSW 100 kHz Delta 1 [T1] 1.89 dB *VSW 300 kHz *OSW 4.920000000 MHz 40 Offset 14.5 dB Marker 1 [T1] 16.9 dB 844.040000000 MHz Temp 1 [T1 OSW] 16.9 dB Temp 2 [T1 OSW] 16.9 dB 848.760000000 MHz</p> <p>Center 846.5 MHz 1 MHz/ Span 10 MHz</p> <p>ProjectNo.:CR231169741-RF Tester:Clair Liu Date: 1.DEC.2023 23:29:35</p>	<p>Ref 40 dBm *Att 35 dB *RSW 100 kHz Delta 1 [T1] 0.00 dB *VSW 300 kHz *OSW 4.960000000 MHz 40 Offset 14.5 dB Marker 1 [T1] 15.6 dB 844.040000000 MHz Temp 1 [T1 OSW] 15.6 dB Temp 2 [T1 OSW] 15.6 dB 848.760000000 MHz</p> <p>Center 846.5 MHz 1 MHz/ Span 10 MHz</p> <p>ProjectNo.:CR231169741-RF Tester:Clair Liu Date: 1.DEC.2023 23:29:51</p>

Occupied Bandwidth

Channel	10MHz Bandwidth QPSK	10MHz Bandwidth 16QAM
Lowest	<p>ProjectNo.:CR231169741-RF Tester:Clair Liu Date: 1.DEC.2023 23:30:42</p>	<p>ProjectNo.:CR231169741-RF Tester:Clair Liu Date: 1.DEC.2023 23:30:58</p>
Middle	<p>ProjectNo.:CR231169741-RF Tester:Clair Liu Date: 1.DEC.2023 23:31:22</p>	<p>ProjectNo.:CR231169741-RF Tester:Clair Liu Date: 1.DEC.2023 23:31:39</p>
Highest	<p>ProjectNo.:CR231169741-RF Tester:Clair Liu Date: 1.DEC.2023 23:31:53</p>	<p>ProjectNo.:CR231169741-RF Tester:Clair Liu Date: 1.DEC.2023 23:32:07</p>

Test Plots for Spurious Emissions at Antenna Terminal:
Note: The test is performed in IRB mode.

Spurious Emissions at Antenna Terminal	
Channel	1.4MHz Bandwidth QPSK
Lowest	<p>ProjectNo.:CR231169741-RF Tester: Claire Liu Date: 4.DEC.2023 13:13:51</p> <p>ProjectNo.:CR231169741-RF Tester: Claire Liu Date: 4.DEC.2023 13:14:25</p>
Middle	<p>ProjectNo.:CR231169741-RF Tester: Claire Liu Date: 4.DEC.2023 13:15:54</p> <p>ProjectNo.:CR231169741-RF Tester: Claire Liu Date: 4.DEC.2023 13:15:03</p>
Highest	<p>ProjectNo.:CR231169741-RF Tester: Claire Liu Date: 4.DEC.2023 13:17:05</p> <p>ProjectNo.:CR231169741-RF Tester: Claire Liu Date: 4.DEC.2023 13:17:29</p>

Spurious Emissions at Antenna Terminal

Channel	3MHz Bandwidth QPSK	
Lowest	<p>ProjectNo.:CR231169741-RF Tester:Clair Liu Date: 4.DEC.2023 13:20:38</p>	<p>ProjectNo.:CR231169741-RF Tester:Clair Liu Date: 4.DEC.2023 13:17:55</p>
Middle	<p>ProjectNo.:CR231169741-RF Tester:Clair Liu Date: 4.DEC.2023 13:21:38</p>	<p>ProjectNo.:CR231169741-RF Tester:Clair Liu Date: 4.DEC.2023 13:22:08</p>
Highest	<p>ProjectNo.:CR231169741-RF Tester:Clair Liu Date: 4.DEC.2023 13:24:44</p>	<p>ProjectNo.:CR231169741-RF Tester:Clair Liu Date: 4.DEC.2023 13:23:27</p>

Spurious Emissions at Antenna Terminal

Channel

5MHz Bandwidth QPSK

Lowest

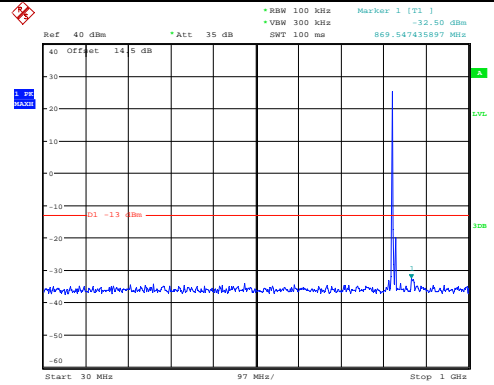

ProjectNo.:CR231169741-RF Tester:Clair Liu
 Date: 4.DEC.2023 13:27:54

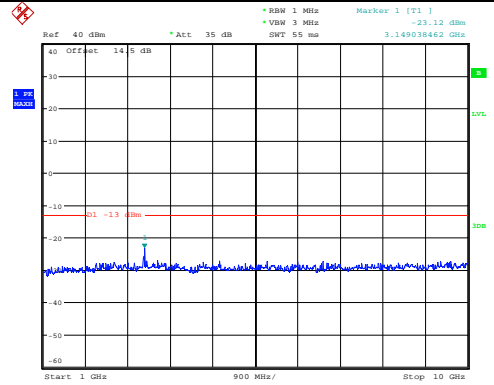

ProjectNo.:CR231169741-RF Tester:Clair Liu
 Date: 4.DEC.2023 13:28:20

Middle

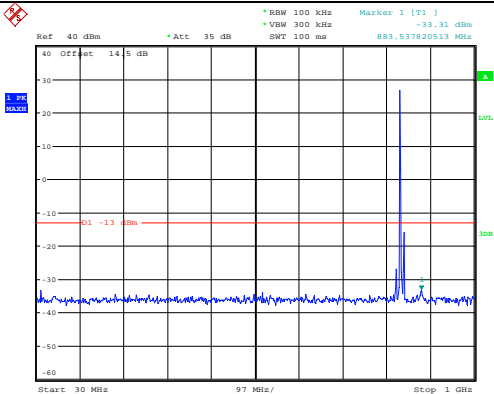

ProjectNo.:CR231169741-RF Tester:Clair Liu
 Date: 4.DEC.2023 13:29:39

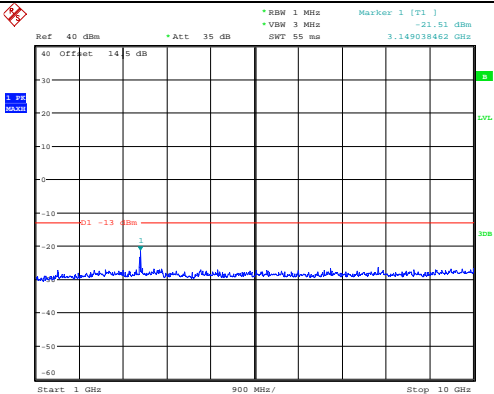

ProjectNo.:CR231169741-RF Tester:Clair Liu
 Date: 4.DEC.2023 13:28:44

Highest

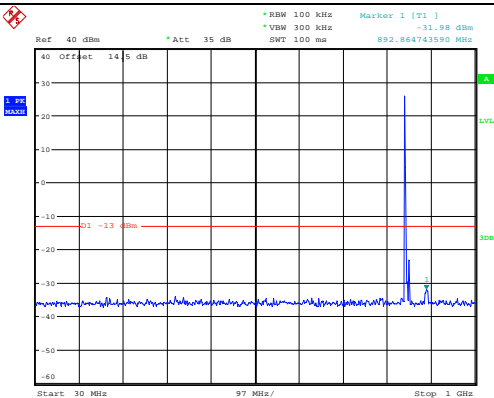

ProjectNo.:CR231169741-RF Tester:Clair Liu
 Date: 4.DEC.2023 13:30:44

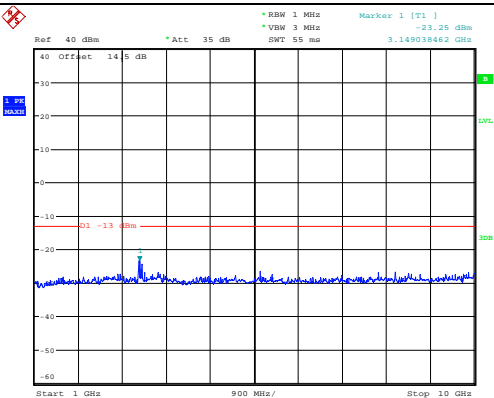

ProjectNo.:CR231169741-RF Tester:Clair Liu
 Date: 4.DEC.2023 13:31:20

Spurious Emissions at Antenna Terminal

Channel

10MHz Bandwidth QPSK

Lowest

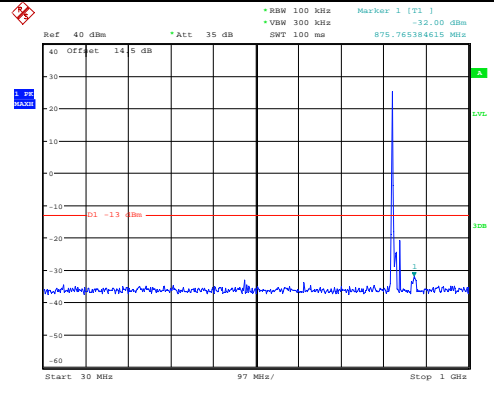

ProjectNo.:CR231169741-RF Tester:Clair Liu
Date: 4.DEC.2023 13:35:56

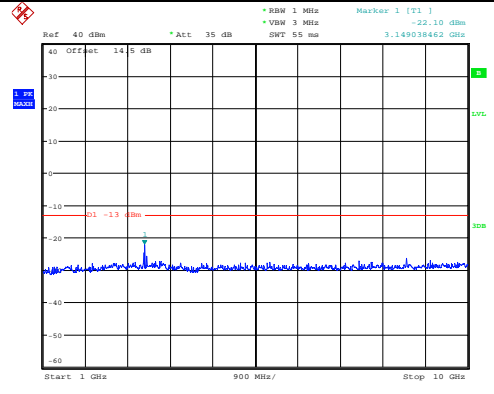

ProjectNo.:CR231169741-RF Tester:Clair Liu
Date: 4.DEC.2023 13:31:55

Middle

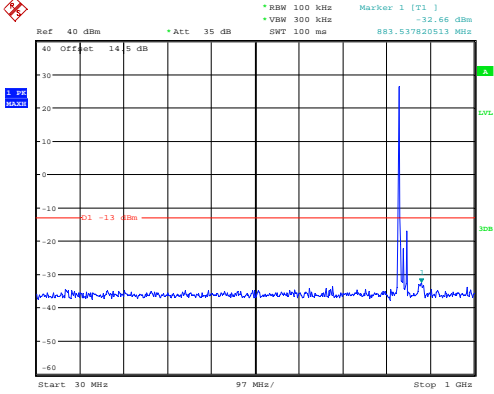

ProjectNo.:CR231169741-RF Tester:Clair Liu
Date: 4.DEC.2023 13:37:49

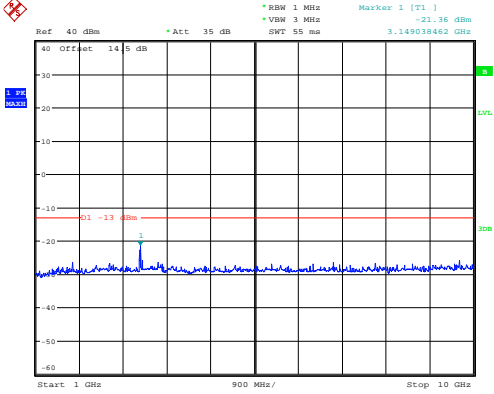

ProjectNo.:CR231169741-RF Tester:Clair Liu
Date: 4.DEC.2023 13:36:46

Highest

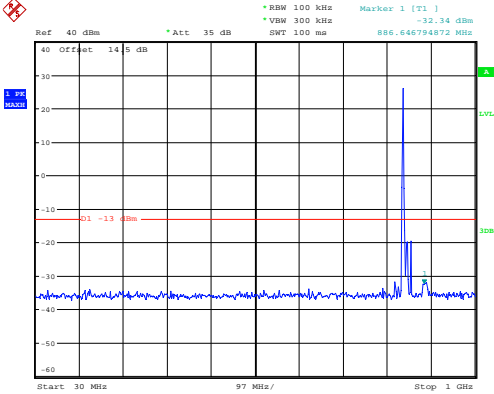

ProjectNo.:CR231169741-RF Tester:Clair Liu
Date: 4.DEC.2023 13:39:18

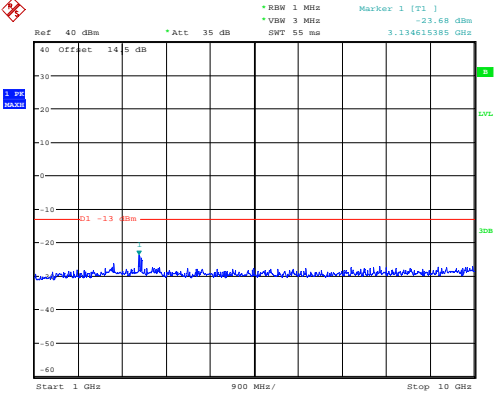

ProjectNo.:CR231169741-RF Tester:Clair Liu
Date: 4.DEC.2023 13:39:45

Test Plots for Out of band emission, Band Edge:
Note: The test is performed in IRB mode.

Out of band emission, Band Edge

Mode	Lowest	Highest
<p>QPSK 1.4MHz</p>	<p>ProjectNo.:CR231169741-RF Tester:Arthur Su Date: 4.DEC.2023 21:03:53</p>	<p>ProjectNo.:CR231169741-RF Tester:Arthur Su Date: 4.DEC.2023 21:05:36</p>
<p>QPSK 3MHz</p>	<p>ProjectNo.:CR231169741-RF Tester:Arthur Su Date: 4.DEC.2023 21:08:18</p>	<p>ProjectNo.:CR231169741-RF Tester:Arthur Su Date: 4.DEC.2023 21:10:18</p>
<p>QPSK 5MHz</p>	<p>ProjectNo.:CR231169741-RF Tester:Arthur Su Date: 4.DEC.2023 21:12:58</p>	<p>ProjectNo.:CR231169741-RF Tester:Arthur Su Date: 4.DEC.2023 21:14:13</p>

Out of band emission, Band Edge

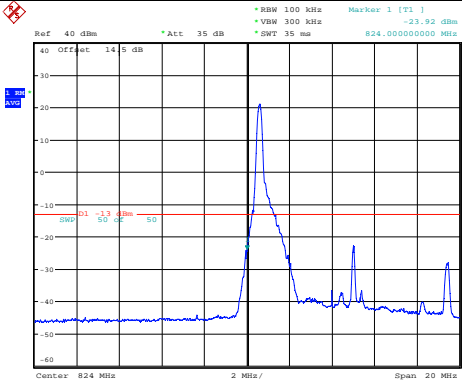
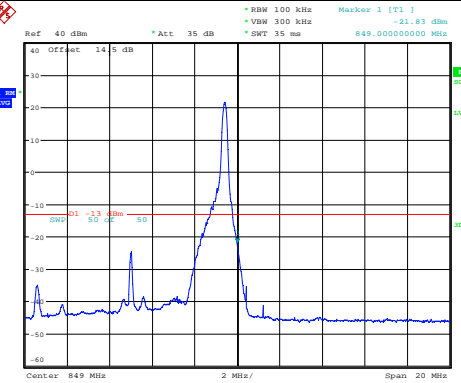
Mode	Lowest	Highest
<p>QPSK 10MHz</p>	 <p>Ref: 40 dBm *Att: 35 dB *RBW: 100 kHz *VBW: 300 kHz *SWT: 35 ms *Marker 1 [T1]: -23.52 dBm 824.00000000 MHz</p> <p>Center: 824 MHz 2 MHz/ Span: 20 MHz</p> <p>ProjectNo.: CR231169741-RF Tester: Arthur Su Date: 4.DEC.2023 21:17:54</p>	 <p>Ref: 40 dBm *Att: 35 dB *RBW: 100 kHz *VBW: 300 kHz *SWT: 35 ms *Marker 1 [T1]: -21.83 dBm 849.00000000 MHz</p> <p>Center: 849 MHz 2 MHz/ Span: 20 MHz</p> <p>ProjectNo.: CR231169741-RF Tester: Arthur Su Date: 4.DEC.2023 21:24:28</p>

Out of band emission, Band Edge

Mode	Lowest	Highest
16QAM 1.4MHz	<p>Ref 40 dBm *Att 35 dB *RBW 30 kHz *VSW 100 kHz *SWT 35 ms *Marker 1 [T1] -22.13 dBm 824.00000000 MHz</p> <p>40 Offset 14.5 dB -30 -20 -10 0 -10 -20 -30 -40 -50 -60</p> <p>Center 824 MHz 600 kHz/ Span 6 MHz</p> <p>ProjectNo.:CR231169741-RF Tester:Arthur Su Date: 4.DEC.2023 21:04:33</p>	<p>Ref 40 dBm *Att 35 dB *RBW 30 kHz *VSW 100 kHz *SWT 35 ms *Marker 1 [T1] -23.19 dBm 849.00000000 MHz</p> <p>40 Offset 14.5 dB -30 -20 -10 0 -10 -20 -30 -40 -50 -60</p> <p>Center 849 MHz 600 kHz/ Span 6 MHz</p> <p>ProjectNo.:CR231169741-RF Tester:Arthur Su Date: 4.DEC.2023 21:06:28</p>
16QAM 3MHz	<p>Ref 40 dBm *Att 35 dB *RBW 30 kHz *VSW 100 kHz *SWT 35 ms *Marker 1 [T1] -23.03 dBm 824.00000000 MHz</p> <p>40 Offset 14.5 dB -30 -20 -10 0 -10 -20 -30 -40 -50 -60</p> <p>Center 824 MHz 600 kHz/ Span 6 MHz</p> <p>ProjectNo.:CR231169741-RF Tester:Arthur Su Date: 4.DEC.2023 21:09:11</p>	<p>Ref 40 dBm *Att 35 dB *RBW 30 kHz *VSW 100 kHz *SWT 35 ms *Marker 1 [T1] -24.08 dBm 849.00000000 MHz</p> <p>40 Offset 14.5 dB -30 -20 -10 0 -10 -20 -30 -40 -50 -60</p> <p>Center 849 MHz 600 kHz/ Span 6 MHz</p> <p>ProjectNo.:CR231169741-RF Tester:Arthur Su Date: 4.DEC.2023 21:11:12</p>
16QAM 5MHz	<p>Ref 40 dBm *Att 35 dB *RBW 100 kHz *VSW 300 kHz *SWT 35 ms *Marker 1 [T1] -15.29 dBm 824.00000000 MHz</p> <p>40 Offset 14.5 dB -30 -20 -10 0 -10 -20 -30 -40 -50 -60</p> <p>Center 824 MHz 1 MHz/ Span 10 MHz</p> <p>ProjectNo.:CR231169741-RF Tester:Arthur Su Date: 4.DEC.2023 21:13:23</p>	<p>Ref 40 dBm *Att 35 dB *RBW 100 kHz *VSW 300 kHz *SWT 35 ms *Marker 1 [T1] -16.93 dBm 849.00000000 MHz</p> <p>40 Offset 14.5 dB -30 -20 -10 0 -10 -20 -30 -40 -50 -60</p> <p>Center 849 MHz 1 MHz/ Span 10 MHz</p> <p>ProjectNo.:CR231169741-RF Tester:Arthur Su Date: 4.DEC.2023 21:15:10</p>

Out of band emission, Band Edge

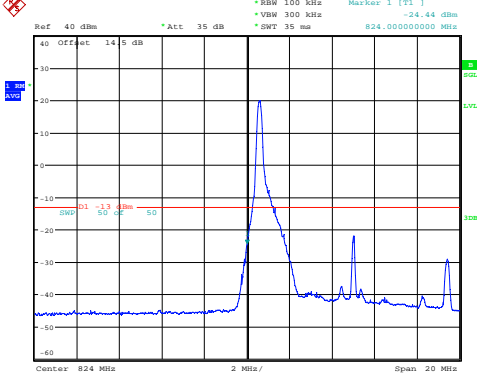
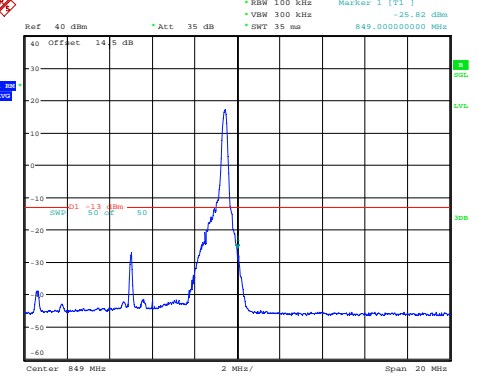
Mode	Lowest	Highest
<p>16QAM 10MHz</p>	 <p>Ref: 40 dBm *Att: 35 dB *RBW: 100 kHz *VBW: 300 kHz *SWT: 35 ms *Marker 1 [T1]: -24.44 dBm 824.00000000 MHz</p> <p>Center: 824 MHz 2 MHz/ Span: 20 MHz</p> <p>ProjectNo.:CR231169741-RF Tester:Arthur Su Date: 4.DEC.2023 21:20:39</p>	 <p>Ref: 40 dBm *Att: 35 dB *RBW: 100 kHz *VBW: 300 kHz *SWT: 35 ms *Marker 1 [T1]: -25.82 dBm 849.00000000 MHz</p> <p>Center: 849 MHz 2 MHz/ Span: 20 MHz</p> <p>ProjectNo.:CR231169741-RF Tester:Arthur Su Date: 4.DEC.2023 21:25:19</p>

Test Plots for Out of band emission, Band Edge:
Note: The test is performed in full RB mode.

Out of band emission, Band Edge

Mode	Lowest	Highest
QPSK 1.4MHz	<p>ProjectNo.:CR231169741-RF Tester: Claire Liu Date: 2.DEC.2023 11:33:37</p>	<p>ProjectNo.:CR231169741-RF Tester: Claire Liu Date: 2.DEC.2023 11:33:52</p>
QPSK 3MHz	<p>ProjectNo.:CR231169741-RF Tester: Claire Liu Date: 2.DEC.2023 11:44:24</p>	<p>ProjectNo.:CR231169741-RF Tester: Claire Liu Date: 2.DEC.2023 11:44:40</p>
QPSK 5MHz	<p>ProjectNo.:CR231169741-RF Tester: Claire Liu Date: 2.DEC.2023 11:45:27</p>	<p>ProjectNo.:CR231169741-RF Tester: Claire Liu Date: 2.DEC.2023 11:45:43</p>

Out of band emission, Band Edge

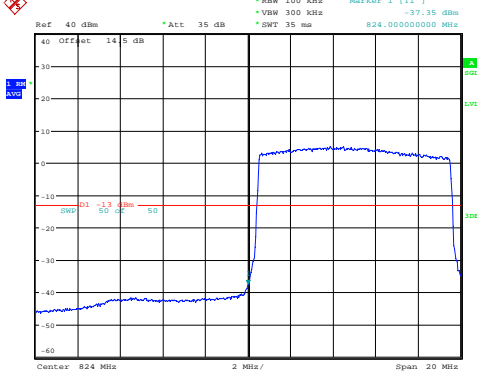
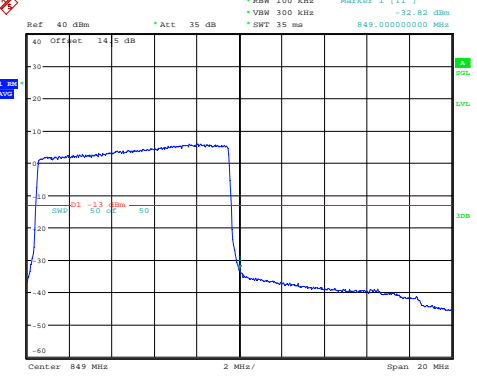
Mode	Lowest	Highest
<p>QPSK 10MHz</p>	 <p>ProjectNo.:CR231169741-RF Tester: Claire Liu Date: 2.DEC.2023 11:47:15</p>	 <p>ProjectNo.:CR231169741-RF Tester: Claire Liu Date: 2.DEC.2023 11:47:33</p>

Out of band emission, Band Edge

Mode	Lowest	Highest
16QAM 1.4MHz	<p>ProjectNo.:CR231169741-RF Tester: Claire Liu Date: 2.DEC.2023 11:33:44</p>	<p>ProjectNo.:CR231169741-RF Tester: Claire Liu Date: 2.DEC.2023 11:34:00</p>
16QAM 3MHz	<p>ProjectNo.:CR231169741-RF Tester: Claire Liu Date: 2.DEC.2023 11:44:32</p>	<p>ProjectNo.:CR231169741-RF Tester: Claire Liu Date: 2.DEC.2023 11:44:48</p>
16QAM 5MHz	<p>ProjectNo.:CR231169741-RF Tester: Claire Liu Date: 2.DEC.2023 11:45:35</p>	<p>ProjectNo.:CR231169741-RF Tester: Claire Liu Date: 2.DEC.2023 11:45:51</p>

Out of band emission, Band Edge

Mode	Lowest	Highest
<p>16QAM 10MHz</p>	<p>ProjectNo.:CR231169741-RF Tester:Clairre Liu Date: 2.DEC.2023 11:47:23</p>	<p>ProjectNo.:CR231169741-RF Tester:Clairre Liu Date: 2.DEC.2023 11:47:42</p>

4.9 Antenna Port Test Data and Results for LTE Band 12

Serial Number:	2E5M-1	Test Date:	2023/12/1-2023/12/5
Test Site:	RF	Test Mode:	Transmitting
Tester:	Claire Liu/Arthur Su	Test Result:	Pass

Environmental Conditions:

Temperature: (°C)	24.3-25.8	Relative Humidity: (%)	52-61	ATM Pressure: (kPa)	101-101.4
----------------------	-----------	---------------------------	-------	------------------------	-----------

Test Equipment List and Details:

Manufacturer	Description	Model	Serial Number	Calibration Date	Calibration Due Date
R&S	Spectrum Analyzer	FSU26	200256	2023/3/31	2024/3/30
zhuoxiang	Coaxial Cable	SMA-178	211002	Each time	N/A
YINSAIGE	Coaxial Cable	SS402	SJ0100002	Each time	N/A
eastsheep	Coaxial Attenuator	2W-SMA-JK-18G	21060301	Each time	N/A
R&S	Wideband Radio Communication Tester	CMW500	143458	2023/3/31	2024/3/30
BACL	TEMP&HUMI Test Chamber	BTH-150-40	30174	2023/3/31	2024/3/30
UNI-T	Multimeter	UT39A+	C210582554	2023/9/28	2024/9/27
ZHAOXIN	DC Power Supply	RXN-6010D	21R6010D0912386	N/A	N/A
Unknown	Coaxial tee connector	Unknown	2204005	Each time	N/A

* Statement of Traceability: China Certification ICT Co., Ltd (Dongguan) attests that all calibrations have been performed, traceable to National Primary Standards and International System of Units (SI).

Test Frequency for Each Mode:

Operation Bandwidth	Lowest Frequency (MHz)	Middle Frequency (MHz)	Highest Frequency (MHz)
1.4MHz	699.7	707.5	715.3
3MHz	700.5	707.5	714.5
5MHz	701.5	707.5	713.5
10MHz	704	707.5	711

Test Data:

RF Output Power						
Test Bandwidth & Modulation	Resource Block & RB offset	Conducted Average Output Power(dBm)			Maximum ERP (dBm)	ERP Limit (dBm)
		Lowest Channel	Middle Channel	Highest Channel		
1.4MHz QPSK	RB1#0	24.82	24.81	24.78	22.17	34.77
	RB1#3	24.99	24.94	24.90		
	RB1#5	24.91	24.81	24.75		
	RB3#0	24.90	24.87	24.87		
	RB3#3	24.95	24.92	24.87		
	RB6#0	23.87	23.88	23.85		
1.4MHz 16QAM	RB1#0	23.95	23.82	23.77	21.34	34.77
	RB1#3	24.16	24.02	23.94		
	RB1#5	23.99	23.88	23.77		
	RB3#0	23.89	24.00	24.05		
	RB3#3	23.95	24.02	24.04		
	RB6#0	22.96	22.85	22.89		
3MHz QPSK	RB1#0	24.83	24.80	24.83	22.07	34.77
	RB1#8	24.89	24.72	24.80		
	RB1#14	24.81	24.71	24.80		
	RB6#0	23.90	23.70	23.73		
	RB6#9	23.86	23.76	23.76		
	RB15#0	23.92	23.81	23.81		
3MHz 16QAM	RB1#0	24.52	23.94	23.92	21.7	34.77
	RB1#8	24.45	23.90	23.83		
	RB1#14	24.45	23.91	23.86		
	RB6#0	22.89	22.74	22.80		
	RB6#9	22.87	22.87	22.79		
	RB15#0	23.03	22.79	22.94		
5MHz QPSK	RB1#0	24.84	24.82	24.77	22.11	34.77
	RB1#13	24.93	24.88	24.85		
	RB1#24	24.82	24.78	24.74		
	RB15#0	24.10	23.78	23.97		
	RB15#10	23.89	24.12	23.73		
	RB25#0	23.95	23.99	23.80		
5MHz 16QAM	RB1#0	23.67	24.17	23.88	21.4	34.77
	RB1#13	23.86	24.22	23.93		
	RB1#24	23.73	24.09	23.85		
	RB15#0	23.16	22.78	23.08		
	RB15#10	22.94	23.05	22.76		
	RB25#0	23.04	22.96	22.88		
10MHz QPSK	RB1#0	24.85	24.88	24.88	22.16	34.77
	RB1#25	24.97	24.98	24.98		
	RB1#49	24.82	24.83	24.82		

	RB25#0	24.11	23.79	23.62		
	RB25#25	24.18	24.15	23.67		
	RB50#0	24.15	24.05	23.69		
10MHz 16QAM	RB1#0	24.48	24.04	23.89	21.82	34.77
	RB1#25	24.64	24.18	24.03		
	RB1#49	24.47	23.99	23.84		
	RB25#0	23.17	22.89	22.75		
	RB25#25	23.23	23.19	22.82		
	RB50#0	23.20	23.05	22.72		

Note:

ERP= Conducted Power(dBm) - Lc(dB) + G_T(dBd)G_T(dBd)=G_T(dBi)-2.15

Result:	Pass
----------------	-------------

Peak-to-average Ratio(PAR)

Test Bandwidth & Modulation	Resource Block & RB offset	Peak-to-average Ratio(dB)			Limit (dB)
		Lowest Channel	Middle Channel	Highest Channel	
10MHz QPSK	RB1#0	5.22	5.19	4.87	13
	RB50#0	5.80	5.58	5.58	13
10MHz 16QAM	RB1#0	6.47	6.38	5.74	13
	RB50#0	6.57	6.54	6.51	13

Result:	Pass
----------------	-------------

Occupied Bandwidth

Operation Mode	99% Occupied Bandwidth (MHz)			26 dB Occupied Bandwidth (MHz)		
	Low Channel	Middle channel	High Channel	Low Channel	Middle Channel	High Channel
1.4MHz QPSK	1.104	1.110	1.098	1.320	1.302	1.302
1.4MHz 16QAM	1.092	1.098	1.110	1.284	1.296	1.326
3MHz QPSK	2.687	2.687	2.687	2.892	2.868	2.880
3MHz 16QAM	2.687	2.687	2.687	2.880	2.868	2.880
5MHz QPSK	4.520	4.540	4.540	5.160	5.160	5.240
5MHz 16QAM	4.540	4.520	4.560	5.260	5.180	5.220
10MHz QPSK	8.960	8.960	8.960	9.960	9.880	9.800
10MHz 16QAM	8.960	8.960	8.960	9.920	9.680	9.760

Note: The test plots please refer to the Plots of Occupied Bandwidth

Spurious Emissions at Antenna Terminal

Result:	Pass, Please refer to the test plots of Spurious Emissions at Antenna Terminal.
----------------	--

Out of band emission, Band Edge

Result:	Pass, Please refer to the test plots of Out of band emission, Band Edge.
----------------	---

Frequency Stability						
Test Mode:	10M QPSK	Test Channel: Lowest for Lower Edge,Highest for Upper Edge				
Test Item	Temperature (°C)	Voltage (V _{DC})	Lower Edge (MHz)		Upper Edge (MHz)	
			Result	Limit	Result	Limit
Frequency Stability vs. Temperature	-30	3.8	699.506	699.00	715.499	716.00
	-20	3.8	699.519	699.00	715.497	716.00
	-10	3.8	699.497	699.00	715.484	716.00
	0	3.8	699.498	699.00	715.497	716.00
	10	3.8	699.509	699.00	715.509	716.00
	20	3.8	699.520	699.00	715.480	716.00
	30	3.8	699.503	699.00	715.501	716.00
	40	3.8	699.497	699.00	715.508	716.00
	50	3.8	699.491	699.00	715.506	716.00
Frequency Stability vs. Voltage	20	3.6	699.496	699.00	715.490	716.00
	20	4.35	699.506	699.00	715.492	716.00
					Result:	Pass

Frequency Stability						
Test Mode:	10M 16QAM	Test Channel: Lowest for Lower Edge,Highest for Upper Edge				
Test Item	Temperature (°C)	Voltage (V _{DC})	Lower Edge (MHz)		Upper Edge (MHz)	
			Result	Limit	Result	Limit
Frequency Stability vs. Temperature	-30	3.8	699.508	699.00	715.494	716.00
	-20	3.8	699.511	699.00	715.493	716.00
	-10	3.8	699.512	699.00	715.492	716.00
	0	3.8	699.505	699.00	715.486	716.00
	10	3.8	699.511	699.00	715.492	716.00
	20	3.8	699.520	699.00	715.480	716.00
	30	3.8	699.513	699.00	715.492	716.00
	40	3.8	699.505	699.00	715.495	716.00
	50	3.8	699.495	699.00	715.488	716.00
Frequency Stability vs. Voltage	20	3.6	699.498	699.00	715.498	716.00
	20	4.35	699.514	699.00	715.501	716.00
					Result:	Pass

Test Plots:

Please refer to the below plots.

Note: The 14.5 dB is the Insertion loss of the RF cable and Power Splitter, which was offset into the Spectrum Analyzer.

Test Plots for Occupied Bandwidth:
Note: The test is performed in full RB mode.

Occupied Bandwidth		
Channel	1.4MHz Bandwidth QPSK	1.4MHz Bandwidth 16QAM
Lowest	<p>ProjectNo.:CR231169741-RF Tester: Claire Liu Date: 1.DEC.2023 23:32:29</p>	<p>ProjectNo.:CR231169741-RF Tester: Claire Liu Date: 1.DEC.2023 23:32:43</p>
Middle	<p>ProjectNo.:CR231169741-RF Tester: Claire Liu Date: 1.DEC.2023 23:33:00</p>	<p>ProjectNo.:CR231169741-RF Tester: Claire Liu Date: 1.DEC.2023 23:33:16</p>
Highest	<p>ProjectNo.:CR231169741-RF Tester: Claire Liu Date: 1.DEC.2023 23:33:37</p>	<p>ProjectNo.:CR231169741-RF Tester: Claire Liu Date: 1.DEC.2023 23:33:54</p>

Occupied Bandwidth

Channel	3MHz Bandwidth QPSK	3MHz Bandwidth 16QAM
Lowest	<p>ProjectNo.:CR231169741-RF Tester: Claire Liu Date: 1.DEC.2023 23:34:36</p>	<p>ProjectNo.:CR231169741-RF Tester: Claire Liu Date: 1.DEC.2023 23:34:50</p>
Middle	<p>ProjectNo.:CR231169741-RF Tester: Claire Liu Date: 1.DEC.2023 23:35:07</p>	<p>ProjectNo.:CR231169741-RF Tester: Claire Liu Date: 1.DEC.2023 23:35:20</p>
Highest	<p>ProjectNo.:CR231169741-RF Tester: Claire Liu Date: 1.DEC.2023 23:35:38</p>	<p>ProjectNo.:CR231169741-RF Tester: Claire Liu Date: 1.DEC.2023 23:35:55</p>

Occupied Bandwidth

Channel	5MHz Bandwidth QPSK	5MHz Bandwidth 16QAM
Lowest	<p>Ref 40 dBm *Att 35 dB *RSW 100 kHz *VSW 300 kHz Delta 1 [T1] 1.40 dB SWT 5 ms 5.160000000 MHz OSW 4.520000000 MHz Marker 1 [T1] 17.13 dB 698.940000000 MHz 17.13 dB Temp 1 [T1 OSW] 703.760000000 MHz 17.13 dB Temp 2 [T1 OSW]</p> <p>Center 701.5 MHz 1 MHz/ Span 10 MHz</p> <p>ProjectNo.:CR231169741-RF Tester: Claire Liu Date: 1.DEC.2023 23:36:37</p>	<p>Ref 40 dBm *Att 35 dB *RSW 100 kHz *VSW 300 kHz Delta 1 [T1] 0.57 dB SWT 5 ms 5.260000000 MHz OSW 4.540000000 MHz Marker 1 [T1] 14.8 dB 698.880000000 MHz 14.8 dB Temp 1 [T1 OSW] 703.780000000 MHz 14.8 dB Temp 2 [T1 OSW]</p> <p>Center 701.5 MHz 1 MHz/ Span 10 MHz</p> <p>ProjectNo.:CR231169741-RF Tester: Claire Liu Date: 1.DEC.2023 23:36:53</p>
Middle	<p>Ref 40 dBm *Att 35 dB *RSW 100 kHz *VSW 300 kHz Delta 1 [T1] 1.22 dB SWT 5 ms 5.160000000 MHz OSW 4.540000000 MHz Marker 1 [T1] 17.1 dB 704.940000000 MHz 17.1 dB Temp 1 [T1 OSW] 709.780000000 MHz 17.1 dB Temp 2 [T1 OSW]</p> <p>Center 707.5 MHz 1 MHz/ Span 10 MHz</p> <p>ProjectNo.:CR231169741-RF Tester: Claire Liu Date: 1.DEC.2023 23:37:11</p>	<p>Ref 40 dBm *Att 35 dB *RSW 100 kHz *VSW 300 kHz Delta 1 [T1] 1.07 dB SWT 5 ms 5.180000000 MHz OSW 4.520000000 MHz Marker 1 [T1] 15.6 dB 704.990000000 MHz 15.6 dB Temp 1 [T1 OSW] 709.760000000 MHz 15.6 dB Temp 2 [T1 OSW]</p> <p>Center 707.5 MHz 1 MHz/ Span 10 MHz</p> <p>ProjectNo.:CR231169741-RF Tester: Claire Liu Date: 1.DEC.2023 23:37:28</p>
Highest	<p>Ref 40 dBm *Att 35 dB *RSW 100 kHz *VSW 300 kHz Delta 1 [T1] -0.61 dB SWT 5 ms 5.240000000 MHz OSW 4.540000000 MHz Marker 1 [T1] 16.3 dB 710.880000000 MHz 16.3 dB Temp 1 [T1 OSW] 715.760000000 MHz 16.3 dB Temp 2 [T1 OSW]</p> <p>Center 713.5 MHz 1 MHz/ Span 10 MHz</p> <p>ProjectNo.:CR231169741-RF Tester: Claire Liu Date: 1.DEC.2023 23:37:51</p>	<p>Ref 40 dBm *Att 35 dB *RSW 100 kHz *VSW 300 kHz Delta 1 [T1] 0.04 dB SWT 5 ms 5.220000000 MHz OSW 4.560000000 MHz Marker 1 [T1] 16.0 dB 710.880000000 MHz 16.0 dB Temp 1 [T1 OSW] 715.780000000 MHz 16.0 dB Temp 2 [T1 OSW]</p> <p>Center 713.5 MHz 1 MHz/ Span 10 MHz</p> <p>ProjectNo.:CR231169741-RF Tester: Claire Liu Date: 1.DEC.2023 23:38:08</p>

Occupied Bandwidth

Channel	10MHz Bandwidth QPSK	10MHz Bandwidth 16QAM
Lowest	<p>ProjectNo.:CR231169741-RF Tester: Claire Liu Date: 1.DEC.2023 23:38:50</p>	<p>ProjectNo.:CR231169741-RF Tester: Claire Liu Date: 1.DEC.2023 23:39:03</p>
Middle	<p>ProjectNo.:CR231169741-RF Tester: Claire Liu Date: 1.DEC.2023 23:39:21</p>	<p>ProjectNo.:CR231169741-RF Tester: Claire Liu Date: 1.DEC.2023 23:39:38</p>
Highest	<p>ProjectNo.:CR231169741-RF Tester: Claire Liu Date: 1.DEC.2023 23:39:55</p>	<p>ProjectNo.:CR231169741-RF Tester: Claire Liu Date: 1.DEC.2023 23:40:12</p>

Test Plots for Spurious Emissions at Antenna Terminal:
Note: The test is performed in IRB mode.

Spurious Emissions at Antenna Terminal	
Channel	1.4MHz Bandwidth QPSK
Lowest	<p>ProjectNo.:CR231169741-RF Tester: Claire Liu Date: 4.DEC.2023 13:43:17</p>
Middle	<p>ProjectNo.:CR231169741-RF Tester: Claire Liu Date: 4.DEC.2023 13:45:03</p>
Highest	<p>ProjectNo.:CR231169741-RF Tester: Claire Liu Date: 4.DEC.2023 13:45:56</p>
	<p>ProjectNo.:CR231169741-RF Tester: Claire Liu Date: 4.DEC.2023 13:43:45</p>
	<p>ProjectNo.:CR231169741-RF Tester: Claire Liu Date: 4.DEC.2023 13:44:13</p>
	<p>ProjectNo.:CR231169741-RF Tester: Claire Liu Date: 4.DEC.2023 13:46:23</p>

Spurious Emissions at Antenna Terminal

Channel

3MHz Bandwidth QPSK

Lowest

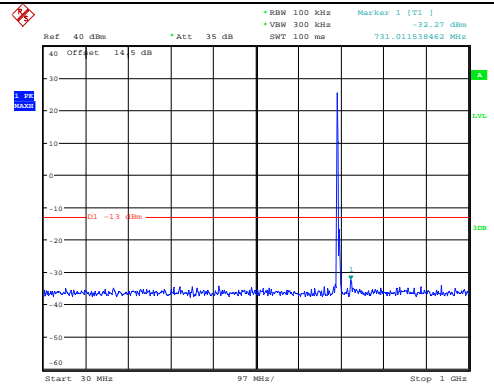

ProjectNo.:CR231169741-RF Tester: Claire Liu
Date: 4.DEC.2023 13:48:58

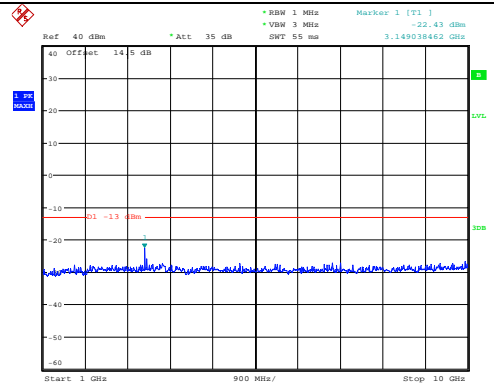

ProjectNo.:CR231169741-RF Tester: Claire Liu
Date: 4.DEC.2023 13:47:00

Middle

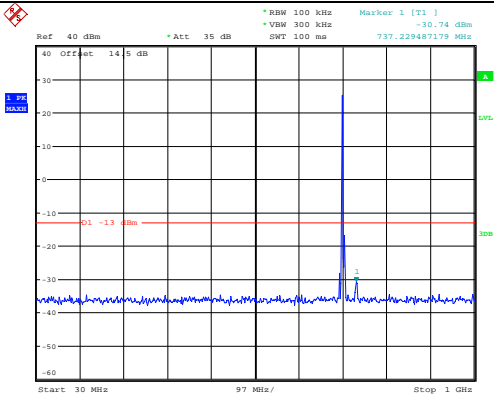

ProjectNo.:CR231169741-RF Tester: Claire Liu
Date: 4.DEC.2023 13:49:48

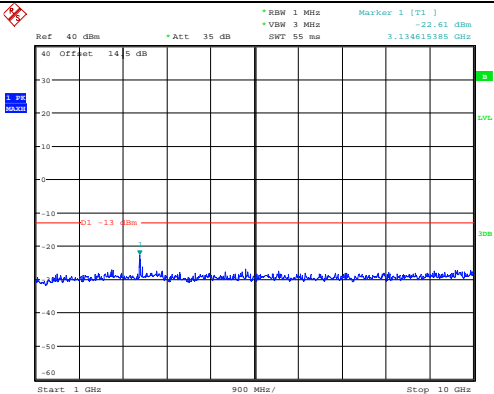

ProjectNo.:CR231169741-RF Tester: Claire Liu
Date: 4.DEC.2023 13:50:11

Highest

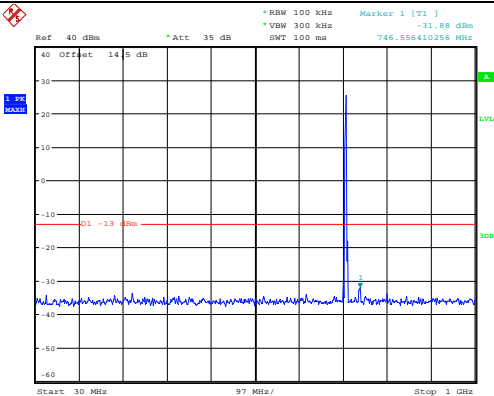

ProjectNo.:CR231169741-RF Tester: Claire Liu
Date: 4.DEC.2023 13:51:27

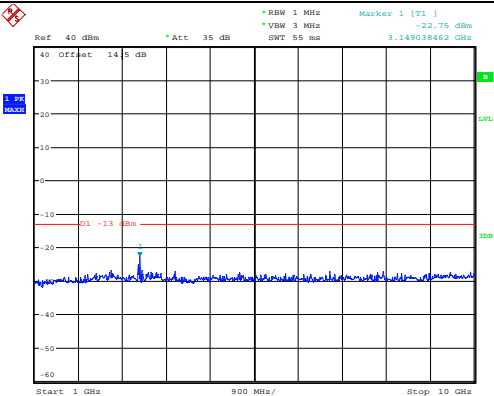

ProjectNo.:CR231169741-RF Tester: Claire Liu
Date: 4.DEC.2023 13:50:39

Spurious Emissions at Antenna Terminal

Channel

5MHz Bandwidth QPSK

Lowest

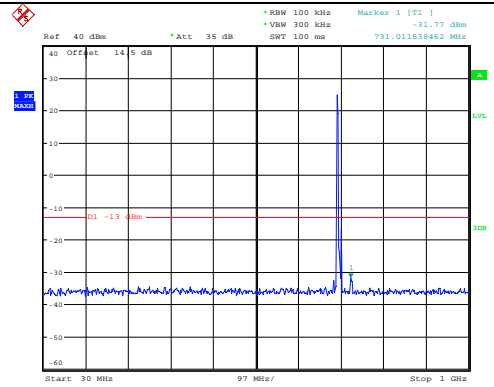

ProjectNo.:CR231169741-RF Tester:Clair Liu
 Date: 4.DEC.2023 13:53:50

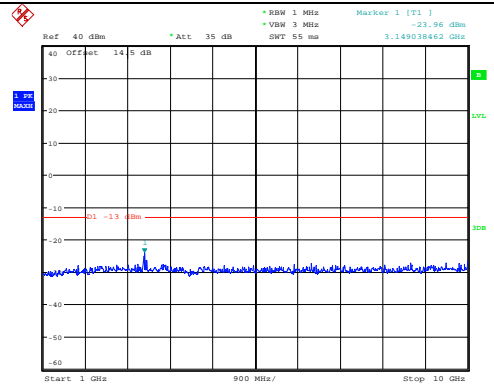

ProjectNo.:CR231169741-RF Tester:Clair Liu
 Date: 4.DEC.2023 13:56:43

Middle

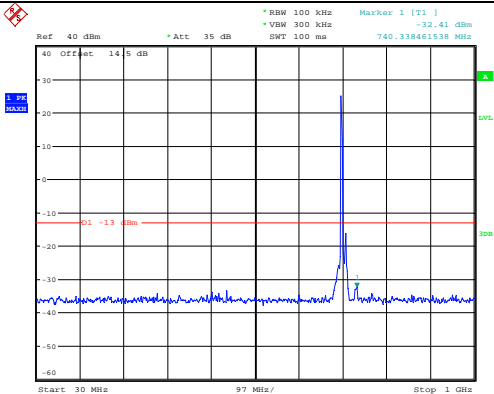

ProjectNo.:CR231169741-RF Tester:Clair Liu
 Date: 4.DEC.2023 13:55:02

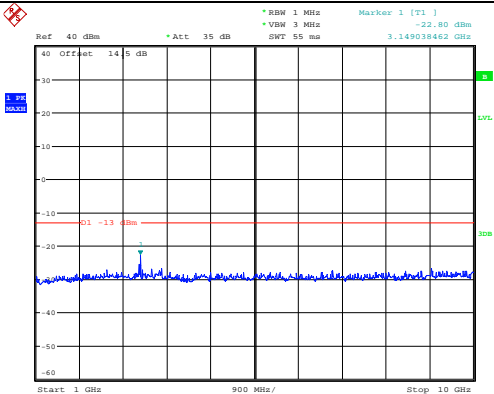

ProjectNo.:CR231169741-RF Tester:Clair Liu
 Date: 4.DEC.2023 13:57:09

Highest

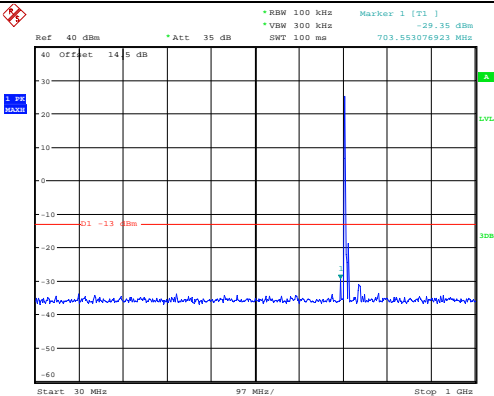

ProjectNo.:CR231169741-RF Tester:Clair Liu
 Date: 4.DEC.2023 13:59:08

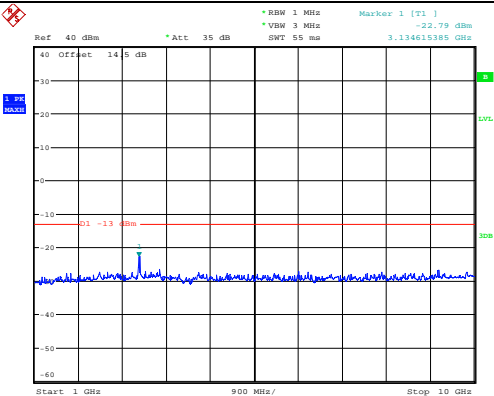

ProjectNo.:CR231169741-RF Tester:Clair Liu
 Date: 4.DEC.2023 13:57:53

Spurious Emissions at Antenna Terminal

Channel

10MHz Bandwidth QPSK

Lowest

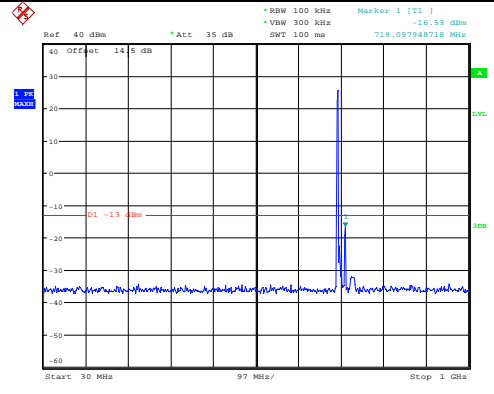

ProjectNo.:CR231169741-RF Tester: Claire Liu
Date: 4.DEC.2023 14:00:34

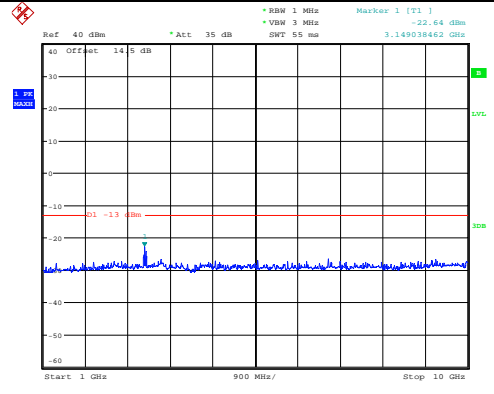

ProjectNo.:CR231169741-RF Tester: Claire Liu
Date: 4.DEC.2023 14:01:13

Middle

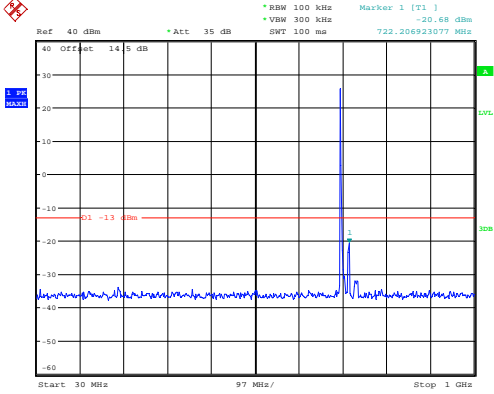

ProjectNo.:CR231169741-RF Tester: Claire Liu
Date: 4.DEC.2023 14:02:26

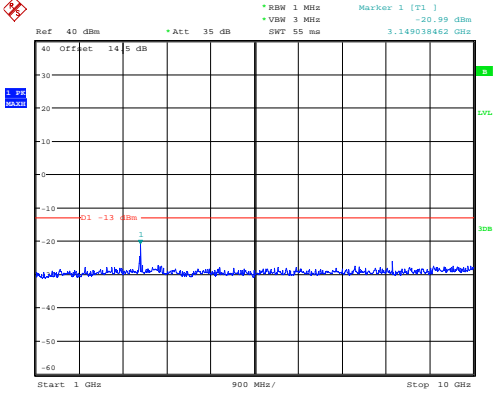

ProjectNo.:CR231169741-RF Tester: Claire Liu
Date: 4.DEC.2023 14:01:40

Highest

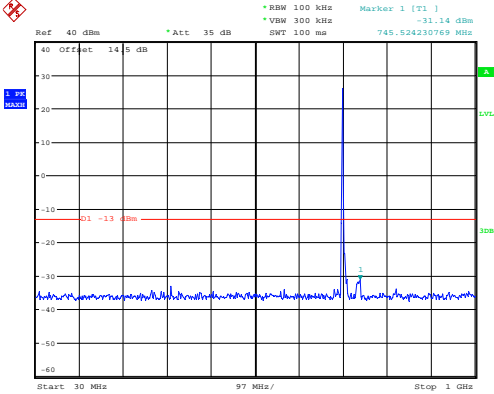

ProjectNo.:CR231169741-RF Tester: Claire Liu
Date: 4.DEC.2023 14:03:25

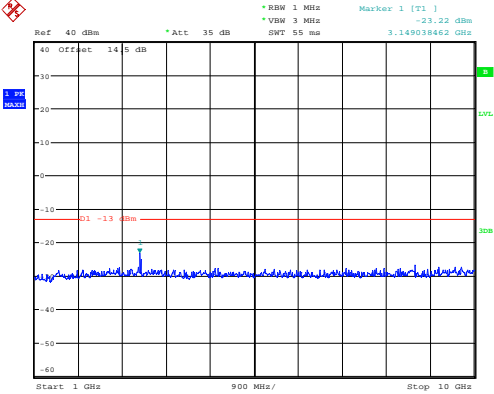

ProjectNo.:CR231169741-RF Tester: Claire Liu
Date: 4.DEC.2023 14:03:48

Test Plots for Out of band emission, Band Edge:
Note: The test is performed in IRB mode.

Out of band emission, Band Edge

Mode	Lowest	Highest
<p>QPSK 1.4MHz</p>	<p>ProjectNo.:CR231169741-RF Tester:Arthur Su Date: 4.DEC.2023 21:27:06</p>	<p>ProjectNo.:CR231169741-RF Tester:Arthur Su Date: 4.DEC.2023 21:29:08</p>
<p>QPSK 3MHz</p>	<p>ProjectNo.:CR231169741-RF Tester:Arthur Su Date: 4.DEC.2023 21:31:32</p>	<p>ProjectNo.:CR231169741-RF Tester:Arthur Su Date: 4.DEC.2023 21:33:24</p>
<p>QPSK 5MHz</p>	<p>ProjectNo.:CR231169741-RF Tester: Claire Liu Date: 5.DEC.2023 11:53:23</p>	<p>ProjectNo.:CR231169741-RF Tester: Claire Liu Date: 5.DEC.2023 11:56:33</p>

Out of band emission, Band Edge

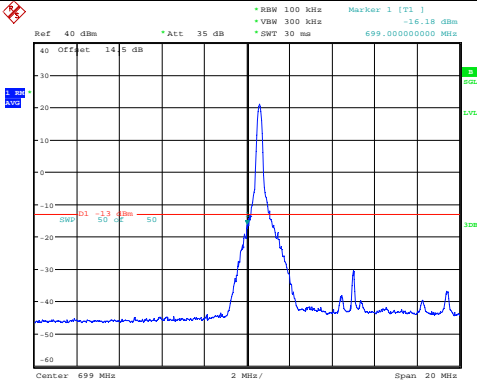
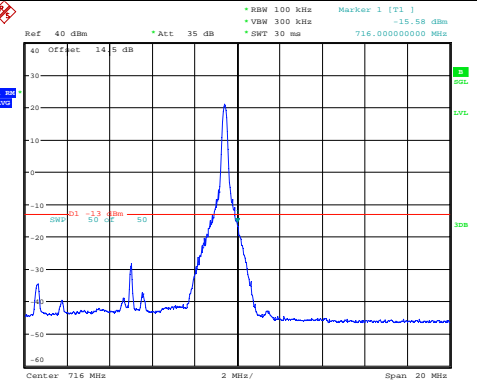
Mode	Lowest	Highest
<p>QPSK 10MHz</p>	 <p>Ref: 40 dBm *Att: 35 dB *RBW: 100 kHz *VBW: 300 kHz *SWT: 30 ms *Marker 1 [T1]: -16.18 dBm 699.00000000 MHz</p> <p>Center: 699 MHz 2 MHz / Span: 20 MHz</p> <p>ProjectNo.: CR231169741-RF Tester: Arthur Su Date: 4.DEC.2023 21:49:33</p>	 <p>Ref: 40 dBm *Att: 35 dB *RBW: 100 kHz *VBW: 300 kHz *SWT: 30 ms *Marker 1 [T1]: -15.58 dBm 716.00000000 MHz</p> <p>Center: 716 MHz 2 MHz / Span: 20 MHz</p> <p>ProjectNo.: CR231169741-RF Tester: Arthur Su Date: 4.DEC.2023 21:51:29</p>

Out of band emission, Band Edge

Mode	Lowest	Highest
16QAM 1.4MHz	<p>ProjectNo.:CR231169741-RF Tester:Arthur Su Date: 4.DEC.2023 21:28:07</p>	<p>ProjectNo.:CR231169741-RF Tester:Arthur Su Date: 4.DEC.2023 21:29:59</p>
16QAM 3MHz	<p>ProjectNo.:CR231169741-RF Tester:Arthur Su Date: 4.DEC.2023 21:32:15</p>	<p>ProjectNo.:CR231169741-RF Tester:Arthur Su Date: 4.DEC.2023 21:33:56</p>
16QAM 5MHz	<p>ProjectNo.:CR231169741-RF Tester:Clair Liu Date: 5.DEC.2023 11:54:03</p>	<p>ProjectNo.:CR231169741-RF Tester:Clair Liu Date: 5.DEC.2023 11:55:53</p>

Out of band emission, Band Edge

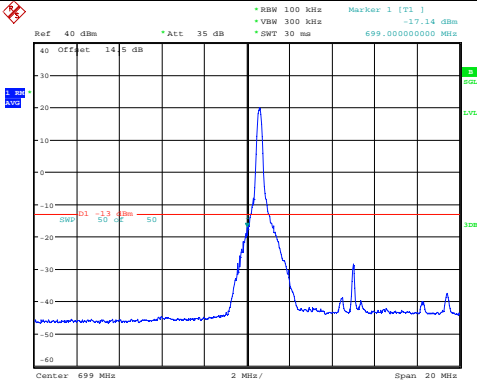
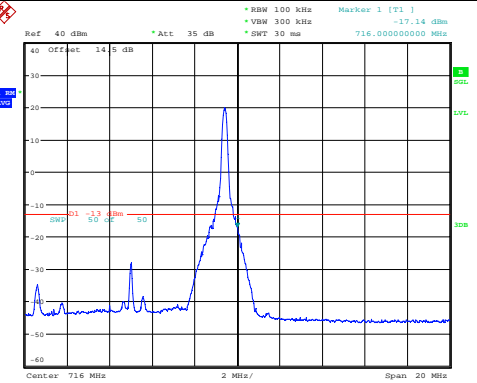
Mode	Lowest	Highest
<p>16QAM 10MHz</p>	 <p>Ref: 40 dBm *Att: 35 dB *RBW: 100 kHz *VBW: 500 kHz *SWT: 30 ms *Marker 1 [T1]: -17.14 dBm 699.00000000 MHz</p> <p>Center: 699 MHz 2 MHz / Span: 20 MHz</p> <p>ProjectNo.: CR231169741-RF Tester: Arthur Su Date: 4.DEC.2023 21:50:21</p>	 <p>Ref: 40 dBm *Att: 35 dB *RBW: 100 kHz *VBW: 500 kHz *SWT: 30 ms *Marker 1 [T1]: -17.14 dBm 716.00000000 MHz</p> <p>Center: 716 MHz 2 MHz / Span: 20 MHz</p> <p>ProjectNo.: CR231169741-RF Tester: Arthur Su Date: 4.DEC.2023 21:52:13</p>

Test Plots for Out of band emission, Band Edge:
Note: The test is performed in full RB mode.

Out of band emission, Band Edge

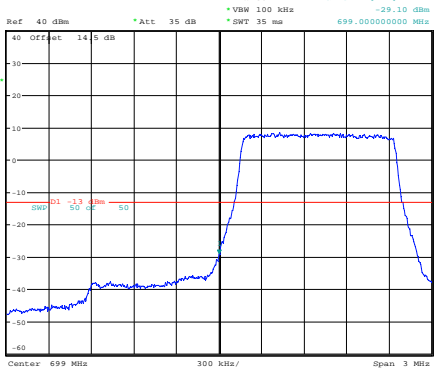
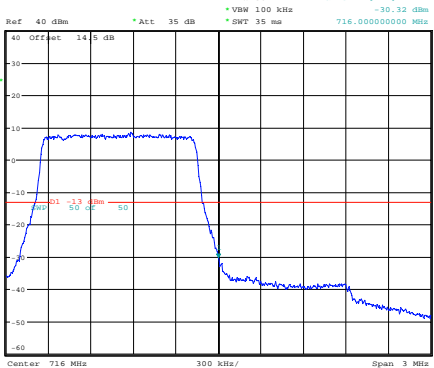
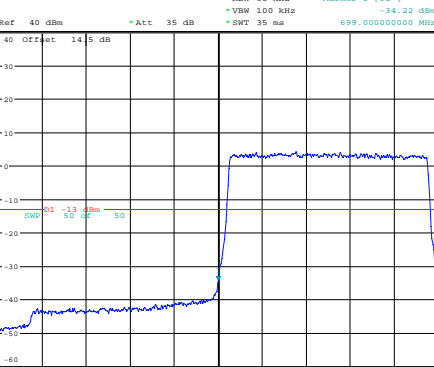
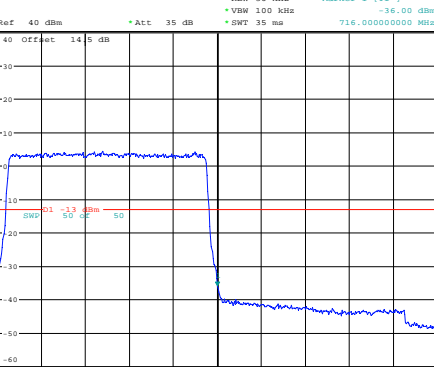
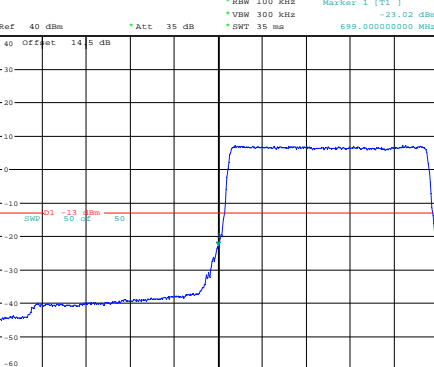
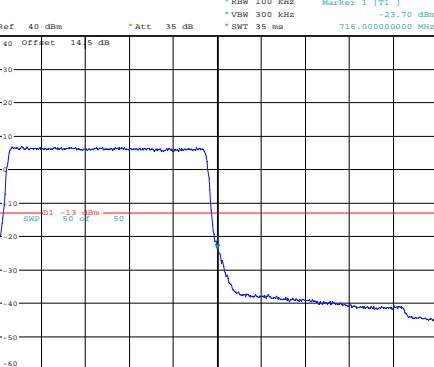
Mode	Lowest	Highest
<p>QPSK 1.4MHz</p>	 <p>ProjectNo.:CR231169741-RF Tester: Claire Liu Date: 2.DEC.2023 11:47:55</p>	 <p>ProjectNo.:CR231169741-RF Tester: Claire Liu Date: 2.DEC.2023 11:48:10</p>
<p>QPSK 3MHz</p>	 <p>ProjectNo.:CR231169741-RF Tester: Claire Liu Date: 2.DEC.2023 11:59:18</p>	 <p>ProjectNo.:CR231169741-RF Tester: Claire Liu Date: 2.DEC.2023 11:59:34</p>
<p>QPSK 5MHz</p>	 <p>ProjectNo.:CR231169741-RF Tester: Claire Liu Date: 2.DEC.2023 12:00:15</p>	 <p>ProjectNo.:CR231169741-RF Tester: Claire Liu Date: 2.DEC.2023 12:00:31</p>

Out of band emission, Band Edge

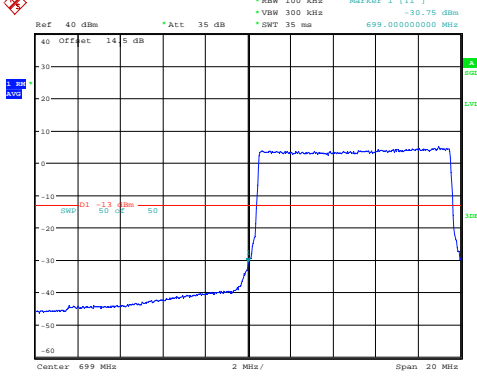
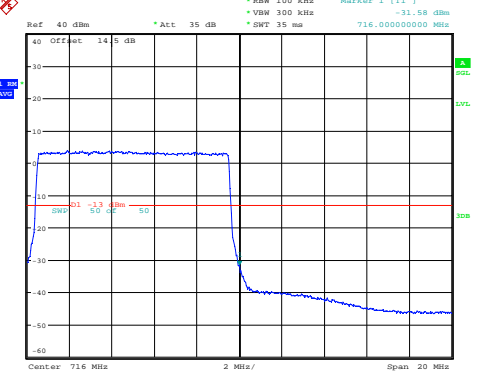
Mode	Lowest	Highest
<p>QPSK 10MHz</p>	 <p>ProjectNo.:CR231169741-RF Tester:Clairre Liu Date: 2.DEC.2023 12:01:13</p>	 <p>ProjectNo.:CR231169741-RF Tester:Clairre Liu Date: 2.DEC.2023 12:01:30</p>

Out of band emission, Band Edge

Mode	Lowest	Highest
16QAM 1.4MHz	<p>ProjectNo.:CR231169741-RF Tester: Claire Liu Date: 2.DEC.2023 11:48:03</p>	<p>ProjectNo.:CR231169741-RF Tester: Claire Liu Date: 2.DEC.2023 11:48:17</p>
16QAM 3MHz	<p>ProjectNo.:CR231169741-RF Tester: Claire Liu Date: 2.DEC.2023 11:59:26</p>	<p>ProjectNo.:CR231169741-RF Tester: Claire Liu Date: 2.DEC.2023 11:59:41</p>
16QAM 5MHz	<p>ProjectNo.:CR231169741-RF Tester: Claire Liu Date: 2.DEC.2023 12:00:23</p>	<p>ProjectNo.:CR231169741-RF Tester: Claire Liu Date: 2.DEC.2023 12:00:39</p>

Out of band emission, Band Edge

Mode	Lowest	Highest
16QAM 10MHz	<p>ProjectNo.:CR231169741-RF Tester:Clairre Liu Date: 2.DEC.2023 12:01:22</p>	<p>ProjectNo.:CR231169741-RF Tester:Clairre Liu Date: 2.DEC.2023 12:01:38</p>

4.10 Antenna Port Test Data and Results for LTE Band 17

Serial Number:	2E5M-1	Test Date:	2023/12/1-2023/12/5
Test Site:	RF	Test Mode:	Transmitting
Tester:	Claire Liu/Arthur Su	Test Result:	Pass

Environmental Conditions:

Temperature: (°C)	24.3-25.8	Relative Humidity: (%)	52-61	ATM Pressure: (kPa)	101-101.4
----------------------	-----------	---------------------------	-------	------------------------	-----------

Test Equipment List and Details:

Manufacturer	Description	Model	Serial Number	Calibration Date	Calibration Due Date
R&S	Spectrum Analyzer	FSU26	200256	2023/3/31	2024/3/30
zhuoxiang	Coaxial Cable	SMA-178	211002	Each time	N/A
YINSAIGE	Coaxial Cable	SS402	SJ0100002	Each time	N/A
eastsheep	Coaxial Attenuator	2W-SMA-JK-18G	21060301	Each time	N/A
R&S	Wideband Radio Communication Tester	CMW500	143458	2023/3/31	2024/3/30
BACL	TEMP&HUMI Test Chamber	BTH-150-40	30174	2023/3/31	2024/3/30
UNI-T	Multimeter	UT39A+	C210582554	2023/9/28	2024/9/27
ZHAOXIN	DC Power Supply	RXN-6010D	21R6010D0912386	N/A	N/A
Unknown	Coaxial tee connector	Unknown	2204005	Each time	N/A

* Statement of Traceability: China Certification ICT Co., Ltd (Dongguan) attests that all calibrations have been performed, traceable to National Primary Standards and International System of Units (SI).

Test Frequency for Each Mode:

Operation Bandwidth	Lowest Frequency (MHz)	Middle Frequency (MHz)	Highest Frequency (MHz)
5MHz	706.5	710	713.5
10MHz	709	710	711

Test Data:

RF Output Power						
Test Bandwidth & Modulation	Resource Block & RB offset	Conducted Average Output Power(dBm)			Maximum ERP (dBm)	ERP Limit (dBm)
		Lowest Channel	Middle Channel	Highest Channel		
5MHz QPSK	RB1#0	24.85	24.83	24.78	22.11	34.77
	RB1#13	24.93	24.88	24.90		
	RB1#24	24.78	24.73	24.82		
	RB15#0	23.84	23.73	23.98		
	RB15#10	24.05	23.91	23.68		
	RB25#0	23.95	23.82	23.79		
5MHz 16QAM	RB1#0	24.15	23.91	23.67	21.41	34.77
	RB1#13	24.23	23.95	23.77		
	RB1#24	24.12	23.87	23.67		
	RB15#0	22.85	22.77	23.02		
	RB15#10	23.04	22.99	22.75		
	RB25#0	22.96	22.87	22.90		
10MHz QPSK	RB1#0	24.89	24.82	24.68	22.19	34.77
	RB1#25	25.01	24.96	24.76		
	RB1#49	24.84	24.76	24.68		
	RB25#0	23.70	23.66	23.40		
	RB25#25	23.98	23.78	23.50		
	RB50#0	23.90	23.77	23.48		
10MHz 16QAM	RB1#0	23.88	24.45	23.82	21.77	34.77
	RB1#25	24.00	24.59	23.97		
	RB1#49	23.84	24.40	23.82		
	RB25#0	22.82	22.71	22.46		
	RB25#25	23.08	22.88	22.57		
	RB50#0	22.92	22.76	22.50		

Note:

ERP= Conducted Power(dBm) - Lc(dB) + G_T(dBd)G_T(dBd)=G_T(dBi)-2.15**Result:****Pass****Peak-to-average Ratio (PAR)**

Test Bandwidth & Modulation	Resource Block & RB offset	Peak-to-average Ratio(dB)			Limit (dB)
		Lowest Channel	Middle Channel	Highest Channel	
10MHz QPSK	RB1#0	5.29	5.16	4.71	13
	RB50#0	5.67	5.58	5.64	13
10MHz 16QAM	RB1#0	6.28	6.22	6.15	13
	RB50#0	6.51	6.54	6.47	13
Result:				Pass	

Occupied Bandwidth						
Operation Mode	99% Occupied Bandwidth (MHz)			26 dB Occupied Bandwidth (MHz)		
	Low Channel	Middle channel	High Channel	Low Channel	Middle Channel	High Channel
5MHz QPSK	4.520	4.520	4.560	5.160	5.140	5.260
5MHz 16QAM	4.540	4.540	4.520	5.200	5.180	5.160
10MHz QPSK	8.960	8.960	8.960	9.800	9.960	9.800
10MHz 16QAM	8.960	8.960	8.960	9.920	9.720	9.720

Note: The test plots please refer to the Plots of Occupied Bandwidth

Spurious Emissions at Antenna Terminal	
Result:	Pass, Please refer to the test plots of Spurious Emissions at Antenna Terminal.

Out of band emission, Band Edge	
Result:	Pass, Please refer to the test plots of Out of band emission, Band Edge.

Frequency Stability						
Test Mode:	10M QPSK	Test Channel: Lowest for Lower Edge, Highest for Upper Edge				
Test Item	Temperature (°C)	Voltage (V _{DC})	Lower Edge (MHz)		Upper Edge (MHz)	
			Result	Limit	Result	Limit
Frequency Stability vs. Temperature	-30	3.8	704.502	704.00	715.488	716.00
	-20	3.8	704.501	704.00	715.481	716.00
	-10	3.8	704.507	704.00	715.502	716.00
	0	3.8	704.509	704.00	715.486	716.00
	10	3.8	704.510	704.00	715.481	716.00
	20	3.8	704.520	704.00	715.480	716.00
	30	3.8	704.494	704.00	715.499	716.00
	40	3.8	704.493	704.00	715.484	716.00
Frequency Stability vs. Voltage	20	3.6	704.500	704.00	715.483	716.00
	20	4.35	704.501	704.00	715.497	716.00
					Result:	Pass

Test Mode:	10M 16QAM	Test Channel: Lowest for Lower Edge, Highest for Upper Edge				
Test Item	Temperature (°C)	Voltage (V _{DC})	Lower Edge (MHz)		Upper Edge (MHz)	
			Result	Limit	Result	Limit
Frequency Stability vs. Temperature	-30	3.8	704.515	704.00	715.502	716.00
	-20	3.8	704.500	704.00	715.507	716.00
	-10	3.8	704.518	704.00	715.501	716.00
	0	3.8	704.494	704.00	715.500	716.00
	10	3.8	704.491	704.00	715.497	716.00
	20	3.8	704.520	704.00	715.480	716.00
	30	3.8	704.493	704.00	715.491	716.00
	40	3.8	704.515	704.00	715.482	716.00
	50	3.8	704.516	704.00	715.508	716.00
Frequency Stability vs. Voltage	20	3.6	704.520	704.00	715.494	716.00
	20	4.35	704.505	704.00	715.506	716.00
					Result:	Pass

Test Plots:

Please refer to the below plots.

Note: The 14.5 dB is the Insertion loss of the RF cable and Power Splitter, which was offset into the Spectrum Analyzer.