



**中认信通**  
CHINA CERTIFICATION ICT CO., LTD (DONGGUAN)



## TEST REPORT

**Applicant: MAXWEST COMMUNICATION LIMITED**

Address: ROOM 1802B FORTRESS TOWER 250 KING' S ROAD, NORTH POINT  
HONG KONG

**FCC ID: 2ASP8ASTRO55R**

**Product Name: Phone**

**Model Number: ASTRO 55R**

**Standard(s): 47 CFR Part 15, Subpart C(15.247)  
ANSI C63.10-2013  
KDB 558074 D01 15.247 Meas Guidance v05r02**

The above equipment has been tested and found compliant with the requirement of the relative standards by China Certification ICT Co., Ltd (Dongguan)

**Report Number: CR21110024-00A**

**Date Of Issue: 2022-01-17**

**Reviewed By: Sun Zhong**

*Sun Zhong*

Title: Manager

**Test Laboratory: China Certification ICT Co., Ltd (Dongguan)**  
No. 113, Pingkang Road, Dalang Town, Dongguan,  
Guangdong, China  
Tel: +86-769-82016888

## Test Facility

The Test site used by China Certification ICT Co., Ltd (Dongguan) to collect test data is located on the No. 113, Pingkang Road, Dalang Town, Dongguan, Guangdong, China.

The lab has been recognized as the FCC accredited lab under the KDB 974614 D01 and is listed in the FCC Public Access Link (PAL) database, FCC Registration No. : 442868, the FCC Designation No. : CN1314.

The lab has been recognized by Innovation, Science and Economic Development Canada to test to Canadian radio equipment requirements, the CAB identifier: CN0123.

## Declarations

China Certification ICT Co., Ltd (Dongguan) is not responsible for the authenticity of any test data provided by the applicant. Data included from the applicant that may affect test results are marked with a triangle symbol “▲”. Customer model name, addresses, names, trademarks etc. are not considered data.

Unless otherwise stated the results shown in this test report refer only to the sample(s) tested.

This report cannot be reproduced except in full, without prior written approval of the Company.

This report is valid only with a valid digital signature. The digital signature may be available only under the Adobe software above version 7.0.

This report may contain data that are not covered by the accreditation scope and shall be marked with an asterisk “★”.

## CONTENTS

<b>TEST FACILITY .....</b>	<b>2</b>
<b>DECLARATIONS.....</b>	<b>2</b>
<b>1. GENERAL INFORMATION .....</b>	<b>5</b>
<b>1.1 PRODUCT DESCRIPTION FOR EQUIPMENT UNDER TEST (EUT) .....</b>	<b>5</b>
<b>1.2 DESCRIPTION OF TEST CONFIGURATION.....</b>	<b>7</b>
1.2.2 Support Equipment List and Details .....	7
1.2.3 Support Cable List and Details .....	7
1.2.4 Block Diagram of Test Setup.....	8
<b>1.3 MEASUREMENT UNCERTAINTY .....</b>	<b>10</b>
<b>2. SUMMARY OF TEST RESULTS .....</b>	<b>11</b>
<b>3. REQUIREMENTS AND TEST PROCEDURES .....</b>	<b>12</b>
<b>3.1 AC LINE CONDUCTED EMISSIONS.....</b>	<b>12</b>
3.1.1 Applicable Standard.....	12
3.1.2 EUT Setup.....	13
3.1.3 EMI Test Receiver Setup .....	13
3.1.4 Test Procedure .....	14
3.1.5 Corrected Amplitude & Margin Calculation.....	14
<b>3.2 RADIATION SPURIOUS EMISSIONS.....</b>	<b>15</b>
3.2.1 Applicable Standard.....	15
3.2.2 EUT Setup.....	15
3.2.3 EMI Test Receiver & Spectrum Analyzer Setup .....	16
3.2.4 Test Procedure .....	16
3.2.5 Corrected Amplitude & Margin Calculation.....	16
<b>3.3 20 DB BANDWIDTH.....</b>	<b>17</b>
3.3.1 Applicable Standard.....	17
3.3.2 EUT Setup.....	17
3.3.3 Test Procedure .....	17
<b>3.4 CHANNEL SEPARATION .....</b>	<b>17</b>
3.4.1 Applicable Standard.....	17
3.4.2 EUT Setup.....	18
3.4.3 Test Procedure .....	18
<b>3.5 NUMBER OF HOPPING FREQUENCY .....</b>	<b>18</b>
3.5.1 Applicable Standard.....	18
3.5.2 EUT Setup.....	18
3.5.3 Test Procedure .....	19
<b>3.6 TIME OF OCCUPANCY(DWELL TIME).....</b>	<b>19</b>
3.6.1 Applicable Standard.....	19
3.6.2 EUT Setup.....	19
3.6.3 Test Procedure .....	19
<b>3.7 PEAK OUTPUT POWER.....</b>	<b>20</b>
3.7.1 Applicable Standard.....	20

3.7.2 EUT Setup.....20  
3.7.3 Test Procedure .....20  
**3.8 100 kHz BANDWIDTH OF FREQUENCY BAND EDGE.....20**  
3.8.1 Applicable Standard.....20  
3.8.2 EUT Setup.....20  
3.8.3 Test Procedure .....20  
**3.9 ANTENNA REQUIREMENT.....21**  
3.9.1 Applicable Standard.....21  
3.9.2 Judgment.....21  
**4. TEST DATA AND RESULTS ..... 22**  
4.1 AC LINE CONDUCTED EMISSIONS.....22  
4.2 RADIATION SPURIOUS EMISSIONS .....27  
4.3 20 dB EMISSION BANDWIDTH: .....35  
4.4 CHANNEL SEPARATION: .....39  
4.5 NUMBER OF HOPPING FREQUENCY: .....43  
4.6 TIME OF OCCUPANCY(DWELL TIME):.....45  
4.7 PEAK CONDUCTED OUTPUT POWER: .....49  
4.8 100 kHz BANDWIDTH OF FREQUENCY BAND EDGE: .....50  
**5. RF EXPOSURE EVALUATION ..... 57**  
5.1 APPLICABLE STANDARD.....57  
5.2 PROCEDURE.....57  
5.3 MEASUREMENT RESULT .....57

## 1. GENERAL INFORMATION

### 1.1 Product Description for Equipment under Test (EUT)

<b>EUT Name:</b>	Phone
<b>EUT Model:</b>	ASTRO 55R
<b>Operation Frequency:</b>	2402-2480 MHz
<b>Maximum Peak Output Power (Conducted):</b>	0.08 dBm
<b>Modulation Type:</b>	GFSK, $\pi/4$ -DQPSK, 8DPSK
<b>Rated Input Voltage:</b>	DC 3.8V from battery or DC 5V from adapter
<b>Serial Number:</b>	CR21110024-RF-S4
<b>EUT Received Date:</b>	2021.11.22
<b>EUT Received Status:</b>	Good

#### Operation Frequency Detail:

Channel	Frequency (MHz)	Channel	Frequency (MHz)
0	2402	40	2442
1	2403	41	2443
...	...	...	...
...	...	...	...
..	...	78	2480
39	2441	/	/

Per section 15.31(m), the below frequencies were performed the test as below:

Test Channel	Frequency (MHz)
Lowest	2402
Middle	2441
Highest	2480

#### Antenna Information Detail▲:

Antenna Manufacturer	Antenna Type	input impedance (Ohm)	Antenna Gain /Frequency Range	§15.203 Requirement
MAXWEST COMMUNICATION LIMITED	FPC	50	-0.98 dBi/ 2.4~2.5GHz	Compliance

The Method of §15.203 Compliance:

- Antenna must be permanently attached to the unit.
- Antenna must use a unique type of connector to attach to the EUT.
- Unit must be professionally installed, and installer shall be responsible for verifying that the correct antenna is employed with the unit.

**Accessory Information:**

<b>Accessory Description</b>	<b>Manufacturer</b>	<b>Model</b>	<b>Parameters</b>
Adapter 1#	Maxwest	ASTRO 55R	Input: 100-240V~50/60Hz 0.15A Output: 5V 1000mA
Adapter 2#	Maxwest	SC/5WM500100-US	Input: 100-240V~50/60Hz 0.4A Output: 5V 1000mA

## 1.2 Description of Test Configuration

### 1.2.1 EUT Operation Condition:

<b>EUT Operation Mode:</b>	The system was configured for testing in Engineering Mode, which was provided by the manufacturer.		
<b>Equipment Modifications:</b>	No		
<b>EUT Exercise Software:</b>	Engineering Mode		
The software " Engineering Mode "was provided by manufacturer. The maximum power was configured as below, that was provided by the manufacturer▲:			
Test Modes	Power Level Setting		
	Lowest	Middle	Highest
GFSK	9	9	9
$\pi/4$ -DQPSK	9	9	9
8DPSK	9	9	9

### 1.2.2 Support Equipment List and Details

Manufacturer	Description	Model	Serial Number
/	/	/	/

### 1.2.3 Support Cable List and Details

Cable Description	Shielding Type	Ferrite Core	Length (m)	From Port	To
Earphone Cable	No	No	1.2	EUT	Earphone
USB Cable	No	No	1.2	Adapter	EUT

### 1.2.4 Block Diagram of Test Setup

AC line conducted emissions:

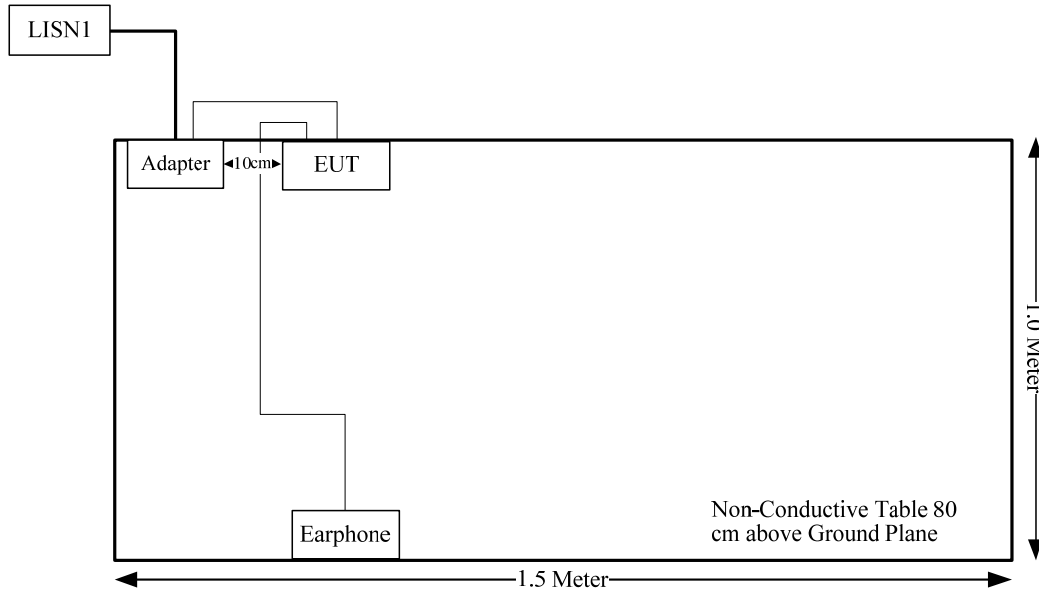

Spurious Emissions:  
Below 1GHz:

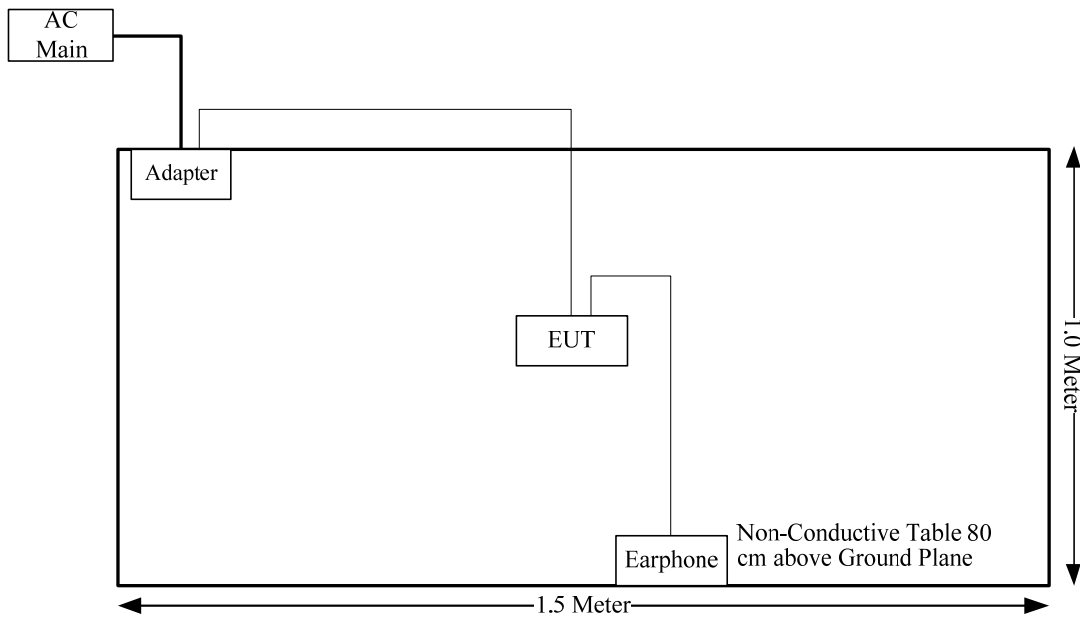



Above 1GHz:

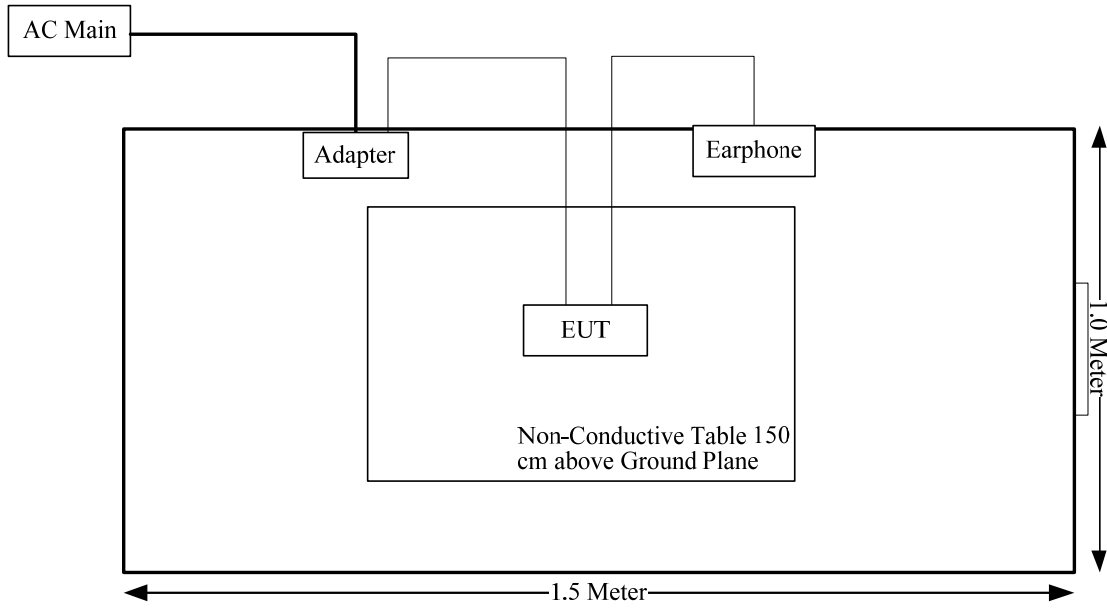

### 1.3 Measurement Uncertainty

Otherwise required by the applicant or Product Regulations, Decision Rule in this report did not consider the uncertainty. The extended uncertainty given in this report is obtained by combining the standard uncertainty times the coverage factor K with the 95% confidence interval.

Parameter	Measurement Uncertainty
Occupied Channel Bandwidth	±5 %
RF output power, conducted	±0.61dB
Power Spectral Density, conducted	±0.61 dB
Unwanted Emissions, radiated	30M~200MHz: 4.15 dB,200M~1GHz: 5.61 dB,1G~6GHz: 5.14 dB, 6G~18GHz: 5.93 dB,18G~26.5G:5.47 dB,26.5G~40G:5.63 dB
Unwanted Emissions, conducted	±1.26 dB
Temperature	±1 °C
Humidity	±5%
DC and low frequency voltages	±0.4%
Duty Cycle	1%
AC Power Lines Conducted Emission	2.8 dB (150 kHz to 30 MHz)

## 2. SUMMARY OF TEST RESULTS

FCC Rules	Description of Test	Result
FCC §15.207(a)	AC line conducted emissions	Compliant
FCC §15.205, §15.209, §15.247(d)	Radiated Spurious emissions	Compliant
FCC §15.247(a)(1)	20 dB bandwidth	Compliant
FCC §15.247(a)(1)	Channel separation	Compliant
FCC §15.247(a)(1)(iii)	Number of hopping Frequency	Compliant
FCC §15.247(a)(1)(iii)	Time of occupancy (dwell time)	Compliant
FCC §15.247(b)(1)	Peak output power measurement	Compliant
FCC §15.247(d)	Band edges	Compliant
FCC §15.203	Antenna requirement	Compliant
FCC§15.247 (i) & §1.1310 & §2.1093	RF Exposure	Compliant

### 3. REQUIREMENTS AND TEST PROCEDURES

#### 3.1 AC Line Conducted Emissions

##### 3.1.1 Applicable Standard

FCC§15.207(a).

(a) Except as shown in paragraphs (b) and (c) of this section, for an intentional radiator that is designed to be connected to the public utility (AC) power line, the radio frequency voltage that is conducted back onto the AC power line on any frequency or frequencies, within the band 150 kHz to 30 MHz, shall not exceed the limits in the following table, as measured using a 50  $\mu$ H/50 ohms line impedance stabilization network (LISN). Compliance with the provisions of this paragraph shall be based on the measurement of the radio frequency voltage between each power line and ground at the power terminal. The lower limit applies at the boundary between the frequency ranges.

Frequency of emission (MHz)	Conducted limit (dB $\mu$ V)	
	Quasi-peak	Average
0.15-0.5	66 to 56*	56 to 46*
0.5-5	56	46
5-30	60	50

\*Decreases with the logarithm of the frequency.

(b) The limit shown in paragraph (a) of this section shall not apply to carrier current systems operating as intentional radiators on frequencies below 30 MHz. In lieu thereof, these carrier current systems shall be subject to the following standards:

(1) For carrier current system containing their fundamental emission within the frequency band 535-1705 kHz and intended to be received using a standard AM broadcast receiver: no limit on conducted emissions.

(2) For all other carrier current systems: 1000  $\mu$ V within the frequency band 535-1705 kHz, as measured using a 50  $\mu$ H/50 ohms LISN.

(3) Carrier current systems operating below 30 MHz are also subject to the radiated emission limits in §15.205, §15.209, §15.221, §15.223, or §15.227, as appropriate.

(c) Measurements to demonstrate compliance with the conducted limits are not required for devices which only employ battery power for operation and which do not operate from the AC power lines or contain provisions for operation while connected to the AC power lines. Devices that include, or make provisions for, the use of battery chargers which permit operating while charging, AC adapters or battery eliminators or that connect to the AC power lines indirectly, obtaining their power through another device which is connected to the AC power lines, shall be tested to demonstrate compliance with the conducted limits.

### 3.1.2 EUT Setup



- Note: 1. Support units were connected to second LISN.  
 2. Both of LISNs (AMN) 80 cm from EUT and at the least 80 cm from other units and other metal planes support units.

The setup of EUT is according with per ANSI C63.10-2013 measurement procedure. The specification used was with the FCC Part 15.207 limits.

The spacing between the peripherals was 10 cm.

The adapter or EUT was connected to the main LISN with a 120 V/60 Hz AC power source.

### 3.1.3 EMI Test Receiver Setup

The EMI test receiver was set to investigate the spectrum from 150 kHz to 30 MHz.

During the conducted emission test, the EMI test receiver was set with the following configurations:

Frequency Range	IF B/W
150 kHz – 30 MHz	9 kHz

### 3.1.4 Test Procedure

The frequency and amplitude of the six highest ac power-line conducted emissions relative to the limit, measured over all the current-carrying conductors of the EUT power cords, and the operating frequency or frequency to which the EUT is tuned (if appropriate), should be reported, unless such emissions are more than 20 dB below the limit. AC power-line conducted emissions measurements are to be separately carried out only on each of the phase (“hot”) line(s) and (if used) on the neutral line(s), but not on the ground [protective earth] line(s). If less than six emission frequencies are within 20 dB of the limit, then the noise level of the measuring instrument at representative frequencies should be reported. The specific conductor of the power-line cord for each of the reported emissions should be identified. Measure the six highest emissions with respect to the limit on each current-carrying conductor of each power cord associated with the EUT (but not the power cords of associated or peripheral equipment that are part of the test configuration). Then, report the six highest emissions with respect to the limit from among all the measurements identifying the frequency and specific current-carrying conductor identified with the emission. The six highest emissions should be reported for each of the current-carrying conductors, or the six highest emissions may be reported over all the current-carrying conductors.

### 3.1.5 Corrected Amplitude & Margin Calculation

The basic equation is as follows:

Result = Reading + Factor

Factor = attenuation caused by cable loss + voltage division factor of AMN

The “**Margin**” column of the following data tables indicates the degree of compliance within the applicable limit. The equation for margin calculation is as follows:

Margin = Limit – Result

## 3.2 Radiation Spurious Emissions

### 3.2.1 Applicable Standard

FCC §15.247 (d);

In any 100 kHz bandwidth outside the frequency band in which the spread spectrum or digitally modulated intentional radiator is operating, the radio frequency power that is produced by the intentional radiator shall be at least 20 dB below that in the 100 kHz bandwidth within the band that contains the highest level of the desired power, based on either an RF conducted or a radiated measurement, provided the transmitter demonstrates compliance with the peak conducted power limits. If the transmitter complies with the conducted power limits based on the use of RMS averaging over a time interval, as permitted under paragraph (b)(3) of this section, the attenuation required under this paragraph shall be 30 dB instead of 20 dB. Attenuation below the general limits specified in §15.209(a) is not required. In addition, radiated emissions which fall in the restricted bands, as defined in §15.205(a), must also comply with the radiated emission limits specified in §15.209(a) (see §15.205(c)).

### 3.2.2 EUT Setup

#### Below 1GHz:

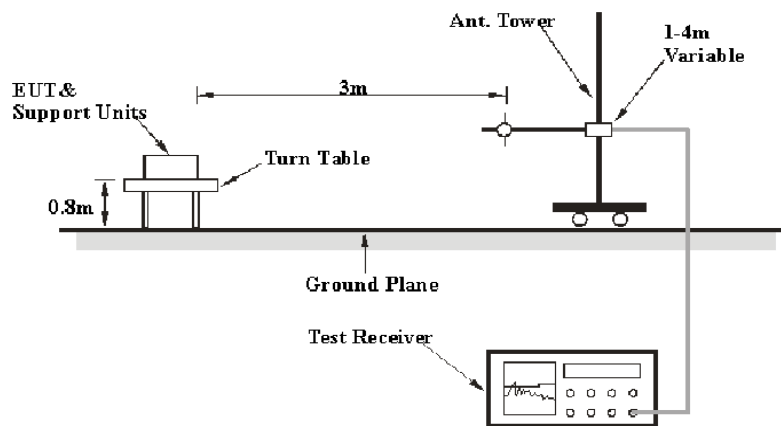

#### Above 1GHz:

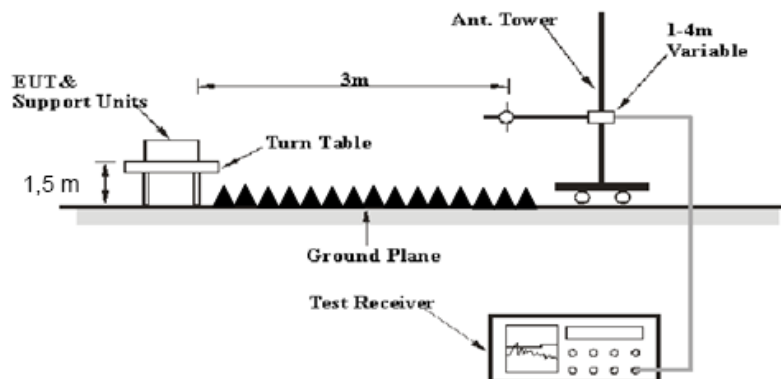

The radiated emissions were performed in the 3 meters distance, using the setup accordance with the ANSI C63.10-2013. The specification used was the FCC 15.209, and FCC 15.247 limits.

The external I/O cables were draped along the test table and formed a bundle 30 to 40 cm long in the middle.

The spacing between the peripherals was 10 cm.

### 3.2.3 EMI Test Receiver & Spectrum Analyzer Setup

During the radiated emission test, the EMI test receiver & Spectrum Analyzer Setup were set with the following configurations:

Frequency Range	RBW	Video B/W	IF B/W	Measurement
30 MHz – 1000 MHz	120 kHz	300 kHz	120 kHz	QP
Above 1 GHz	1MHz	3 MHz	/	PK
	1MHz	10 Hz	/	AV

If the maximized peak measured value complies with under the QP/Average limit more than 6dB, then it is unnecessary to perform an QP/Average measurement.

### 3.2.4 Test Procedure

Maximizing procedure was performed on the highest emissions to ensure that the EUT complied with all installation combinations.

Data was recorded in Quasi-peak detection mode for frequency range of 30 MHz-1 GHz, peak and Average detection modes for frequencies above 1 GHz.

### 3.2.5 Corrected Amplitude & Margin Calculation

The basic equation is as follows:

Result = Reading + Factor

Factor = Antenna Factor + Cable Loss- Amplifier Gain

The “**Margin**” column of the following data tables indicates the degree of compliance within the applicable limit. The equation for margin calculation is as follows:

Margin = Limit – Result



### 3.3 20 dB Bandwidth

#### 3.3.1 Applicable Standard

FCC §15.247 (a)(1)

Frequency hopping systems shall have hopping channel carrier frequencies separated by a minimum of 25 kHz or the 20 dB bandwidth of the hopping channel, whichever is greater. Alternatively, frequency hopping systems operating in the 2400-2483.5 MHz band may have hopping channel carrier frequencies that are separated by 25 kHz or two-thirds of the 20 dB bandwidth of the hopping channel, whichever is greater, provided the systems operate with an output power no greater than 125 mW. The system shall hop to channel frequencies that are selected at the system hopping rate from a pseudo randomly ordered list of hopping frequencies. Each frequency must be used equally on the average by each transmitter. The system receivers shall have input bandwidths that match the hopping channel bandwidths of their corresponding transmitters and shall shift frequencies in synchronization with the transmitted signals.

#### 3.3.2 EUT Setup

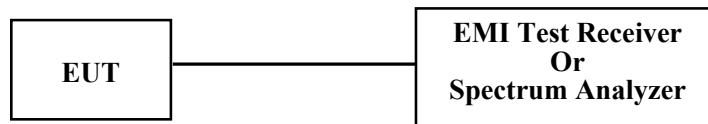

#### 3.3.3 Test Procedure

1. Check the calibration of the measuring instrument using either an internal calibrator or a known signal from an external generator.
2. Position the EUT on the test table without connection to measurement instrument. Turn on the EUT. Then set it to any one convenient frequency within its operating range. Set a reference level on the measuring instrument equal to the highest peak value.
3. Measure the frequency difference of two frequencies that were attenuated 20 dB from the reference level. Record the frequency difference as the emission bandwidth.
4. Repeat above procedures until all frequencies measured were complete.

### 3.4 Channel Separation

#### 3.4.1 Applicable Standard

FCC §15.247 (a)(1)

Frequency hopping systems shall have hopping channel carrier frequencies separated by a minimum of 25 kHz or the 20 dB bandwidth of the hopping channel, whichever is greater. Alternatively, frequency hopping systems operating in the 2400-2483.5 MHz band may have hopping channel carrier frequencies that are separated by 25 kHz or two-thirds of the 20 dB bandwidth of the hopping channel, whichever is greater, provided the systems operate with an output power no greater than 125 mW. The system shall hop to channel frequencies that are selected at the system hopping rate from a pseudo randomly ordered list of hopping frequencies. Each frequency must be used equally on the average by each transmitter. The system receivers shall have input bandwidths that match the hopping channel bandwidths of their corresponding transmitters and shall shift frequencies in synchronization with the transmitted signals.

### 3.4.2 EUT Setup

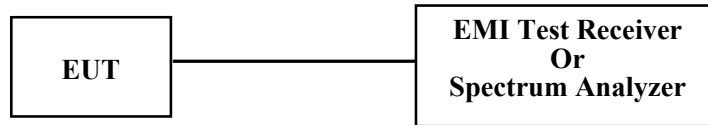

### 3.4.3 Test Procedure

According to ANSI C63.10-2013 Section 7.8.2

The EUT shall have its hopping function enabled. Use the following spectrum analyzer settings:

- a) Span: Wide enough to capture the peaks of two adjacent channels.
- b) RBW: Start with the RBW set to approximately 30% of the channel spacing; adjust as necessary to best identify the center of each individual channel.
- c) Video (or average) bandwidth (VBW)  $\geq$  RBW.
- d) Sweep: Auto.
- e) Detector function: Peak.
- f) Trace: Max hold.
- g) Allow the trace to stabilize.

Use the marker-delta function to determine the separation between the peaks of the adjacent channels. Compliance of an EUT with the appropriate regulatory limit shall be determined. A plot of the data shall be included in the test report.

## 3.5 Number Of Hopping Frequency

### 3.5.1 Applicable Standard

FCC §15.247 (a)(1)(iii)

Frequency hopping systems in the 2400–2483.5 MHz band shall use at least 15 channels. The average time of occupancy on any channel shall not be greater than 0.4 seconds within a period of 0.4 seconds multiplied by the number of hopping channels employed. Frequency hopping systems may avoid or suppress transmissions on a particular hopping frequency provided that a minimum of 15 channels are used.

### 3.5.2 EUT Setup

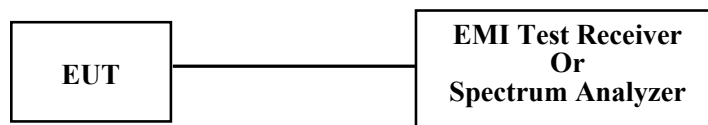

### 3.5.3 Test Procedure

According to ANSI C63.10-2013 Section 7.8.3

The EUT shall have its hopping function enabled. Use the following spectrum analyzer settings:

- a) Span: The frequency band of operation. Depending on the number of channels the device supports, it may be necessary to divide the frequency range of operation across multiple spans, to allow the individual channels to be clearly seen.
- b) RBW: To identify clearly the individual channels, set the RBW to less than 30% of the channel spacing or the 20 dB bandwidth, whichever is smaller.
- c) VBW  $\geq$  RBW.
- d) Sweep: Auto.
- e) Detector function: Peak.
- f) Trace: Max hold.
- g) Allow the trace to stabilize

It might prove necessary to break the span up into subranges to show clearly all of the hopping frequencies. Compliance of an EUT with the appropriate regulatory limit shall be determined for the number of hopping channels. A plot of the data shall be included in the test report.

## 3.6 Time Of Occupancy(Dwell Time)

### 3.6.1 Applicable Standard

Frequency hopping systems in the 2400-2483.5 MHz shall use at least 15 channels. The average time of occupancy on any channel shall not be greater than 0.4 seconds within a period of 0.4 seconds multiplied by the number of hopping channels employed. Frequency hopping systems may avoid or suppress transmissions on a particular hopping frequency provided that a minimum of 15 channels are used.

### 3.6.2 EUT Setup



### 3.6.3 Test Procedure

The EUT was worked in channel hopping; the time of single pulses was tested.

### 3.7 Peak Output Power

#### 3.7.1 Applicable Standard

FCC §15.247 (b)(1)

For frequency hopping systems operating in the 2400–2483.5 MHz band employing at least 75 non-overlapping hopping channels, and all frequency hopping systems in the 5725-5850 MHz band: 1 watt. For all other frequency hopping systems in the 2400–2483.5 MHz band: 0.125 watts

#### 3.7.2 EUT Setup

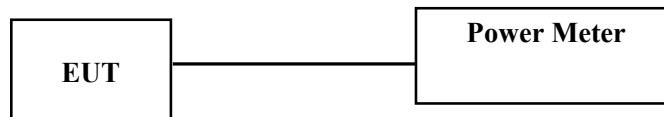

#### 3.7.3 Test Procedure

1. Remove the antenna from the EUT and then connect a low loss RF cable from the antenna port to one test equipment.
2. Add a correction factor to the display.

### 3.8 100 kHz Bandwidth of Frequency Band Edge

#### 3.8.1 Applicable Standard

FCC §15.247 (d);

In any 100 kHz bandwidth outside the frequency band in which the spread spectrum or digitally modulated intentional radiator is operating, the radio frequency power that is produced by the intentional radiator shall be at least 20 dB below that in the 100 kHz bandwidth within the band that contains the highest level of the desired power, based on either an RF conducted or a radiated measurement, provided the transmitter demonstrates compliance with the peak conducted power limits. If the transmitter complies with the conducted power limits based on the use of RMS averaging over a time interval, as permitted under paragraph (b)(3) of this section, the attenuation required under this paragraph shall be 30 dB instead of 20 dB. Attenuation below the general limits specified in §15.209(a) is not required. In addition, radiated emissions which fall in the restricted bands, as defined in §15.205(a), must also comply with the radiated emission limits specified in §15.209(a) (see §15.205(c)).

#### 3.8.2 EUT Setup

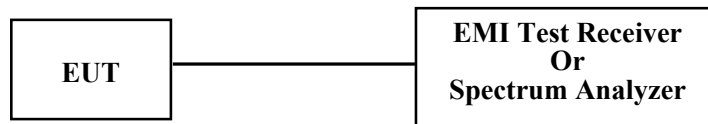

#### 3.8.3 Test Procedure

- a) Set the center frequency and span to encompass frequency range to be measured.
- b) Set the RBW = 100 kHz.
- c) Set the VBW  $\geq [3 \times \text{RBW}]$ .
- d) Detector = peak.
- e) Sweep time = auto couple.
- f) Trace mode = max hold.

g) Allow trace to fully stabilize.

h) Use the peak marker function to determine the maximum amplitude level.

Ensure that the amplitude of all unwanted emissions outside of the authorized frequency band (excluding restricted frequency bands) is attenuated by at least the minimum requirements specified in 11.11. Report the three highest emissions relative to the limit.

### **3.9 Antenna Requirement**

#### **3.9.1 Applicable Standard**

FCC §15.203

An intentional radiator shall be designed to ensure that no antenna other than that furnished by the responsible party shall be used with the device. The use of a permanently attached antenna or of an antenna that uses a unique coupling to the intentional radiator shall be considered sufficient to comply with the provisions of this section. The manufacturer may design the unit so that a broken antenna can be replaced by the user, but the use of a standard antenna jack or electrical connector is prohibited. This requirement does not apply to carrier current devices or to devices operated under the provisions of §§15.211, 15.213, 15.217, 15.219, 15.221, or §15.236. Further, this requirement does not apply to intentional radiators that must be professionally installed, such as perimeter protection systems and some field disturbance sensors, or to other intentional radiators which, in accordance with §15.31(d), must be measured at the installation site. However, the installer shall be responsible for ensuring that the proper antenna is employed so that the limits in this part are not exceeded.

#### **3.9.2 Judgment**

Please refer to the Antenna Information detail in Section 1.

## 4. TEST DATA AND RESULTS

### 4.1 AC Line Conducted Emissions

Serial Number:	CR21110024-RF-S4	Test Date:	2021-11-25
Test Site:	CE	Test Mode:	Transmitting
Tester:	Nick Tang	Test Result:	Pass

Environmental Conditions:					
Temperature: (°C)	19.8	Relative Humidity: (%)	57	ATM Pressure: (kPa)	101.4

### Test Equipment List and Details:

Manufacturer	Description	Model	Serial Number	Calibration Date	Calibration Due Date
R&S	LISN	ENV216	101134	2021-04-25	2022-04-24
R&S	EMI Test Receiver	ESR3	102726	2021-07-22	2022-07-21
MICRO-COAX	Coaxial Cable	UTIFLEX	C-0200-01	2021-08-08	2022-08-07
Audix	Test Software	E3	190306 (V9)	N/A	N/A

\* Statement of Traceability: China Certification ICT Co., Ltd (Dongguan) attests that all calibrations have been performed, traceable to National Primary Standards and International System of Units (SI).

Adapter 1#  
Line:

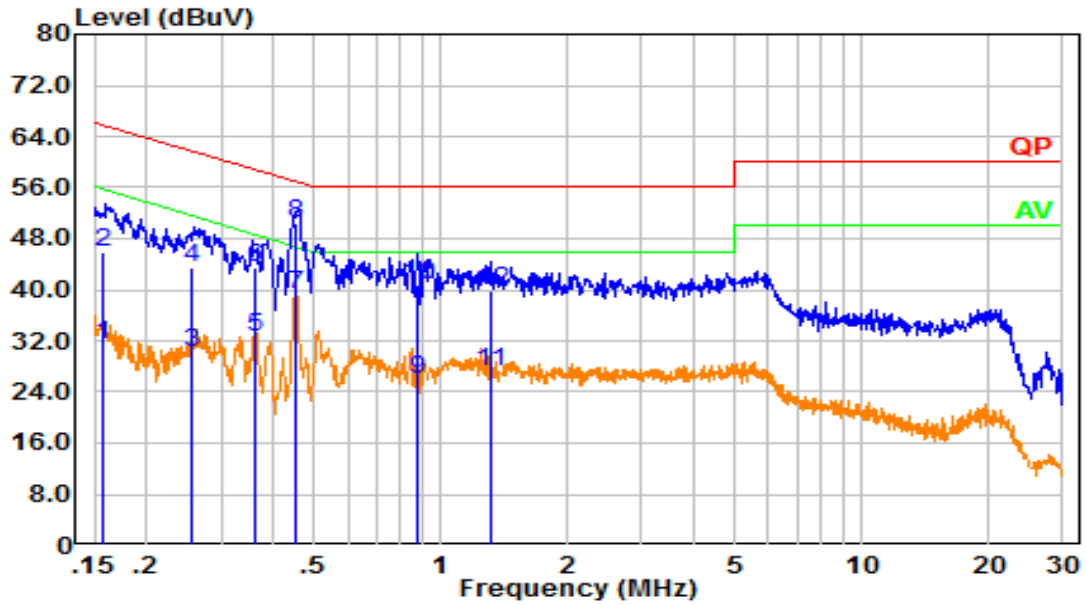

No.	Frequency (MHz)	Reading (dBμV)	Factor (dB)	Result (dBμV)	Limit (dBμV)	Margin (dB)	Detector
1	0.158	21.85	9.61	31.46	55.59	24.13	Average
2	0.158	36.25	9.61	45.86	65.59	19.73	QP
3	0.257	20.70	9.61	30.31	51.53	21.22	Average
4	0.257	33.72	9.61	43.33	61.53	18.21	QP
5	0.362	22.94	9.61	32.55	48.69	16.14	Average
6	0.362	33.72	9.61	43.33	58.69	15.36	QP
7	0.453	29.64	9.61	39.25	46.82	7.57	Average
8	0.453	40.79	9.61	50.40	56.82	6.42	QP
9	0.884	16.49	9.62	26.11	46.00	19.89	Average
10	0.884	31.11	9.62	40.73	56.00	15.27	QP
11	1.308	17.53	9.62	27.15	46.00	18.85	Average
12	1.308	30.24	9.62	39.87	56.00	16.13	QP

Neutral:

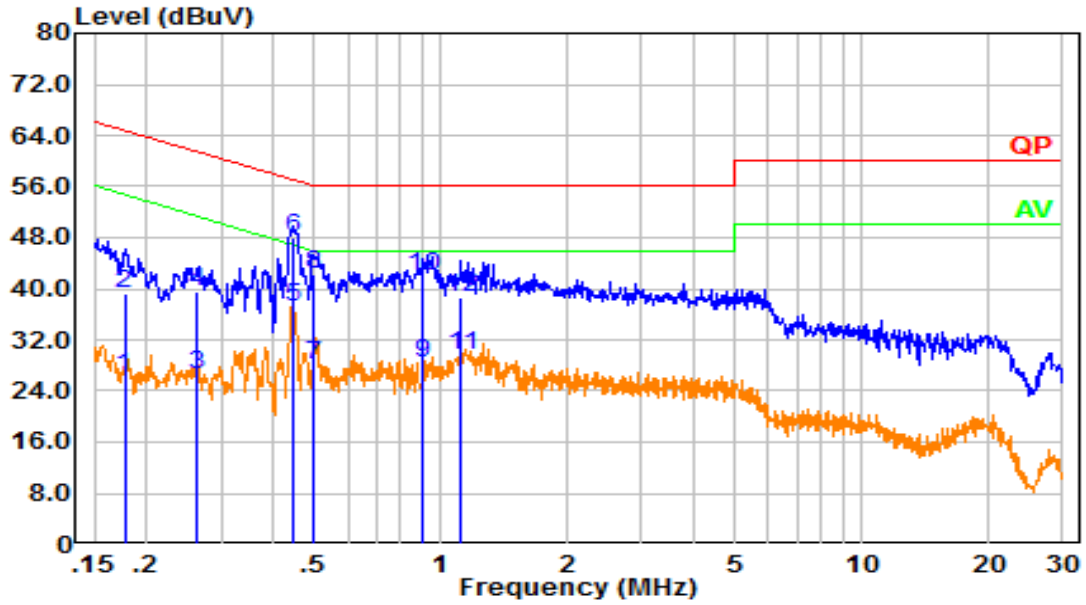

No.	Frequency (MHz)	Reading (dBμV)	Factor (dB)	Result (dBμV)	Limit (dBμV)	Margin (dB)	Detector
1	0.177	16.62	9.61	26.23	54.63	28.40	Average
2	0.177	29.60	9.61	39.21	64.63	25.42	QP
3	0.262	17.04	9.61	26.65	51.36	24.71	Average
4	0.262	29.97	9.61	39.58	61.36	21.78	QP
5	0.444	27.55	9.61	37.16	46.99	9.83	Average
6	0.444	38.48	9.61	48.09	56.99	8.90	QP
7	0.495	18.60	9.61	28.21	46.09	17.88	Average
8	0.495	32.80	9.61	42.41	56.09	13.68	QP
9	0.906	18.80	9.62	28.42	46.00	17.58	Average
10	0.906	32.24	9.62	41.86	56.00	14.14	QP
11	1.116	19.84	9.62	29.46	46.00	16.54	Average
12	1.116	29.01	9.62	38.63	56.00	17.37	QP



Adapter 2#

Line:

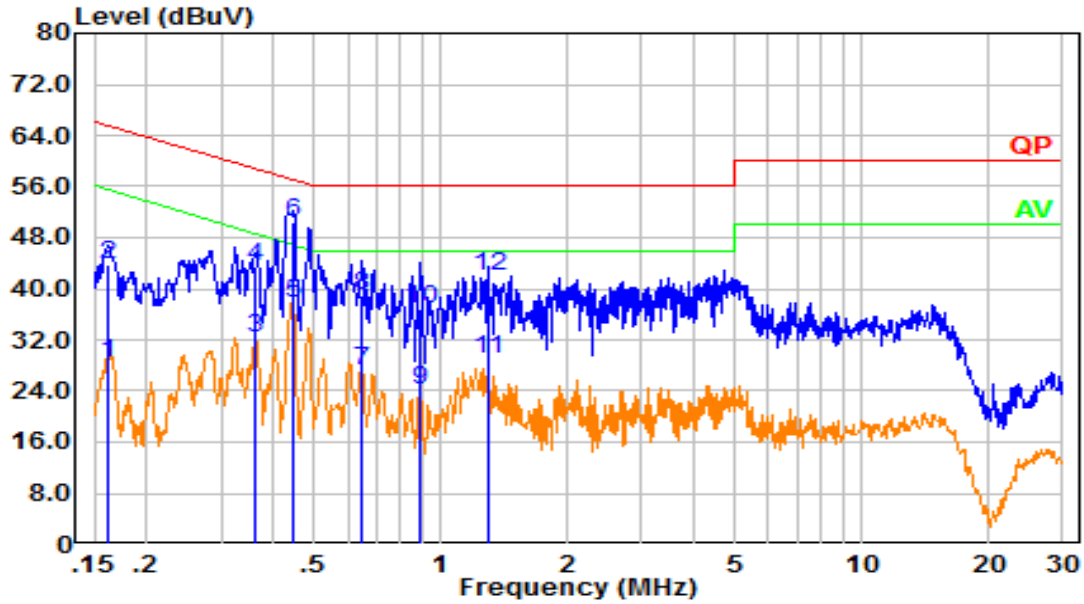

No.	Frequency (MHz)	Reading (dB $\mu$ V)	Factor (dB)	Result (dB $\mu$ V)	Limit (dB $\mu$ V)	Margin (dB)	Detector
1	0.162	18.89	9.61	28.50	55.37	26.87	Average
2	0.162	34.10	9.61	43.71	65.37	21.66	QP
3	0.362	22.65	9.61	32.26	48.68	16.42	Average
4	0.362	33.73	9.61	43.34	58.68	15.34	QP
5	0.446	28.18	9.61	37.79	46.94	9.15	Average
6	0.446	40.80	9.61	50.41	56.94	6.53	QP
7	0.649	17.49	9.62	27.11	46.00	18.89	Average
8	0.649	29.43	9.62	39.05	56.00	16.95	QP
9	0.889	14.49	9.62	24.11	46.00	21.89	Average
10	0.889	27.24	9.62	36.86	56.00	19.14	QP
11	1.298	19.47	9.62	29.09	46.00	16.91	Average
12	1.298	32.21	9.62	41.83	56.00	14.17	QP

Neutral:

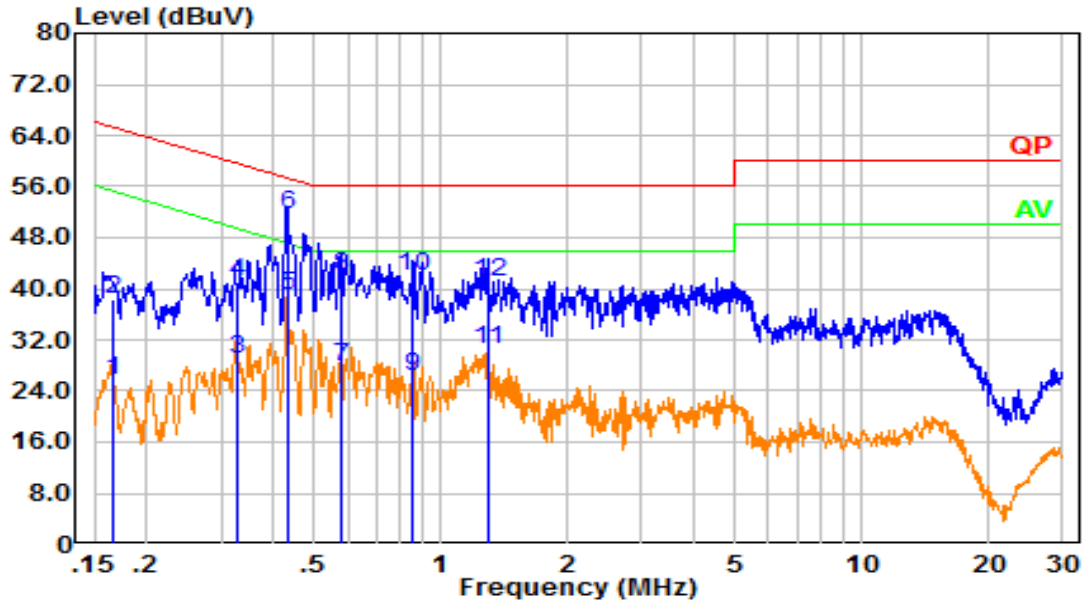

No.	Frequency (MHz)	Reading (dBμV)	Factor (dB)	Result (dBμV)	Limit (dBμV)	Margin (dB)	Detector
1	0.165	16.03	9.61	25.64	55.18	29.54	Average
2	0.165	28.71	9.61	38.32	65.18	26.86	QP
3	0.330	19.39	9.61	29.00	49.46	20.46	Average
4	0.330	31.58	9.61	41.19	59.46	18.27	QP
5	0.431	29.30	9.61	38.91	47.23	8.32	Average
6	0.431	41.95	9.61	51.56	57.23	5.67	QP
7	0.577	18.08	9.62	27.69	46.00	18.31	Average
8	0.577	32.49	9.62	42.10	56.00	13.90	QP
9	0.860	16.66	9.62	26.28	46.00	19.72	Average
10	0.860	32.19	9.62	41.81	56.00	14.19	QP
11	1.297	20.98	9.62	30.60	46.00	15.40	Average
12	1.297	31.32	9.62	40.95	56.00	15.05	QP

## 4.2 Radiation Spurious Emissions

Serial Number:	CR21110024-RF-S4	Test Date:	2021-11-24~2021-11-26
Test Site:	966-1/966-2	Test Mode:	Transmitting
Tester:	Tommy Luo, Great Qiao	Test Result:	Pass

### Environmental Conditions:

Temperature: (°C)	20.2~20.3	Relative Humidity: (%)	52~57	ATM Pressure: (kPa)	101.3~101.7
----------------------	-----------	------------------------------	-------	------------------------	-------------

### Test Equipment List and Details:

Manufacturer	Description	Model	Serial Number	Calibration Date	Calibration Due Date
Sunol Sciences	Antenna	JB6	A082520-5	2020-10-19	2023-10-18
R&S	EMI Test Receiver	ESR3	102724	2021-07-22	2022-07-21
TIMES MICROWAVE	Coaxial Cable	LMR-600-UltraFlex	C-0470-02	2021-07-18	2022-07-17
TIMES MICROWAVE	Coaxial Cable	LMR-600-UltraFlex	C-0780-01	2021-07-18	2022-07-17
Sonoma	Amplifier	310N	186165	2021-07-18	2022-07-17
ETS-Lindgren	Horn Antenna	3115	9912-5985	2020-10-13	2023-10-12
R&S	Spectrum Analyzer	FSV40	101591	2021-07-22	2022-07-21
MICRO-COAX	Coaxial Cable	UFA210A-1-1200-70U300	217423-008	2021-08-08	2022-08-07
MICRO-COAX	Coaxial Cable	UFA210A-1-2362-300300	235780-001	2021-08-08	2022-08-07
Mini	Pre-amplifier	ZVA-183-S+	5969001149	2021-11-10	2022-11-09
Audix	Test Software	E3	201021 (V9)	N/A	N/A
PASTERNAK	Horn Antenna	PE9852/2F-20	112002	2021-02-05	2023-02-04
AH	Preamplifier	PAM-1840VH	190	2021-11-19	2022-11-18
MICRO-COAX	Coaxial Cable	UFB142A-1-2362-200200	235772-001	2021-08-08	2022-08-07
E-Microwave	Band Rejection Filter	2400-2483.5MHz	OE01902424	2021-08-08	2022-08-07
Mini Circuits	High Pass Filter	VHF-3100+	31251	2021-08-08	2022-08-07

\* Statement of Traceability: China Certification ICT Co., Ltd (Dongguan) attests that all calibrations have been performed, traceable to National Primary Standards and International System of Units (SI).

### Test Data:

Please refer to the below table and plots.

Note: The device can be mounted in multiple orientations, test was performed with X, Y, Z Axis, the worst orientation was photographed and it's data was recorded.

### 1) 30MHz-1GHz(BDR Low channel was the worst)

Adapter 1#

Horizontal:

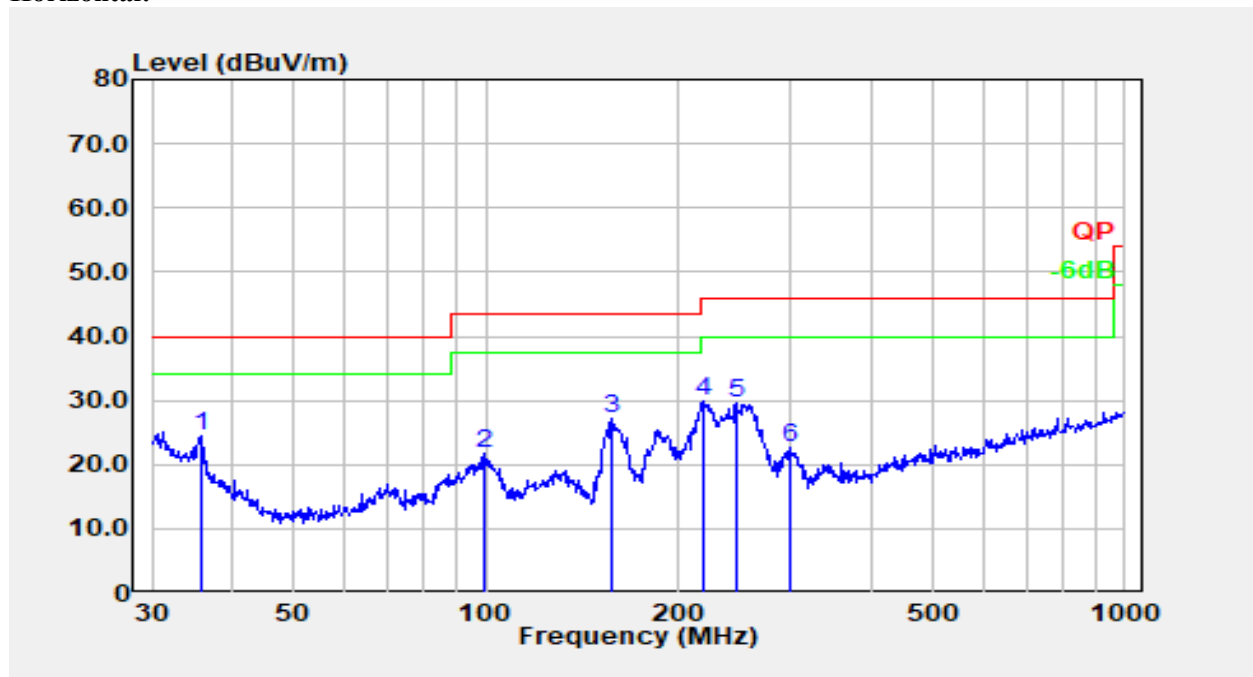

No.	Frequency (MHz)	Reading (dB $\mu$ V)	Factor (dB/m)	Result (dB $\mu$ V/m)	Limit (dB $\mu$ V/m)	Margin (dB)	Detector
1	35.749	32.73	-8.23	24.50	40.00	15.50	Peak
2	99.528	36.43	-14.69	21.73	43.50	21.77	Peak
3	157.007	39.33	-12.30	27.03	43.50	16.47	Peak
4	219.075	42.80	-12.93	29.87	46.00	16.13	Peak
5	245.951	42.73	-13.15	29.58	46.00	16.42	Peak
6	300.367	33.55	-10.81	22.74	46.00	23.26	Peak

Vertical:

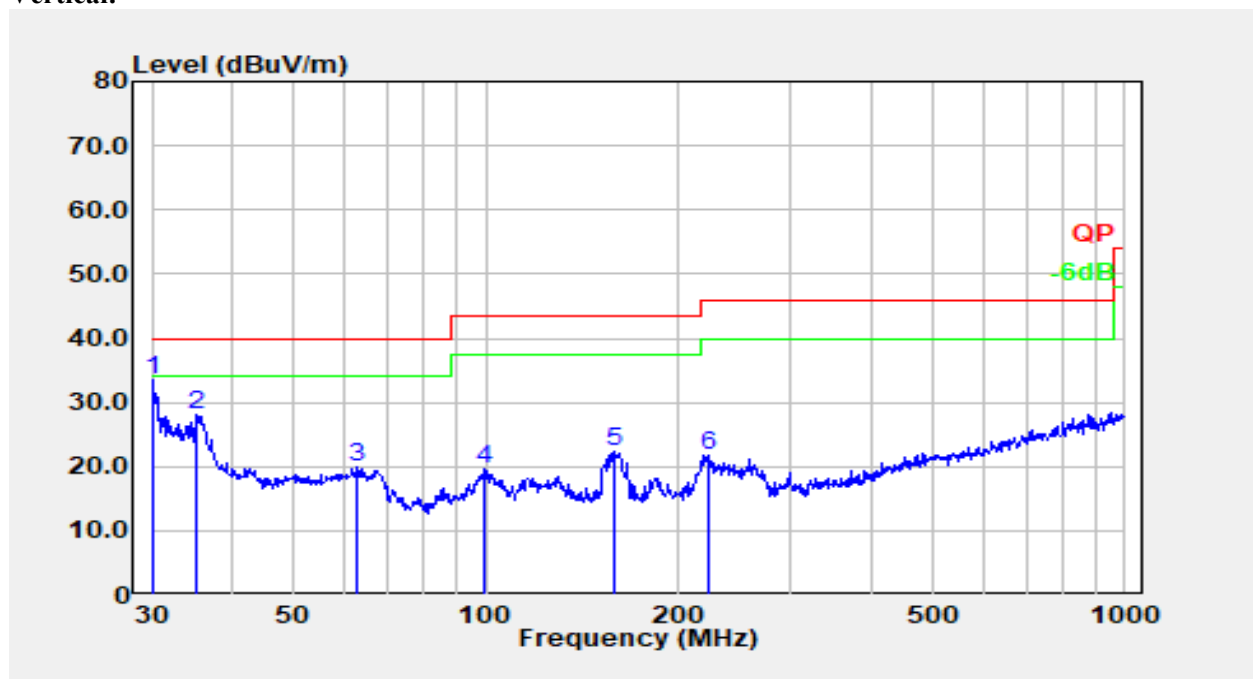

No.	Frequency (MHz)	Reading (dBμV)	Factor (dB/m)	Result (dBμV/m)	Limit (dBμV/m)	Margin (dB)	Detector
1	30.000	37.40	-3.79	33.61	40.00	6.39	Peak
2	35.251	35.90	-7.86	28.04	40.00	11.96	Peak
3	62.871	37.27	-17.36	19.91	40.00	20.09	Peak
4	99.528	34.29	-14.69	19.60	43.50	23.90	Peak
5	158.112	34.53	-12.31	22.22	43.50	21.28	Peak
6	222.170	34.72	-12.99	21.73	46.00	24.27	Peak

Adapter 2#

Horizontal:

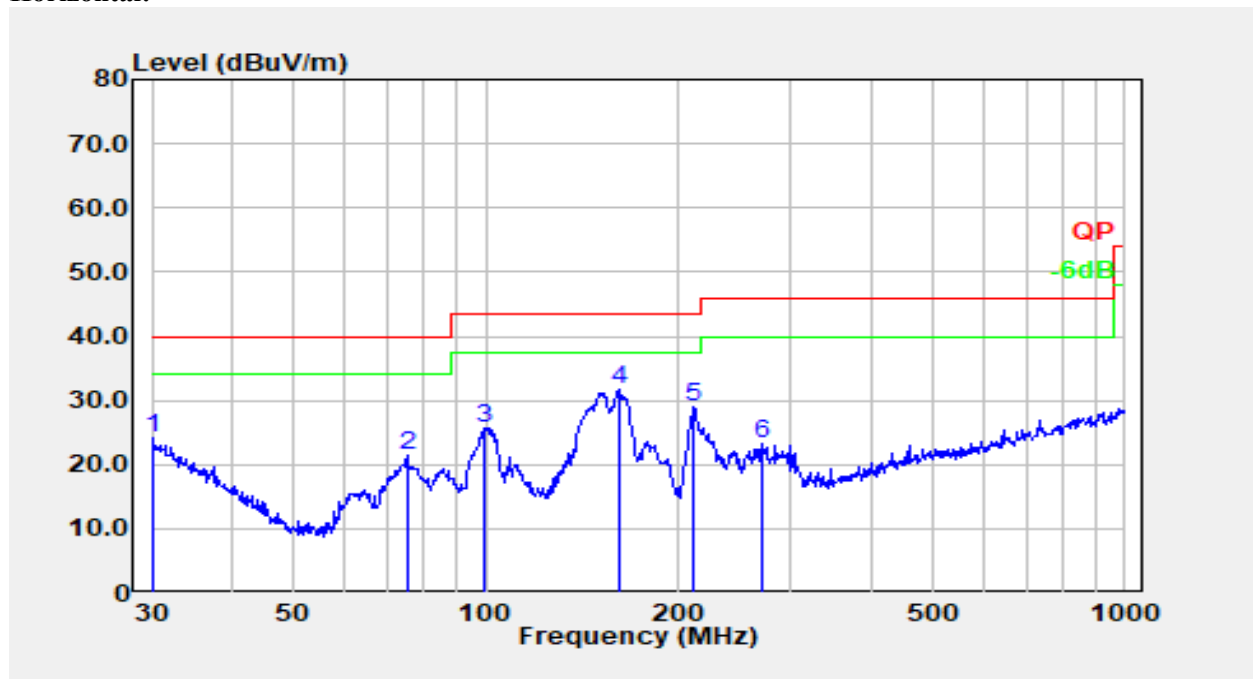

No.	Frequency (MHz)	Reading (dBμV)	Factor (dB/m)	Result (dBμV/m)	Limit (dBμV/m)	Margin (dB)	Detector
1	30.105	27.92	-3.87	24.04	40.00	15.96	Peak
2	75.182	38.50	-17.19	21.31	40.00	18.69	Peak
3	99.528	40.35	-14.69	25.66	43.50	17.84	Peak
4	161.474	44.13	-12.44	31.69	43.50	11.81	Peak
5	211.527	41.75	-12.66	29.09	43.50	14.41	Peak
6	270.375	35.64	-12.28	23.35	46.00	22.65	Peak

## Vertical:

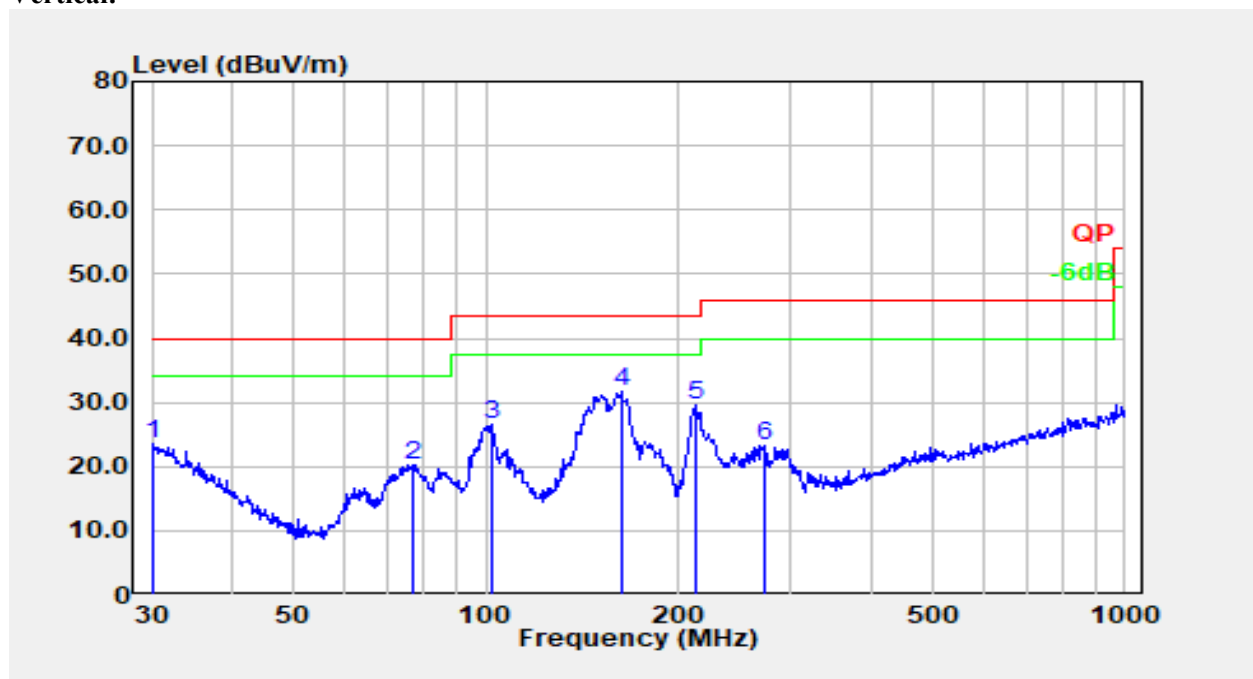

No.	Frequency (MHz)	Reading (dB $\mu$ V)	Factor (dB/m)	Result (dB $\mu$ V/m)	Limit (dB $\mu$ V/m)	Margin (dB)	Detector
1	30.000	27.22	-3.79	23.43	40.00	16.57	Peak
2	76.512	37.67	-17.33	20.34	40.00	19.66	Peak
3	102.001	40.68	-14.22	26.46	43.50	17.04	Peak
4	162.611	44.13	-12.54	31.58	43.50	11.92	Peak
5	213.015	42.29	-12.72	29.57	43.50	13.93	Peak
6	272.278	35.33	-12.20	23.12	46.00	22.88	Peak

**2) 1-25GHz(Adapter 1# was tested):***BDR Mode(GFSK) was the worst:*

Frequency (MHz)	Receiver		Polar (H/V)	Factor (dB/m)	Result (dBµV/m)	Limit (dBµV/m)	Margin (dB)
	Reading (dBµV)	Detector					
Low Channel: 2402 MHz							
2402.00	66.50	PK	H	31.51	98.01	N/A	N/A
2402.00	52.33	AV	H	31.51	83.84	N/A	N/A
2402.00	65.38	PK	V	31.51	96.89	N/A	N/A
2402.00	51.22	AV	V	31.51	82.73	N/A	N/A
2390.00	27.32	PK	H	31.46	58.78	74.00	15.22
2390.00	13.90	AV	H	31.46	45.36	54.00	8.64
4804.00	40.96	PK	H	10.91	51.87	74.00	22.13
4804.00	24.43	AV	H	10.91	35.34	54.00	18.66
7206.00	35.20	PK	H	14.22	49.42	74.00	24.58
7206.00	24.68	AV	H	14.22	38.90	54.00	15.10
2357.00	56.34	PK	H	3.33	59.67	74.00	14.33
2357.00	22.93	AV	H	3.33	26.26	54.00	27.74
Middle Channel: 2441 MHz							
2441.00	64.33	PK	H	31.61	95.94	N/A	N/A
2441.00	50.08	AV	H	31.61	81.69	N/A	N/A
2441.00	63.97	PK	V	31.61	95.58	N/A	N/A
2441.00	49.72	AV	V	31.61	81.33	N/A	N/A
4882.00	40.56	PK	H	11.07	51.63	74.00	22.37
4882.00	24.54	AV	H	11.07	35.61	54.00	18.39
7323.00	34.32	PK	H	14.80	49.12	74.00	24.88
7323.00	22.40	AV	H	14.80	37.20	54.00	16.80
2357.00	54.26	PK	H	3.33	57.59	74.00	16.41
2357.00	22.01	AV	H	3.33	25.34	54.00	28.66
High Channel: 2480 MHz							
2480.00	66.28	PK	H	31.64	97.92	N/A	N/A
2480.00	52.34	AV	H	31.64	83.98	N/A	N/A
2480.00	65.91	PK	V	31.64	97.55	N/A	N/A
2480.00	51.23	AV	V	31.64	82.87	N/A	N/A
2483.50	28.73	PK	H	31.64	60.37	74.00	13.63
2483.50	14.28	AV	H	31.64	45.92	54.00	8.08
4960.00	42.19	PK	H	11.23	53.42	74.00	20.58
4960.00	27.34	AV	H	11.23	38.57	54.00	15.43
7440.00	41.37	PK	H	15.26	56.63	74.00	17.37
7440.00	24.48	AV	H	15.26	39.74	54.00	14.26
2357.00	55.87	PK	H	3.33	59.20	74.00	14.80
2357.00	22.64	AV	H	3.33	25.97	54.00	28.03



**Worst Test plots(GFSK High channel was the worst)**  
**Horizontal:**

Fundamental  
Test with Band  
Rejection Filter

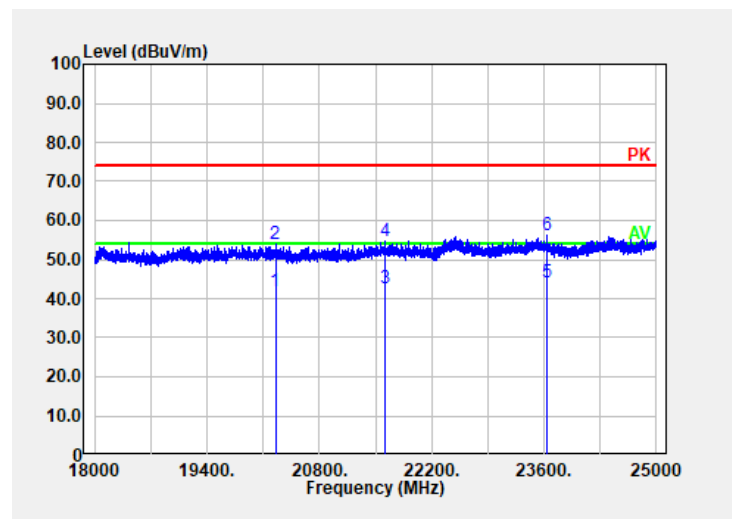
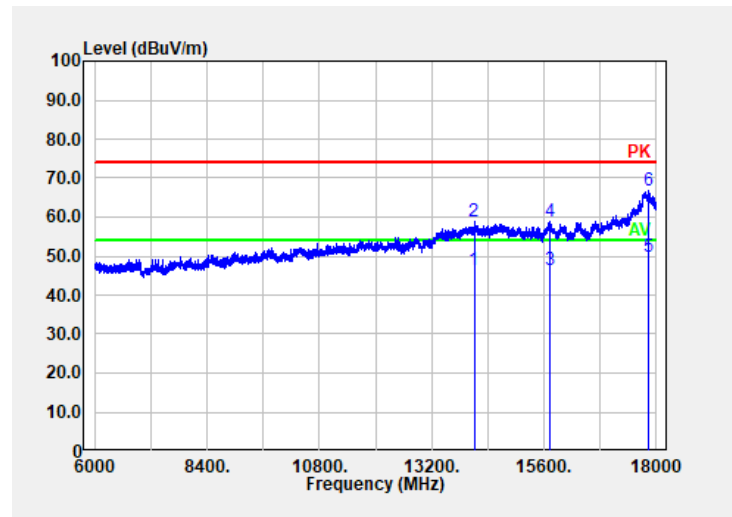
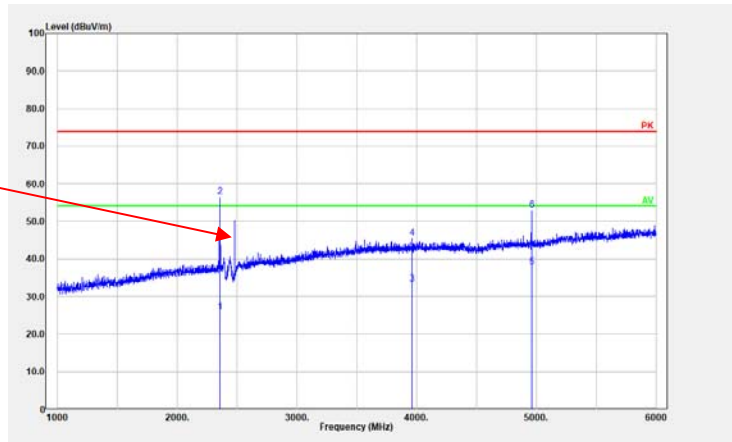

**Vertical:**

Fundamental Test with Band Rejection Filter

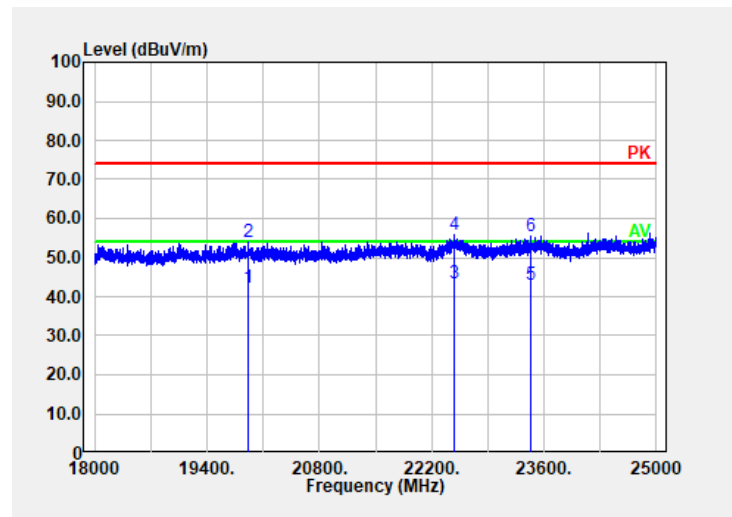
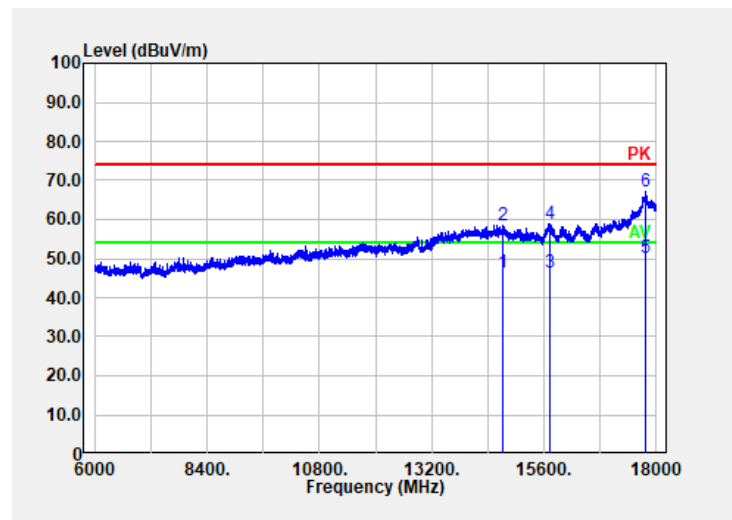
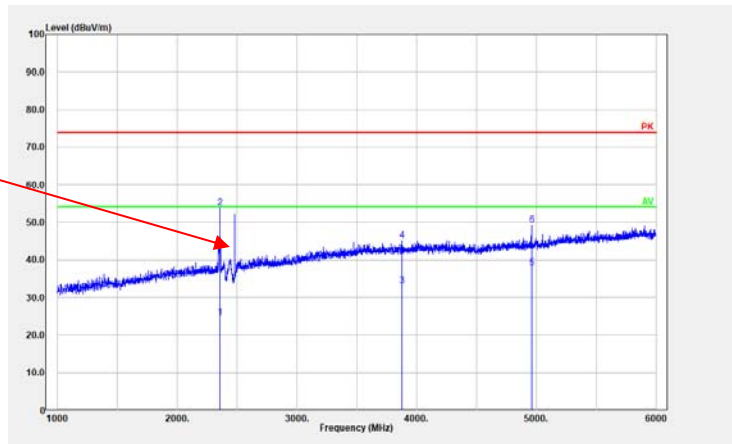

**4.3 20 dB Emission Bandwidth:**

Serial Number:	CR21110024-RF-S4	Test Date:	2021/11/26
Test Site:	RF	Test Mode:	Transmitting
Tester:	Le Qiao	Test Result:	N/A

**Environmental Conditions:**

Temperature: (°C)	26	Relative Humidity: (%)	61	ATM Pressure: (kPa)	100.3
----------------------	----	------------------------------	----	------------------------	-------

**Test Equipment List and Details:**

Manufacturer	Description	Model	Serial Number	Calibration Date	Calibration Due Date
R&S	Spectrum Analyzer	FSV40	101474	2021-07-22	2022-07-21
zhuoxiang	Coaxial Cable	SMA-178	211001	Each time	N/A
Mini-Circuits	DC Block	BLK-18-S+	1554403	Each time	N/A

\* Statement of Traceability: China Certification ICT Co., Ltd (Dongguan) attests that all calibrations have been performed, traceable to National Primary Standards and International System of Units (SI).

**Test Data:**

Test Modes	Test Channel	Test Frequency (MHz)	20 dB Bandwidth (MHz)
BDR Mode (GFSK)	Lowest	2402	0.884
	Middle	2441	0.948
	Highest	2480	0.944
EDR Mode ( $\pi/4$ -DQPSK)	Lowest	2402	1.264
	Middle	2441	1.268
	Highest	2480	1.268
EDR Mode (8DPSK)	Lowest	2402	1.264
	Middle	2441	1.256
	Highest	2480	1.268

**BDR Mode (GFSK)**

<p>Lowest Channel</p>	<p><b>Spectrum</b>          Ref Level 20.00 dBm Offset 0.50 dB RBW 30 kHz          Att 30 dB SWT 63.1 μs VBW 100 kHz Mode Auto FFT          1Pk Max          M1[1] -23.49 dBm          D1[1] 2.40154400 GHz          D1 -3.560 dBm          D2 -23.560 dBm          0.04 dB          884.00 kHz          CF 2.402 GHz 501 pts Span 2.0 MHz          Measuring... 26.11.2021 18:04:36          Date: 26.NOV.2021 18:04:37</p>
<p>Middle Channel</p>	<p><b>Spectrum</b>          Ref Level 20.00 dBm Offset 0.50 dB RBW 30 kHz          Att 30 dB SWT 63.1 μs VBW 100 kHz Mode Auto FFT          1Pk Max          M1[1] -23.69 dBm          D1[1] 2.44054400 GHz          D1 -4.040 dBm          D2 -24.040 dBm          -0.47 dB          948.00 kHz          CF 2.441 GHz 501 pts Span 2.0 MHz          Measuring... 26.11.2021 18:06:25          Date: 26.NOV.2021 18:06:26</p>
<p>Highest Channel</p>	<p><b>Spectrum</b>          Ref Level 20.00 dBm Offset 0.50 dB RBW 30 kHz          Att 30 dB SWT 63.1 μs VBW 100 kHz Mode Auto FFT          1Pk Max          M1[1] -21.93 dBm          D1[1] 2.47954400 GHz          D1 -2.010 dBm          D2 -22.010 dBm          -0.08 dB          944.00 kHz          CF 2.48 GHz 501 pts Span 2.0 MHz          Measuring... 26.11.2021 18:07:35          Date: 26.NOV.2021 18:07:35</p>

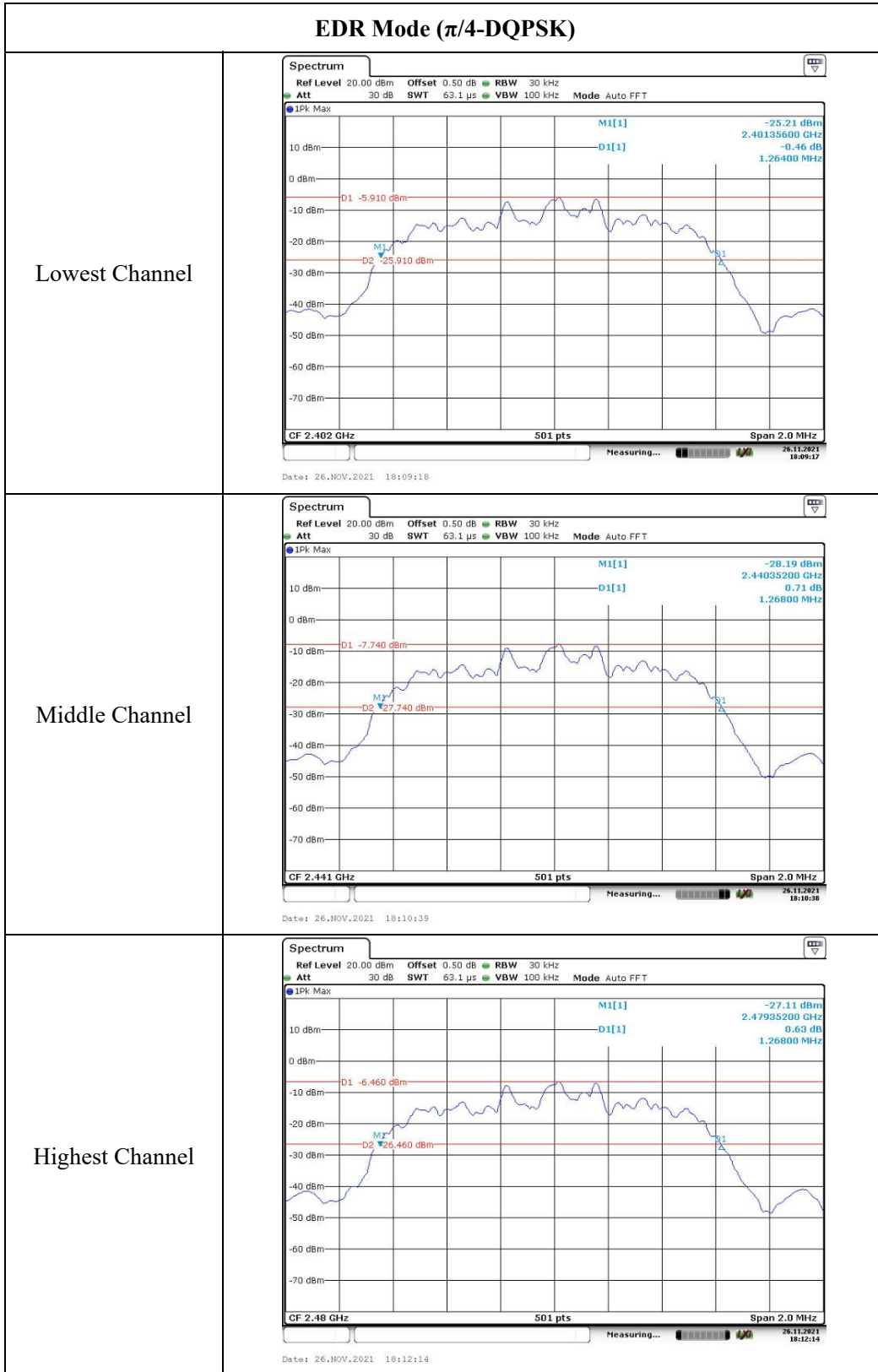

**EDR Mode (8DPSK)**

<p>Lowest Channel</p>	<p><b>Spectrum</b>          Ref Level 20.00 dBm Offset 0.50 dB RBW 30 kHz          Att 30 dB SWT 63.1 μs VBW 100 kHz Mode Auto FFT          1Pk Max          M1[1] -25.60 dBm          D1[1] -0.05 dB          D1 -5.500 dBm          D2 -25.500 dBm          CF 2.402 GHz 501 pts Span 2.0 MHz          Measuring... 26.11.2021 18:14:46</p>
<p>Middle Channel</p>	<p><b>Spectrum</b>          Ref Level 20.00 dBm Offset 0.50 dB RBW 30 kHz          Att 30 dB SWT 63.1 μs VBW 100 kHz Mode Auto FFT          1Pk Max          M1[1] -26.12 dBm          D1[1] 0.05 dB          D1 -6.250 dBm          D2 -26.250 dBm          CF 2.441 GHz 501 pts Span 2.0 MHz          Measuring... 26.11.2021 18:16:16</p>
<p>Highest Channel</p>	<p><b>Spectrum</b>          Ref Level 20.00 dBm Offset 0.50 dB RBW 30 kHz          Att 30 dB SWT 63.1 μs VBW 100 kHz Mode Auto FFT          1Pk Max          M1[1] -25.28 dBm          D1[1] -0.05 dB          D1 -5.160 dBm          D2 -25.160 dBm          CF 2.48 GHz 501 pts Span 2.0 MHz          Measuring... 26.11.2021 18:17:38</p>

**4.4 Channel Separation:**

Serial Number:	CR21110024-RF-S4	Test Date:	2021/11/26
Test Site:	RF	Test Mode:	Transmitting
Tester:	Le Qiao	Test Result:	Pass

**Environmental Conditions:**

Temperature: (°C)	26	Relative Humidity: (%)	61	ATM Pressure: (kPa)	100.3
----------------------	----	------------------------------	----	------------------------	-------

**Test Equipment List and Details:**

Manufacturer	Description	Model	Serial Number	Calibration Date	Calibration Due Date
R&S	Spectrum Analyzer	FSV40	101474	2021/7/22	2022/7/21
zhuoxiang	Coaxial Cable	SMA-178	211001	Each time	N/A
Mini-Circuits	DC Block	BLK-18-S+	1554403	Each time	N/A

\* Statement of Traceability: China Certification ICT Co., Ltd (Dongguan) attests that all calibrations have been performed, traceable to National Primary Standards and International System of Units (SI).

**Test Data:**

Test Modes	Test Frequency (MHz)	Channel Separation (MHz)	Limits (MHz)
BDR Mode (GFSK)	2402	1.000	0.589
	2441	1.000	0.632
	2480	1.000	0.629
EDR Mode ( $\pi/4$ -DQPSK)	2402	1.000	0.843
	2441	1.000	0.845
	2480	1.000	0.845
EDR Mode (8DPSK)	2402	1.000	0.843
	2441	1.000	0.837
	2480	1.000	0.845

**BDR Mode (GFSK)**

<p>Lowest Channel</p>	<p>CF 2.4025 GHz 501 pts Span 3.0 MHz</p> <p>Date: 26.NOV.2021 18:05:52</p>
<p>Middle Channel</p>	<p>CF 2.4415 GHz 501 pts Span 3.0 MHz</p> <p>Date: 26.NOV.2021 18:07:11</p>
<p>Highest Channel</p>	<p>CF 2.4795 GHz 501 pts Span 3.0 MHz</p> <p>Date: 26.NOV.2021 18:08:46</p>



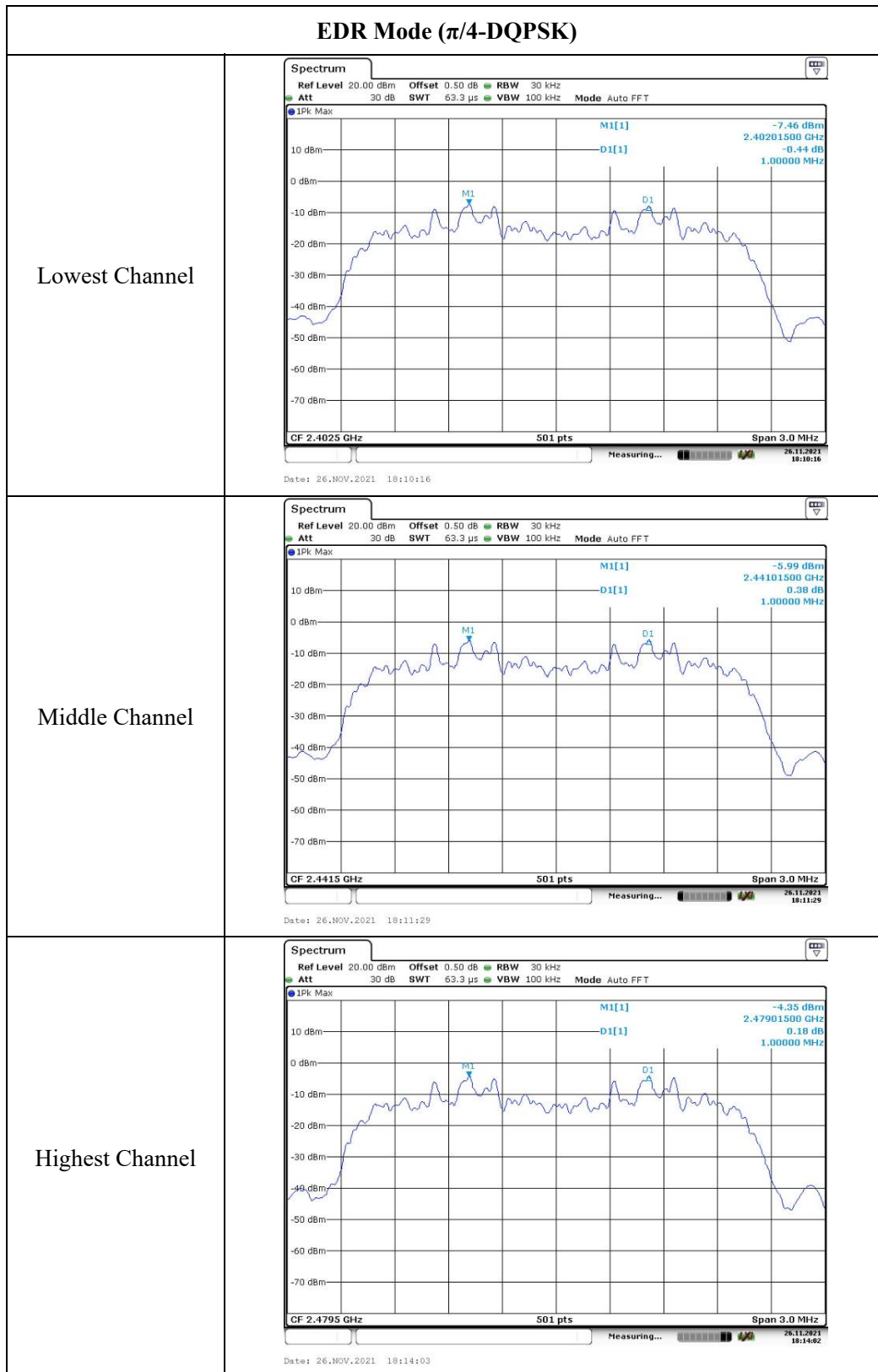

**EDR Mode (8DPSK)**

<p>Lowest Channel</p>	<p>CF 2.4025 GHz 501 pts Span 3.0 MHz</p> <p>Date: 26.NOV.2021 18:15:52</p>
<p>Middle Channel</p>	<p>CF 2.4415 GHz 501 pts Span 3.0 MHz</p> <p>Date: 26.NOV.2021 18:17:17</p>
<p>Highest Channel</p>	<p>CF 2.4795 GHz 501 pts Span 3.0 MHz</p> <p>Date: 26.NOV.2021 18:18:57</p>

**4.5 Number Of Hopping Frequency:**

Serial Number:	CR21110024-RF-S4	Test Date:	2021/11/26
Test Site:	RF	Test Mode:	Transmitting
Tester:	Le Qiao	Test Result:	Pass

**Environmental Conditions:**

Temperature: (°C)	26	Relative Humidity: (%)	61	ATM Pressure: (kPa)	100.3
----------------------	----	------------------------------	----	------------------------	-------

**Test Equipment List and Details:**

Manufacturer	Description	Model	Serial Number	Calibration Date	Calibration Due Date
R&S	Spectrum Analyzer	FSV40	101474	2021/7/22	2022/7/21
zhuoxiang	Coaxial Cable	SMA-178	211001	Each time	N/A
Mini-Circuits	DC Block	BLK-18-S+	1554403	Each time	N/A

\* Statement of Traceability: China Certification ICT Co., Ltd (Dongguan) attests that all calibrations have been performed, traceable to National Primary Standards and International System of Units (SI).

**Test Data:**

Test Modes	Frequency Range (MHz)	Number of Hopping Channel	Limits
GFSK	2400-2483.5	79	≥15
$\pi/4$ -DQPSK	2400-2483.5	79	≥15
8DPSK	2400-2483.5	79	≥15

<p><b>BDR Mode (GFSK)</b></p>	<p><b>Spectrum</b>          Ref Level 20.00 dBm    Offset 0.50 dB    RBW 100 kHz          Att 30 dB    SWT 4.5 ms    VBW 300 kHz    Mode Sweep          1Pk Max          D1[1] 1.62 dB          M1[1] 77.930 MHz          -4.24 dBm          2.402136 GHz          Start 2.4 GHz    501 pts    Stop 2.4835 GHz          Date: 26.NOV.2021 19:47:13</p>
<p><b>EDR Mode (<math>\pi/4</math>-DQPSK)</b></p>	<p><b>Spectrum</b>          Ref Level 20.00 dBm    Offset 0.50 dB    RBW 100 kHz          Att 30 dB    SWT 4.5 ms    VBW 300 kHz    Mode Sweep          1Pk Max          D1[1] 1.38 dB          M1[1] 77.930 MHz          -4.55 dBm          2.401970 GHz          Start 2.4 GHz    501 pts    Stop 2.4835 GHz          Date: 26.NOV.2021 19:49:20</p>
<p><b>EDR Mode (8DPSK)</b></p>	<p><b>Spectrum</b>          Ref Level 20.00 dBm    Offset 0.50 dB    RBW 100 kHz          Att 30 dB    SWT 4.5 ms    VBW 300 kHz    Mode Sweep          1Pk Max          D1[1] 1.47 dB          M1[1] 77.930 MHz          -4.64 dBm          2.401970 GHz          Start 2.4 GHz    501 pts    Stop 2.4835 GHz          Date: 26.NOV.2021 19:51:14</p>

**4.6 Time Of Occupancy(Dwell Time):**

Serial Number:	CR21110024-RF-S4	Test Date:	2021/11/26
Test Site:	RF	Test Mode:	Transmitting
Tester:	Le Qiao	Test Result:	Pass

**Environmental Conditions:**

Temperature: (°C)	26	Relative Humidity: (%)	61	ATM Pressure: (kPa)	100.3
----------------------	----	------------------------------	----	------------------------	-------

**Test Equipment List and Details:**

Manufacturer	Description	Model	Serial Number	Calibration Date	Calibration Due Date
R&S	Spectrum Analyzer	FSV40	101474	2021/7/22	2022/7/21
zhuoxiang	Coaxial Cable	SMA-178	211001	Each time	N/A
Mini-Circuits	DC Block	BLK-18-S+	1554403	Each time	N/A

\* Statement of Traceability: China Certification ICT Co., Ltd (Dongguan) attests that all calibrations have been performed, traceable to National Primary Standards and International System of Units (SI).

**Test Data:**

Test Modes	Packet Type	Test Frequency (MHz)	Pulse width (ms)	Result (s)	Limit (s)
BDR Mode (GFSK)	DH1	2402	0.434	0.139	0.400
	DH3	2402	1.720	0.275	0.400
	DH5	2402	2.981	0.318	0.400
EDR Mode ( $\pi/4$ -DQPSK)	2DH1	2402	0.430	0.138	0.400
	2DH3	2402	1.690	0.270	0.400
	2DH5	2402	2.963	0.316	0.400
EDR Mode (8DPSK)	3DH1	2402	0.426	0.136	0.400
	3DH3	2402	1.684	0.269	0.400
	3DH5	2402	2.954	0.315	0.400

Note:

DH1:Dwell time=Pulse time (ms)  $\times$  (1600/2/79)  $\times$  31.6 s

DH3:Dwell time=Pulse time (ms)  $\times$  (1600/4/79)  $\times$  31.6 s

DH5:Dwell time=Pulse time (ms)  $\times$  (1600/6/79)  $\times$  31.6 s

<b>BDR Mode (GFSK)</b>	
<b>DH1:</b>	<p><b>Spectrum</b>          Ref Level 20.00 dBm    Offset 0.50 dB    RBW 1 MHz          Att 30 dB    SWT 1 ms    VBW 3 MHz          SGL TRG:VID          1Pk Clrw          D1[1] -1.01 dB          M1[1] 434.46 μs          -58.78 dBm          TRG -11.000 dBm          CF 2.441 GHz    501 pts    100.0 μs/</p> <p>Date: 26.NOV.2021 19:25:06</p>
<b>DH3:</b>	<p><b>Spectrum</b>          Ref Level 20.00 dBm    Offset 0.50 dB    RBW 1 MHz          Att 30 dB    SWT 3 ms    VBW 3 MHz          SGL TRG:VID          1Pk Clrw          D1[1] 1.28 dB          M1[1] 1.71962 ms          -57.78 dBm          TRG -11.000 dBm          CF 2.441 GHz    501 pts    300.0 μs/</p> <p>Date: 26.NOV.2021 19:39:59</p>
<b>DH5:</b>	<p><b>Spectrum</b>          Ref Level 20.00 dBm    Offset 0.50 dB    RBW 1 MHz          Att 30 dB    SWT 4.5 ms    VBW 3 MHz          SGL TRG:VID          1Pk Clrw          D1[1] 0.21 dB          M1[1] 2.98062 ms          -55.33 dBm          TRG -11.000 dBm          CF 2.441 GHz    501 pts    450.0 μs/</p> <p>Date: 26.NOV.2021 19:42:51</p>

<b>EDR Mode (<math>\pi/4</math>-DQPSK)</b>	
<b>2DH1:</b>	<p><b>Spectrum</b>                      Ref Level 20.00 dBm    Offset 0.50 dB    RBW 1 MHz                      Att 30 dB    SWT 1 ms    VBW 3 MHz                      SGL TRG:VID                      1Pk Clrw</p> <p>01[1] 0.56 dB                      M1[1] 430.46 <math>\mu</math>s                      -59.13 dBm                      -23.80 <math>\mu</math>s</p> <p>TRG -11.000 dBm</p> <p>CF 2.441 GHz    501 pts    100.0 <math>\mu</math>s/</p> <p>Date: 26.NOV.2021 19:26:36</p>
<b>2DH3:</b>	<p><b>Spectrum</b>                      Ref Level 20.00 dBm    Offset 0.50 dB    RBW 1 MHz                      Att 30 dB    SWT 3 ms    VBW 3 MHz                      SGL TRG:VID                      1Pk Clrw</p> <p>01[1] -2.41 dB                      M1[1] 1.68962 ms                      -55.27 dBm                      -17.80 <math>\mu</math>s</p> <p>TRG -11.000 dBm</p> <p>CF 2.441 GHz    501 pts    300.0 <math>\mu</math>s/</p> <p>Date: 26.NOV.2021 19:40:59</p>
<b>2DH5:</b>	<p><b>Spectrum</b>                      Ref Level 20.00 dBm    Offset 0.50 dB    RBW 1 MHz                      Att 30 dB    SWT 4.5 ms    VBW 3 MHz                      SGL TRG:VID                      1Pk Clrw</p> <p>01[1] 0.91 dB                      M1[1] 2.96262 ms                      -55.17 dBm                      -41.80 <math>\mu</math>s</p> <p>TRG -11.000 dBm</p> <p>CF 2.441 GHz    501 pts    450.0 <math>\mu</math>s/</p> <p>Date: 26.NOV.2021 19:43:38</p>

**EDR Mode (8DPSK)**

**3DH1:**

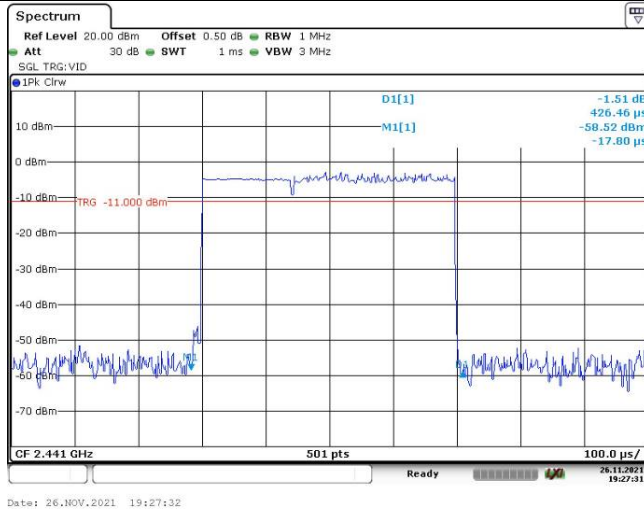

**3DH3:**

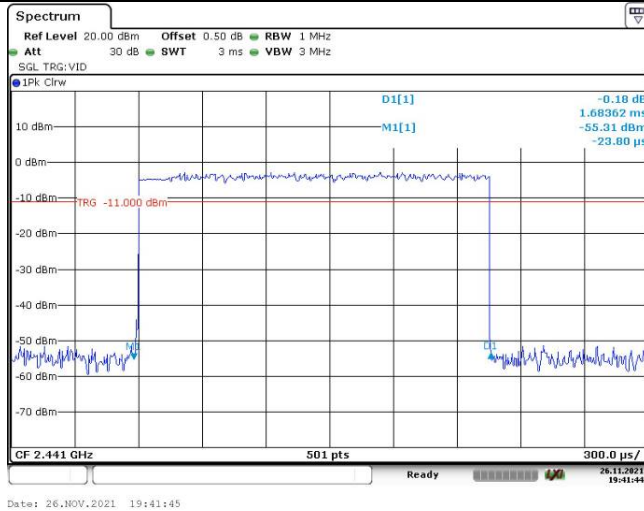

**3DH5:**

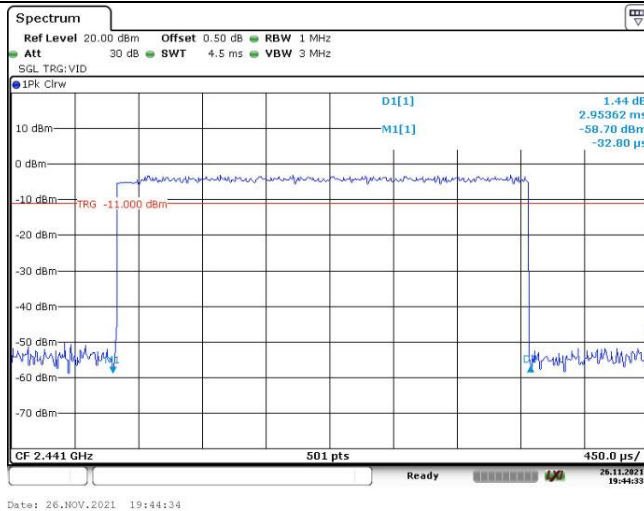



**4.7 Peak Conducted Output Power:**

Serial Number:	CR21110024-RF-S4	Test Date:	2021/11/26
Test Site:	RF	Test Mode:	Transmitting
Tester:	Le Qiao	Test Result:	Pass

**Environmental Conditions:**

Temperature: (°C)	26	Relative Humidity: (%)	61	ATM Pressure: (kPa)	100.3
----------------------	----	------------------------------	----	------------------------	-------

**Test Equipment List and Details:**

Manufacturer	Description	Model	Serial Number	Calibration Date	Calibration Due Date
eastsheep	Coaxial Attenuator	2W-SMA-JK-18G	21060301	Each time	N/A
zhuoxiang	Coaxial Cable	SMA-178	211001	Each time	N/A
Agilent	USB Wideband Power Sensor	U2021XA	MY54080015	2021-07-22	2022-07-21

\* Statement of Traceability: China Certification ICT Co., Ltd (Dongguan) attests that all calibrations have been performed, traceable to National Primary Standards and International System of Units (SI).

**Test Data:**

Test Modes	Test Frequency (MHz)	Peak Conducted Output Power (dBm)	Limits (dBm)
BDR Mode (GFSK)	2402	-1.97	21
	2441	-2.65	21
	2480	-2.31	21
EDR Mode ( $\pi/4$ -DQPSK)	2402	-1.98	21
	2441	-2.50	21
	2480	-0.21	21
EDR Mode (8DPSK)	2402	-1.46	21
	2441	-2.48	21
	2480	0.08	21

**4.8 100 kHz Bandwidth of Frequency Band Edge:**

Serial Number:	CR21110024-RF-S4	Test Date:	2021/11/26
Test Site:	RF	Test Mode:	Transmitting
Tester:	Le Qiao	Test Result:	Pass

**Environmental Conditions:**

Temperature: (°C)	26	Relative Humidity: (%)	61	ATM Pressure: (kPa)	100.3
----------------------	----	------------------------------	----	------------------------	-------

**Test Equipment List and Details:**

Manufacturer	Description	Model	Serial Number	Calibration Date	Calibration Due Date
R&S	Spectrum Analyzer	FSV40	101474	2021/7/22	2022/7/21
zhuoxiang	Coaxial Cable	SMA-178	211001	Each time	N/A
Mini-Circuits	DC Block	BLK-18-S+	1554403	Each time	N/A

*\* Statement of Traceability: China Certification ICT Co., Ltd (Dongguan) attests that all calibrations have been performed, traceable to National Primary Standards and International System of Units (SI).*

**BDR Mode (GFSK)**

**Band Edge,  
Left Side**

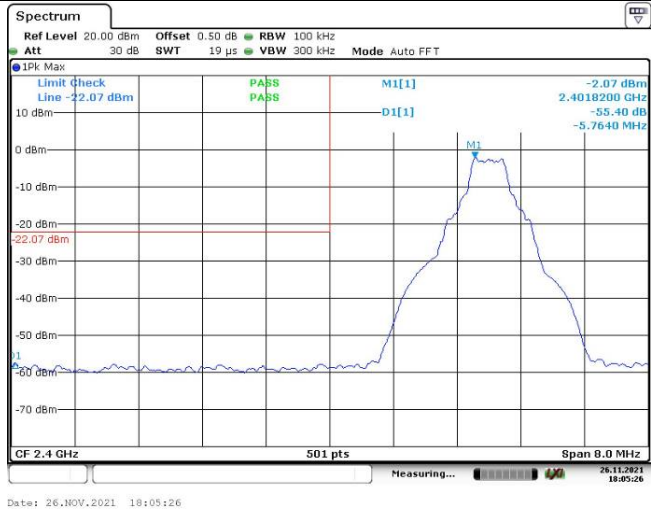

**Band Edge,  
Right Side**

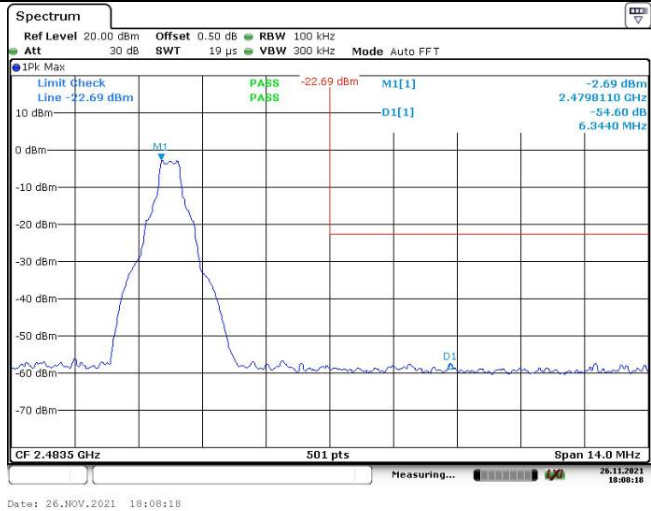

**EDR Mode ( $\pi/4$ -DQPSK)**

**Band Edge,  
Left Side**

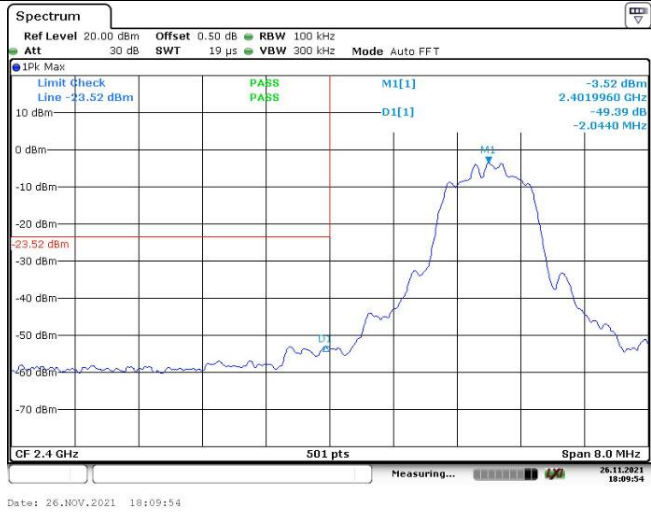

**Band Edge,  
Right Side**

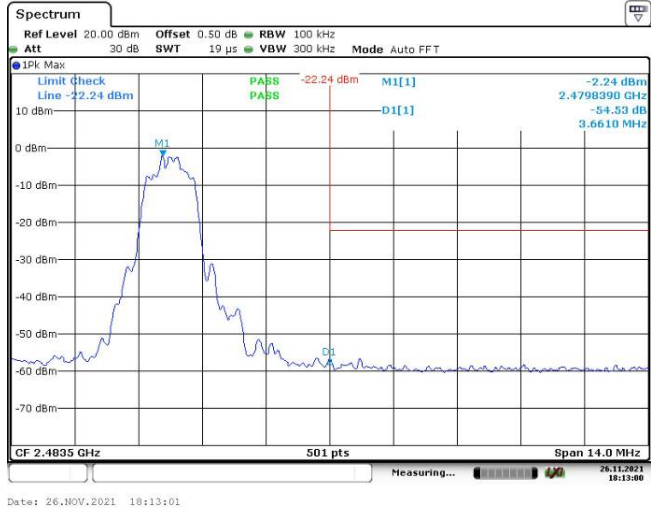

**EDR Mode (8DPSK)**

**Band Edge,  
Left Side**

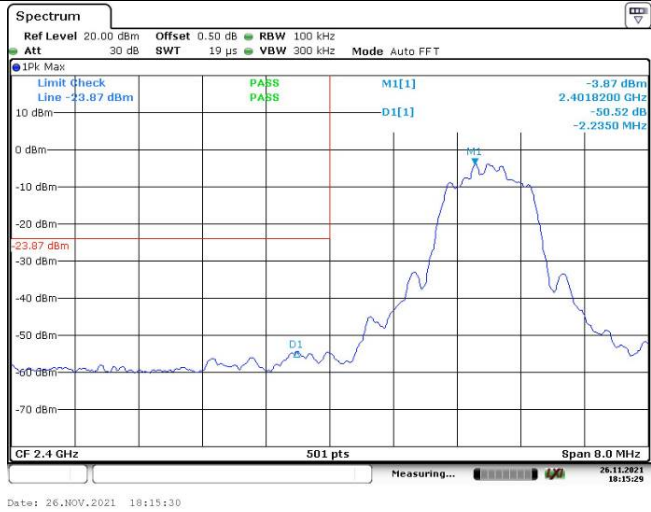

**Band Edge,  
Right Side**



### Hopping Mode, BDR Mode (GFSK)

**Band Edge,  
Left Side**

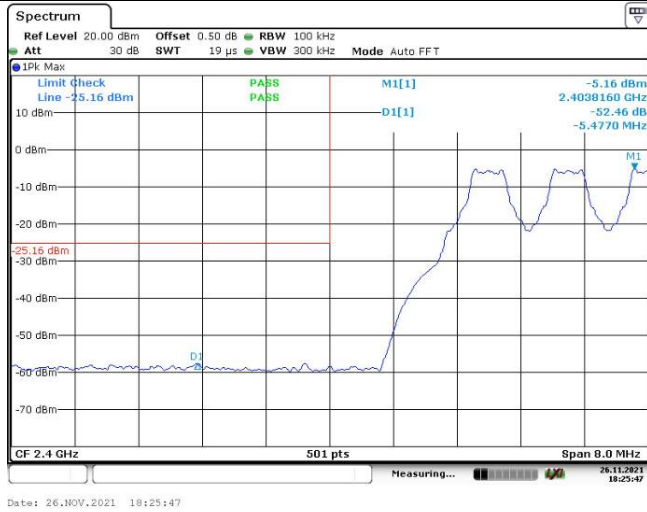

**Band Edge,  
Right Side**

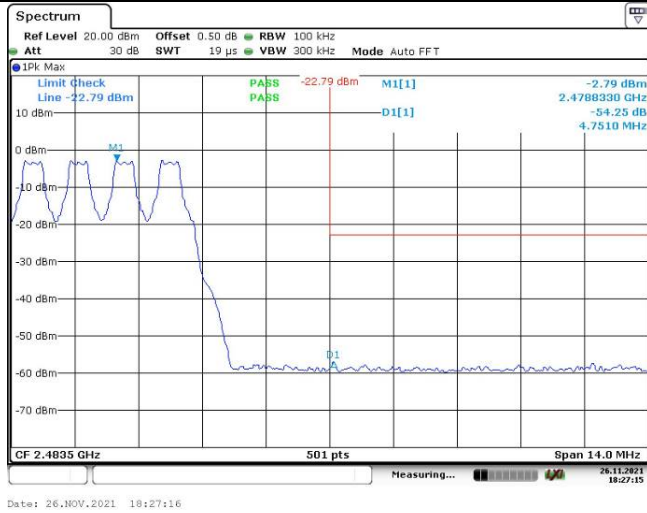

### Hopping Mode, EDR Mode ( $\pi/4$ -DQPSK)

**Band Edge,  
Left Side**

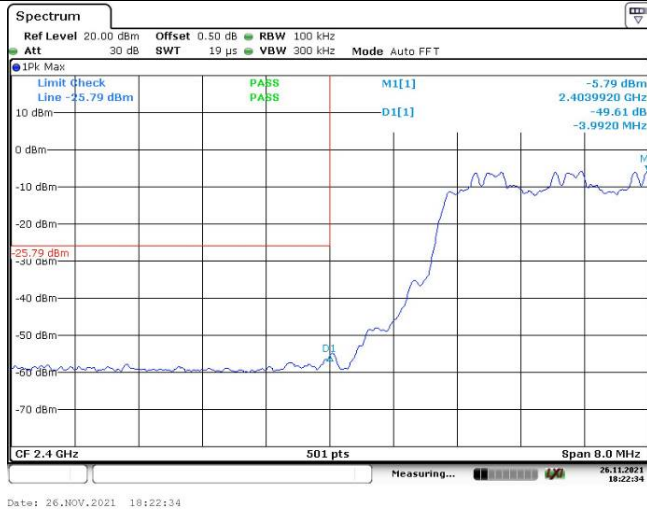

**Band Edge,  
Right Side**

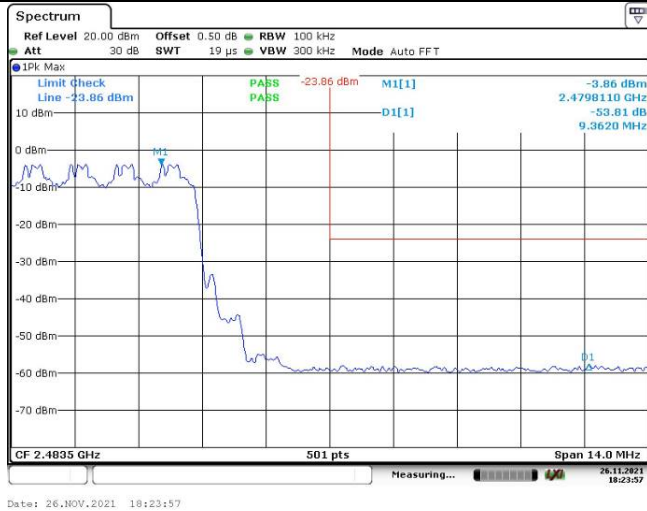

### Hopping Mode, EDR Mode (8DPSK)

**Band Edge,  
Left Side**



**Band Edge,  
Right Side**





## 5. RF EXPOSURE EVALUATION

### 5.1 Applicable Standard

FCC §15.247 (i)

Systems operating under the provisions of this section shall be operated in a manner that ensures that the public is not exposed to radio frequency energy levels in excess of the Commission's guidelines. See §1.1307(b)(1) of this chapter.

### 5.2 Procedure

According to KDB447498 D01 General RF Exposure Guidance v06:

The 1-g and 10-g SAR test exclusion thresholds for 100 MHz to 6 GHz at test separation distances  $\leq 50$  mm are determined by:

$[(\text{max. power of channel, including tune-up tolerance, mW}) / (\text{min. test separation distance, mm})] \cdot [\sqrt{f(\text{GHz})}] \leq 3.0$  for 1-g SAR and  $\leq 7.5$  for 10-g extremity SAR, where

- $f(\text{GHz})$  is the RF channel transmit frequency in GHz
- Power and distance are rounded to the nearest mW and mm before calculation
- The result is rounded to one decimal place for comparison
- 3.0 and 7.5 are referred to as the numeric thresholds in the step 2 below

The test exclusions are applicable only when the minimum test separation distance is  $\leq 50$  mm and for transmission frequencies between 100 MHz and 6 GHz. When the minimum test separation distance is  $< 5$  mm, a distance of 5 mm according to 5) in section 4.1 is applied to determine SAR test exclusion.

### 5.3 Measurement Result

Frequency (MHz)	Conducted Output Power Including Tolerance		Distance (mm)	Calculated value	Threshold (1-g)	SAR Test Exclusion
	(dBm)	(mW)				
2402-2480	0.5	1.12	5	0.4	3	Yes

**Result: Compliance. The stand-alone SAR test is not necessary.**

**\*\*\*\*\* END OF REPORT \*\*\*\*\***