



TEST REPORT

Report No. : CHTEW19080138

Report verification :



Project No. : SHT1907048508EW

FCC ID : 2ASNSRT28

Applicant's name : Shenzhen Retevis Technology Co., Ltd.

Address : Room 700, 7/F, 13-C, Zhonghaixin Science&Technology Park, No.12 Ganli 6th Road, Jihua Street, Longgang District, Shenzhen, China

Manufacturer..... : Shenzhen Retevis Technology Co., Ltd.

Address..... : Room 700, 7/F, 13-C, Zhonghaixin Science&Technology Park, No.12 Ganli 6th Road, Jihua Street, Longgang District, Shenzhen, China

Test item description : Two Way Radio

Trade Mark : RETEVIS

Model/Type reference : RT28

Listed Model(s)..... : RT28S, RT28P, RT628

Standard..... : FCC CFR Title 47 Part 2
FCC CFR Title 47 Part 95B

Date of receipt of test sample..... : Aug.08, 2019

Date of testing..... : Aug.08, 2019-Aug.23, 2019

Date of issue..... : Aug.26, 2019

Result : PASS

Compiled by
(position+printed name+signature) . : File administrators Echo Wei

Supervised by
(position+printed name+signature) . : Project Engineer Edward Pan

Approved by
(position+printed name+signature) . : RF Manager Hans Hu

Testing Laboratory Name..... : Shenzhen Huatongwei International Inspection Co., Ltd.

Address : 1/F, Bldg 3, Hongfa Hi-tech Industrial Park, Genyu Road, Tianliao, Gongming, Shenzhen, China

Shenzhen Huatongwei International Inspection Co., Ltd. All rights reserved.

This publication may be reproduced in whole or in part for non-commercial purposes as long as the Shenzhen Huatongwei International Inspection Co., Ltd. is acknowledged as copyright owner and source of the material. Shenzhen Huatongwei International Inspection Co., Ltd. takes no responsibility for and will not assume liability for damages resulting from the reader's interpretation of the reproduced material due to its placement and context.

The test report merely correspond to the test sample.

Contents

1	<u>TEST STANDARDS AND REPORT VERSION</u>	3
1.1.	Test Standards	3
1.2.	Report revised information	3
2	<u>TEST DESCRIPTION</u>	4
3	<u>SUMMARY</u>	5
3.1	Client Information	5
3.2	Product Description	5
3.3	Test frequency list	6
3.4	Operation mode	7
3.5	EUT configuration	7
4	<u>TEST ENVIRONMENT</u>	8
4.1	Address of the test laboratory	8
4.2	Test Facility	8
4.3	Environmental conditions	9
4.4	Statement of the measurement uncertainty	9
4.5	Equipments Used during the Test	10
5	<u>TEST CONDITIONS AND RESULTS</u>	11
5.1	Effective Radiated Power(ERP)	11
5.2	99% Occupied Bandwidth & 26dB Bandwidth	13
5.3	Emission Mask	14
5.4	Modulation Limit	15
5.5	Audio Frequency Response	16
5.6	Audio Low Pass Filter Response	18
5.7	Frequency stability VS Temperature	19
5.8	Frequency stability VS Voltage	20
5.9	Transmitter Radiated Spurious Emission	21
5.10	AC Power Line Conducted Emission	25
5.11	Radiated Emission	28
6	<u>TEST SETUP PHOTOS OF THE EUT</u>	31
7	<u>EXTERNAL AND INTERNAL PHOTOS OF THE EUT</u>	34
8	<u>APPENDIX REPORT</u>	38

1 TEST STANDARDS AND REPORT VERSION

1.1. Test Standards

The tests were performed according to following standards:

[FCC Rules Part 2](#): Frequency allocations and radio treaty matters; General rules and regulations

[FCC Rules Part 95B](#): PERSONAL RADIO SERVICES-Family Radio Service (FRS)

[ANSI C63.26-2015](#): American National Standard for Compliance Testing of Transmitters Used in Licensed Radio Services

[ANSI/TIA-603-E\(2016\)](#): Land Mobile FM or PM Communications Equipment and Performance Standards

[FCC Part 15 Subpart B](#): Unintentional Radiators.

[ANSI C63.4-2014](#): American National Standard for Methods of Measurement of Radio-Noise Emissions from Low-Voltage Electrical and Electronic Equipment in the Range of 9 kHz to 40 GHz

1.2. Report revised information

Revised No.	Date of issued	Description
N/A	2019-08-26	Original

2 TEST DESCRIPTION

Test Item	Section in CFR 47	Result	Test Engineer
Carrier Output Power(ERP)	Part 95.567 Part 2.1046(a)	Pass	Pan Xie
99% Occupied Bandwidth & 26dB bandwidth	Part 95.573 Part 2.1049	Pass	Bruse.Li
Emission Mask	Part 95.579(a)(1)(2)(3) Part 2.1049	Pass	Bruse.Li
Modulation Limit	Part 95.575 Part 2.1047(b)	Pass	Bruse.Li
Audio Frequency Response	Part 95.575 Part 2.1047(a)	Pass	Bruse.Li
Audio Low Pass Filter Response	Part 95.575 Part 2.1047(a)	Pass	Bruse.Li
Frequency Stability V.S. Temperature	Part 95.565 Part 2.1055	Pass	Bruse.Li
Frequency Stability V.S. Voltage	Part 95.565 Part 2.1055	Pass	Bruse.Li
Transmit Radiated Spurious Emission	Part 95.579(a)(3) Part 2.1053	Pass	Bruse.Li
AC Power Line Conducted Emission	Part 15.107	Pass	Kang Yang
Radiated Emission	Part 15.109	Pass	Pan Xie

3 SUMMARY

3.1 Client Information

Applicant:	Shenzhen Retevis Technology Co., Ltd.
Address:	Room 700, 7/F, 13-C, Zhonghaixin Science&Technology Park, No.12 Ganli 6th Road, Jihua Street, Longgang District, Shenzhen, China
Manufacturer:	Shenzhen Retevis Technology Co., Ltd.
Address:	Room 700, 7/F, 13-C, Zhonghaixin Science&Technology Park, No.12 Ganli 6th Road, Jihua Street, Longgang District, Shenzhen, China

3.2 Product Description

Name of EUT:	Two Way Radio
Trade mark:	RETEVIS
Model/Type reference:	RT28
Listed model(s):	RT28S, RT28P, RT628
Power supply:	DC 3.7V
Battery information:	Model: BL28 Voltage: DC 3.7V Capacity: 1000mAh(3.7Wh)
Adapter information:	Model: DSA-5PF07-05 FUS 050100 Input:100-240Va.c.,50/60Hz 0.2A Output:5Vd.c.,1A
Hardware version:	BF-V1-A21-VER1.4
Software version:	BF-V1-A21-VER1.2
RF Specification	
Support Frequency Range:	462.5625MHz~ 462.7125MHz
	462.5500MHz~ 462.7250MHz
Rated Output Power:	2W
Modulation Type:	FM(Analog)
Emission Designator: * ¹	11K0F3E
Antenna Type:	Integrated antenna
Antenna Gain:	1.5dBi

Note:

- (1) *¹ According to FCC Part 2.202 requirements, the Necessary Bandwidth is calculated as follows:
 - For FM Voice Modulation
Channel Spacing = 12.5 KHz, D = 2.5 KHz max, K = 1, M = 3 KHz
Bn = 2M + 2DK = 2*3 + 2*2.5*1 = **11 KHz**
Emission designation: 11K0F3E
- (2) The device only supports voice communication.
- (3) The device has no gain and vertically polarized antenna.

3.3 Test frequency list

According to ANSI C63.26 section 5.1.2.1:

Measurements of transmitters shall be performed and, if required, reported for each frequency band in which the EUT can be operated with the device transmitting at the number of frequencies in each band specified in Table 2.

Frequency range over which EUT operates	Number of frequencies	Location in frequency range of operation
1 MHz or less	1	Middle
1 MHz to 10 MHz	2	1 near top and 1 near bottom
More than 10 MHz	3	1 near top, 1 near middle, and 1 near bottom

Frequency Bands (MHz)	Test Channel	Test Frequency (MHz)
462.5625~462.7125	CH _{M1}	462.6375(CH4)
462.5500~462.7250	CH _{M2}	462.6500(CH12)

Operational channel frequency table:

Channel No.	Center frequency (MHz)	Channel No.	Center frequency (MHz)
1	462.5625	12	462.6500
2	462.5875	13	462.5750
3	462.6125	14	462.7000
4	462.6375	15	462.7250
5	462.6625	16	X
6	462.6875	17	
7	462.7125	18	
8	462.5500	19	
9	462.5750	20	
10	462.6000	21	
11	462.6250	22	

3.4 Operation mode

Test mode	Transmitting	Receiving	FRS
TX-FRS	■		■
RX-FRS		■	■

Note: ■ is operation mode.

Modulation Type	Description
UM	Un-modulation
AM2	Apply a 1000 Hz tone and adjust the audio frequency generator to produce 20% of the rated system deviation.
AM6	Apply a 1000 Hz modulating signal to the transmitter from the audio frequency generator, and adjust the level to obtain 60% of full rated system deviation, then increase the level from the audio generator by 20 dB
AM5	Modulate the transmitter with a 2500 Hz sine wave at an input level 16 dB greater than that necessary to produce 50% of rated system deviation.

Test item	Modulation Type	Test mode
Output Power(ERP)	UM	TX-FRS
99% Occupied Bandwidth & 26dB bandwidth	AM6	TX-FRS
Emission Mask	AM5	TX-FRS
Modulation Limit	AM6	TX-FRS
Audio Frequency Response	AM2	TX-FRS
Audio Low Pass Filter Response	AM2	TX-FRS
Frequency Stability VS Temperature	UM	TX-FRS
Frequency Stability VS Voltage	UM	TX-FRS
Transmit Radiated Spurious Emission	AM5	TX-FRS
AC Power Line Conducted Emission	-	RX-FRS
Radiated Emission	-	RX-FRS

3.5 EUT configuration

The following peripheral devices and interface cables were connected during the measurement:

- - supplied by the manufacturer
- - supplied by the lab

●	Power Cable	Length (m) :	/
		Shield :	/
		Detachable :	/
○	Multimeter	Manufacturer :	/
		Model No. :	/

4 TEST ENVIRONMENT

4.1 Address of the test laboratory

Laboratory: Shenzhen Huatongwei International Inspection Co., Ltd.

Address: 1/F, Bldg 3, Hongfa Hi-tech Industrial Park, Genyu Road, Tianliao, Gongming, Shenzhen, China

4.2 Test Facility

The test facility is recognized, certified, or accredited by the following organizations:

CNAS-Lab Code: L1225

Shenzhen Huatongwei International Inspection Co., Ltd. has been assessed and proved to be in compliance with CNAS-CL01 Accreditation Criteria for Testing and Calibration Laboratories (identical to ISO/IEC17025: 2005 General Requirements) for the Competence of Testing and Calibration Laboratories.

A2LA-Lab Cert. No. 3902.01

Shenzhen Huatongwei International Inspection Co., Ltd. EMC Laboratory has been accredited by A2LA for technical competence in the field of electrical testing, and proved to be in compliance with ISO/IEC 17025: 2005 General Requirements for the Competence of Testing and Calibration Laboratories and any additional program requirements in the identified field of testing.

FCC-Registration No.: 762235

Shenzhen Huatongwei International Inspection Co., Ltd. EMC Laboratory has been registered and fully described in a report filed with the FCC (Federal Communications Commission). The acceptance letter from the FCC is maintained in our files. Registration 762235.

IC-Registration No.: 5377A

Two 3m Alternate Test Site of Shenzhen Huatongwei International Inspection Co., Ltd. has been registered by Certification and Engineering Bureau of Industry Canada for the performance of radiated measurements with Registration No. 5377A.

ACA

Shenzhen Huatongwei International Inspection Co., Ltd. EMC Laboratory can also perform testing for the Australian C-Tick mark as a result of our A2LA accreditation.

4.3 Environmental conditions

Atmospheric Contions	
Temperature:	21°C to 25°C
Relative Humidity:	20 % to 75 %.
Atmospheric Pressure:	860 mbar to 1060 mbar
Norminal Test Voltage:	$V_N = DC 3.70V$
Extrem Test Voltage @115% V_N :	$V_H = DC 4.26V$
Extrem Test Voltage @85% V_N :	$V_L = DC 3.15V$

4.4 Statement of the measurement uncertainty

The data and results referenced in this document are true and accurate. The reader is cautioned that there may be errors within the calibration limits of the equipment and facilities. The measurement uncertainty was calculated for all measurements listed in this test report acc. to CISPR 16 - 4 „Specification for radio disturbance and immunity measuring apparatus and methods – Part 4: Uncertainty in EMC Measurements“ and is documented in the Shenzhen Huatongwei International Inspection Co., Ltd quality system acc. to DIN EN ISO/IEC 17025. Furthermore, component and process variability of devices similar to that tested may result in additional deviation. The manufacturer has the sole responsibility of continued compliance of the device.

Hereafter the best measurement capability for Shenzhen Huatongwei laboratory is reported:

Test Items	Measurement Uncertainty	Notes
Frequency stability & Occupied Bandwidth	15Hz for <1GHz 70Hz for >1GHz	(1)
Conducted Output Power	0.51dB	(1)
ERP / EIRP / RSE	2.66dB for <1GHz 3.44dB for >1GHz	(1)
Conducted Emission 9KHz-30MHz	3.02dB	(1)
Radiated Emission 30~1000MHz	4.90dB	(1)
Radiated Emission 1~18GHz	4.96dB	(1)
FM deviation	25 Hz	(1)
Audio level	0.62 dB	(1)
Low Pass Filter Response	0.76 dB	(1)
Modulation Limiting	0.42 %	(1)

(1) This uncertainty represents an expanded uncertainty expressed at approximately the 95% confidence level using a coverage factor of $k=1.96$.

4.5 Equipments Used during the Test

● TS8613 Test system						
Used	Test Equipment	Manufacturer	Model No.	Serial No.	Last Cal. Date (YY-MM-DD)	Next Cal. Date (YY-MM-DD)
●	Spectrum Analyzer	Agilent	N9020A	MY50510187	2018/09/29	2019/09/28
●	Signal & Spectrum Analyzer	R&S	FSW26	103440	2018/10/28	2019/10/27
●	RF Communication Test Set	HP	8920A	3813A10206	2018/10/28	2019/10/27
●	Digital intercom communication tester	Aeroflex	3920B	1001682041	2018/10/28	2019/10/27
●	Signal Generator	R&S	SML02	100507	2018/10/27	2019/10/26
●	Signal Generator	IFR	2032	203002\100	2018/11/11	2019/11/10
●	RF Control Unit	Tonscend	JS0806-2	N/A	N/A	N/A
○	Fliter-VHF	Microwave	N26460M1	498702	2019/03/19	2020/03/18
●	Fliter-UHF	Microwave	N25155M2	498704	2019/03/19	2020/03/18
○	Power Divider	Microwave	OPD1040-N-4	N/A	2018/11/15	2019/11/14
○	Attenuator	JFW	50FH-030-100	N/A	2018/11/15	2019/11/14
○	Attenuator	JFW	50-A-MFN-20	0322	2018/11/15	2019/11/14
●	Test software	HTW	Radio ATE	N/A	N/A	N/A

● Auxiliary Equipment						
Used	Test Equipment	Manufacturer	Model No.	Serial No.	Last Cal. Date (YY-MM-DD)	Next Cal. Date (YY-MM-DD)
●	Climate chamber	ESPEC	GPL-2	N/A	2018/11/08	2019/11/07
●	DC Power Supply	Gwinstek	SPS-2415	GER835793	2018/10/28	2019/10/27

● Radiated Spurious Emission						
Used	Test Equipment	Manufacturer	Model No.	Serial No.	Last Cal. Date (YY-MM-DD)	Next Cal. Date (YY-MM-DD)
●	Semi-Anechoic Chamber	Albatross projects	SAC-3m-01	N/A	2018/09/30	2021/09/29
●	Spectrum Analyzer	R&S	FSP40	100597	2018/10/27	2019/10/26
●	Loop Antenna	R&S	HFH2-Z2	100020	2017/11/20	2020/11/19
●	Ultra-Broadband Antenna	SCHWARZBECK	VULB9163	538	2017/04/05	2020/04/04
●	Horn Antenna	SCHWARZBECK	9120D	1011	2017/04/01	2020/03/31
○	Horn Antenna	SCHWARZBECK	BBHA9170	25841	2017/03/27	2020/03/26
○	Pre-amplifier	BONN	BLWA0160-2M	1811887	2018/11/14	2019/11/13
●	Pre-amplifier	CD	PAP-0102	12004	2018/11/14	2019/11/13
●	Broadband Preamplifier	SCHWARZBECK	BBV 9718	9718-248	2019/05/23	2020/05/22
●	RF Connection Cable	HUBER+SUHNER	RE-7-FH	N/A	2018/11/15	2019/11/14
●	RF Connection Cable	HUBER+SUHNER	RE-7-FL	N/A	2018/11/15	2019/11/14
●	EMI Test Software	Audix	E3	N/A	N/A	N/A
●	Turntable	MATURO	TT2.0	N/A	N/A	N/A
●	Antenna Mast	MATURO	TAM-4.0-P	N/A	N/A	N/A

5 TEST CONDITIONS AND RESULTS

5.1 Effective Radiated Power(ERP)

LIMIT

FCC Part FCC Part 95.567, FCC Part 2.1046

Each FRS transmitter type must be designed such that the effective radiated power (ERP) on channels 8 through 14 does not exceed 0.5 Watts and the ERP on channels 1 through 7 and 15 through 22 does not exceed 2.0 Watts. The radio shall be equipped with an integral antenna.

TEST CONFIGURATION

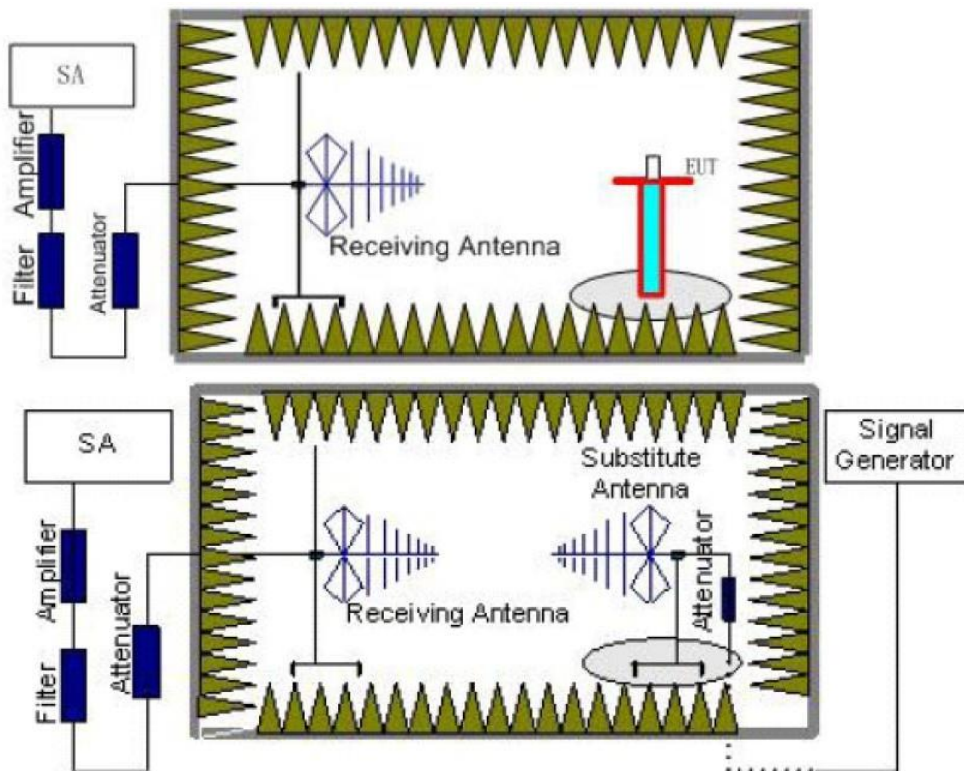

TEST PROCEDURE

1. Place the EUT in the center of the turntable.
 - a) For radiated emissions measurements performed at frequencies less than or equal to 1 GHz, the EUT shall be placed on a RF-transparent table at a nominal height of 80 cm above the reference ground plane
 - b) For radiated measurements performed at frequencies above 1 GHz, the EUT shall be placed on an RF transparent table at a nominal height of 1.5 m above the ground plane.
2. Unless the EUT uses an integral antenna, the EUT shall be terminated with a non-radiating transmitter load. In cases where the EUT uses an adjustable antenna, the antenna shall be adjusted through typical positions and lengths to maximize emissions levels.
3. The EUT shall be tested while operating on the frequency per manufacturer specification. Set the transmitter to operate in continuous transmit mode.
4. Receiver or Spectrum set as follow:
 - Below 1GHz, RBW=100kHz, VBW=300kHz, Detector=Peak, Sweep time=Auto
 - Above 1GHz, RBW=1MHz, VBW=3MHz, Detector=Peck, Sweep time=Auto
5. Each emission under consideration shall be evaluated:
 - a) Raise and lower the measurement antenna from 1 m to 4 m, as necessary to enable detection of the maximum emission amplitude relative to measurement antenna height.
 - b) Rotate the EUT through 360° to determine the maximum emission level relative to the axial position.
 - c) Return the turntable to the azimuth where the highest emission amplitude level was observed.
 - d) Vary the measurement antenna height again through 1 m to 4 m again to find the height associated with the maximum emission amplitude.
 - e) Record the measured emission amplitude level and frequency

6. Repeat step 5 for each emission frequency with the measurement antenna oriented in both the horizontal and vertical polarizations to determine the orientation that gives the maximum emissions amplitude.
7. Set-up the substitution measurement with the reference point of the substitution antenna located as near as possible to where the center of the EUT radiating element was located during the initial EUT measurement.
8. Maintain the previous measurement instrument settings and test set-up, with the exception that the EUT is removed and replaced by the substitution antenna.
9. Connect a signal generator to the substitution antenna; locate the signal generator so as to minimize any potential influences on the measurement results. Set the signal generator to the frequency where emissions are detected, and set an output power level such that the radiated signal can be detected by the measurement instrument, with sufficient dynamic range relative to the noise floor.
10. For each emission that was detected and measured in the initial test
 - a) Vary the measurement antenna height between 1 m to 4 m to maximize the received (measured) signal amplitude.
 - b) Adjust the signal generator output power level until the amplitude detected by the measurement instrument equals the amplitude level of the emission previously measured directly in step 5 and step 6.
 - c) Record the output power level of the signal generator when equivalence is achieved in step b).
11. Repeat step 8 through step 10 with the measurement antenna oriented in the opposite polarization.
12. Calculate the emission power in dBm referenced to a half-wave dipole using the following equation:
$$P_e = P_s(\text{dBm}) - \text{cable loss (dB)} + \text{antenna gain (dBd)}$$
where
 P_e = equivalent emission power in dBm
 P_s = source (signal generator) power in dBm
NOTE—dBd refers to the measured antenna gain in decibels relative to a half-wave dipole.
13. Correct the antenna gain of the substitution antenna if necessary to reference the emission power to a half-wave dipole. When using measurement antennas with the gain specified in dBi, the equivalent dipole-referenced gain can be determined from:
$$\text{gain (dBd)} = \text{gain (dBi)} - 2.15 \text{ dB.}$$
If necessary, the antenna gain can be calculated from calibrated antenna factor information
14. Provide the complete measurement results as a part of the test report.

TEST MODE

Please reference to the section 3.4

TEST RESULTS

Passed **Not Applicable**

Please refer to appendix A on the section 8 appendix report

5.2 99% Occupied Bandwidth & 26dB Bandwidth

LIMIT

FCC Part 95.573, FCC Part 2.1049

Each FRS transmitter type must be designed such that the occupied bandwidth does not exceed 12.5 kHz.

TEST CONFIGURATION

Test setup for Analog:

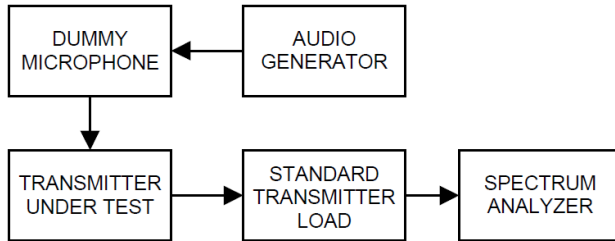

TEST PROCEDURE

- (1) Connect the equipment as illustrated
- (2) Spectrum set as follow:
Centre frequency = the nominal EUT channel center frequency,
The frequency span for the spectrum analyzer shall be set wide enough to capture all modulation products including the emission skirts (typically a span of $1.5 \times \text{OBW}$ is sufficient)
RBW = 1% to 5% of the anticipated OBW, VBW $\geq 3 \times \text{RBW}$, Sweep = auto,
Detector function = peak, Trace = max hold
- (3) Set 99% Occupied Bandwidth and 26dB Bandwidth
- (4) Measure and record the results in the test report.

TEST MODE

Please reference to the section 3.4

TEST RESULTS

Passed Not Applicable

Please refer to appendix B on the section 8 appendix report

5.3 Emission Mask

LIMIT

FCC Part 95.579(a)(1)(2)(3), FCC Part 2.1049

Each FRS transmitter type must be designed to satisfy the applicable unwanted emissions limits in this paragraph.

(a) Attenuation requirements. The power of unwanted emissions must be attenuated below the carrier power output in Watts (P) by at least:

- (1) 25 dB (decibels) in the frequency band 6.25 kHz to 12.5 kHz removed from the channel center frequency.
- (2) 35 dB in the frequency band 12.5 kHz to 31.25 kHz removed from the channel center frequency.
- (3) $43 + 10 \log (P)$ dB in any frequency band removed from the channel center frequency by more than 31.25 kHz.

TEST CONFIGURATION

Test setup for Analog:

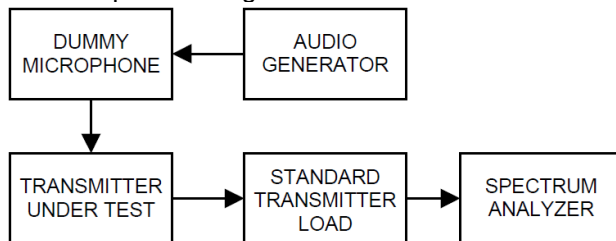

TEST PROCEDURE

- 1) Connect the equipment as illustrated.
- 2) Spectrum set as follow:
Centre frequency = fundamental frequency, span=120kHz for 12.5kHz channel spacing,
RBW=100Hz, VBW=1000Hz, Sweep = auto,
Detector function = peak, Trace = max hold
- 3) Key the transmitter, and set the level of the unmodulated carrier to a full scale reference line. This is the 0dB reference for the measurement.
- 4) Apply Input Modulation Signal to EUT according to Section 3.4
- 5) Measure and record the results in the test report.

TEST MODE

Please reference to the section 3.4

TEST RESULTS

Passed Not Applicable

Please refer to appendix C on the section 8 appendix report

5.4 Modulation Limit

LIMIT

FCC Part 95.575, FCC Part 2.1047(b)

Each FRS transmitter type must be designed such that the peak frequency deviation does not exceed 2.5 kHz, and the highest audio frequency contributing substantially to modulation must not exceed 3.125 kHz.

TEST CONFIGURATION

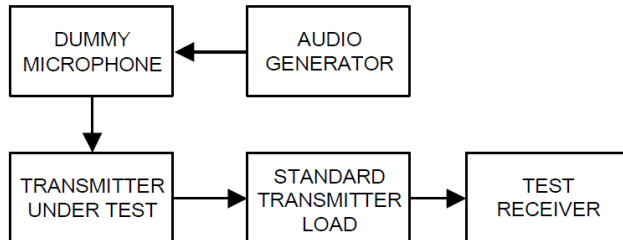

TEST PROCEDURE

- 1) Connect the equipment as illustrated.
- 2) Adjust the transmitter per the manufacturer's procedure for full rated system deviation.
- 3) Set the test receiver to measure peak positive deviation. Set the audio bandwidth for ≤ 0.25 Hz to $\geq 15,000$ Hz. Turn the de-emphasis function off.
- 4) Apply Input Modulation Signal to EUT according to Section 3.4 and vary the input level from -20 to $+20$ dB.
- 5) Measure both the instantaneous and steady-state deviation at and after the time of increasing the audio input level
- 6) Repeat step 4-5 with input frequency changing to 300Hz, 1004Hz, 1500Hz and 2500Hz in sequence.

TEST MODE

Please reference to the section 3.4

TEST RESULTS

Passed Not Applicable

Please refer to appendix D on the section 8 appendix report

5.5 Audio Frequency Response

LIMIT

FCC Part 95.575), FCC Part 2.1047(a):

Each FRS transmitter type must be designed such that the peak frequency deviation does not exceed 2.5 kHz, and the highest audio frequency contributing substantially to modulation must not exceed 3.125 kHz.

Voice modulated communication equipment. A curve or equivalent data showing the frequency response of the audio modulating circuit over a range of 100 to 5000 Hz shall be submitted.

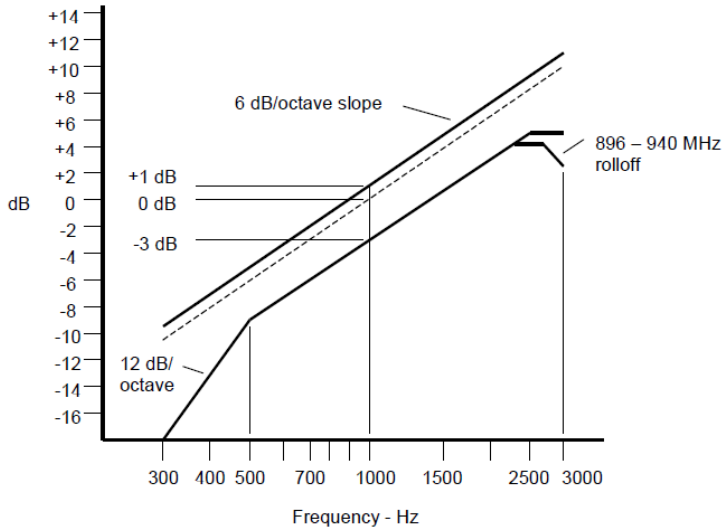

An additional 6 dB per octave attenuation is allowed from 2500 Hz to 3000 Hz in equipment operating in the 25 MHz to 869 MHz range.

TEST CONFIGURATION

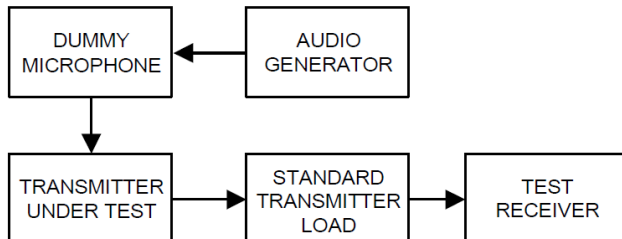

TEST PROCEDURE

- 1) Connect the equipment as illustrated.
- 2) Set the test receiver to measure peak positive deviation. Set the audio bandwidth for 50 Hz to 15,000 Hz. Turn the de-emphasis function off.
- 3) Set the DMM to measure rms voltage.
- 4) Adjust the transmitter per the manufacturer's procedure for full rated system deviation.
- 5) Apply Input Modulation Signal to EUT according to Section 3.4
- 6) Set the test receiver to measure rms deviation and record the deviation reading.
- 7) Record the DMM reading as V_{REF} .
- 8) Set the audio frequency generator to the desired test frequency between 300 Hz and 3000 Hz.
- 9) Vary the audio frequency generator output level until the deviation reading that was recorded in step 6) is obtained.
- 10) Record the DMM reading as V_{FREQ}
- 11) Calculate the audio frequency response at the present frequency as:
audio frequency response = $20 \log_{10} (V_{FREQ}/V_{REF})$.
- 12) Repeat steps 8) through 11) for all the desired test frequencies

TEST MODE

Please reference to the section 3.4

TEST RESULTS

Passed **Not Applicable**

Please refer to appendix E on the section 8 appendix report

5.6 Audio Low Pass Filter Response

LIMIT

FCC Part 95.575), FCC Part 2.1047(a):

The filter must be between the modulation limiter and the modulated stage of the transmitter. At any frequency (f in kHz) between 3 and 20 kHz, the filter must have an attenuation of at least $60 \log_{10}(f/3)$ dB greater than the attenuation at 1 kHz. Above 20 kHz, it must have an attenuation of at least 50 dB greater than the attenuation at 1 kHz.

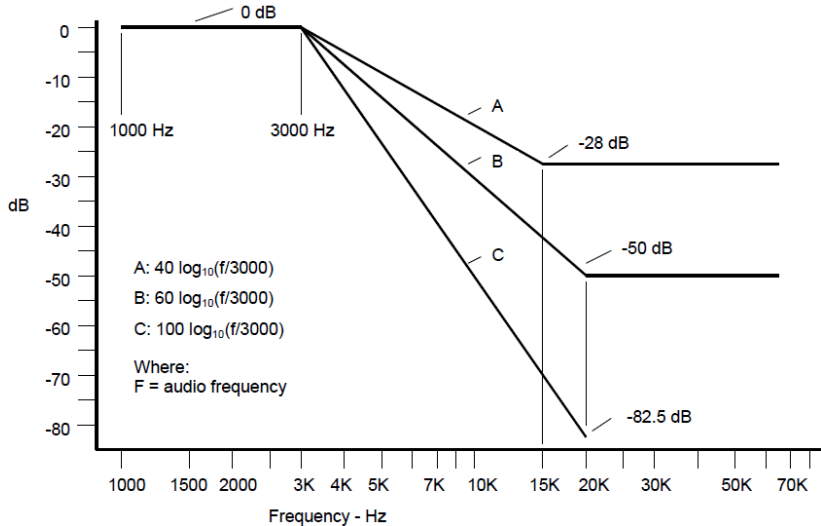

TEST CONFIGURATION

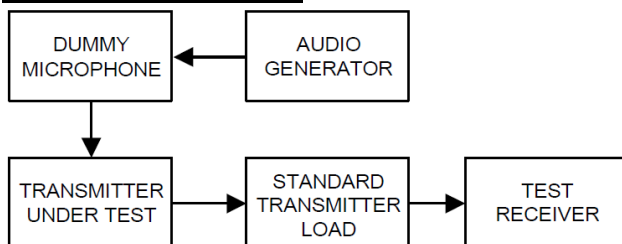

TEST PROCEDURE

- 1) Configure the EUT as shown in figure .
- 2) Apply a 1000 Hz tone from the audio signal generator and adjust the level per manufacturer's specifications. Record the dB level of the 1000 Hz tone as LEV_{REF} .
- 3) Set the audio signal generator to the desired test frequency between 3000 Hz and the upper low pass filter limit. Record the dB level at the test frequency as LEV_{FREQ} .
- 4) Calculate the audio frequency response at the test frequency as:
 low pass filter response = $LEV_{FREQ} - LEV_{REF}$

TEST MODE

Please reference to the section 3.4

TEST RESULTS

Passed Not Applicable

Please refer to appendix F on the section 8 appendix report

5.7 Frequency stability VS Temperature

LIMIT

FCC Part 95.565:

Each FRS transmitter type must be designed such that the carrier frequencies remain within ± 2.5 parts-per-million of the channel center frequencies specified in §95.563 during normal operating conditions.

TEST CONFIGURATION

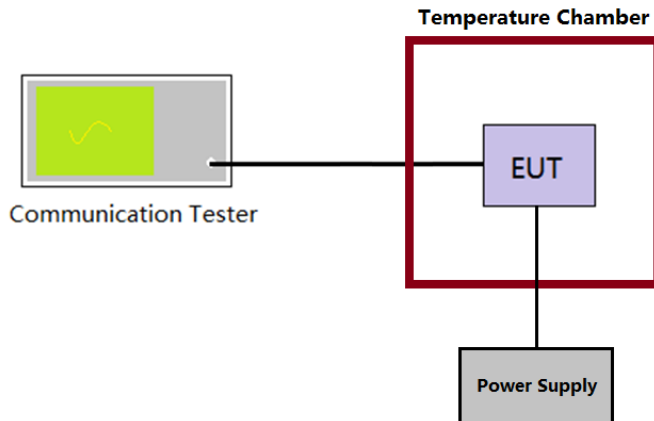

TEST PROCEDURE

- 1) The EUT output port was connected to communication tester.
- 2) The EUT was placed inside the temperature chamber.
- 3) Turn EUT off and set the chamber temperature to -30°C . After the temperature stabilized for approximately 30 minutes recorded the frequency as MCF_{MHz} .
- 4) Calculate the ppm frequency error by the following:

$$\text{ppm error} = (MCF_{\text{MHz}} / ACF_{\text{MHz}} - 1) * 10^6$$
 where
 MCF_{MHz} is the Measured Carrier Frequency in MHz
 ACF_{MHz} is the Assigned Carrier Frequency in MHz
- 5) Repeat step 3 measure with 10°C increased per stage until the highest temperature of $+50^{\circ}\text{C}$ reached.

TEST MODE

Please reference to the section 3.4

TEST RESULTS

Passed Not Applicable

Please refer to appendix G on the section 8 appendix report

5.8 Frequency stability VS Voltage

LIMIT

FCC Part 95.565:

Each FRS transmitter type must be designed such that the carrier frequencies remain within ± 2.5 parts-per-million of the channel center frequencies specified in §95.563 during normal operating conditions.

TEST CONFIGURATION

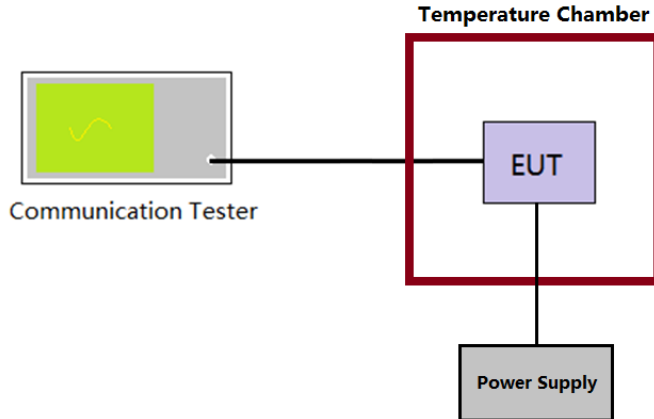

TEST PROCEDURE

- 1) The EUT output port was connected to communication tester.
- 2) The EUT was placed inside the temperature chamber at 25°C
- 3) Record the carrier frequency of the transmitter as MCF_{MHz}
- 4) Calculate the ppm frequency error by the following:
$$ppm\ error = (MCF_{MHz} / ACF_{MHz} - 1) * 10^6$$

where
 MCF_{MHz} is the Measured Carrier Frequency in MHz
 ACF_{MHz} is the Assigned Carrier Frequency in MHz
- 5) Repeat step 3 measure with varied $\pm 15\%$ of the nominal value measured at the input to the EUT

TEST MODE

Please reference to the section 3.4

TEST RESULTS

Passed Not Applicable

Please refer to appendix H on the section 8 appendix report

5.9 Transmitter Radiated Spurious Emission

LIMIT

FCC Part 95.579(a)(3):

$43 + 10 \log (P_{\text{watts}})$

Calculation: Limit (dBm) = EL - 43 - 10 log₁₀ (TP)

Notes: EL is the emission level of the Output Power expressed in dBm,
In this application, the EL is P (dBm).

Limit (dBm) = P (dBm) - 43 - 10 log (Pwatts) = -13 dBm

TEST CONFIGURATION

Below 1GHz:

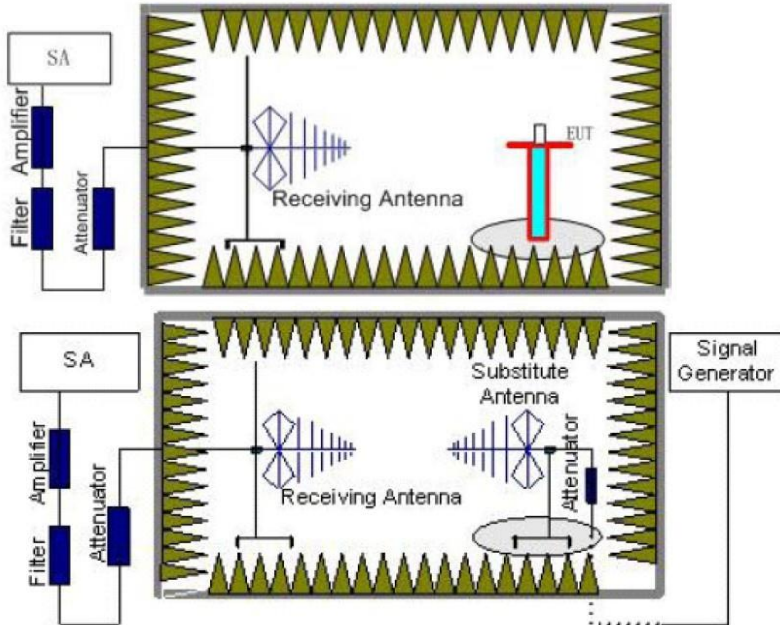

Above 1GHz:

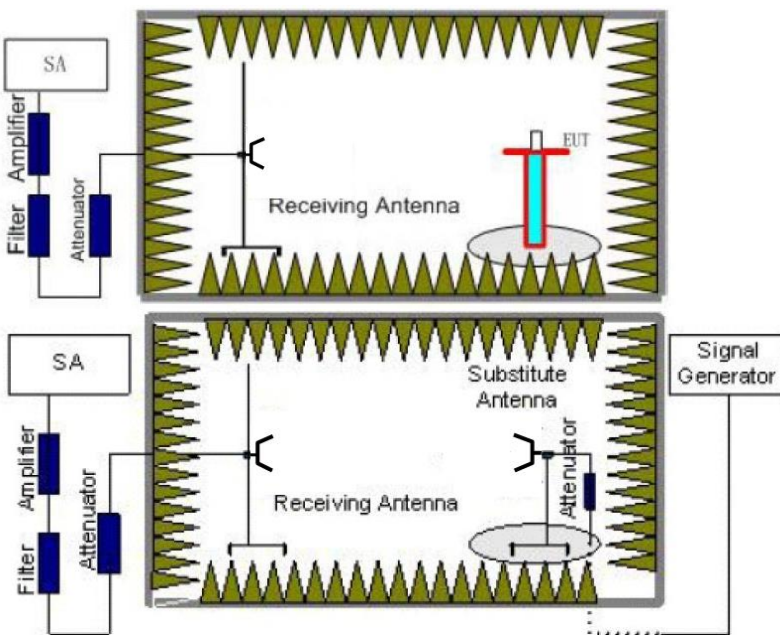

TEST PROCEDURE

1. Place the EUT in the center of the turntable.
 - a) For radiated emissions measurements performed at frequencies less than or equal to 1 GHz, the EUT shall be placed on a RF-transparent table at a nominal height of 80 cm above the reference ground plane
 - b) For radiated measurements performed at frequencies above 1 GHz, the EUT shall be placed on an RF transparent table at a nominal height of 1.5 m above the ground plane.
2. Unless the EUT uses an integral antenna, the EUT shall be terminated with a non-radiating transmitter load. In cases where the EUT uses an adjustable antenna, the antenna shall be adjusted through typical positions and lengths to maximize emissions levels.
3. The EUT shall be tested while operating on the frequency per manufacturer specification. Set the transmitter to operate in continuous transmit mode.
4. Receiver or Spectrum set as follow:
Below 1GHz, RBW=100kHz, VBW=300kHz, Detector=Peak, Sweep time=Auto
Above 1GHz, RBW=1MHz, VBW=3MHz, Detector=Peck, Sweep time=Auto
5. Each emission under consideration shall be evaluated:
 - a) Raise and lower the measurement antenna from 1 m to 4 m, as necessary to enable detection of the maximum emission amplitude relative to measurement antenna height.
 - b) Rotate the EUT through 360° to determine the maximum emission level relative to the axial position.
 - c) Return the turntable to the azimuth where the highest emission amplitude level was observed.
 - d) Vary the measurement antenna height again through 1 m to 4 m again to find the height associated with the maximum emission amplitude.
 - e) Record the measured emission amplitude level and frequency
6. Repeat step 5 for each emission frequency with the measurement antenna oriented in both the horizontal and vertical polarizations to determine the orientation that gives the maximum emissions amplitude.
7. Set-up the substitution measurement with the reference point of the substitution antenna located as near as possible to where the center of the EUT radiating element was located during the initial EUT measurement.
8. Maintain the previous measurement instrument settings and test set-up, with the exception that the EUT is removed and replaced by the substitution antenna.
9. Connect a signal generator to the substitution antenna; locate the signal generator so as to minimize any potential influences on the measurement results. Set the signal generator to the frequency where emissions are detected, and set an output power level such that the radiated signal can be detected by the measurement instrument, with sufficient dynamic range relative to the noise floor.
10. For each emission that was detected and measured in the initial test
 - a) Vary the measurement antenna height between 1 m to 4 m to maximize the received (measured) signal amplitude.
 - b) Adjust the signal generator output power level until the amplitude detected by the measurement instrument equals the amplitude level of the emission previously measured directly in step 5 and step 6.
 - c) Record the output power level of the signal generator when equivalence is achieved in step b).
11. Repeat step 8 through step 10 with the measurement antenna oriented in the opposite polarization.
12. Calculate the emission power in dBm referenced to a half-wave dipole using the following equation:

$$P_e = P_s(\text{dBm}) - \text{cable loss (dB)} + \text{antenna gain (dBd)}$$
 where
 P_e = equivalent emission power in dBm
 P_s = source (signal generator) power in dBm
NOTE—dBd refers to the measured antenna gain in decibels relative to a half-wave dipole.
13. Correct the antenna gain of the substitution antenna if necessary to reference the emission power to a half-wave dipole. When using measurement antennas with the gain specified in dBi, the equivalent dipole-referenced gain can be determined from:

$$\text{gain (dBd)} = \text{gain (dBi)} - 2.15 \text{ dB.}$$
 If necessary, the antenna gain can be calculated from calibrated antenna factor information
14. Provide the complete measurement results as a part of the test report.

TEST MODE

Please reference to the section 3.4

TEST RESULTS

Passed **Not Applicable**

TEST MODE	TX-FRS	Test Channel:	CH _{M1}	Polarity:	Horizontal
-----------	--------	---------------	------------------	-----------	------------

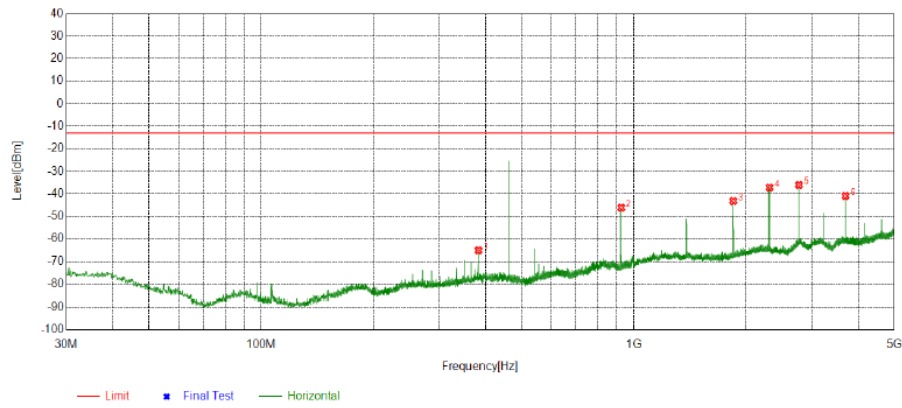

NO.	Freq. [MHz]	Reading [dBm]	Factor [dB]	Level [dBm]	Limit [dBm]	Margin [dB]	Polarity	Detector
1	383.0800	-68.84	3.67	-65.17	-13.00	52.17	Horizontal	PK
2	925.3100	-55.56	9.38	-46.18	-13.00	33.18	Horizontal	PK
3	1850.500	-49.43	6.18	-43.25	-13.00	30.25	Horizontal	PK
4	2313.000	-47.17	9.93	-37.24	-13.00	24.24	Horizontal	PK
5	2776.000	-50.21	14.13	-36.08	-13.00	23.08	Horizontal	PK
6	3701.000	-55.55	14.58	-40.97	-13.00	27.97	Horizontal	PK

TEST MODE	TX-FRS	Test Channel:	CH _{M1}	Polarity:	Vertical
-----------	--------	---------------	------------------	-----------	----------

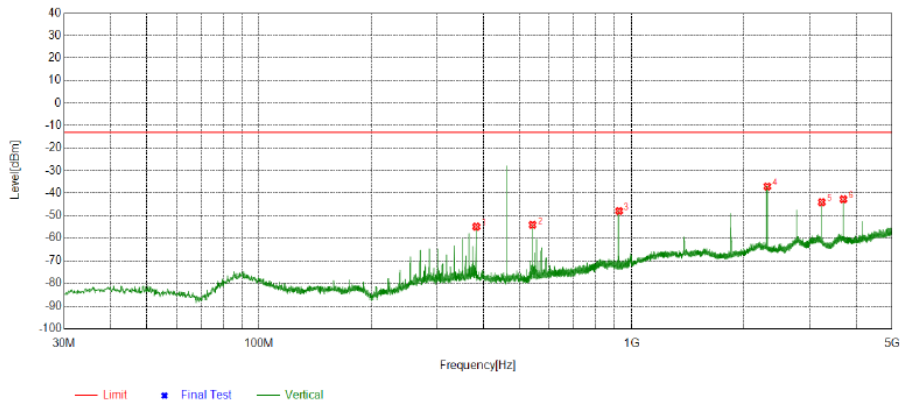

NO.	Freq. [MHz]	Reading [dBm]	Factor [dB]	Level [dBm]	Limit [dBm]	Margin [dB]	Polarity	Detector
1	383.0800	-58.48	3.49	-54.99	-13.00	41.99	Vertical	PK
2	542.2813	-58.02	3.85	-54.17	-13.00	41.17	Vertical	PK
3	925.3100	-57.63	9.65	-47.98	-13.00	34.98	Vertical	PK
4	2313.000	-47.07	9.97	-37.10	-13.00	24.10	Vertical	PK
5	3238.500	-57.05	12.92	-44.13	-13.00	31.13	Vertical	PK
6	3701.500	-57.45	14.61	-42.84	-13.00	29.84	Vertical	PK

TEST MODE	TX-FRS	Test Channel:	CH _{M2}	Polarity:	Horizontal
-----------	--------	---------------	------------------	-----------	------------

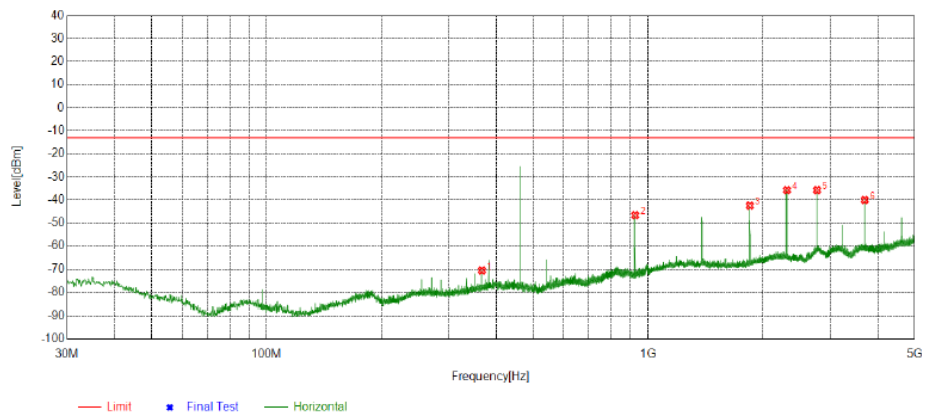

NO.	Freq. [MHz]	Reading [dBm]	Factor [dB]	Level [dBm]	Limit [dBm]	Margin [dB]	Polarity	Detector
1	367.0750	-73.67	3.03	-70.64	-13.00	57.64	Horizontal	PK
2	925.4313	-56.07	9.38	-46.69	-13.00	33.69	Horizontal	PK
3	1850.500	-48.70	6.18	-42.52	-13.00	29.52	Horizontal	PK
4	2313.500	-45.74	9.93	-35.81	-13.00	22.81	Horizontal	PK
5	2776.000	-49.95	14.13	-35.82	-13.00	22.82	Horizontal	PK
6	3701.000	-54.66	14.58	-40.08	-13.00	27.08	Horizontal	PK

TEST MODE	TX-FRS	Test Channel:	CH _{M2}	Polarity:	Vertical
-----------	--------	---------------	------------------	-----------	----------

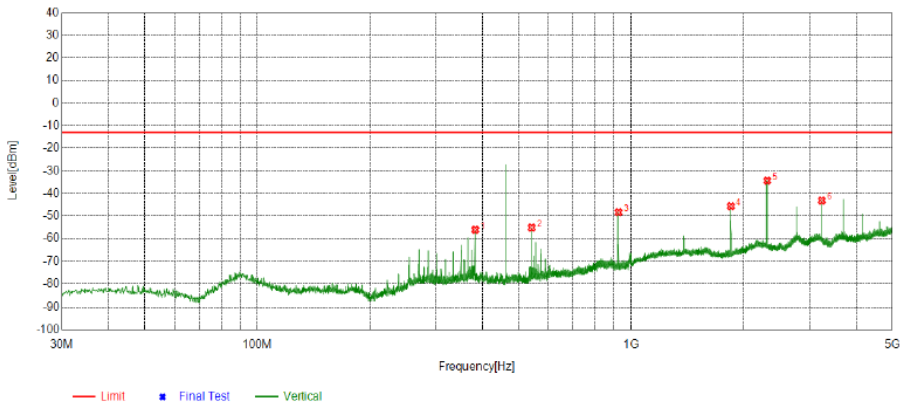

NO.	Freq. [MHz]	Reading [dBm]	Factor [dB]	Level [dBm]	Limit [dBm]	Margin [dB]	Polarity	Detector
1	383.0800	-59.59	3.49	-56.10	-13.00	43.10	Vertical	PK
2	542.2813	-59.00	3.85	-55.15	-13.00	42.15	Vertical	PK
3	925.4313	-58.00	9.65	-48.35	-13.00	35.35	Vertical	PK
4	1850.500	-51.46	5.78	-45.68	-13.00	32.68	Vertical	PK
5	2313.500	-44.30	9.97	-34.33	-13.00	21.33	Vertical	PK
6	3238.500	-56.04	12.92	-43.12	-13.00	30.12	Vertical	PK

5.10 AC Power Line Conducted Emission

The frequency spectrum from 0.15 MHz to 30 MHz was investigated. The LISN used was 50 ohm / 50 u Henry as specified by section 5.1 of ANSI C63.4. Cables and peripherals were moved to find the maximum emission levels for each frequency.

Limit

FCC part 15.107(a)

Frequency of emission (MHz)	Conducted limit (dBµV)	
	Quasi-peak	Average
0.15-0.5	66 to 56*	56 to 46*
0.5-5	56	46
5-30	60	50

TEST CONFIGURATION

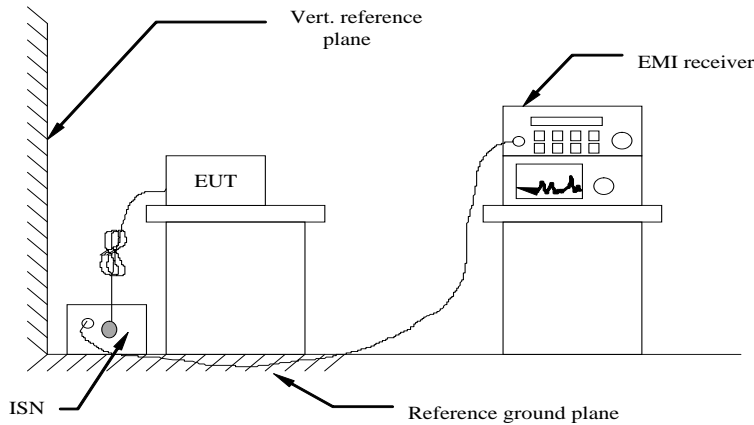

TEST PROCEDURE

- 1 The equipment was set up as per the test configuration to simulate typical actual usage per the user’s manual. The EUT is a tabletop system; a wooden table with a height of 0.8 meters is used and is placed on the ground plane as per ANSI C63.4
- 2 Support equipment, if needed, was placed as per ANSI C63.4
- 3 All I/O cables were positioned to simulate typical actual usage as per ANSI C63.4.
- 4 If a EUT received AC120V/60Hz power through a Line Impedance Stabilization Network (LISN) which supplied power source and was grounded to the ground plane.
- 5 All support equipments received AC power from a second LISN, if any
- 6 The EUT test program was started. Emissions were measured on each current carrying line of the EUT using a spectrum Analyzer / Receiver connected to the LISN powering the EUT. The LISN has two monitoring points: Line 1 (Hot Side) and Line 2 (Neutral Side). Two scans were taken: one with Line 1 connected to Analyzer / Receiver and Line 2 connected to a 50 ohm load; the second scan had Line 1 connected to a 50 ohm load and Line 2 connected to the Analyzer / Receiver.
- 7 Analyzer / Receiver scanned from 150 kHz to 30MHz for emissions in each of the test modes.
- 8 During the above scans, the emissions were maximized by cable manipulation.

TEST MODE

Please reference to the section 3.4

TEST RESULTS

Passed Not Applicable

Polarity: L

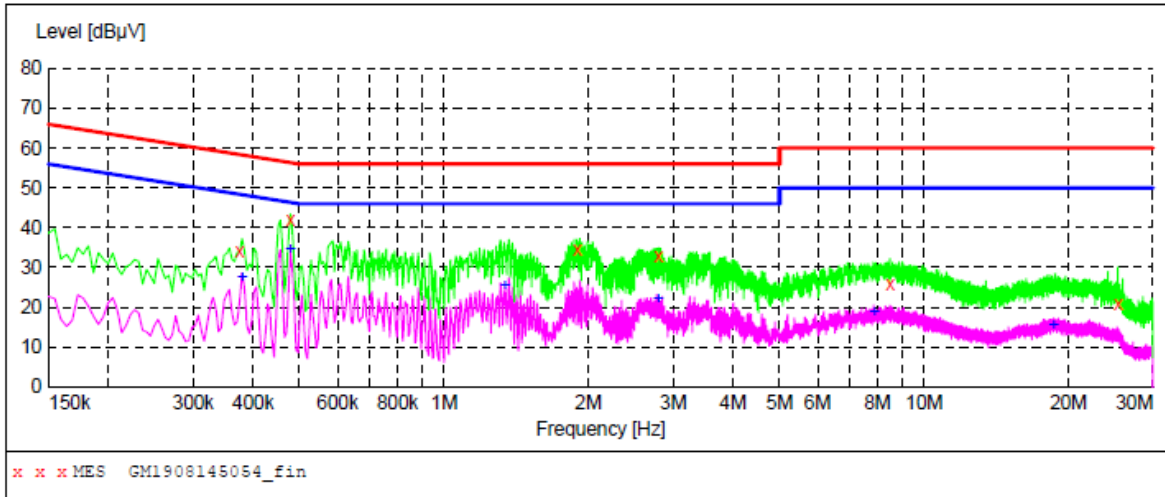

MEASUREMENT RESULT: "GM1908145054_fin"

8/14/2019 4:31PM

Frequency MHz	Level dBµV	Transd dB	Limit dBµV	Margin dB	Detector	Line	PE
0.375000	34.20	9.9	58	24.2	QP	L1	GND
0.478500	42.10	9.9	56	14.3	QP	L1	GND
1.891500	34.50	9.9	56	21.5	QP	L1	GND
2.791500	33.00	9.9	56	23.0	QP	L1	GND
8.493000	26.00	10.1	60	34.0	QP	L1	GND
25.368000	21.00	10.3	60	39.0	QP	L1	GND

MEASUREMENT RESULT: "GM1908145054_fin2"

8/14/2019 4:31PM

Frequency MHz	Level dBµV	Transd dB	Limit dBµV	Margin dB	Detector	Line	PE
0.379500	27.50	9.9	48	20.8	AV	L1	GND
0.478500	34.50	9.9	46	11.9	AV	L1	GND
1.338000	25.40	9.9	46	20.6	AV	L1	GND
2.796000	22.00	9.9	46	24.0	AV	L1	GND
7.872000	18.60	10.0	50	31.4	AV	L1	GND
18.600000	15.60	10.2	50	34.4	AV	L1	GND

Polarity: N

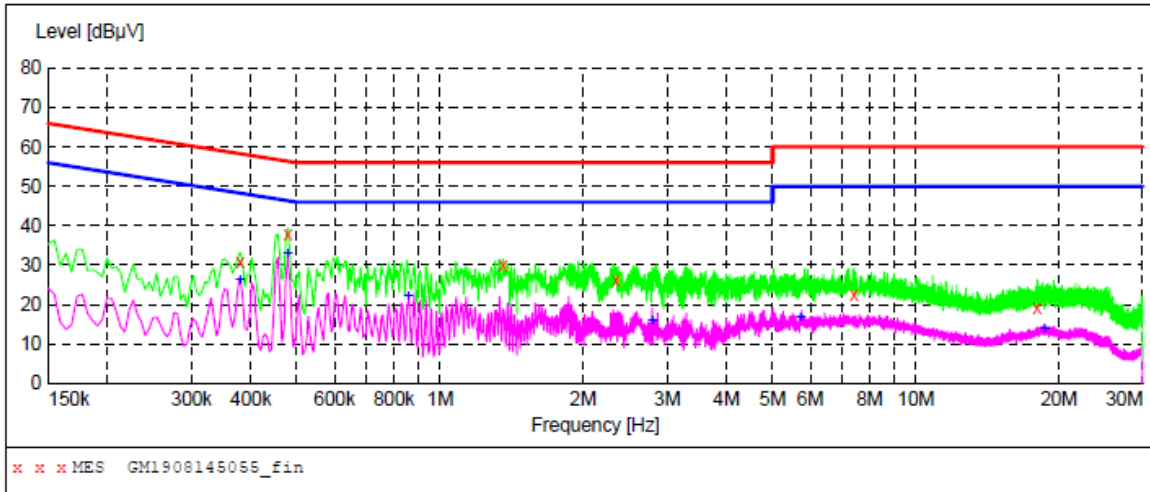

MEASUREMENT RESULT: "GM1908145055_fin"

8/14/2019 4:34PM

Frequency MHz	Level dBµV	Transd dB	Limit dBµV	Margin dB	Detector	Line	PE
0.379500	30.70	9.9	58	27.6	QP	N	GND
0.478500	38.00	9.9	56	18.4	QP	N	GND
1.356000	29.80	9.9	56	26.2	QP	N	GND
2.341500	26.40	9.9	56	29.6	QP	N	GND
7.413000	22.40	10.0	60	37.6	QP	N	GND
18.006000	19.00	10.2	60	41.0	QP	N	GND

MEASUREMENT RESULT: "GM1908145055_fin2"

8/14/2019 4:34PM

Frequency MHz	Level dBµV	Transd dB	Limit dBµV	Margin dB	Detector	Line	PE
0.379500	26.40	9.9	48	21.9	AV	N	GND
0.478500	32.70	9.9	46	13.7	AV	N	GND
0.856500	22.00	9.9	46	24.0	AV	N	GND
2.791500	16.00	9.9	46	30.0	AV	N	GND
5.730000	16.80	10.0	50	33.2	AV	N	GND
18.667500	13.60	10.2	50	36.4	AV	N	GND

5.11 Radiated Emission

LIMIT

For unintentional device, according to § 15.109(a) except for Class A digital devices, the field strength of radiated emissions from unintentional radiators at a distance of 3 meters shall not exceed the following values:

Frequency of emission (MHz)	Field strength (microvolts/meter)
30-88	100
88-216	150
216-960	200
Above 960	500

For intentional device, according to § 15.209(a), the general requirement of field strength of radiated emissions from intentional radiators at a distance of 3 meters shall not exceed the above table.

TEST CONFIGURATION

(A) Radiated Emission Test Set-Up, Frequency below 1000MHz

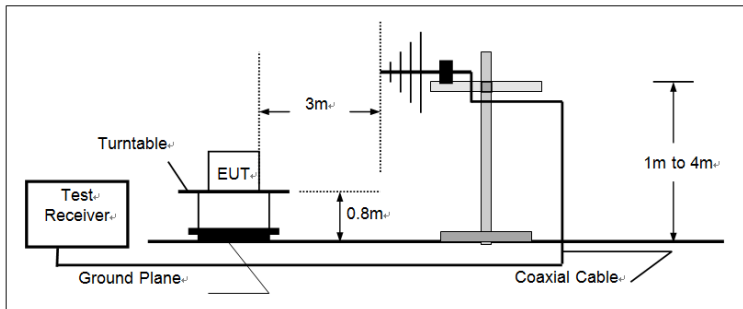

(B) Radiated Emission Test Set-Up, Frequency above 1000MHz

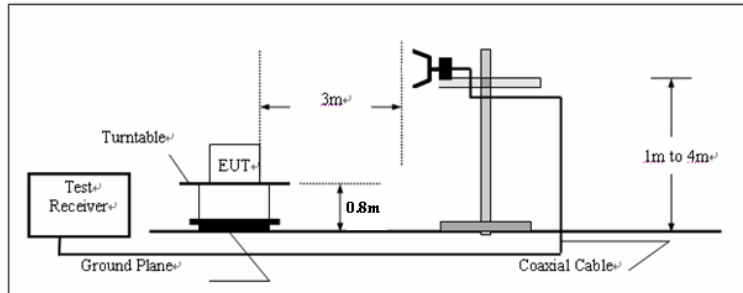

TEST PROCEDURE

- 1 The EUT was placed on a turn table which is 0.8m above ground plane.
- 2 Maximum procedure was performed by raising the receiving antenna from 1m to 4m and rotating the turn table from 0° to 360° to acquire the highest emissions from EUT
- 3 And also, each emission was to be maximized by changing the polarization of receiving antenna both horizontal and vertical.
- 4 Repeat above procedures until all frequency measurements have been completed.

TEST MODE

Please reference to the section 3.4

TEST RESULTS

Passed Not Applicable

Note:

The EUT shall be scanned from 30 MHz to the 5th harmonic of the highest oscillator frequency in the digital devices or 1 GHz whichever is higher.

Polarity: Horizontal

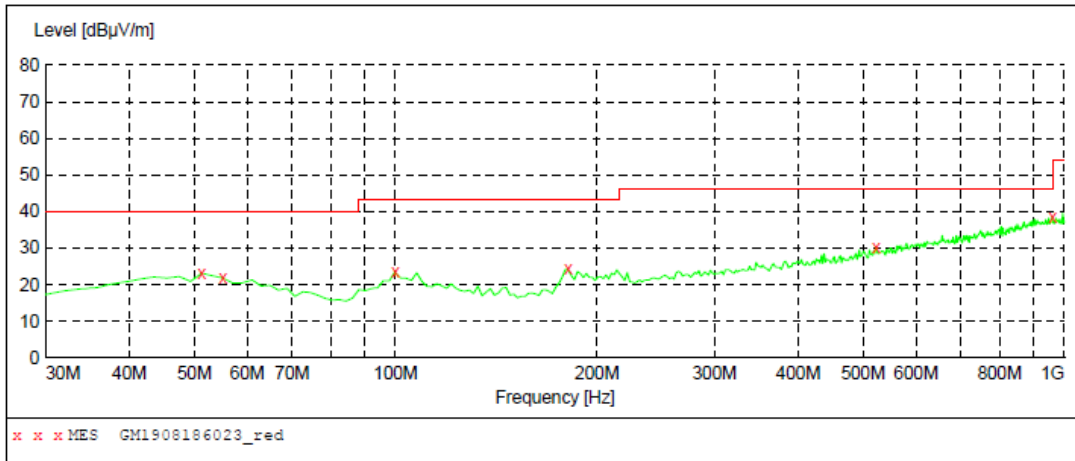

MEASUREMENT RESULT: "GM1908186023_red"

8/18/2019 11:14AM

Frequency MHz	Level dBµV/m	Transd dB	Limit dBµV/m	Margin dB	Det.	Height cm	Azimuth deg	Polarization
51.340000	23.20	-4.9	40.0	16.8	QP	100.0	130.00	HORIZONTAL
55.220000	21.90	-5.3	40.0	18.1	QP	100.0	281.00	HORIZONTAL
99.840000	23.50	-6.7	43.5	20.0	QP	300.0	174.00	HORIZONTAL
181.320000	24.20	-8.3	43.5	19.3	QP	100.0	118.00	HORIZONTAL
522.760000	30.30	2.5	46.0	15.7	QP	100.0	270.00	HORIZONTAL
959.260000	38.40	10.9	46.0	7.6	QP	300.0	150.00	HORIZONTAL

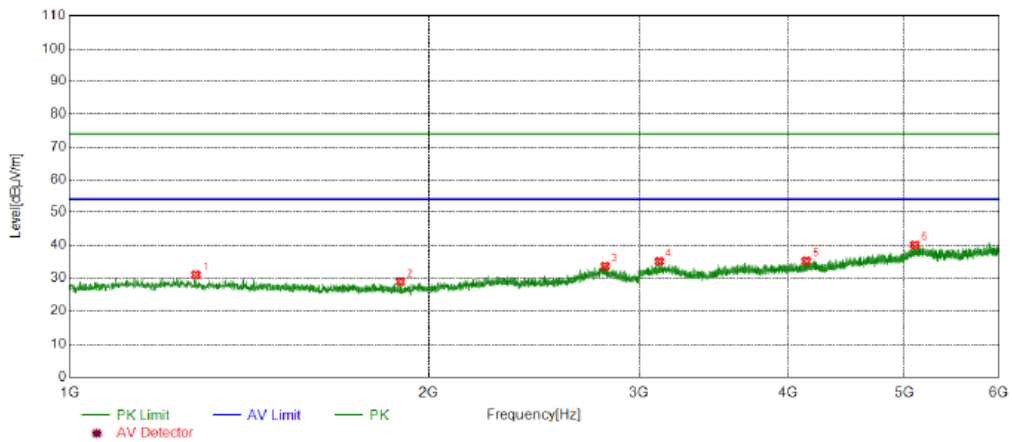

Suspected Data List

NO.	Freq. [MHz]	Reading [dBµV/m]	Factor [dB]	Level [dBµV/m]	Limit [dBµV/m]	Margin [dB]	Polarity	Detector
1	1276.250	36.50	-5.63	30.87	74.00	43.13	Horizontal	PK
2	1893.125	34.62	-5.83	28.79	74.00	45.21	Horizontal	PK
3	2808.125	31.58	1.96	33.54	74.00	40.46	Horizontal	PK
4	3118.750	34.56	0.42	34.98	74.00	39.02	Horizontal	PK
5	4141.250	31.61	3.49	35.10	74.00	38.90	Horizontal	PK
6	5104.375	31.18	8.81	39.99	74.00	34.01	Horizontal	PK

Polarity: Vertical

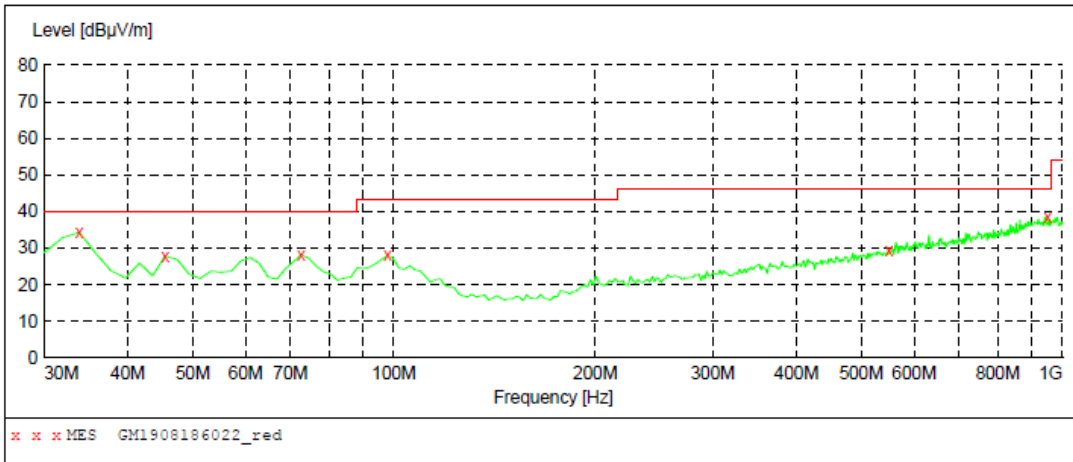

MEASUREMENT RESULT: "GM1908186022_red"

8/18/2019 11:09AM

Frequency MHz	Level dBµV/m	Transd dB	Limit dBµV/m	Margin dB	Det.	Height cm	Azimuth deg	Polarization
33.880000	34.30	-8.7	40.0	5.7	QP	100.0	129.00	VERTICAL
45.520000	27.90	-4.9	40.0	12.1	QP	100.0	350.00	VERTICAL
72.680000	28.20	-10.2	40.0	11.8	QP	100.0	157.00	VERTICAL
97.900000	28.00	-6.9	43.5	15.5	QP	100.0	88.00	VERTICAL
549.920000	29.60	3.0	46.0	16.4	QP	100.0	251.00	VERTICAL
949.560000	38.50	10.8	46.0	7.5	QP	100.0	170.00	VERTICAL

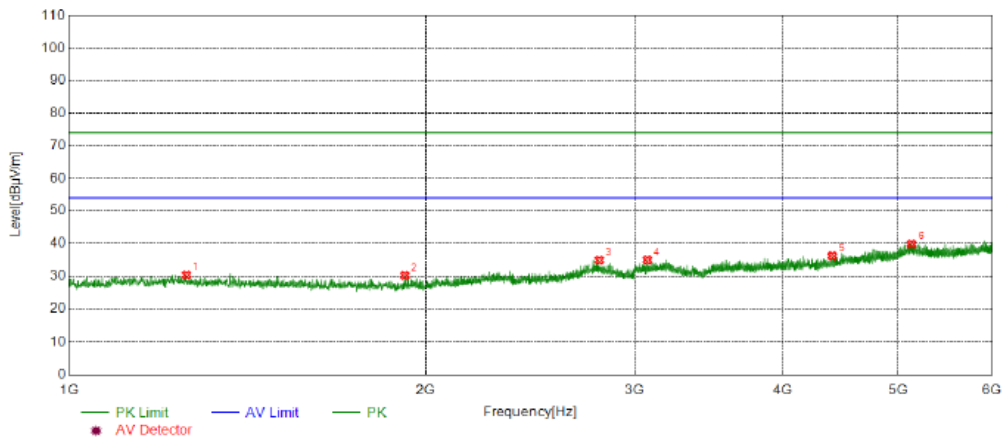

Suspected Data List								
NO.	Freq. [MHz]	Reading [dBµV/m]	Factor [dB]	Level [dBµV/m]	Limit [dBµV/m]	Margin [dB]	Polarity	Detector
1	1256.250	35.98	-5.68	30.30	74.00	43.70	Vertical	PK
2	1920.000	35.75	-5.60	30.15	74.00	43.85	Vertical	PK
3	2800.000	32.78	2.09	34.87	74.00	39.13	Vertical	PK
4	3074.375	34.72	0.21	34.93	74.00	39.07	Vertical	PK
5	4403.750	31.20	4.94	36.14	74.00	37.86	Vertical	PK
6	5133.750	30.96	8.86	39.82	74.00	34.18	Vertical	PK

6 TEST SETUP PHOTOS OF THE EUT

Transmitter Radiated Spurious Emission:



Frequency Stability:



AC Power Line Conducted Emission:

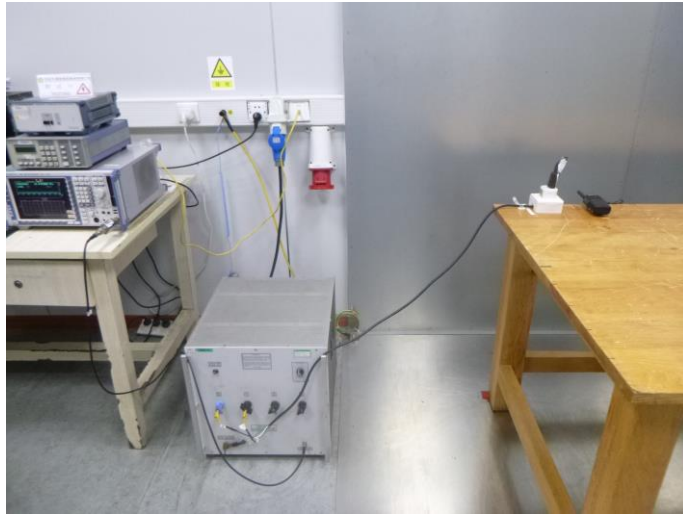

Radiated Emission:



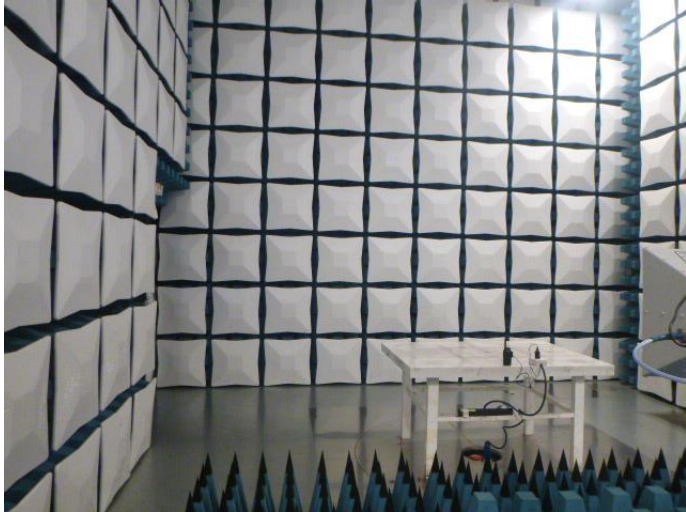

7 EXTERNAL AND INTERNAL PHOTOS OF THE EUT

External Photos of the EUT

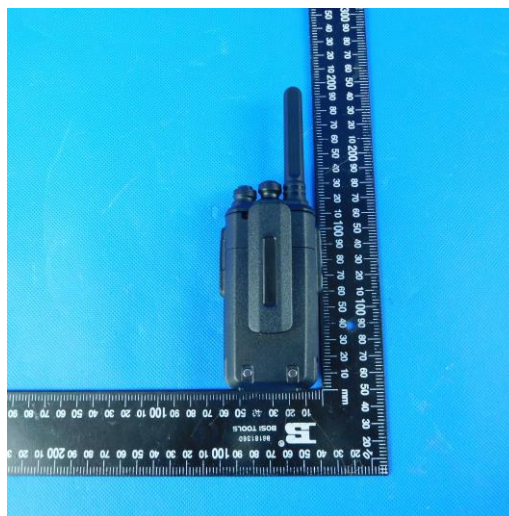

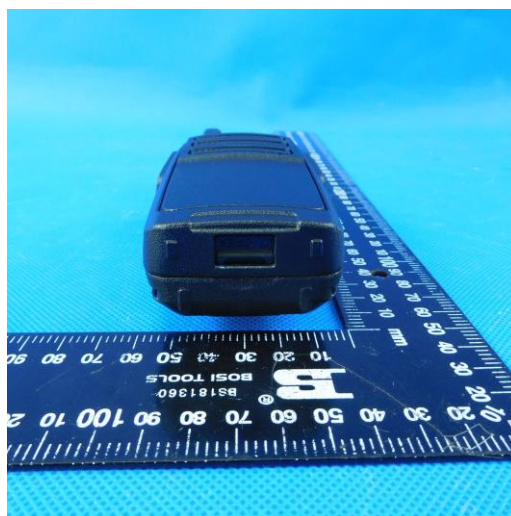



Internal Photos of the EUT



RF Antenna

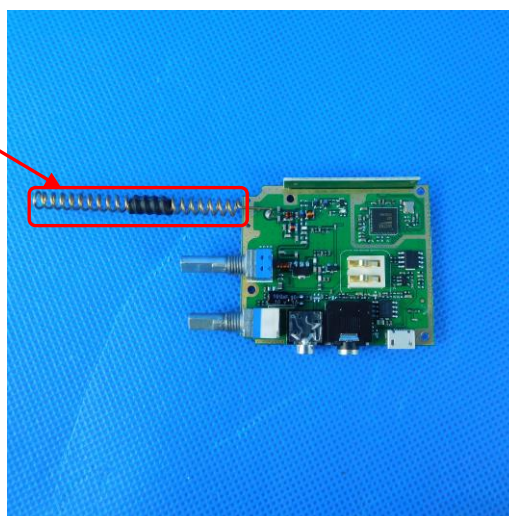

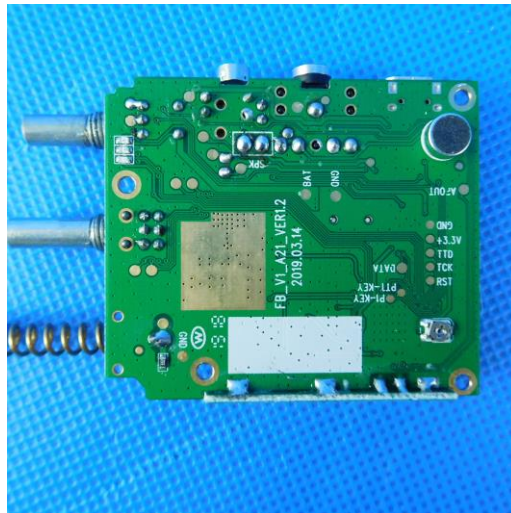
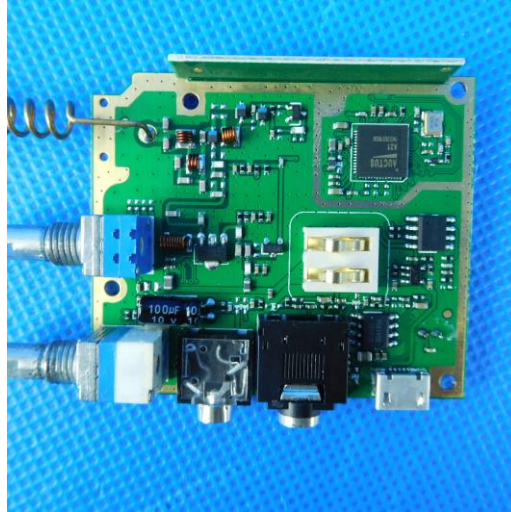

8 APPENDIX REPORT



Appendix A: Carrier Output Power(ERP)

Test Mode	Modulation Type	Test Channel	Measured power (dBm)	Measured power (W)	Limit(W)	Result
TX-FRS	FM	CH _{M1}	32.76	1.89	≤2	PASS
TX-FRS	FM	CH _{M2}	32.72	1.87	≤2	PASS



Appendix B: 99% Occupied Bandwidth & 26dB Bandwidth

Test Mode	Modulation Type	Test Channel	Occupied Bandwidth		99% Limit(kHz)	Result
			99%(kHz)	26dB(kHz)		
TX-FRS	FM	CH _{M1}	<u>10.028</u>	10.23	≤12.5	PASS
TX-FRS	FM	CH _{M2}	10.024	10.24	≤12.5	PASS

Appendix B: 99% Occupied Bandwidth & 26dB Bandwidth



Appendix B: 99% Occupied Bandwidth & 26dB Bandwidth

Test Mode	Modulation Type	Test Channel	TEST PLOT RESULT
TX-FRS	FM	CH _{M1}	<p>Agilent Spectrum Analyzer - Occupied BW</p> <p>Center Freq 462.637500 MHz</p> <p>Ref 36.22 dBm</p> <p>Occupied Bandwidth: 10.028 kHz</p> <p>Total Power: 33.7 dBm</p> <p>Transmit Freq Error: -2.215 kHz</p> <p>OBW Power: 99.00 %</p> <p>x dB Bandwidth: 10.23 kHz</p> <p>x dB: -26.00 dB</p>
TX-FRS	FM	CH _{M2}	<p>Agilent Spectrum Analyzer - Occupied BW</p> <p>Center Freq 462.650000 MHz</p> <p>Ref 36.31 dBm</p> <p>Occupied Bandwidth: 10.024 kHz</p> <p>Total Power: 33.1 dBm</p> <p>Transmit Freq Error: -2.728 kHz</p> <p>OBW Power: 99.00 %</p> <p>x dB Bandwidth: 10.21 kHz</p> <p>x dB: -26.00 dB</p>

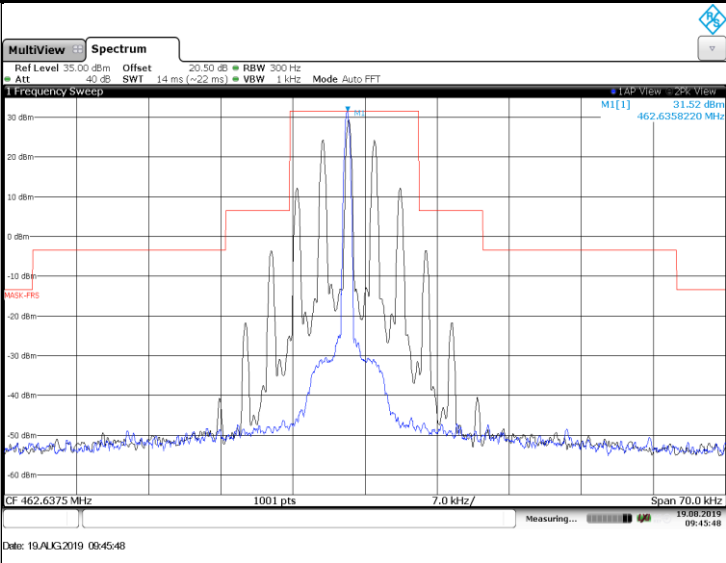
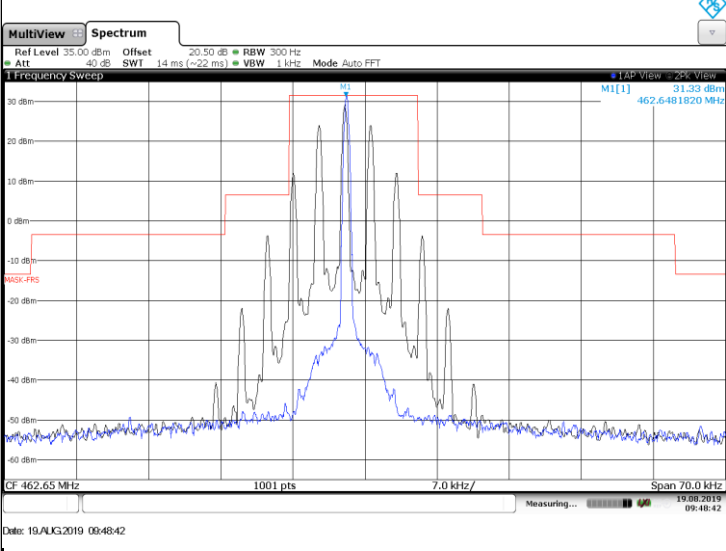

Appendix C:Emission Mask

Test Mode	Modulation Type	Test Channel	TEST PLOT RESULT
TX-FRS	FM	CH _{M1}	
TX-FRS	FM	CH _{M2}	

**Appendix D:Modulation Limit**

Test Mode	Modulation Type	Test Channel	Modulation Level (dB)	Peak Frequency Deviation (Hz)				Limit (kHz)	Result
				300	1004	1500	2500		
TX-FRS	FM	CH _{M1}	-20	0.079	0.182	0.247	0.344	2.5	PASS
TX-FRS	FM	CH _{M1}	-15	0.11	0.304	0.416	0.592	2.5	PASS
TX-FRS	FM	CH _{M1}	-10	0.149	0.504	0.711	1.035	2.5	PASS
TX-FRS	FM	CH _{M1}	-5	0.243	0.88	1.232	1.882	2.5	PASS
TX-FRS	FM	CH _{M1}	0	0.409	1.532	2.079	2.399	2.5	PASS
TX-FRS	FM	CH _{M1}	5	0.61	2.093	2.327	2.428	2.5	PASS
TX-FRS	FM	CH _{M1}	10	0.769	2.216	2.401	2.468	2.5	PASS
TX-FRS	FM	CH _{M1}	15	0.915	2.338	2.43	2.471	2.5	PASS
TX-FRS	FM	CH _{M1}	20	1.08	2.437	2.445	2.486	2.5	PASS
TX-FRS	FM	CH _{M2}	-20	0.073	0.189	0.25	0.349	2.5	PASS
TX-FRS	FM	CH _{M2}	-15	0.101	0.298	0.412	0.584	2.5	PASS
TX-FRS	FM	CH _{M2}	-10	0.154	0.51	0.699	1.042	2.5	PASS
TX-FRS	FM	CH _{M2}	-5	0.24	0.872	1.232	1.906	2.5	PASS
TX-FRS	FM	CH _{M2}	0	0.413	1.543	2.086	2.295	2.5	PASS
TX-FRS	FM	CH _{M2}	5	0.607	2.082	2.312	2.428	2.5	PASS
TX-FRS	FM	CH _{M2}	10	0.759	2.205	2.381	2.442	2.5	PASS
TX-FRS	FM	CH _{M2}	15	0.899	2.324	2.411	2.462	2.5	PASS
TX-FRS	FM	CH _{M2}	20	1.099	2.436	2.431	2.473	2.5	PASS



Appendix D:Modulation Limit

Test Mode	Modulation Type	Test Channel	TEST PLOT RESULT
TX-FRS	FM	CH _{M1}	
TX-FRS	FM	CH _{M2}	

Peak Deviation

Modulation Level (dB)

**Appendix E:Aduio Frequency Response**

Test Mode	Modulation Type	Test Channel	Frequency (Hz)	Audio Frequency Response (dB)	Lower Limit	Upper Limit	Result
TX-FRS	FM	CH _{M1}	100	-33.36	-	-	PASS
TX-FRS	FM	CH _{M1}	200	-33.31	-	-	PASS
TX-FRS	FM	CH _{M1}	300	-11.89	-17.84	-9.42	PASS
TX-FRS	FM	CH _{M1}	400	-8.03	-12.86	-6.93	PASS
TX-FRS	FM	CH _{M1}	500	-6.01	-9.00	-5.00	PASS
TX-FRS	FM	CH _{M1}	600	-4.19	-7.42	-3.42	PASS
TX-FRS	FM	CH _{M1}	700	-2.90	-6.09	-2.09	PASS
TX-FRS	FM	CH _{M1}	800	-1.76	-4.93	-0.93	PASS
TX-FRS	FM	CH _{M1}	900	-0.80	-3.91	0.09	PASS
TX-FRS	FM	CH _{M1}	1000	0.05	-3.00	1.00	PASS
TX-FRS	FM	CH _{M1}	1200	1.46	-1.42	2.58	PASS
TX-FRS	FM	CH _{M1}	1400	2.61	-0.09	3.91	PASS
TX-FRS	FM	CH _{M1}	1600	3.57	1.07	5.07	PASS
TX-FRS	FM	CH _{M1}	1800	4.36	2.09	6.09	PASS
TX-FRS	FM	CH _{M1}	2000	5.03	3.00	7.00	PASS
TX-FRS	FM	CH _{M1}	2100	5.32	3.42	7.42	PASS
TX-FRS	FM	CH _{M1}	2200	5.59	3.83	7.83	PASS
TX-FRS	FM	CH _{M1}	2300	5.84	4.21	8.21	PASS
TX-FRS	FM	CH _{M1}	2400	6.05	4.58	8.58	PASS
TX-FRS	FM	CH _{M1}	2500	6.26	4.93	8.93	PASS
TX-FRS	FM	CH _{M1}	2600	6.45	4.59	9.27	PASS
TX-FRS	FM	CH _{M1}	2700	6.61	4.27	9.60	PASS
TX-FRS	FM	CH _{M1}	2800	6.72	3.95	9.91	PASS
TX-FRS	FM	CH _{M1}	2900	6.79	3.65	10.22	PASS
TX-FRS	FM	CH _{M1}	3000	6.80	3.35	10.51	PASS
TX-FRS	FM	CH _{M1}	3500	4.50	-	-	PASS
TX-FRS	FM	CH _{M1}	4000	-2.47	-	-	PASS
TX-FRS	FM	CH _{M1}	4500	-10.71	-	-	PASS
TX-FRS	FM	CH _{M1}	5000	-18.69	-	-	PASS
TX-FRS	FM	CH _{M2}	100	-33.52	-	-	PASS
TX-FRS	FM	CH _{M2}	200	-33.48	-	-	PASS
TX-FRS	FM	CH _{M2}	300	-12.02	-17.84	-9.42	PASS
TX-FRS	FM	CH _{M2}	400	-8.04	-12.86	-6.93	PASS
TX-FRS	FM	CH _{M2}	500	-6.07	-9.00	-5.00	PASS
TX-FRS	FM	CH _{M2}	600	-4.27	-7.42	-3.42	PASS
TX-FRS	FM	CH _{M2}	700	-2.94	-6.09	-2.09	PASS
TX-FRS	FM	CH _{M2}	800	-1.81	-4.93	-0.93	PASS
TX-FRS	FM	CH _{M2}	900	-0.86	-3.91	0.09	PASS
TX-FRS	FM	CH _{M2}	1000	-0.01	-3.00	1.00	PASS
TX-FRS	FM	CH _{M2}	1200	1.43	-1.42	2.58	PASS
TX-FRS	FM	CH _{M2}	1400	2.59	-0.09	3.91	PASS
TX-FRS	FM	CH _{M2}	1600	3.55	1.07	5.07	PASS

**Appendix E:Audio Frequency Response**

Test Mode	Modulation Type	Test Channel	Frequency (Hz)	Audio Frequency Response (dB)	Lower Limit	Upper Limit	Result
TX-FRS	FM	CH _{M2}	1800	4.35	2.09	6.09	PASS
TX-FRS	FM	CH _{M2}	2000	5.01	3.00	7.00	PASS
TX-FRS	FM	CH _{M2}	2100	5.31	3.42	7.42	PASS
TX-FRS	FM	CH _{M2}	2200	5.58	3.83	7.83	PASS
TX-FRS	FM	CH _{M2}	2300	5.82	4.21	8.21	PASS
TX-FRS	FM	CH _{M2}	2400	6.04	4.58	8.58	PASS
TX-FRS	FM	CH _{M2}	2500	6.25	4.93	8.93	PASS
TX-FRS	FM	CH _{M2}	2600	6.44	4.59	9.27	PASS
TX-FRS	FM	CH _{M2}	2700	6.59	4.27	9.60	PASS
TX-FRS	FM	CH _{M2}	2800	6.71	3.95	9.91	PASS
TX-FRS	FM	CH _{M2}	2900	6.80	3.65	10.22	PASS
TX-FRS	FM	CH _{M2}	3000	6.80	3.35	10.51	PASS
TX-FRS	FM	CH _{M2}	3500	4.50	-	-	PASS
TX-FRS	FM	CH _{M2}	4000	-2.50	-	-	PASS
TX-FRS	FM	CH _{M2}	4500	-10.84	-	-	PASS
TX-FRS	FM	CH _{M2}	5000	-18.92	-	-	PASS



Appendix E:Audio Frequency Response

Test Mode	Modulation Type	Test Channel	TEST PLOT RESULT
TX-FRS	FM	CH _{M1}	<p>RESPONSE ATTENUATION (dB)</p> <p>FREQUENCY (Hz)</p> <p>Legend: Audio Frequency Response (dB), Upper Limit</p>
TX-FRS	FM	CH _{M2}	<p>RESPONSE ATTENUATION (dB)</p> <p>FREQUENCY (Hz)</p> <p>Legend: Audio Frequency Response (dB), Upper Limit</p>
TX-FRS	FM	CH _{M3}	

Note: The highest audio frequency response at 3kHz<3.125kHz, so meet the requirement.

**Appendix F:Frequency Stability Test & Temperature**

Test Mode	Modulation Type	Test Conditions		Frequency error (ppm)		Limit (ppm)	Result
		Voltage	Temperature	CH _{M1}	CH _{M2}		
TX-FRS	FM	V _N	-30	-0.357	<u>0.399</u>	±2.5	PASS
TX-FRS	FM	V _N	-20	-0.345	0.391	±2.5	PASS
TX-FRS	FM	V _N	-10	-0.336	0.382	±2.5	PASS
TX-FRS	FM	V _N	0	-0.325	0.359	±2.5	PASS
TX-FRS	FM	V _N	10	-0.316	0.365	±2.5	PASS
TX-FRS	FM	V _N	20	-0.305	0.352	±2.5	PASS
TX-FRS	FM	V _N	30	-0.317	0.363	±2.5	PASS
TX-FRS	FM	V _N	40	-0.325	0.372	±2.5	PASS
TX-FRS	FM	V _N	55	-0.336	0.380	±2.5	PASS

**Appendix G:Frequency Stability Test & Voltage**

Test Mode	Modulation Type	Test Conditions		Frequency error (ppm)		Limit (ppm)	Result
		Voltage	Temperature	CH _{M1}	CH _{M2}		
TX-FRS	FM	V _N	T _N	-0.305	0.352	±2.5	PASS
TX-FRS	FM	V _L	T _N	-0.311	0.358	±2.5	PASS
TX-FRS	FM	V _H	T _N	-0.320	0.360	±2.5	PASS

----End of Report----