



TEST REPORT

Report No. : CHTEW20110054

Report verification: 

Project No..... : SHT2011041301EW

FCC ID..... : 2ASNSH777

Applicant's name : Shenzhen Retevis Technology Co., Ltd.

Address..... : Room 700, 7/F, 13-C, Zhonghaixin Science&Technology Park, No.12 Ganli 6th Road, Jihua Street, Longgang District, Shenzhen, China

Test item description : Two Way Radio

Trade Mark : RETEVIS

Model/Type reference..... : H777

Listed Model(s) : -

Standard : FCC 47 CFR Part2.1093
IEEE Std C95.1, 1999 Edition
IEEE 1528: 2013

Date of receipt of test sample..... : NOV.09, 2020

Date of testing..... : NOV.10, 2020- NOV.11, 2020

Date of issue..... : NOV.11, 2020

Result..... : PASS

Compiled by
(position+printed name+signature)..: File administrators: Fanghui Zhu 

Supervised by
(position+printed name+signature)..: Test Engineer: Patrick Qiu 

Approved by
(position+printed name+signature)..: Manager: Hans Hu 

Testing Laboratory Name : Shenzhen Huatongwei International Inspection Co., Ltd

Address..... : 1/F, Bldg 3, Hongfa Hi-tech Industrial Park, Genyu Road, Tianliao, Gongming, Shenzhen, China

Shenzhen Huatongwei International Inspection Co., Ltd. All rights reserved.

This publication may be reproduced in whole or in part for non-commercial purposes as long as the Shenzhen Huatongwei International Inspection Co., Ltd is acknowledged as copyright owner and source of the material. Shenzhen Huatongwei International Inspection Co., Ltd takes no responsibility for and will not assume liability for damages resulting from the reader's interpretation of the reproduced material due to its placement and context.

The test report merely correspond to the test sample.

Contents

<u>1.</u>	<u>Statement of Compliance</u>	<u>3</u>
<u>2.</u>	<u>Test Standards and Report version</u>	<u>4</u>
2.1.	Test Standards	4
2.2.	Report version	4
<u>3.</u>	<u>Summary</u>	<u>5</u>
3.1.	Client Information	5
3.2.	Product Description	5
3.3.	Radio Specification Description	5
3.4.	Test frequency list	6
3.5.	Testing Laboratory Information	6
3.6.	Environmental conditions	6
<u>4.</u>	<u>Equipments Used during the Test</u>	<u>7</u>
<u>5.</u>	<u>Measurement Uncertainty</u>	<u>8</u>
<u>6.</u>	<u>SAR Measurements System Configuration</u>	<u>9</u>
6.1.	SAR Measurement Set-up	9
6.2.	DASY5 E-field Probe System	10
6.3.	Phantoms	11
6.4.	Device Holder	11
<u>7.</u>	<u>SAR Test Procedure</u>	<u>12</u>
7.1.	Scanning Procedure	12
7.2.	Data Storage and Evaluation	14
<u>8.</u>	<u>Position of the wireless device in relation to the phantom</u>	<u>16</u>
8.1.	Front-of-face	16
8.2.	Body Position	16
<u>9.</u>	<u>Dielectric Property Measurements & System Check</u>	<u>17</u>
9.1.	Tissue Dielectric Parameters	17
9.2.	SAR System Validation	18
9.3.	System Check	19
<u>10.</u>	<u>SAR Exposure Limits</u>	<u>22</u>
<u>11.</u>	<u>Radiated Power Measurement Results</u>	<u>22</u>
<u>12.</u>	<u>Maximum Tune-up Limit</u>	<u>22</u>
<u>13.</u>	<u>SAR Measurement Results</u>	<u>23</u>
<u>14.</u>	<u>Test Setup Photos</u>	<u>24</u>
<u>15.</u>	<u>External and Internal Photos of the EUT</u>	<u>24</u>

1. Statement of Compliance

Maximum Reported SAR (W/kg @1g)	
RF Exposure Conditions	FRF
Head(Dist.= 25mm)	0.452
Body-worn(Dist.= 0mm)	1.250

This device is in compliance with Specific Absorption Rate (SAR) for general population/uncontrolled exposure limits (1.6 W/kg) specified in FCC 47 CFR part 2 (2.1093) and ANSI/IEEE C95.1-1992, and had been tested in accordance with the measurement methods and procedures specified in IEEE 1528-2013 and FCC KDB publications.

2. Test Standards and Report version

2.1. Test Standards

The tests were performed according to following standards:

[FCC 47 Part 2.1093](#): Radiofrequency Radiation Exposure Evaluation:Portable Devices

[IEEE Std C95.1, 1999 Edition](#): IEEE Standard for Safety Levels with Respect to Human Exposure to Radio Frequency Electromagnetic Fields, 3 kHz to 300 GHz

[IEEE Std 1528™-2013](#): IEEE Recommended Practice for Determining the Peak Spatial-Average Specific Absorption Rate (SAR) in the Human Head from Wireless Communications Devices: Measurement Techniques.

FCC published RF exposure KDB procedures:

[KDB 865664 D01 SAR Measurement 100 MHz to 6 GHz v01r04](#): SAR Measurement Requirements for 100 MHz to 6 GHz

[KDB 865664 D02 RF Exposure Reporting v01r02](#): RF Exposure Compliance Reporting and Documentation Considerations

[KDB 447498 D01 General RF Exposure Guidance v06](#): Mobile and Portable Device RF Exposure Procedures and Equipment Authorization Policies

[TCB workshop](#): April, 2019; Page 19, Tissue Simulating Liquids (TSL)

2.2. Report version

Revision No.	Date of issue	Description
N/A	2020-11-11	Original

3. Summary

3.1. Client Information

Applicant:	Shenzhen Retevis Technology Co., Ltd.
Address:	Room 700, 7/F, 13-C, Zhonghaixin Science&Technology Park, No.12 Ganli 6th Road, Jihua Street, Longgang District, Shenzhen, China
Manufacturer:	Shenzhen Retevis Technology Co., Ltd.
Address:	Room 700, 7/F, 13-C, Zhonghaixin Science&Technology Park, No.12 Ganli 6th Road, Jihua Street, Longgang District, Shenzhen, China

3.2. Product Description

Main unit	
Name of EUT:	Two Way Radio
Trade mark:	RETEVIS
Model/Type reference:	H777
Listed model(s):	-
Device Category:	Portable
RF Exposure Environment:	General Population/Uncontrolled
Power supply:	DC 3.7 V from Battery
Hardware version:	BF-889-A21_V1.3
Software version:	1.0.1
Device Dimension:	Overall (Length x Width x Thickness): 103x56x33mm Antenna(Length): 65mm

3.3. Radio Specification Description

Operation Frequency Range:	462.5500-462.7250MHz	
Rated Output Power:	<input checked="" type="checkbox"/> High Power: 2W	<input checked="" type="checkbox"/> Low Power: 0.5W
Modulation Type:	FM(Analog)	
Channel Bandwidth:	12.5kHz	
Antenna Type:	Integral	
Remark:	<p>1. The EUT battery must be fully charged and checked periodically during the test to ascertain uniform power.</p> <p>2. EUT supports VOX functionality.</p>	

3.4. Test frequency list

When the frequency channels required for SAR testing are not specified in the published RF exposure KDB procedures, the following should be applied to determine the number of required test channels. The test channels should be evenly spread across the transmission frequency band of each wireless mode:

$$N_c = \text{Round}\left\{\left[100\left(f_{\text{high}} - f_{\text{low}}\right) / f_c\right]^{0.5} \times \left(f_c / 100\right)^{0.2}\right\},$$

N_c is the number of test channels, rounded to the nearest integer,
 f_{high} and f_{low} are the highest and lowest channel frequencies within the transmission band,
 f_c is the mid-band channel frequency,
 all frequencies are in MHz.

Modulation Type	Channel Bandwidth	Test Channel	Test Frequency(MHz)
			TX
Analog	12.5kHz	CH4	462.6375

3.5. Testing Laboratory Information

Laboratory Name	Shenzhen Huatongwei International Inspection Co., Ltd.		
Laboratory Location	1/F, Bldg 3, Hongfa Hi-tech Industrial Park, Genyu Road, Tianliao, Gongming, Shenzhen, China		
Qualifications	Type	Accreditation Number	
	CNAS	L1225	
	A2LA	3902.01	
	FCC	762235	
	Canada	5377A	

3.6. Environmental conditions

During the measurement the environmental conditions were within the listed ranges:

Ambient temperature	18 °C to 25 °C
Ambient humidity	30%RH to 70%RH
Air Pressure	950-1050mbar

4. Equipments Used during the Test

Used	Test Equipment	Manufacturer	Model No.	Serial No.	Cal. date (YY-MM-DD)	Due date (YY-MM-DD)
●	Data Acquisition Electronics DAEx	SPEAG	DAE4	1549	2020/04/04	2021/04/03
●	E-field Probe	SPEAG	EX3DV4	3842	2020/01/30	2021/01/29
○	Universal Radio Communication Tester	R&S	CMW500	137681	2020/06/18	2021/06/17
● Tissue-equivalent liquids Validation						
●	Dielectric Assessment Kit	SPEAG	DAK-3.5	1267	N/A	N/A
○	Dielectric Assessment Kit	SPEAG	DAK-12	1130	N/A	N/A
●	Network analyzer	Keysight	E5071C	MY46733048	2020/10/15	2021/10/14
● System Validation						
○	System Validation Antenna	SPEAG	CLA-150	4024	2018/02/21	2021/02/20
●	System Validation Dipole	SPEAG	D450V3	1102	2018/02/23	2021/02/22
○	System Validation Dipole	SPEAG	D750V3	1180	2018/02/07	2021/02/06
○	System Validation Dipole	SPEAG	D835V2	4d238	2018/02/19	2021/02/18
○	System Validation Dipole	SPEAG	D1750V2	1164	2018/02/06	2021/02/05
○	System Validation Dipole	SPEAG	D1900V2	5d226	2018/02/22	2021/02/21
○	System Validation Dipole	SPEAG	D2450V2	1009	2018/02/05	2021/02/04
○	System Validation Dipole	SPEAG	D2600V2	1150	2018/02/05	2021/02/04
○	System Validation Dipole	SPEAG	D5GHzV2	1273	2018/02/21	2021/02/20
●	Signal Generator	R&S	SMB100A	114360	2020/08/11	2021/08/10
●	Power Viewer for Windows	R&S	N/A	N/A	N/A	N/A
●	Power sensor	R&S	NRP18A	101010	2020/08/11	2021/08/10
●	Power sensor	R&S	NRP18A	101386	2020/06/08	2021/06/07
●	Power Amplifier	BONN	BLWA 0160-2M	1811887	2019/11/14	2020/11/13
●	Dual Directional Coupler	Mini-Circuits	ZHDC-10-62-S+	F975001814	2019/11/14	2020/11/13
●	Attenuator	Mini-Circuits	VAT-3W2+	1819	2019/11/14	2020/11/13
●	Attenuator	Mini-Circuits	VAT-10W2+	1741	2019/11/14	2020/11/13

Note:

1. The Probe, Dipole and DAE calibration reference to the Appendix B and C.
2. Referring to KDB865664 D01, the dipole calibration interval can be extended to 3 years with justification. The dipole are also not physically damaged or repaired during the interval.

5. Measurement Uncertainty

Per KDB 865664 D01 SAR Measurement 100 MHz to 6 GHz, when the highest measured 1-g SAR within a frequency band is < 1.5 W/kg. The expanded SAR measurement uncertainty must be $\leq 30\%$, for a confidence interval of $k = 2$. If these conditions are met, extensive SAR measurement uncertainty analysis described in IEEE Std 1528-2013 is not required in SAR reports submitted for equipment approval.

Therefore, the measurement uncertainty is not required.

6. SAR Measurements System Configuration

6.1. SAR Measurement Set-up

The DASY5 system for performing compliance tests consists of the following items:

A standard high precision 6-axis robot (Stäubli RX family) with controller and software. An arm extension for accommodating the data acquisition electronics (DAE).

A dosimetric probe, i.e. an isotropic E-field probe optimized and calibrated for usage in tissue simulating liquid. The probe is equipped with an optical surface detector system.

A data acquisition electronic (DAE) which performs the signal amplification, signal multiplexing, AD-conversion, offset measurements, mechanical surface detection, collision detection, etc. The unit is battery powered with standard or rechargeable batteries. The signal is optically transmitted to the EOC.

A unit to operate the optical surface detector which is connected to the EOC.

The Electro-Optical Coupler (EOC) performs the conversion from the optical into a digital electric signal of the DAE. The EOC is connected to the DASY5 measurement server.

The DASY5 measurement server, which performs all real-time data evaluation for field measurements and surface detection, controls robot movements and handles safety operation. A computer operating Windows 2003.

DASY5 software and SEMCAD data evaluation software.

Remote control with teach panel and additional circuitry for robot safety such as warning lamps, etc.

The generic twin phantom enabling the testing of left-hand and right-hand usage.

The device holder for handheld Mobile Phones.

Tissue simulating liquid mixed according to the given recipes.

System validation dipoles allowing to validate the proper functioning of the system.

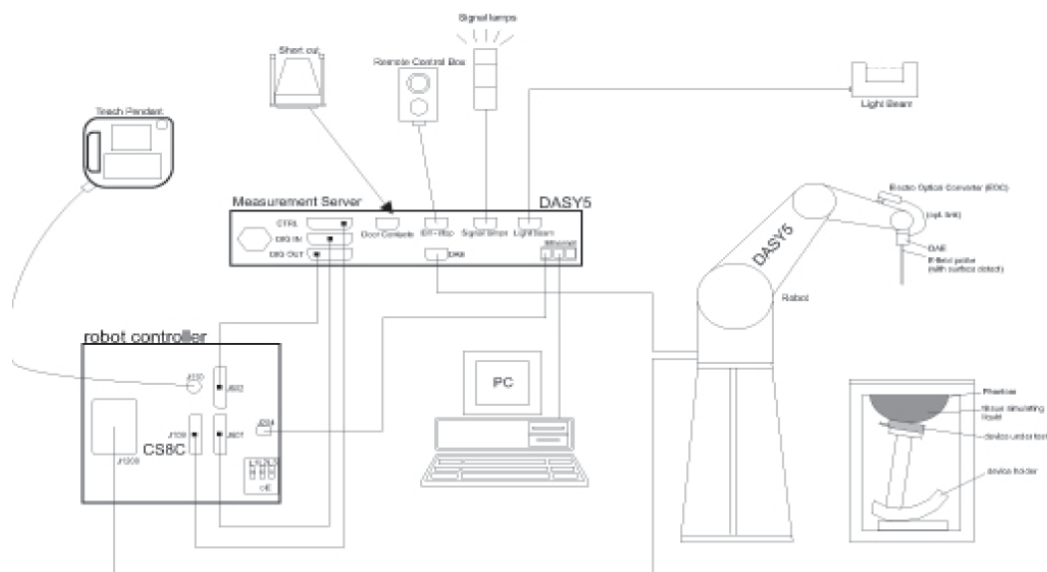

6.2. DASY5 E-field Probe System

The SAR measurements were conducted with the dosimetric probe EX3DV4 (manufactured by SPEAG), designed in the classical triangular configuration and optimized for dosimetric evaluation.

● Probe Specification

Construction Symmetrical design with triangular core
 Interleaved sensors
 Built-in shielding against static charges
 PEEK enclosure material (resistant to organic solvents, e.g., DGBE)

Calibration ISO/IEC 17025 calibration service available.

Frequency	10 MHz to 10 GHz; Linearity: ± 0.2 dB (30 MHz to 10 GHz)
Directivity	± 0.1 dB in TSL (rotation around probe axis) ± 0.3 dB in TSL (rotation normal to probe axis)
Dynamic Range	10 μ W/g to > 100 mW/g; Linearity: ± 0.2 dB
Dimensions	Overall length: 337 mm (Tip: 20 mm) Tip diameter: 2.5 mm (Body: 12 mm) Distance from probe tip to dipole centers: 2.0 mm
Application	General dosimetry up to 10 GHz Dosimetry in strong gradient fields Compliance tests of Mobile Phones
Compatibility	DASY3, DASY4, DASY52 SAR and higher, EASY4/MRI



● Isotropic E-Field Probe

The isotropic E-Field probe has been fully calibrated and assessed for isotropicity, and boundary effect within a controlled environment. Depending on the frequency for which the probe is calibrated the method utilized for calibration will change.

The E-Field probe utilizes a triangular sensor arrangement as detailed in the diagram below:

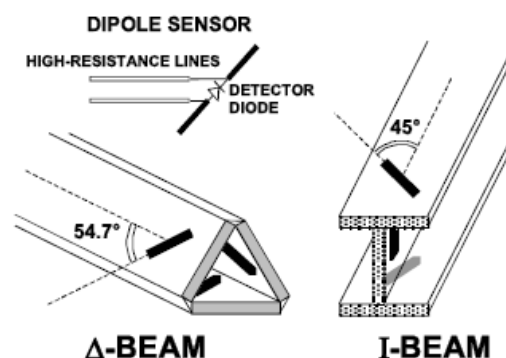

6.3. Phantoms

Phantom for compliance testing of handheld and body-mounted wireless devices in the frequency range of 30 MHz to 6 GHz. ELI is fully compatible with standard and all known tissue-simulating liquids. ELI has been optimized regarding its performance and can be integrated into our standard phantom tables. A cover prevents evaporation of the liquid. Reference markings on the phantom allow installation of the complete setup, including all predefined phantom positions and measurement grids, by teaching three points. The phantom is compatible with all SPEAG dosimetric probes and dipoles.



ELI4 Phantom

6.4. Device Holder

The device was placed in the device holder (illustrated below) that is supplied by SPEAG as an integral part of the DASY system.

The DASY device holder is designed to cope with the different positions given in the standard. It has two scales for device rotation (with respect to the body axis) and device inclination (with respect to the line between the ear reference points). The rotation centers for both scales is the ear reference point (ERP). Thus the device needs no repositioning when changing the angles.



Device holder supplied by SPEAG

7. SAR Test Procedure

7.1. Scanning Procedure

Step 1: Power Reference Measurement

The Power Reference Measurement and Power Drift Measurements are for monitoring the power drift of the device under test in the batch process. Measure the local SAR at a test point within 8 mm of the phantom inner surface that is closest to the DUT. This distance cannot be smaller than the distance of sensor calibration points to probe tip as defined in the probe properties.

Step 2: Area Scan

The Area Scan is used as a fast scan in two dimensions to find the area of high field values, before doing a fine measurement around the hot spot. The sophisticated interpolation routines implemented in DASY software can find the maximum locations even in relatively coarse grids. When an Area Scan has measured all reachable points, it computes the field maximal found in the scanned area, within a range of the global maximum. The range (in dB) is specified in the standards for compliance testing. For example, a 2 dB range is required in IEEE Standard 1528 and IEC 62209 standards, whereby 3 dB is a requirement when compliance is assessed in accordance with the ARIB standard (Japan). If only one Zoom Scan follows the Area Scan, then only the absolute maximum will be taken as reference. For cases where multiple maximums are detected, the number of Zoom Scans has to be increased accordingly.

Area Scan Resolutions per FCC KDB Publication 865664 D01v04

	≤ 3 GHz	> 3 GHz
Maximum distance from closest measurement point (geometric center of probe sensors) to phantom surface	5 mm ± 1 mm	$\frac{1}{2} \cdot \delta \cdot \ln(2)$ mm ± 0.5 mm
Maximum probe angle from probe axis to phantom surface normal at the measurement location	30° ± 1°	20° ± 1°
Maximum area scan spatial resolution: Δx_{Area} , Δy_{Area}	≤ 2 GHz: ≤ 15 mm 2 – 3 GHz: ≤ 12 mm	3 – 4 GHz: ≤ 12 mm 4 – 6 GHz: ≤ 10 mm
	When the x or y dimension of the test device, in the measurement plane orientation, is smaller than the above, the measurement resolution must be ≤ the corresponding x or y dimension of the test device with at least one measurement point on the test device.	

Step 3: Zoom Scan

Zoom Scans are used to assess the peak spatial SAR values within a cubic averaging volume containing 1g and 10g of simulated tissue. The Zoom Scan measures points (refer to table below) within a cube whose base faces are centered on the maxima found in a preceding area scan job within the same procedure. When the measurement is done, the Zoom Scan evaluates the averaged SAR for 1 g and 10 g and displays these values next to the job's label.

Zoom Scan Resolutions per FCC KDB Publication 865664 D01v04

Maximum zoom scan spatial resolution: $\Delta x_{\text{Zoom}}, \Delta y_{\text{Zoom}}$		$\leq 2 \text{ GHz}: \leq 8 \text{ mm}$ $2 - 3 \text{ GHz}: \leq 5 \text{ mm}^*$	$3 - 4 \text{ GHz}: \leq 5 \text{ mm}^*$ $4 - 6 \text{ GHz}: \leq 4 \text{ mm}^*$
Maximum zoom scan spatial resolution, normal to phantom surface	uniform grid: $\Delta z_{\text{Zoom}}(n)$	$\leq 5 \text{ mm}$	$3 - 4 \text{ GHz}: \leq 4 \text{ mm}$ $4 - 5 \text{ GHz}: \leq 3 \text{ mm}$ $5 - 6 \text{ GHz}: \leq 2 \text{ mm}$
	graded grid	$\Delta z_{\text{Zoom}}(1)$: between 1 st two points closest to phantom surface	$\leq 4 \text{ mm}$
		$\Delta z_{\text{Zoom}}(n>1)$: between subsequent points	$\leq 1.5 \cdot \Delta z_{\text{Zoom}}(n-1) \text{ mm}$
Minimum zoom scan volume	x, y, z	$\geq 30 \text{ mm}$	$3 - 4 \text{ GHz}: \geq 28 \text{ mm}$ $4 - 5 \text{ GHz}: \geq 25 \text{ mm}$ $5 - 6 \text{ GHz}: \geq 22 \text{ mm}$
<p>Note: δ is the penetration depth of a plane-wave at normal incidence to the tissue medium; see IEEE Std 1528-2013 for details.</p> <p>* When zoom scan is required and the <i>reported</i> SAR from the <i>area scan based 1-g SAR estimation</i> procedures of KDB Publication 447498 is $\leq 1.4 \text{ W/kg}$, $\leq 8 \text{ mm}$, $\leq 7 \text{ mm}$ and $\leq 5 \text{ mm}$ zoom scan resolution may be applied, respectively, for 2 GHz to 3 GHz, 3 GHz to 4 GHz and 4 GHz to 6 GHz.</p>			

Step 4: Power drift measurement

The Power Drift Measurement measures the field at the same location as the most recent power reference measurement within the same procedure, and with the same settings. The Power Drift Measurement gives the field difference in dB from the reading conducted within the last Power Reference Measurement. This allows a user to monitor the power drift of the device under test within a batch process. The measurement procedure is the same as Step 1. The SAR drift shall be kept within $\pm 5 \%$.

7.2. Data Storage and Evaluation

Data Storage

The DASY5 software stores the acquired data from the data acquisition electronics as raw data (in microvolt readings from the probe sensors), together with all necessary software parameters for the data evaluation (probe calibration data, liquid parameters and device frequency and modulation data) in measurement files with the extension ".DA4". The software evaluates the desired unit and format for output each time the data is visualized or exported. This allows verification of the complete software setup even after the measurement and allows correction of incorrect parameter settings. For example, if a measurement has been performed with a wrong crest factor parameter in the device setup, the parameter can be corrected afterwards and the data can be re-evaluated.

The measured data can be visualized or exported in different units or formats, depending on the selected probe type ([V/m], [A/m], [°C], [mW/g], [mW/cm²], [dBrel], etc.). Some of these units are not available in certain situations or show meaningless results, e.g., a SAR output in a lossless media will always be zero. Raw data can also be exported to perform the evaluation with other software packages.

Data Evaluation

The SEMCAD software automatically executes the following procedures to calculate the field units from the microvolt readings at the probe connector. The parameters used in the evaluation are stored in the configuration modules of the software:

Probe parameters:	Sensitivity:	Normi, ai0, ai1, ai2
	Conversion factor:	ConvFi
	Diode compression point:	Dcpi
Device parameters:	Frequency:	f
	Crest factor:	cf
Media parameters:	Conductivity:	σ
	Density:	ρ

These parameters must be set correctly in the software. They can be found in the component documents or they can be imported into the software from the configuration files issued for the DASY5 components. In the direct measuring mode of the multimeter option, the parameters of the actual system setup are used. In the scan visualization and export modes, the parameters stored in the corresponding document files are used.

The first step of the evaluation is a linearization of the filtered input signal to account for the compression characteristics of the detector diode. The compensation depends on the input signal, the diode type and the DC-transmission factor from the diode to the evaluation electronics. If the exciting field is pulsed, the crest factor of the signal must be known to correctly compensate for peak power. The formula for each channel can be given as:

$$V_i = U_i + U_i^2 \cdot \frac{cf}{dcp_i}$$

Vi:	compensated signal of channel (i = x, y, z)
Ui:	input signal of channel (i = x, y, z)
cf:	crest factor of exciting field (DASY parameter)
dcp _i :	diode compression point (DASY parameter)

From the compensated input signals the primary field data for each channel can be evaluated:

$$E - \text{fieldprobes} : \quad E_i = \sqrt{\frac{V_i}{Norm_i \cdot ConvF}}$$

$$H - \text{fieldprobes} : \quad H_i = \sqrt{V_i} \cdot \frac{a_{i0} + a_{i1}f + a_{i2}f^2}{f}$$

Vi:	compensated signal of channel (i = x, y, z)
Normi:	sensor sensitivity of channel (i = x, y, z), [mV/(V/m) ²] for E-field Probes
ConvF:	sensitivity enhancement in solution
aij:	sensor sensitivity factors for H-field probes
f:	carrier frequency [GHz]
E _i :	electric field strength of channel i in V/m
H _i :	magnetic field strength of channel i in A/m

The RSS value of the field components gives the total field strength (Hermitian magnitude):

$$E_{tot} = \sqrt{E_x^2 + E_y^2 + E_z^2}$$

The primary field data are used to calculate the derived field units.

$$SAR = E_{tot}^2 \cdot \frac{\sigma}{\rho \cdot 1'000}$$

SAR: local specific absorption rate in mW/g
Etot: total field strength in V/m
 σ : conductivity in [mho/m] or [Siemens/m]
 ρ : equivalent tissue density in g/cm³

Note that the density is normally set to 1 (or 1.06), to account for actual brain density rather than the density of the simulation liquid.

8. Position of the wireless device in relation to the phantom

8.1. Front-of-face

A typical example of a front-of-face device is a two-way radio that is held at a distance from the face of the user when transmitting. In these cases the device under test shall be positioned at the distance to the phantom surface that corresponds to the intended use as specified by the manufacturer in the user instructions. If the intended use is not specified, a separation distance of 25 mm between the phantom surface and the device shall be used.

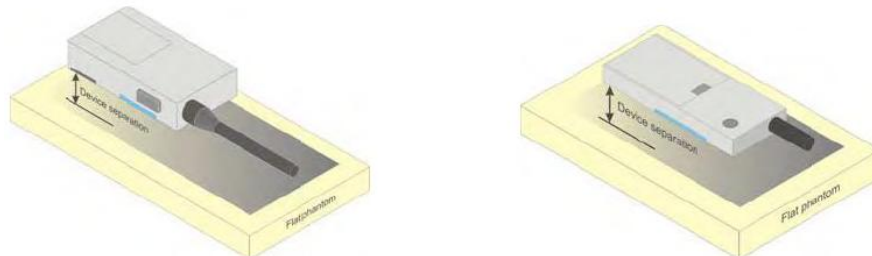

8.2. Body Position

A typical example of a body-worn device is a mobile phone, wireless enabled PDA or other battery operated wireless device with the ability to transmit while mounted on a person's body using a carry accessory approved by the wireless device manufacturer.

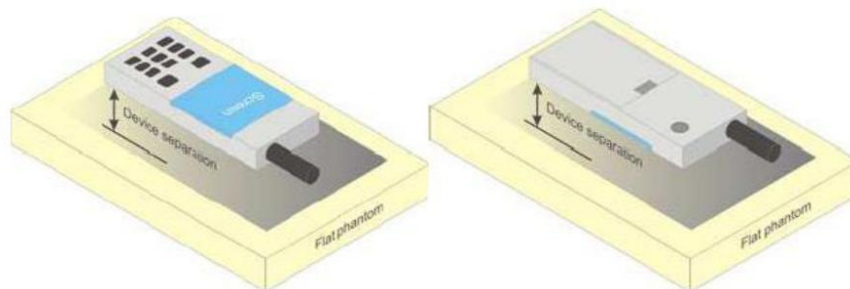

9. Dielectric Property Measurements & System Check

9.1. Tissue Dielectric Parameters

The temperature of the tissue-equivalent medium used during measurement must also be within 18°C to 25°C and within $\pm 2^\circ\text{C}$ of the temperature when the tissue parameters are characterized.

The dielectric parameters must be measured before the tissue-equivalent medium is used in a series of SAR measurements. The parameters should be re-measured after each 3-4 days of use; or earlier if the dielectric parameters can become out of tolerance; for example, when the parameters are marginal at the beginning of the measurement series.

The dielectric constant (ϵ_r) and conductivity (σ) of typical tissue-equivalent media recipes are expected to be within $\pm 5\%$ of the required target values; but for SAR measurement systems that have implemented the SAR error compensation algorithms documented in IEEE Std 1528-2013, to automatically compensate the measured SAR results for deviations between the measured and required tissue dielectric parameters, the tolerance for ϵ_r and σ may be relaxed to $\pm 10\%$. This is limited to frequencies ≤ 3 GHz.

Tissue Dielectric Parameters

FCC KDB 865664 D01 SAR Measurement 100 MHz to 6 GHz

Tissue dielectric parameters for Head and Body				
Target Frequency (MHz)	Head		Body	
	ϵ_r	$\sigma(\text{S/m})$	ϵ_r	$\sigma(\text{S/m})$
450	43.5	0.87	56.7	0.94

IEEE Std 1528-2013

Refer to Table 3 within the IEEE Std 1528-2013

Dielectric Property Measurements Results:

Dielectric performance of Head tissue simulating liquid									
Frequency (MHz)	ϵ_r		$\sigma(\text{S/m})$		Delta (ϵ_r)	Delta (σ)	Limit	Temp ($^\circ\text{C}$)	Date
	Target	Measured	Target	Measured					
450	43.50	42.76	0.870	0.853	-1.70%	-1.94%	$\pm 5\%$	22.7	2020-11-10

9.2. SAR System Validation

Per FCC KDB 865664 D02, SAR system validation status should be documented to confirm measurement accuracy. The SAR systems (including SAR probes, system components and software versions) used for this device were validated against its performance specifications prior to the SAR measurements. Reference dipoles were used with the required tissue-equivalent media for system validation, according to the procedures outlined in FCC KDB 865664 D01 and IEEE 1528-2013. Since SAR probe calibrations are frequency dependent, each probe calibration point, using the system that normally operates with the probe for routine SAR measurements and according to the required tissue-equivalent media.

A tabulated summary of the system validation status including the validation date(s), measurement frequencies, SAR probes and tissue dielectric parameters has been included.

Test Date	Probe S/N	Calibration Point		Dielectric Parameters		CW Validation			Modulation Validation		
				Conductivity	Permittivity	Sensitivity	Probe linearity	Probe Isotropy	Modulation type	Duty factor	PAR
2020-03-30	3842	Head	450	0.88	43.15	PASS	PASS	PASS	FM	PASS	PASS

9.3. System Check

SAR system verification is required to confirm measurement accuracy, according to the tissue dielectric media, probe calibration points and other system operating parameters required for measuring the SAR of a test device. The system verification must be performed for each frequency band and within the valid range of each probe calibration point required for testing the device. The same SAR probe(s) and tissue-equivalent media combinations used with each specific SAR system for system verification must be used for device testing. When multiple probe calibration points are required to cover substantially large transmission bands, independent system verifications are required for each probe calibration point. A system verification must be performed before each series of SAR measurements using the same probe calibration point and tissue-equivalent medium. Additional system verification should be considered according to the conditions of the tissue-equivalent medium and measured tissue dielectric parameters, typically every three to four days when the liquid parameters are re-measured or sooner when marginal liquid parameters are used at the beginning of a series of measurements.

System Performance Check Measurement Conditions:

- The measurements were performed in the flat section of the TWIN SAM or ELI phantom, shell thickness: 2.0 ± 0.2 mm (bottom plate) filled with Body or Head simulating liquid of the following parameters.
- The depth of tissue-equivalent liquid in a phantom must be ≥ 15.0 cm for SAR measurements ≤ 3 GHz and ≥ 10.0 cm for measurements > 3 GHz.
- The DASY system with an E-Field Probe was used for the measurements.
- The dipole was mounted on the small tripod so that the dipole feed point was positioned below the center marking of the flat phantom section and the dipole was oriented parallel to the body axis (the long side of the phantom). The standard measuring distance was 10 mm (above 1 GHz) and 15 mm (below 1 GHz) from dipole center to the simulating liquid surface.
- The coarse grid with a grid spacing of 15 mm was aligned with the dipole.
For 5 GHz band - The coarse grid with a grid spacing of 10 mm was aligned with the dipole.
- Special 7x7x7 (below 3 GHz) and/or 8x8x7 (above 3 GHz) fine cube was chosen for the cube.
- The results are normalized to 1 W input power.

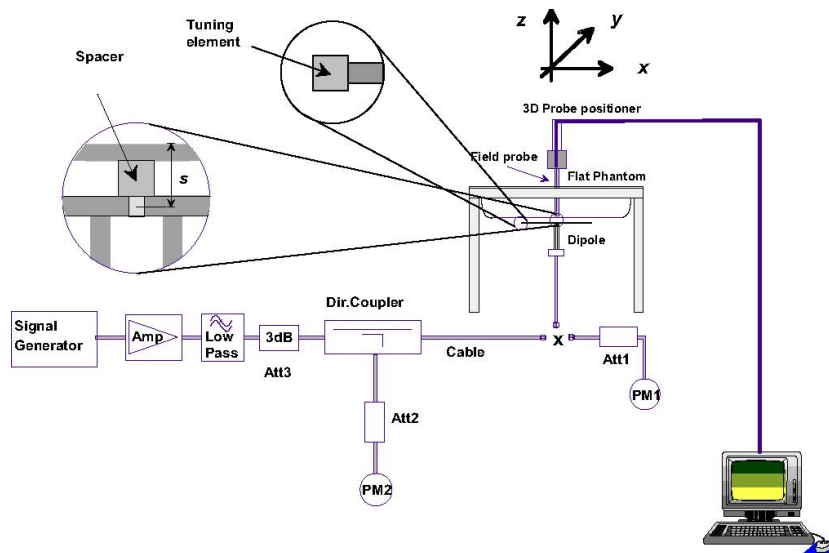

System Performance Check Setup



Photo of Dipole Setup

Check Result:

Head											
Frequency (MHz)	1g SAR			10g SAR			Delta (1g)	Delta (10g)	Limit	Temp (°C)	Date
	Target 1W	Normalize to 1W	Measured 250mW	Target 1W	Normalize to 1W	Measured 250mW					
450	4.48	4.52	1.13	3.00	3.05	0.763	0.89%	1.73%	±10%	22.7	2020-11-10

Note:

1. the graph results see follow.

Plots of System Performance Check

System Performance Check-Head 450MHz

DUT: D450V3; Type: D450V3; Serial: 1102

Date: 2020-11-10

Communication System: UID 0, A-CW (0); Frequency: 450 MHz; Duty Cycle: 1:1

Medium parameters used: $f = 450$ MHz; $\sigma = 0.853$ S/m; $\epsilon_r = 42.758$; $\rho = 1000$ kg/m³

Phantom section: Flat Section

Ambient Temperature: 22.2°C; Liquid Temperature: 22.0°C;

DASY5 Configuration:

- Probe: EX3DV4 - SN3842; ConvF(9.96, 9.96, 9.96) @ 450 MHz; Calibrated: 1/30/2020
- Sensor-Surface: 1.4mm (Mechanical Surface Detection)
- Electronics: DAE4 Sn1549; Calibrated: 4/4/2020
- Phantom: ELI V8.0 ; Type: QD OVA 004 AA ; Serial: 2078
- DASY52 52.10.2(1495); SEMCAD X 14.6.12(7450)

Head/d=15mm, Pin=250mW, dist=1.4mm/Area Scan (51x101x1): Interpolated grid:

$dx=1.500$ mm, $dy=1.500$ mm

Maximum value of SAR (interpolated) = 1.54 W/kg

Head/d=15mm, Pin=250mW, dist=1.4mm /Zoom Scan (5x5x7)/Cube 0:

Measurement grid: $dx=8$ mm, $dy=8$ mm, $dz=5$ mm

Reference Value = 41.62 V/m; Power Drift = -0.13 dB

Peak SAR (extrapolated) = 1.80 W/kg

SAR(1 g) = 1.13 W/kg; SAR(10 g) = 0.763 W/kg

Maximum value of SAR (measured) = 1.54 W/kg

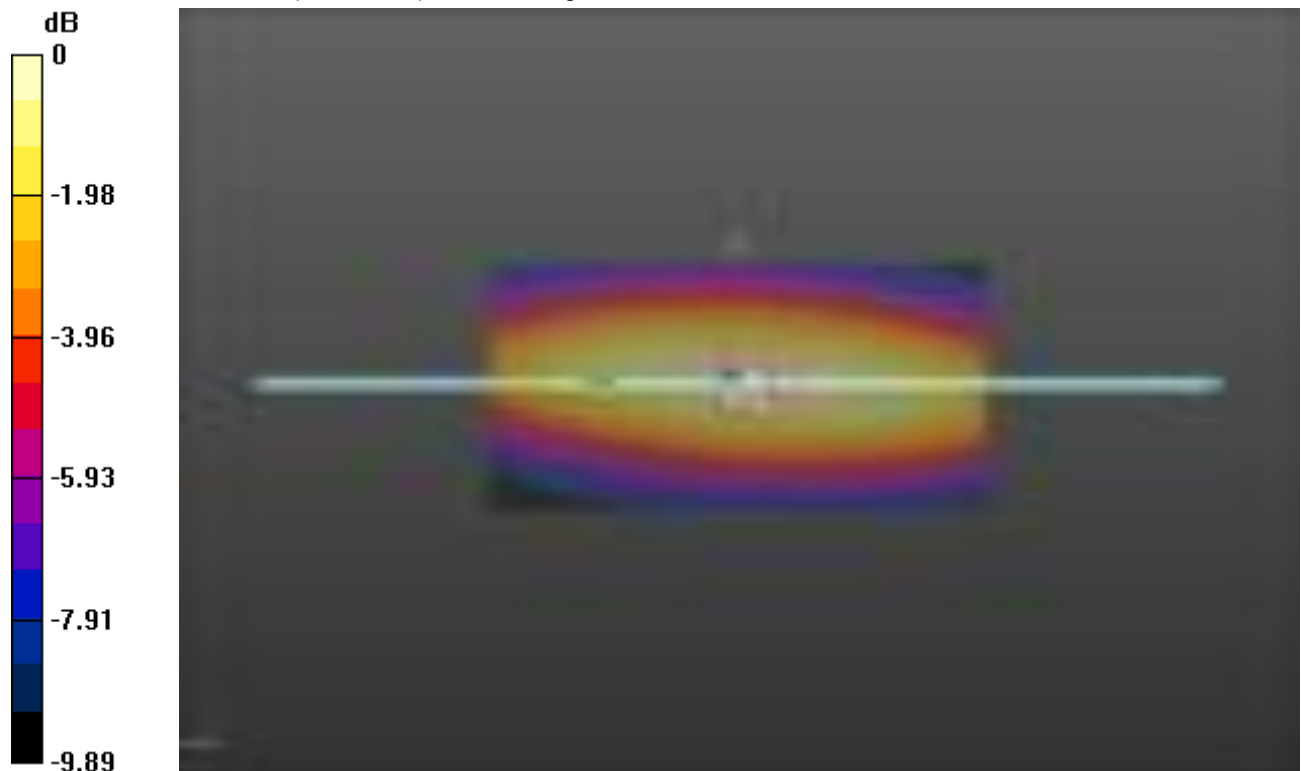

10. SAR Exposure Limits

SAR assessments have been made in line with the requirements of FCC 47 CFR § 2.1093.

Type Exposure	Limit (W/kg)	
	General Population / Uncontrolled Exposure Environment	Occupational / Controlled Exposure Environment
Spatial Average SAR (whole body)	0.08	0.4
Spatial Peak SAR (1g cube tissue for head and trunk)	1.6	8.0
Spatial Peak SAR (10g for limb)	4.0	20.0

Population/Uncontrolled Environments: are defined as locations where there is the exposure of individual who have no knowledge or control of their exposure.

Occupational/Controlled Environments: are defined as locations where there is exposure that may be incurred by people who are aware of the potential for exposure (i.e. as a result of employment or occupation).

11. Radiated Power Measurement Results

FRS				
Mode	Channel Bandwidth	Frequency		Radiated power (dBm)
		Channel	MHz	
Analog	12.5kHz	CH4	462.6375	31.75

12. Maximum Tune-up Limit

This device operates using the following maximum output power specifications. SAR values were scaled to the maximum allowed power to determine compliance per KDB publication 447498 D01

FRS			
Mode	Channel Bandwidth	Operation Frequency Range (MHz)	Maximum tune-up power (dBm)
Analog	12.5kHz	462.5500-462.7250	33.00

13. SAR Measurement Results

Front-of-face											
Mode	Test Position	Frequency		ERP (dBm)	Tune-up limit (dBm)	Tune-up scaling factor	Power Drift(dB)	Measured SAR(1g)	Report SAR(1g)	75% Duty factor SAR	Plot No.
		CH	MHz					(W/kg)	(W/kg)	(W/kg)	
Analog 12.5kHz	Front	CH4	462.6375	31.75	33.00	1.334	-0.09	0.452	0.603	0.452	1

Front-of-face											
Mode	Test Position	Frequency		ERP (dBm)	Tune-up limit (dBm)	Tune-up scaling factor	Power Drift(dB)	Measured SAR(1g)	Report SAR(1g)	75% Duty factor SAR	Plot No.
		CH	MHz					(W/kg)	(W/kg)	(W/kg)	
Analog 12.5kHz	Front	CH4	462.6375	31.75	33.00	1.334	-0.15	1.250	1.667	1.250	2

Note:

1. The distance of the front-of-face test is 25mm, the distance of the Body-worn test is 0mm.
2. Batteries are fully charged at the beginning of the SAR measurements.
3. The Body-worn SAR evaluation was performed with the Leather Case body-worn accessory attached to the DUT and touching the outer surface of the planar phantom.
4. SAR Test Data Plots to the Appendix A.

14. Test Setup Photos

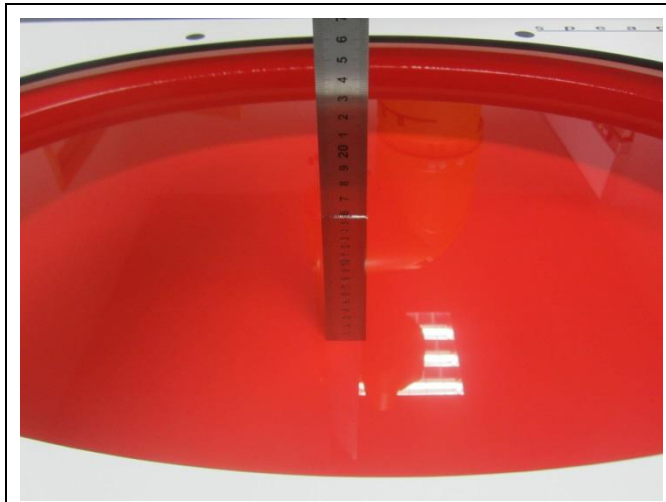

Liquid depth in the ELI Phantom



Front-of-face(25mm)



Body-worn(0mm)

15. External and Internal Photos of the EUT

Please refer to the test report No.: CHTEW20110051

-----End of Report-----