



# Test Report

## FCC Part15 Subpart C & RSS-247 Issue 2

Product Name : Somnox Sleep Robot  
Model No. : 801.00.001  
FCC ID : 2ASNCGC519591  
IC : 24848-GC519591

Applicant : Somnox Inc.  
Address : 228 East 45th Street, Suite 9E , New  
York, NY 10017

Date of Receipt : Aug. 08, 2018  
Test Date : Aug. 09, 2018~ Feb. 25, 2019  
Issued Date : Mar. 13, 2019  
Report No. : 1882054R-RF-US-P06V01  
Report Version : V1.0

The test results relate only to the samples tested.

The test results shown in the test report are traceable to the national/international standard through the calibration of the equipment and evaluated measurement uncertainty herein.

This report must not be used to claim product endorsement by A2LA or any agency of the government.

The test report shall not be reproduced without the written approval of DEKRA Testing & Certification (Suzhou) Co., Ltd.

# Test Report Certification

Issued Date : Mar. 13, 2019  
Report No. : 1882054R-RF-US-P06V01



Product Name : Somnox Sleep Robot  
 Applicant : Somnox Inc.  
 Address : 228 East 45th Street, Suite 9E , New York, NY 10017  
 Manufacturer : Koninklijke Auping b.v.  
 Address : Maagdenburgstraat 26, Deventer, 7421 ZA, The Netherlands  
 Model No. : 801.00.001  
 FCC ID : 2ASNCGC519591  
 IC : 24848-GC519591  
 EUT Voltage : AC 100-240V, 50/60Hz 0.55A  
 Test Voltage : AC 120V/60Hz  
 Brand Name : Somnox Sleep Robot  
 Applicable Standard : FCC CFR Title 47 Part 15 Subpart C: 2015  
 ANSI C63.10:2013;  
 KDB 558074 D01v05  
 RSS-Gen Issue 5/ RSS-247 Issue 2  
 Test Result : Complied  
 Performed Location : DEKRA Testing & Certification (Suzhou) Co., Ltd.  
 No.99 Hongye Rd., Suzhou Industrial Park, Suzhou, 215006,  
 Jiangsu, China  
 TEL: +86-512-6251-5088 / FAX: +86-512-6251-5098  
 FCC Designation Number: CN1199; ISED Lab Code: 4075B

Documented By : Kitty Li  
 ( Adm. Specialist: Kitty Li )

Reviewed By : Frank He  
 (Senior Project Manager: Frank He )

Approved By : Jack Zhang  
 (Engineering Supervisor: Jack Zhang)

## TABLE OF CONTENTS

Description	Page
1. General Information.....	6
1.1. EUT Description .....	6
1.2. Working Frequency of Each Channel: .....	7
1.3. Antenna information .....	7
1.4. Mode of Operation.....	8
1.5. Tested System Details .....	8
1.6. Configuration of Tested System.....	9
1.7. EUT Exercise Software.....	10
2. Technical Test .....	11
2.1. Summary of Test Result.....	11
2.2. Test Frequency configuration:.....	12
2.3. Test Environment.....	13
2.4. Measurement Uncertainty.....	13
3. AC Power Line Conducted Emission.....	14
3.1. Test Equipment.....	14
3.2. Test Setup .....	14
3.3. Limit.....	15
3.4. Test Procedure .....	15
3.5. Test Result.....	16
4. Emissions in restricted frequency bands .....	18
4.1. Test Equipment.....	18
4.2. Test Setup .....	19
4.3. Limit.....	20
4.4. Test Procedure .....	23
4.5. EUT test Axis definition.....	24
4.6. Test Result.....	25
5. Emissions in non-restricted frequency bands .....	33
5.1. Test Equipment.....	33
5.2. Test Setup .....	33
5.3. Limit.....	34
5.4. Test Procedure .....	35
5.5. EUT test Axis definition.....	36
5.6. Test Result.....	37
6. Radiated Emission Band Edge .....	38
6.1. Test Equipment.....	38
6.2. Test Setup .....	39
6.3. Limit.....	39

- 6.4. Test Procedure .....40
- 6.5. EUT test definition .....41
- 6.6. Duty Cycle .....42
- 6.7. Test Result .....43
- 7. Occupied Bandwidth .....51
- 7.1. Test Equipment.....51
- 7.2. Test Setup .....51
- 7.3. Limit.....52
- 7.4. Test Procedure .....52
- 7.5. EUT test definition .....53
- 7.6. Test Result.....54
- 8. Fundamental emission output power .....55
- 8.1. Test Equipment.....55
- 8.2. Test Setup .....55
- 8.3. Limit.....56
- 8.4. Test Procedure .....57
- 8.5. EUT test definition .....58
- 8.6. Test Result.....59
- 9. Power Spectral Density .....60
- 9.1. Test Equipment.....60
- 9.2. Test Setup .....60
- 9.3. Limit.....60
- 9.4. Test Procedure .....61
- 9.5. EUT test definition .....62
- 9.6. Test Result.....63

## History of This Test Report

REPORT NO.	VERSION	DESCRIPTION	ISSUED DATE
1882054R-RF-US-P06V01	V1.0	Initial Issued Report	Mar. 13, 2019

## 1. General Information

### 1.1. EUT Description

Product Name	Somnox Sleep Robot
Model No.	801.00.001
EUT Voltage	AC 100-240V, 50/60Hz 0.55A
Test Voltage	AC 120V/60Hz
Bluetooth Specification	V4.0
Frequency Range	2402- 2480 MHz
Channel Number	V4.0: 40
Channel Separation	V4.0: 2MHz
Type of Modulation	V4.0: GFSK
Data Rate	V4.0: 1Mbps(GFSK)
Antenna Type	Reference to Antenna List
Peak Antenna Gain	Reference to Antenna List

### 1.2. Working Frequency of Each Channel:

Bluetooth Working Frequency of Each Channel: (For V4.0)							
Channel	Frequency	Channel	Frequency	Channel	Frequency	Channel	Frequency
00	2402 MHz	01	2404 MHz	02	2406 MHz	03	2408 MHz
04	2410 MHz	05	2412 MHz	06	2414 MHz	07	2416 MHz
08	2418 MHz	09	2420 MHz	10	2422 MHz	11	2424 MHz
12	2426 MHz	13	2428 MHz	14	2430 MHz	15	2432 MHz
16	2434 MHz	17	2436 MHz	18	2438 MHz	19	2440 MHz
20	2442 MHz	21	2444 MHz	22	2446 MHz	23	2448 MHz
24	2450 MHz	25	2452 MHz	26	2454 MHz	27	2456 MHz
28	2458 MHz	29	2460 MHz	30	2462 MHz	31	2464 MHz
32	2466 MHz	33	2468 MHz	34	2470 MHz	35	2472 MHz
36	2474 MHz	37	2476 MHz	38	2478 MHz	39	2480 MHz

### 1.3. Antenna information

Model No.	N/A					
Antenna manufacturer	N/A					
Antenna Delivery	<input checked="" type="checkbox"/>	1*TX+1*RX	<input type="checkbox"/>	2*TX+2*RX	<input type="checkbox"/>	3*TX+3*RX
Antenna technology	<input checked="" type="checkbox"/>	SISO				
	<input type="checkbox"/>	MIMO	<input type="checkbox"/>	Basic		
			<input type="checkbox"/>	CDD		
			<input type="checkbox"/>	Sectorized		
			<input type="checkbox"/>	Beam-forming		
Antenna Type	<input type="checkbox"/>	External	<input type="checkbox"/>	Dipole		
			<input type="checkbox"/>	Sectorized		
	<input checked="" type="checkbox"/>	Internal	<input type="checkbox"/>	PIFA		
			<input checked="" type="checkbox"/>	PCB		
			<input type="checkbox"/>	Ceramic Chip Antenna		
			<input type="checkbox"/>	Dipole Antenna		
Antenna Technology	Ant Gain (dBi)					
<input checked="" type="checkbox"/> SISO	3.3					

#### 1.4. Mode of Operation

Test Mode
Mode 1: Transmit-1Mbps(GFSK_BLE)

#### 1.5. Tested System Details

The types for all equipment, plus descriptions of all cables used in the tested system (including inserted cards) are:

Product		Manufacturer	Model No.	Serial No.	Power Cord
1	Wideband Radio Communication Tester	R & S	CMW 500	1201.0002K50-158243-jb	Shielded $\leq 1\text{m}$
A	USB Control Cable	Shielded $>10\text{m}$	A	USB Control Cable	Shielded $>10\text{m}$
B	USB Control Cable	Shielded $\leq 1\text{m}$	B	USB Control Cable	Shielded $\leq 1\text{m}$



### 1.6. Configuration of Tested System

Test setup Diagram- AC Line Conducted Emission Test

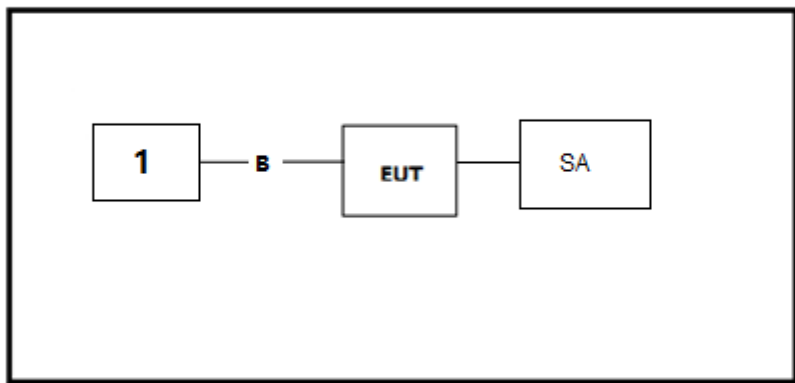

Test setup Diagram- Radiated Emission

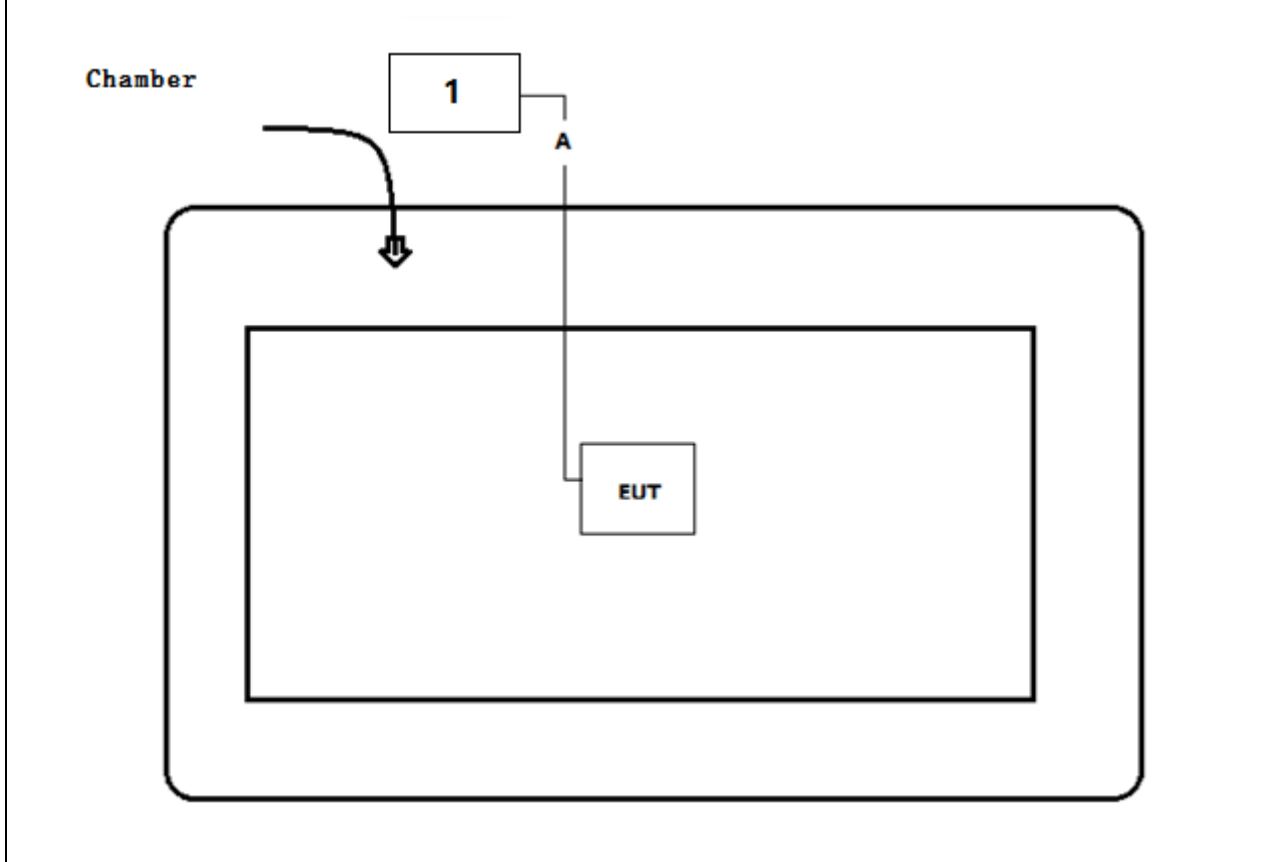

### 1.7. EUT Exercise Software

1	Setup the EUT and simulators as shown on above.
2	Turn on the power of equipment.
3	Select the transmission mode and test channel, then start test.

## 2. Technical Test

### 2.1. Summary of Test Result

#### For FCC:

Performed Test Item	Normative References	Limit	Result
AC Power Line Conducted Emission	FCC CFR Title 47 Part 15 Subpart C: 2015 Section 15.207	FCC 15.207	PASS
Emissions in restricted frequency bands	FCC CFR Title 47 Part 15 Subpart C: 2015 Section 15.209	FCC 15.209	PASS
Emissions in non-restricted frequency bands	FCC CFR Title 47 Part 15 Subpart C: 2015 Section 15.247(d)	$\geq 20\text{dBc}$	PASS
Radiated Emission Band Edge	FCC CFR Title 47 Part 15 Subpart C: 2015 15.247(d)	FCC 15.209	PASS
Occupied Bandwidth	FCC CFR Title 47 Part 15 Subpart C: 2015 Section 15.247(a)(2)	$\geq 500\text{kHz}$	PASS
Fundamental emission output power	FCC CFR Title 47 Part 15 Subpart C: 2015 Section 15.247(b)(3)	$\leq 30\text{dBm}$	PASS
Power Spectral Density	FCC CFR Title 47 Part 15 Subpart C: 2015 Section 15.247(e)	$\leq 8\text{dBm}/3\text{kHz}$	PASS
Antenna Requirement	FCC CFR Title 47 Part 15 Subpart C: 2015 Section 15.203	FCC 15.203	PASS

#### For ISED:

Performed Test Item	Normative References	Limit	Result
AC Power Line Conducted Emission	RSS-Gen Issue 5 Section 8.8	RSS-Gen	PASS
Emissions in restricted frequency bands	RSS-Gen Issue 5 Section 8.10	RSS-Gen	PASS
Radiated Emission Band Edge	RSS-247 Issue 2 Section A5.5	RSS-247	PASS
Fundamental emission output power	RSS-247 Issue 2 Section A5.4(4)	$\leq 30\text{dBm}$	PASS

**2.2. Test Frequency configuration:**

<b>Modulation Mode</b>	<b>Channel</b>	<b>Frequency</b>	<b>Channel</b>	<b>Frequency</b>	<b>Channel</b>	<b>Frequency</b>
<b>BLE</b>	00	2402 MHz	19	2440 MHz	39	2480MHz

### 2.3. Test Environment

Items	Required (IEC 68-1)	Actual
Temperature (°C)	15-35	21
Humidity (%RH)	25-75	50
Barometric pressure (mbar)	860-1060	950-1000

### 2.4. Measurement Uncertainty

Test Items	Uncertainty
AC Power Line Conducted Emission	±2.02dB
Radiated Emission	Below 1GHz ±3.8 dB
	Above 1GHz ±3.9 dB
RF Antenna Port Conducted Emission	±1.27dB
Radiated Emission Band Edge	±3.9dB
Occupied Bandwidth	±1kHz
Power Spectral Density	±1.27dB

### 3. AC Power Line Conducted Emission

#### 3.1. Test Equipment

AC Power Line Conducted Emission / TR-1					
Instrument	Manufacturer	Type No.	Serial No.	Cal. Date	Cal. Due Date
EMI Test Receiver	R&S	ESCI	100906	2018.03.05	2019.03.04
Two-Line V-Network	R&S	ENV 216	101189	2018.07.16	2019.07.15
Two-Line V-Network	R&S	ENV 216	101044	2018.09.16	2019.09.15
50ohm Coaxial Switch	Anritsu	MP59B	6200464462	N/A	N/A
50ohm Termination	SHX	TF2	07081402	2018.09.16	2019.09.15
Temperature/Humidity Meter	Zhichen	ZC1-2	TR1-TH	2019.01.03	2020.01.02

Note: All equipment is calibrated with traceable calibrations. Each calibration is traceable to the national or international standards.

#### 3.2. Test Setup

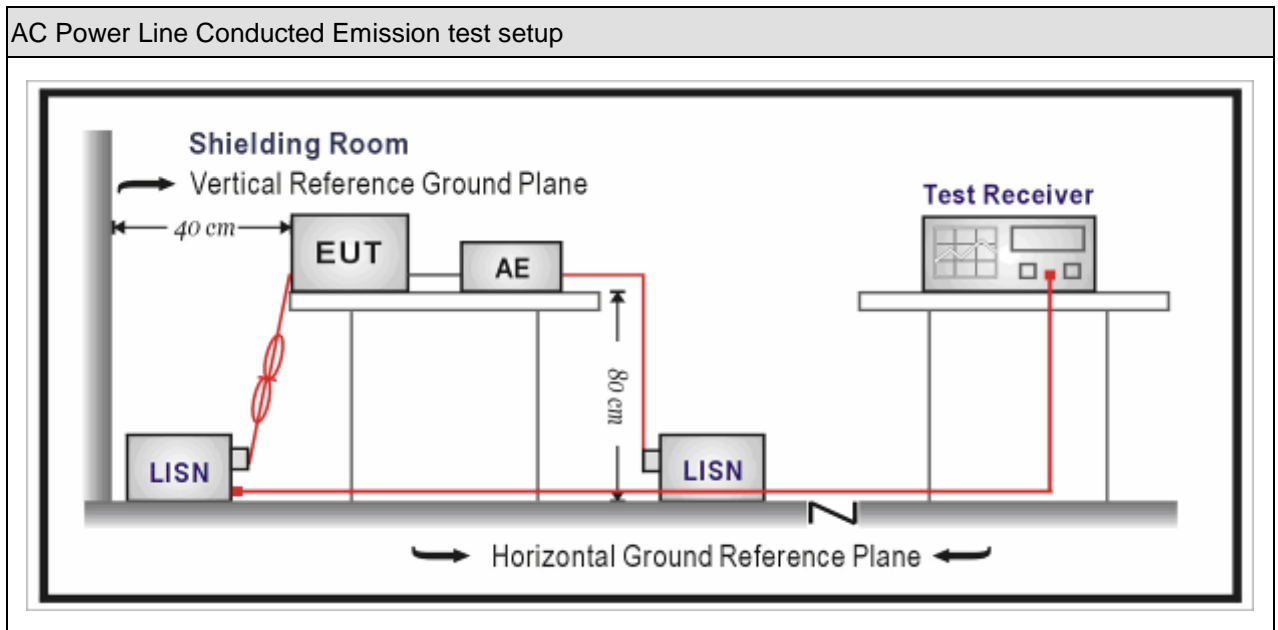

### 3.3. Limit

Frequency of Emission (MHz)	Conducted Limit	
	Quasi-peak (dBµV)	Average(dBµV)
0.15-0.5	66 to 56	56 to 46
0.5-5	56	46
5-30	60	50

Note 1: The lower limit shall apply at the transition frequencies.  
 Note 2: The limit decreases linearly with the logarithm of the frequency in the range 0.15 MHz to 0.5 MHz.

### 3.4. Test Procedure

Test Method			
	References Rule	Chapter	Item
<input checked="" type="checkbox"/>	ANSI C63.10-2013	6.2	Standard test method for ac power-line conducted emissions from unlicensed wireless devices
<input checked="" type="checkbox"/>	ANSI C63.4-2014	7	AC power-line conducted emission measurements

### 3.5. Test Result

Engineer: Aaron	
Site: TR1	Time: 2019/01/17
Limit: FCC_Part15.207_CE_AC Power	Margin: 0
Probe: ENV216_101190(0.009-30MHz)	Polarity: Line
EUT: Somnox Sleep Robot	Power: AC 120V/60Hz
Note: Mode 1	

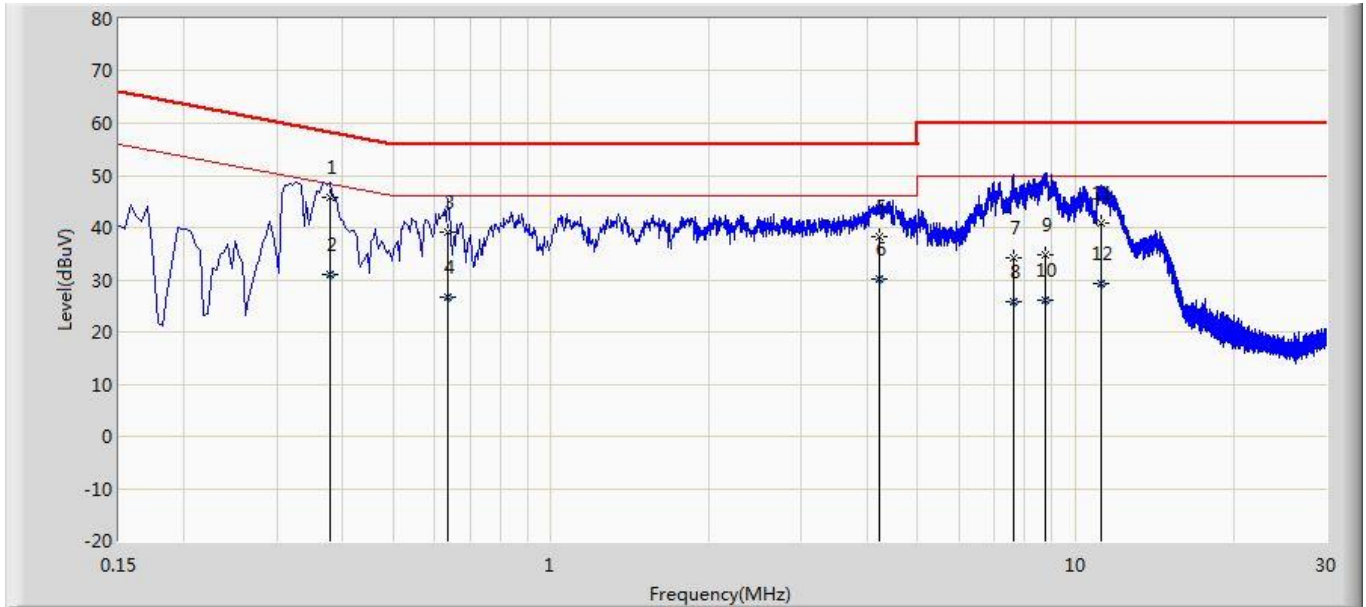

No	Mark	Frequency (MHz)	Measure Level (dBuV)	Reading Level (dBuV)	Over Limit (dB)	Limit (dBuV)	Probe (dB)	Cable (dB)	Amp (dB)	Type
1	*	0.378	45.680	36.043	-12.643	58.323	9.600	0.037	0.000	QP
2		0.378	31.063	21.426	-17.260	48.323	9.600	0.037	0.000	AV
3		0.634	39.031	29.383	-16.969	56.000	9.600	0.048	0.000	QP
4		0.634	26.569	16.921	-19.431	46.000	9.600	0.048	0.000	AV
5		4.226	38.145	28.367	-17.855	56.000	9.647	0.131	0.000	QP
6		4.226	30.183	20.405	-15.817	46.000	9.647	0.131	0.000	AV
7		7.594	34.202	24.313	-25.798	60.000	9.714	0.175	0.000	QP
8		7.594	25.942	16.053	-24.058	50.000	9.714	0.175	0.000	AV
9		8.734	34.787	24.857	-25.213	60.000	9.741	0.189	0.000	QP
10		8.734	26.163	16.234	-23.837	50.000	9.741	0.189	0.000	AV
11		11.174	40.870	30.857	-19.130	60.000	9.800	0.213	0.000	QP
12		11.174	29.280	19.266	-20.720	50.000	9.800	0.213	0.000	AV

Note:

1. " \* ", means this data is the worst emission level.
2. Measurement Level = Reading Level + Factor(Probe+Cable-Amp).



Engineer: Aaron	
Site: TR1	Time: 2019/01/17
Limit: FCC_Part15.207_CE_AC Power	Margin: 0
Probe: ENV216_101190(0.009-30MHz)	Polarity: Neutral
EUT: Somnox Sleep Robot	Power: AC 120V/60Hz
Note: Mode 1	

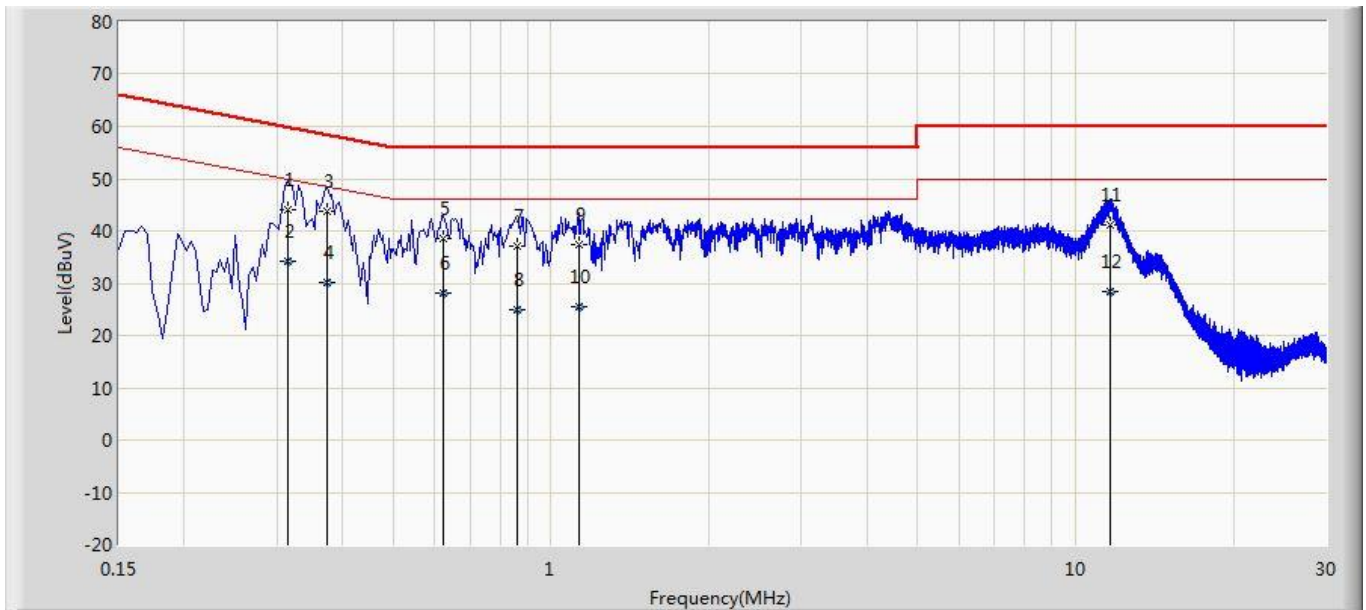

No	Mark	Frequency (MHz)	Measure Level (dBuV)	Reading Level (dBuV)	Over Limit (dB)	Limit (dBuV)	Probe (dB)	Cable (dB)	Amp (dB)	Type
1		0.314	43.921	34.291	-15.943	59.864	9.596	0.034	0.000	QP
2		0.314	34.217	24.586	-15.647	49.864	9.596	0.034	0.000	AV
3	*	0.374	43.765	34.134	-14.647	58.412	9.594	0.037	0.000	QP
4		0.374	30.259	20.629	-18.152	48.412	9.594	0.037	0.000	AV
5		0.622	38.418	28.781	-17.582	56.000	9.590	0.048	0.000	QP
6		0.622	27.990	18.352	-18.010	46.000	9.590	0.048	0.000	AV
7		0.862	37.122	27.478	-18.878	56.000	9.590	0.054	0.000	QP
8		0.862	25.047	15.403	-20.953	46.000	9.590	0.054	0.000	AV
9		1.130	37.406	27.751	-18.594	56.000	9.592	0.063	0.000	QP
10		1.130	25.507	15.852	-20.493	46.000	9.592	0.063	0.000	AV
11		11.622	41.303	31.239	-18.697	60.000	9.845	0.218	0.000	QP
12		11.622	28.284	18.221	-21.716	50.000	9.845	0.218	0.000	AV

**Note:**

1. " \* ", means this data is the worst emission level.
2. Measurement Level = Reading Level + Factor(Probe+Cable-Amp).

## 4. Emissions in restricted frequency bands

### 4.1. Test Equipment

Radiated Emission(Below 1GHz) / AC-2					
Instrument	Manufacturer	Type No.	Serial No.	Cal. Date	Cal. Due Date
EMI Test Receiver	R&S	ESCI	100573	2018.03.29	2019.03.28
Loop Antenna	R&S	HFH2-Z2	833799/003	2018.11.16	2019.11.15
Bilog Antenna	Teseq GmbH	CBL6112D	27611	2018.10.16	2019.10.15
Coaxial Cable	Huber+Suhner	SUCOFLEX 106	AC2-C	2018.03.02	2019.03.01
Temperature/Humidity Meter	Zhichen	ZC1-2	AC2-TH	2019.01.03	2020.01.02

Note: All equipment is calibrated with traceable calibrations. Each calibration is traceable to the national or international standards.

Radiated Emission(Above 1GHz) / AC-5					
Instrument	Manufacturer	Type No.	Serial No.	Cal. Date	Cal. Due Date
Spectrum Analyzer	Agilent	E4446A	MY45300103	2019.01.04	2020.01.03
Preamplifier	Miteq	NSP1800-25	1364185	2018.05.06	2019.05.05
Preamplifier	QuieTek	AP-040G	CHM-0906001	2018.05.06	2019.05.05
DRG Horn	ETS-Lindgren	3117	00123988	2019.01.22	2020.01.21
Broad-Band Horn Antenna	Schwarzbeck	BBHA9170	294	2018.11.25	2019.11.24
Coaxial Cable	Huber+Suhner	SUCOFLEX 106	AC5-C1	2018.03.02	2019.03.01
Coaxial Cable	Huber+Suhner	SUCOFLEX 106	AC5-C2	2018.03.02	2019.03.01
Coaxial Cable	Huber+Suhner	SUCOFLEX 102	AC5-C3	2018.03.02	2019.03.01
EMI Receiver	Agilent	N9038A	MY51210196	2018.06.10	2019.06.09
Temperature/Humidity Meter	Zhichen	ZC1-2	AC5-TH	2019.01.04	2020.01.03

Note: All equipment is calibrated with traceable calibrations. Each calibration is traceable to the national or international standards.

### 4.2. Test Setup

Below 30MHz Test Setup:

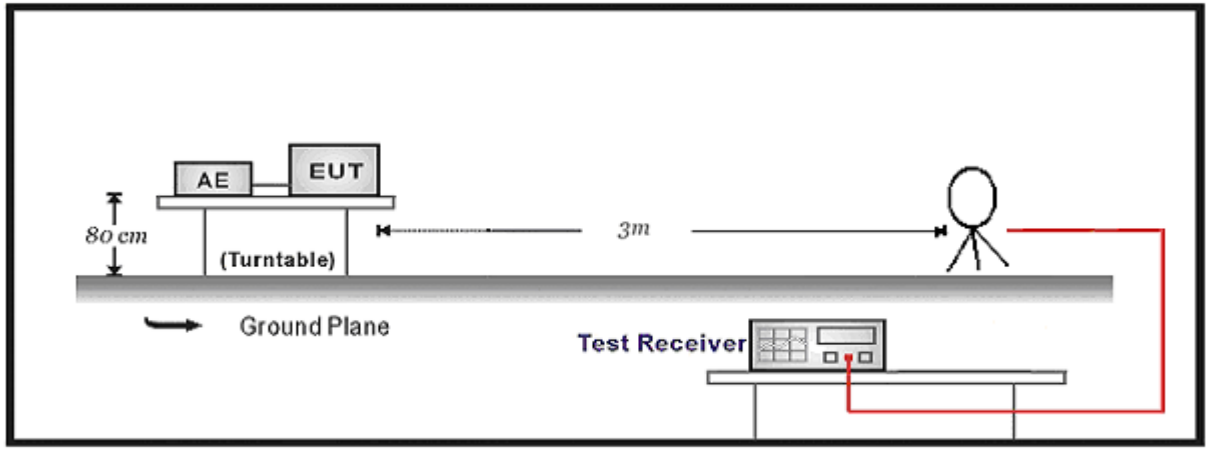

30MHz-1GHz Test Setup:

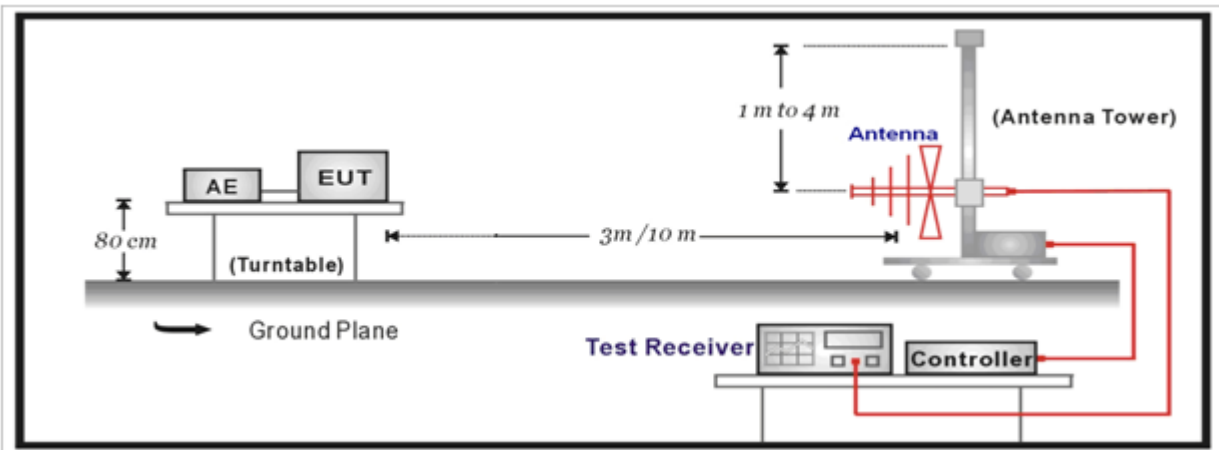

Above 1GHz Test Setup:

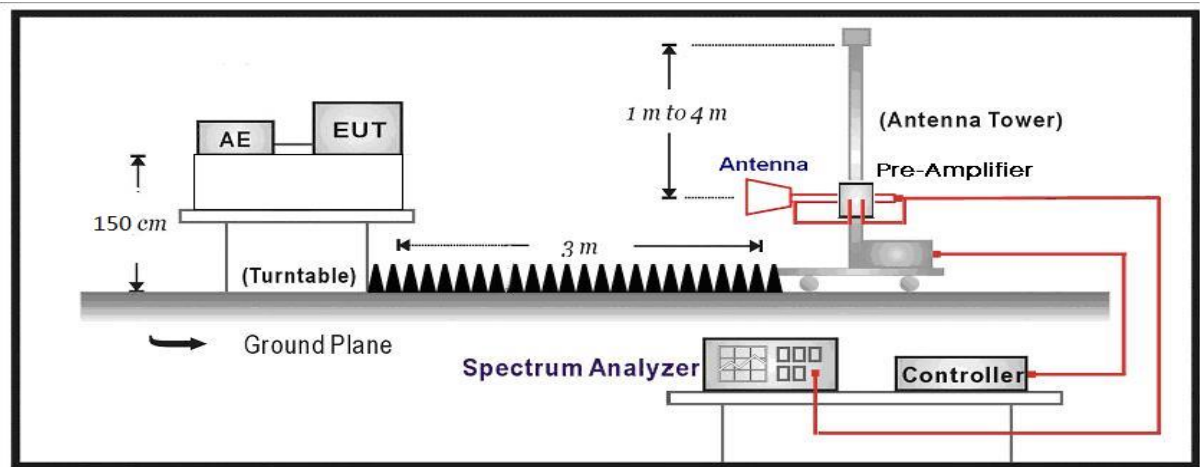

**4.3. Limit**

**For FCC:**

Restricted Bands of operation			
Frequency (MHz)	Frequency (MHz)	Frequency (MHz)	Frequency (GHz)
0.090 – 0.110	16.42 – 16.423	399.9 – 410	4.5 – 5.15
0.495 – 0.505	16.69475 – 16.69525	608 – 614	5.35 – 5.46
2.1735 – 2.1905	16.80425 – 16.80475	960 – 1240	7.25 – 7.75
4.125 – 4.128	25.5 – 25.67	1300 – 1427	8.025 – 8.5
4.17725 – 4.17775	37.5 – 38.25	1435 – 1626.5	9.0 – 9.2
4.20725 – 4.20775	73 – 74.6	1645.5 – 1646.5	9.3 – 9.5
6.215 – 6.218	74.8 – 75.2	1660 – 1710	10.6 – 12.7
6.26775 – 6.26825	108 – 121.94	1718.8 – 1722.2	13.25 – 13.4
6.31175 – 6.31225	123 – 138	2200 – 2300	14.47 – 14.5
8.291 – 8.294	149.9 – 150.05	2310 – 2390	15.35 – 16.2
8.362 – 8.366	156.52475 – 156.52525	2483.5 – 2500	17.7 – 21.4
8.37625 – 8.38675	156.7 – 156.9	2690 – 2900	22.01 – 23.12
8.81425 – 8.81475	162.0125 – 167.17	3260 – 3267	23.6 – 24.0
12.29 – 12.293	167.72 – 173.2	3332 – 3339	31.2 – 31.8
12.51975 – 12.52025	240 – 285	3345.8 – 3358	36.43 – 36.5
12.57675 – 12.57725	322 – 335.4	3600 – 4400	
13.36 – 13.41			

**For IC:**

Restricted Bands of operation			
Frequency (MHz)	Frequency (MHz)	Frequency (MHz)	Frequency (GHz)
0.090-0.110	13.36-13.41	1645.5-1646.5	9.0-9.2
2.1735-2.1905	16.42-16.423	1660-1710	9.3-9.5
3.020-3.026	16.69475-16.69525	1718.8-1722.2	10.6-12.7
4.125-4.128	16.80425-16.80475	2200-2300	13.25-13.4
4.17725-4.17775	25.5-25.67	2310-2390	14.47-14.5
4.20725-4.20775	37.5-38.25	2655-2900	15.35-16.2
5.677-5.683	73-74.6	3260-3267	17.7-21.4
6.215-6.218	74.8-75.2	3332-3339	22.01-23.12
6.26775-6.26825	108-138	3345.8-3358	23.6-24.0
6.31175-6.31225	156.52475-156.52525	3500-4400	31.2-31.8
8.291-8.294	156.7-156.9	4500-5150	36.43-36.5
8.362-8.366	240-285	5350-5460	Above 38.6
8.37625-8.38675	322-335.4	7250-7750	
8.41425-8.41475	399.9-410	8025-8500	
12.29-12.293	608-614		
12.51975-12.52025	960-1427		
12.57675-12.57725	1435-1626.5		

Restricted Band Emissions Limit			
Frequency (MHz)	Field strength (µV/m)	Field strength (dBµV/m)	Measurement distance (m)
0.009 - 0.49	2400/F(kHz)	48.5 – 13.8	300 <sub>(Note 1)</sub>
0.49 - 1.705	24000/F(kHz)	33.8 - 23	30 <sub>(Note 1)</sub>
1.705 - 30	30	29.5	30 <sub>(Note 1)</sub>
30 - 88	100	40	3 <sub>(Note 2)</sub>
88 - 216	150	43.5	3 <sub>(Note 2)</sub>
216 - 960	200	46	3 <sub>(Note 2)</sub>
Above 960	500	54	3 <sub>(Note 2)</sub>



Note 1: At frequencies below 30 MHz, measurements may be performed at a distance closer than that specified in the regulations; however, an attempt should be made to avoid making measurements in the near field. Pending the development of an appropriate measurement procedure for measurements performed below 30 MHz, when performing measurements at a closer distance than specified, the results shall be extrapolated to the specified distance by either making measurements at a minimum of two distances on at least one radial to determine the proper extrapolation factor or by using the square of an inverse linear distance extrapolation factor (40 dB/decade).

Note 2: At frequencies at or above 30 MHz, measurements may be performed at a distance other than what is specified provided: measurements are not made in the near field except where it can be shown that near field measurements are appropriate due to the characteristics of the device; and it can be demonstrated that the signal levels needed to be measured at the distance employed can be detected by the measurement equipment. Measurements shall not be performed at a distance greater than 30 meters unless it can be further demonstrated that measurements at a distance of 30 meters or less are impractical. When performing measurements at a distance other than that specified, the results shall be extrapolated to the specified distance using an extrapolation factor of 20 dB/decade (inverse linear-distance for field strength measurements; inverse-linear-distance-squared for power density measurements).

**4.4. Test Procedure**

Test Method			
	References Rule	Chapter	Description
<input type="checkbox"/>	ANSI C63.10	11.11	Emissions in non-restricted frequency bands
	<input type="checkbox"/> ANSI C63.10	11.11.2	Reference level measurement
	<input type="checkbox"/> ANSI C63.10	11.11.3	Emission level measurement
<input checked="" type="checkbox"/>	ANSI C63.10	11.12	Emissions in restricted frequency bands
	<input checked="" type="checkbox"/> ANSI C63.10	11.12.1	Radiated emission measurements
	<input checked="" type="checkbox"/> ANSI C63.10	11.12.2.7	Radiated spurious emission test
	<input checked="" type="checkbox"/> ANSI C63.10	6.4	Radiated emissions from unlicensed wireless devices below 30 MHz
	<input checked="" type="checkbox"/> ANSI C63.10	6.5	Radiated emissions from unlicensed wireless devices in the frequency range of 30 MHz to 1000 MHz
	<input checked="" type="checkbox"/> ANSI C63.10	6.6	Radiated emissions from unlicensed wireless devices above 1 GHz
	<input type="checkbox"/> ANSI C63.10	11.12.2.3	Quasi-peak measurement procedure
	<input checked="" type="checkbox"/> ANSI C63.10	11.12.2.4	Peak power measurement procedure
	<input checked="" type="checkbox"/> ANSI C63.10	11.12.2.5	Average power measurement procedures
	<input type="checkbox"/> ANSI C63.10	11.12.2.5.1	Trace averaging with continuous EUT transmission at full power
	<input type="checkbox"/> ANSI C63.10	11.12.2.5.2	Trace averaging across ON and OFF times of the EUT transmissions followed by duty cycle correction
	<input checked="" type="checkbox"/> ANSI C63.10	11.12.2.5.3	Reduced VBW averaging across ON and OFF times of the EUT transmissions with max hold

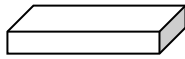
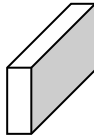
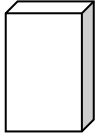
**4.5. EUT test Axis definition**

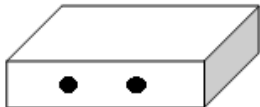
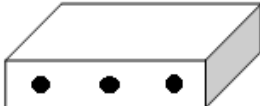
Item	Emissions in restricted frequency bands			
Device Category	<input type="checkbox"/>	Fixed point-to-point		
	<input type="checkbox"/>	Emit multiple directional beams, simultaneously or sequentially		
	<input checked="" type="checkbox"/>	Other cases		
Test mode	Mode 1			
Test method	<input checked="" type="checkbox"/>	Radiated		
		X Axis	Y Axis	Z Axis
				
		Worst Axis <input checked="" type="checkbox"/>	Worst Axis <input type="checkbox"/>	Worst Axis <input type="checkbox"/>
	<input type="checkbox"/>	Conducted		
	<input type="checkbox"/>	Chain 0		
				
	<input type="checkbox"/>	Chain 0	Chain 1	
				
	<input type="checkbox"/>	Chain 0	Chain 1	Chain 2
				



### 4.6. Test Result

Site: AC5	Time: 2019/01/14 - 22:39
Limit: FCC_Part15.209_RE(3m)	Margin: 0
Probe: Horn_3117_00167055(1-18GHz)	Polarity: Horizontal
EUT: Somnox Sleep Robot	Power: AC 120V/60Hz
Note: Mode 1:Transmit at 2402MHz by BLE	

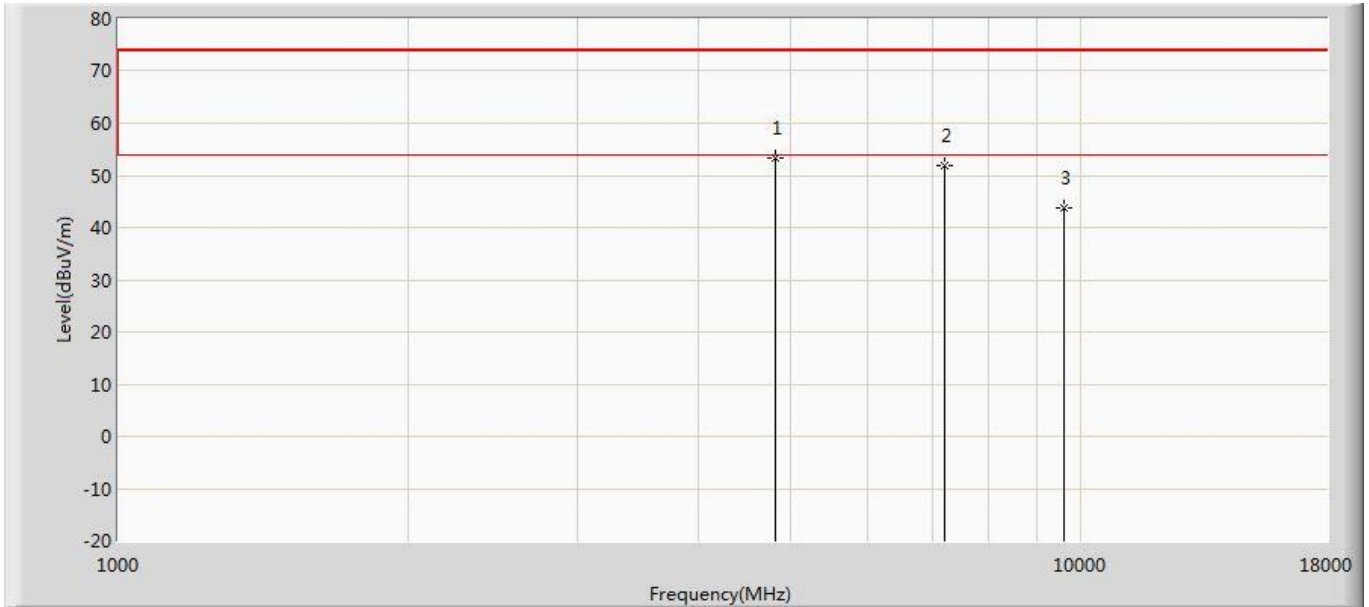

No	Mark	Frequency (MHz)	Measure Level (dBuV/m)	Reading Level (dBuV)	Over Limit (dB)	Limit (dBuV/m)	Factor (dB)	Type
1	*	4808.000	53.333	55.134	-20.667	74.000	-1.801	PK
2		7205.000	51.742	49.806	-22.258	74.000	1.936	PK
3		9608.000	43.763	38.864	-30.237	74.000	4.899	PK

Site: AC5	Time: 2019/01/14 - 22:39
Limit: FCC_Part15.209_RE(3m)	Margin: 0
Probe: Horn_3117_00167055(1-18GHz)	Polarity: Vertical
EUT: Somnox Sleep Robot	Power: AC 120V/60Hz
Note: Mode 1:Transmit at 2402MHz by BLE	

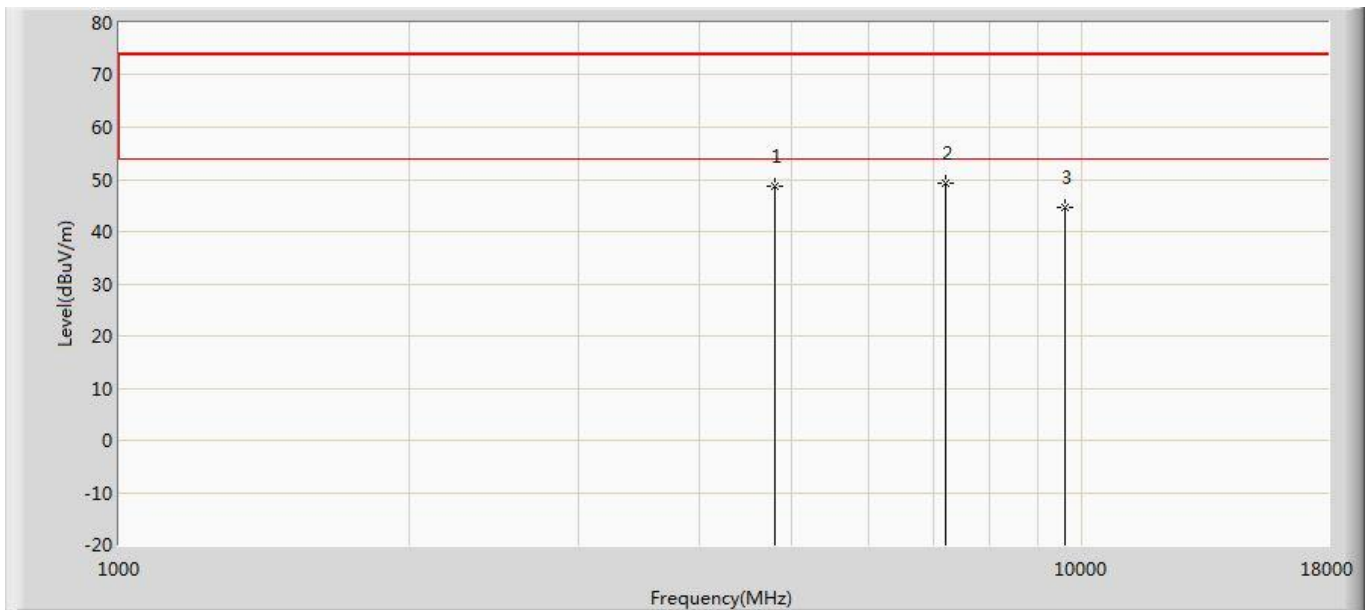

No	Mark	Frequency (MHz)	Measure Level (dBuV/m)	Reading Level (dBuV)	Over Limit (dB)	Limit (dBuV/m)	Factor (dB)	Type
1		4799.500	48.709	50.345	-25.291	74.000	-1.636	PK
2	*	7205.000	49.187	47.251	-24.813	74.000	1.936	PK
3		9608.000	44.583	39.684	-29.417	74.000	4.899	PK

Site: AC5	Time: 2019/01/14 - 22:39
Limit: FCC_Part15.209_RE(3m)	Margin: 0
Probe: Horn_3117_00167055(1-18GHz)	Polarity: Horizontal
EUT: Somnox Sleep Robot	Power: AC 120V/60Hz
Note: Mode 1:Transmit at 2440MHz by BLE	

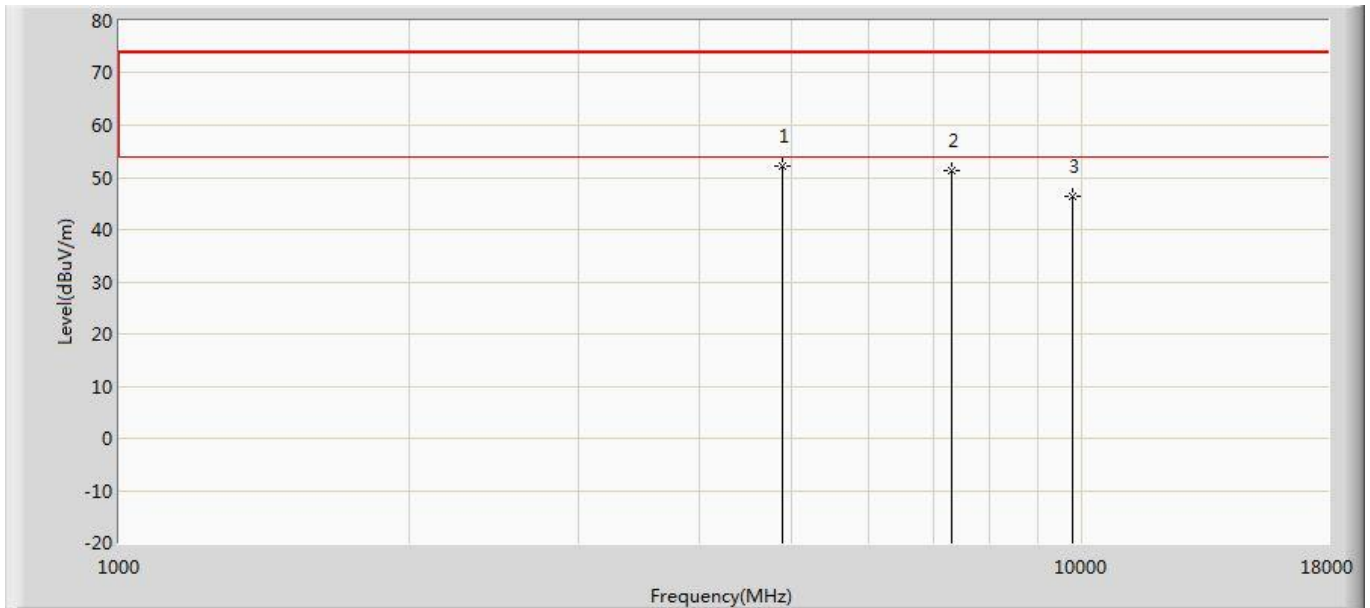

No	Mark	Frequency (MHz)	Measure Level (dBuV/m)	Reading Level (dBuV)	Over Limit (dB)	Limit (dBuV/m)	Factor (dB)	Type
1	*	4884.500	52.154	53.512	-21.846	74.000	-1.358	PK
2		7324.000	51.345	49.428	-22.655	74.000	1.917	PK
3		9764.000	46.301	40.301	-27.699	74.000	6.001	PK

Site: AC5	Time: 2019/01/14 - 22:39
Limit: FCC_Part15.209_RE(3m)	Margin: 0
Probe: Horn_3117_00167055(1-18GHz)	Polarity: Vertical
EUT: Somnox Sleep Robot	Power: AC 120V/60Hz
Note: Mode 1:Transmit at 2440MHz by BLE	

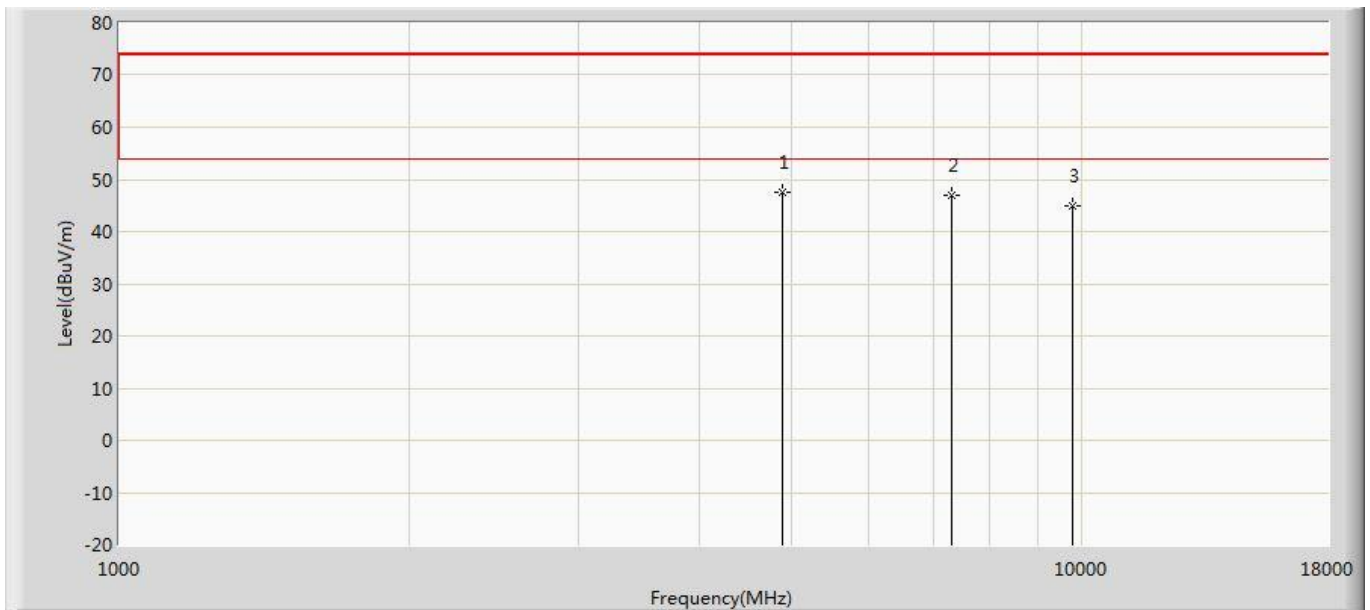

No	Mark	Frequency (MHz)	Measure Level (dBuV/m)	Reading Level (dBuV)	Over Limit (dB)	Limit (dBuV/m)	Factor (dB)	Type
1	*	4884.500	47.585	48.943	-26.415	74.000	-1.358	PK
2		7315.500	46.875	45.030	-27.125	74.000	1.845	PK
3		9764.000	44.981	38.981	-29.019	74.000	6.001	PK

Site: AC5	Time: 2019/01/14 - 22:39
Limit: FCC_Part15.209_RE(3m)	Margin: 0
Probe: Horn_3117_00167055(1-18GHz)	Polarity: Horizontal
EUT: Somnox Sleep Robot	Power: AC 120V/60Hz
Note: Mode 1:Transmit at 2480MHz by BLE	

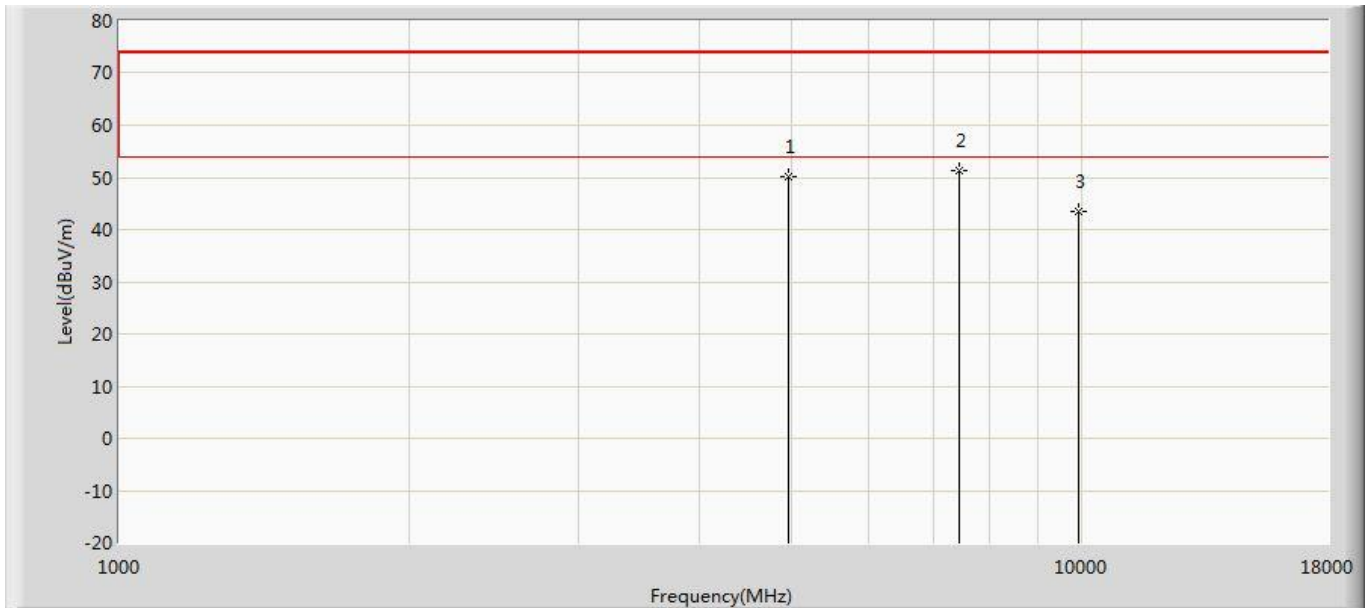

No	Mark	Frequency (MHz)	Measure Level (dBuV/m)	Reading Level (dBuV)	Over Limit (dB)	Limit (dBuV/m)	Factor (dB)	Type
1		4961.000	50.092	51.248	-23.908	74.000	-1.156	PK
2	*	7443.000	51.327	48.838	-22.673	74.000	2.489	PK
3		9920.000	43.598	38.344	-30.402	74.000	5.253	PK

Site: AC5	Time: 2019/01/14 - 22:39
Limit: FCC_Part15.209_RE(3m)	Margin: 0
Probe: Horn_3117_00167055(1-18GHz)	Polarity: Vertical
EUT: Somnox Sleep Robot	Power: AC 120V/60Hz
Note: Mode 1:Transmit at 2480MHz by BLE	

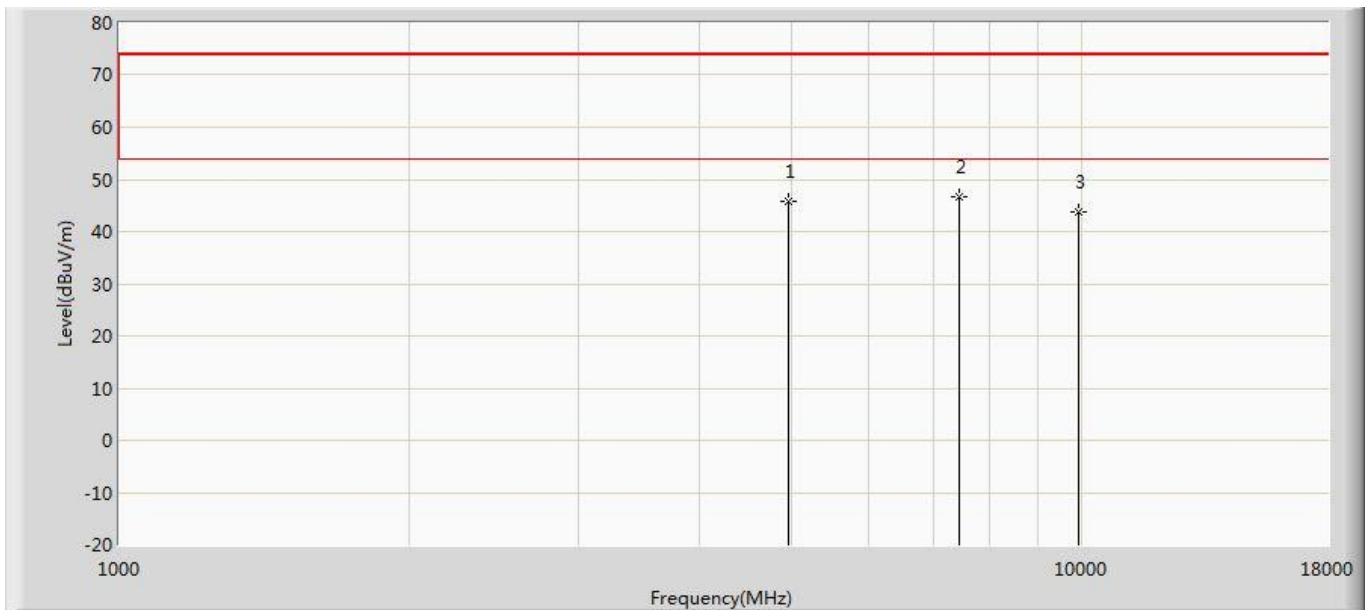

No	Mark	Frequency (MHz)	Measure Level (dBuV/m)	Reading Level (dBuV)	Over Limit (dB)	Limit (dBuV/m)	Factor (dB)	Type
1		4961.000	45.904	47.060	-28.096	74.000	-1.156	PK
2	*	7443.000	46.771	44.282	-27.229	74.000	2.489	PK
3		9920.000	43.811	38.557	-30.189	74.000	5.253	PK

**Note:**

1. Measured Level = Reading Level + Factor.
2. The test frequency range, 9kHz~30MHz, 18GHz~26GHz, both of the worst case are at least 20dB below the limits, therefore no data appear in the report.
3. This limit applies for using average detector, if the test result on peak is lower than average limit, then average measurement needn't be performed.
4. As the radiated emission was performed, so conducted emission was not tested.

**The worst case of Radiated Emission below 1GHz:**

Site: AC2	Time: 2019/01/29
Limit: FCC_Part15.209_RE(3m)	Margin: 0
Probe: AC2_3M(30-1000M)	Polarity: Horizontal
EUT: Somnox Sleep Robot	Power: AC 120V/60Hz
Note: Mode 1	

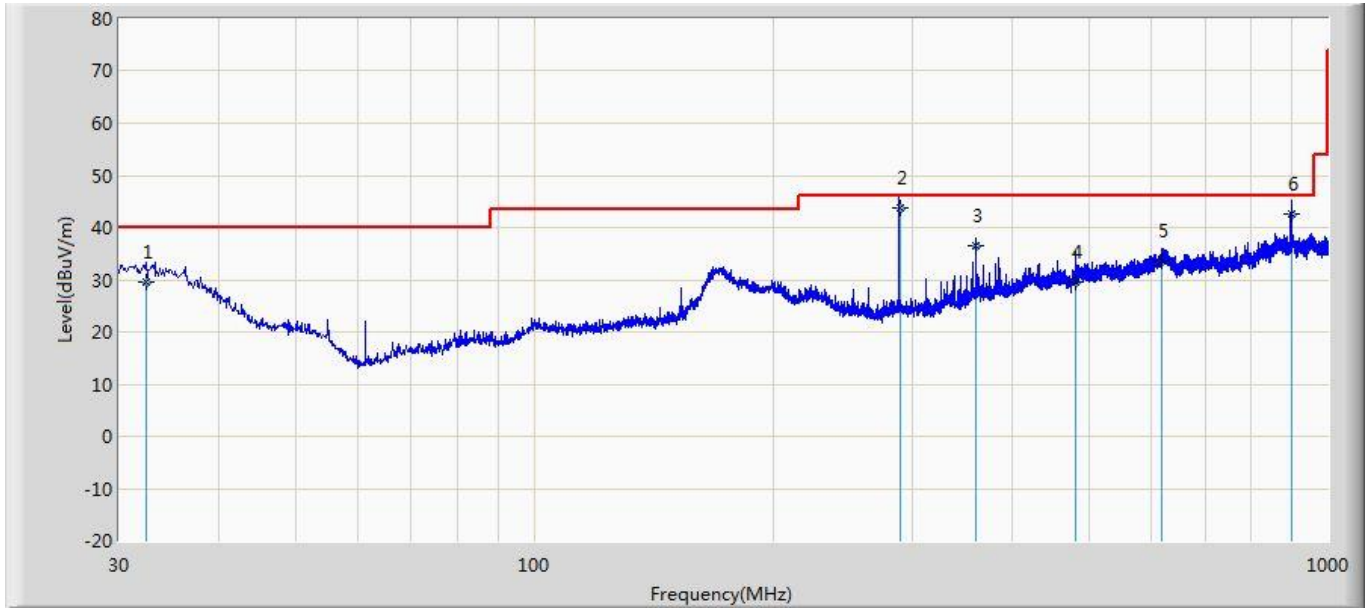

No	Mark	Frequency (MHz)	Measure Level (dBuV/m)	Reading Level (dBuV)	Over Limit (dB)	Limit (dBuV/m)	Probe (dB/m)	Cable (dB)	Amp (dB)	Ant Pos (cm)	Table Pos (deg)	Type
1		32.454	29.677	2.300	-10.323	40.000	20.732	6.645	0.000	200	248	QP
2	*	288.676	43.864	23.200	-2.136	46.000	13.055	7.609	0.000	100	21	QP
3		360.054	36.463	12.100	-9.537	46.000	16.545	7.818	0.000	200	41	QP
4		480.110	29.616	2.600	-16.384	46.000	18.994	8.022	0.000	200	89	QP
5		617.556	33.508	3.100	-12.492	46.000	21.856	8.551	0.000	200	44	QP
6		899.255	42.688	9.600	-3.312	46.000	23.840	9.248	0.000	200	336	QP

**Note:**

1. " \* ", means this data is the worst emission level.
2. Measurement Level = Reading Level + Factor(Probe+Cable-Amp).

Site: AC2	Time: 2019/01/29
Limit: FCC_Part15.209_RE(3m)	Margin: 0
Probe: AC2_3M(30-1000M)	Polarity: Vertical
EUT: Somnox Sleep Robot	Power: AC 120V/60Hz
Note: Mode 1	

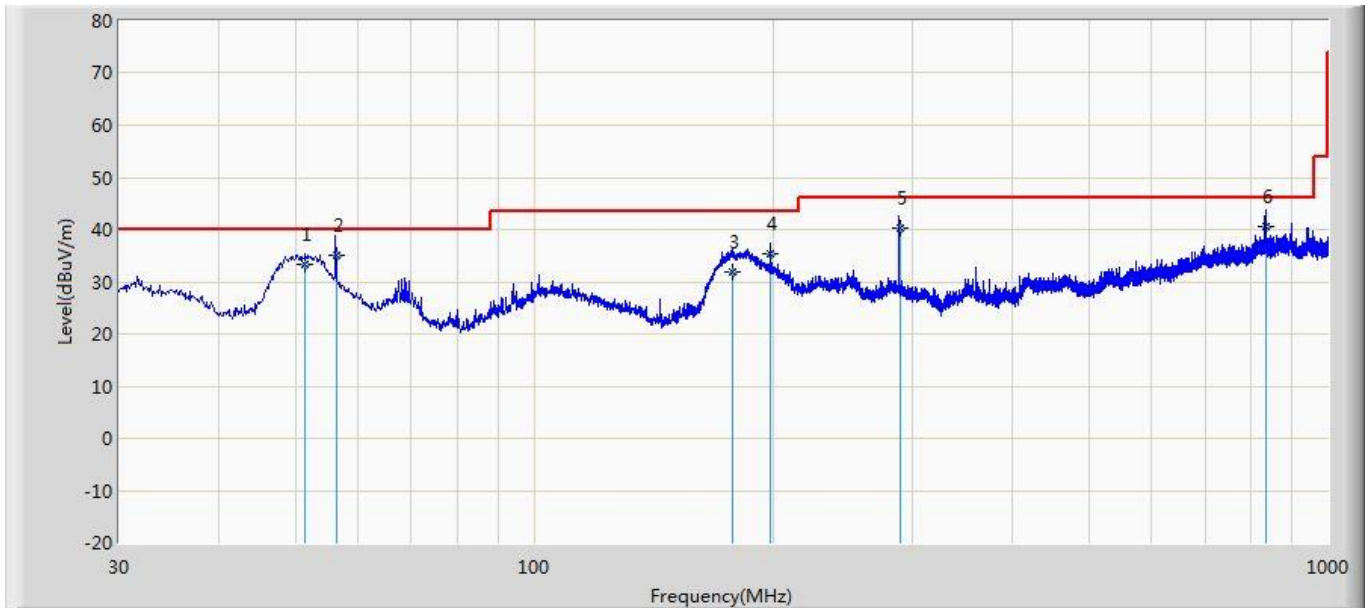

No	Mark	Frequency (MHz)	Measure Level (dBuV/m)	Reading Level (dBuV)	Over Limit (dB)	Limit (dBuV/m)	Probe (dB/m)	Cable (dB)	Amp (dB)	Ant Pos (cm)	Table Pos (deg)	Type
1		51.454	33.352	14.300	-6.648	40.000	12.483	6.569	0.000	100	79	QP
2	*	56.379	34.986	17.800	-5.014	40.000	10.531	6.655	0.000	100	125	QP
3		177.689	31.968	13.500	-11.532	43.500	11.174	7.294	0.000	100	229	QP
4		198.154	35.429	12.300	-8.071	43.500	15.792	7.337	0.000	100	54	QP
5		288.680	40.420	15.500	-5.580	46.000	17.311	7.609	0.000	100	42	QP
6		833.969	40.511	7.500	-5.489	46.000	23.920	9.092	0.000	200	359	QP

**Note:**

- " \* ", means this data is the worst emission level.
- Measurement Level = Reading Level + Factor(Probe+Cable-Amp).



## 5. Emissions in non-restricted frequency bands

### 5.1. Test Equipment

Emissions in non-restricted frequency bands / TR-8					
Instrument	Manufacturer	Type No.	Serial No.	Cal. Date	Cal. Due Date
Spectrum Analyzer	Agilent	N9010A	MY48030494	2019.02.04	2020.02.03
EXA Spectrum Analyzer	Keysight	N9010A	MY55370495	2018.04.09	2019.04.08
MXA Signal Analyzer	Keysight	N9020A	MY56060147	2018.04.09	2019.04.08
Temperature/Humidity Meter	zhichen	ZC1-2	TR8-TH	2018.04.10	2019.04.09

Note: All equipment is calibrated with traceable calibrations. Each calibration is traceable to the national or international standards.

### 5.2. Test Setup

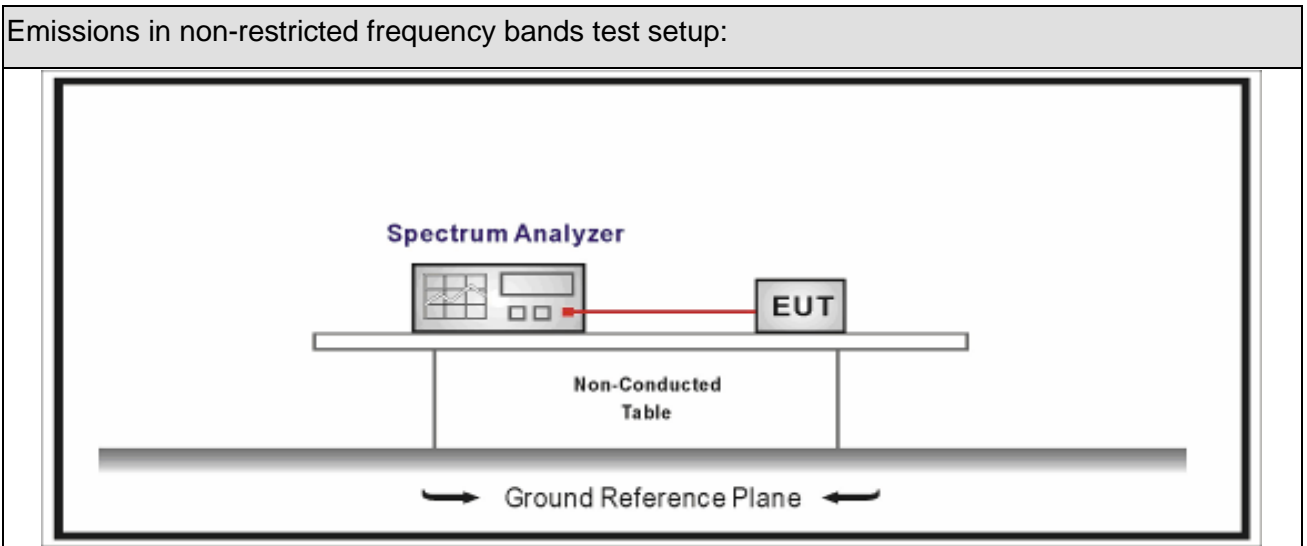



### 5.3. Limit

Un-Restricted Band Emissions Limit	
RF Output power (Detection methods)	Limit(dB)
RF Output power(Average detector)	30c(Note1)
RF Output power(PK detector)	20c(Note2)
<p>Note 1: If maximum conducted (average) output power was used to demonstrate compliance as described in 9.2, then the peak power in any 100 kHz bandwidth outside of the authorized frequency band shall be attenuated by at least 30 dB relative to the maximum in-band peak PSD level in 100 kHz (i.e., 30 dBc).</p> <p>Note 2: If the maximum peak conducted output power procedure was used, then the peak output power measured in any 100 kHz bandwidth outside of the authorized frequency band shall be attenuated by at least 20 dB relative to the maximum in-band peak PSD level in 100 kHz (i.e., 20 dBc).</p>	

### 5.4. Test Procedure

Test Method			
	References Rule	Chapter	Description
<input checked="" type="checkbox"/>	ANSI C63.10	11.11	Emissions in non-restricted frequency bands
	<input checked="" type="checkbox"/> ANSI C63.10	11.11.2	Reference level measurement
	<input checked="" type="checkbox"/> ANSI C63.10	11.11.3	Emission level measurement
<input type="checkbox"/>	ANSI C63.10	11.12	Emissions in restricted frequency bands
	<input type="checkbox"/> ANSI C63.10	11.12.1	Radiated emission measurements
	<input type="checkbox"/> ANSI C63.10	11.12.2.7	Radiated spurious emission test
<input type="checkbox"/>	ANSI C63.10	6.4	Radiated emissions from unlicensed wireless devices below 30 MHz
<input type="checkbox"/>	ANSI C63.10	6.5	Radiated emissions from unlicensed wireless devices in the frequency range of 30 MHz to 1000 MHz
<input type="checkbox"/>	ANSI C63.10	6.6	Radiated emissions from unlicensed wireless devices above 1 GHz
	<input checked="" type="checkbox"/> ANSI C63.10	11.12.2	Antenna-port conducted measurements
	<input type="checkbox"/> ANSI C63.10	11.12.2.3	Quasi-peak measurement procedure
	<input checked="" type="checkbox"/> ANSI C63.10	11.12.2.4	Peak power measurement procedure
	<input type="checkbox"/> ANSI C63.10	11.12.2.5	Average power measurement procedures
	<input type="checkbox"/> ANSI C63.10	11.12.2.5.1	Trace averaging with continuous EUT transmission at full power
	<input type="checkbox"/> ANSI C63.10	11.12.2.5.2	Trace averaging across ON and OFF times of the EUT transmissions followed by duty cycle correction
	<input type="checkbox"/> ANSI C63.10	11.12.2.5.3	Reduced VBW averaging across ON and OFF times of the EUT transmissions with max hold

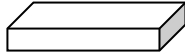
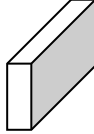
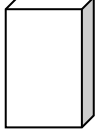
**5.5. EUT test Axis definition**

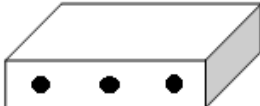
Item	Emissions in non-restricted frequency bands			
Device Category	<input type="checkbox"/>	Fixed point-to-point		
	<input type="checkbox"/>	Emit multiple directional beams, simultaneously or sequentially		
	<input checked="" type="checkbox"/>	Other cases		
Test mode	Mode 1			
Test method	<input type="checkbox"/>	Radiated		
		X Axis	Y Axis	Z Axis
				
		Worst Axis <input type="checkbox"/>	Worst Axis <input type="checkbox"/>	Worst Axis <input type="checkbox"/>
	<input checked="" type="checkbox"/>	Conducted		
	<input checked="" type="checkbox"/>	Chain 0		
				
	<input type="checkbox"/>	Chain 0	Chain 1	
				
	<input type="checkbox"/>	Chain 0	Chain 1	Chain 2
				

### 5.6. Test Result

Product Name	: Somnox Sleep Robot	Power	: AC 120V/60Hz
Test Mode	: Mode 1	Test Site	: TR-8
Test Date	: 2019.01.18		

Mode	Channel	Test Frequency (MHz)	In-Band PSD[a] (dBm/100kHz)	Frequency (MHz)	Out-Band PSD[b] (dBm/100kHz)	[a]-[b] (dB)	Limit (dB)	Result
1	00	2402	-1.106	2400.00	-42.134	41.028	>20	Pass
1	39	2480	-2.050	2500.00	-59.769	57.719	>20	Pass

Note: The worst case of Emissions in non-restricted frequency bands as below:

Mode 1 CH00 (2402MHz)

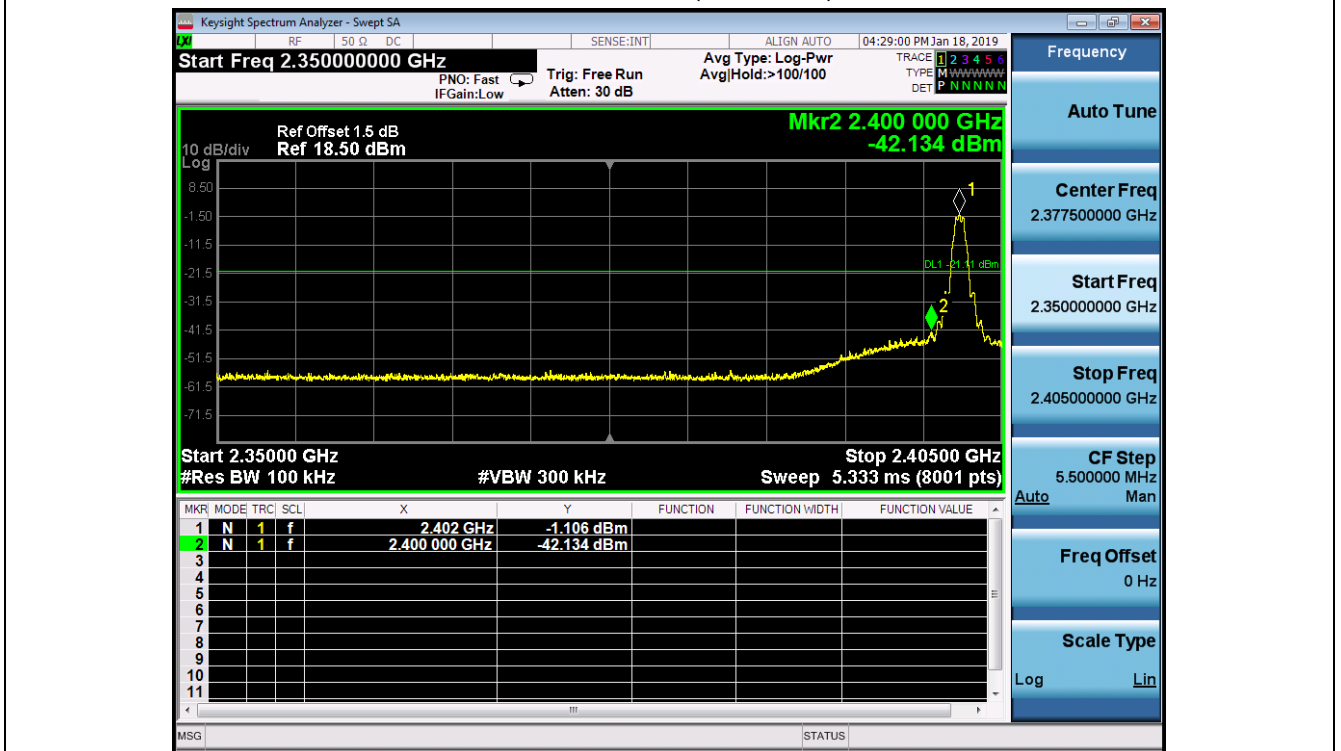

## 6. Radiated Emission Band Edge

### 6.1. Test Equipment

Radiated Emission(Above 1GHz) / AC-5					
Instrument	Manufacturer	Type No.	Serial No.	Cal. Date	Cal. Due Date
EMI Receiver	Agilent	N9038A	MY51210196	2018.07.16	2019.07.15
Pre-Amplifier	Miteq	NSP1800-25	1364185	2018.05.03	2019.05.02
DRG Horn Antenna	ETS-Lindgren	3117	00167055	2018.07.12	2019.07.11
Broad-Band Horn Antenna	Schwarzbeck	BBHA9170	294	2018.09.18	2019.09.17
Coaxial Cable	Huber+Suhner	SUCOFLEX 106	AC5-C1	2018.02.28	2019.02.27
Coaxial Cable	Huber+Suhner	SUCOFLEX 106	AC5-C2	2018.02.28	2019.02.27
Temperature/Humidity Meter	Zhichen	ZC1-2	AC5-TH	2019.01.05	2020.01.04

### 6.2. Test Setup

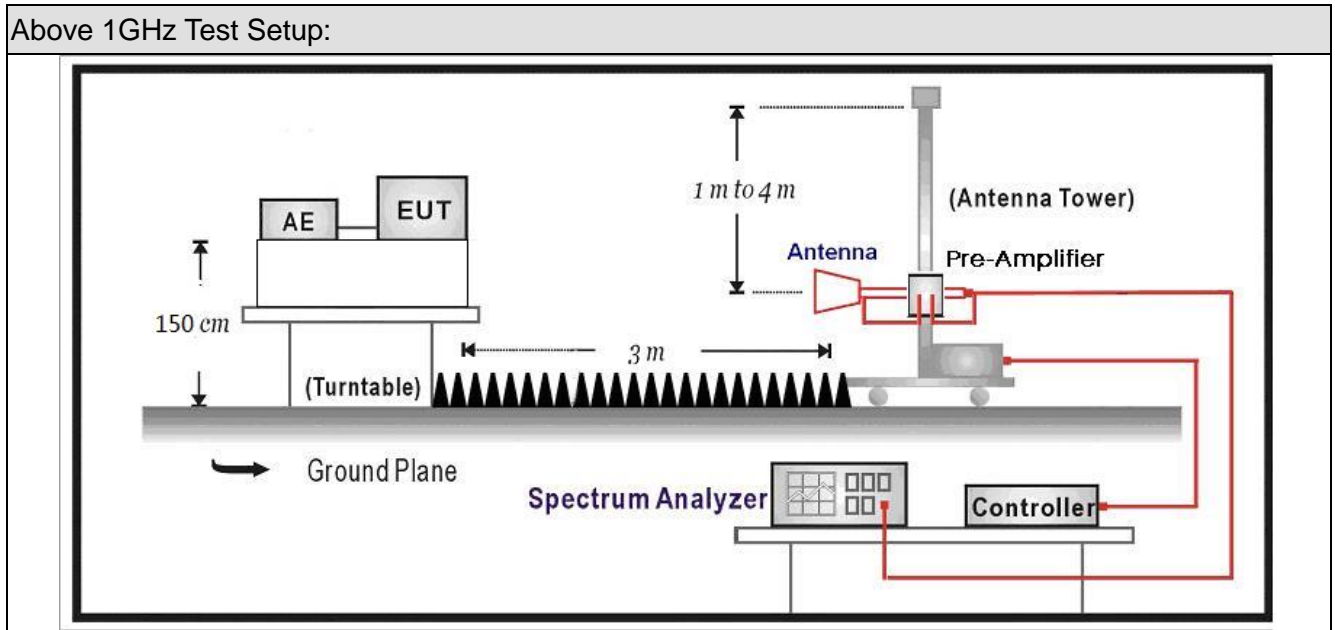

### 6.3. Limit

Band edge Limit				
Frequency bands (MHz)	Detector	Limit (dB $\mu$ V/m)	RBW (MHz)	Distance (m)
2310-2390	PK	74	1	3
2483.5-2500	AV	54	1	3





Note: The field strength of emissions appearing within these frequency bands shall not exceed the limits.

### 6.4. Test Procedure

Test Method			
	References Rule	Chapter	Description
<input checked="" type="checkbox"/>	ANSI C63.10	6.10	Band-edge testing
	<input checked="" type="checkbox"/> ANSI C63.10	6.10.5	Restricted-band band-edge measurements
	<input type="checkbox"/> ANSI C63.10	6.10.6	Marker-delta method
<input checked="" type="checkbox"/>	ANSI C63.10	11.12	Emissions in restricted frequency bands
	<input checked="" type="checkbox"/> ANSI C63.10	11.12.1	Radiated emission measurements
	<input checked="" type="checkbox"/> ANSI C63.10	11.12.2.7	Radiated spurious emission test
<input type="checkbox"/>	ANSI C63.10	6.4	Radiated emissions from unlicensed wireless devices below 30 MHz
<input type="checkbox"/>	ANSI C63.10	6.5	Radiated emissions from unlicensed wireless devices in the frequency range of 30 MHz to 1000 MHz
<input checked="" type="checkbox"/>	ANSI C63.10	6.6	Radiated emissions from unlicensed wireless devices above 1 GHz
	<input type="checkbox"/> ANSI C63.10	11.12.2.3	Quasi-peak measurement procedure
	<input checked="" type="checkbox"/> ANSI C63.10	11.12.2.4	Peak power measurement procedure
	<input checked="" type="checkbox"/> ANSI C63.10	11.12.2.5	Average power measurement procedures
	<input type="checkbox"/> ANSI C63.10	11.12.2.5.1	Trace averaging with continuous EUT transmission at full power
	<input type="checkbox"/> ANSI C63.10	11.12.2.5.2	Trace averaging across ON and OFF times of the EUT transmissions followed by duty cycle correction
	<input checked="" type="checkbox"/> ANSI C63.10	11.12.2.5.3	Reduced VBW averaging across ON and OFF times of the EUT transmissions with max hold

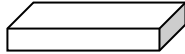
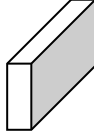
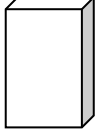

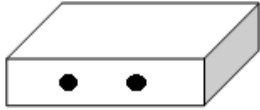
**6.5. EUT test definition**

Item	Radiated Emission Band Edge			
Device Category	<input type="checkbox"/>	Fixed point-to-point		
	<input type="checkbox"/>	Emit multiple directional beams, simultaneously or sequentially		
	<input checked="" type="checkbox"/>	Other cases		
Test mode	Mode 1			
Test method	<input checked="" type="checkbox"/>	Radiated		
		X Axis	Y Axis	Z Axis
				
		Worst Axis <input checked="" type="checkbox"/>	Worst Axis <input type="checkbox"/>	Worst Axis <input type="checkbox"/>
	<input type="checkbox"/>	Conducted		
	<input type="checkbox"/>	Chain 0		
				
	<input type="checkbox"/>	Chain 0	Chain 1	
				
	<input type="checkbox"/>	Chain 0	Chain 1	Chain 2
				

### 6.6. Duty Cycle

Test Mode	Tx On (ms)	Tx Off (ms)	Reduced VBW (kHz)	Tx On + Tx Off (ms)	Duty Cycle
BLE	0.427	0.208	2.4	0.635	67.24%

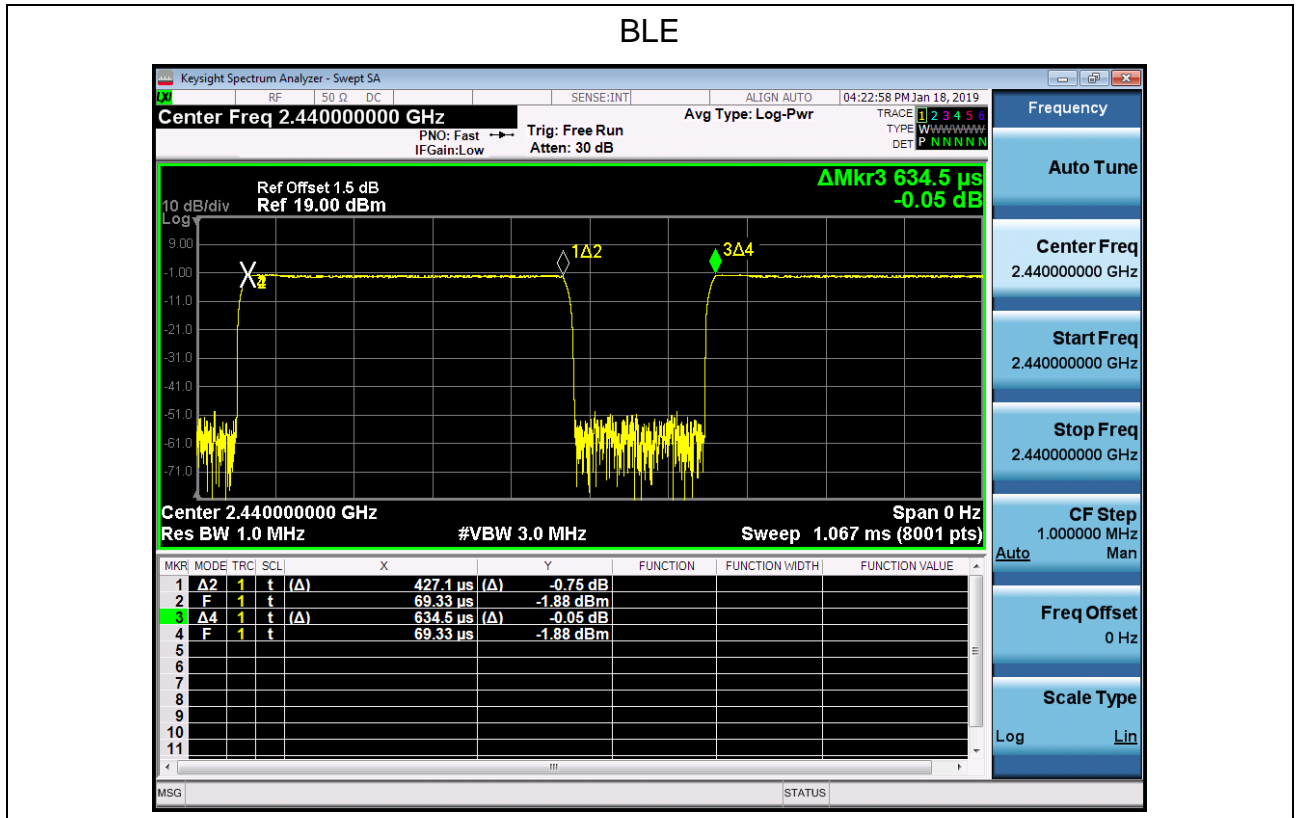

### 6.7 Test Result

Site: AC5	Time: 2019/01/14 - 22:15
Limit: FCC_Part15.209_RE(3m)	Margin: 0
Probe: Horn_3117_00167055(1-18GHz)	Polarity: Horizontal
EUT: Somnox Sleep Robot	Power: AC 120V/60Hz
Note: Mode 1:Transmit at 2402MHz by BLE	

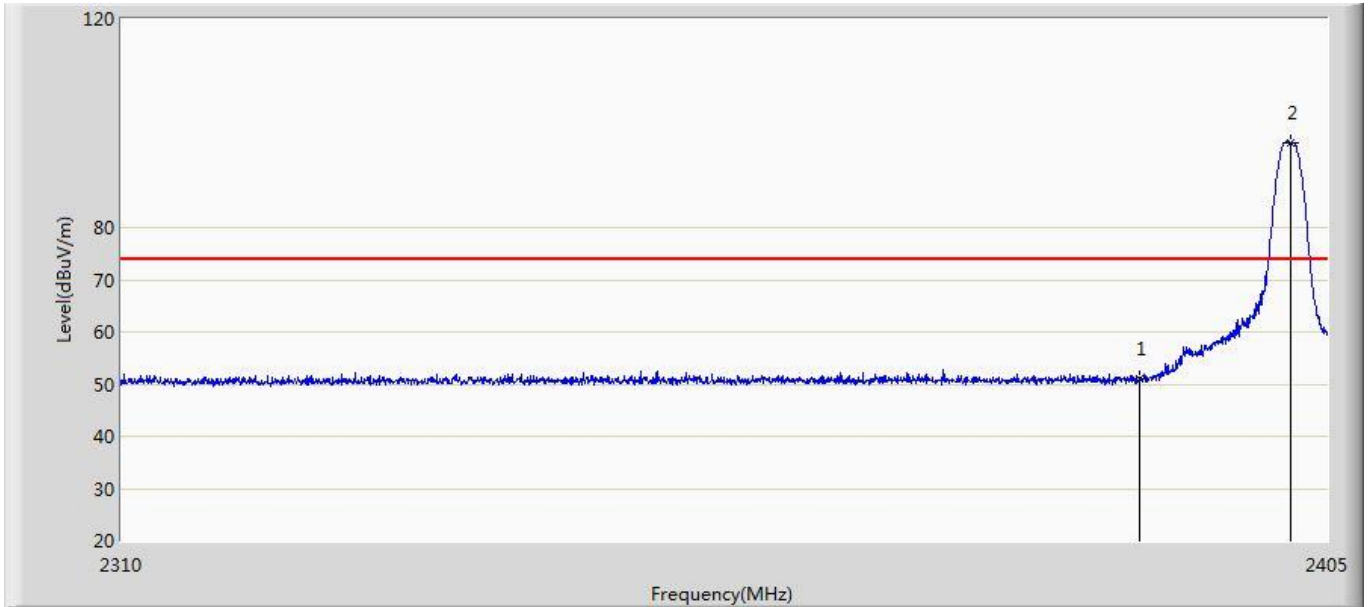

No	Mark	Frequency (MHz)	Measure Level (dBuV/m)	Reading Level (dBuV)	Over Limit (dB)	Limit (dBuV/m)	Factor (dB)	Type
1		2390.000	50.884	15.202	-23.116	74.000	35.682	PK
2	*	2402.055	96.292	60.579	N/A	N/A	35.712	PK

Site: AC5	Time: 2019/01/14 - 22:19
Limit: FCC_Part15.209_RE(3m)	Margin: 0
Probe: Horn_3117_00167055(1-18GHz)	Polarity: Horizontal
EUT: Somnox Sleep Robot	Power: AC 120V/60Hz
Note: Mode 1:Transmit at 2402MHz by BLE	

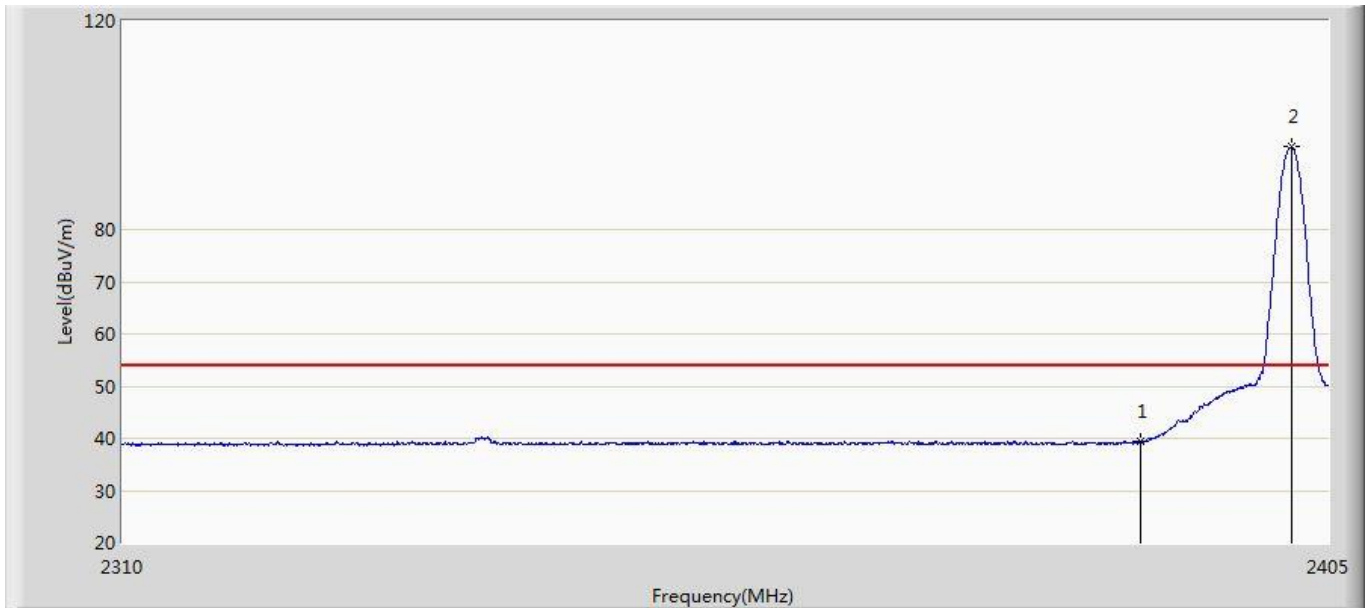

No	Mark	Frequency (MHz)	Measure Level (dBuV/m)	Reading Level (dBuV)	Over Limit (dB)	Limit (dBuV/m)	Factor (dB)	Type
1		2390.000	39.397	3.715	-14.603	54.000	35.682	AV
2	*	2402.055	95.821	60.108	N/A	N/A	35.712	AV

Site: AC5	Time: 2019/01/14 - 22:20
Limit: FCC_Part15.209_RE(3m)	Margin: 0
Probe: Horn_3117_00167055(1-18GHz)	Polarity: Vertical
EUT: Somnox Sleep Robot	Power: AC 120V/60Hz
Note: Mode 1:Transmit at 2402MHz by BLE	

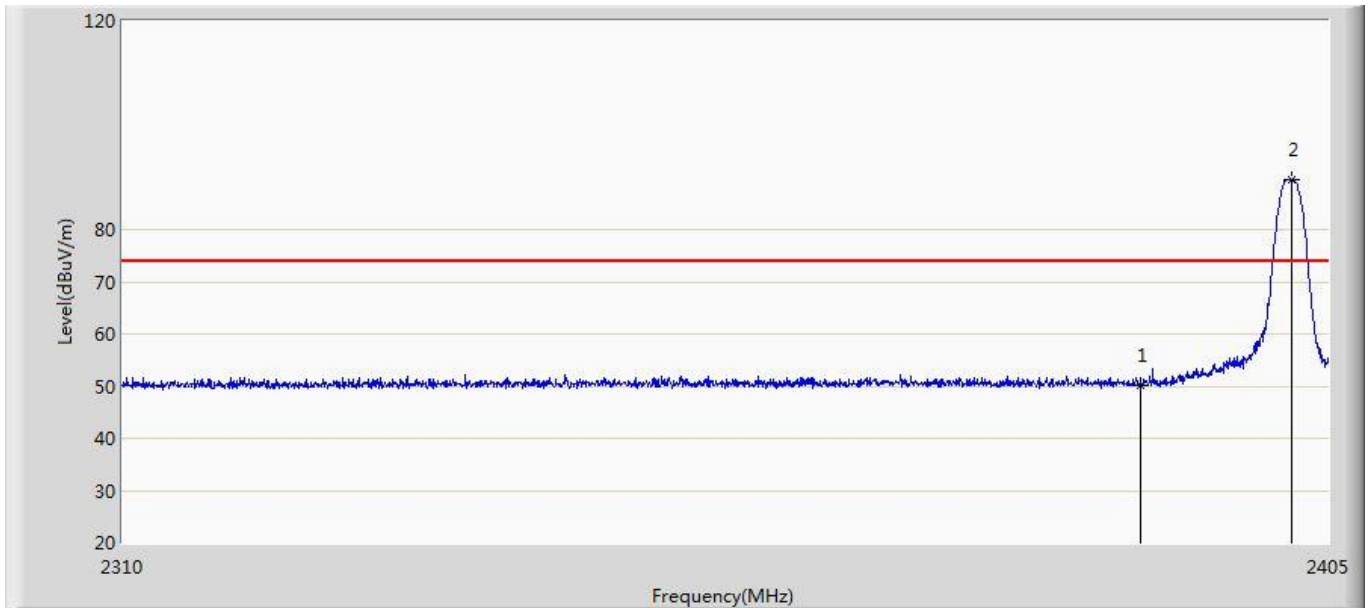

No	Mark	Frequency (MHz)	Measure Level (dBuV/m)	Reading Level (dBuV)	Over Limit (dB)	Limit (dBuV/m)	Factor (dB)	Type
1		2390.000	50.169	14.487	-23.831	74.000	35.682	PK
2	*	2402.055	89.539	53.826	N/A	N/A	35.712	PK

Site: AC5	Time: 2019/01/14 - 22:22
Limit: FCC_Part15.209_RE(3m)	Margin: 0
Probe: Horn_3117_00167055(1-18GHz)	Polarity: Vertical
EUT: Somnox Sleep Robot	Power: AC 120V/60Hz
Note: Mode 1:Transmit at 2402MHz by BLE	

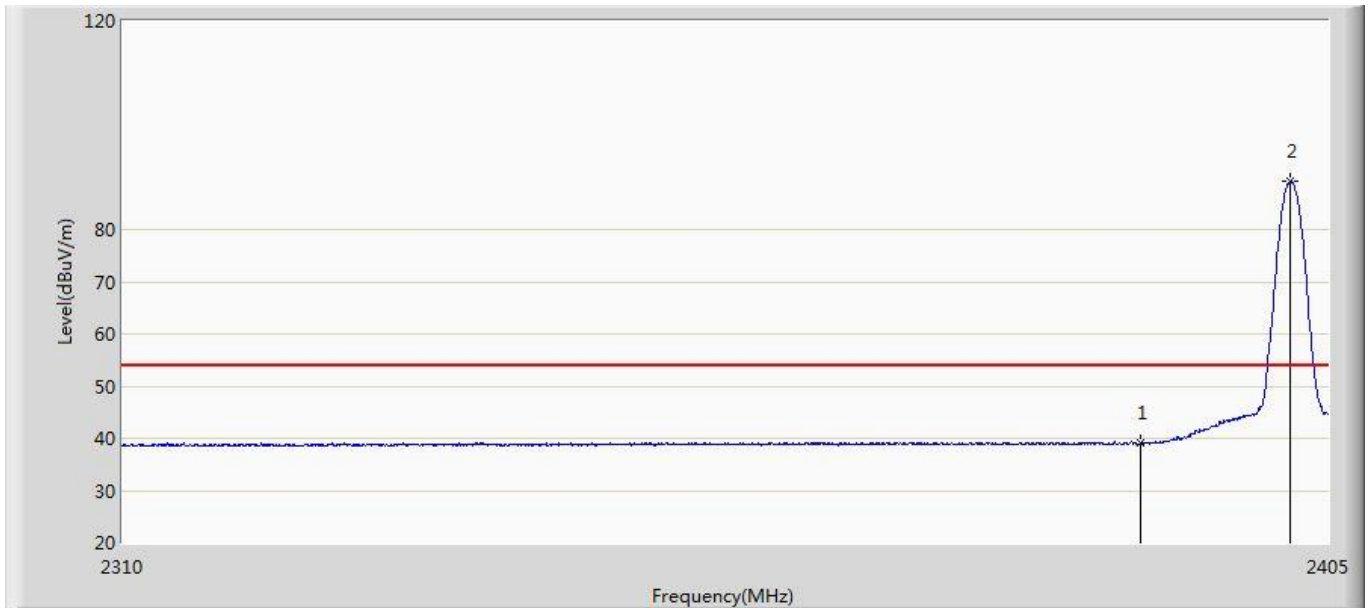

No	Mark	Frequency (MHz)	Measure Level (dBuV/m)	Reading Level (dBuV)	Over Limit (dB)	Limit (dBuV/m)	Factor (dB)	Type
1		2390.000	39.037	3.355	-14.963	54.000	35.682	AV
2	*	2401.960	89.167	53.454	N/A	N/A	35.712	AV

Site: AC5	Time: 2019/01/14 - 22:25
Limit: FCC_Part15.209_RE(3m)	Margin: 0
Probe: Horn_3117_00167055(1-18GHz)	Polarity: Horizontal
EUT: Somnox Sleep Robot	Power: AC 120V/60Hz
Note: Mode 1:Transmit at 2480MHz by BLE	

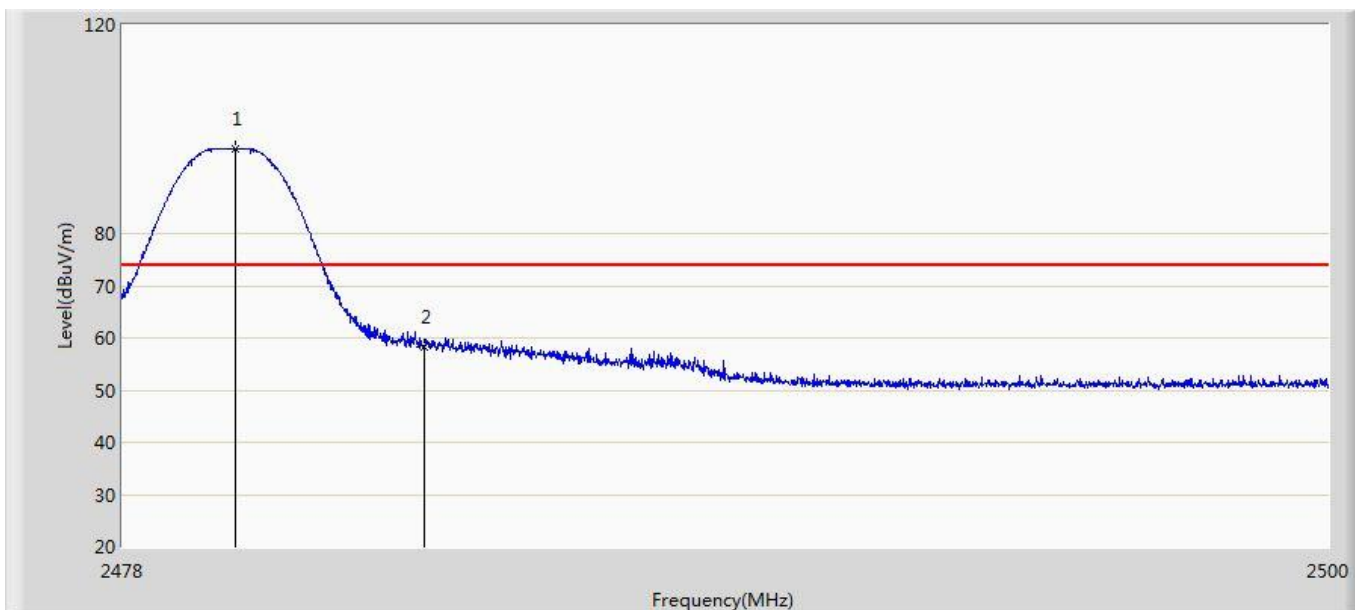

No	Mark	Frequency (MHz)	Measure Level (dBuV/m)	Reading Level (dBuV)	Over Limit (dB)	Limit (dBuV/m)	Factor (dB)	Type
1	*	2480.046	96.265	60.398	N/A	N/A	35.866	PK
2		2483.500	58.195	22.303	-15.805	74.000	35.891	PK

Site: AC5	Time: 2019/01/14 - 22:32
Limit: FCC_Part15.209_RE(3m)	Margin: 0
Probe: Horn_3117_00167055(1-18GHz)	Polarity: Horizontal
EUT: Somnox Sleep Robot	Power: AC 120V/60Hz
Note: Mode 1:Transmit at 2480MHz by BLE	

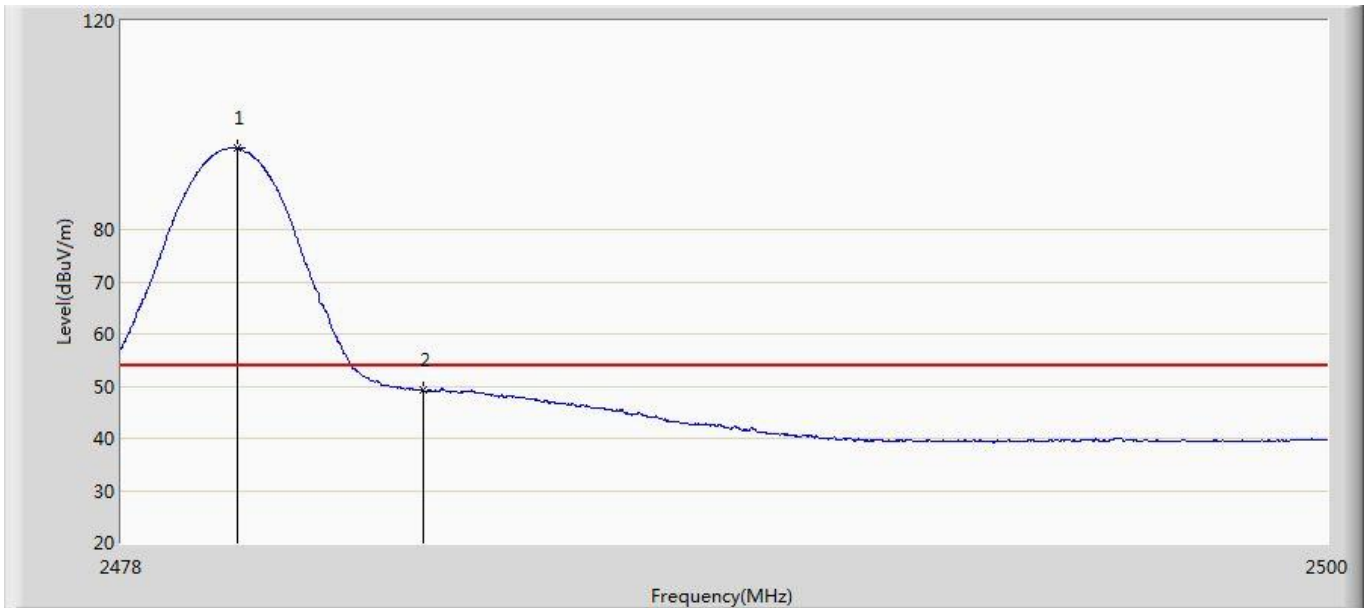

No	Mark	Frequency (MHz)	Measure Level (dBuV/m)	Reading Level (dBuV)	Over Limit (dB)	Limit (dBuV/m)	Factor (dB)	Type
1	*	2480.112	95.643	59.776	N/A	N/A	35.867	AV
2		2483.500	49.175	13.283	-4.825	54.000	35.891	AV



Site: AC5	Time: 2019/01/14 - 22:34
Limit: FCC_Part15.209_RE(3m)	Margin: 0
Probe: Horn_3117_00167055(1-18GHz)	Polarity: Vertical
EUT: Somnox Sleep Robot	Power: AC 120V/60Hz
Note: Mode 1:Transmit at 2480MHz by BLE	

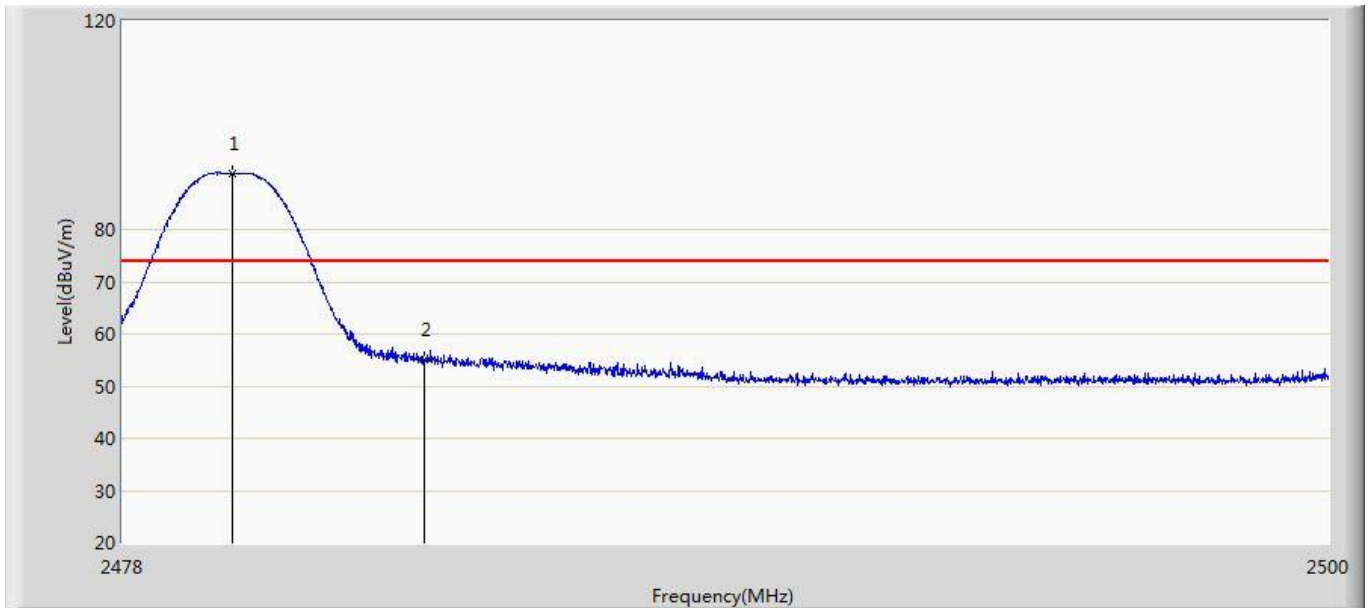

No	Mark	Frequency (MHz)	Measure Level (dBuV/m)	Reading Level (dBuV)	Over Limit (dB)	Limit (dBuV/m)	Factor (dB)	Type
1	*	2480.013	90.670	54.804	N/A	N/A	35.866	PK
2		2483.500	55.023	19.131	-18.977	74.000	35.891	PK

Site: AC5	Time: 2019/01/14 - 22:36
Limit: FCC_Part15.209_RE(3m)	Margin: 0
Probe: Horn_3117_00167055(1-18GHz)	Polarity: Vertical
EUT: Somnox Sleep Robot	Power: AC 120V/60Hz
Note: Mode 1:Transmit at 2480MHz by BLE	

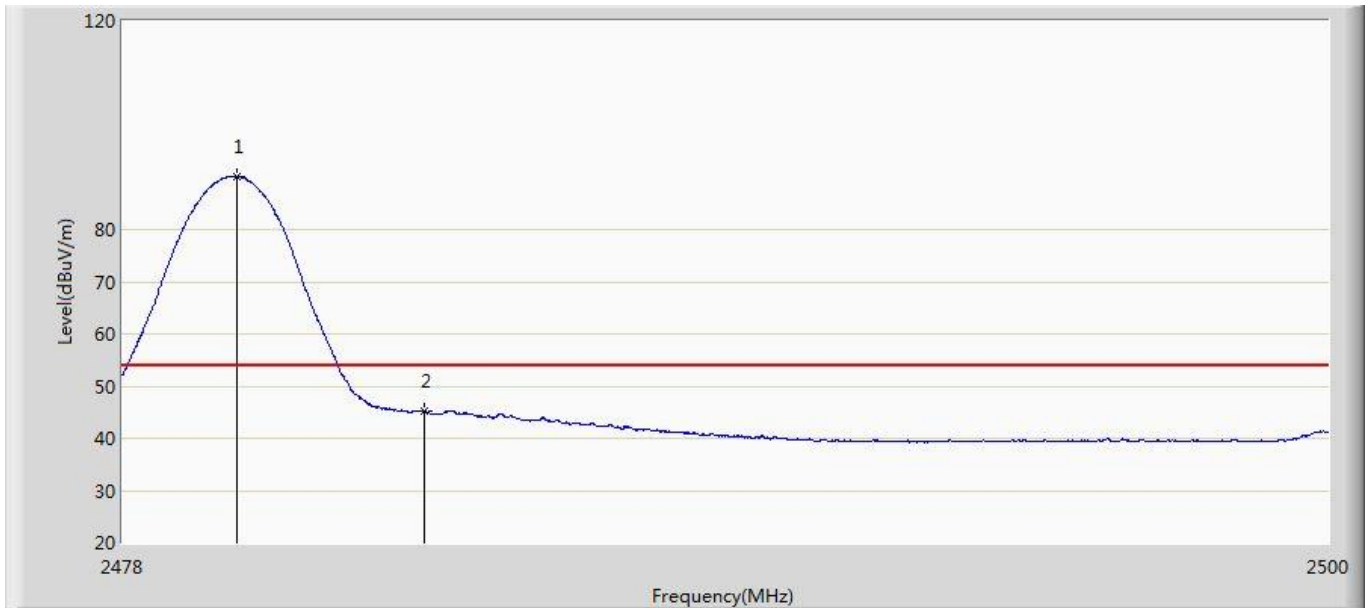

No	Mark	Frequency (MHz)	Measure Level (dBuV/m)	Reading Level (dBuV)	Over Limit (dB)	Limit (dBuV/m)	Factor (dB)	Type
1	*	2480.079	90.198	54.331	N/A	N/A	35.867	AV
2		2483.500	45.209	9.317	-8.791	54.000	35.891	AV

## 7. Occupied Bandwidth

### 7.1. Test Equipment

Occupied Bandwidth / TR-8					
Instrument	Manufacturer	Type No.	Serial No.	Cal. Date	Cal. Due Date
Spectrum Analyzer	Agilent	N9010A	MY48030494	2019.02.04	2020.02.03
EXA Spectrum Analyzer	Keysight	N9010A	MY55370495	2018.04.09	2019.04.08
MXA Signal Analyzer	Keysight	N9020A	MY56060147	2018.04.09	2019.04.08
Temperature/Humidity Meter	zhichen	ZC1-2	TR8-TH	2018.04.10	2019.04.09

Note: All equipment is calibrated with traceable calibrations. Each calibration is traceable to the national or international standards.

### 7.2. Test Setup

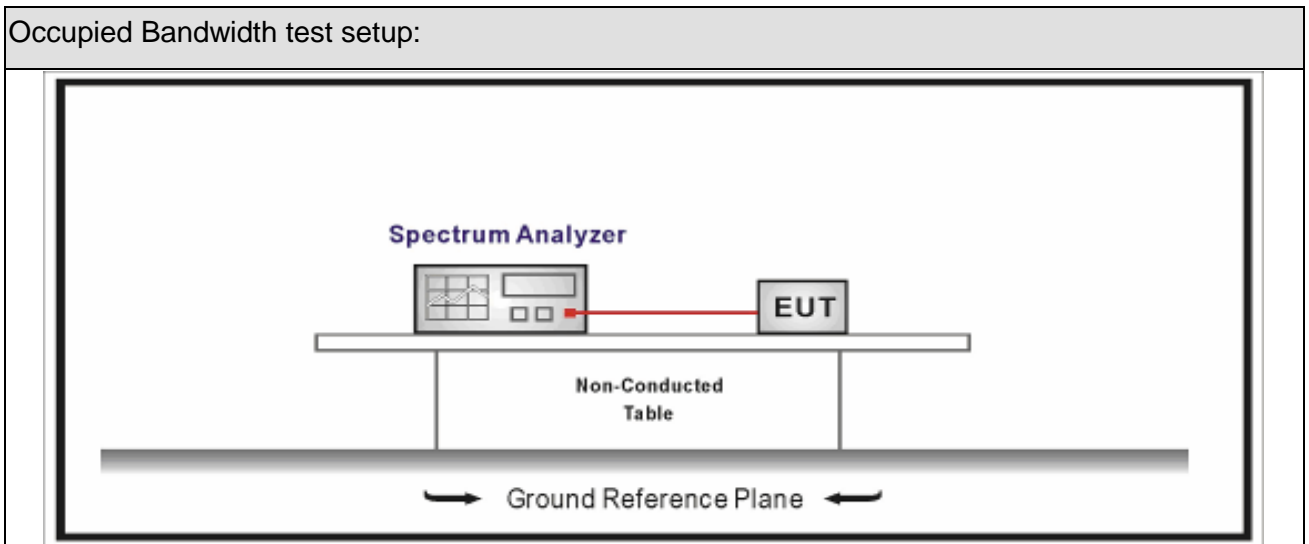



### 7.3. Limit

Occupied Bandwidth
Systems using digital modulation techniques operate in the 2400-2483.5 MHz. The minimum 6 dB bandwidth shall be at least 500 kHz

### 7.4. Test Procedure

Test Method			
	Reference Rule	Chapter	Description
<input checked="" type="checkbox"/>	ANSI C63.10	11.8	DTS bandwidth
	<input type="checkbox"/> ANSI C63.10	11.8.1	Option 1
	<input checked="" type="checkbox"/> ANSI C63.10	11.8.2	Option 2

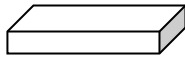
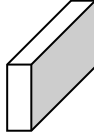
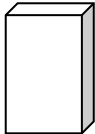
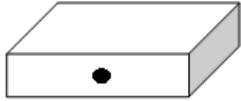
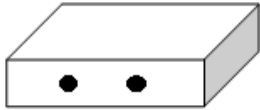
**7.5. EUT test definition**

Item	Occupied Bandwidth			
Device Category	<input type="checkbox"/>	Fixed point-to-point		
	<input type="checkbox"/>	Emit multiple directional beams, simultaneously or sequentially		
	<input checked="" type="checkbox"/>	Other cases		
Test mode	Mode 1			
Test method	<input type="checkbox"/>	Radiated		
		X Axis	Y Axis	Z Axis
				
		Worst Axis <input type="checkbox"/>	Worst Axis <input type="checkbox"/>	Worst Axis <input type="checkbox"/>
	<input checked="" type="checkbox"/>	Conducted		
	<input checked="" type="checkbox"/>	Chain 0		
				
	<input type="checkbox"/>	Chain 0	Chain 1	
				
	<input type="checkbox"/>	Chain 0	Chain 1	Chain 2
				

### 7.6. Test Result

Product Name	: Somnox Sleep Robot	Power	: AC 120V/60Hz
Test Mode	: Mode 1	Test Site	: TR-8
Test Date	: 2019.01.18		

Mode	CH.	Test Freq. (MHz)	6dB Occupied Bandwidth (kHz)	99% Occupied Bandwidth (kHz)	Limit (kHz)	Result
1	00	2402	703.0	1123.7	>500	Pass
1	19	2440	698.5	1125.9	>500	Pass
1	39	2480	693.3	1117.4	>500	Pass

Note : The worst case of Occupied Bandwidth as below:

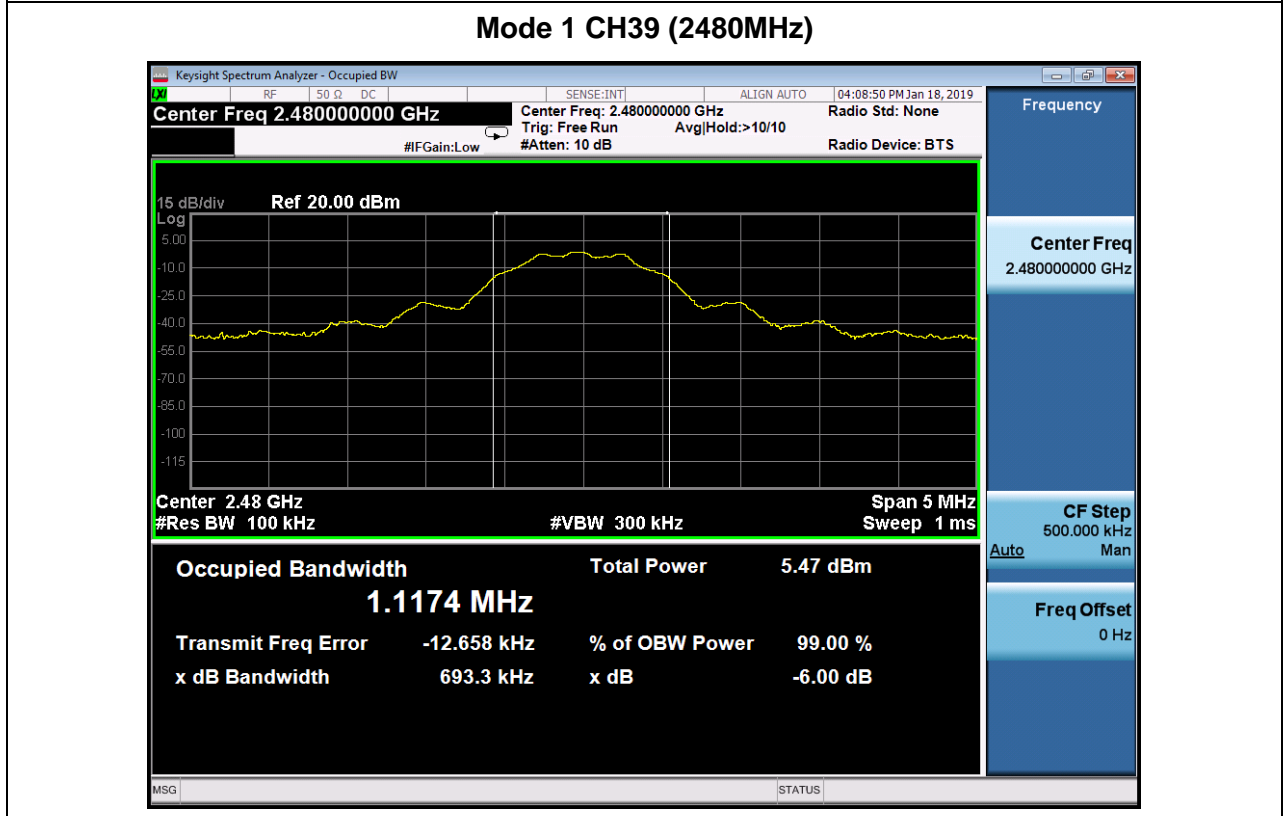

## 8. Fundamental emission output power

### 8.1. Test Equipment

Fundamental emission output power/ TR-8					
Instrument	Manufacturer	Type No.	Serial No.	Cal. Date	Cal. Due Date
Spectrum Analyzer	Agilent	E4446A	MY45300103	2019.01.04	2020.01.03
Spectrum Analyzer	Agilent	N9010A	MY48030494	2019.01.04	2020.01.03
Wideband Peak Power Meter	Anritsu	ML2495A	0905006	2018.10.14	2019.10.13
Power Sensor	Anritsu	MA2411B	0846014	2018.10.14	2019.10.13
Temperature/Humidity Meter	zhicheng	ZC1-2	TR8-TH	2018.04.10	2019.04.09

Note: All equipment is calibrated with traceable calibrations. Each calibration is traceable to the national or international standards.

### 8.2. Test Setup

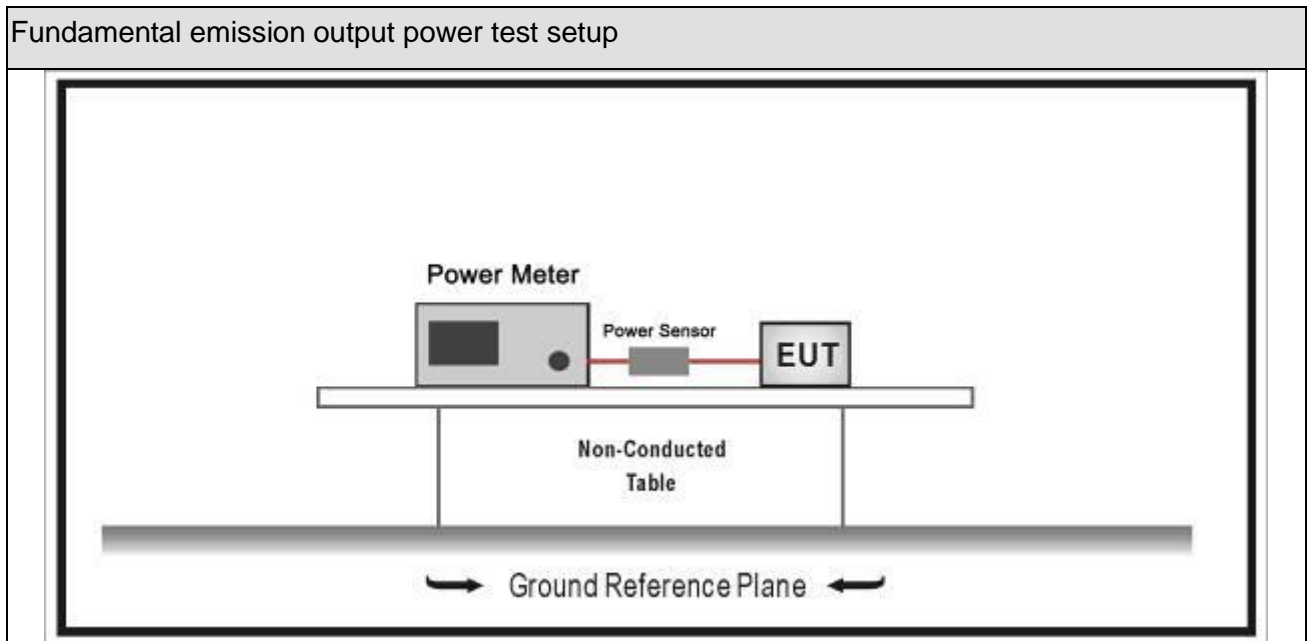

### 8.3. Limit



Fundamental emission output power Limit		
<input checked="" type="checkbox"/>	$G_{TX} < 6\text{dBi}$	$P_{out} \leq 30\text{dBm}$
<input type="checkbox"/>	$G_{TX} > 6\text{dBi}$	
<input type="checkbox"/>	Non-Fix point-point	$P_{out} \leq 30 - (G_{TX} - 6)$
<input type="checkbox"/>	Fix point-point	$P_{out} \leq 30 - [(G_{TX} - 6)]/3$
<input type="checkbox"/>	Point-to-multipoint	$P_{out} \leq 30 - (G_{TX} - 6)$
<input type="checkbox"/>	Overlap Beams	$P_{out} \leq 30 - [(G_{TX} - 6)]/3$
<input type="checkbox"/>	Aggregate power transmitted simultaneously on all beams	$P_{out} \leq 30 - [(G_{TX} - 6)]/3$
<input type="checkbox"/>	single directional beam	$P_{out} \leq 30 - [(G_{TX} - 6)]/3 + 8\text{dB}$
<p>Note 1 : <math>G_{TX}</math> directional gain of transmitting antennas.</p> <p>Note 2 : <math>P_{out}</math> is maximum peak conducted output power .</p>		



### 8.4. Test Procedure

Fundamental emission output power Test Method					
	References Rule		Chapter	Description	
<input checked="" type="checkbox"/>	ANSI C63.10		11.9	Fundamental emission output power	
	<input checked="" type="checkbox"/>	ANSI C63.10		11.9.1	Maximum peak conducted output power
	<input type="checkbox"/>	ANSI C63.10	11.9.1.1	RBW ≥ DTS bandwidth	
	<input type="checkbox"/>	ANSI C63.10	11.9.1.2	Integrated band power method	
	<input checked="" type="checkbox"/>	ANSI C63.10	11.9.1.3	PKPM1 Peak power meter method	
	<input type="checkbox"/>	ANSI C63.10		11.9.2	Maximum conducted (average) output power
	<input type="checkbox"/>	ANSI C63.10		11.9.2.2	Measurement using a spectrum analyzer (SA)
	<input type="checkbox"/>	ANSI C63.10	11.9.2.2.2	Method AVGSA-1(Duty cycle≥98%)	
	<input type="checkbox"/>	ANSI C63.10	11.9.2.2.3	Method AVGSA-1A(Duty cycle≥98%)	
	<input type="checkbox"/>	ANSI C63.10	11.9.2.2.4	Method AVGSA-2(Duty cycle≤98%)	
	<input type="checkbox"/>	ANSI C63.10	11.9.2.2.5	Method AVGSA-2A(Duty cycle≤98%)	
	<input type="checkbox"/>	ANSI C63.10	11.9.2.2.4	Method AVGSA-3	
	<input type="checkbox"/>	ANSI C63.10	11.9.2.2.5	Method AVGSA-3A	
	<input type="checkbox"/>	ANSI C63.10		11.9.2.3	Measurement using a power meter (PM)
	<input type="checkbox"/>	ANSI C63.10	11.9.2.3.1	Method AVGPM	
<input type="checkbox"/>	ANSI C63.10	11.9.2.3.2	Method AVGPM-G		

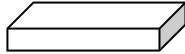
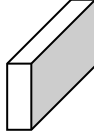
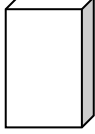
**8.5. EUT test definition**

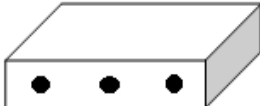
Item	Fundamental emission output power			
Device Category	<input type="checkbox"/>	Fixed point-to-point		
	<input type="checkbox"/>	Emit multiple directional beams, simultaneously or sequentially		
	<input checked="" type="checkbox"/>	Other cases		
Test mode	Mode 1			
Test method	<input type="checkbox"/>	Radiated		
		X Axis	Y Axis	Z Axis
				
		Worst Axis <input type="checkbox"/>	Worst Axis <input type="checkbox"/>	Worst Axis <input type="checkbox"/>
	<input checked="" type="checkbox"/>	Conducted		
	<input checked="" type="checkbox"/>	Chain 0		
				
	<input type="checkbox"/>	Chain 0	Chain 1	
				
	<input type="checkbox"/>	Chain 0	Chain 1	Chain 2
				

## 8.6. Test Result

Product Name	:	Somnox Sleep Robot	Power	:	AC 120V/60Hz
Test Mode	:	Mode 1	Test Site	:	TR-8
Test Date	:	2019.01.25			

Mode	Channel	Test Frequency (MHz)	Measurement Power Output (dBm)	Limit (dBm)	Result
1	00	2402	0.39	30	Pass
1	19	2440	0.97	30	Pass
1	39	2480	0.37	30	Pass

## 9. Power Spectral Density

### 9.1. Test Equipment

Power Spectral Density / TR-8					
Instrument	Manufacturer	Type No.	Serial No.	Cal. Date	Cal. Due Date
Spectrum Analyzer	Agilent	N9010A	MY48030494	2019.02.04	2020.02.03
EXA Spectrum Analyzer	Keysight	N9010A	MY55370495	2018.04.09	2019.04.08
MXA Signal Analyzer	Keysight	N9020A	MY56060147	2018.04.09	2019.04.08
Temperature/Humidity Meter	zhichen	ZC1-2	TR8-TH	2018.04.10	2019.04.09

Note: All equipment is calibrated with traceable calibrations. Each calibration is traceable to the national or international standards.

### 9.2. Test Setup

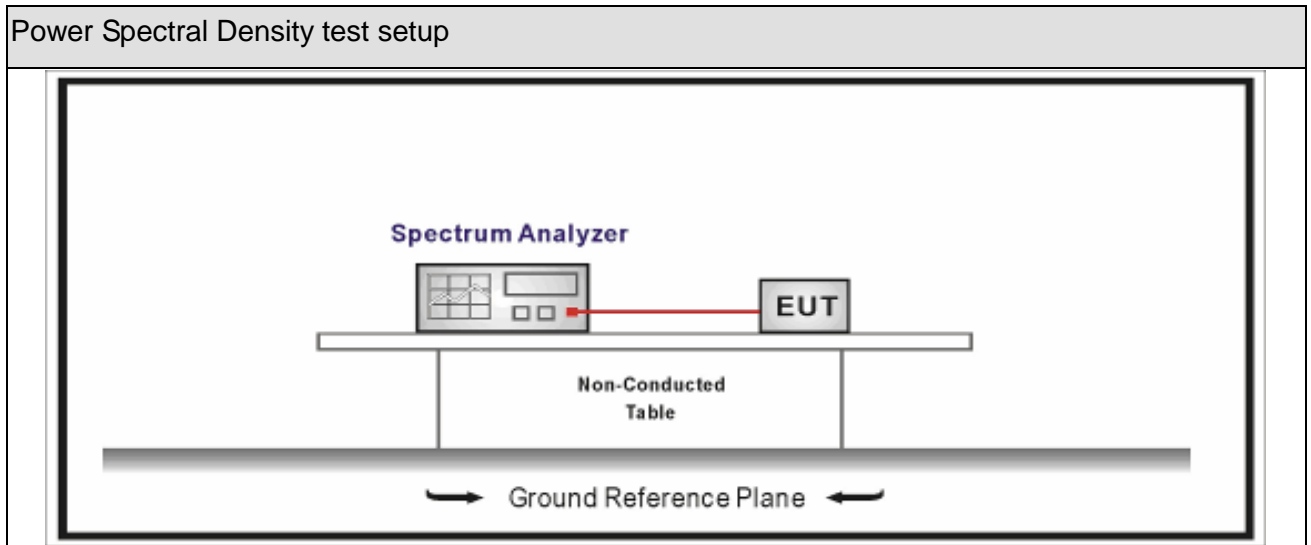

### 9.3. Limit

Power Spectral Density Limit
Power Spectral Density $\leq 8\text{dBm}/3\text{kHz}$

### 9.4. Test Procedure

Power Spectral Density Test Method			
	References Rule	Chapter	Description
<input checked="" type="checkbox"/>	ANSI C63.10	11.10	Maximum power spectral density level in the fundamental emission
<input checked="" type="checkbox"/>	ANSI C63.10	11.10.2	Method PKPSD (peak PSD)
<input type="checkbox"/>	ANSI C63.10	11.10.3	Method AVGPSD-1(Duty cycle≥98%)
<input type="checkbox"/>	ANSI C63.10	11.10.4	Method AVGPSD-1A(Duty cycle≥98%)
<input type="checkbox"/>	ANSI C63.10	11.10.5	Method AVGPSD-2(Duty cycle<98%)
<input type="checkbox"/>	ANSI C63.10	11.10.6	Method AVGPSD-2A(Duty cycle<98%)
<input type="checkbox"/>	ANSI C63.10	11.10.7	Method AVGPSD-3
<input type="checkbox"/>	ANSI C63.10	11.10.8	Method AVGPSD-3A

**9.5. EUT test definition**

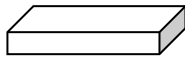
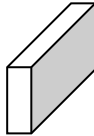
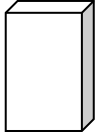
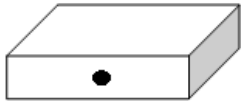
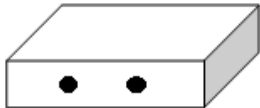
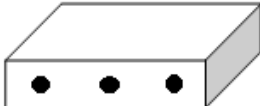
Item	Power Spectral Density Test Method			
Device Category	<input type="checkbox"/>	Fixed point-to-point		
	<input type="checkbox"/>	Emit multiple directional beams, simultaneously or sequentially		
	<input checked="" type="checkbox"/>	Other cases		
Test mode	Mode 1			
Test method	<input type="checkbox"/>	Radiated		
		X Axis	Y Axis	Z Axis
				
		Worst Axis <input type="checkbox"/>	Worst Axis <input type="checkbox"/>	Worst Axis <input type="checkbox"/>
	<input checked="" type="checkbox"/>	Conducted		
	<input checked="" type="checkbox"/>	Chain 0		
				
	<input type="checkbox"/>	Chain 0	Chain 1	
				
	<input type="checkbox"/>	Chain 0	Chain 1	Chain 2
				

### 9.6. Test Result

Product Name	: Somnox Sleep Robot	Power	: AC 120V/60Hz
Test Mode	: Mode 1	Test Site	: TR-8
Test Date	: 2019.01.18		

Mode	Channel	Test Frequency (MHz)	Measurement PSD (dBm/3kHz)	Total PSD (dBm/3kHz)	Limit (dBm/3kHz)	Result
1	00	2402	-14.238	-14.238	8	Pass
1	19	2440	-15.309	-15.309	8	Pass
1	39	2480	-15.559	-15.559	8	Pass

Note : The worst case of Power Spectral Density as below:

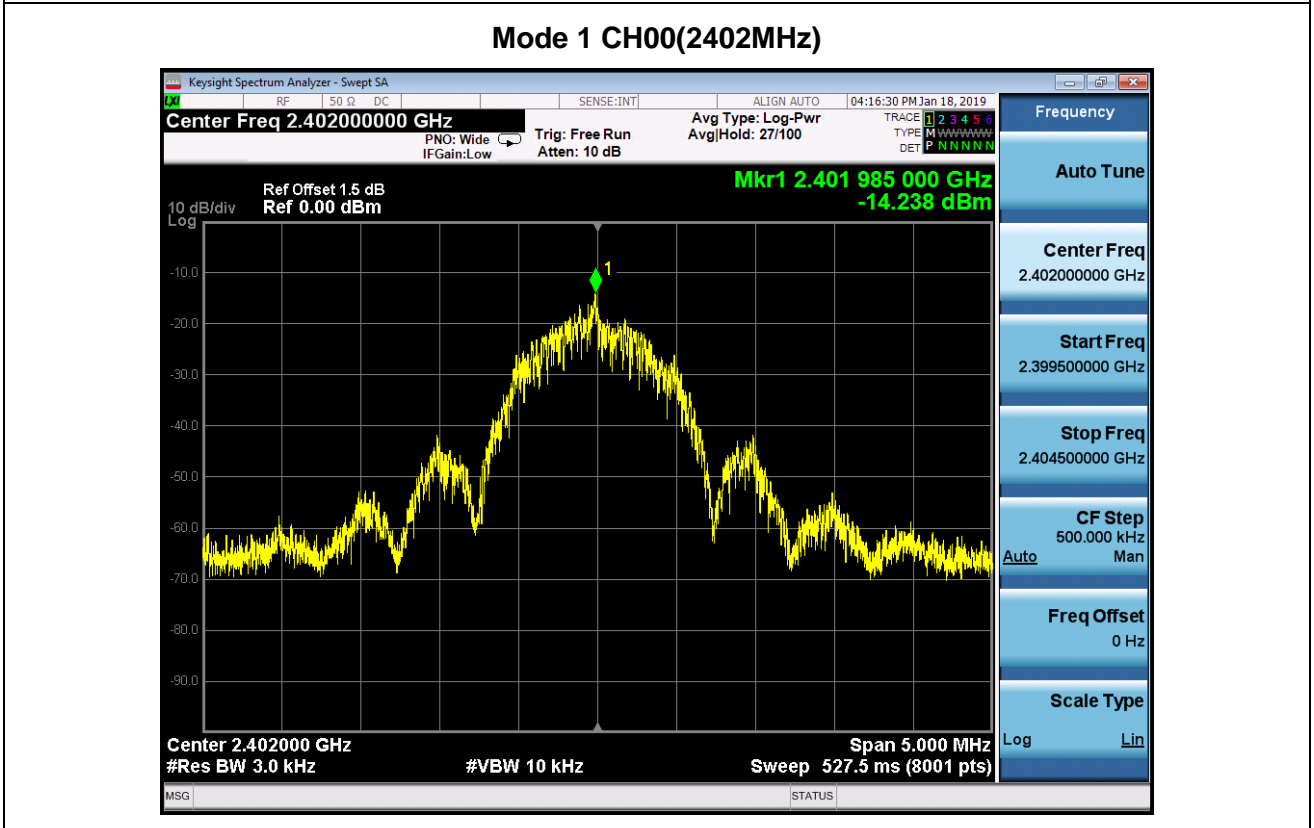

## 10. Antenna Requirement

### 10.1. Limit

Antenna Requirement Limit
<p>An intentional radiator shall be designed to ensure that no antenna other than that furnished by the responsible party shall be used with the device. The use of a permanently attached antenna or of an antenna that uses a unique coupling to the intentional radiator shall be considered sufficient to comply with the provisions of this section. The manufacturer may design the unit so that a broken antenna can be replaced by the user, but the use of a standard antenna jack or electrical connector is prohibited. This requirement does not apply to carrier current devices or to devices operated under the provisions of §15.211, §15.213, §15.217, §15.219, or §15.221. Further, this requirement does not apply to intentional radiators that must be professionally installed, such as perimeter protection systems and some field disturbance sensors, or to other intentional radiators which, in accordance with §15.31(d), must be measured at the installation site. However, the installer shall be responsible for ensuring that the proper antenna is employed so that the limits in this part are not exceeded.</p>

### 10.2. Antenna Connector Construction

Antenna Connector Construction	
<input checked="" type="checkbox"/>	The use of a permanently attached antenna
<input type="checkbox"/>	The antenna use of a unique coupling to the intentional radiator
<input type="checkbox"/>	The use of a nonstandard antenna jack or electrical connector
Please refer to the attached document "Internal Photograph" to show the antenna connector.	

\_\_\_\_\_ The End \_\_\_\_\_