

AI Flash
AB600-R

Electronic Flash with Auto Bounce Function

QUICK START GUIDE

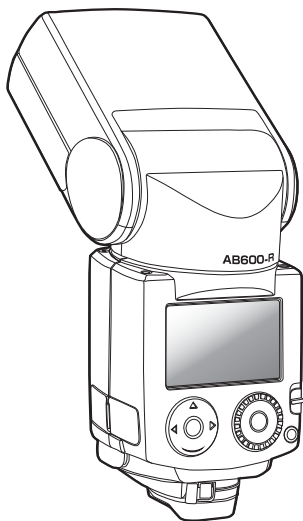

Thank you for purchasing this product. Please make sure you read this Quick Start Guide in its entirety before using this product.

Safety Precautions



Warning: ignoring the following instructions and cautions can cause fire or electric shock that may lead to serious injury or even death.

- Never attempt to disassemble and reassemble this product, as this could cause an electric shock.
- In case the exterior parts get damaged, be careful not to touch them, as this could cause an electric shock.
- Do not submerge this product in water and make sure to not touch this product with wet hands, as this can cause an electric shock or fire.
- Do not use the light-emitting part of this product near other people eyes, as there is a risk of causing vision damage.
- When using the auto bounce mode, make sure nobody is nearby before shooting. As the auto bounce mode works automatically, there is the risk of accidentally emitting light directly into people' s eyes at a very close range.
- Make sure your hands or a piece of cloth do not cover this product when using it, as this could cause a burn or may lead to fire.
- Use only compatible battery cells. Insert the battery cells properly according to the (+/-) indications. If wrongly inserted, the battery cells could explode and their corrosive liquid could leak out.
- Do not mix battery types, brands or old and new cells.
- Do not use this product in humid or dusty environments, or in the presence of flammable or explosive gasses.
- When using this product, make sure it is not pointed at people driving a vehicle, as this could cause serious accidents.
- In case you use this product on board of a plane or in medical facilities, make sure to do so strictly according to the airline company/hospital' s own regulations and indications.
- Keep this product out of reach of children.
- If by any chance the product overheats abnormally, and you detect smoke or a burning smell, stop using it immediately, store it in a place away from any flammable substance and contact our customer service.



Attention: ignoring the following instructions and cautions may lead to bodily injury or damage to property.

- Do not subject this product to any accidental and strong vibration or impact.
- When not using this product for a long time, remove any battery cells before storing it.
- Refrain from storing or leaving this product in enclosed spaces which may be subject to high temperatures, like the inside of a car, etc.
- Due to prolonged light emission, this product may get hot. In this case, make sure to not touch it, as this could cause serious burns.
- Due to prolonged light emission, the battery of this product may get hot. In this case, let it cool down sufficiently, then replace the battery cells.
- Refrain from using organic solvents, like benzene, paint thinner, alcohol etc., for the regular cleaning and maintenance of this product.
- This product uses a 2.4GHz band. Stop using this product in case it happens to influence other wireless radio stations or wireless devices nearby.

Part names

Box contents

Electronic Flash AB600-R 1x
Bounce adapter 1x
Mini stand 1x
Soft case 1x
Quick start guide
Warranty card

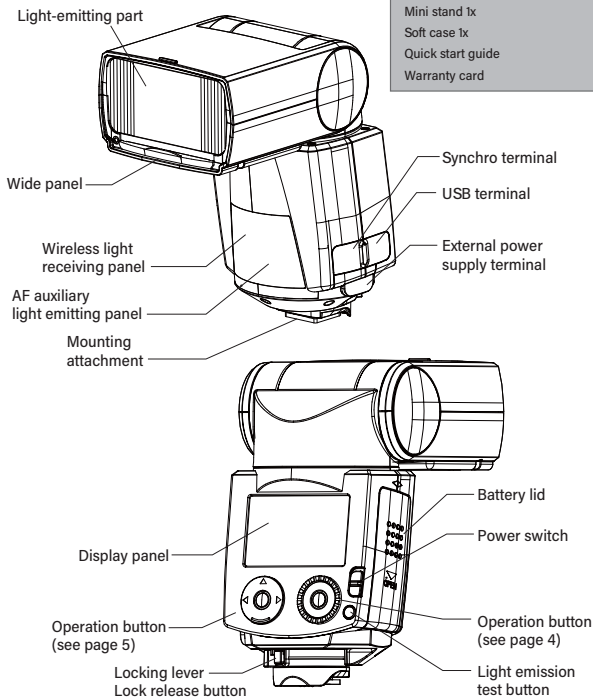

How to insert batteries

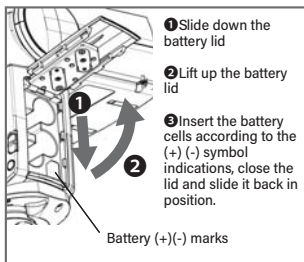

How to attach to the camera

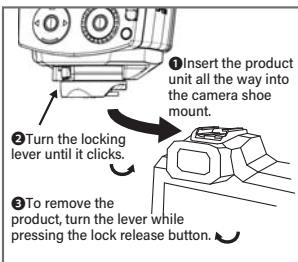

Compatible battery cells

AA type alkaline dry cell or AA type nickel-metal hydride cell (4x)

CAUTION

RISK OF EXPLOSION IF BATTERY IS REPLACED BY AN INCORRECT TYPE.
DISPOSE OF USED BATTERIES ACCORDING TO THE INSTRUCTIONS.

Main Functions and Specifications

Guide number	60 maximum (200mm, ISO100)
Angle of illumination	20mm - 200mm (18mm with wide panel installed)
Light emission mode	TTL, Manual, Multi (repeat mode)
Other light emission functions	Modeling light emission function, test light emission function
Synchro mode	High-speed sync, 1st-curtain sync, 2nd-curtain sync
Bounce mode	Auto bounce, angle lock, manual bounce
Wireless light emission	Radio wave, optical
Operation Frequency	2411MHz-2471MHz
Max. EIRP	-7.27dBm (for Europe)
Dimensions (W x H x D)	approx. 80 x 196 x 62 (mm)
Weight	approx. 470 g (without batteries)

Operations button

Circumference: wheel

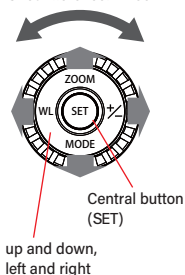

Central button (SET)	Press the central button to set the selected option. By pressing and holding the central button, enter the options setting mode.
Wheel	Use the wheel to select the black/white inverted options.
ZOOM (up)	Press on ZOOM to enter the zoom selecting mode
MODE (down)	Press on MODE to select the light emission mode
(+/-) (right side)	Press on (+/-) to enter the EV value setting mode
(WL) (left side)	By pressing and hold on WL to enter the wireless operations mode. (Please consult the instruction manual for more details) Press and holding on WL for 2 times to quit the mode

Main setting modes

Auto shooting mode

Set MODE and ZOOM as below:

MODE	ETTL (for Canon camera users) TTLB (for Nikon camera users)
ZOOM	"A" zoom

Manual shooting mode

Press MODE on the operations button (down) to switch to M mode. Set any setting unrelated to light quantity, zoom distance, etc.

About auto bounce mode

What is Bounce Flash Photography?

Bounce Flash Photography is a photographic technique in which, without hitting the shooting object directly, the photographer bounces the flash light on the ceiling or the walls, thus illuminating the object with a softer light.

Direct lighting

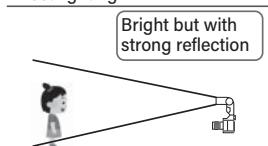

Light bounced on the ceiling

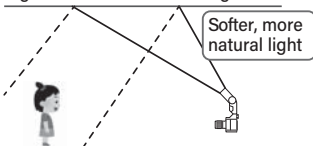

The auto bounce mode

By operating the auto bounce button while holding the camera toward the object, the light emitting part will move automatically to direct the light toward the corresponding ceiling, or the left and right walls, at the optimal bouncing angle (angle lock mode).

Auto bounce button

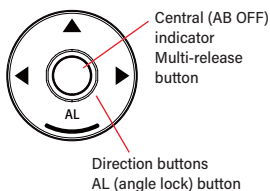

AB OFF	Press the AB OFF central button to switch off the auto bounce mode and the angle lock mode. LED colors: - Blu LED (light on): the auto bounce is working - Blu LED (flashing): angle lock mode ON - Orange LED: auto bounce mode OFF
▲▲▶▶	Auto bounce (up, left, right)
AL	Angle lock mode

Top tips

Easy Bounce Flash Photography: let the flash do the work

By simply pressing the arrow symbol corresponding to the ceiling (▲), or the left and right walls (◀▶), where you want the light to bounce on, the optimum bounce angle will be automatically set and kept.

* The flashlight unit will emit light several times in order to calculate the distance to the ceiling or the walls. It may take up to five seconds for the measurements to be complete: during this time, hold the camera firmly in the same position.

How to keep your favorite bounce angle

When the indicator is orange (auto bounce mode OFF), if you manually rotate the light-emitting part and, after the direction is set, press the AL button, the bounce direction will be kept unchanged even if you move the camera, either horizontally or vertically.

Notice



Hereby, Kenko Tokina Co., Ltd. declares that the radio equipment type AB600-R is in compliance with Directive 2014/53/EU.

The full text of the EU declaration of conformity is available at the following internet address:
<http://www.kenkoglobal.com>

FCC Compliance Statement:

changes or modifications not expressly approved by the party responsible for compliance could void the user's authority to operate the equipment.

This device complies with Part 15 of the FCC Rules. Operation is subject to the following two conditions: (1) this device may not cause harmful interference, and (2) this device must accept any interference received, including interference that may cause undesired operation.

This equipment has been tested and found to comply with the limits for a Class B digital device, pursuant to Part 15 of the FCC Rules. These limits are designed to provide reasonable protection against harmful interference in a residential installation. This equipment generates, uses and can radiate radio frequency energy and, if not installed and used in accordance with the instructions, may cause harmful interference to radio communications. However, there is no guarantee that interference will not occur in a particular installation.

If this equipment does cause harmful interference to radio or television reception, which can be determined by turning the equipment off and on, the user is encouraged to try to correct the interference by one or more of the following measures:

- Reorient or relocate the receiving antenna.
- Increase the separation between the equipment and receiver.
- Connect the equipment into an outlet on a circuit different from that to which the receiver is connected.
- Consult the dealer or an experienced radio/TV technician for help.

ISED Compliance Statement:

This device contains licence-exempt transmitter(s)/receiver(s) that comply with Innovation, Science and Economic Development Canada's licence-exempt RSS(s). Operation is subject to the following two conditions:

1. This device may not cause interference.
2. This device must accept any interference, including interference that may cause undesired operation of the device.

L' émetteur/récepteur exempt de licence contenu dans le présent appareil est conforme aux CNR d' Innovation, Sciences et Développement économique Canada applicables aux appareils radio exempts de licence. L' exploitation est autorisée aux deux conditions suivantes :

1. L' appareil ne doit pas produire de brouillage;
2. L' appareil doit accepter tout brouillage radioélectrique subi, même si le brouillage est susceptible d' en compromettre le fonctionnement.

RF Exposure Compliance:

This equipment complies with FCC/IC radiation exposure limits set forth for an uncontrolled environment. This transmitter must not be co-located or operating in conjunction with any other antenna or transmitter.

ce matériel est conforme aux limites de dose d'exposition aux rayonnements FCC/IC énoncées pour un autre environnement.cet émetteur ne doit pas être situées ou opérant conjointement avec toute autre antenne ou l'émetteur.

For Customers in Europe
CULLMANN GERMANY GMBH
Waldstraße 12, 90579 Langenzenn,

Complies with
IMDA Standards
[DA105282]

CAN ICES-3 (B)/NMB-3(B)

Supported cameras

Please consult the product page of this product.

Instruction manual

The instruction manual is available on the product page for download.

Firmware updates

Connect the unit to your PC with a regular micro USB cable and then update the firmware by following the instructions available on the product page.

Trouble shooting

The unit won' t turn on	Please check the battery cells and replace them when necessary.
No light emission	Please check there is no dust or dirt on the camera shoe mount. Make sure that the unit is firmly mounted on the camera.
I want to reset the settings	Press and hold on both the AB OFF button and SET button to restore the factory settings.
Repair	For any questions about repairs, etc., please directly contact the shop you purchased the item from.

Contacts

 Kenko Tokina Co., Ltd.

KT Nakano Building, 5-68-10, Nakano
Nakano-ku, Tokyo 164-8616, Japan
www.kenkoglobal.com



