



FCC LISTED, REGISTRATION
NUMBER: 2764.01

ISED LISTED REGISTRATION
NUMBER: 23595-1

Test report No:
2395ERM.001A1

Test report

REFERENCE STANDARD:
USA FCC Part 27
CANADA ISED RSS-139, RSS-130

Identification of item tested	Wireless Module
Trademark	Telit
Model and /or type reference	LE866SV1 [Marketing name: LE866-SV1]
Other identification of the product	FCC ID: RI7LE866SV1A IC: 5131A-LE866SV1A HW Version: 1.0
Features	LTE module CAT1
Manufacturer	Telit Communications S.p.A. Via Stazione di Prosecco 5/b 34010 SGONICO TRIESTE - ITALY
Test method requested, standard	USA FCC Part 27 10-1-18 Edition CANADA IC RSS-139 Issue 3, Jul. 2015. CANADA IC RSS-130 Issue 2, Feb. 2019. Measurement Guidance 971168 D01 v02r02 for certification of Licensed Digital Transmitters. ANSI C63.26 – 2015.
Summary	IN COMPLIANCE
Approved by (name / position & signature)	Domingo Galvez EMC&RF Lab Manager
Date of issue	05-06-2019
Report template No	FDT08_21

Index

Competences and guarantees	3
General conditions	3
Uncertainty	3
Data provided by the client.....	4
Usage of samples	4
Test sample description	4
Identification of the client.....	6
Testing period and place.....	6
Document history	6
Modifications to the reference test report	6
Environmental conditions	7
Remarks and comments	7
Testing verdicts.....	8
Summary	8
List of equipment used during the test.....	9
Appendix A: Test Results for.....	10

Competences and guarantees

DEKRA Certification Inc. is a testing laboratory accredited by A2LA (The American Association for Laboratory Accreditation), to perform the tests indicated in the Certificate 2764.01.

DEKRA Certification Inc. is a testing laboratory competent to carry out the tests described in this report.

In order to assure the traceability to other national and international laboratories, DEKRA Certification Inc. has a calibration and maintenance program for its measurement equipment.

DEKRA Certification Inc. guarantees the reliability of the data presented in this report, which is the result of the measurements and the tests performed to the item under test on the date and under the conditions stated on the report and, it is based on the knowledge and technical facilities available at DEKRA Certification at the time of performance of the test.

DEKRA Certification Inc. is liable to the client for the maintenance of the confidentiality of all information related to the item under test and the results of the test.

The results presented in this Test Report apply only to the particular item under test established in this document.

IMPORTANT: No parts of this report may be reproduced or quoted out of context, in any form or by any means, except in full, without the previous written permission of DEKRA Certification Inc.

General conditions

1. This report is only referred to the item that has undergone the test.
2. This report does not constitute or imply on its own an approval of the product by the Certification Bodies or competent Authorities.
3. This document is only valid if complete; no partial reproduction can be made without previous written permission of DEKRA Certification Inc.
4. This test report cannot be used partially or in full for publicity and/or promotional purposes without previous written permission of DEKRA Certification Inc. and the Accreditation Bodies.

Uncertainty

Uncertainty (factor $k=2$) was calculated according to the DEKRA Certification internal document PODT000.

Frequency (MHz)	U(k=2)	Units
30-180	3.82	dB
180-1000	2.61	dB
1000-18000	2.92	dB
18000-40000	2.15	dB

Data provided by the client

LTE module CAT1 supports LTE bands 4 and 13.

DEKRA declines any responsibility with respect to the information provided by the client and that may affect the validity of results.

Usage of samples

Samples undergoing test have been selected by: The client.

Sample S/01 is composed of the following elements:

Control N°	Description	Model	Serial N°	Date of reception
2395.04	Telit Sample	LE866-SV1	IMEI:352613079011577	12/19/2018
2201.04	Cradle kit	N/A	13990002537	05/29/2018
2201.05	Antenna	N/A	N/A	05/29/2018
2201.06	Antenna	N/A	N/A	05/29/2018

1. Sample S/01 has undergone following test(s):

All conducted and radiated tests indicated in appendix A.

Test sample description

Ports..... :	Port name and description	Cable			
		Specified max length [m]	Attached during test	Shielded	Coupled to patient ⁽³⁾
			<input type="checkbox"/>	<input type="checkbox"/>	<input type="checkbox"/>
			<input type="checkbox"/>	<input type="checkbox"/>	<input type="checkbox"/>
			<input type="checkbox"/>	<input type="checkbox"/>	<input type="checkbox"/>
			<input type="checkbox"/>	<input type="checkbox"/>	<input type="checkbox"/>
Supplementary information to the ports..... :	No data provided				

Rated power supply	Voltage and Frequency		Reference poles			
			L1	L2	L3	N
	<input type="checkbox"/>	AC:	<input type="checkbox"/>	<input type="checkbox"/>	<input type="checkbox"/>	<input type="checkbox"/>
	<input type="checkbox"/>	AC:	<input type="checkbox"/>	<input type="checkbox"/>	<input type="checkbox"/>	<input type="checkbox"/>
	<input checked="" type="checkbox"/>	DC: 3.8 V				
Rated Power	No data provided					
Clock frequencies	No data provided					
Other parameters	No data provided					
Software version	No data provided					
Hardware version	No data provided					
Dimensions in cm (W x H x D)	No data provided					
Mounting position	<input type="checkbox"/>	Table top equipment				
	<input type="checkbox"/>	Wall/Ceiling mounted equipment				
	<input type="checkbox"/>	Floor standing equipment				
	<input type="checkbox"/>	Hand-held equipment				
	<input checked="" type="checkbox"/>	Other: Module				
Modules/parts	Module/parts of test item		Type	Manufacturer		
	LTE Antenna Type no T—AT305 [Frequency: 700 - 960MHz / 1710 - 2700 MHz]		Cellular	ATEL-CAB		
	LTE Antenna Type no T—AT305 [Frequency: 700 - 960MHz / 1710 - 2700 MHz]		Cellular	ATEL-CAB		
Accessories (not part of the test item)	Description		Type	Manufacturer		
	No data provided					
Documents as provided by the applicant	Description		File name	Issue date		
	No data provided					

Copy of marking plate:



Identification of the client

TELIT COMMUNICATIONS S.P.A.

Via Stazione di Prosecco 5/b – 34010 – Sgonico – Trieste, Italy

Testing period and place

Test Location	DEKRA Certification, Inc.
Date (start)	01-07-2019
Date (finish)	01-25-2019

Document history

Report number	Date	Description
2395ERM.001	01-31-2019	First release
2395ERM.001A1	05-06-2019	2 nd release

Modifications to the reference test report

It was introduced the following modifications in respect to the test report number 2304ERM.001 related with the same samples, in the next clauses and sub-clauses:

Clauses/ Sub-Clauses	Modification	Justification
Page 45/ Occupied Bandwidth	RBW and screenshot modified	According to the OBW defined

Environmental conditions

In the control chamber, the following limits were not exceeded during the test:

Temperature	Min. = 15 °C Max. = 35 °C
Relative humidity	Min. = 30 % Max. = 75 %
Air pressure	Min. = 860 mbar Max. = 1060 mbar

In the semi anechoic chamber, the following limits were not exceeded during the test.

Temperature	Min. = 15 °C Max. = 35 °C
Relative humidity	Min. = 30 % Max. = 75 %
Air pressure	Min. = 860 mbar Max. = 1060 mbar

In the chamber for conducted measurements, the following limits were not exceeded during the test:

Temperature	Min. = 15 °C Max. = 35 °C
Relative humidity	Min. = 30 % Max. = 60 %
Air pressure	Min. = 860 mbar Max. = 1060 mbar

Remarks and comments

The tests have been performed by the technical personnel: Sravani Gollamudi and Koji Nishimoto.

Testing verdicts

Not applicable :	N/A
Pass :	P
Fail :	F
Not measured :	N/M

Summary

FCC PART 27 /IC RSS-139/IC RSS-130/ PARAGRAPH					
Report Section	Part 27 Spec Clause	RSS Spec Clause	Test Description	Verdict	Remark
A.1	§2.1046 and §27.50	RSS-139 Clause 6.5/ RSS-130 Clause 4.6	RF Output power	P	N/A
A.2	§2.1047 and §27.50	RSS-139 Clause 6.2/ RSS-130 Clause 4.2	Modulation characteristics	P	N/A
A.3	§2.1055 and §27.54	RSS-139 Clause 6.4/ RSS-130 Clause 4.5	Frequency stability	P	N/A
A.4	§ 2.1049	RSS-139 Clause 6.4/ RSS-130 Clause 4.5	Occupied Bandwidth	P	N/A
A.5	§2.1051 and §27.53	RSS-139 Clause 6.6/ RSS-130 Clause 4.7	Spurious emissions at antenna terminals	P	N/A
A.6	§ 27.53	RSS-139 Clause 6.6/ RSS-130 Clause 4.7	Spurious emissions at antenna terminals at Block edges	P	N/A
A.7	§2.1053 and §27.53	RSS-139 Clause 6.6/ RSS-130 Clause 4.7	Radiated emissions	P	N/A
<u>Supplementary information and remarks:</u>					
N/A					

List of equipment used during the test

Conducted Measurements

Test system Rohde & Schwarz TS 8997:

CONTROL NUMBER	DESCRIPTION	MANUFACTURER	MODEL	LAST CALIBRATION	NEXT CALIBRATION
1039	Signal Analyzer	ROHDE & SCHWARZ	FSV40	2017/03	2019/03
1149	Wideband Radio Communication Tester	ROHDE & SCHWARZ	CMW500	2018/07	2020/07
1041	EMI Test Receiver	ROHDE & SCHWARZ	ESR7	2017/04	2019/03
1042	RF generator	ROHDE & SCHWARZ	SMBV100A	2018/01	2019/01
0101	Climatic Chamber	ESPEC NA	ESL-2CA	2019/01	2020/01

Radiated Measurements

CONTROL NUMBER	DESCRIPTION	MANUFACTURER	MODEL	LAST CALIBRATION	NEXT CALIBRATION
1014	Signal Analyzer	ROHDE & SCHWARZ	FSV40	2017/03	2019/03
1012	EMI Test Receiver	ROHDE & SCHWARZ	ESR26	2018/09	2020/09
1058	Double Ridged Waveguide Horn Antenna	ETS LINDGREN	3115	2017/03	2020/03
1055	Double Ridged Waveguide Horn Antenna	ETS LINDGREN	3116C	2016/12	2019/12
1065	Biconilog Antenna	ETS LINDGREN	3142E	2017/03	2020/03
0981	Preamplifier	BONN ELEKTRONIK	BLMA 0118-2A	2017/05	2019/05
0980	Preamplifier	BONN ELEKTRONIK	BLNA 0360-01N	2017/05	2019/05
0982	Preamplifier	BONN ELEKTRONIK	BLMA1840-1M	2017/05	2019/05
1017	EMC measurement software	ROHDE & SCHWARZ	EMC32 V9.01	---	---

Appendix A: Test Results for FCC Part 27/ IC RSS-139/ IC RSS-130

Appendix A Content

PRODUCT INFORMATION	12
DESCRIPTION OF TEST CONDITIONS	13
TEST A.1: RF OUTPUT POWER.....	15
TEST A.2: MODULATION CHARACTERISTICS	39
TEST A.3: FREQUENCY STABILITY	42
TEST A.4: OCCUPIED BANDWIDTH	45
TEST A.5: SPURIOUS EMISSIONS AT ANTENNA TERMINALS.....	81
TEST A.6: SPURIOUS EMISSIONS AT ANTENNA TERMINALS AT BLOCK EDGES.....	92
TEST A.7: RADIATED EMISSIONS.....	107

PRODUCT INFORMATION

The following information is provided by the client

Information	Description
Modulation	QPSK, QAM
Maximum RF Output Power	23 dBm
Operation mode:	
- Operating Frequency Range	Band 4: 1712.5-1752.5 MHz Band 13: 779.5-784.5 MHz
- Nominal Channel Bandwidth	Band 4: 5/ 10/ 15/ 20 MHz Band 13: 5/ 10 MHz
Extreme operating conditions	
- Temperature range	$T_{nom} = +15$ to $+35$ $T_{min} = -30$ $T_{max} = +50$
Antenna type	External attachable Antenna. Equipment with 1 TX/RX antenna and 1 RX (diversity) antenna
Antenna gain	2.14 dBi
Nominal Voltage	
- Supply Voltage	3.8 Vdc
- Type of power source	DC voltage from power supply.
Equipment type	LTE module CAT1

DESCRIPTION OF TEST CONDITIONS

The worst case was found when positioned as the table below. Following channel(s) was (were) selected for the final test as listed below:

TEST CONDITIONS	DESCRIPTION										
<p>TC#01 LTE Band 4</p>	<p><u>Power supply (V):</u> $V_{\text{nominal}} = 3.8 \text{ Vdc}$</p> <p><u>Test Frequencies for Conducted tests:</u></p> <p><u>5 MHz Bandwidth:</u> -Lowest Channel: 19975(1712.5 MHz) -Middle Channel: 20175(1732.5 MHz) -Highest Channel: 20375(1752.5 MHz)</p> <p><u>10 MHz Bandwidth:</u> -Lowest Channel: 20000(1715 MHz) -Middle Channel: 20175(1732.5 MHz) -Highest Channel: 20350(1750 MHz)</p> <p><u>15 MHz Bandwidth:</u> -Lowest Channel: 20025(1717.5 MHz) -Middle Channel: 20175(1732.5 MHz) -Highest Channel: 20325(1747.5 MHz)</p> <p><u>20 MHz Bandwidth:</u> -Lowest Channel: 20050(1720 MHz) -Middle Channel: 20175(1732.5 MHz) -Highest Channel: 20300(1745 MHz)</p> <p><u>Test Frequencies for Radiated tests:</u></p> <table border="1" data-bbox="411 1615 1334 1776"> <thead> <tr> <th>Available Frequencies</th> <th>Tested Frequency</th> <th>Channel Bandwidth</th> <th>Modulation</th> <th>Mode</th> </tr> </thead> <tbody> <tr> <td>1712.5 to 1752.5 MHz</td> <td>1732.5 MHz</td> <td>5 MHz</td> <td>QPSK</td> <td>1 RB</td> </tr> </tbody> </table> <p>Note: This device was tested under all bandwidths, RB configurations and modulations. The worst case found in QPSK modulation.</p>	Available Frequencies	Tested Frequency	Channel Bandwidth	Modulation	Mode	1712.5 to 1752.5 MHz	1732.5 MHz	5 MHz	QPSK	1 RB
Available Frequencies	Tested Frequency	Channel Bandwidth	Modulation	Mode							
1712.5 to 1752.5 MHz	1732.5 MHz	5 MHz	QPSK	1 RB							

TEST CONDITIONS	DESCRIPTION										
<p>TC#02 LTE Band 13</p>	<p>Power supply (V): $V_{\text{nominal}} = 3.8 \text{ Vdc}$</p> <p>Test Frequencies for Conducted tests: <u>5 MHz Bandwidth:</u> -Lowest Channel: 23205(779.5 MHz) -Middle Channel: 23230(782 MHz) -Highest Channel: 23255(784.5 MHz) <u>10 MHz Bandwidth:</u> -Lowest Channel: N/A -Middle Channel: 23230 (782 MHz) -Highest Channel: N/A</p> <p>Test Frequencies for Radiated tests:</p> <table border="1" data-bbox="411 1099 1331 1256"> <thead> <tr> <th>Available Frequencies</th> <th>Tested Frequency</th> <th>Channel Bandwidth</th> <th>Modulation</th> <th>Mode</th> </tr> </thead> <tbody> <tr> <td>779.5 to 784.5 MHz</td> <td>782 MHz</td> <td>5 MHz</td> <td>QPSK</td> <td>1 RB</td> </tr> </tbody> </table> <p>Note: This device was tested under all bandwidths, RB configurations and modulations. The worst case found in QPSK modulation.</p>	Available Frequencies	Tested Frequency	Channel Bandwidth	Modulation	Mode	779.5 to 784.5 MHz	782 MHz	5 MHz	QPSK	1 RB
Available Frequencies	Tested Frequency	Channel Bandwidth	Modulation	Mode							
779.5 to 784.5 MHz	782 MHz	5 MHz	QPSK	1 RB							

TEST A.1: RF OUTPUT POWER

LIMITS:	Product standard:	FCC Part 27 / IC RSS-139/ IC RSS-130
	Test standard:	FCC §2.1046 and §27.50. RSS-139 Clause 6.5/RSS-130 Clause 4.6

LIMITS

Fixed, mobile, and portable (hand-held) stations operating in the 1710-1755 MHz band are limited to 1-watt EIRP (30 dBm). Fixed stations operating in the 1710-1755 MHz band are limited to a maximum antenna height of 10 meters above ground. Mobile and portable stations operating in these bands must employ a means for limiting power to the minimum necessary for successful communications.

The peak-to-average ratio (PAR) of the transmission shall not exceed 13 dB.

Control stations and mobile stations transmitting in the 746-757 MHz, 776-788 MHz, and 805-806 MHz bands and fixed stations transmitting in the 787-788 MHz and 805-806 MHz bands are limited to 30 watts ERP (44.77 dBm).

RSS-139 Clause 6.5

The equivalent isotropically radiated power (e.i.r.p.) for mobile and portable transmitters shall not exceed one watt (30 dBm). The e.i.r.p. for fixed and base stations in the band 1710-1780 MHz shall not exceed one watt.

The peak-to-average power ratio (PAPR) of the transmission shall not exceed 13 dB.

RSS-130 Clause 4.6

The e.r.p. shall not exceed 30 watts (44.77 dBm) for mobile equipment and outdoor fixed subscriber equipment, or not exceed 3 watts (34.77 dBm) for portable equipment and indoor fixed subscriber equipment.

The peak-to-average power ratio (PAPR) of the transmission shall not exceed 13 dB.

TEST SETUP

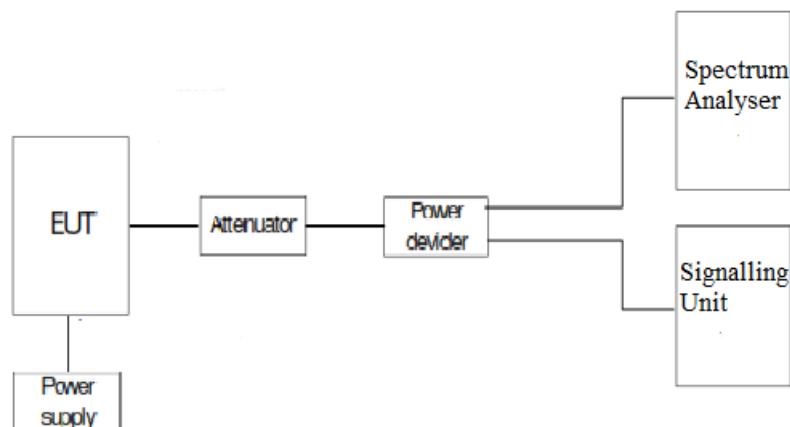

TESTED SAMPLES:	S/01
TESTED CONDITIONS MODES:	TC#01
TEST RESULTS:	PASS

Bandwidth (MHz)	Channel Location Frequency (MHz) Channel Number	Modulation	Resource Block Size	Resource Block Offset	Average power at antenna port (dBm)	PAPR (dB)
5	Lowest 1712.5 19975	QPSK	1	0	22.33	4.72
			1	24	22.44	
			12	0	21.02	
			12	12	21.06	
			25	0	21.08	
		16-QAM	1	0	20.77	5.54
			1	24	20.90	
			12	0	19.89	
			12	12	19.91	
			25	0	19.95	
	Middle 1732.5 20175	QPSK	1	0	22.59	4.52
			1	24	22.59	
			12	0	21.32	
			12	12	21.20	
			25	0	21.32	
		16-QAM	1	0	21.02	5.39
			1	24	21.11	
			12	0	20.24	
			12	12	20.13	
			25	0	20.23	
Highest 1752.5 20375	QPSK	1	0	21.85	4.64	
		1	24	21.94		
		12	0	20.94		
		12	12	20.99		
		25	0	20.86		
	16-QAM	1	0	20.50	5.30	
		1	24	20.63		
		12	0	19.90		
		12	12	19.87		
		25	0	19.73		

TEST RESULTS (Cont):						
Bandwidth (MHz)	Channel Location Frequency (MHz) Channel Number	Modulation	Resource Block Size	Resource Block Offset	Average power at antenna port (dBm)	PAPR (dB)
10	Lowest 1715.0 20000	QPSK	1	0	22.08	4.70
			1	49	22.36	
			25	0	21.04	
			25	24	21.19	
			50	0	21.02	
		16-QAM	1	0	20.54	5.51
			1	49	20.90	
			25	0	19.94	
			25	24	20.18	
			50	0	20.04	
	Middle 1732.5 20175	QPSK	1	0	22.17	4.52
			1	49	22.19	
			25	0	21.34	
			25	24	21.22	
			50	0	21.26	
		16-QAM	1	0	20.91	5.10
			1	49	20.97	
			25	0	20.27	
			25	24	20.07	
			50	0	20.15	
	Highest 1750.0 20350	QPSK	1	0	22.21	4.35
			1	49	22.01	
			25	0	21.02	
			25	24	20.77	
50			0	20.95		
16-QAM		1	0	20.71	5.22	
		1	49	20.64		
		25	0	20.00		
		25	24	19.94		
		50	0	19.88		

TEST RESULTS (Cont):						
Bandwidth (MHz)	Channel Location Frequency (MHz) Channel Number	Modulation	Resource Block Size	Resource Block Offset	Average power at antenna port (dBm)	PAPR (dB)
15	Lowest 1717.5 20025	QPSK	1	0	21.99	4.32
			1	74	22.25	
			36	0	19.60	
			36	37	20.29	
			75	0	19.79	
		16-QAM	1	0	20.95	5.10
			1	74	20.80	
			36	0	18.71	
			36	37	19.29	
			75	0	18.80	
	Middle 1732.5 20175	QPSK	1	0	22.48	4.00
			1	74	22.37	
			36	0	19.93	
			36	37	20.14	
			75	0	19.95	
		16-QAM	1	0	21.36	4.72
			1	74	20.92	
			36	0	18.94	
			36	37	19.19	
			75	0	18.94	
	Highest 1747.5 20325	QPSK	1	0	22.15	4.09
			1	74	21.87	
			36	0	19.64	
			36	37	19.96	
75			0	19.77		
16-QAM		1	0	20.92	4.81	
		1	74	20.63		
		36	0	18.68		
		36	37	18.87		
		75	0	18.73		

TEST RESULTS (Cont):						
Bandwidth (MHz)	Channel Location Frequency (MHz) Channel Number	Modulation	Resource Block Size	Resource Block Offset	Average power at antenna port (dBm)	PAPR (dB)
20	Lowest 1720.0 20050	QPSK	1	0	22.14	4.46
			1	99	22.24	
			50	0	18.41	
			50	49	18.65	
			100	0	18.45	
		16-QAM	1	0	20.84	5.19
			1	99	20.90	
			50	0	17.46	
			50	49	17.61	
			100	0	17.40	
	Middle 1732.5 20175	QPSK	1	0	22.33	4.23
			1	99	22.55	
			50	0	18.59	
			50	49	18.69	
			100	0	18.58	
		16-QAM	1	0	21.41	5.33
			1	99	21.17	
			50	0	17.62	
			50	49	17.71	
			100	0	17.55	
Highest 1745.0 20300	QPSK	1	0	22.39	4.12	
		1	99	22.46		
		50	0	18.56		
		50	49	18.62		
		100	0	18.43		
	16-QAM	1	0	21.32	5.13	
		1	99	20.27		
		50	0	17.51		
		50	49	17.54		
		100	0	17.34		

TEST RESULTS (Cont):

LTE QPSK AND 16QAM MODULATION. Bandwidth = 5 MHz

Channel	Average power at antenna port (dBm)	Maximum declared antenna gain (dBi)	Maximum E.I.R.P. average power (dBm)	PAPR (dB)
Lowest	22.44	2.14	24.58	5.54
Middle	22.59	2.14	24.73	5.39
Highest	21.94	2.14	24.08	5.30
Measurement uncertainty (dB)			<±0.95	

LTE QPSK AND 16QAM MODULATION. Bandwidth = 10 MHz

Channel	Average power at antenna port (dBm)	Maximum declared antenna gain (dBi)	Maximum E.I.R.P. average power (dBm)	PAPR (dB)
Lowest	22.36	2.14	24.50	5.51
Middle	22.19	2.14	24.33	5.10
Highest	22.21	2.14	24.35	5.22
Measurement uncertainty (dB)			<±0.95	

LTE QPSK AND 16QAM MODULATION. Bandwidth = 15 MHz

Channel	Average power at antenna port (dBm)	Maximum declared antenna gain (dBi)	Maximum E.I.R.P. average power (dBm)	PAPR (dB)
Lowest	22.25	2.14	24.39	5.10
Middle	22.48	2.14	24.62	4.72
Highest	22.15	2.14	24.29	4.81
Measurement uncertainty (dB)			<±0.95	

LTE QPSK AND 16QAM MODULATION. Bandwidth = 20 MHz

Channel	Average power at antenna port (dBm)	Maximum declared antenna gain (dBi)	Maximum E.I.R.P. average power (dBm)	PAPR (dB)
Lowest	22.24	2.14	24.38	5.19
Middle	22.55	2.14	24.69	5.33
Highest	22.46	2.14	24.60	5.13
Measurement uncertainty (dB)			<±0.95	

Verdict: PASS

TEST RESULTS (Cont):

PAPR

Bandwidth = 5 MHz. Modulation QPSK. RB Size: 1. RB Offset: 0.

Lowest channel

Ref Level 30.00 dBm Offset 1.50 dB RBW 10 MHz
 Att 45 dB AQT 1.6 ms Input 1 AC
 SGL PS

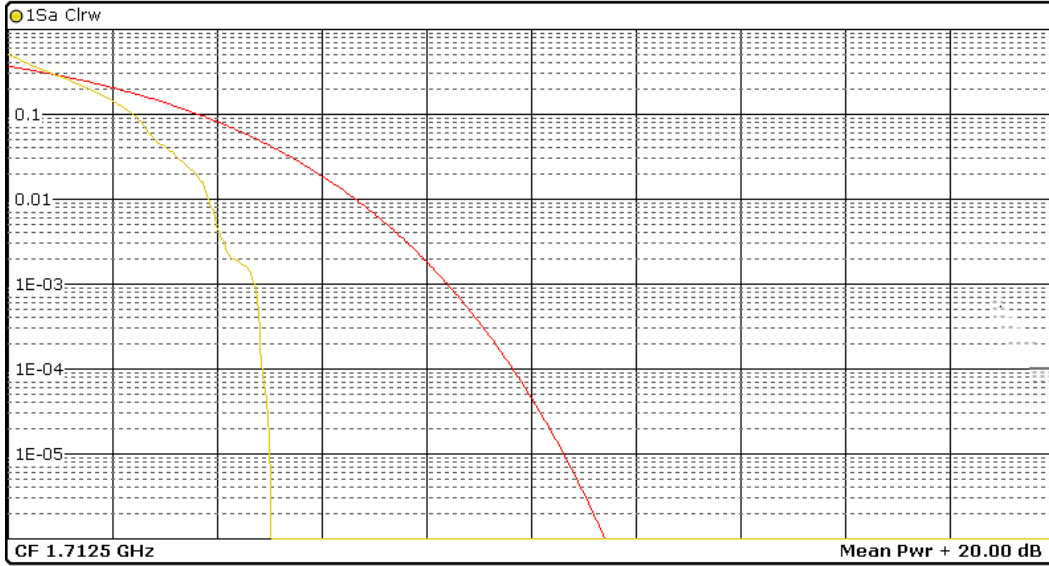

CF 1.7125 GHz Mean Pwr + 20.00 dB

Complementary Cumulative Distribution Function Samples: 100000

	Mean	Peak	Crest	10%	1%	0.1%	0.01%
Trace 1	22.50 dBm	27.52 dBm	5.02 dB	2.38 dB	3.86 dB	4.72 dB	4.87 dB

Middle channel

Ref Level 30.00 dBm Offset 1.50 dB RBW 10 MHz
 Att 45 dB AQT 1.6 ms Input 1 AC
 SGL PS

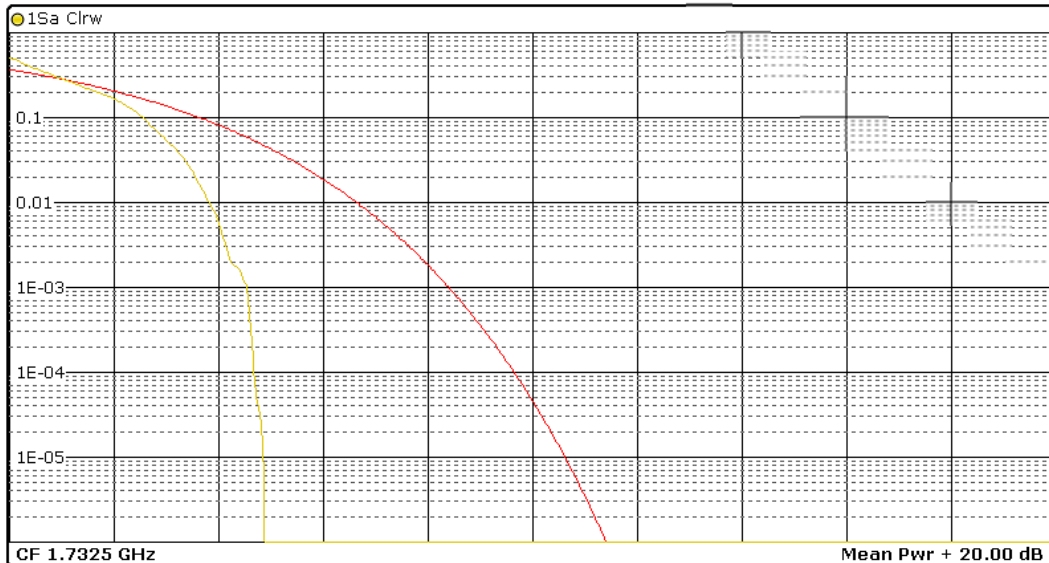

CF 1.7325 GHz Mean Pwr + 20.00 dB

Complementary Cumulative Distribution Function Samples: 100000

	Mean	Peak	Crest	10%	1%	0.1%	0.01%
Trace 1	22.86 dBm	27.71 dBm	4.85 dB	2.55 dB	3.83 dB	4.52 dB	4.70 dB

TEST RESULTS (Cont):

Highest channel

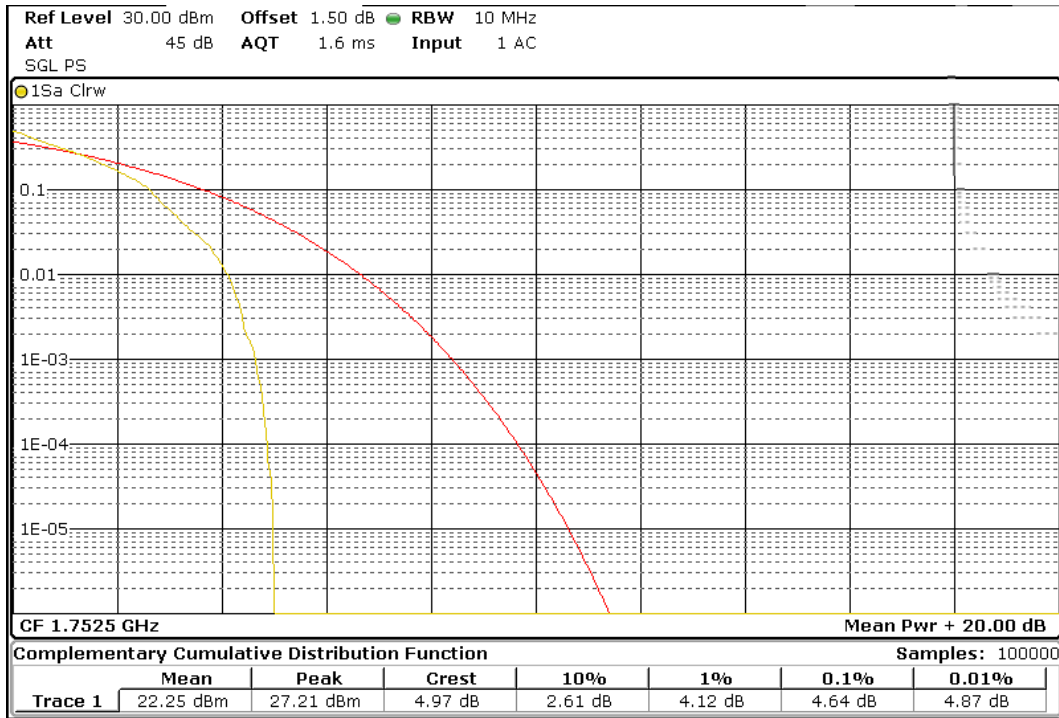

PAPR

Bandwidth = 5 MHz. Modulation 16QAM. RB Size: 1. RB Offset: 0.

Lowest channel

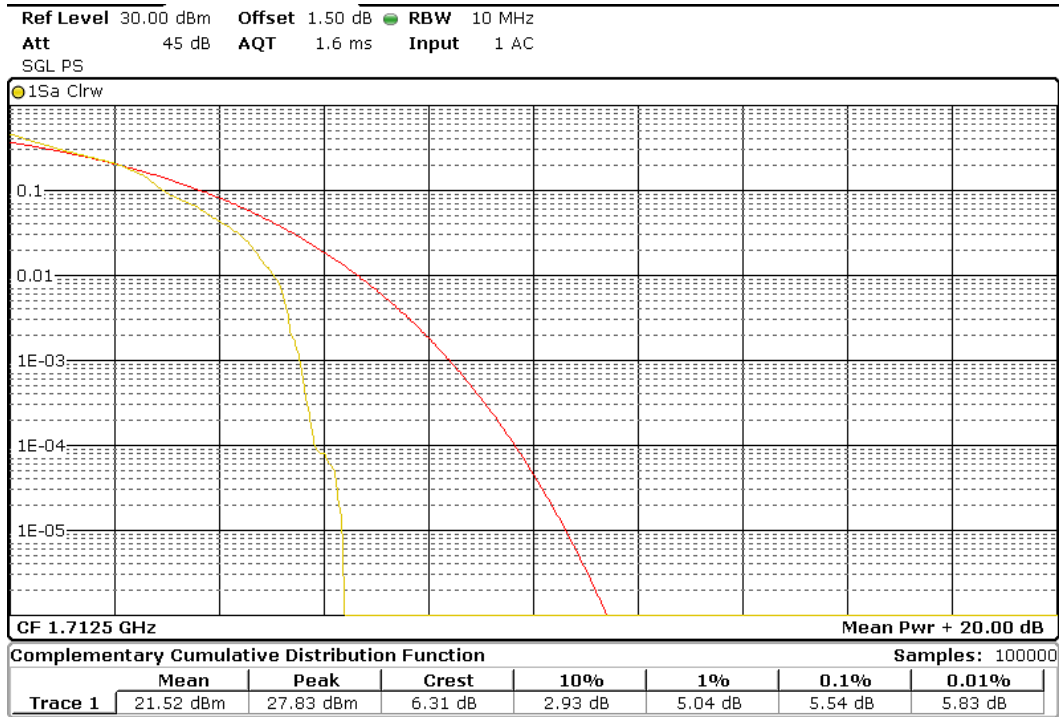

TEST RESULTS (Cont):

Middle channel

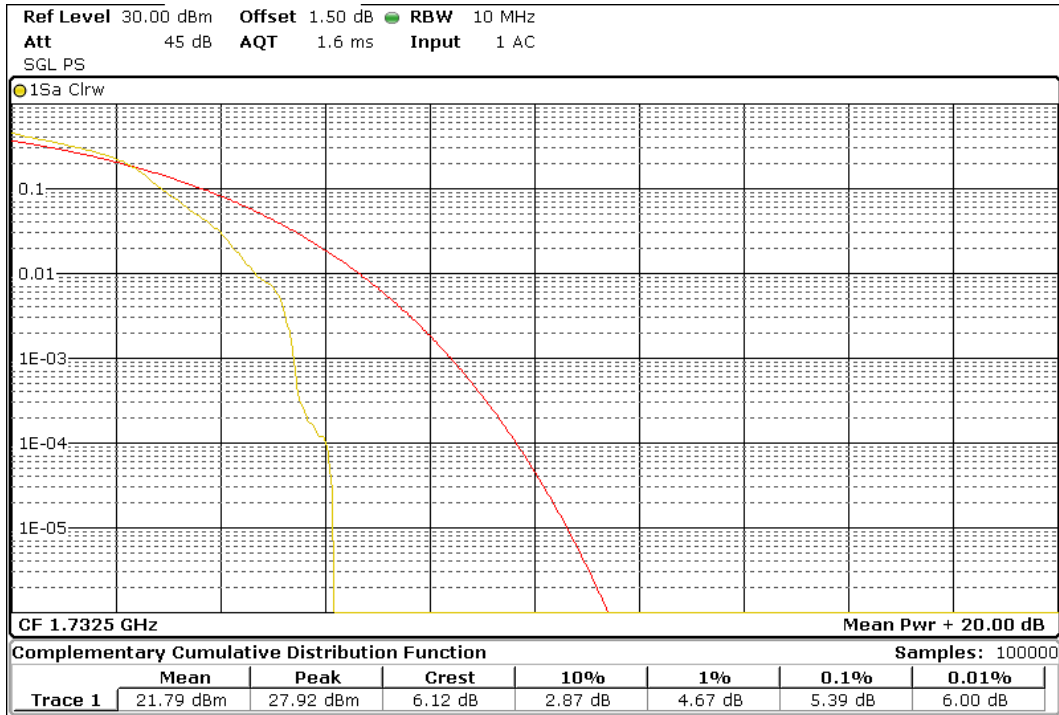

Highest channel

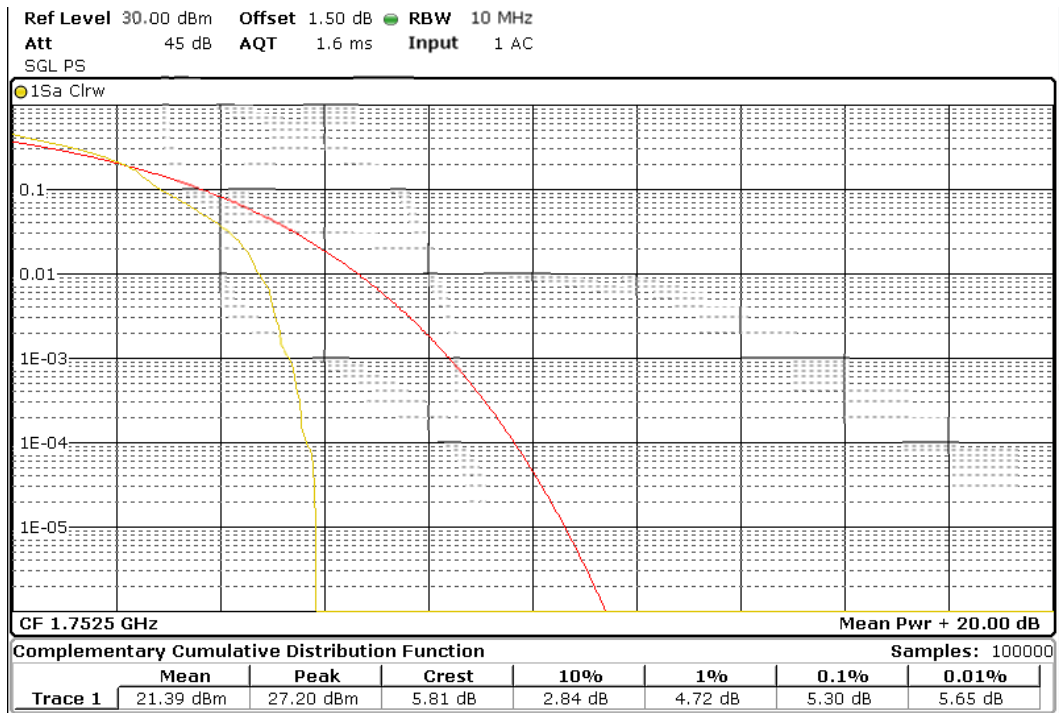

TEST RESULTS (Cont):

PAPR

Bandwidth = 10 MHz. Modulation QPSK. RB Size: 1. RB Offset: 0.

Lowest channel

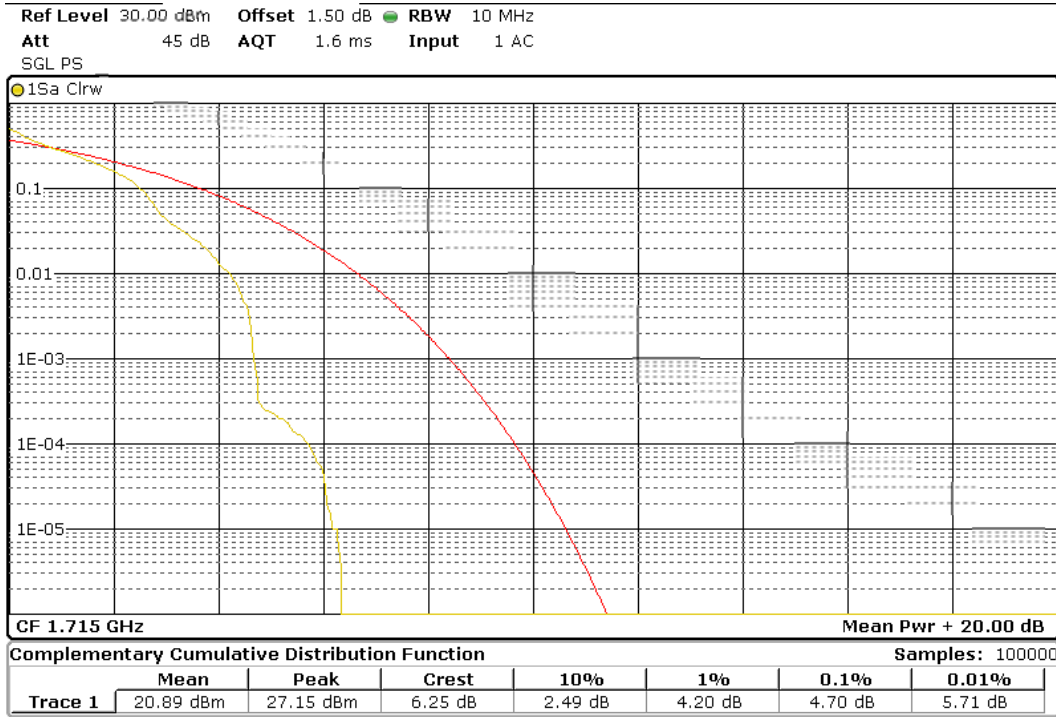

Middle channel

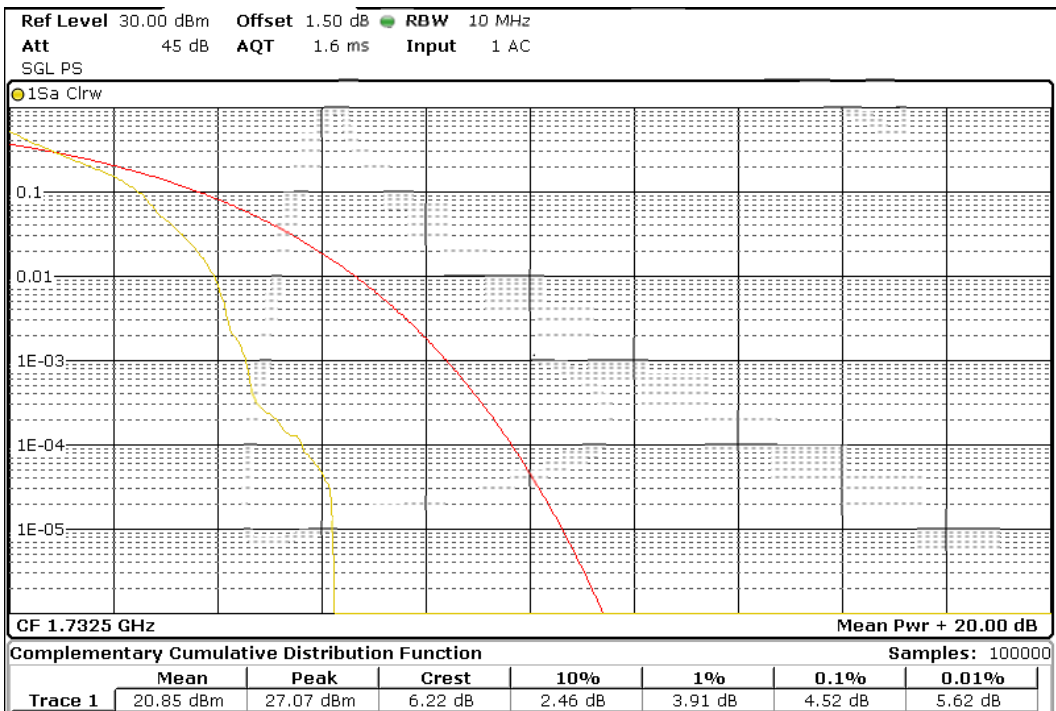

TEST RESULTS (Cont):

Highest channel

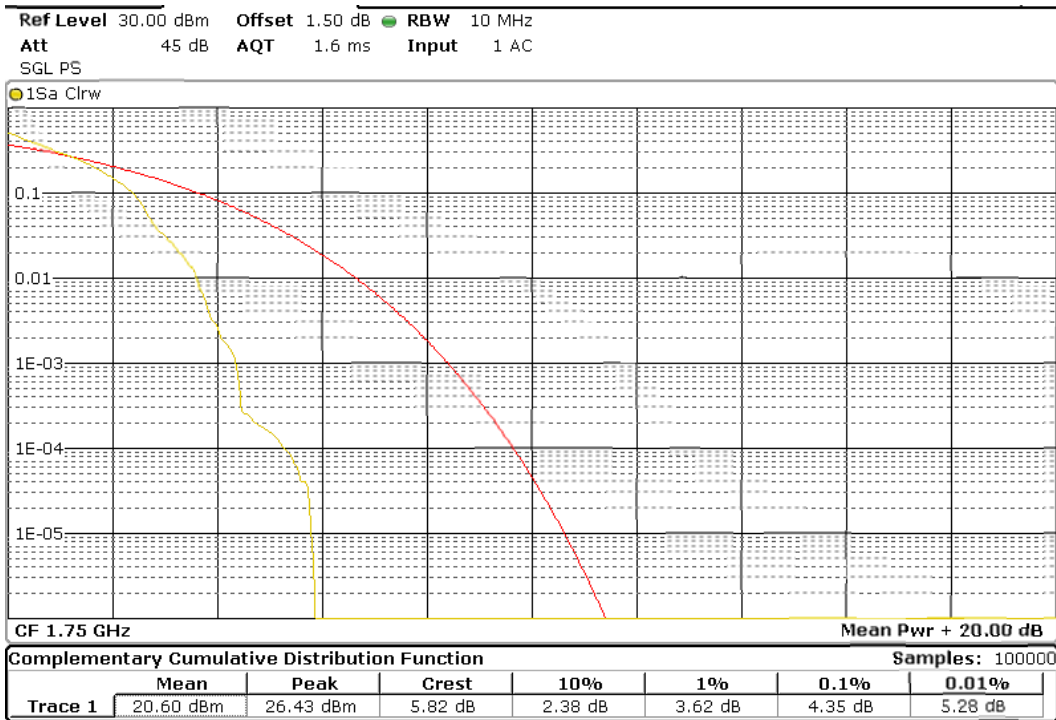

PAPR

Bandwidth = 10 MHz. Modulation 16QAM. RB Size: 1. RB Offset: 0.

Lowest channel

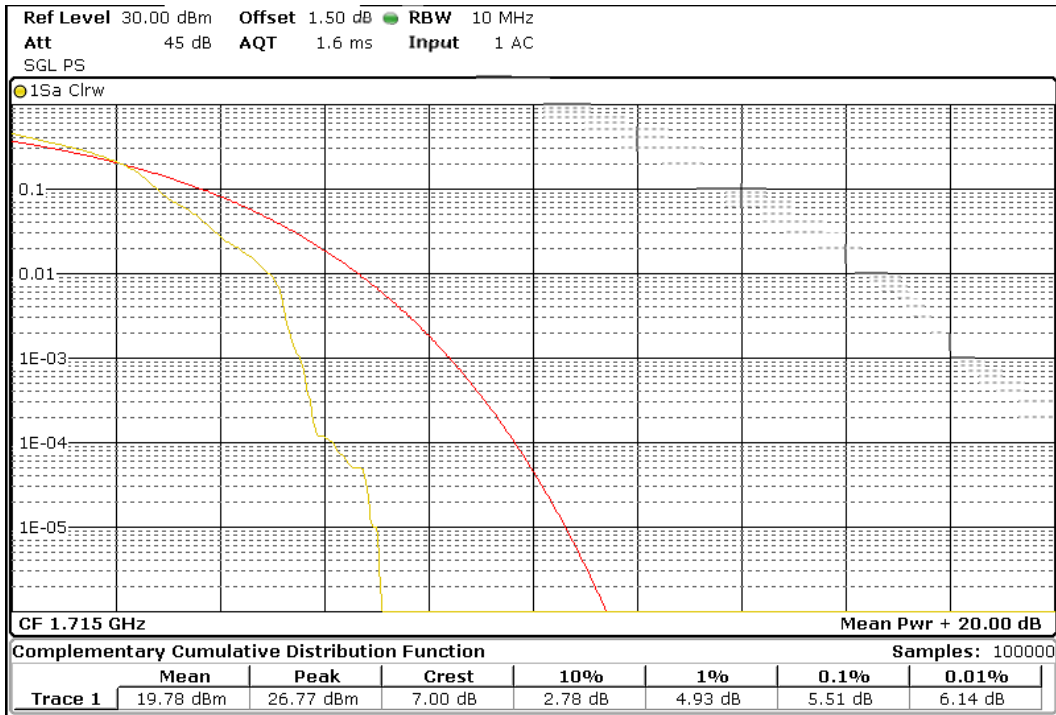

TEST RESULTS (Cont):

Middle channel

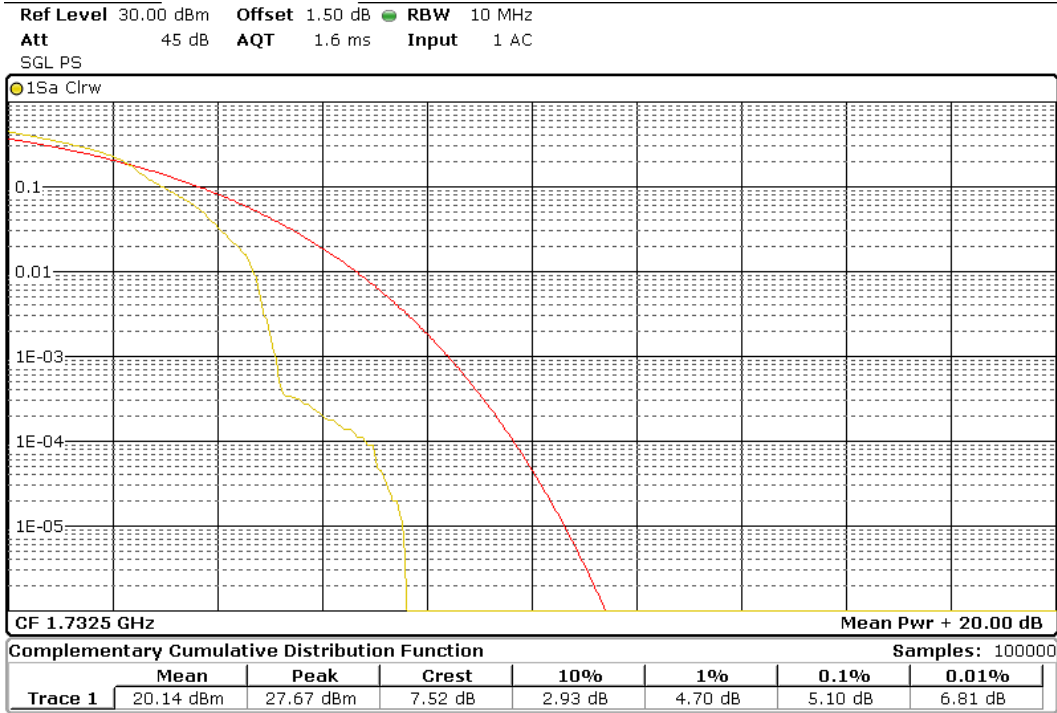

Highest channel

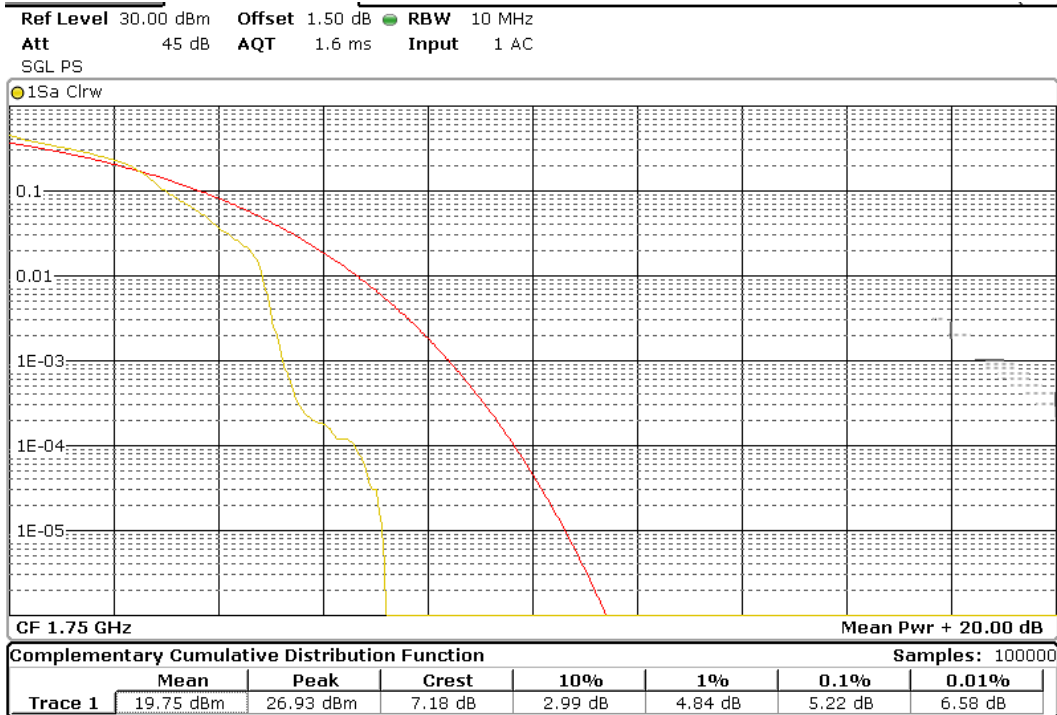

TEST RESULTS (Cont):

PAPR

Bandwidth = 15 MHz. Modulation QPSK. RB Size: 1. RB Offset: 0.
 Lowest channel

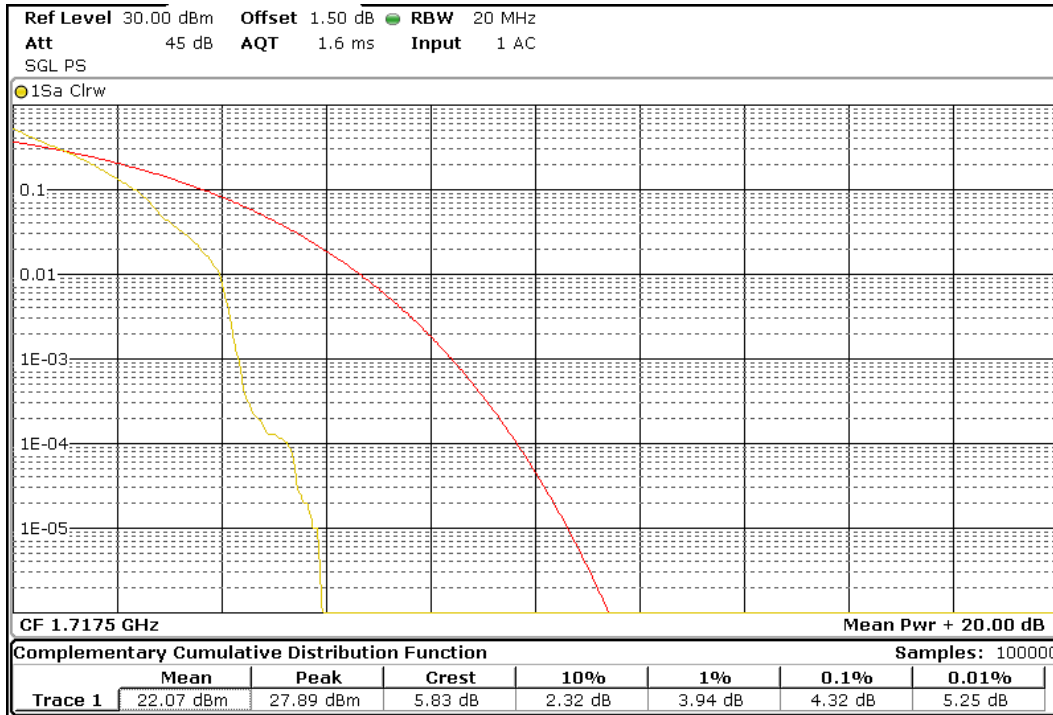

Middle channel

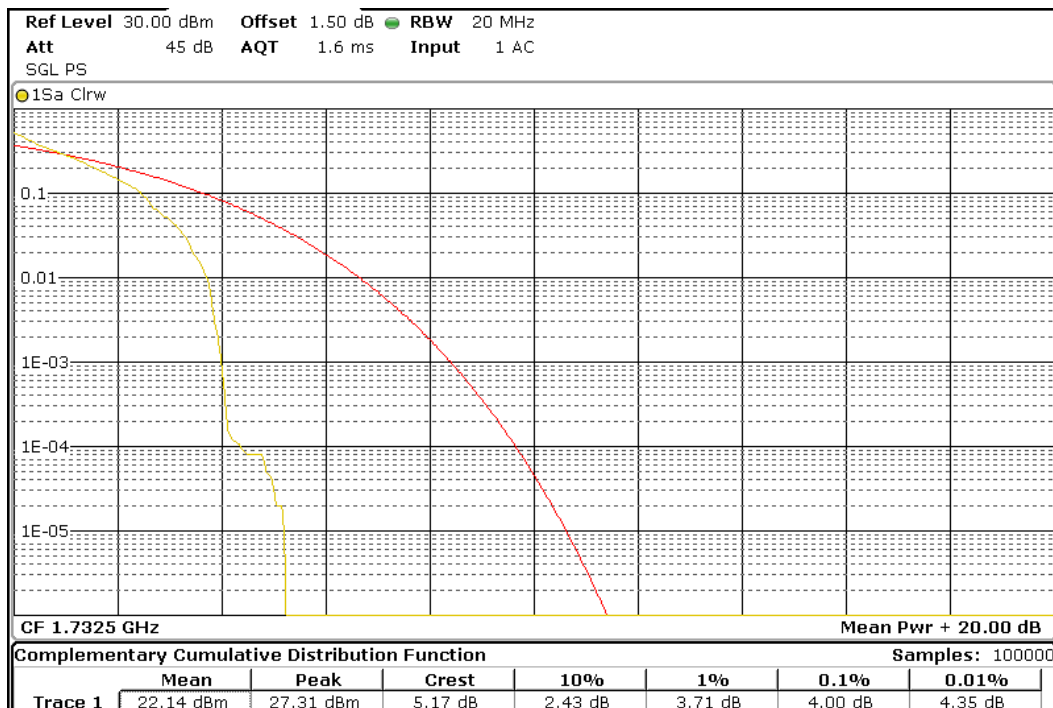

TEST RESULTS (Cont):

Highest channel

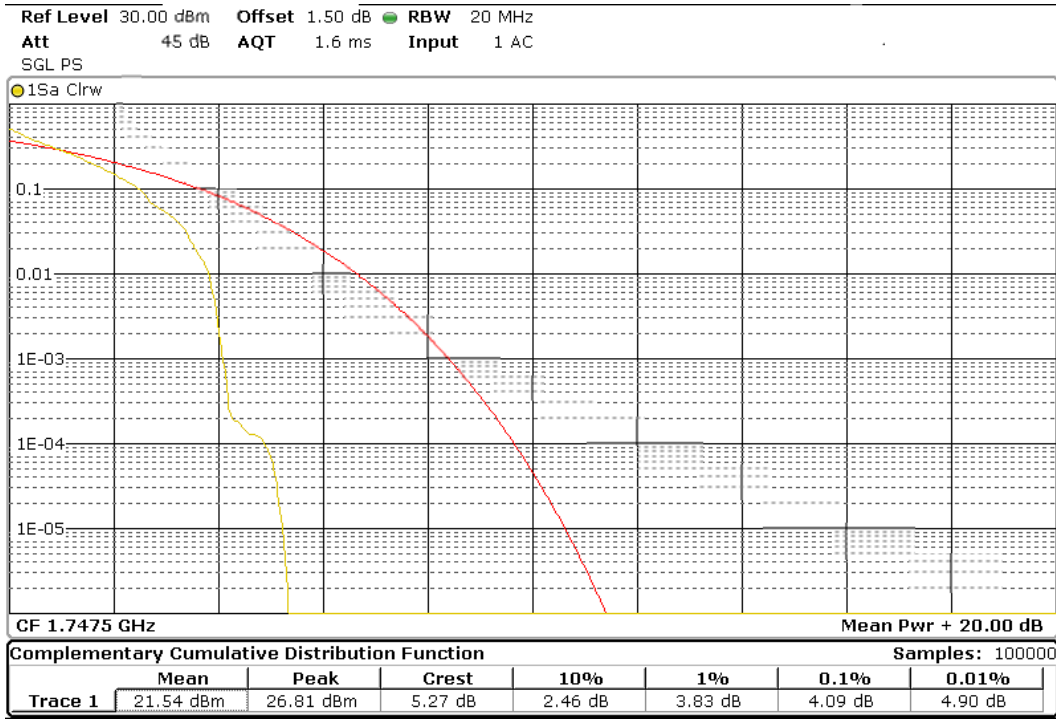

Bandwidth = 15 MHz. Modulation 16QAM. RB Size: 1. RB Offset: 0.
 Lowest channel

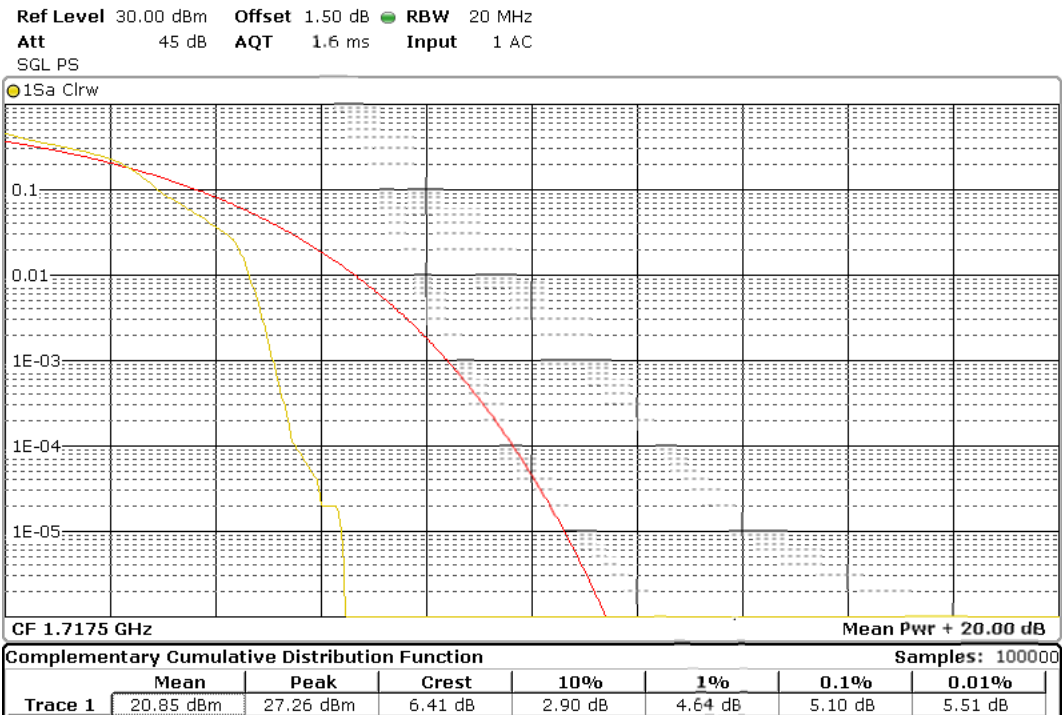

TEST RESULTS (Cont):

Middle channel

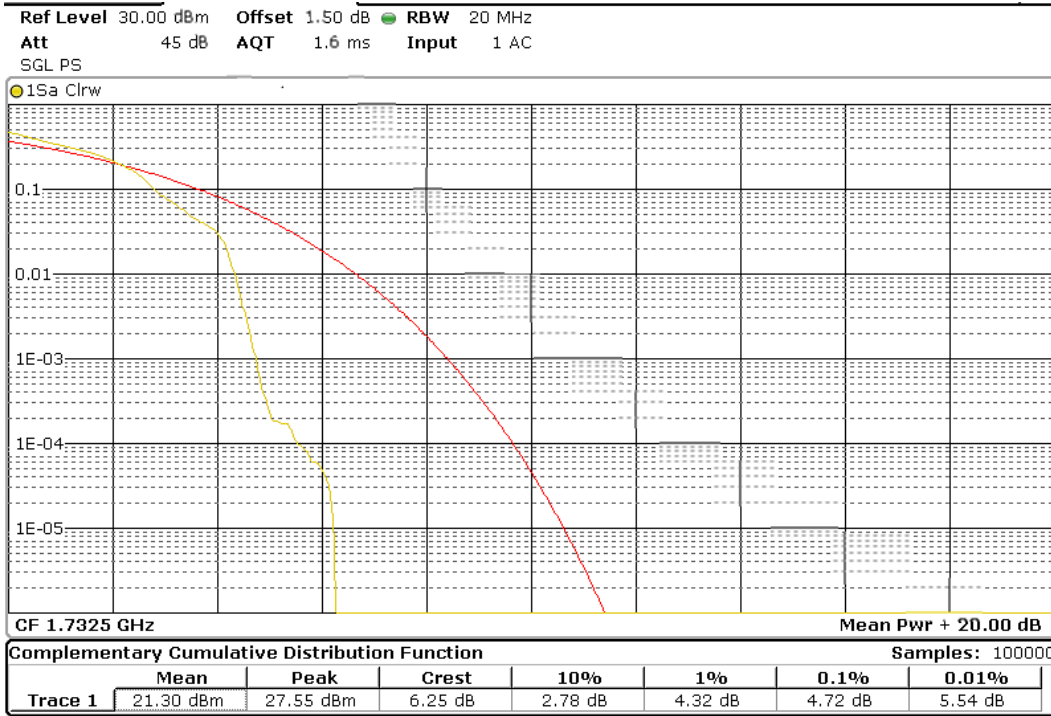

Highest channel

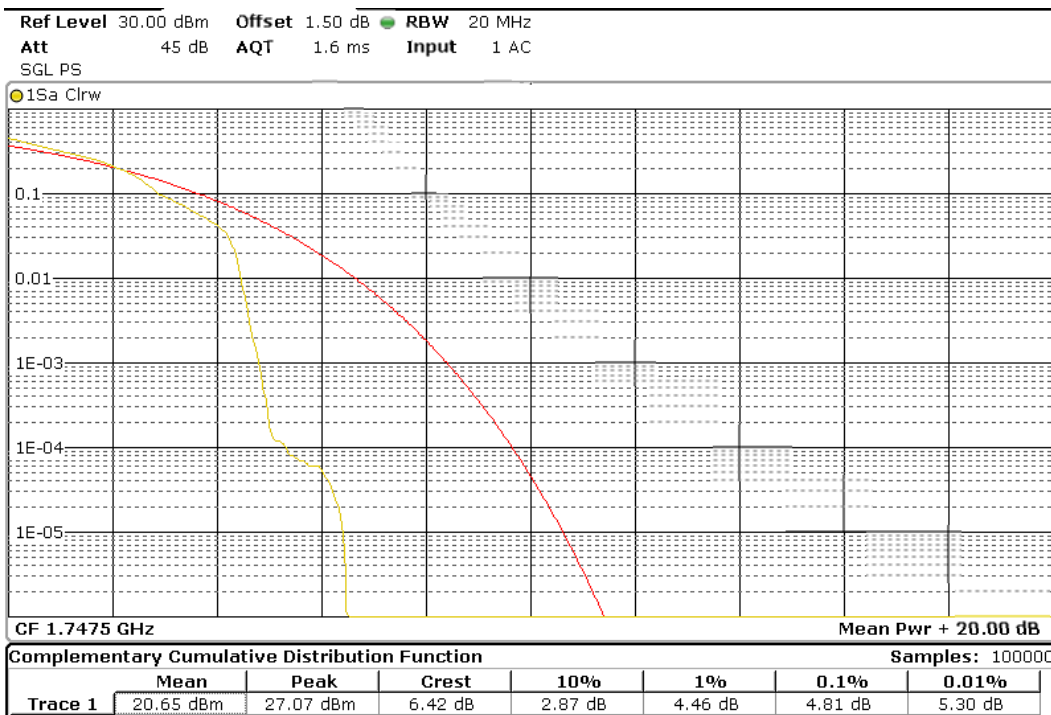

TEST RESULTS (Cont):

Bandwidth = 20 MHz. Modulation QPSK. RB Size: 1. RB Offset: 0.
 Lowest channel

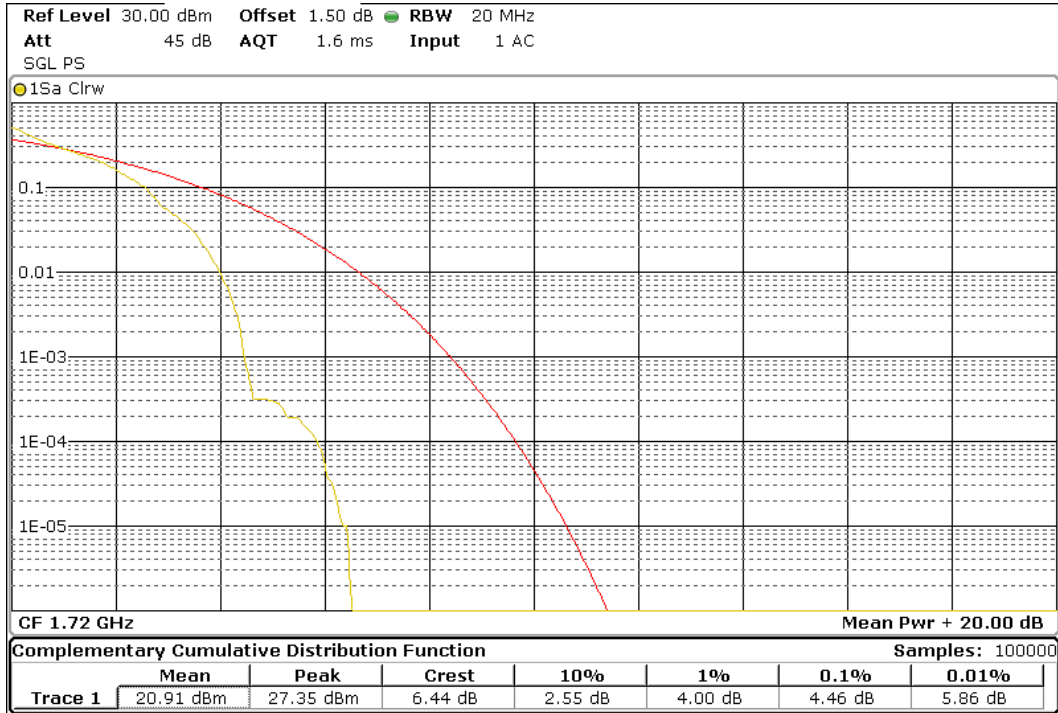

Middle channel

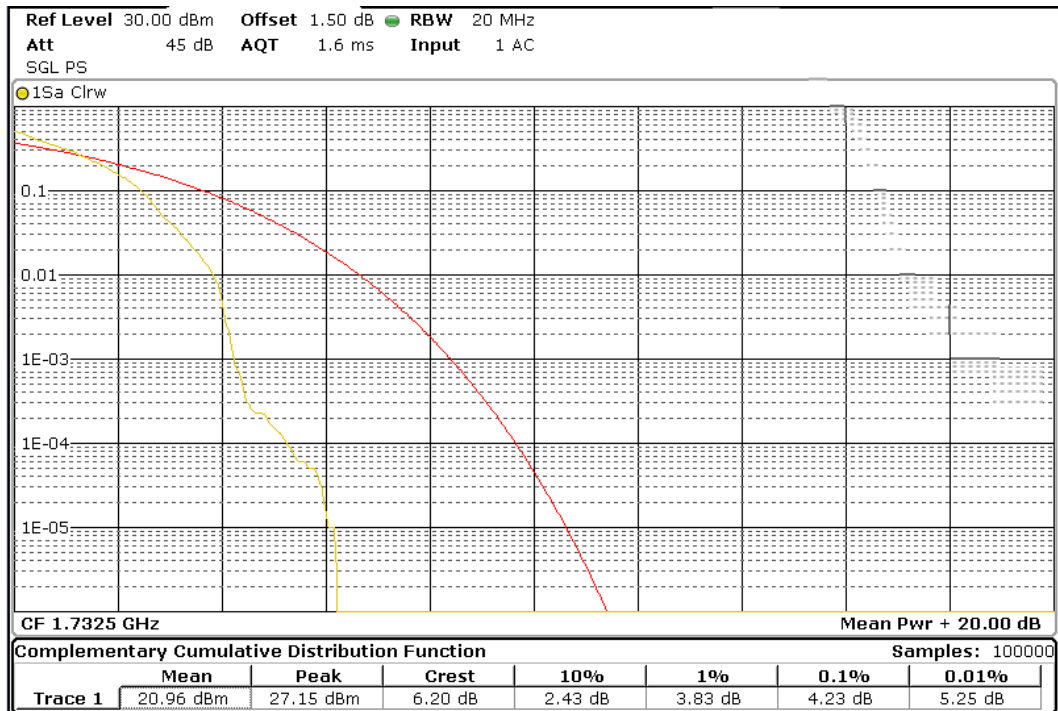

TEST RESULTS (Cont):

Highest channel

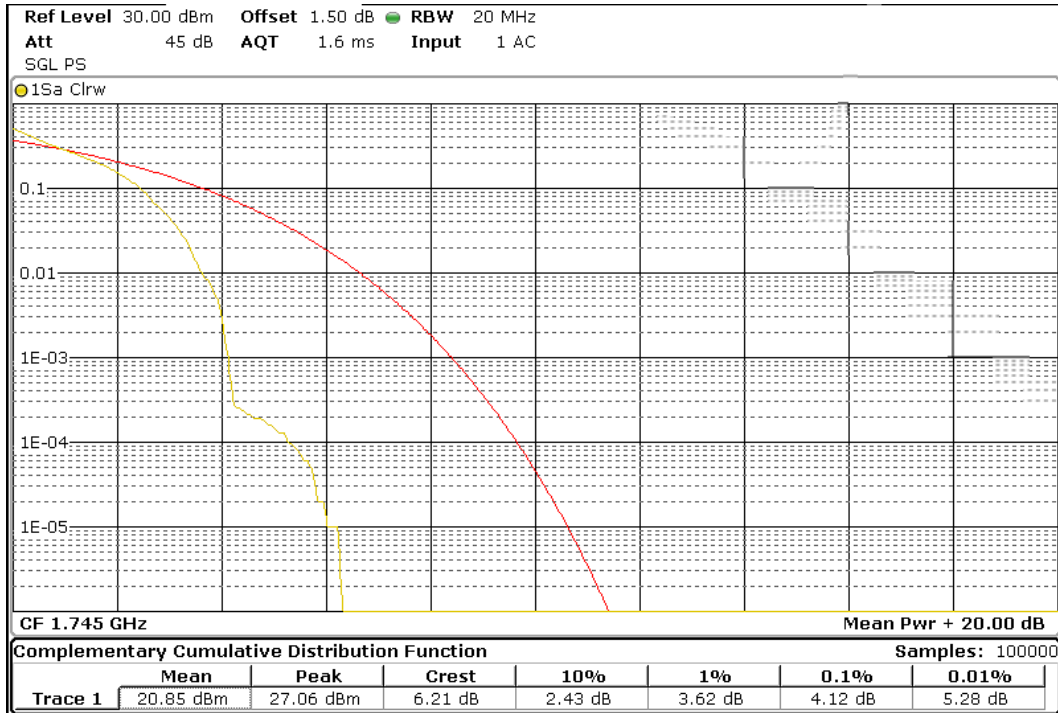

Bandwidth = 20 MHz. Modulation 16QAM. RB Size: 1. RB Offset: 0.
 Lowest channel

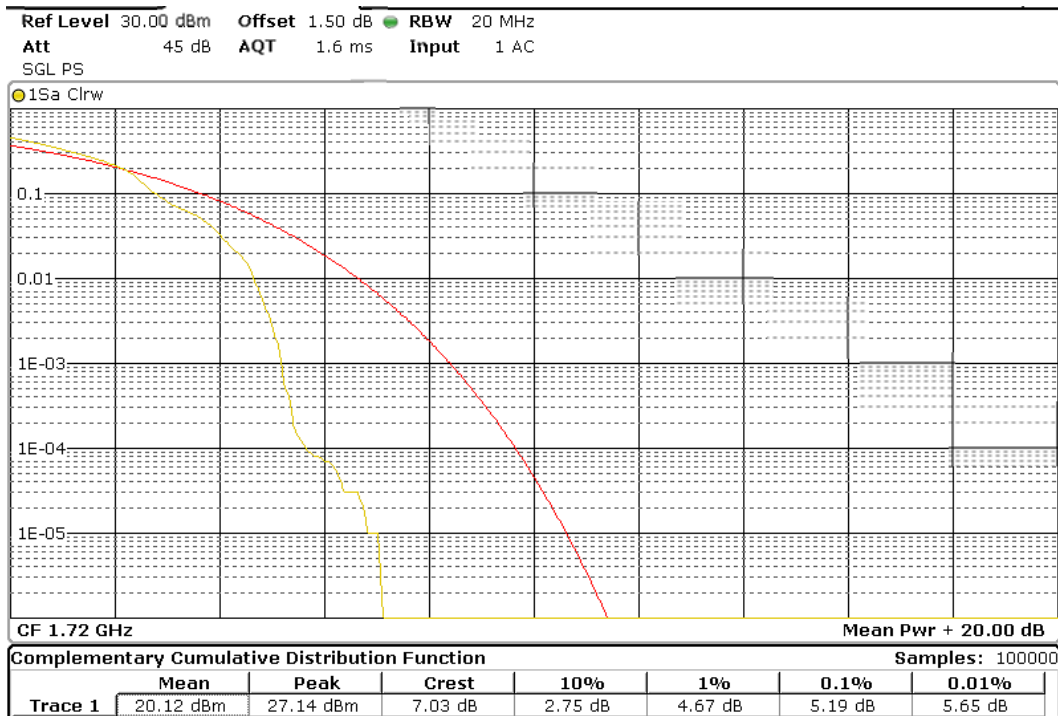

TEST RESULTS (Cont):

Middle channel

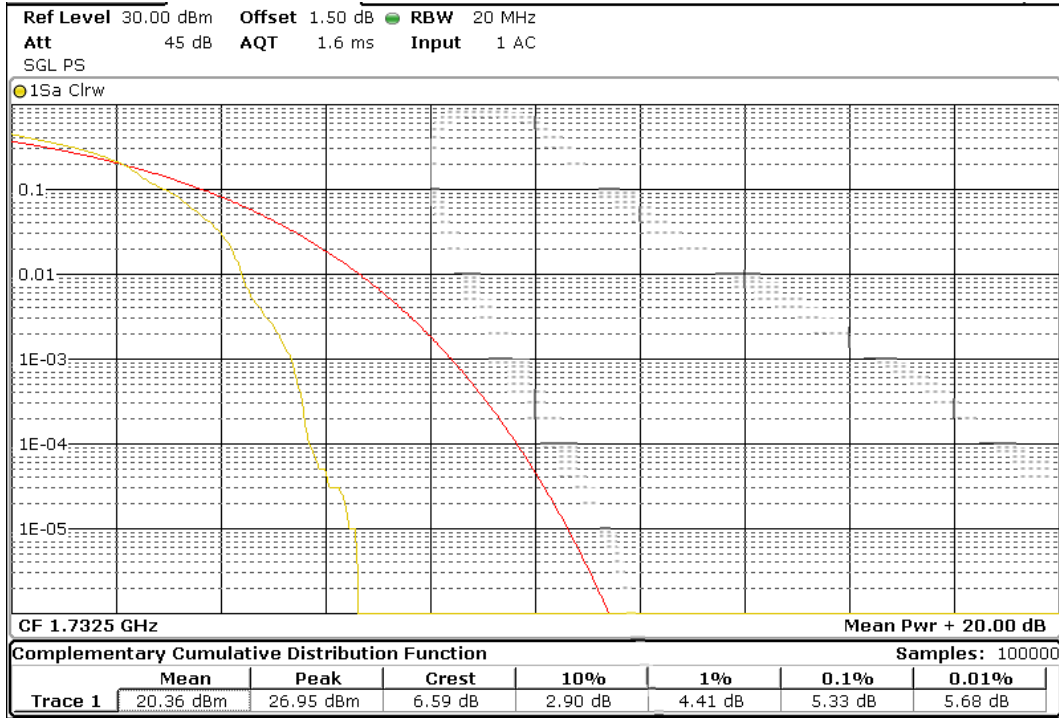

Highest channel

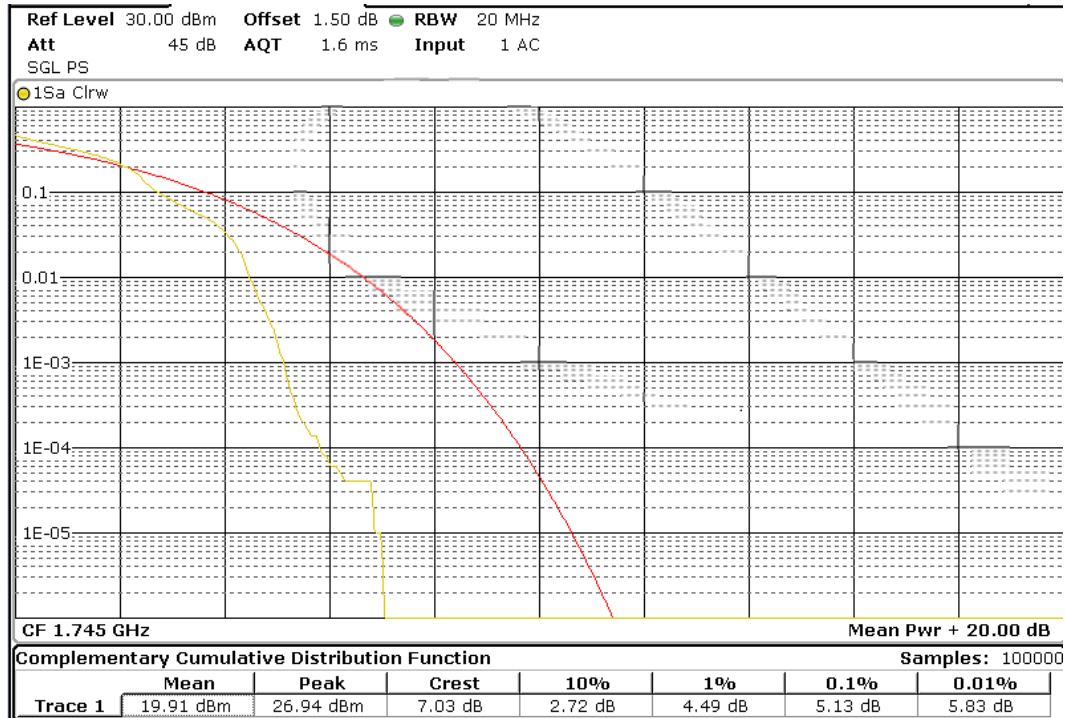

TESTED SAMPLES:	S/01
TESTED CONDITIONS MODES:	TC#02
TEST RESULTS:	PASS

Bandwidth (MHz)	Channel Location Frequency (MHz) Channel Number	Modulation	Resource Block Size	Resource Block Offset	Average power at antenna port (dBm)	Peak-to-average ratio (PAR) (dB)
5	Lowest 779.5 23205	QPSK	1	0	24.41	4.67
			1	24	24.34	
			12	0	23.64	
			12	12	23.67	
			25	0	23.54	
		16-QAM	1	0	22.96	5.01
			1	24	23.00	
			12	0	22.57	
			12	12	22.62	
			25	0	22.57	
	Middle 782 23230	QPSK	1	0	25.84	4.84
			1	24	25.51	
			12	0	24.74	
			12	12	24.52	
			25	0	24.66	
		16-QAM	1	0	24.77	5.57
			1	24	24.45	
			12	0	23.79	
			12	12	23.35	
			25	0	23.61	
Highest 784.5 23255	QPSK	1	0	25.82	4.81	
		1	24	25.88		
		12	0	24.67		
		12	12	24.70		
		25	0	24.63		
	16-QAM	1	0	24.30	5.68	
		1	24	24.48		
		12	0	23.41		
		12	12	23.54		
		25	0	23.49		

TEST RESULTS (Cont):

Bandwidth (MHz)	Channel Location Frequency (MHz) Channel Number	Modulation	Resource Block Size	Resource Block Offset	Average power at antenna port (dBm)	Peak-to-average ratio (PAR) (dB)
10	Middle 782 23230	QPSK	1	0	25.53	5.28
			1	49	25.53	
			25	0	24.86	
			25	25	24.61	
			50	0	24.78	
		16-QAM	1	0	24.51	5.94
			1	49	24.29	
			25	0	23.69	
			25	25	23.55	
			50	0	23.59	

LTE QPSK AND 16QAM MODULATION. Bandwidth = 5 MHz

Channel	Average power at antenna port (dBm)	Maximum declared antenna gain (dBi)	Maximum E.I.R.P. average power (dBm)	PAPR (dB)
Lowest		2.14		
Middle		2.14		
Highest		2.14		
Measurement uncertainty (dB)			<±0.95	

LTE QPSK AND 16QAM MODULATION. Bandwidth = 10 MHz

Channel	Average power at antenna port (dBm)	Maximum declared antenna gain (dBi)	Maximum E.I.R.P. average power (dBm)	PAPR (dB)
Lowest		2.14		
Middle		2.14		
Highest		2.14		
Measurement uncertainty (dB)			<±0.95	

TEST RESULTS (Cont):

PAPR

Bandwidth = 5 MHz. Modulation QPSK. RB Size: 1. RB Offset: 0.
 Lowest channel

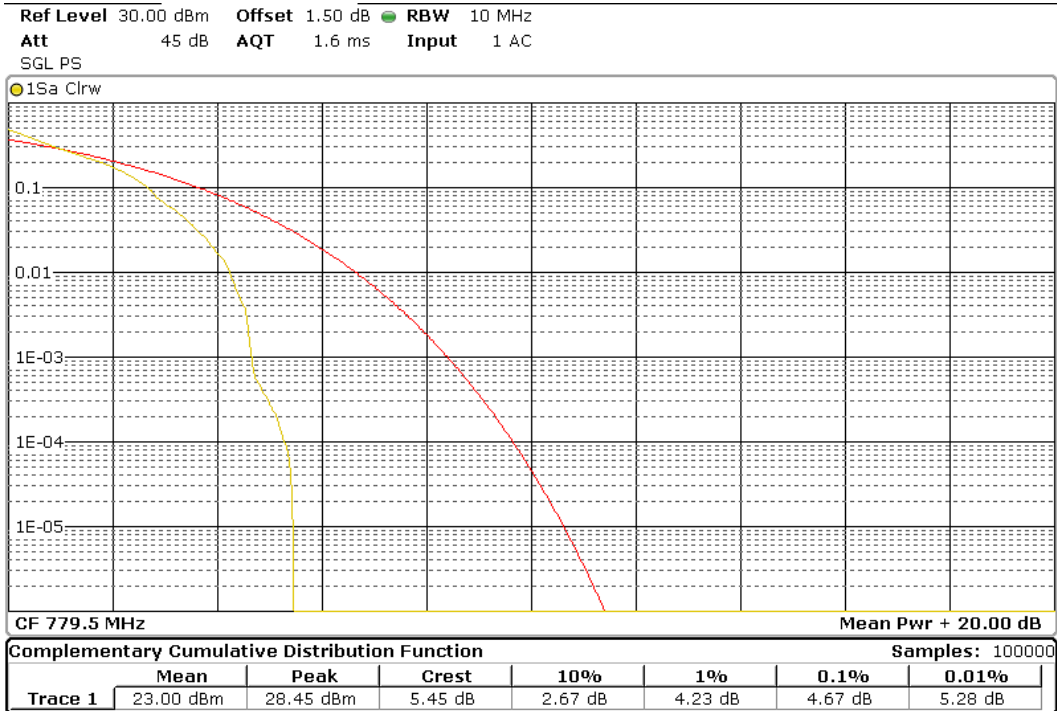

Middle channel

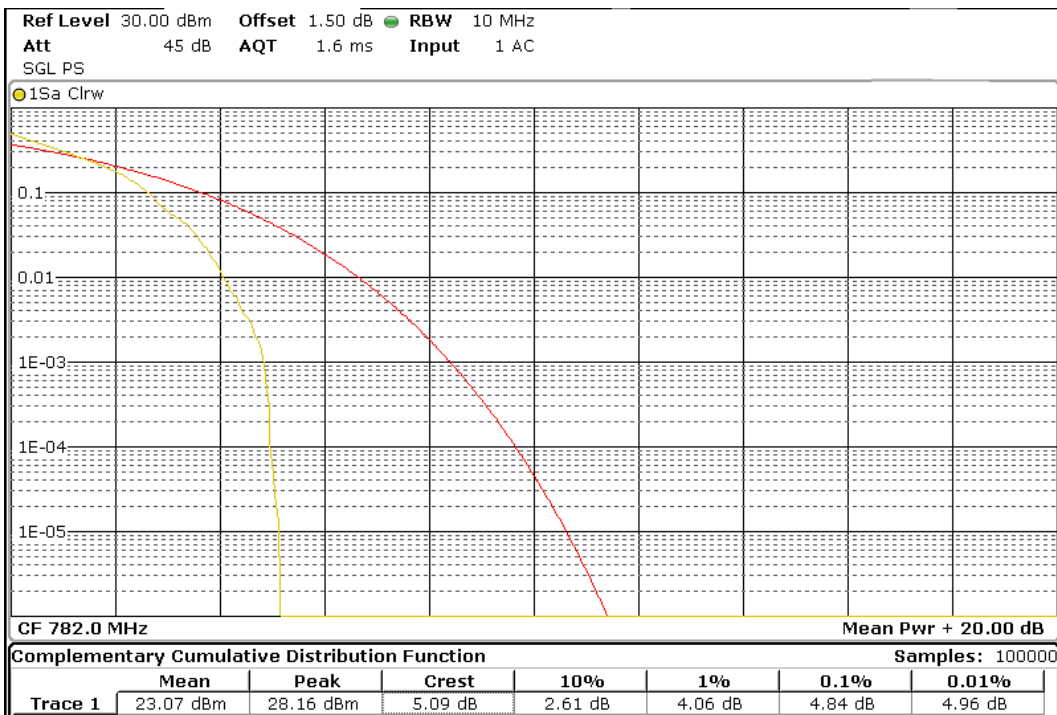

TEST RESULTS (Cont):

Highest channel

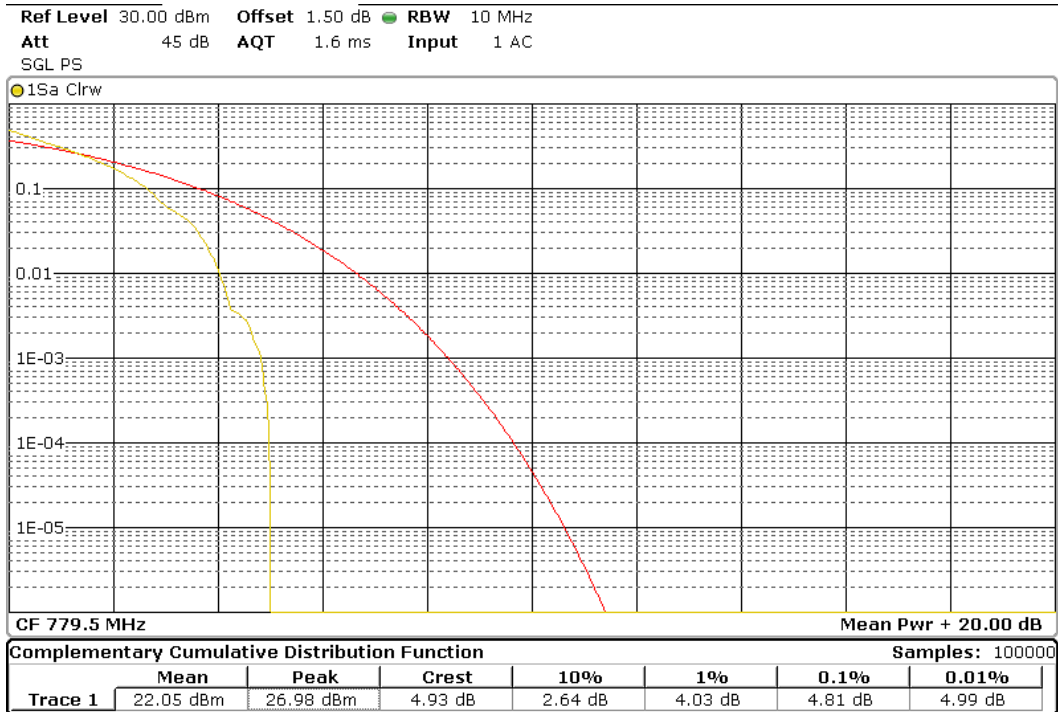

PAPR

Bandwidth = 5 MHz. Modulation 16QAM. RB Size: 1. RB Offset: 0.
 Lowest channel

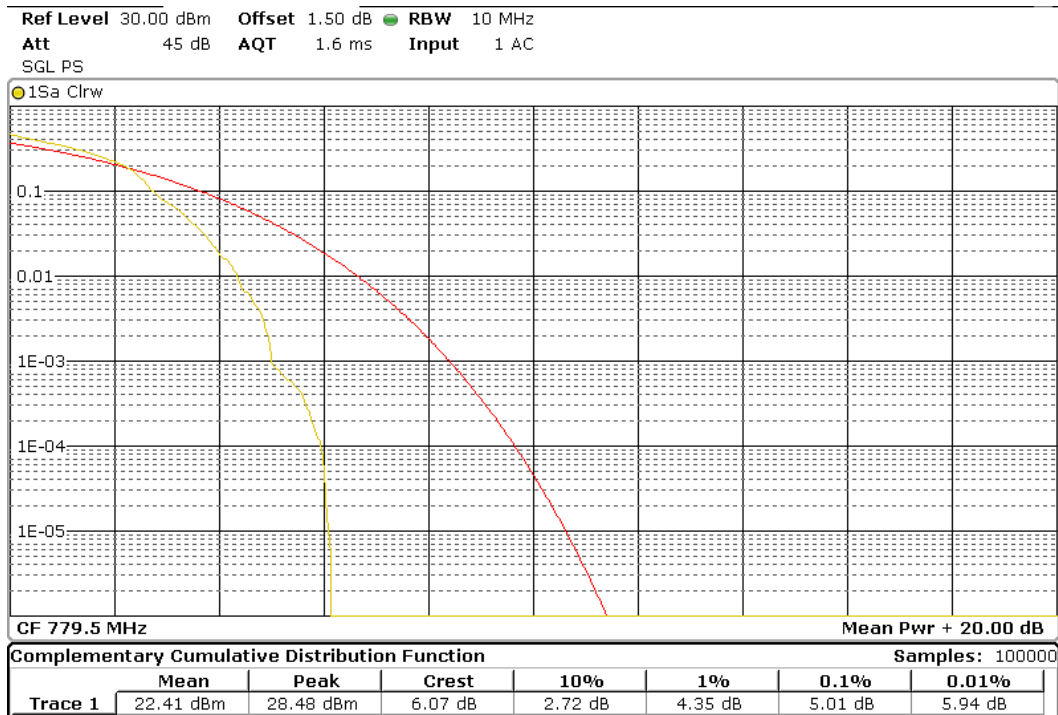

TEST RESULTS (Cont):

Middle channel

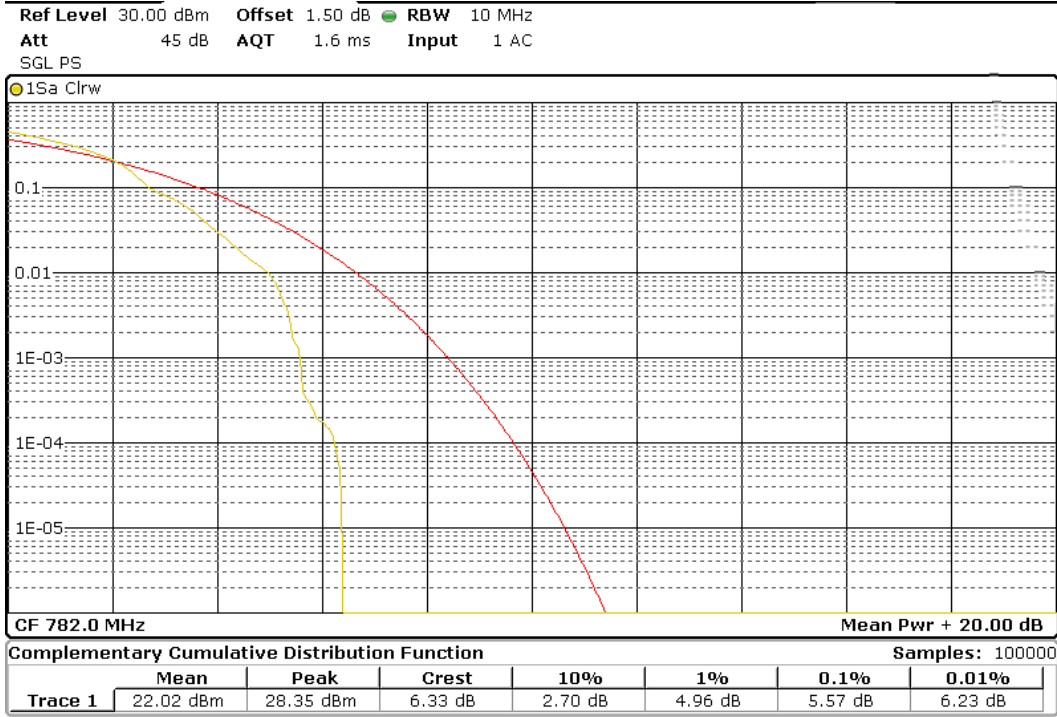

Highest channel

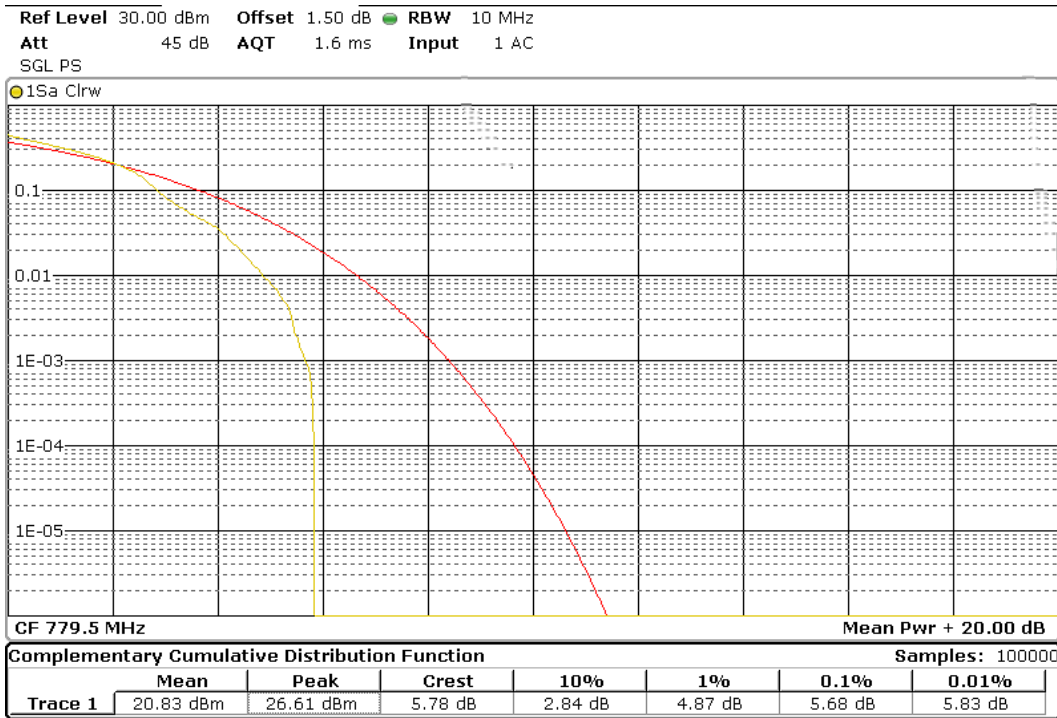

TEST RESULTS (Cont):

PAPR

Bandwidth = 10 MHz. Modulation: QPSK RB Size: 1. RB Offset: 0.

Lowest channel

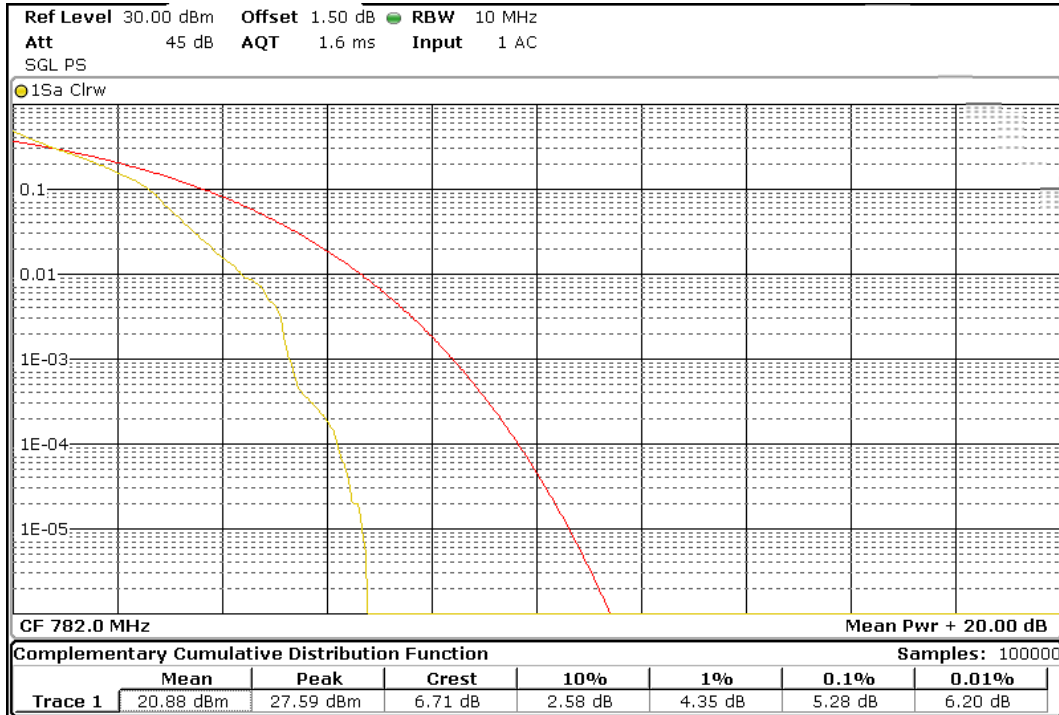

PAPR

Bandwidth = 10 MHz. Modulation 16QAM. RB Size: 1. RB Offset: 0.

Lowest channel

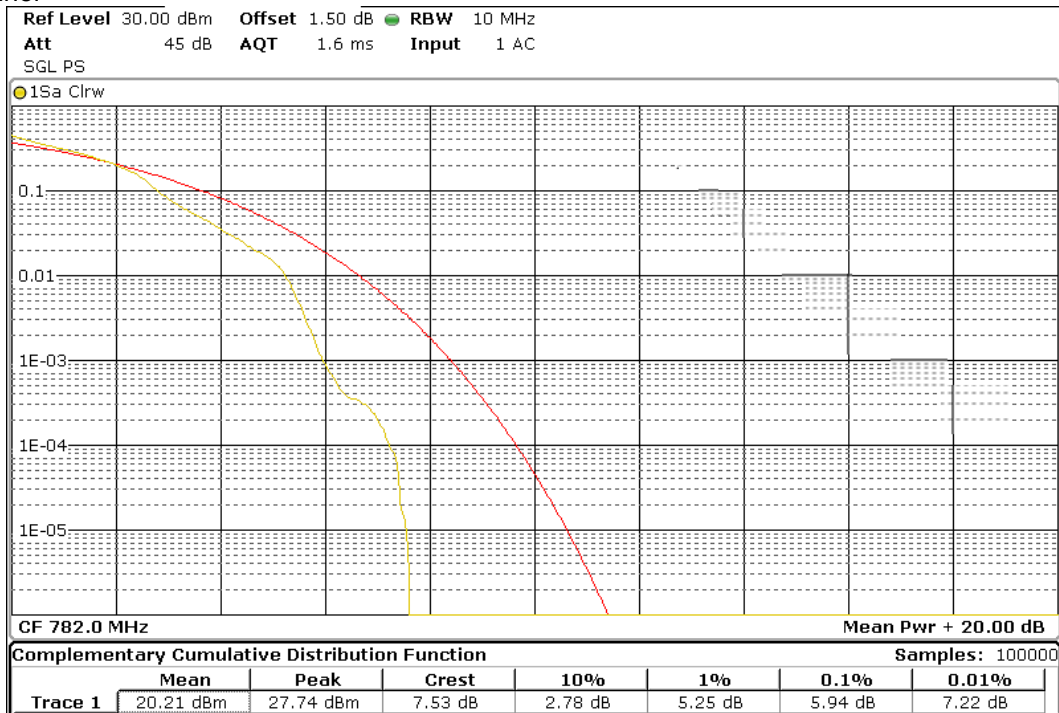

TEST A.2: MODULATION CHARACTERISTICS

LIMITS:	Product standard:	FCC Part 27 / IC RSS-139/ IC RSS-130
	Test standard:	FCC §2.1047 and §27.50. RSS-139 Clause 6.2/RSS-130 Clause 4.2

LIMITS

A curve or equivalent data which shows that the equipment will meet the modulation requirements of the rules under which the equipment is to be licensed.

TEST SETUP

For LTE the EUT operates with QPSK and 16QAM modulation modes in which the information is digitized and coded into a bit stream. The RF transmission is multiplexed using Orthogonal Frequency Division Multiplexing (OFDM) using different possible arrangement of subcarriers (Resource Blocks RB).

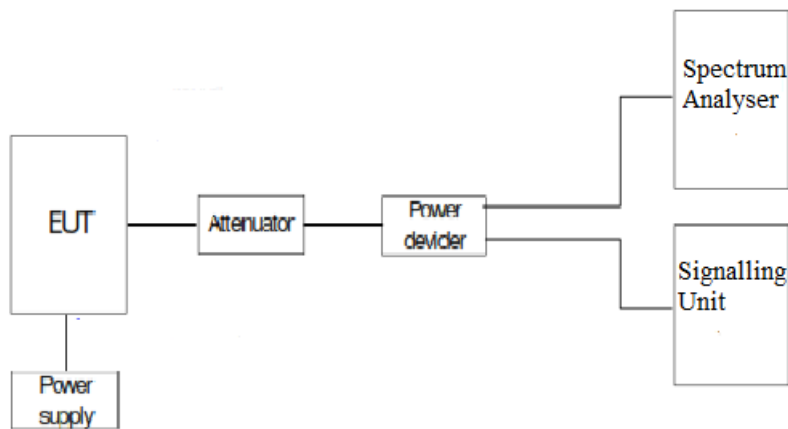

TESTED SAMPLES:	S/01
TESTED CONDITIONS MODES:	TC#01
TEST RESULTS:	PASS

QPSK Modulation

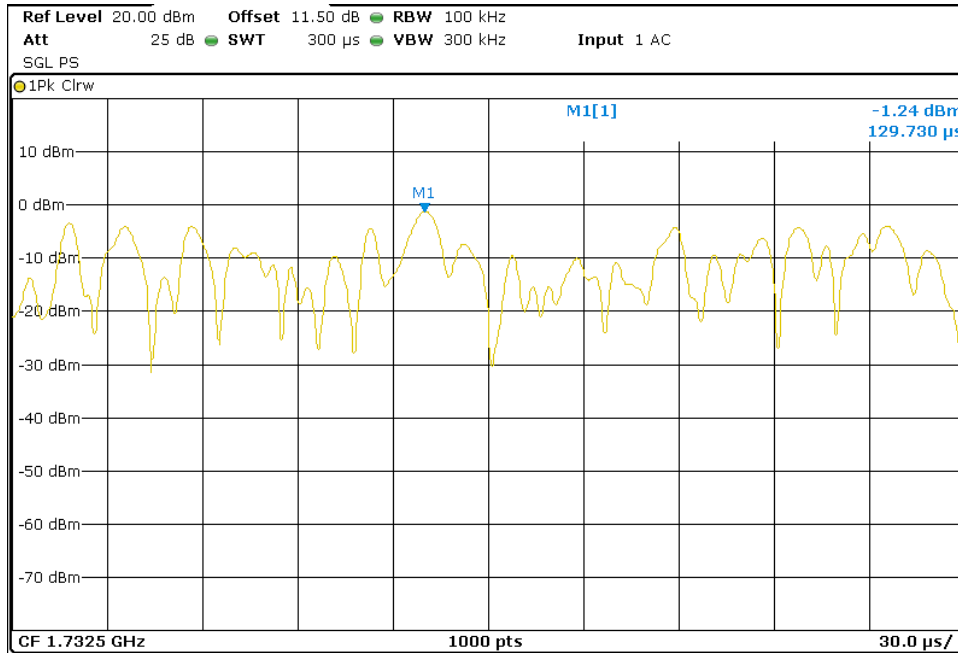

16QAM Modulation

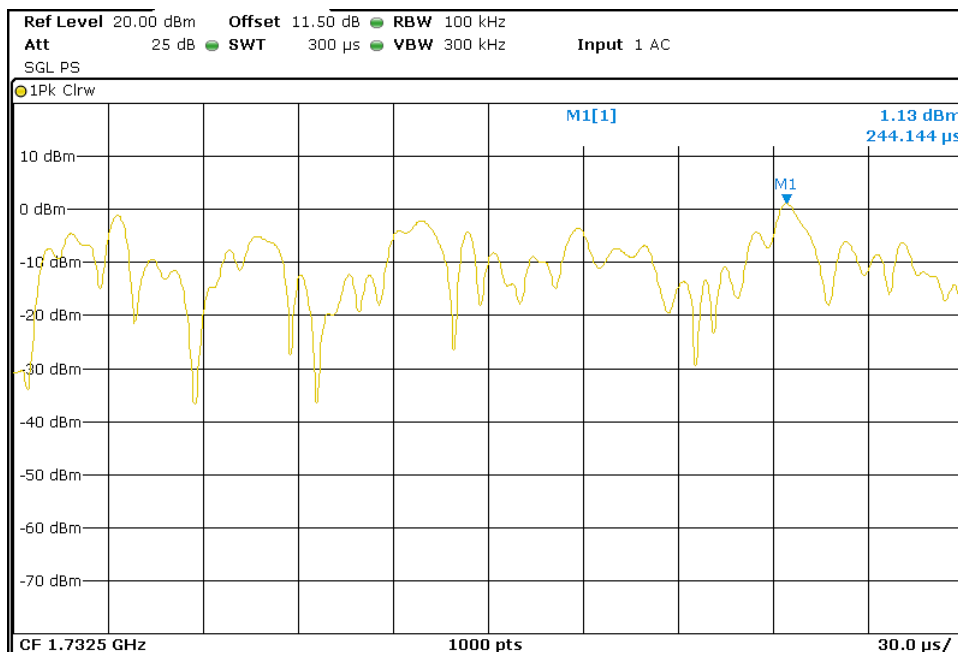

TESTED SAMPLES:	S/01
TESTED CONDITIONS MODES:	TC#02
TEST RESULTS:	PASS

QPSK Modulation

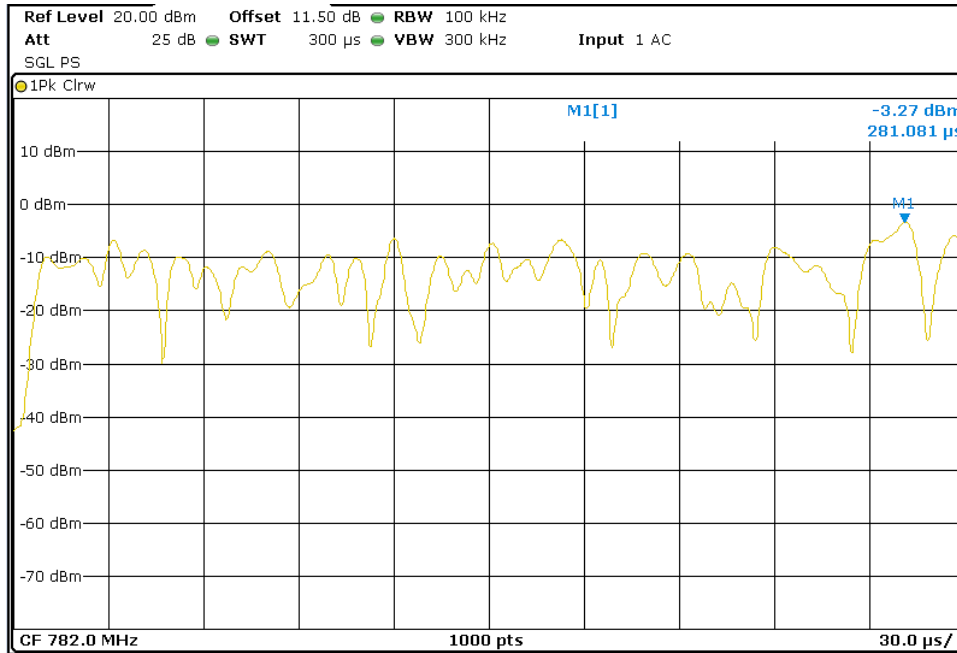

16QAM Modulation

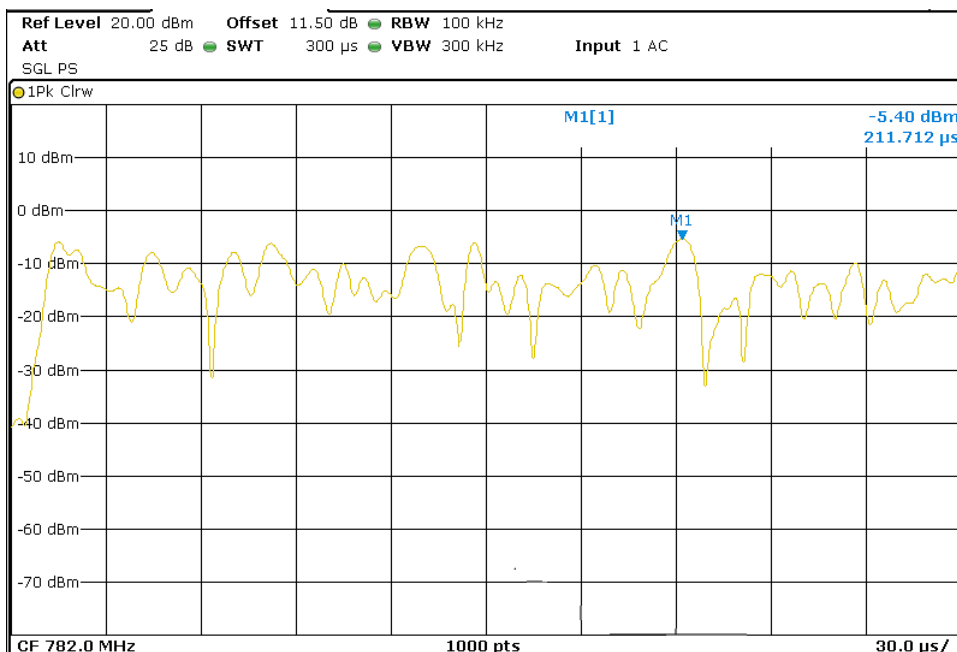

TEST A.3: FREQUENCY STABILITY

LIMITS:	Product standard:	FCC Part 27 / IC RSS-139/ IC RSS-130
	Test standard:	FCC §2.1055 and § 27.54/ RSS-139 Clause 6.4/RSS-130 Clause 4.5

LIMITS

The frequency stability shall be sufficient to ensure that the fundamental emissions stay within the authorized bands of operation.

TEST SETUP

The frequency tolerance measurements over temperature variations were made over the temperature range of -30°C to $+50^{\circ}\text{C}$. The EUT was placed inside a climatic chamber and the temperature was raised hourly in 10°C steps from -30°C up to $+50^{\circ}\text{C}$.

The supply voltage was varied between 85% and 115% of nominal voltage.

The EUT was set in "call mode" in the middle channel using the Universal Radio Communication tester R&S CMW500 and the maximum frequency error was measured using the built-in calibrated frequency meter.

For LTE mode the QPSK modulation was used for the test as it is the worst case for conducted power.

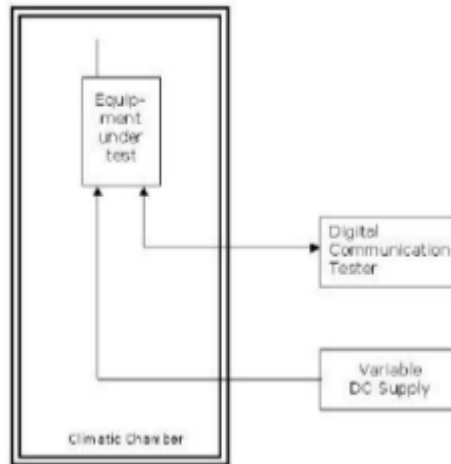

TESTED SAMPLES:	S/01
TESTED CONDITIONS MODES:	TC#01
TEST RESULTS:	PASS

LTE QPSK MODULATION. BW = 5 MHz

Frequency stability over temperature variations

Temperature (°C)	Frequency Error (Hz)	Frequency Error (ppm)	Frequency Error (%)
50	-22.41	-0.0129	-0.00000129
40	-21.95	-0.0127	-0.00000127
30	-12.04	-0.0069	-0.00000069
20	-16.27	-0.0094	-0.00000094
10	-8.91	-0.0051	-0.00000051
0	-13.27	-0.0077	-0.00000077
-10	-12.56	-0.0072	-0.00000072
-20	-16.89	-0.0097	-0.00000097
-30	-12.07	-0.0070	-0.00000070

Frequency stability over voltage variations

Battery Supply voltage	Voltage (V)	Frequency Error (Hz)	Frequency Error (ppm)	Frequency Error (%)
Vmax	4.37	-14.21	-0.0082	-0.00000082
Vmin	3.23	-18.98	-0.0110	-0.00000110

TESTED SAMPLES:	S/01
TESTED CONDITIONS MODES:	TC#02
TEST RESULTS:	PASS

LTE QPSK MODULATION. BW = 5 MHz

Frequency stability over temperature variations

Temperature (°C)	Frequency Error (Hz)	Frequency Error (ppm)	Frequency Error (%)
50	-11.77	-0.0151	-0.00000151
40	-12.13	-0.0155	-0.00000155
30	9.86	0.0126	0.00000126
20	12.90	0.0165	0.00000165
10	-14.56	-0.0186	-0.00000186
0	-13.53	-0.0173	-0.00000173
-10	-10.11	-0.0129	-0.00000129
-20	12.80	0.0164	0.00000164
-30	16.29	0.0208	0.00000208

Frequency stability over voltage variations

Battery Supply voltage	Voltage (V)	Frequency Error (Hz)	Frequency Error (ppm)	Frequency Error (%)
Vmax	4.37	12.13	0.0155	0.00000155
Vmin	3.23	-11.30	-0.0145	-0.00000145

TEST A.4: OCCUPIED BANDWIDTH

LIMITS:	Product standard:	FCC Part 27 / IC RSS-139/ IC RSS-130
	Test standard:	FCC § 2.1049/ RSS-139 Clause 6.4/RSS-130 Clause 4.5

LIMITS

Reference only.

TEST SETUP

The occupied bandwidth measurement was performed at the output terminals of the EUT using an attenuator, power splitter and spectrum analyzer. The EUT was controlled via the Universal Radio Communication tester R&S CMW500 selecting maximum transmission power of the EUT and different modes of modulation. The 99% occupied bandwidth and the -26 dBc bandwidth were measured directly using the built-in bandwidth measuring option of spectrum analyzer.

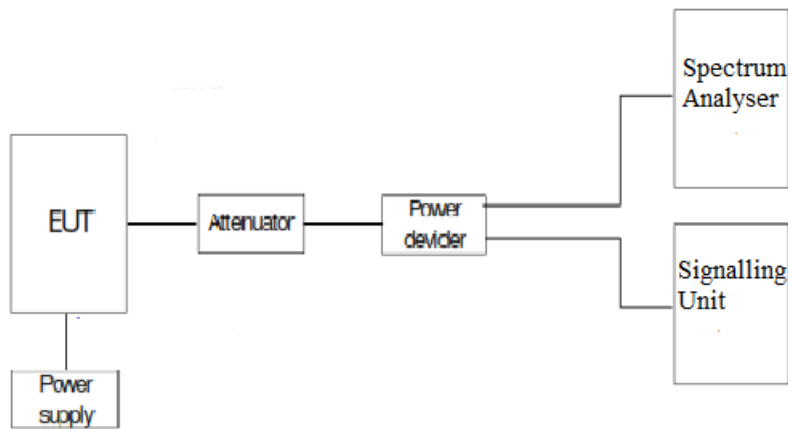

TESTED SAMPLES:	S/01
TESTED CONDITIONS MODES:	TC#01
TEST RESULTS:	PASS

RESULTS

LTE QPSK MODULATION. BW = 5 MHz

Channel	Lowest	Middle	Highest
99% Occupied bandwidth (MHz)	4.57	4.57	4.57
-26 dBc bandwidth (MHz)	5.12	5.12	5.09

LTE 16QAM MODULATION. BW = 5 MHz

Channel	Lowest	Middle	Highest
99% Occupied bandwidth (MHz)	4.57	4.57	4.57
-26 dBc bandwidth (MHz)	5.12	5.12	5.14

LTE QPSK MODULATION. BW = 10 MHz

Channel	Lowest	Middle	Highest
99% Occupied bandwidth (MHz)	9.04	9.04	9.04
-26 dBc bandwidth (MHz)	10.10	10.04	10.10

LTE 16QAM MODULATION. BW = 10 MHz

Channel	Lowest	Middle	Highest
99% Occupied bandwidth (MHz)	9.04	9.06	9.06
-26 dBc bandwidth (MHz)	10.13	10.04	10.04

LTE QPSK MODULATION. BW = 15 MHz

Channel	Lowest	Middle	Highest
99% Occupied bandwidth (MHz)	13.62	13.65	13.62
-26 dBc bandwidth (MHz)	15.22	15.23	15.34

TEST RESULTS (Cont):

LTE 16QAM MODULATION. BW = 15 MHz

Channel	Lowest	Middle	Highest
99% Occupied bandwidth (MHz)	13.65	13.68	13.65
-26 dBc bandwidth (MHz)	15.35	15.28	15.36

LTE QPSK MODULATION. BW = 20 MHz

Channel	Lowest	Middle	Highest
99% Occupied bandwidth (MHz)	18.04	18.08	18.04
-26 dBc bandwidth (MHz)	19.77	19.89	19.90

LTE 16QAM MODULATION. BW = 20 MHz

Channel	Lowest	Middle	Highest
99% Occupied bandwidth (MHz)	18.04	18.08	18.04
-26 dBc bandwidth (MHz)	19.94	19.95	19.90

LTE QPSK MODULATION. BW = 5 MHz

Lowest Channel 99% Occupied Bandwidth

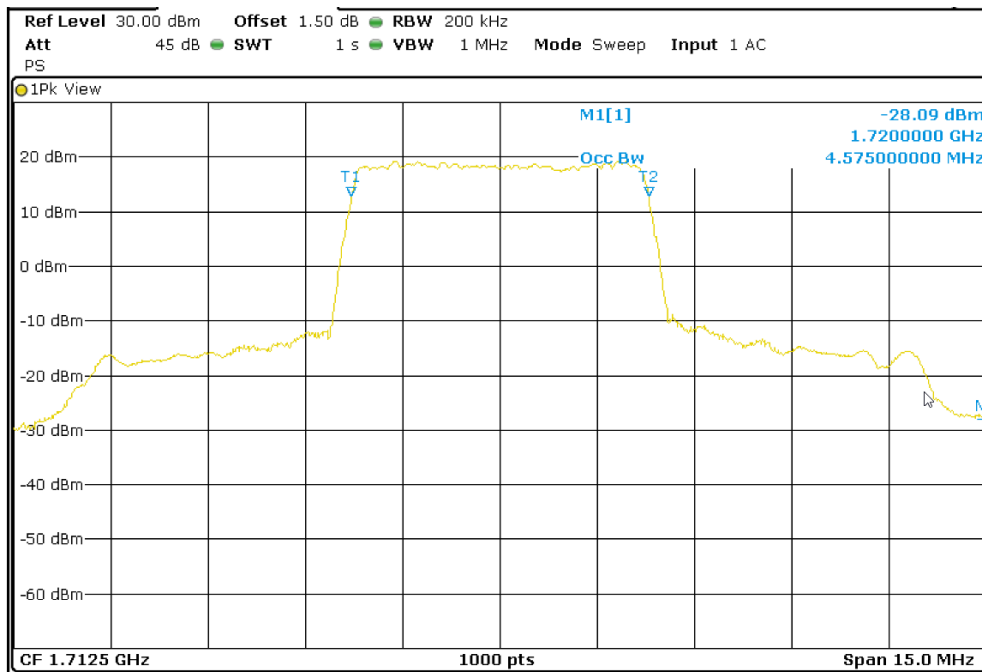

TEST RESULTS (Cont):

Lowest Channel -26dBc Bandwidth kHz

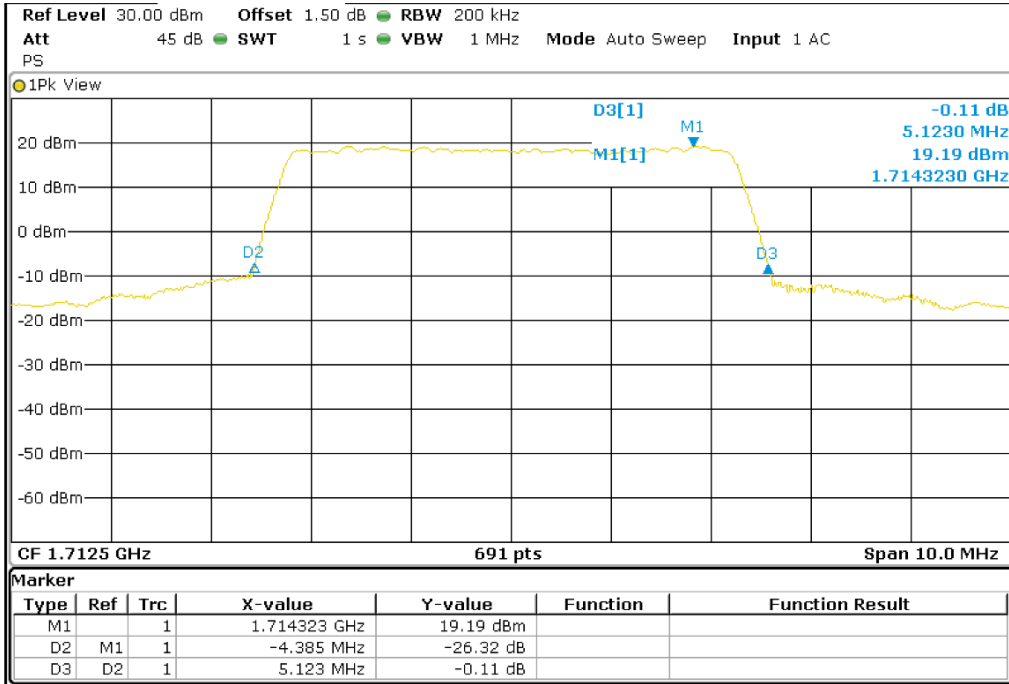

Middle Channel 99% Occupied Bandwidth

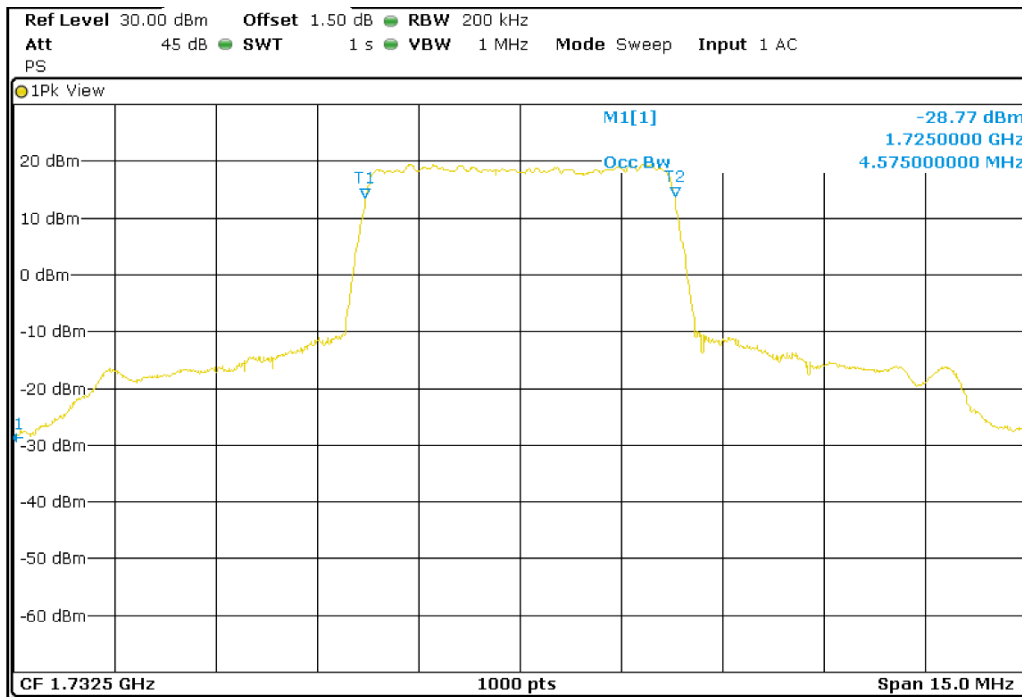

TEST RESULTS (Cont):

Middle Channel 26dBc Bandwidth kHz

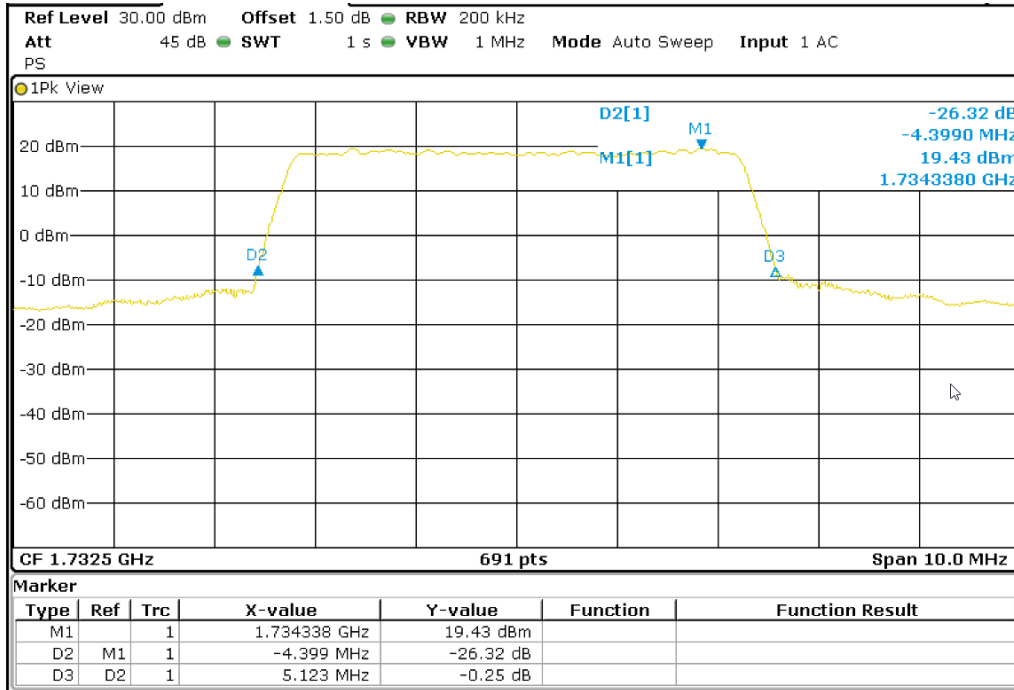

Highest Channel 99% Occupied Bandwidth

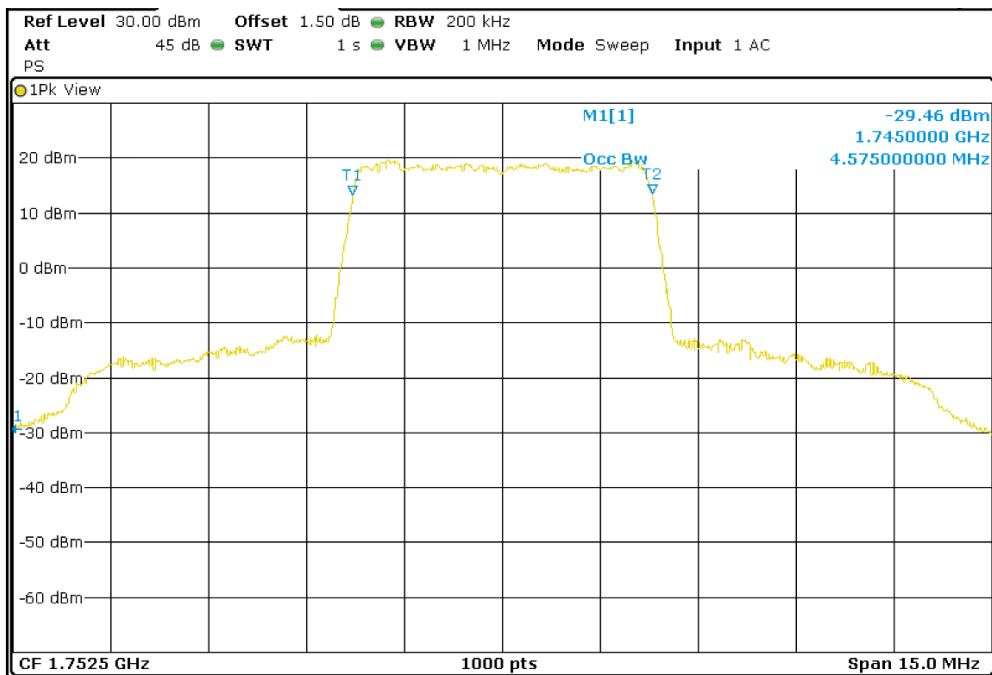

TEST RESULTS (Cont):

Highest Channel 26dBc Bandwidth kHz

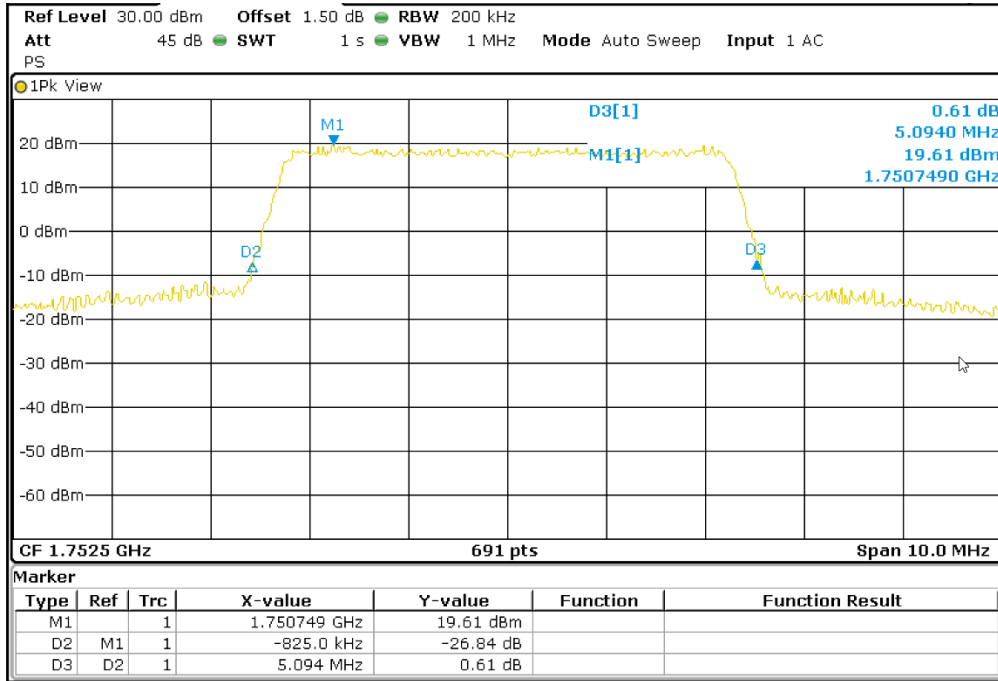

LTE 16QAM MODULATION. BW = 5 MHz

Lowest Channel 99% Occupied Bandwidth

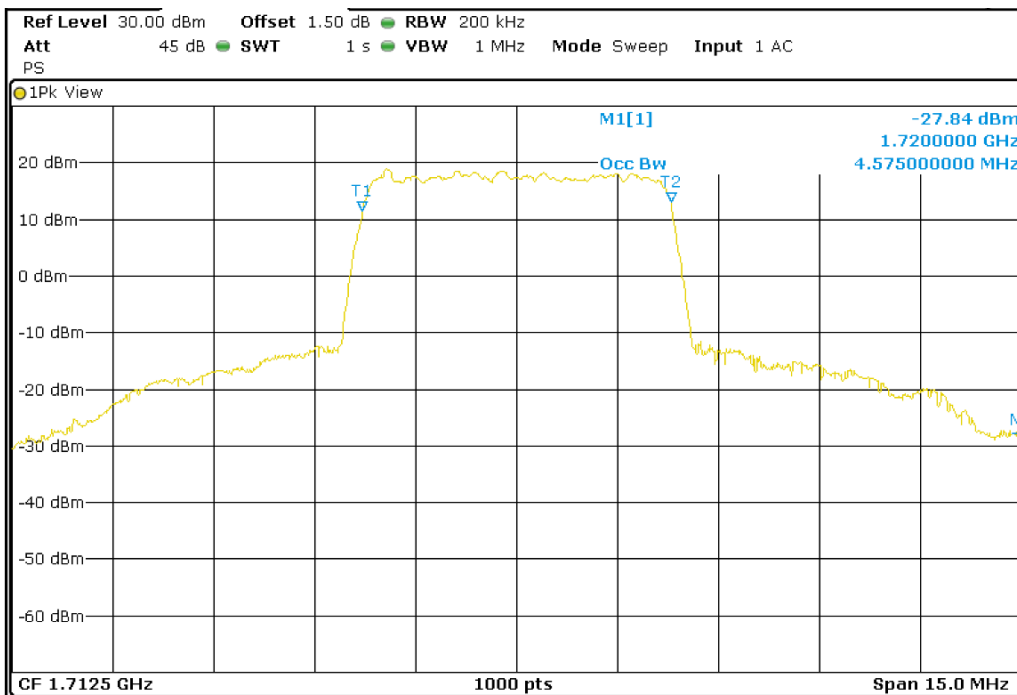

TEST RESULTS (Cont):

Lowest Channel -26dBc Bandwidth kHz

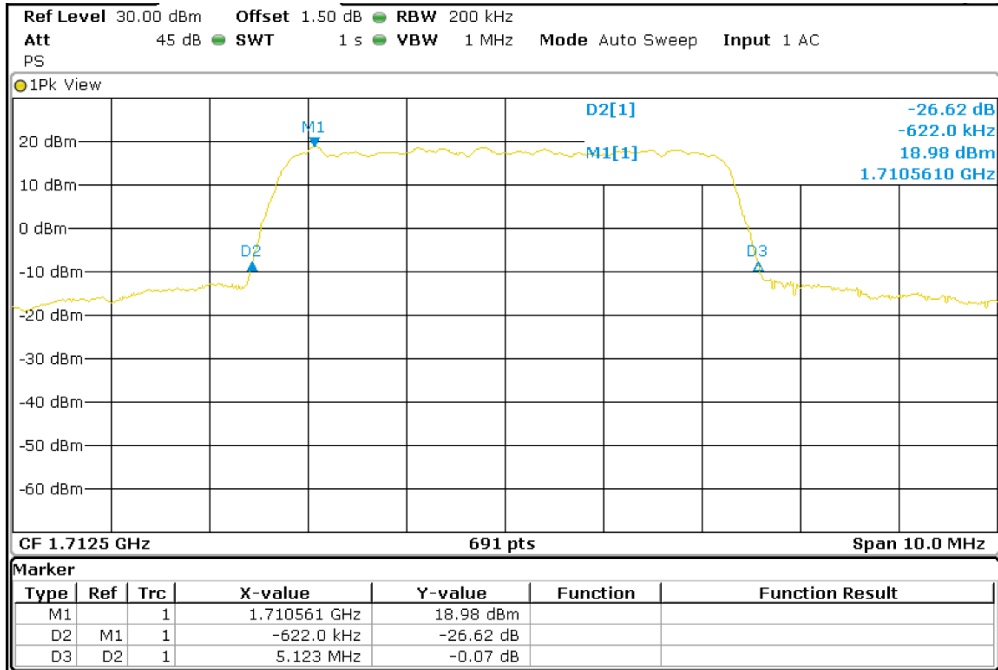

Middle Channel 99% Occupied Bandwidth

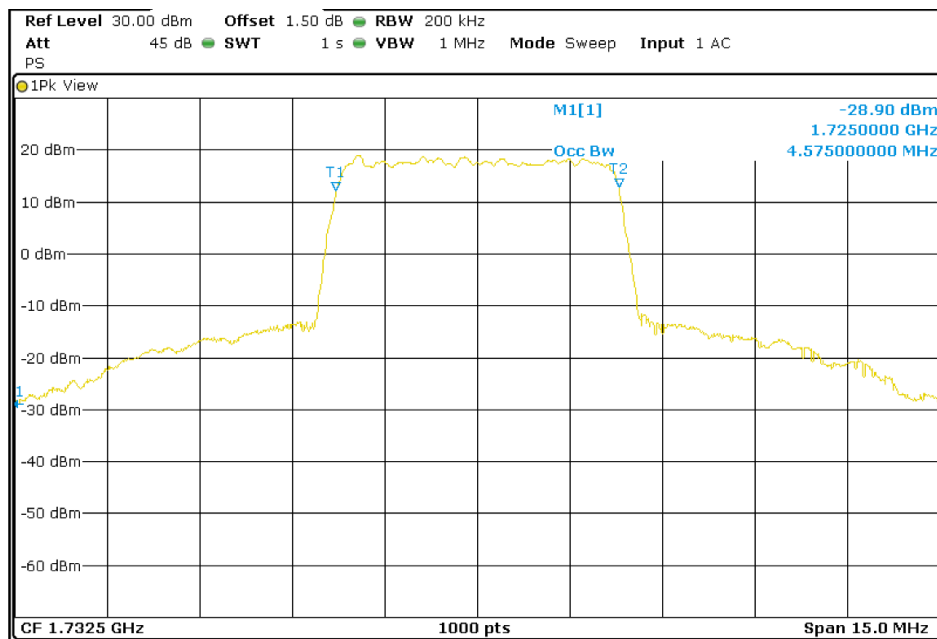

TEST RESULTS (Cont):

Middle Channel 26dBc Bandwidth kHz

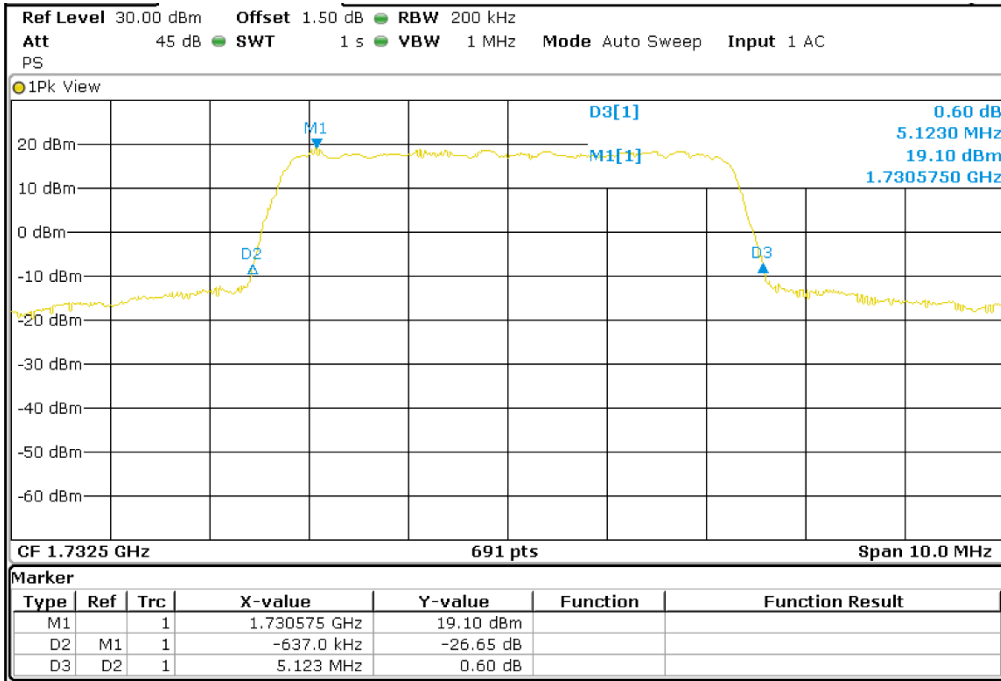

Highest Channel 99% Occupied Bandwidth

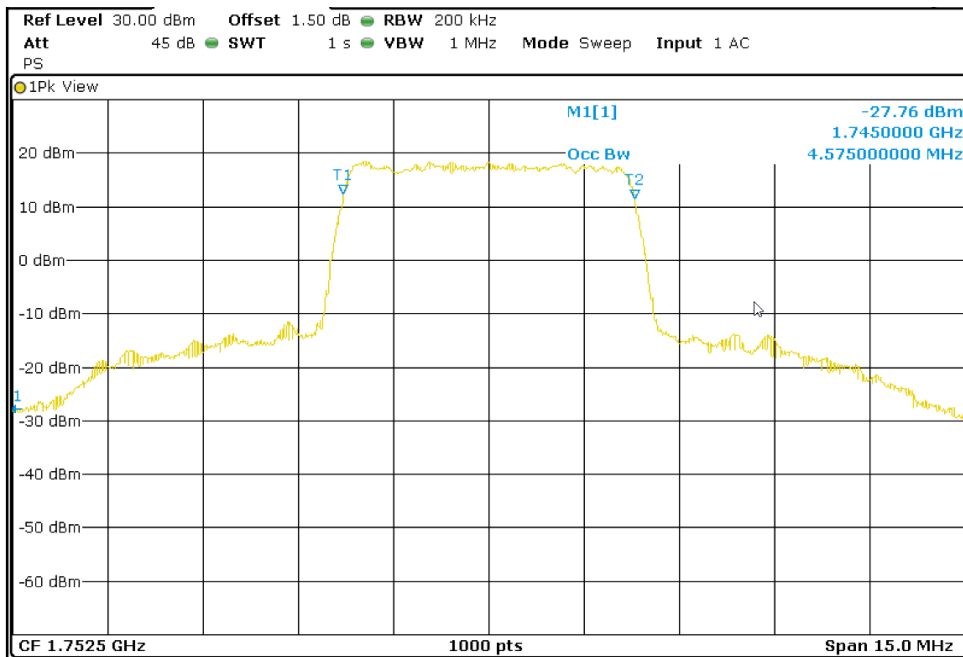

TEST RESULTS (Cont):

Highest Channel 26dBc Bandwidth kHz

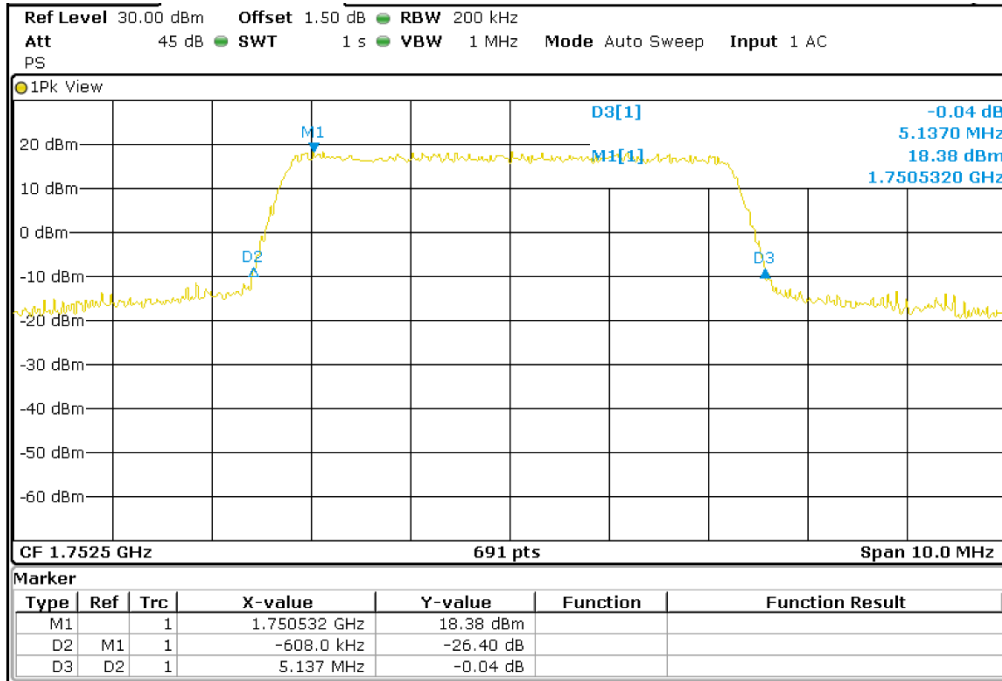

LTE QPSK MODULATION. BW = 10 MHz

Lowest Channel 99% Occupied Bandwidth

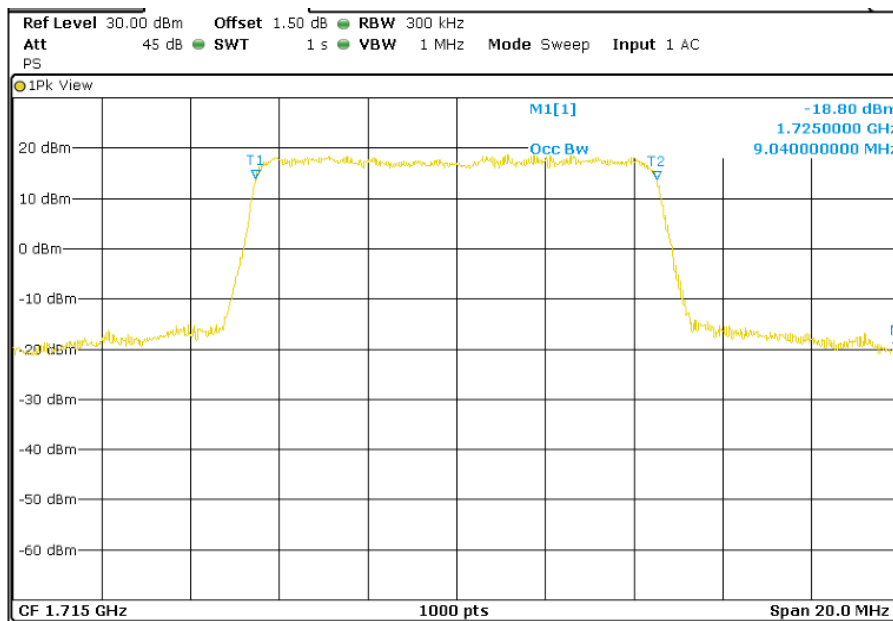

TEST RESULTS (Cont):

Lowest Channel -26dBc Bandwidth kHz

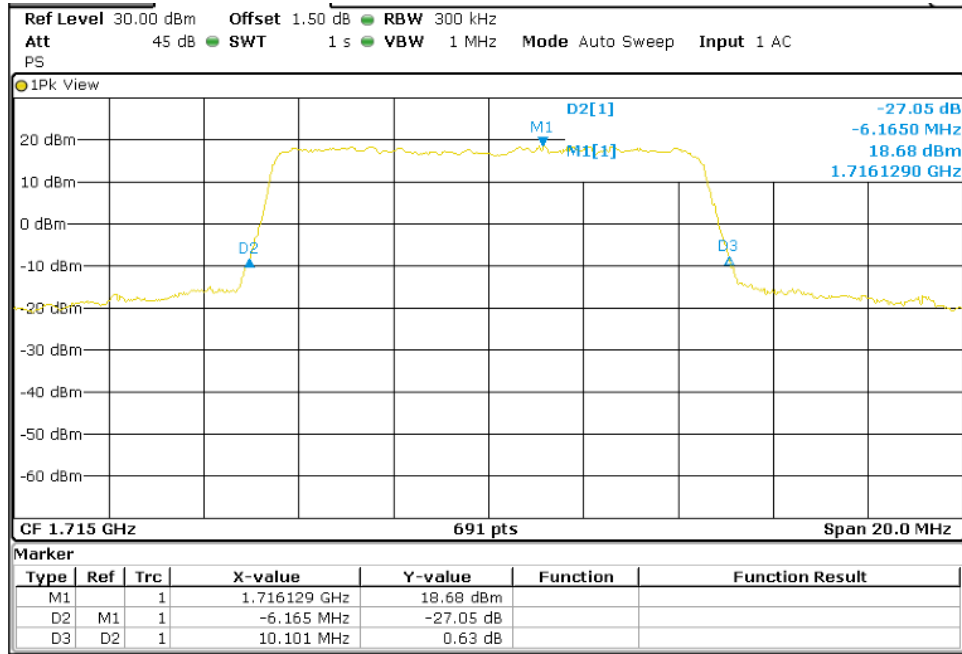

Middle Channel 99% Occupied Bandwidth

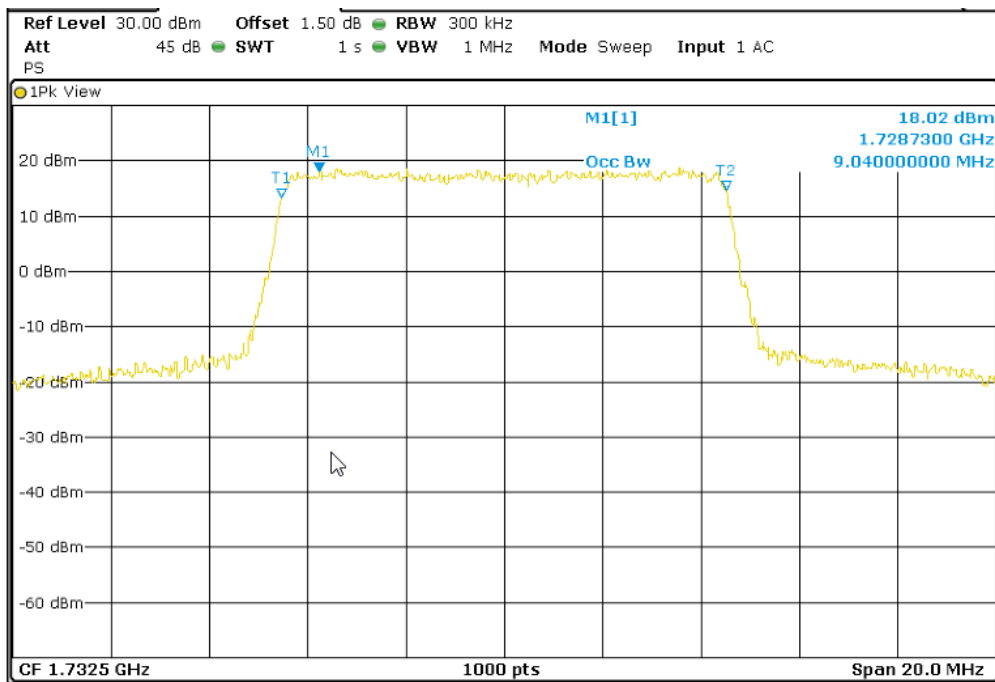

TEST RESULTS (Cont):

Highest Channel 26dBc Bandwidth kHz

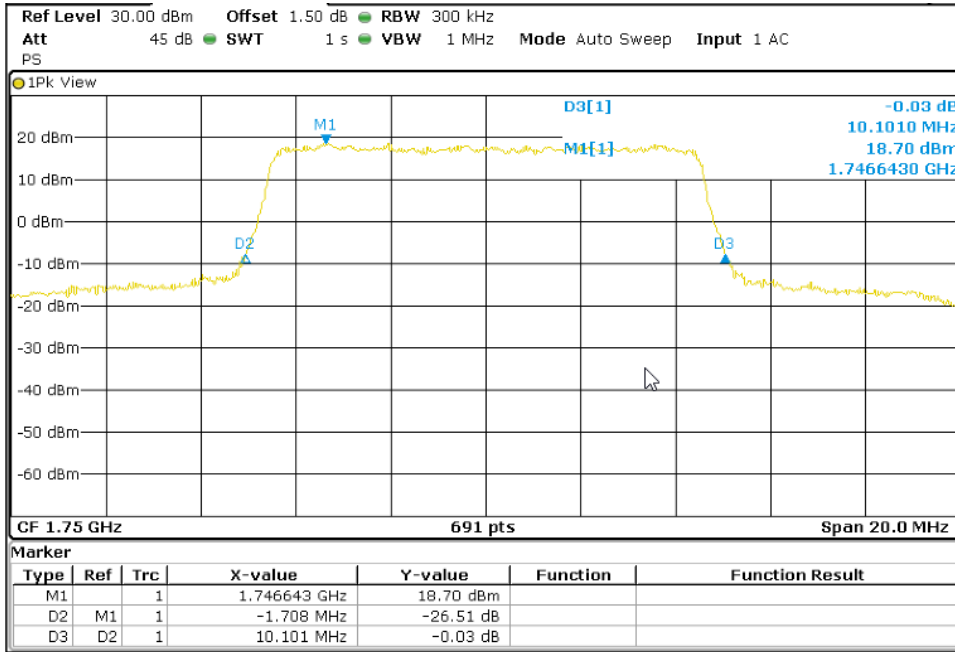

LTE 16QAM MODULATION. BW = 10 MHz

Lowest Channel 99% Occupied Bandwidth

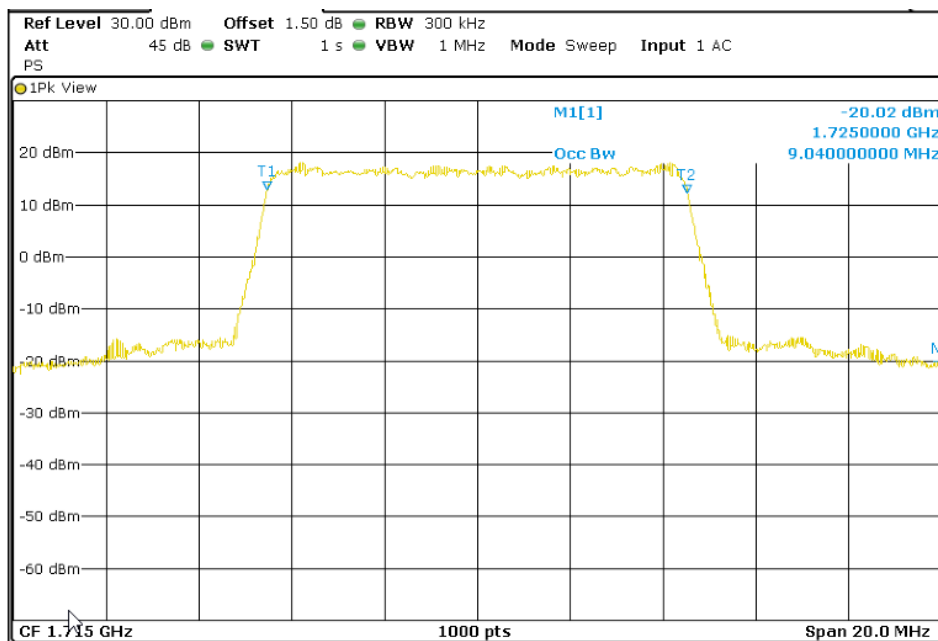

TEST RESULTS (Cont):

Lowest Channel 26dBc Bandwidth kHz

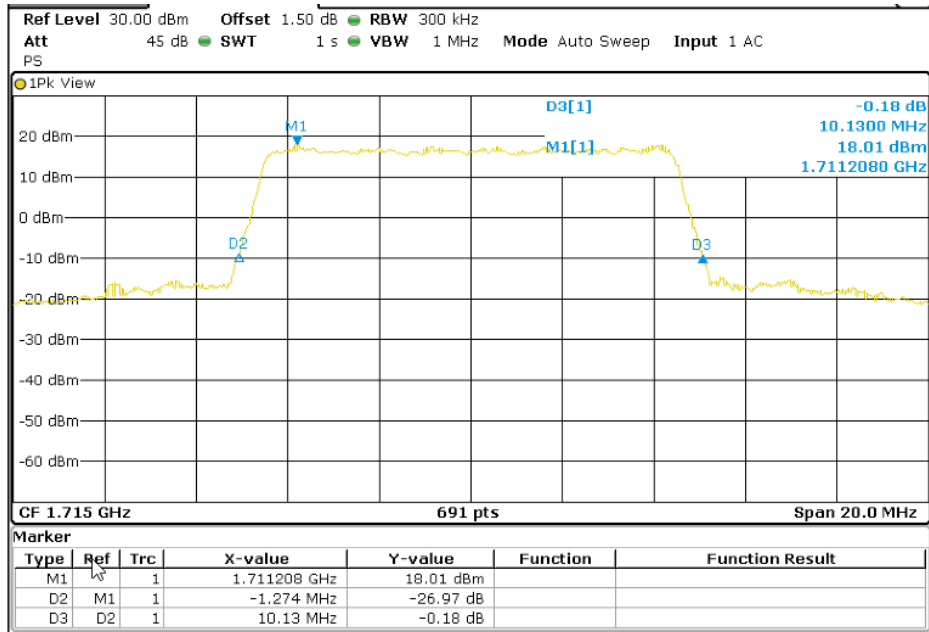

Middle Channel 99% Occupied Bandwidth

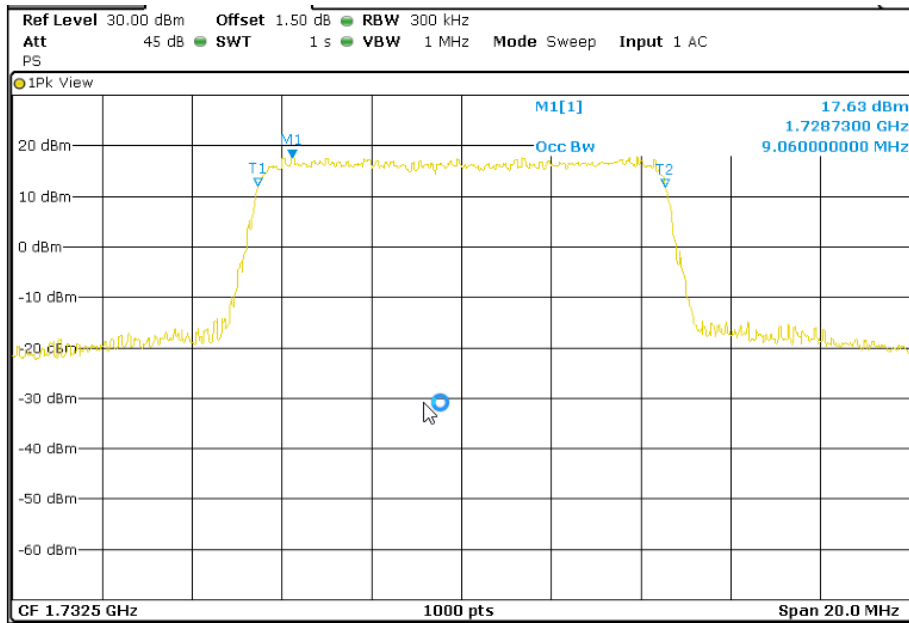

TEST RESULTS (Cont):

Middle Channel 26dBc Bandwidth kHz

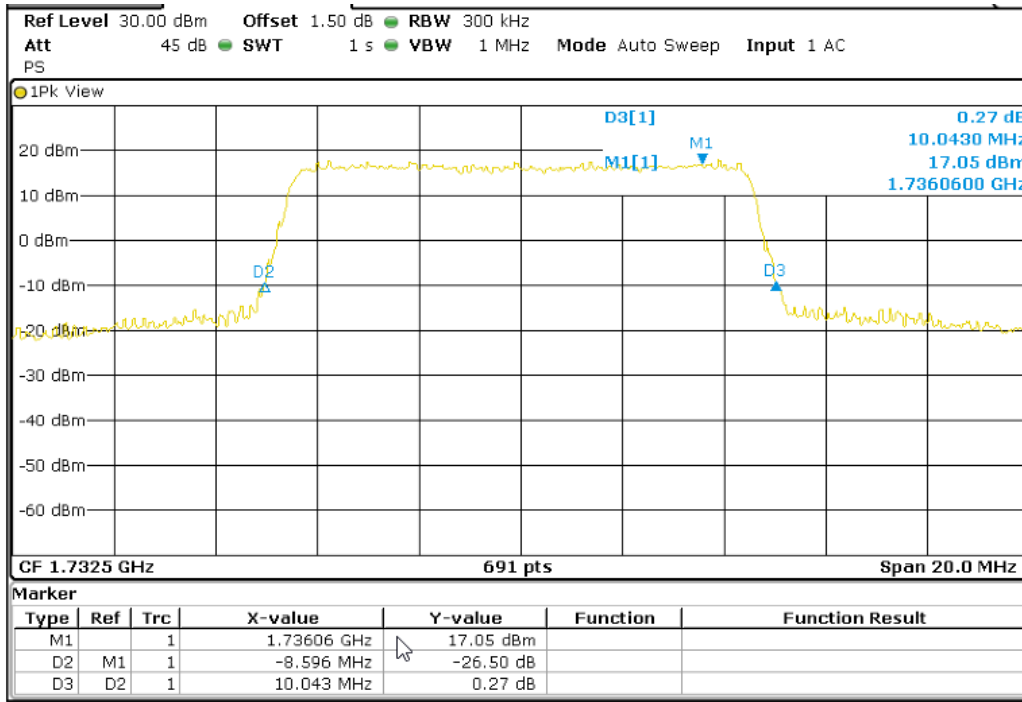

Highest Channel 99% Occupied Bandwidth

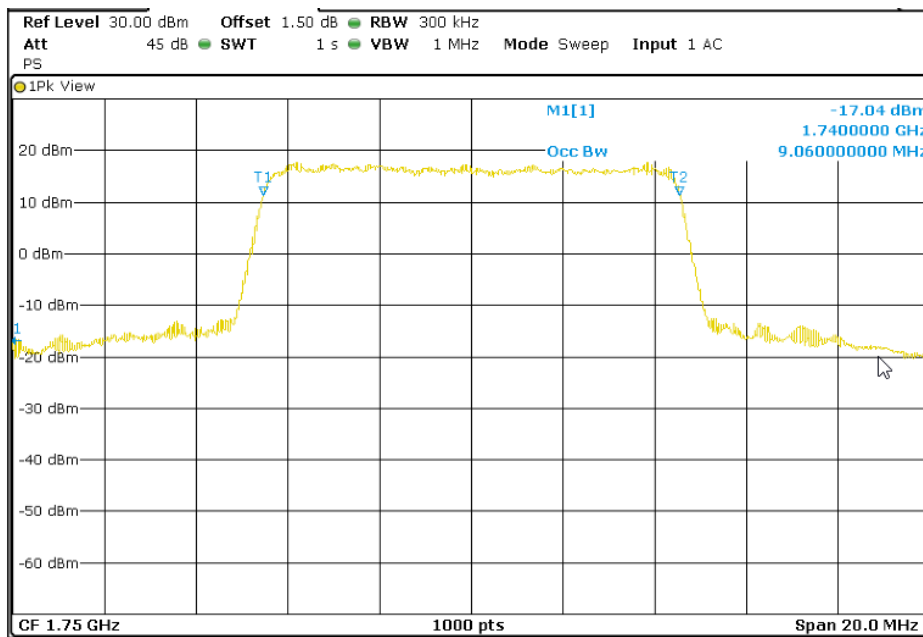

TEST RESULTS (Cont):

Highest Channel 26dBc Bandwidth kHz

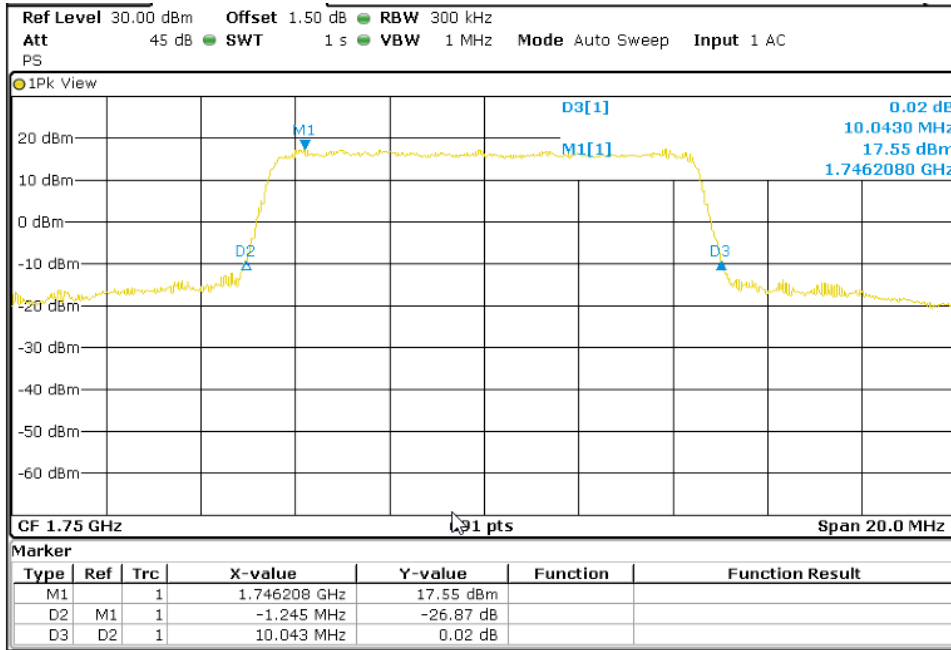

LTE QPSK MODULATION. BW = 15 MHz

Lowest Channel 99% Occupied Bandwidth

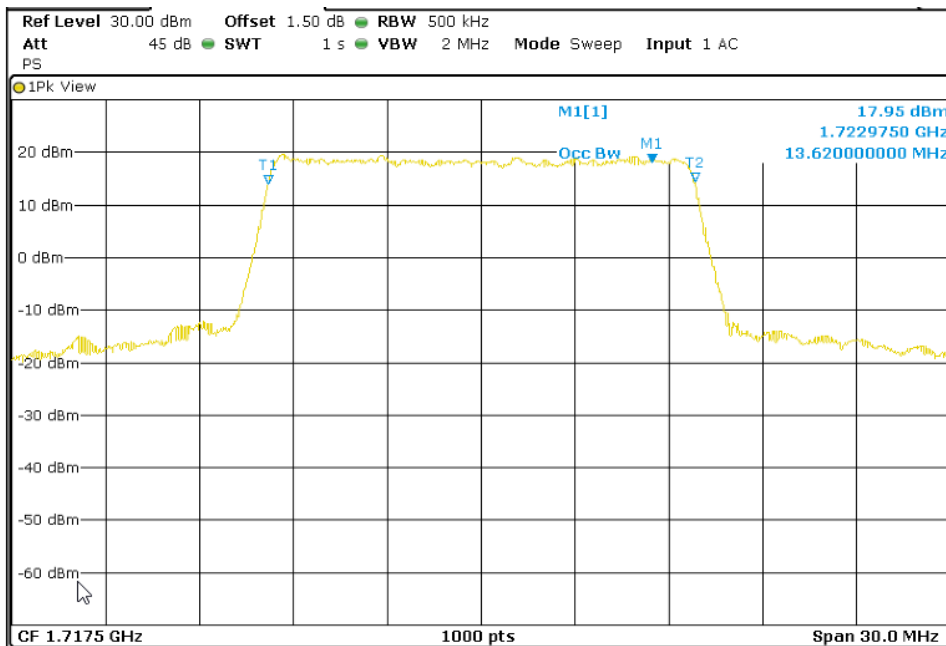

TEST RESULTS (Cont):

Lowest Channel 26dBc Bandwidth kHz

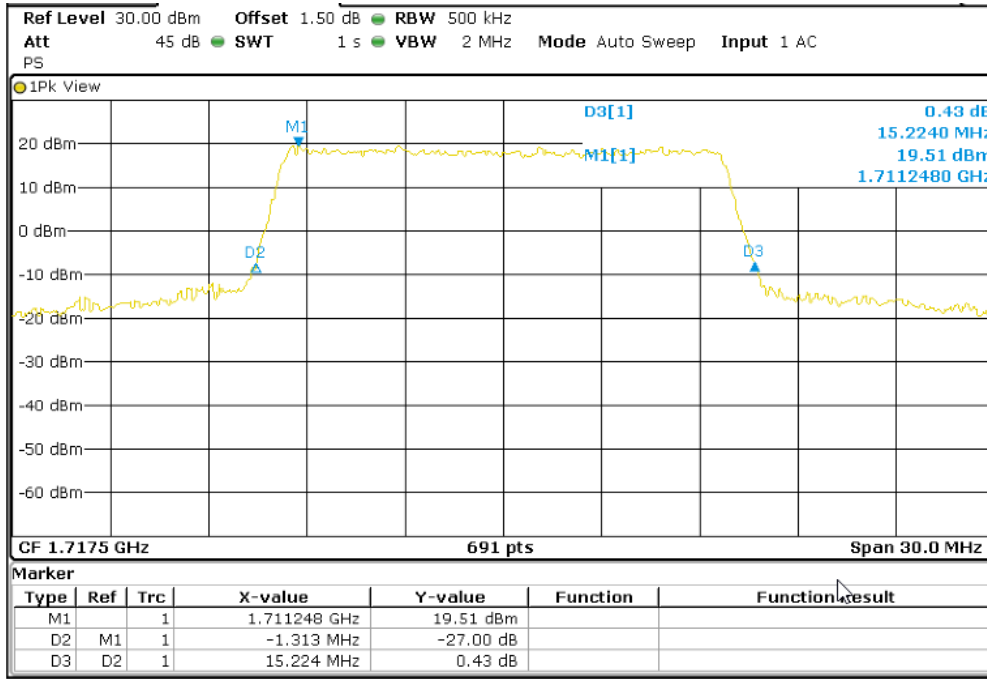

Middle Channel 99% Occupied Bandwidth

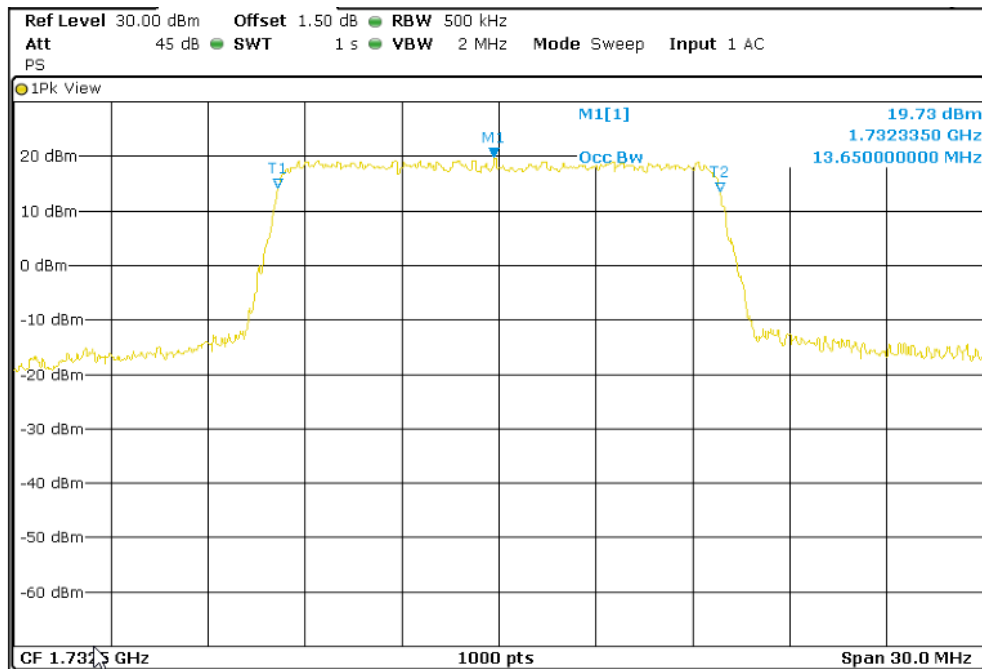

TEST RESULTS (Cont):

Middle Channel 26dBc Bandwidth kHz

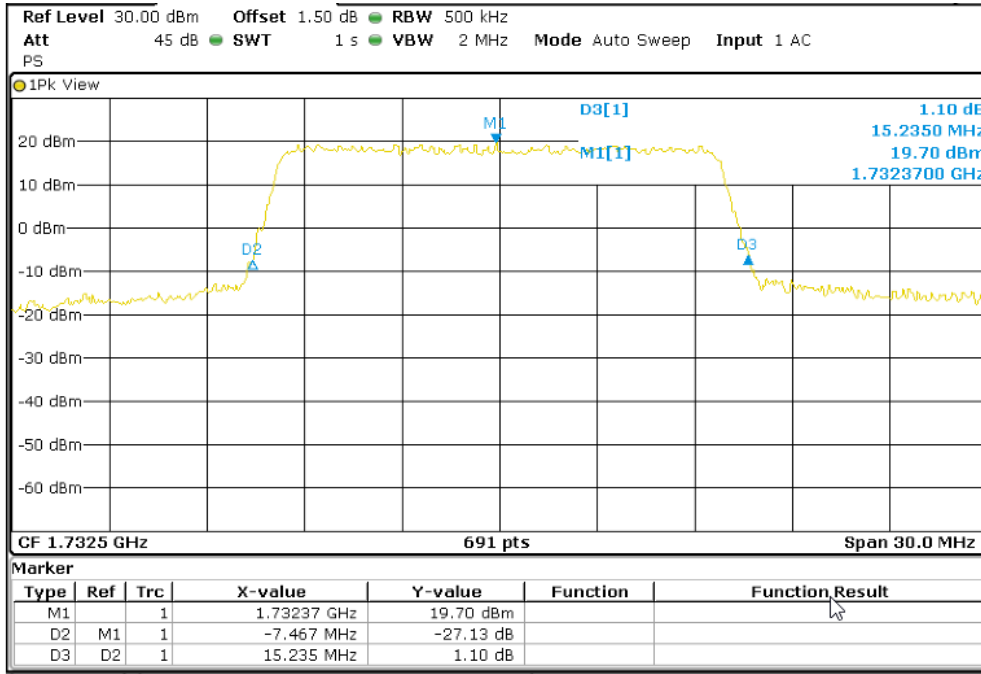

Highest Channel 99% Occupied Bandwidth

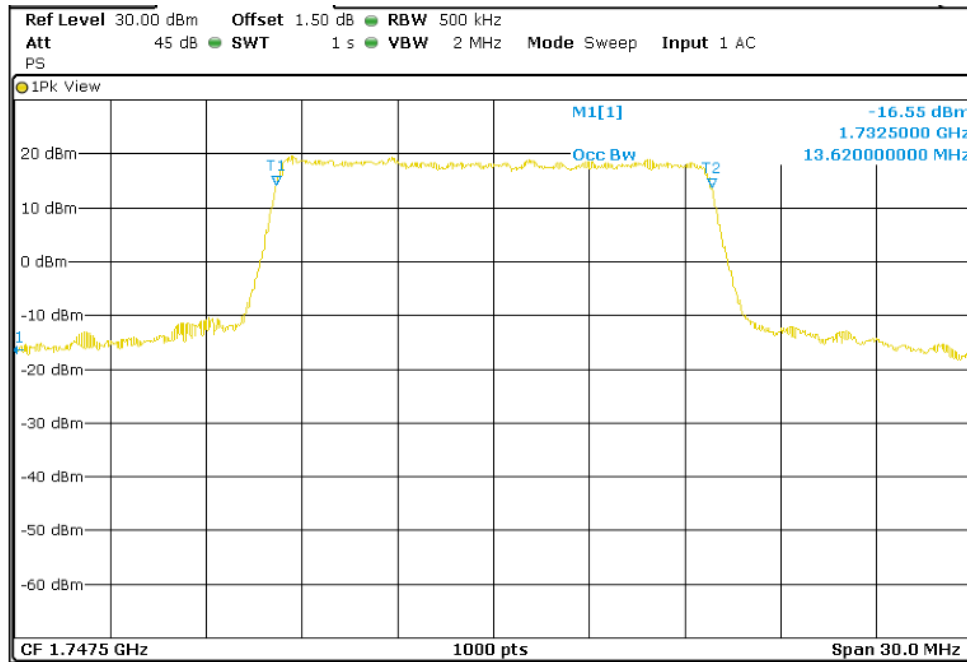

TEST RESULTS (Cont):

Highest Channel 26dBc Bandwidth kHz

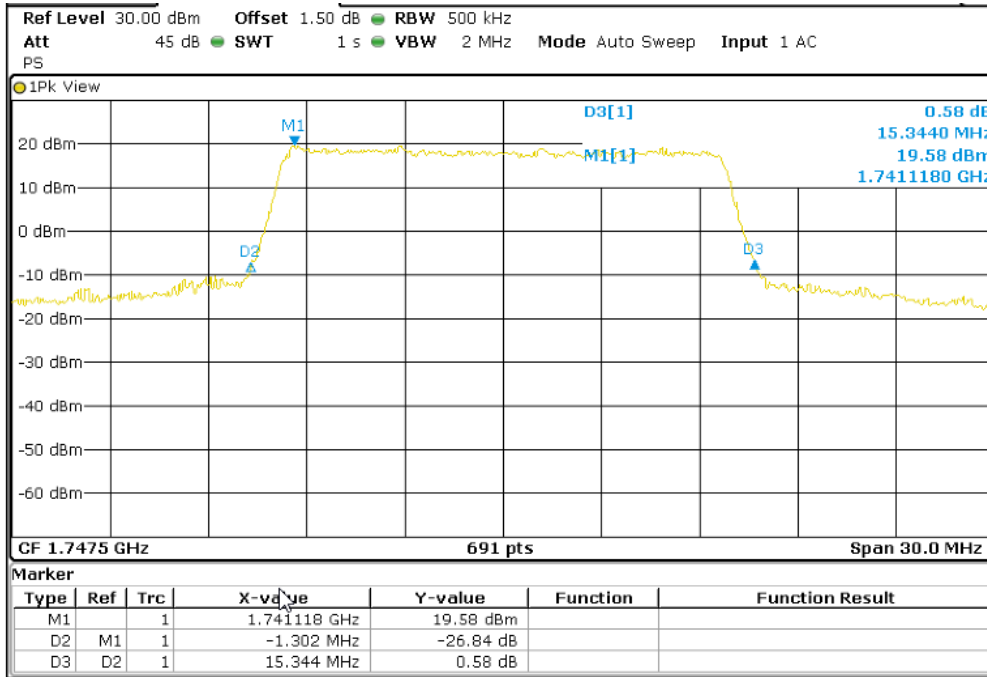

LTE 16QAM MODULATION. BW = 15 MHz

Lowest Channel 99% Occupied Bandwidth

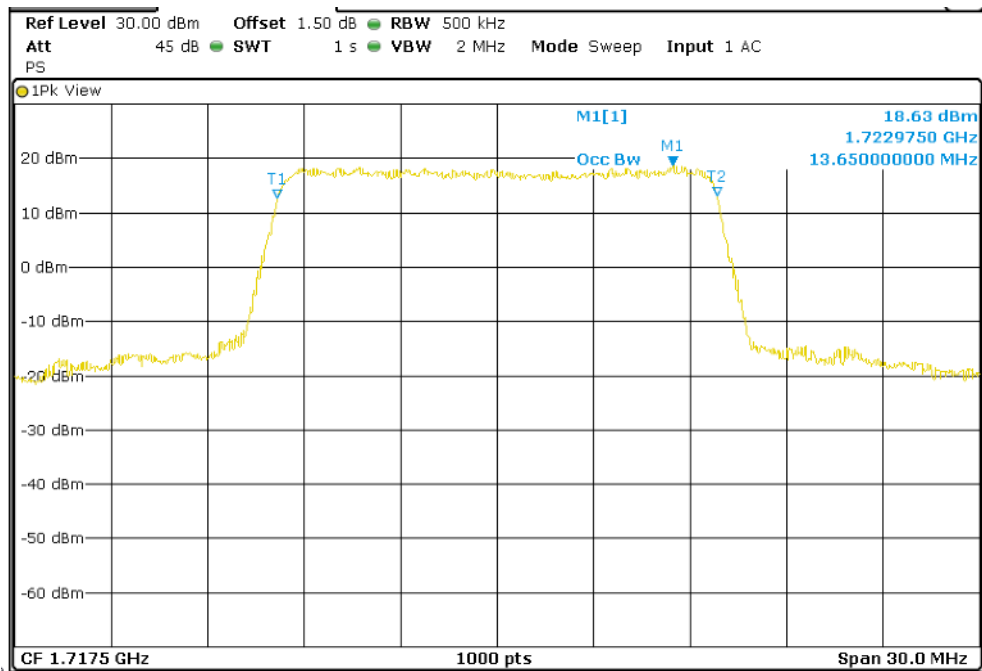

TEST RESULTS (Cont):

Lowest Channel 26dBc Bandwidth kHz

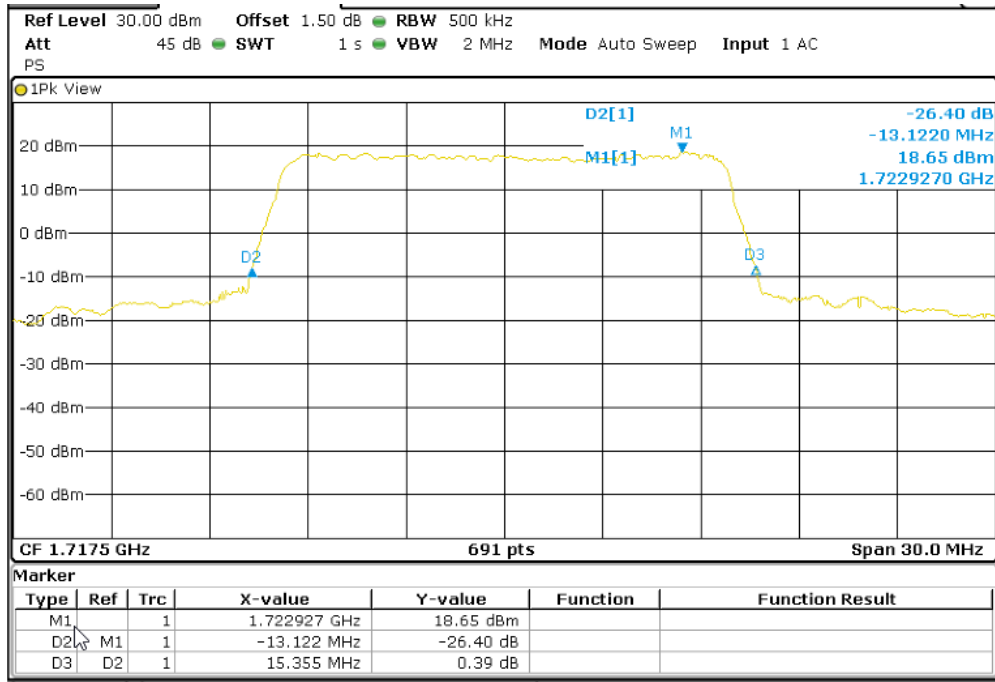

Middle Channel 99% Occupied Bandwidth

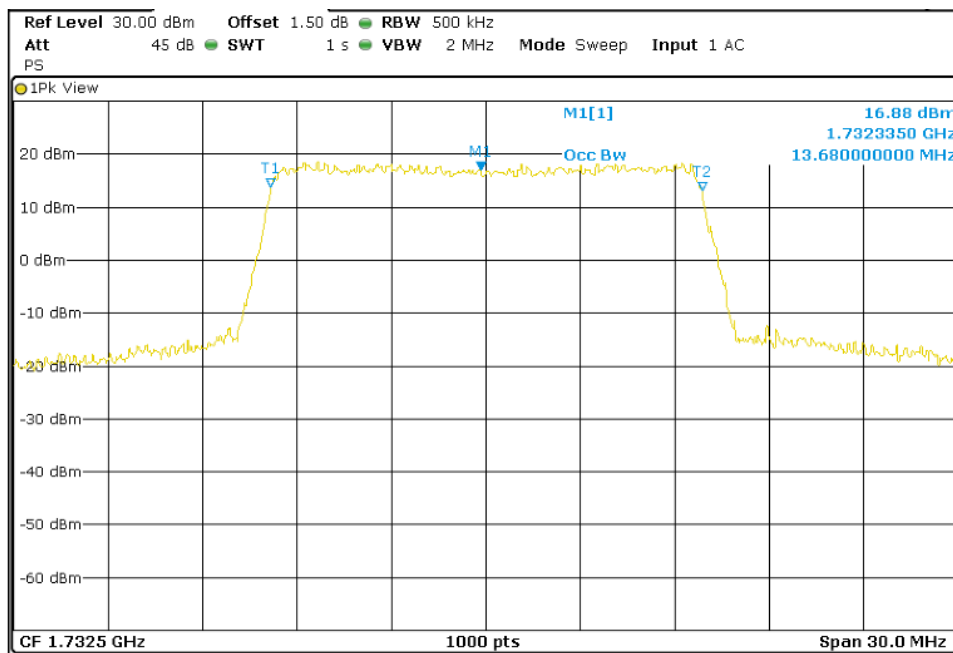

TEST RESULTS (Cont):

Middle Channel 26dBc Bandwidth kHz

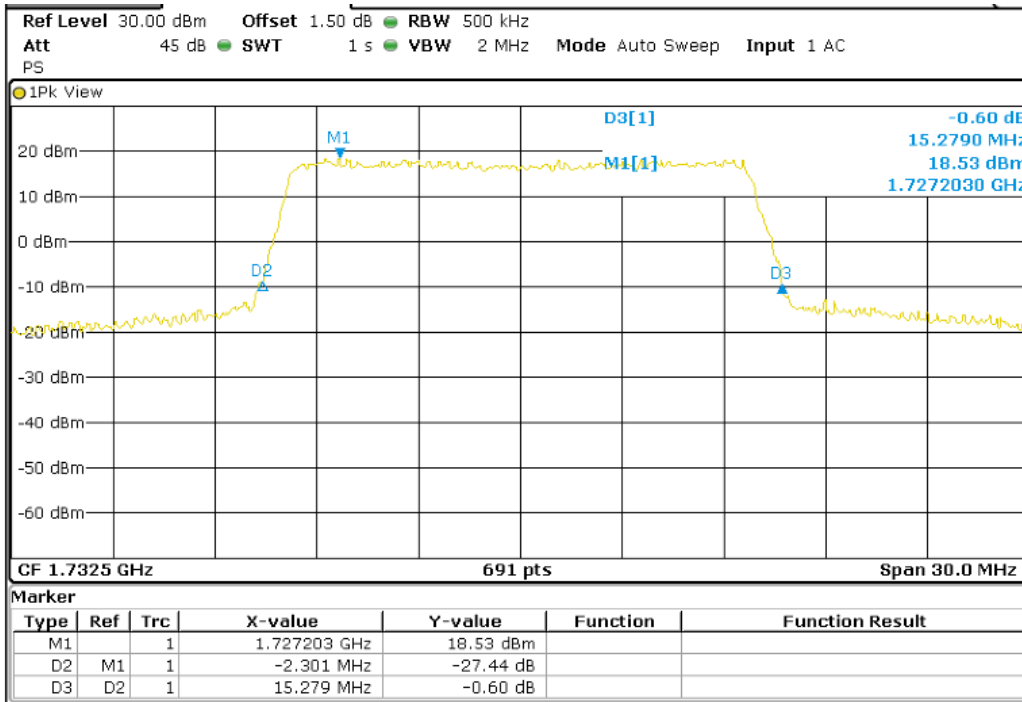

Highest Channel 99% Occupied Bandwidth

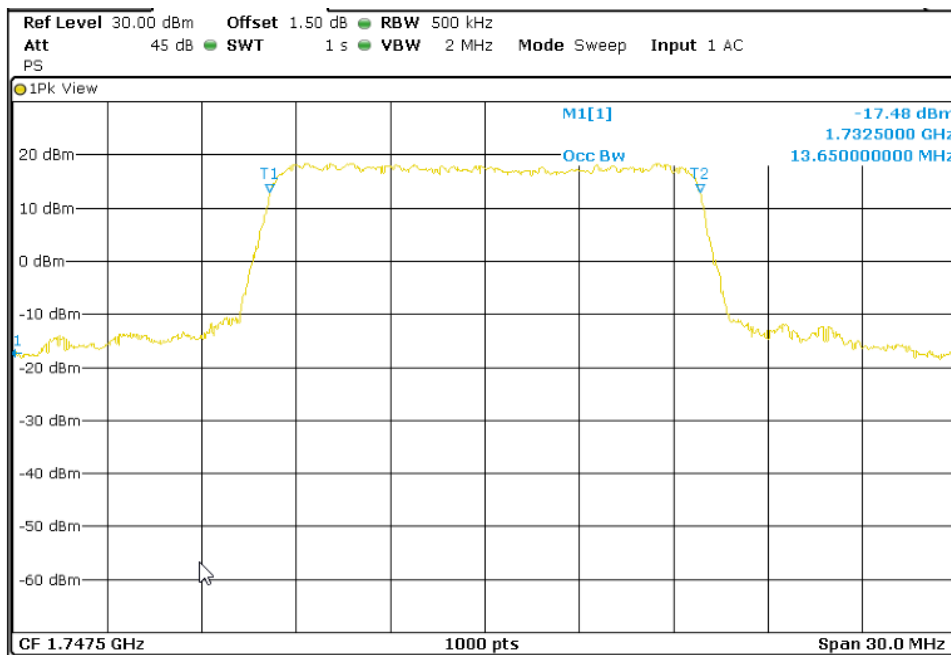

TEST RESULTS (Cont):

Highest Channel 26dBc Bandwidth kHz

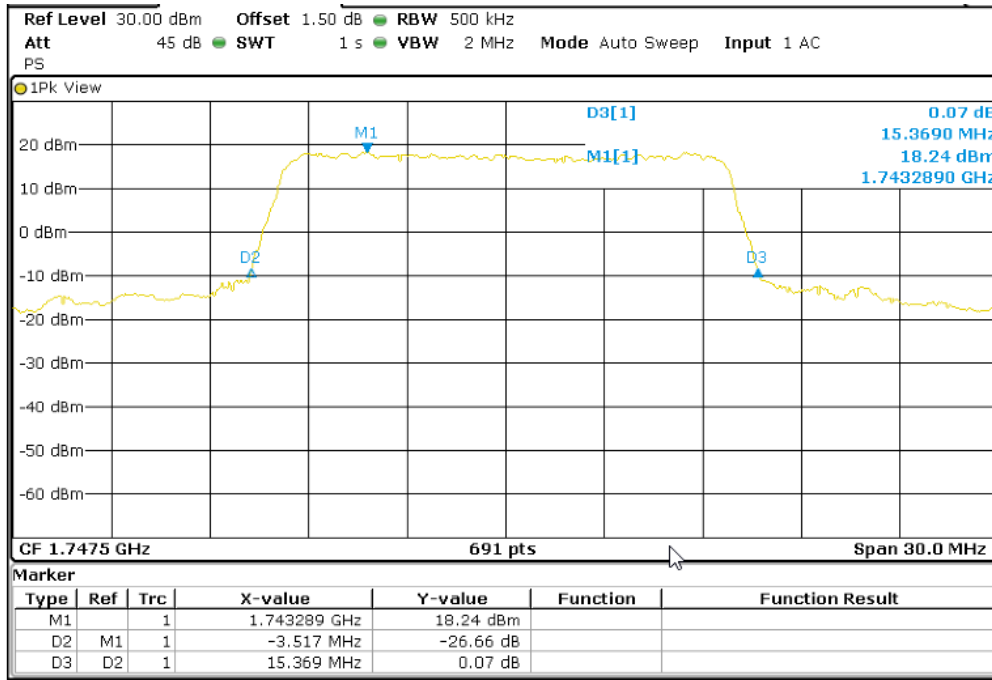

LTE QPSK MODULATION. BW = 20 MHz

Lowest Channel 99% Occupied Bandwidth

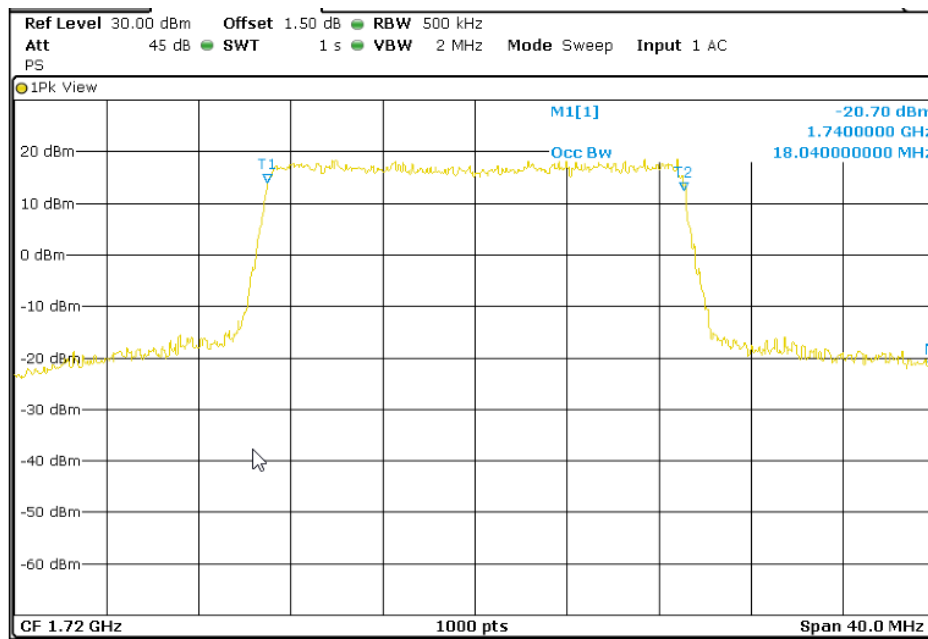

TEST RESULTS (Cont):

Lowest Channel 26dBc Bandwidth kHz

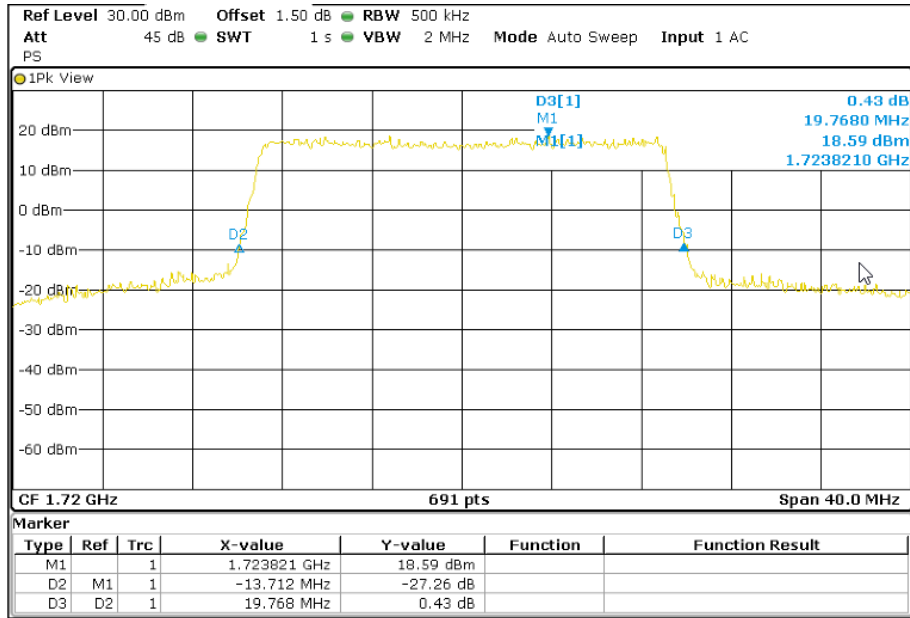

Middle Channel 99% Occupied Bandwidth

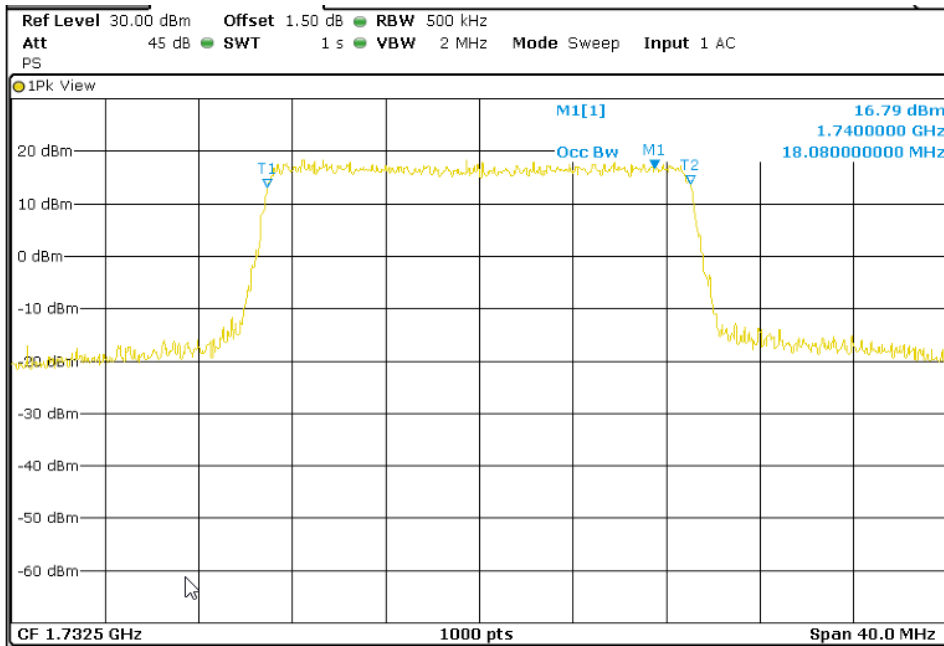

TEST RESULTS (Cont):

Middle Channel 26dBc Bandwidth kHz

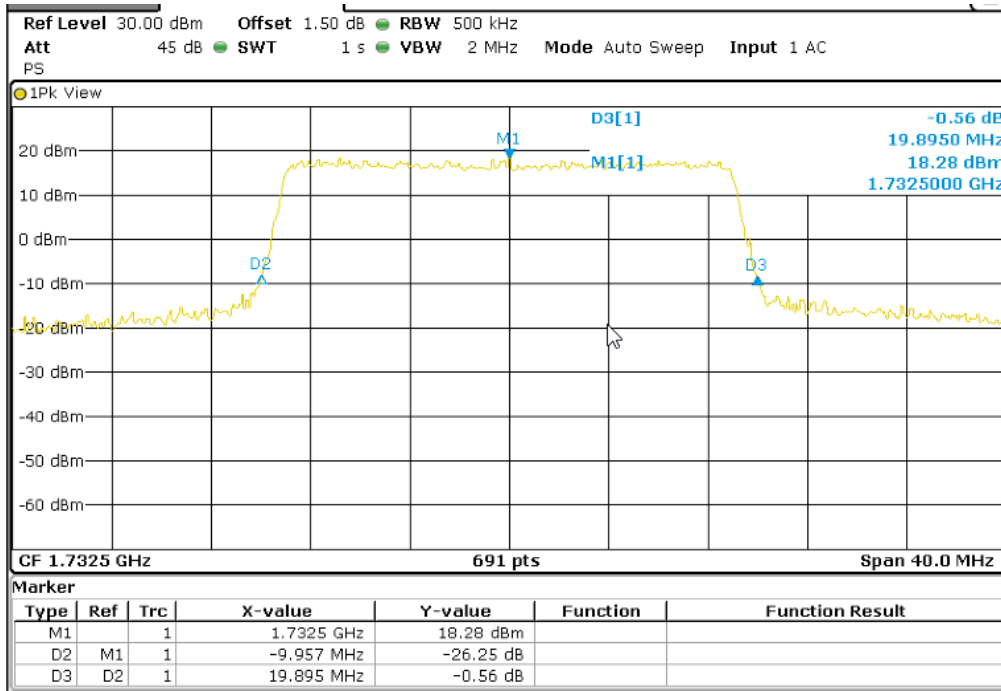

Highest Channel 99% Occupied Bandwidth

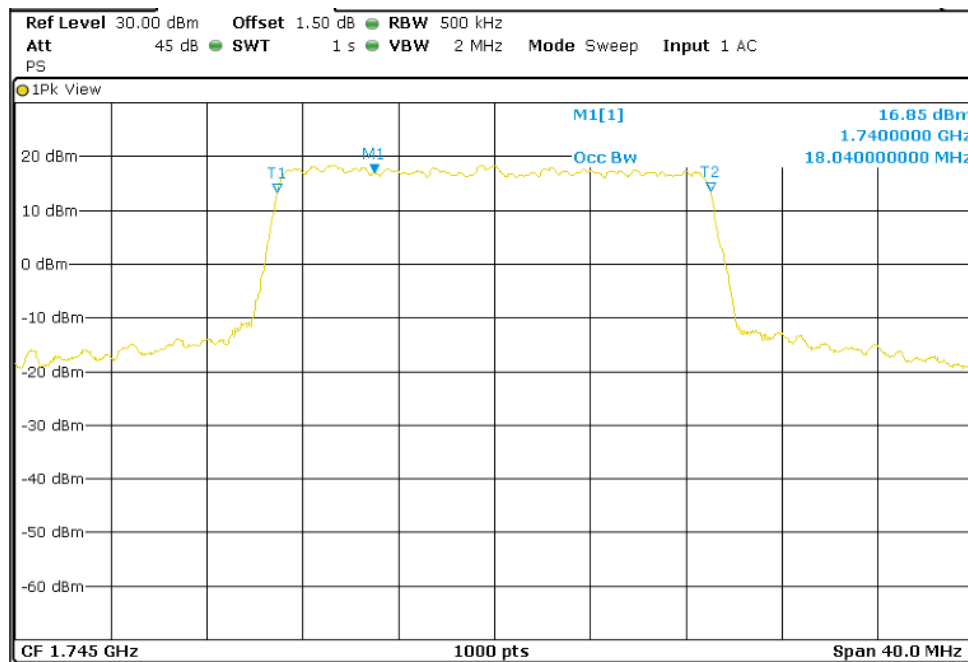

TEST RESULTS (Cont):

Highest Channel 26dBc Bandwidth kHz

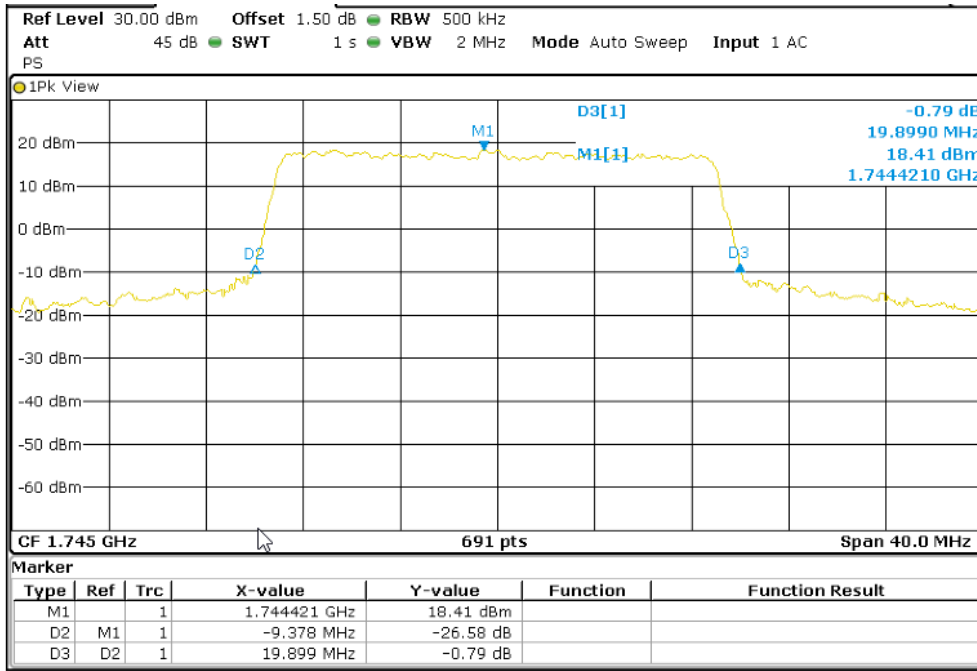

LTE 16QAM MODULATION. BW = 20 MHz

Lowest Channel 99% Occupied Bandwidth

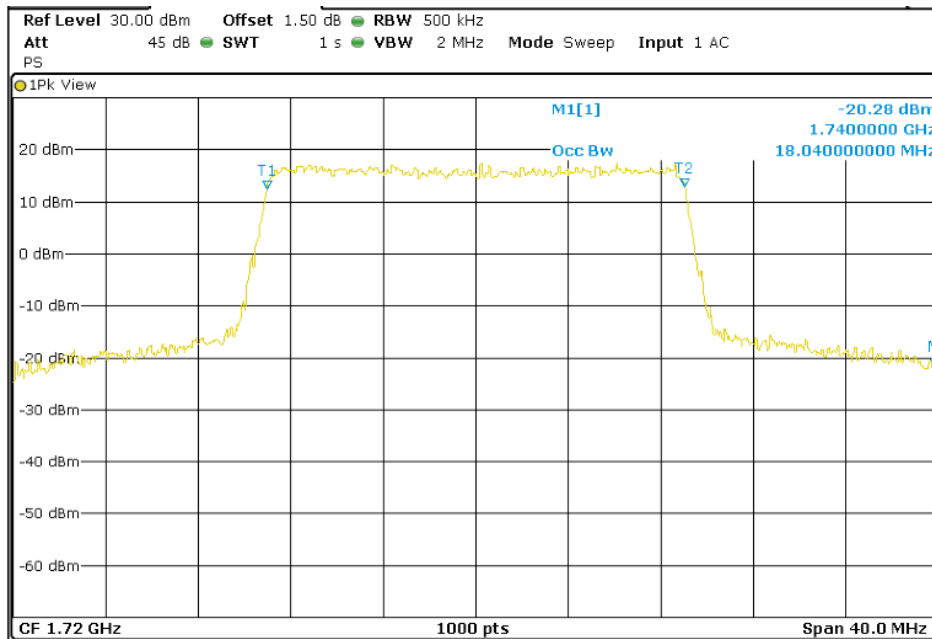

TEST RESULTS (Cont):

Lowest Channel 26dBc Bandwidth kHz

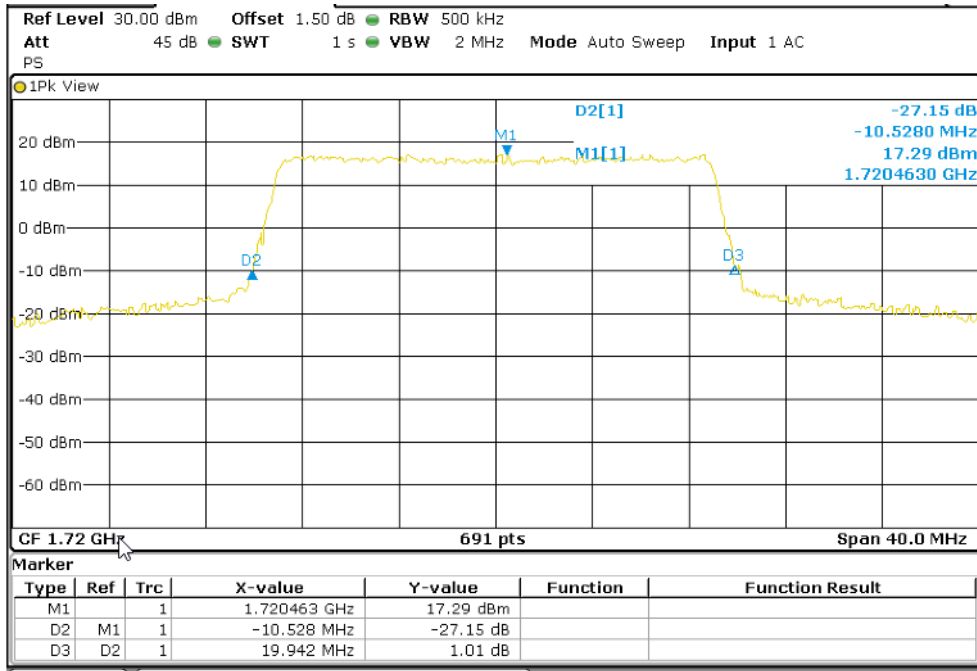

Middle Channel 99% Occupied Bandwidth

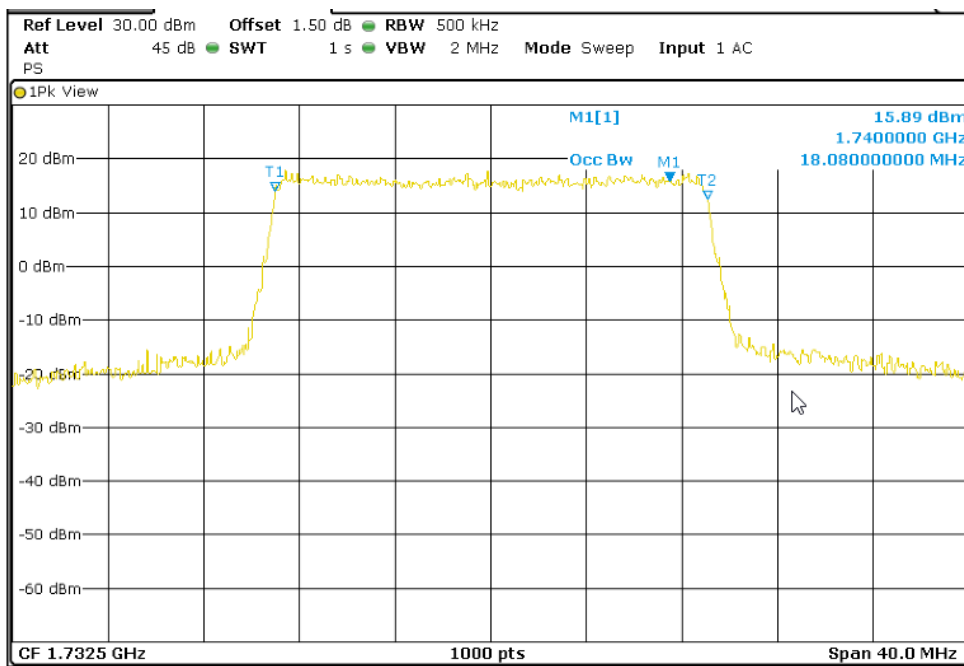

TEST RESULTS (Cont):

Middle Channel 26dBc Bandwidth kHz

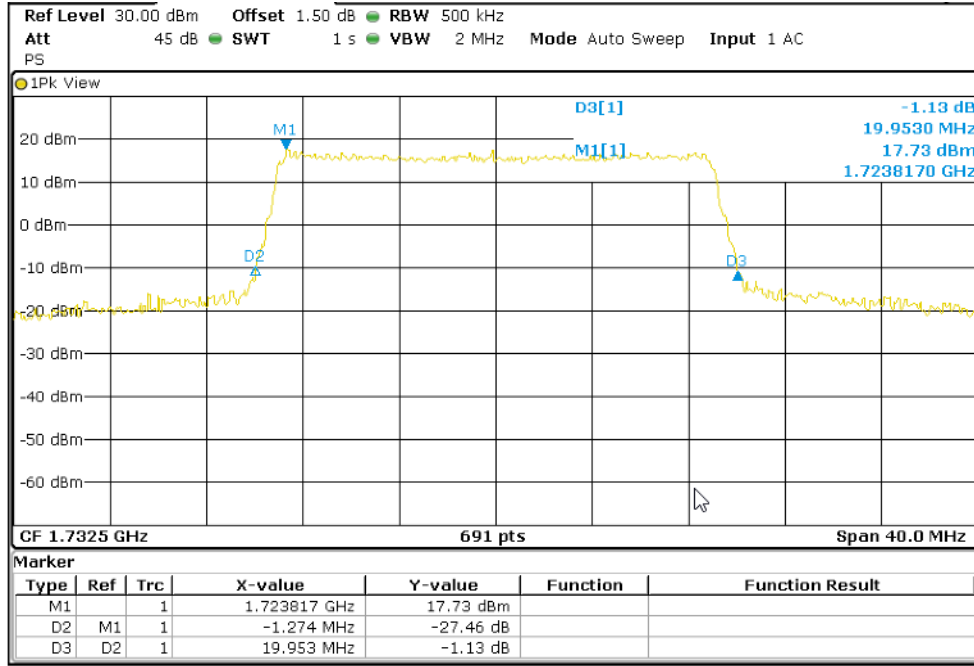

Highest Channel 99% Occupied Bandwidth

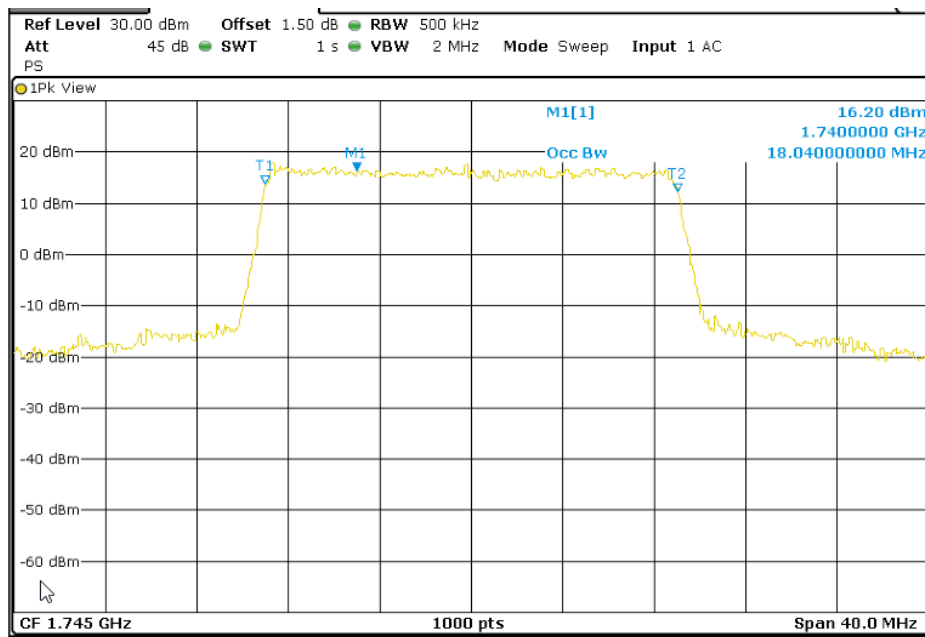

TEST RESULTS (Cont):

Highest Channel 26dBc Bandwidth kHz

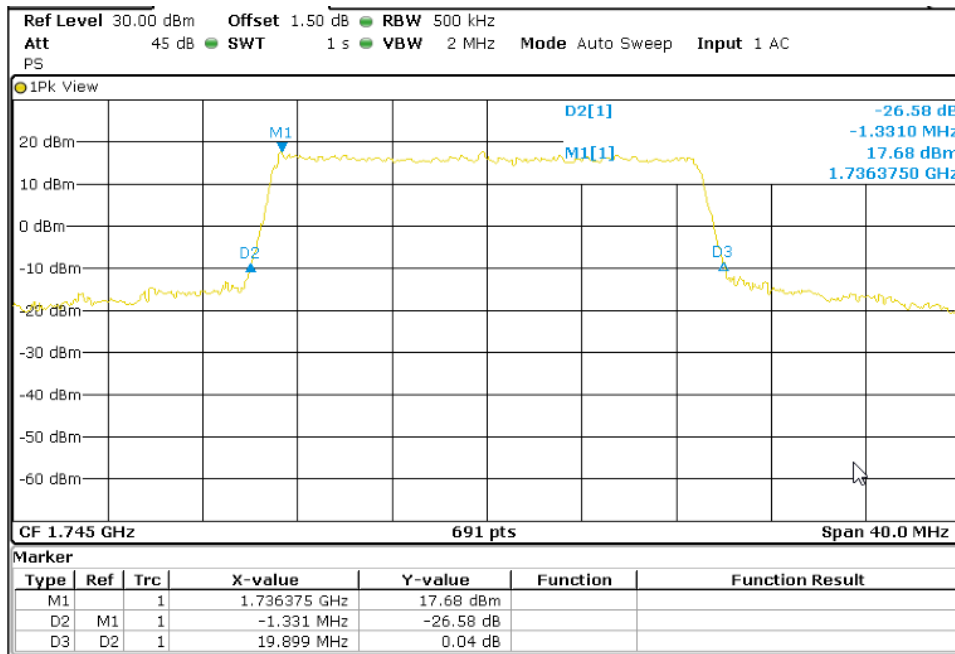

TESTED SAMPLES:	S/01
TESTED CONDITIONS MODES:	TC#02
TEST RESULTS:	PASS

RESULTS

LTE QPSK MODULATION. BW = 5 MHz

Channel	Lowest	Middle	Highest
99% Occupied bandwidth (MHz)	4.52	4.51	4.51
-26 dBc bandwidth (MHz)	5.08	5.07	5.07

LTE 16QAM MODULATION. BW = 5 MHz

Channel	Lowest	Middle	Highest
99% Occupied bandwidth (MHz)	4.51	4.50	4.50
-26 dBc bandwidth (MHz)	5.09	5.08	5.09

LTE QPSK MODULATION. BW = 10 MHz

Channel	Middle
99% Occupied bandwidth (MHz)	8.98
-26 dBc bandwidth (MHz)	10.05

LTE 16QAM MODULATION. BW = 10 MHz

Channel	Middle
99% Occupied bandwidth (MHz)	9.00
-26 dBc bandwidth (MHz)	10.02

TEST RESULTS (Cont):

LTE QPSK MODULATION. BW = 5 MHz

Lowest Channel 99% Occupied Bandwidth

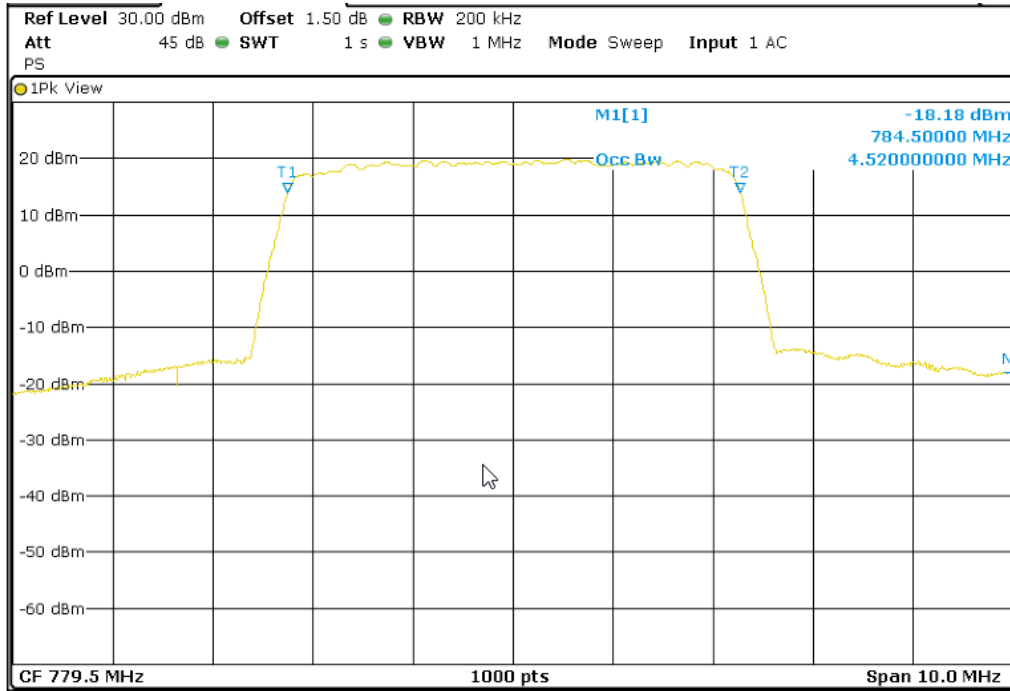

Lowest Channel 26dBc Bandwidth kHz

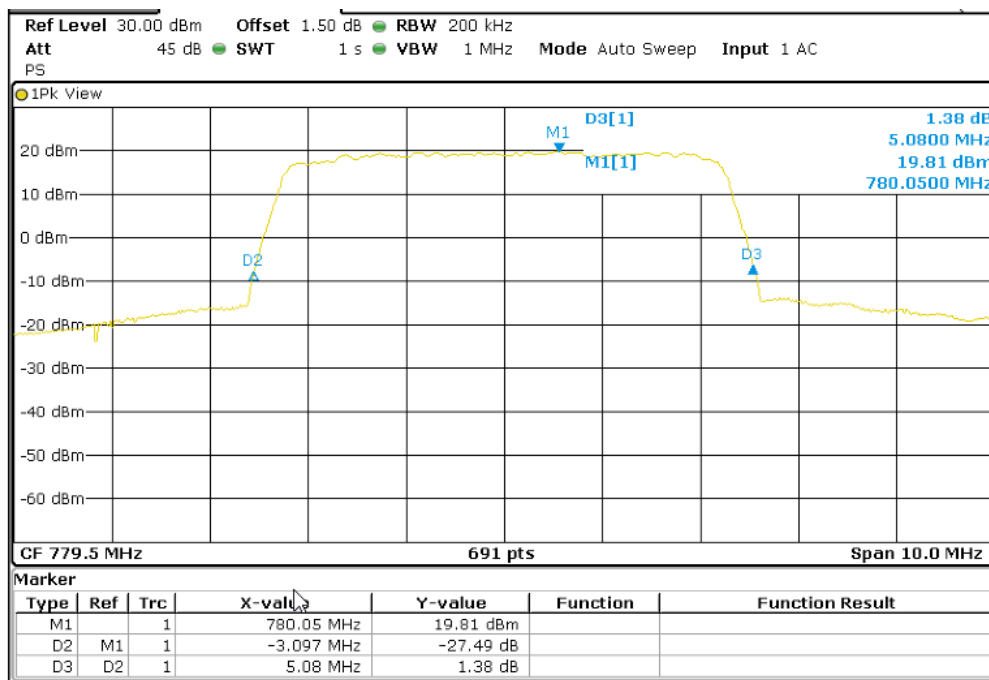

TEST RESULTS (Cont):

Middle Channel 99% Occupied Bandwidth

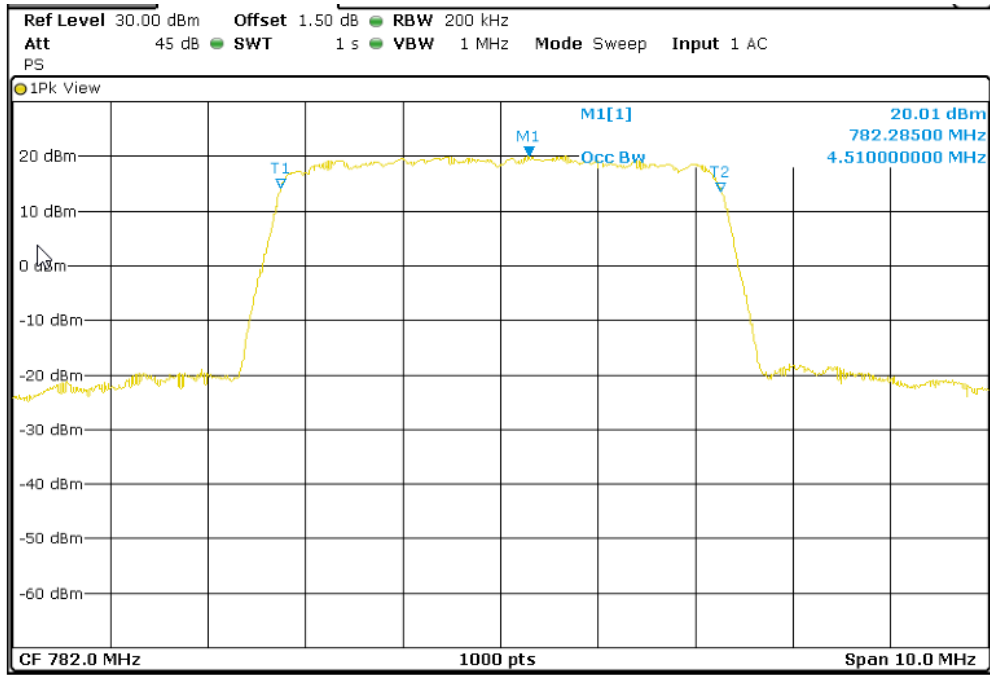

Middle Channel 26dBc Bandwidth kHz

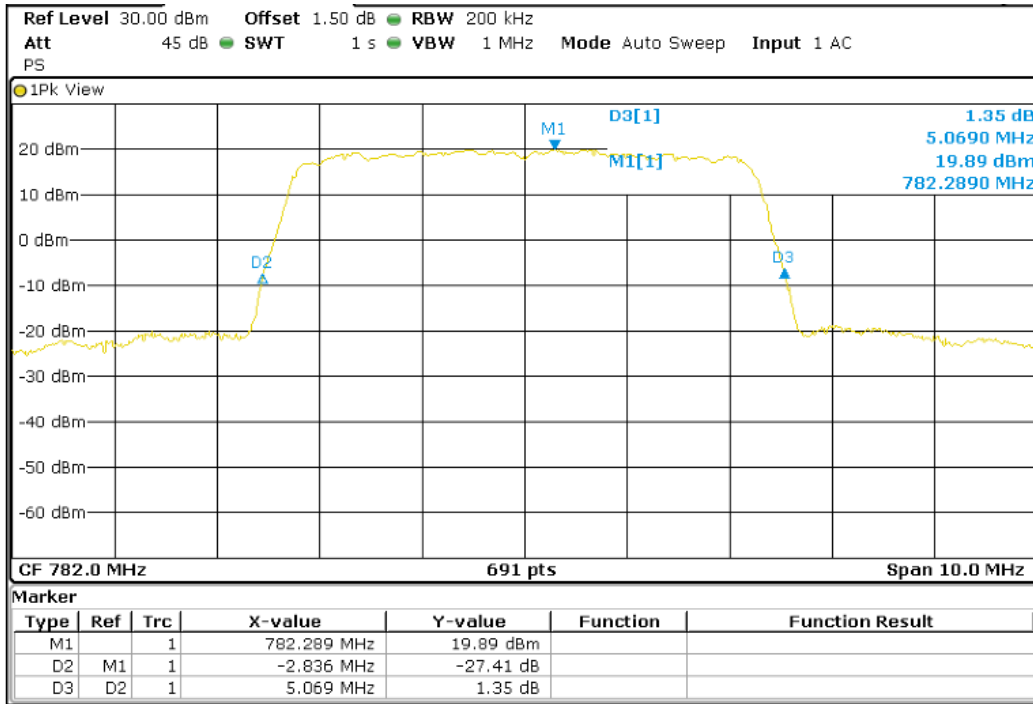

TEST RESULTS (Cont):

Highest Channel 99% Occupied Bandwidth

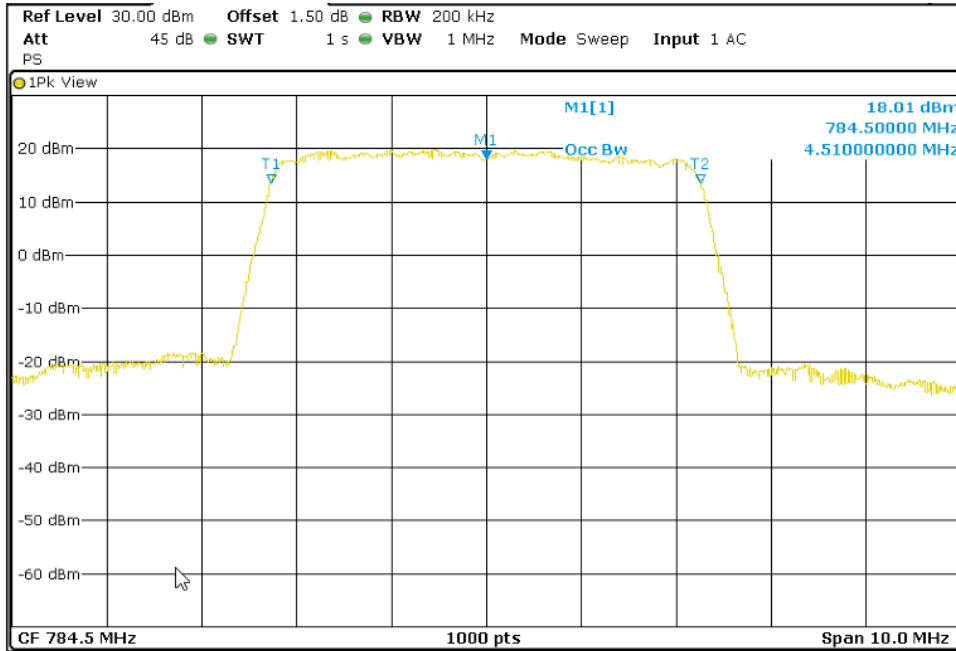

Highest Channel 26dBc Bandwidth kHz

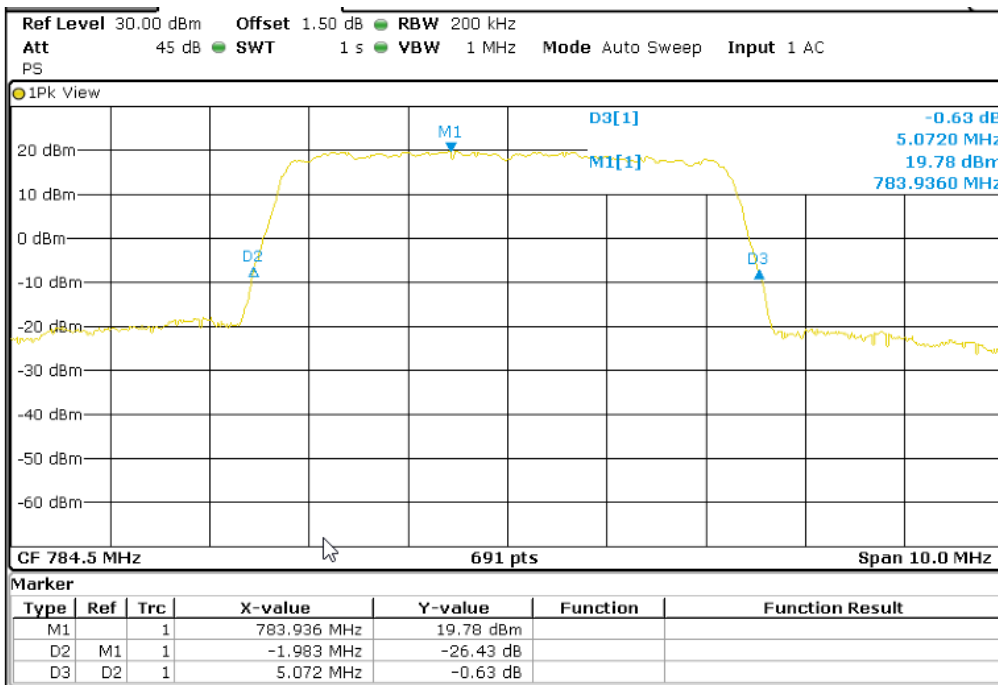

TEST RESULTS (Cont):

LTE 16QAM MODULATION. BW = 5 MHz

Lowest Channel 99% Occupied Bandwidth

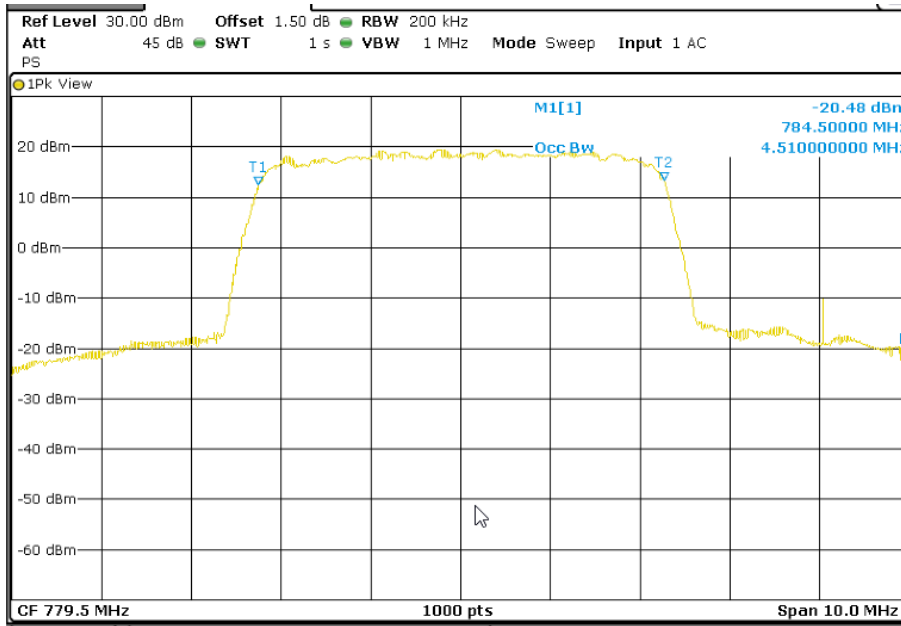

Lowest Channel 26dBc Bandwidth kHz

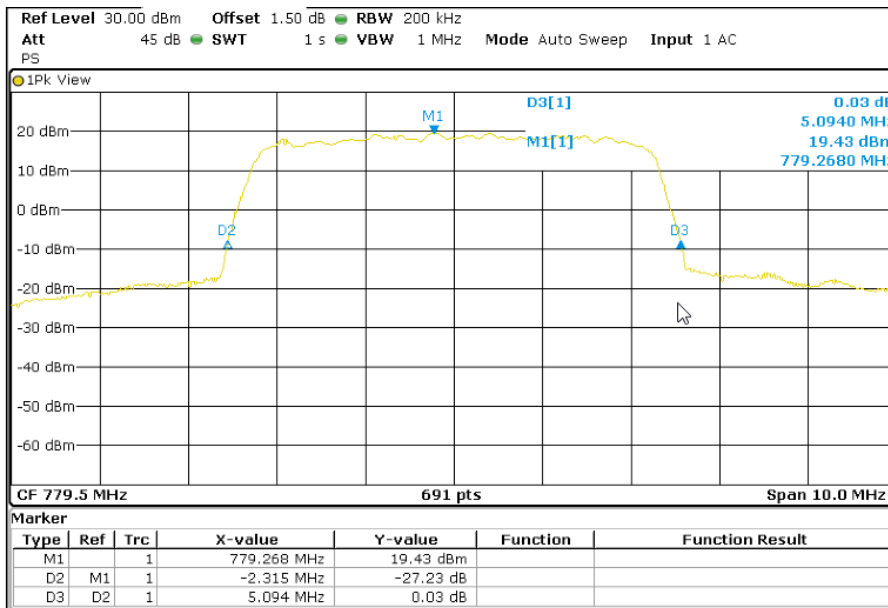

TEST RESULTS (Cont):

Middle Channel 99% Occupied Bandwidth

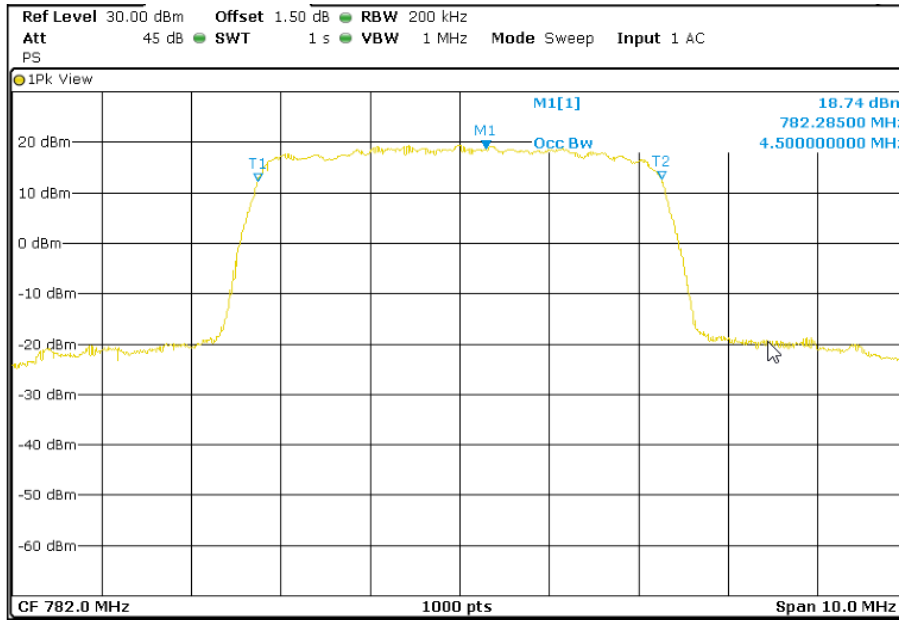

Middle Channel 26dBc Bandwidth kHz

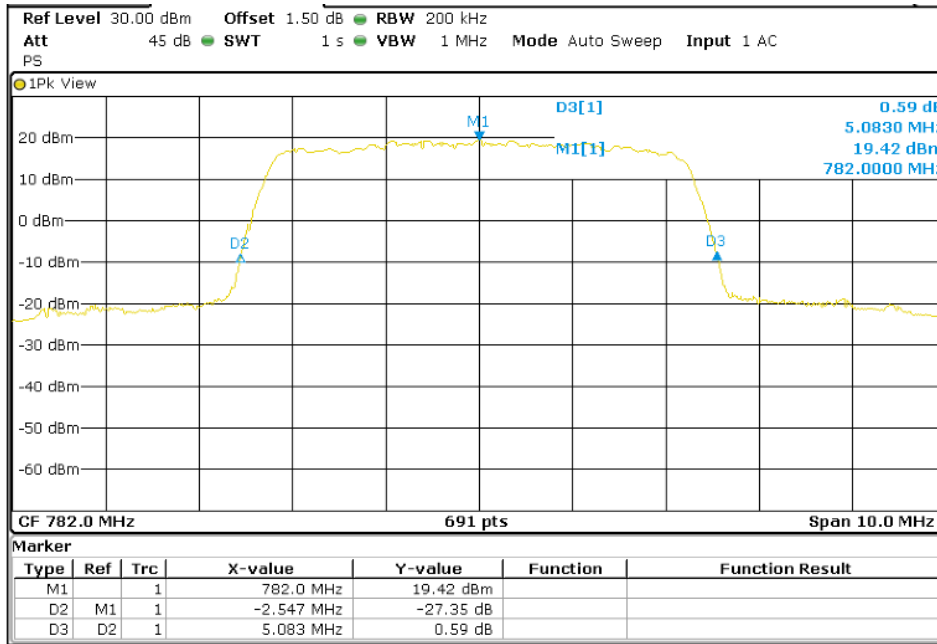

TEST RESULTS (Cont):

Highest Channel 99% Occupied Bandwidth

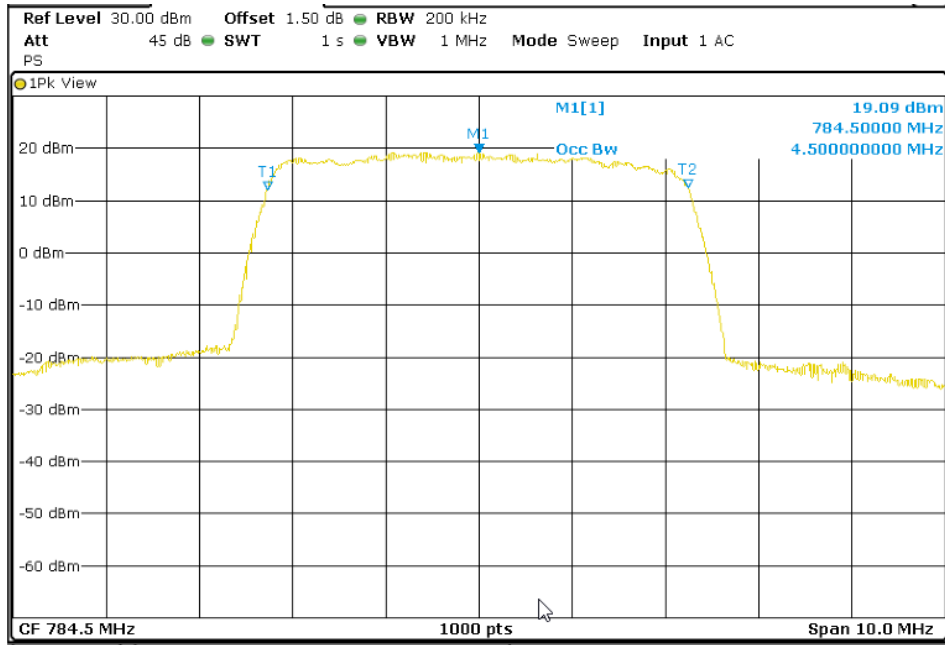

Highest Channel 26dBc Bandwidth kHz

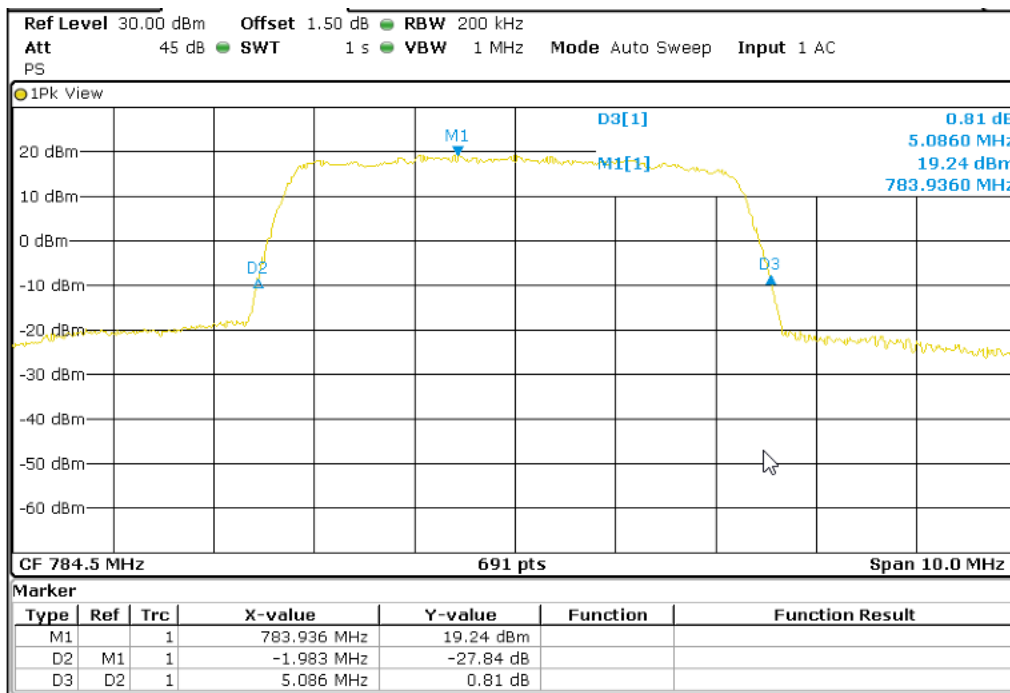

TEST RESULTS (Cont):

LTE QPSK MODULATION. BW = 10 MHz

Middle Channel 99% Occupied Bandwidth

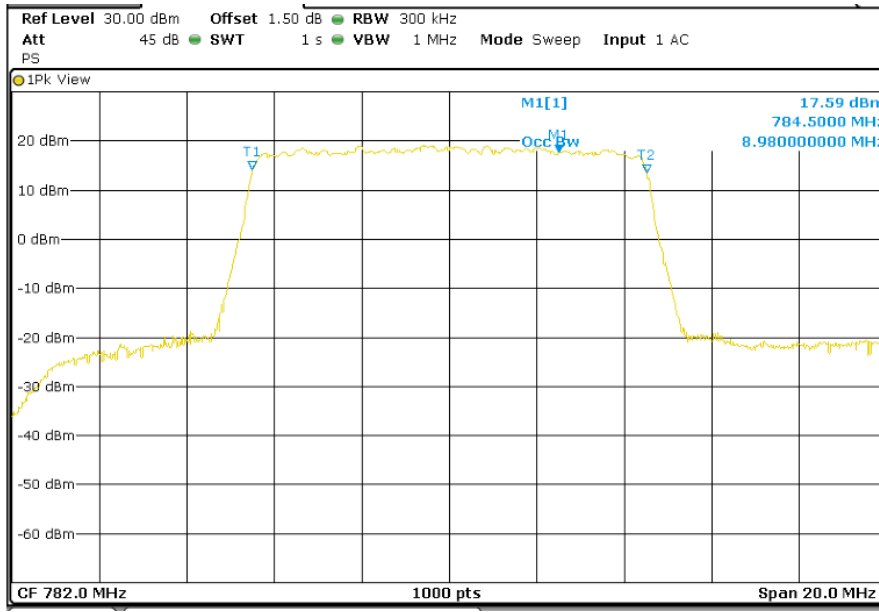

Middle Channel 26dBc Bandwidth kHz

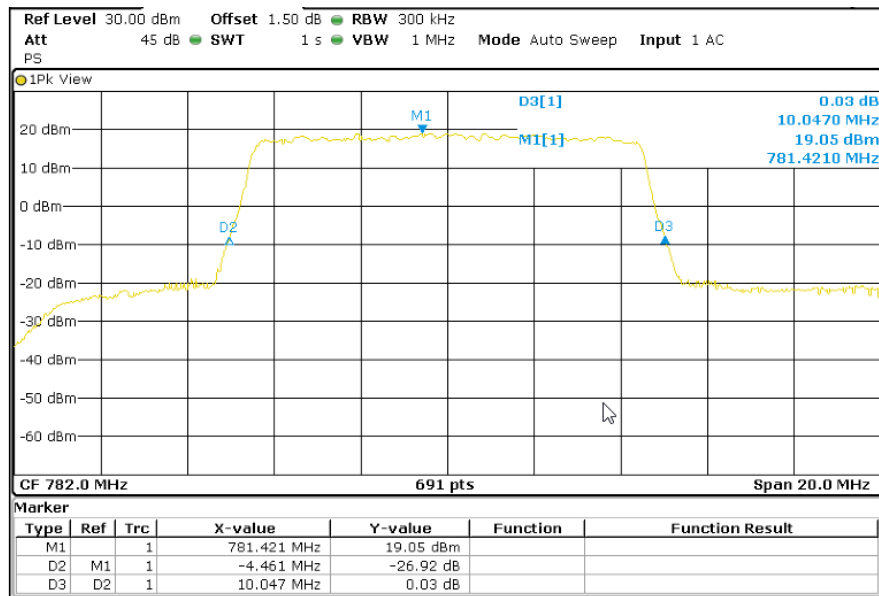

TEST RESULTS (Cont):

LTE 16QAM MODULATION. BW = 10 MHz

Middle Channel 99% Occupied Bandwidth

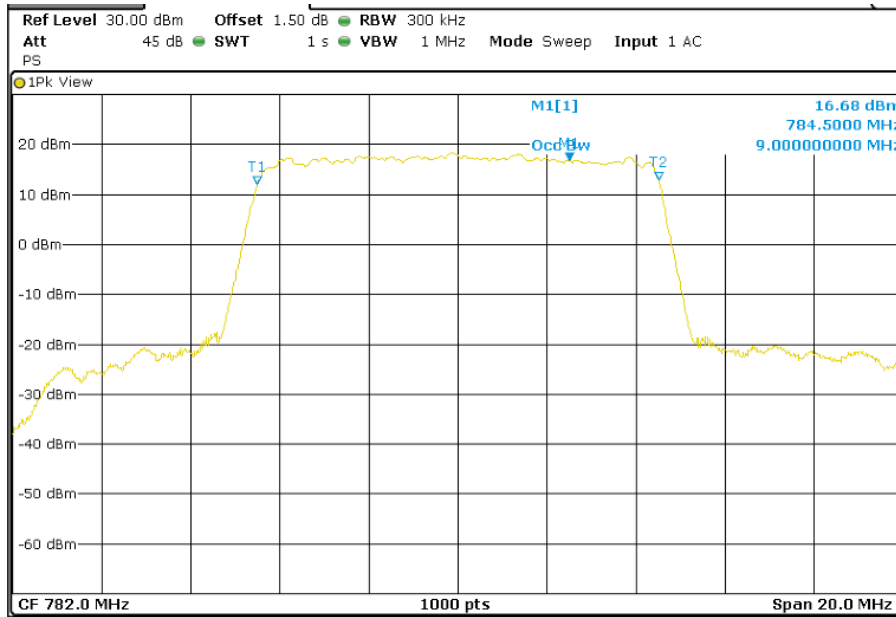

Middle Channel 26dBc Bandwidth kHz

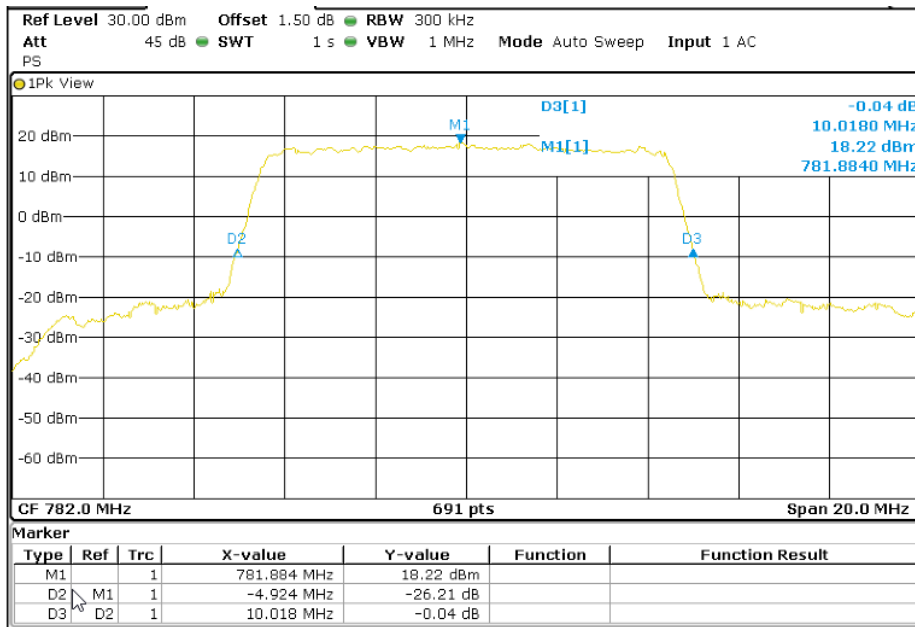

TEST A.5: SPURIOUS EMISSIONS AT ANTENNA TERMINALS

LIMITS:	Product standard:	FCC Part 27 / IC RSS-139/ IC RSS-130
	Test standard:	FCC §2.1051 and § 27.53/ RSS-139 Clause 6.6/RSS-130 Clause 4.7

LIMITS

According to specification, the power of emissions shall be attenuated below the transmitter power (P) by a factor of at least $43 + 10 \log (P)$ dB. P in watts.

At P_o transmitting power of 2 watts (33 dBm), the specified minimum attenuation becomes $43+10\log (P_o)$. and the level in dBm relative to P_o becomes:

$$P_o \text{ (dBm)} - [43 + 10 \log (P_o \text{ in watts})] = -13 \text{ dBm}$$

TEST SETUP

The EUT RF output connector was connected to a spectrum analyzer and to the Universal Radio Communication tester R&S CMW500 (selecting maximum transmission power of the EUT and different modes of modulation) using a 50 ohm attenuator and a power splitter.

The spectrum was investigated from 9 kHz to 18 GHz for LTE Band IV.
 The spectrum was investigated from 9 kHz to 18 GHz for WCDMA and HSUPA Band IV.

The reading of the spectrum analyzer is corrected with the attenuation loss of connection between output terminal of EUT and input of the spectrum analyzer.

For LTE mode the configuration of Resource Blocks and modulation which is the worst case for conducted power was used.

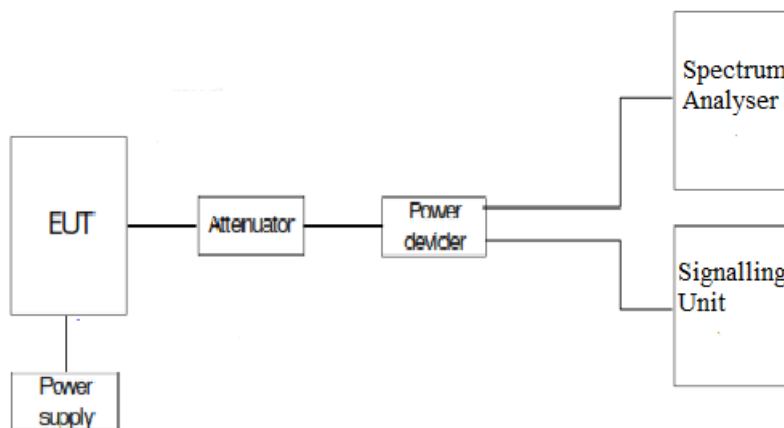

TESTED SAMPLES:	S/01
TESTED CONDITIONS MODES:	TC#01
TEST RESULTS:	PASS

RESULTS

Frequency range 9 kHz – 18 GHz

LTE QPSK MODULATION. BW = 5 MHz

Lowest Channel

No spurious signal was found at less than 20dB respect to the limit in the frequency range.

Middle Channel

No spurious signal was found at less than 20dB respect to the limit in the frequency range.

Highest Channel

No spurious signal was found at less than 20dB respect to the limit in the frequency range.

LTE QPSK MODULATION. BW = 10 MHz

Lowest Channel

No spurious signal was found at less than 20dB respect to the limit in the frequency range.

Middle Channel

No spurious signal was found at less than 20dB respect to the limit in the frequency range.

Highest Channel

No spurious signal was found at less than 20dB respect to the limit in the frequency range.

LTE QPSK MODULATION. BW = 15 MHz

Lowest Channel

No spurious signal was found at less than 20dB respect to the limit in the frequency range.

Middle Channel

No spurious signal was found at less than 20dB respect to the limit in the frequency range.

Highest Channel

No spurious signal was found at less than 20dB respect to the limit in the frequency range.

LTE QPSK MODULATION. BW = 20 MHz

Lowest Channel

No spurious signal was found at less than 20dB respect to the limit in the frequency range.

Middle Channel

No spurious signal was found at less than 20dB respect to the limit in the frequency range.

Highest Channel

No spurious signal was found at less than 20dB respect to the limit in the frequency range.

TEST RESULTS (Cont):

LTE QPSK MODULATION. BW = 5MHz

Lowest Channel

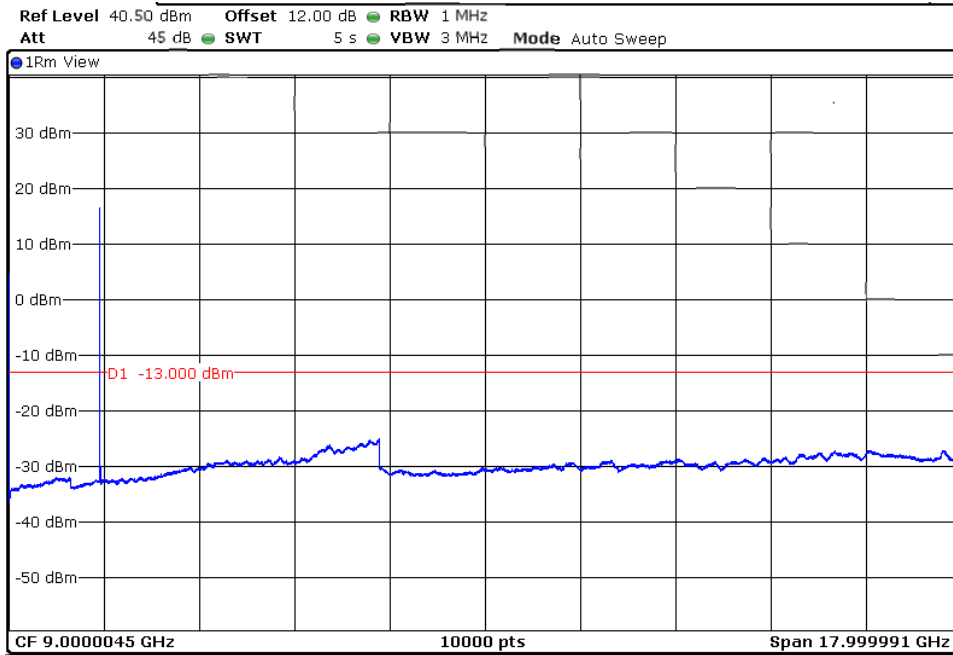

Middle Channel

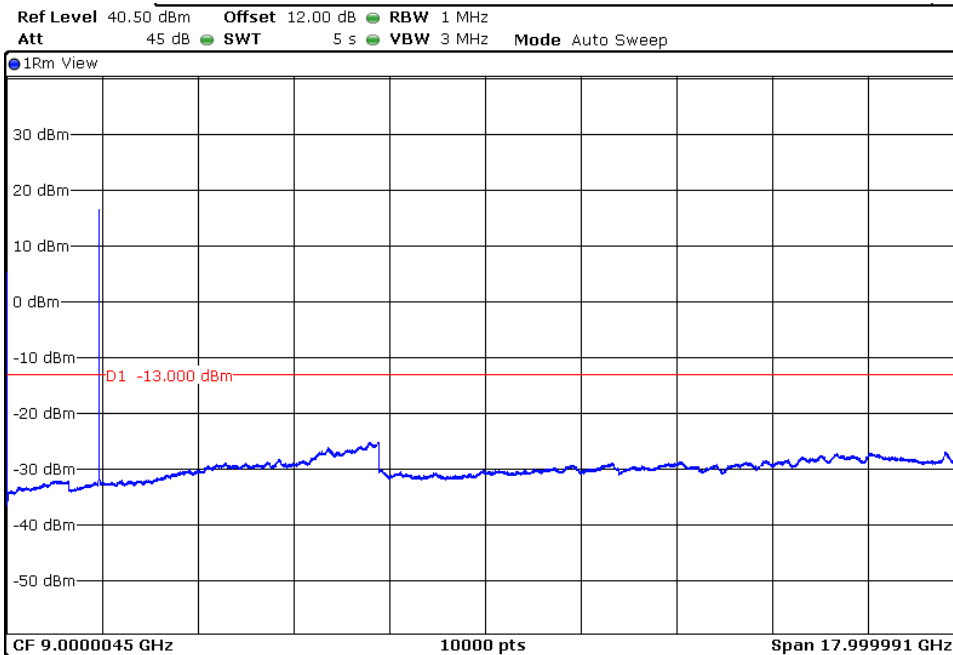

TEST RESULTS (Cont):

Highest Channel

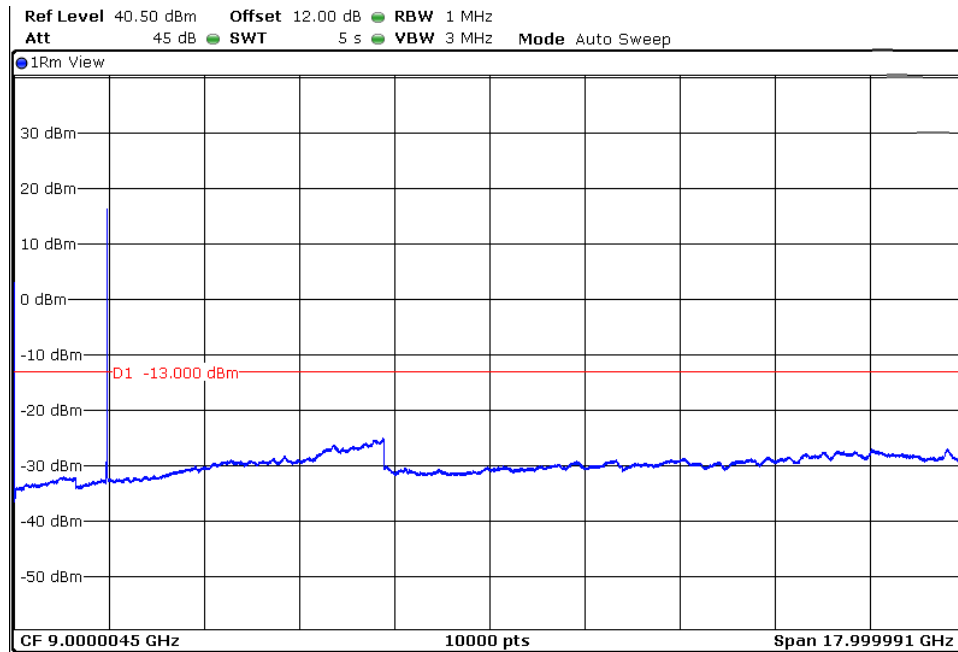

LTE QPSK MODULATION. BW = 10 MHz

Lowest Channel

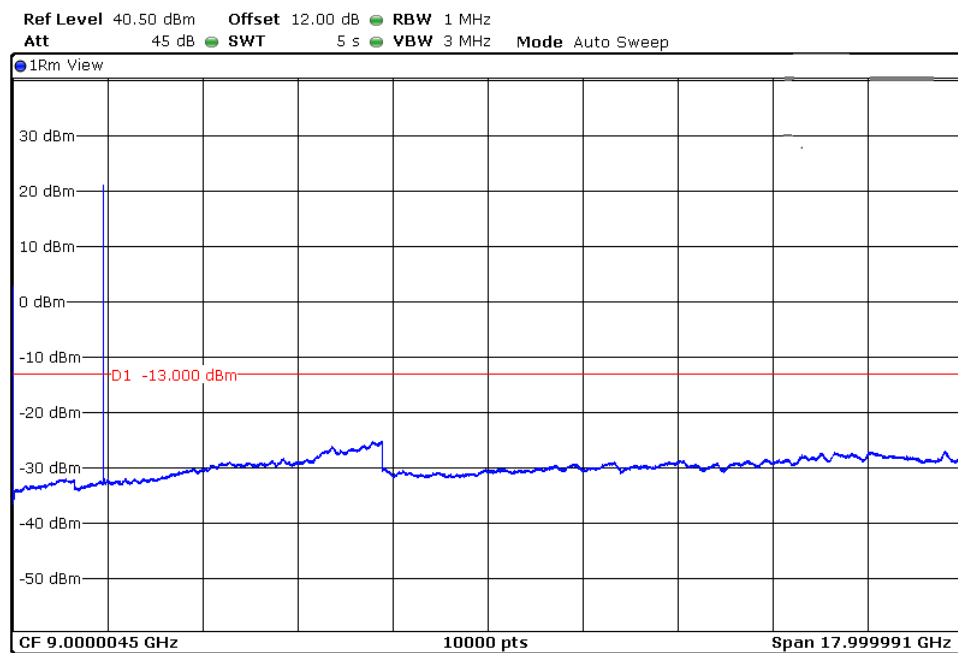

TEST RESULTS (Cont):

Middle Channel

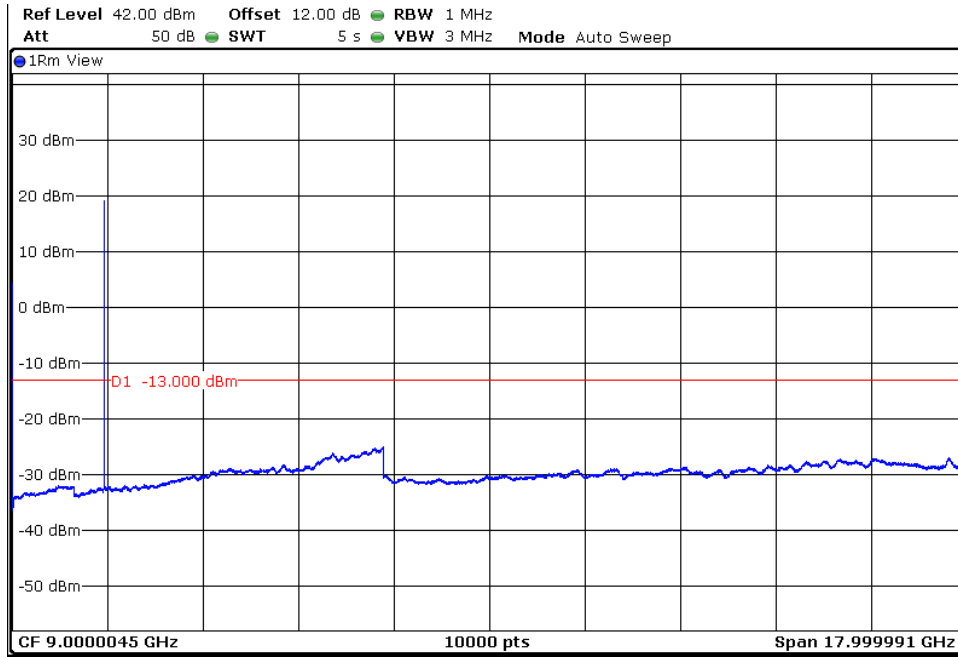

Highest Channel

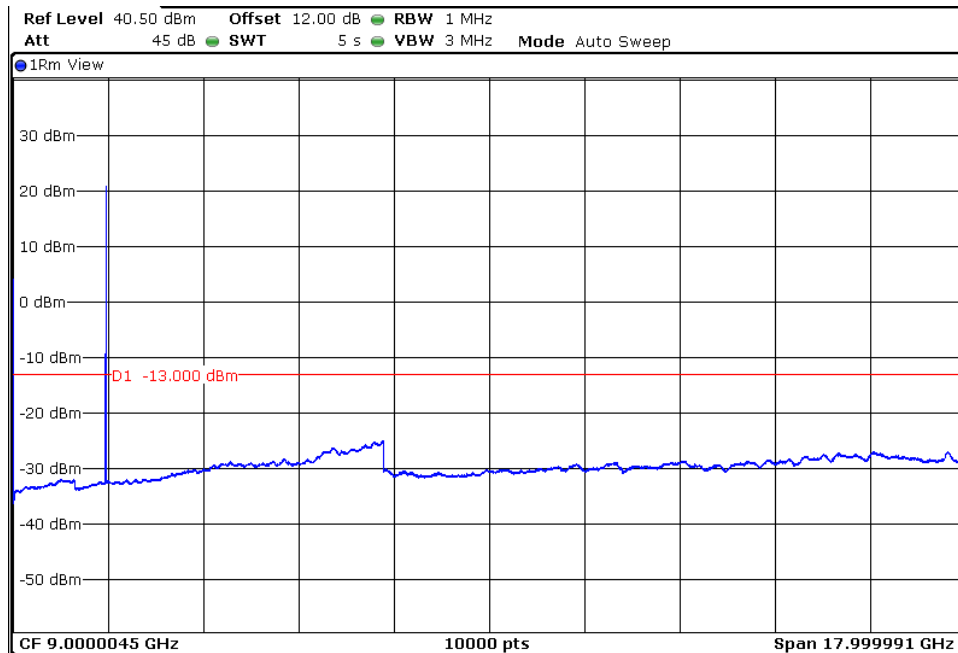

TEST RESULTS (Cont):

LTE QPSK MODULATION. BW = 15 MHz

Lowest Channel

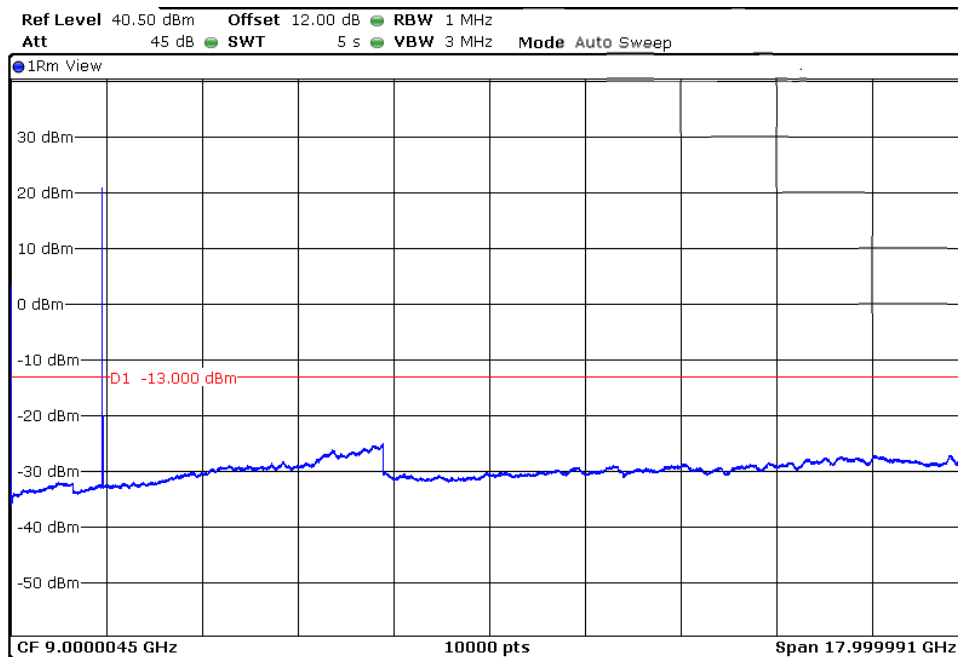

Middle Channel

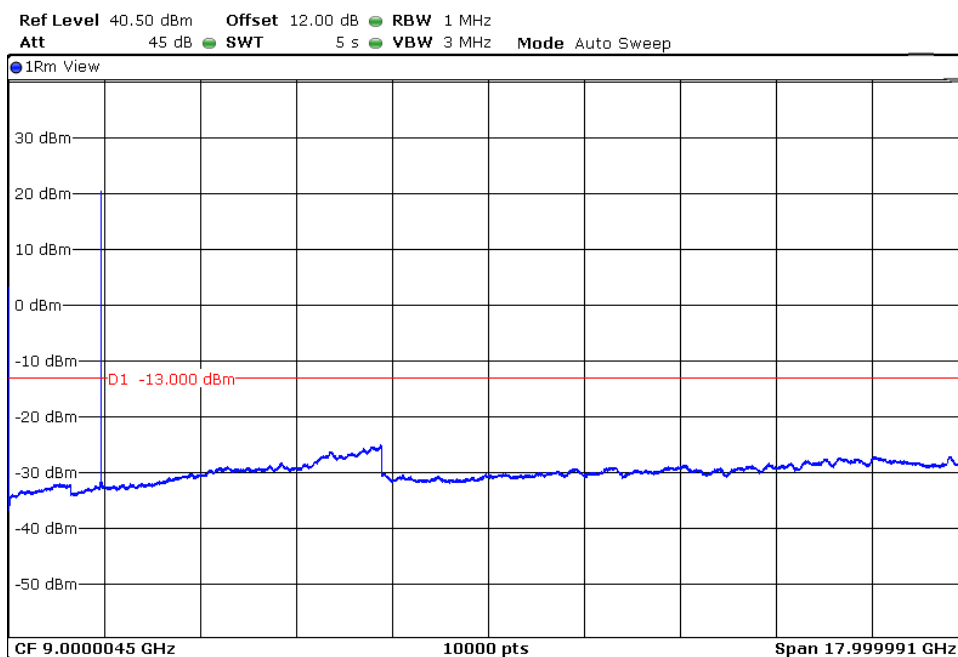

TEST RESULTS (Cont):

Highest Channel

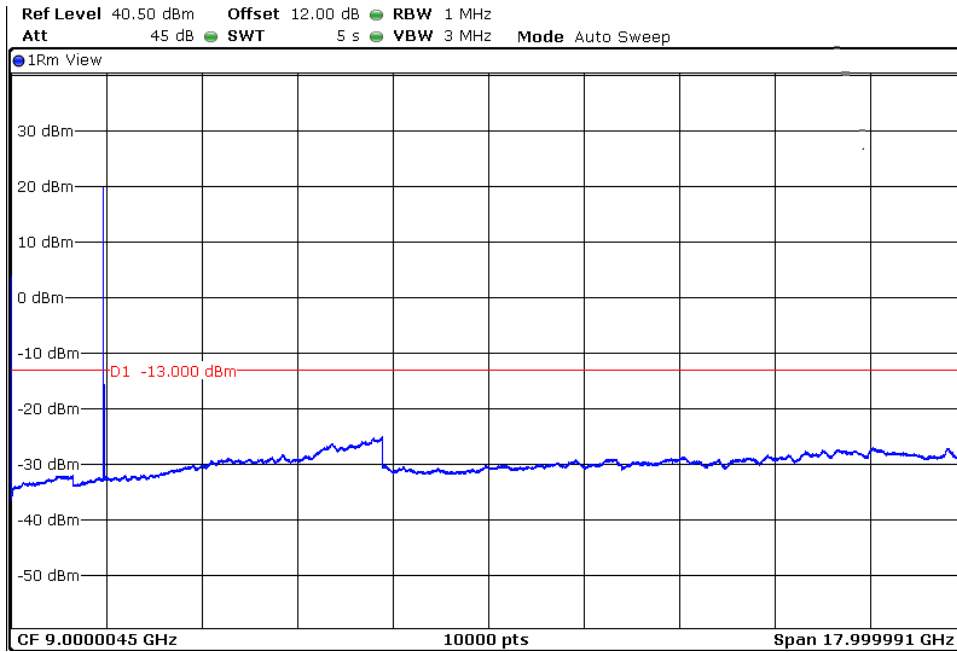

LTE QPSK MODULATION. BW = 20 MHz

Lowest Channel

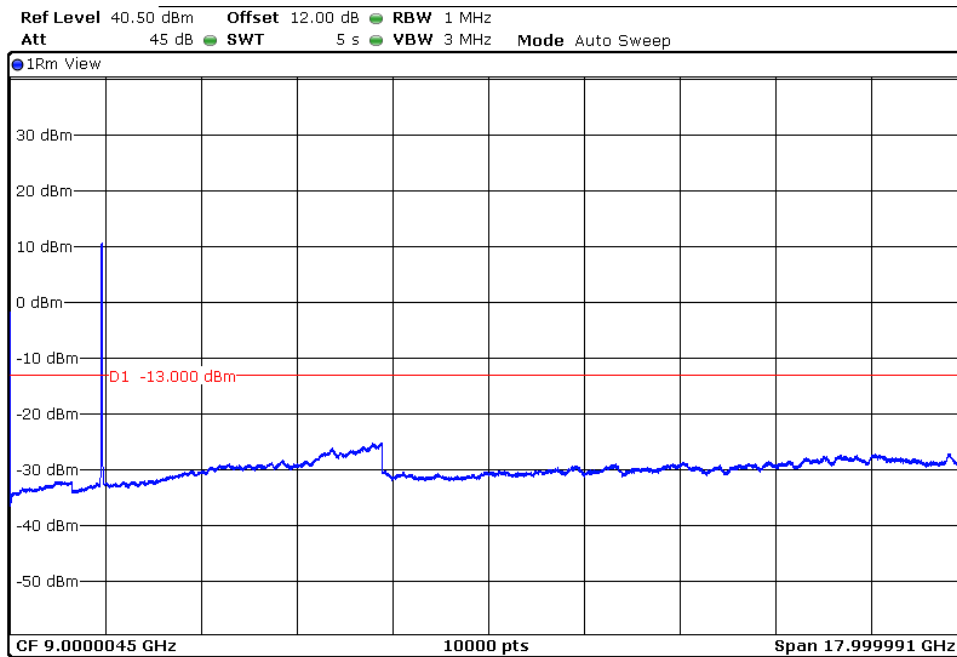

TEST RESULTS (Cont):

Middle Channel

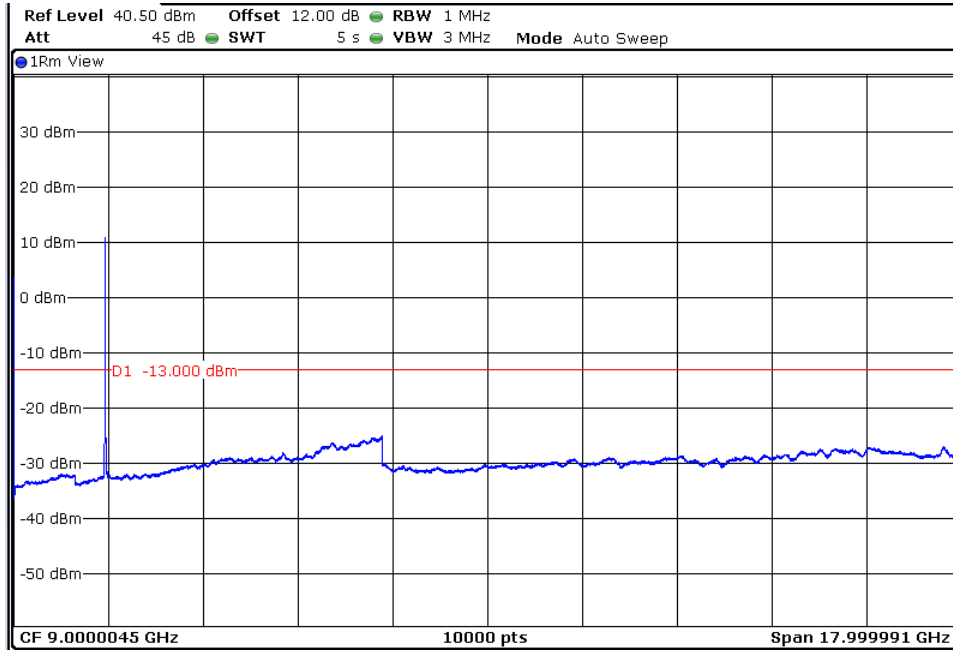

Highest Channel

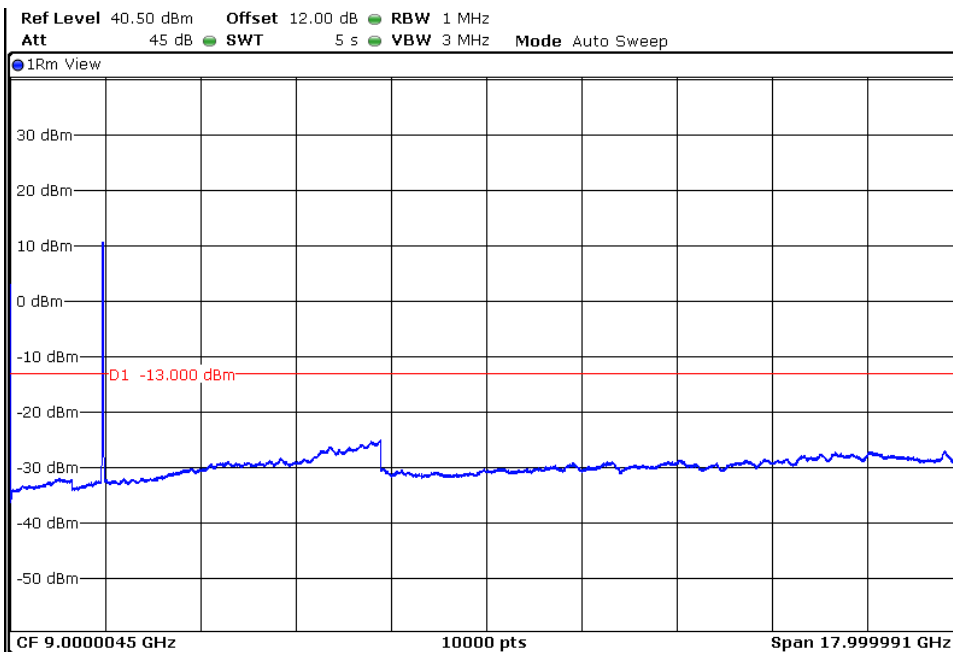

TESTED SAMPLES:	S/01
TESTED CONDITIONS MODES:	TC#02
TEST RESULTS:	PASS

RESULTS

Frequency range 9 kHz – 18 GHz

LTE QPSK MODULATION. BW = 5 MHz

Lowest Channel

No spurious signal was found at less than 20dB respect to the limit in the frequency range.

Middle Channel

No spurious signal was found at less than 20dB respect to the limit in the frequency range.

Highest Channel

No spurious signal was found at less than 20dB respect to the limit in the frequency range.

LTE QPSK MODULATION. BW = 10 MHz

Middle Channel

No spurious signal was found at less than 20dB respect to the limit in the frequency range.

LTE QPSK MODULATION. BW = 5 MHz

Lowest Channel

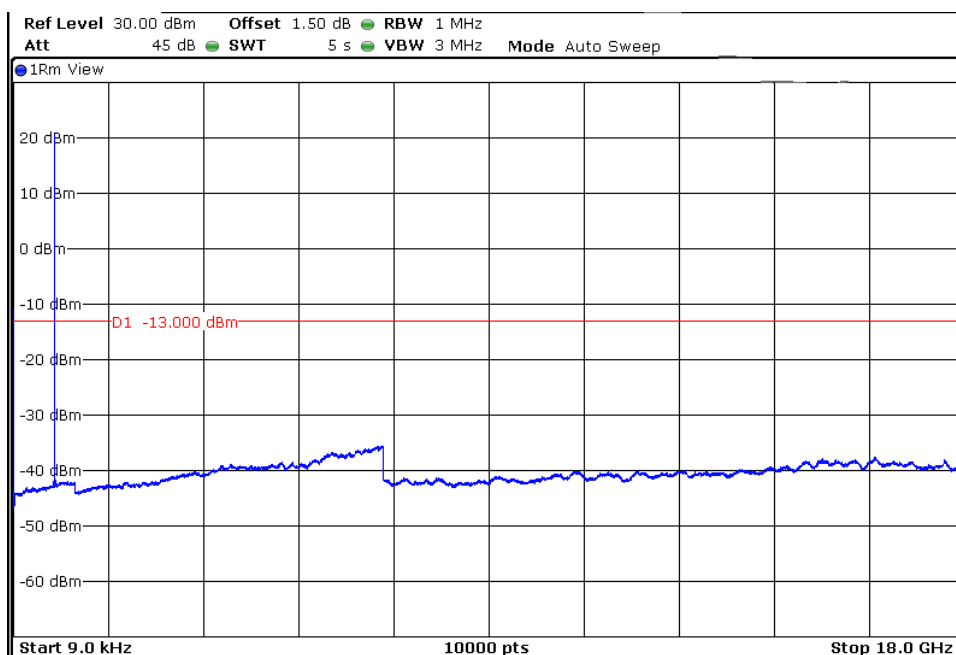

TEST RESULTS (Cont):

LTE QPSK MODULATION. BW = 10 MHz

Middle Channel

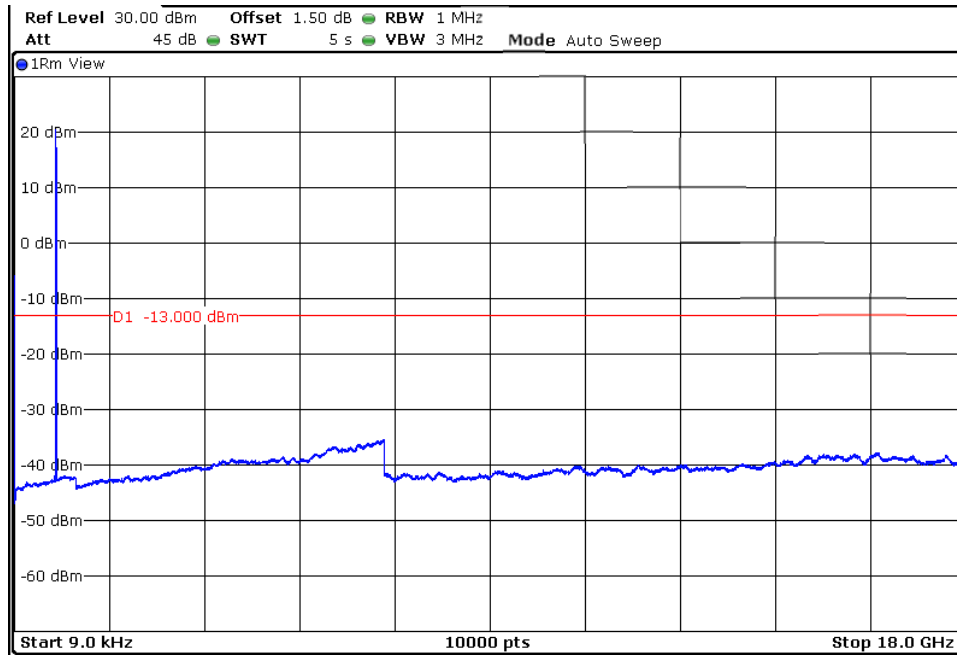

TEST A.6: SPURIOUS EMISSIONS AT ANTENNA TERMINALS AT BLOCK EDGES

LIMITS:	Product standard:	FCC Part 27 / IC RSS-139/ IC RSS-130
	Test standard:	FCC § 27.53/ RSS- Clause 6.6/RSS-130 Clause 4.7

LIMITS

According to specification, the power of emissions shall be attenuated below the transmitter power (P) by a factor of at least $43 + 10 \log (P)$ dB. P in watts.

At P_o transmitting power of 2 watts (33 dBm), the specified minimum attenuation becomes $43+10\log (P_o)$. and the level in dBm relative to P_o becomes:

$$P_o \text{ (dBm)} - [43 + 10 \log (P_o \text{ in watts})] = -13 \text{ dBm}$$

TEST SETUP

The EUT RF output connector was connected to a spectrum analyzer and to the Universal Radio Communication tester R&S CMW500 (selecting maximum transmission power of the EUT and different modes of modulation) using a 50 ohm attenuator and a power splitter.

The reading of the spectrum analyzer is corrected with the attenuation loss of connection between output terminal of EUT and input of the spectrum analyzer.

For LTE mode the configuration of modulation which is the worst case for conducted power was used.

As indicated in FCC part 27.53 (h) (3), in the 1 MHz bands immediately outside and adjacent to the licensee's frequency block or band, a resolution bandwidth of at least one percent of the emission bandwidth of the fundamental emission of the transmitter may be employed.

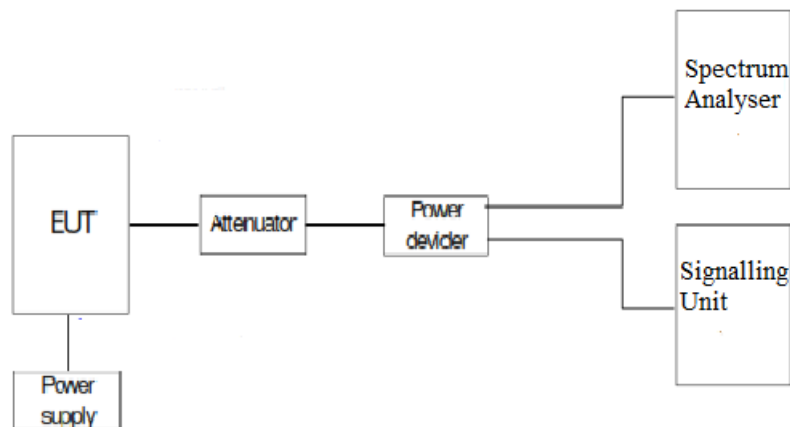

TESTED SAMPLES:	S/01
TESTED CONDITIONS MODES:	TC#01
TEST RESULTS:	PASS

RESULTS

LTE QPSK MODULATION	RB=1 Offset =0 BW = 5 MHz	RB=1 Offset =0 BW = 10 MHz	RB=15 Offset =0 BW = 15 MHz	RB=20 Offset =0 BW = 20 MHz
Maximum measured level at lowest Block Edge at antenna port (dBm)	-29.49	-25.63	-22.99	-24.23

LTE QPSK MODULATION	RB=25 Offset =0 BW = 5 MHz	RB=50 Offset =0 BW = 10 MHz	RB=75 Offset =0 BW = 15 MHz	RB=100 Offset =0 BW = 20 MHz
Maximum measured level at lowest Block Edge at antenna port (dBm)	-33.63	-32.9	-29.55	-31.19

LTE QPSK MODULATION	RB=1 Offset =0 BW = 5 MHz	RB=10 Offset =0 BW = 10 MHz	RB=15 Offset =0 BW = 15 MHz	RB=20 Offset =0 BW = 20 MHz
Maximum measured level at Highest Block Edge at antenna port (dBm)	-25.55	-24.55	-22.17	-25.52

LTE QPSK MODULATION	RB=25 Offset =0 BW = 5 MHz	RB=50 Offset =0 BW = 10 MHz	RB=75 Offset =0 BW = 15 MHz	RB=100 Offset =0 BW = 20 MHz
Maximum measured level at Highest Block Edge at antenna port (dBm)	-32.02	-30.75	-28.11	-29.71

TEST RESULTS (Cont):

LTE QPSK MODULATION. RB = 1. Offset = 0. BW = 5 MHz

Lowest Channel

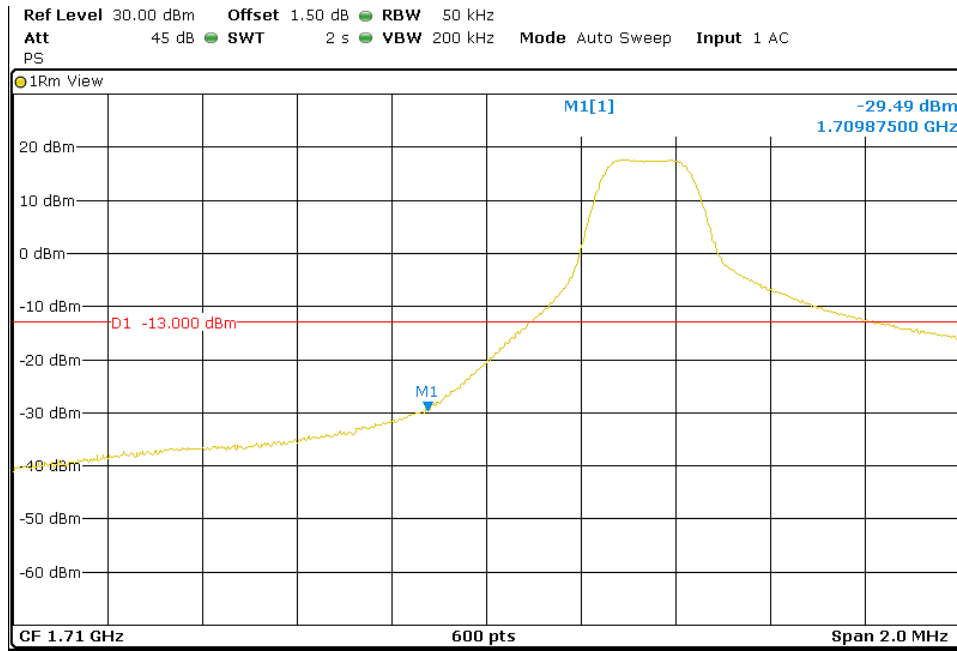

Highest Channel

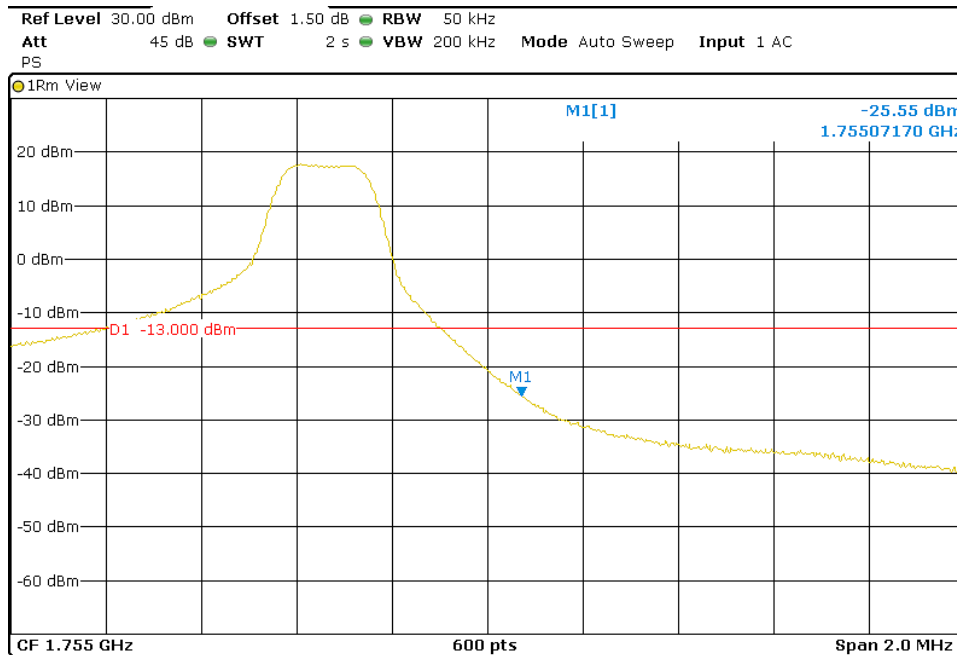

TEST RESULTS (Cont):

LTE QPSK MODULATION. RB = 25. Offset = 0. BW = 5 MHz

Lowest Channel

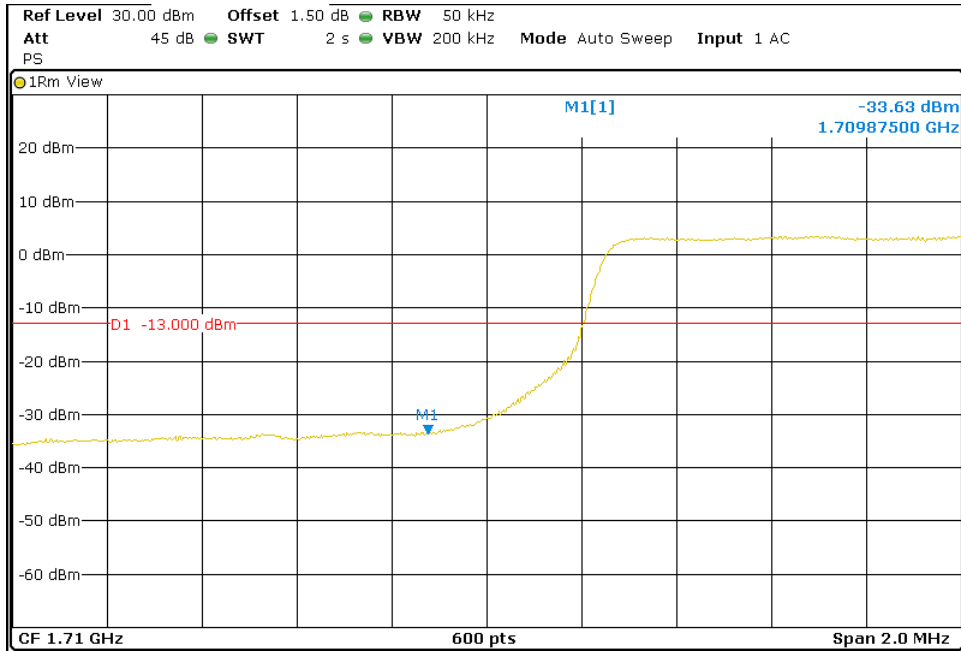

Highest Channel

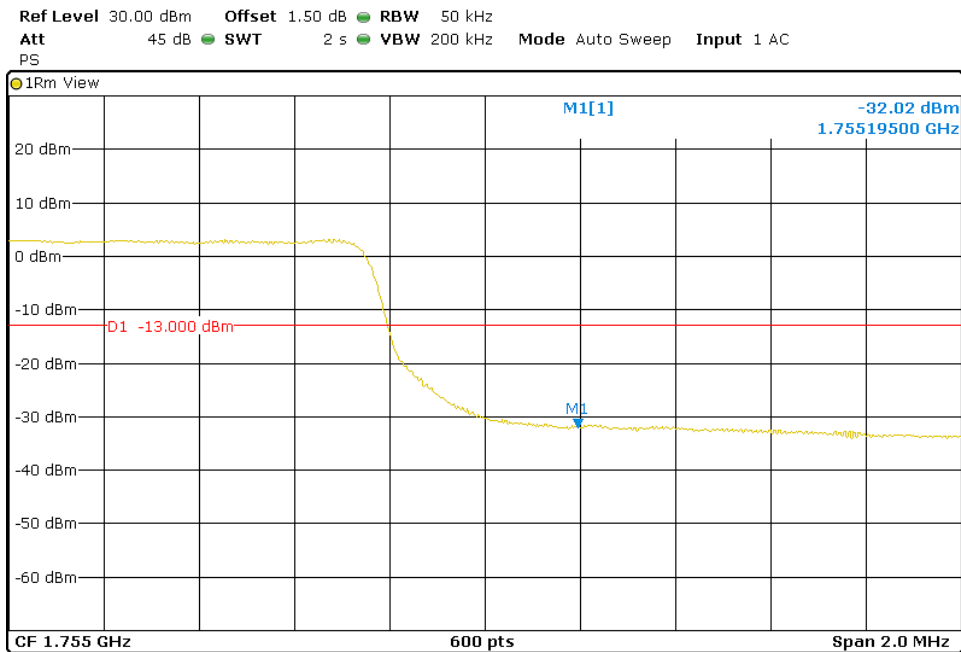

TEST RESULTS (Cont):

LTE QPSK MODULATION. RB = 1. Offset = 0. BW = 10 MHz

Lowest Channel

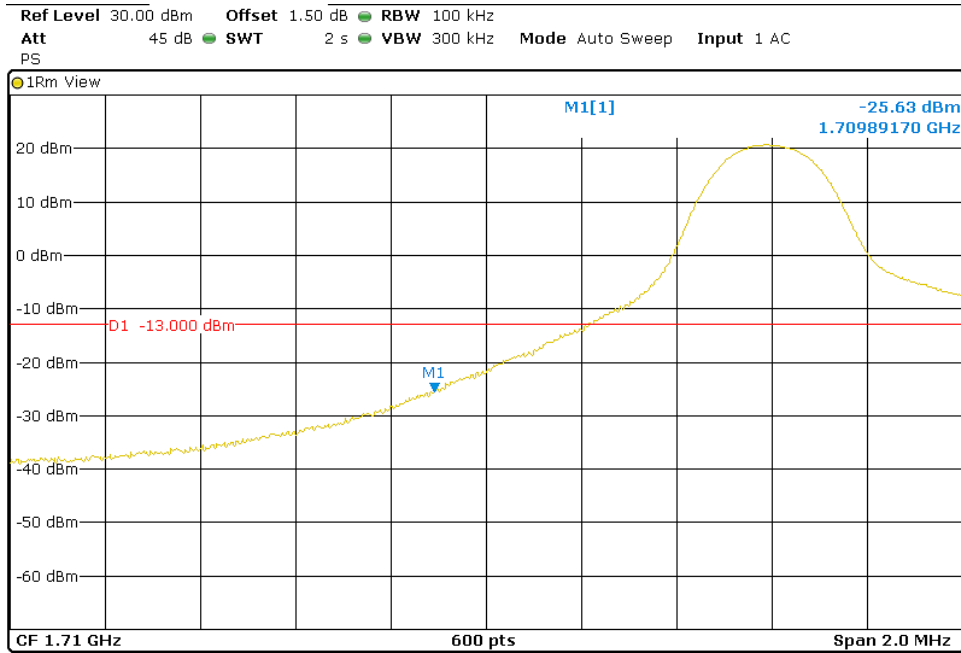

Highest Channel

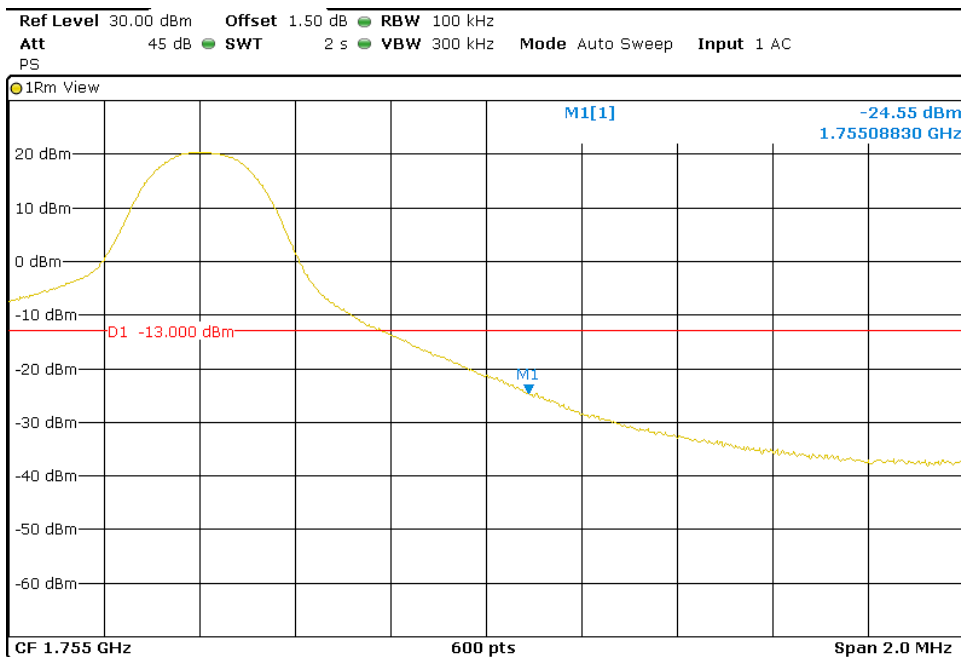

TEST RESULTS (Cont):

LTE QPSK MODULATION. RB = 50. Offset = 0. BW = 10 MHz

Lowest Channel

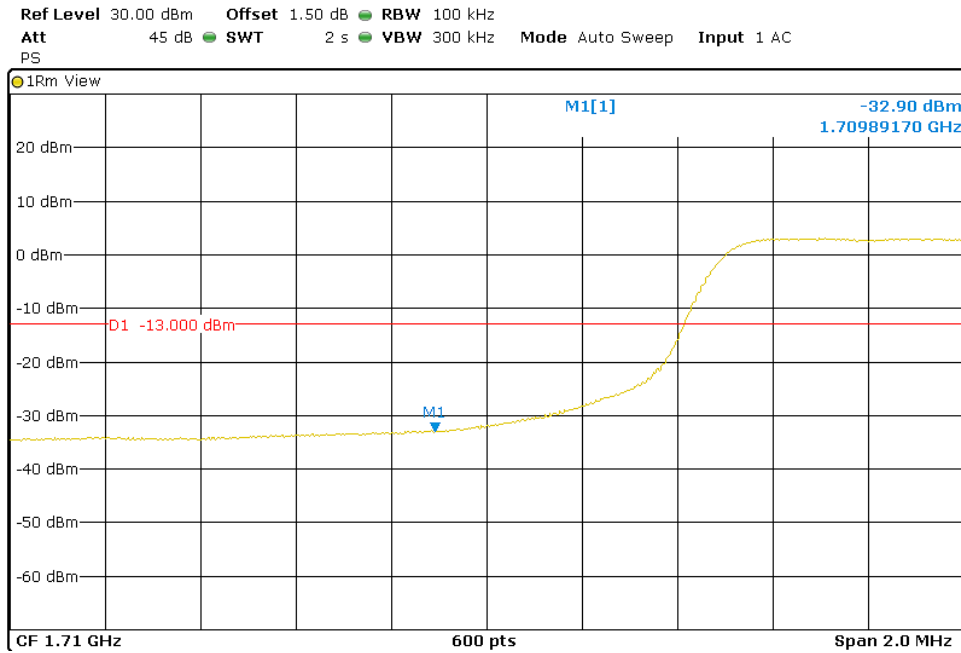

Highest Channel

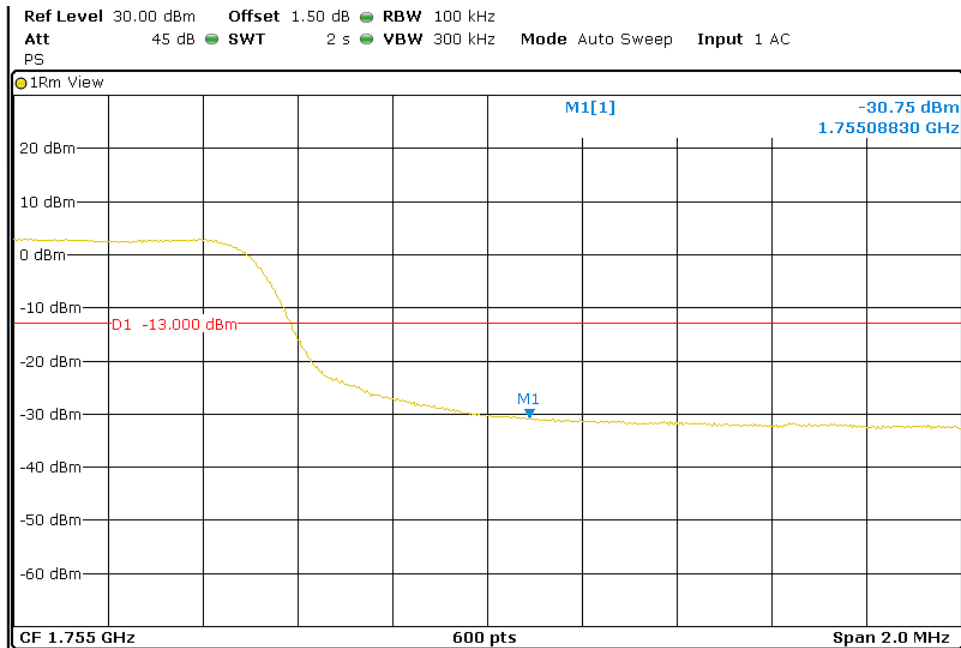

TEST RESULTS (Cont):

LTE QPSK MODULATION. RB = 1. Offset = 0. BW = 15 MHz

Lowest Channel

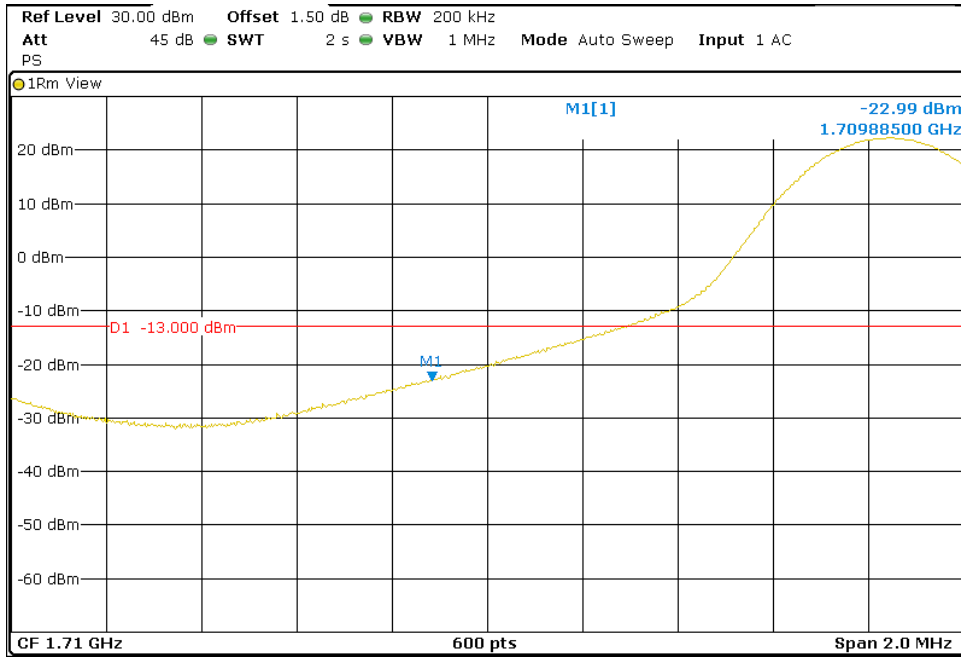

Highest Channel

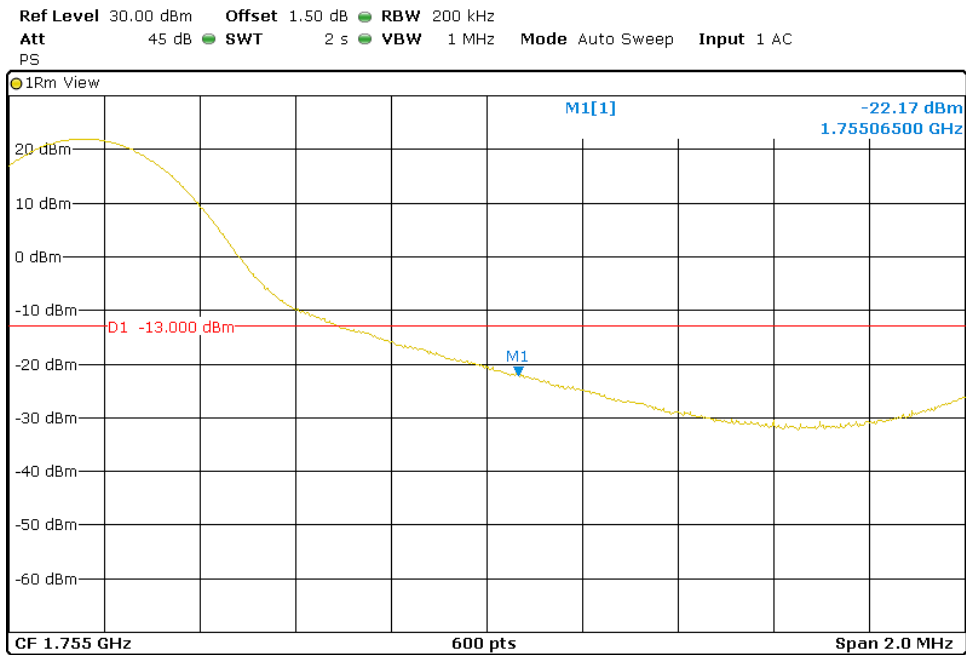

TEST RESULTS (Cont):

LTE QPSK MODULATION. RB = 75. Offset = 0. BW = 15 MHz

Lowest Channel

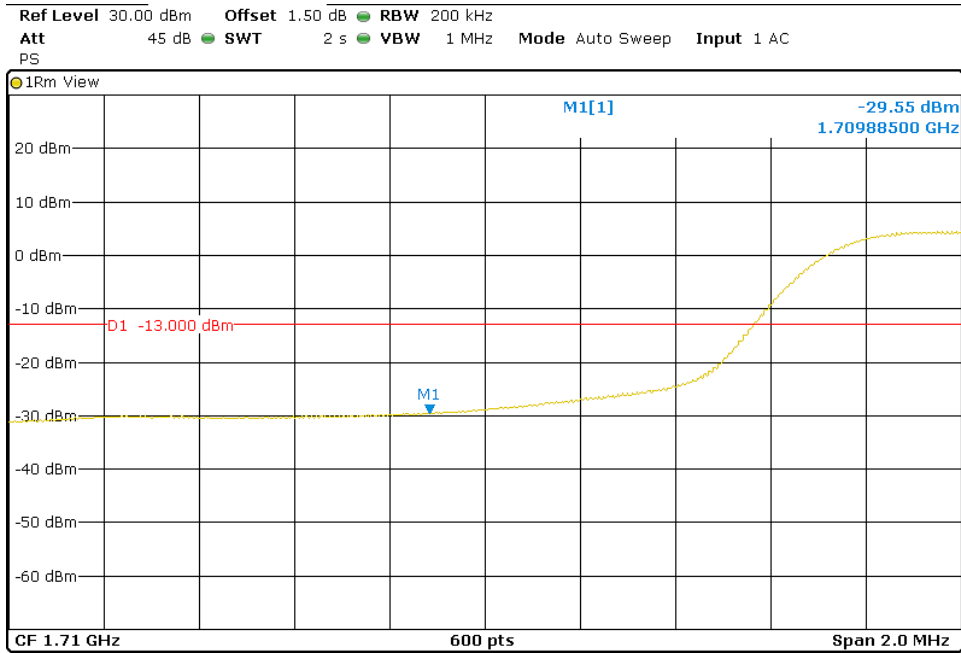

Highest Channel

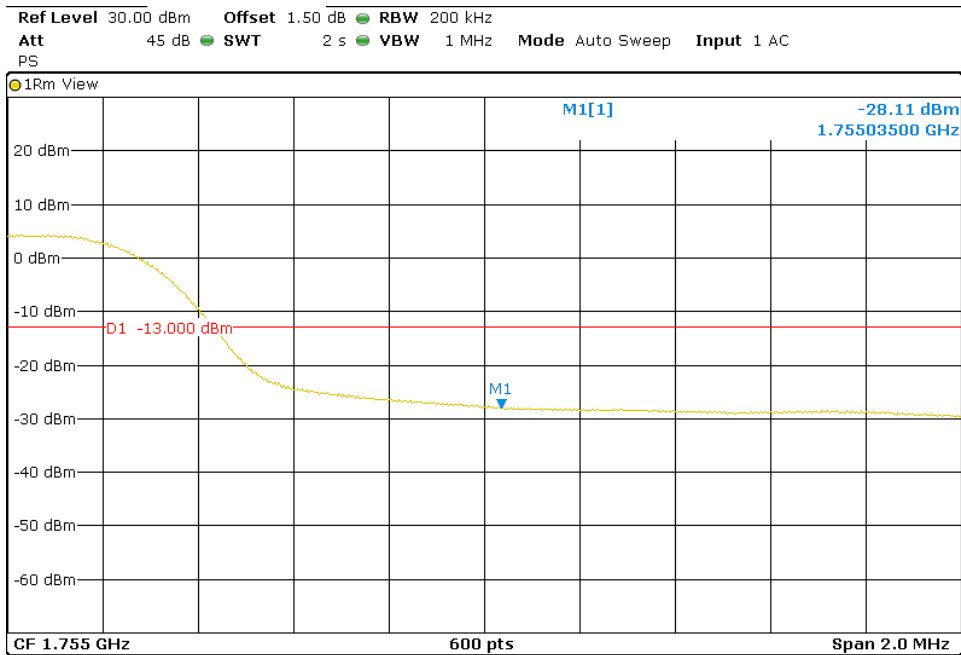

TEST RESULTS (Cont):

LTE QPSK MODULATION. RB = 1. Offset = 0. BW = 20 MHz

Lowest Channel

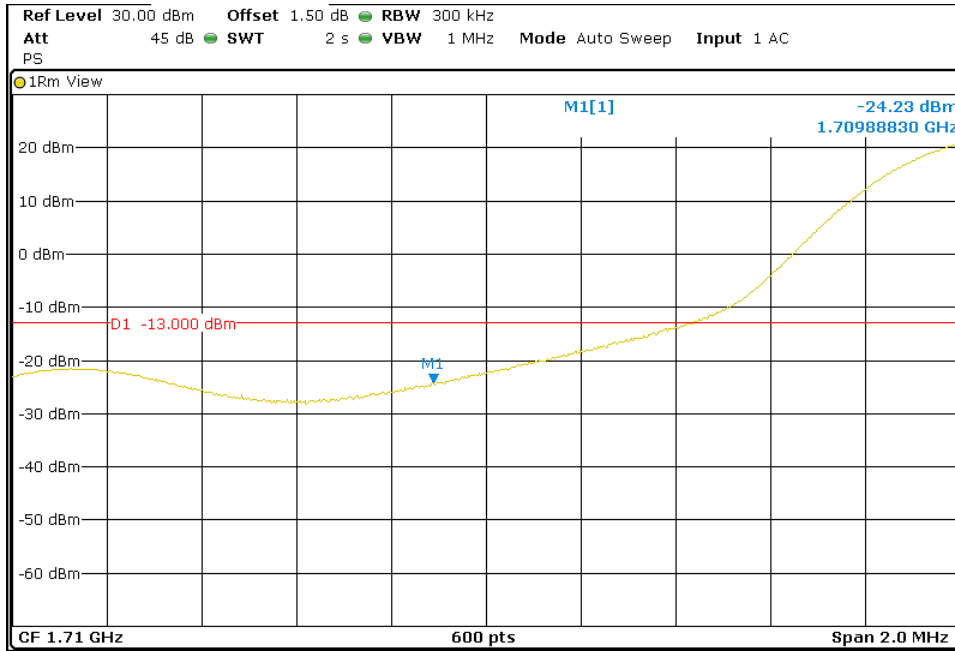

Highest Channel

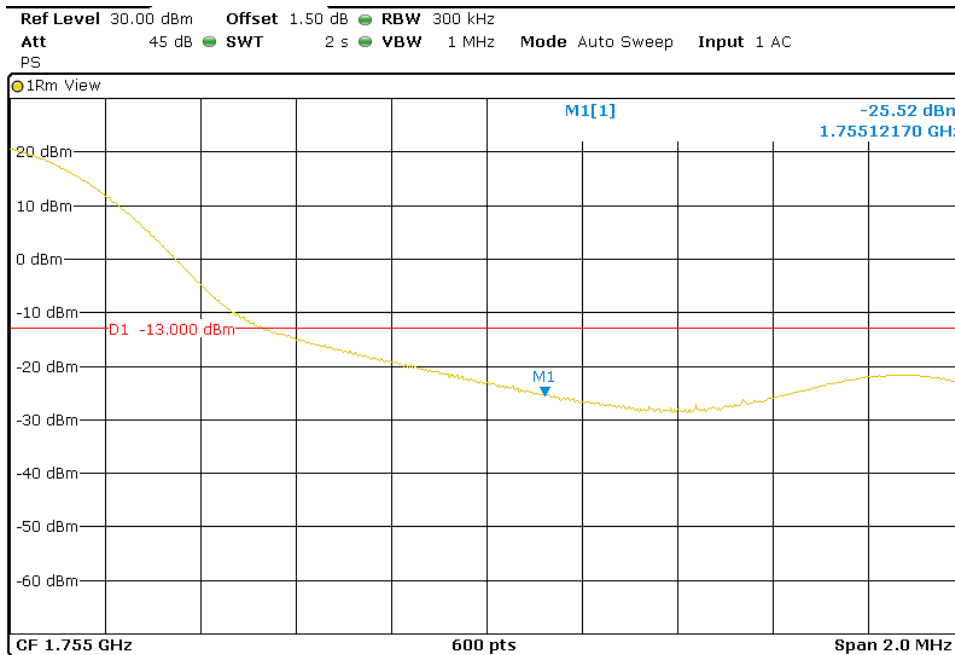

TEST RESULTS (Cont):

LTE QPSK MODULATION. RB = 100. Offset = 0. BW = 20 MHz

Lowest Channel

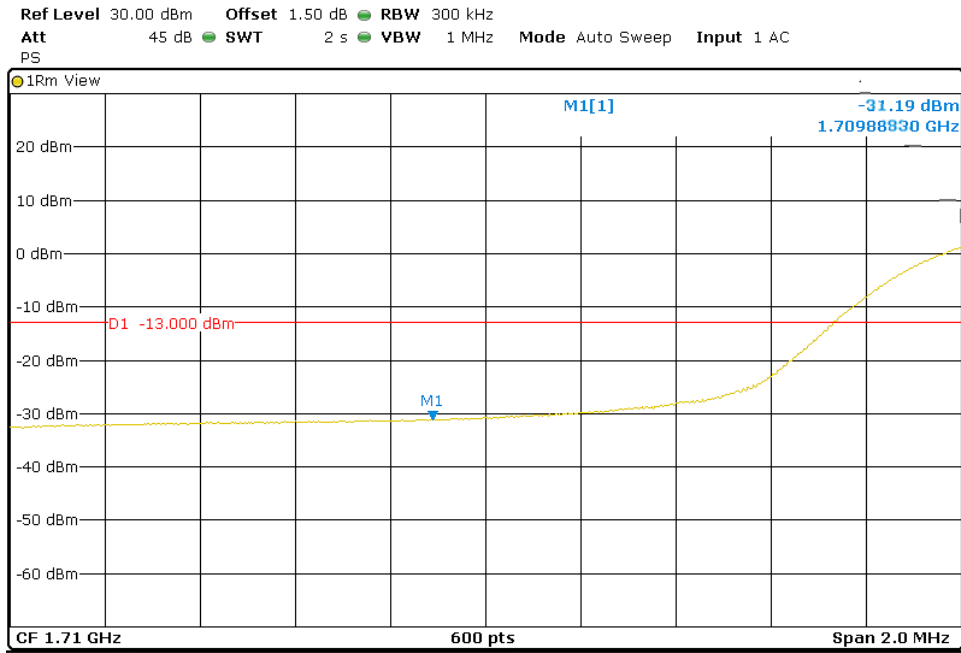

Highest Channel

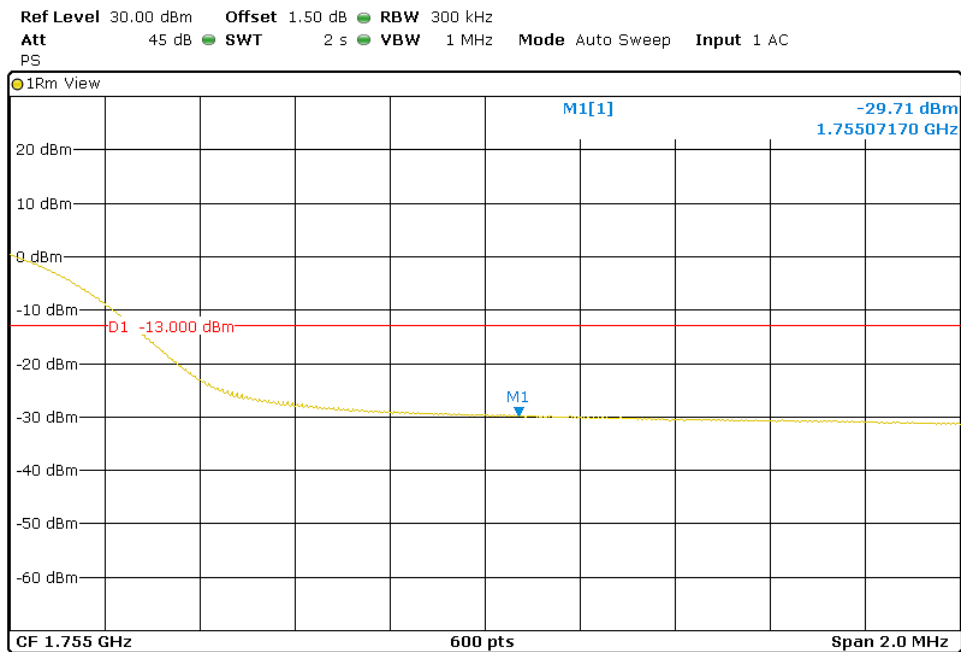

TESTED SAMPLES:	S/01
TESTED CONDITIONS MODES:	TC#02
TEST RESULTS:	PASS

RESULTS

LTE QPSK MODULATION	RB=1 Offset =0 BW = 5 MHz	RB=1 Offset =0 BW = 10 MHz
Maximum measured level at lowest Block Edge at antenna port (dBm)	-41.64	-25.84

LTE QPSK MODULATION	RB=25 Offset =0 BW = 5 MHz	RB=50 Offset =0 BW = 10 MHz
Maximum measured level at lowest Block Edge at antenna port (dBm)	-43.71	-37.08

LTE QPSK MODULATION	RB=1 Offset =0 BW = 5 MHz	RB=1 Offset =0 BW = 10 MHz
Maximum measured level at highest Block Edge at antenna port (dBm)	-42.69	-22.08

LTE QPSK MODULATION	RB=25 Offset =0 BW = 5 MHz	RB=50 Offset =0 BW = 10 MHz
Maximum measured level at highest Block Edge at antenna port (dBm)	-43.81	-35.85

TEST RESULTS (Cont):

LTE QPSK MODULATION. RB = 1. Offset = 0. BW = 5 MHz

Lowest Channel

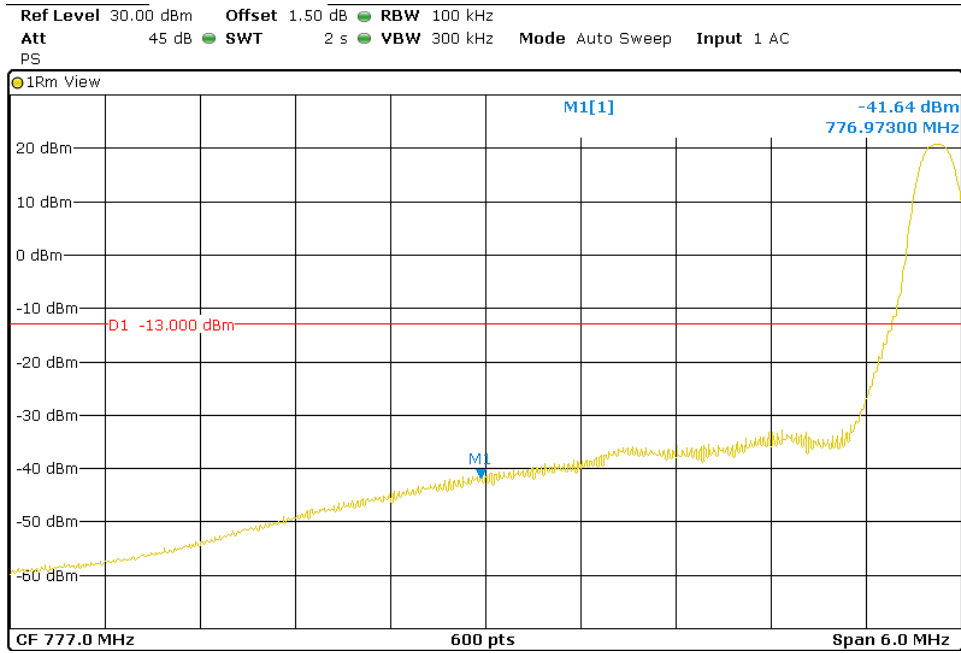

Highest Channel

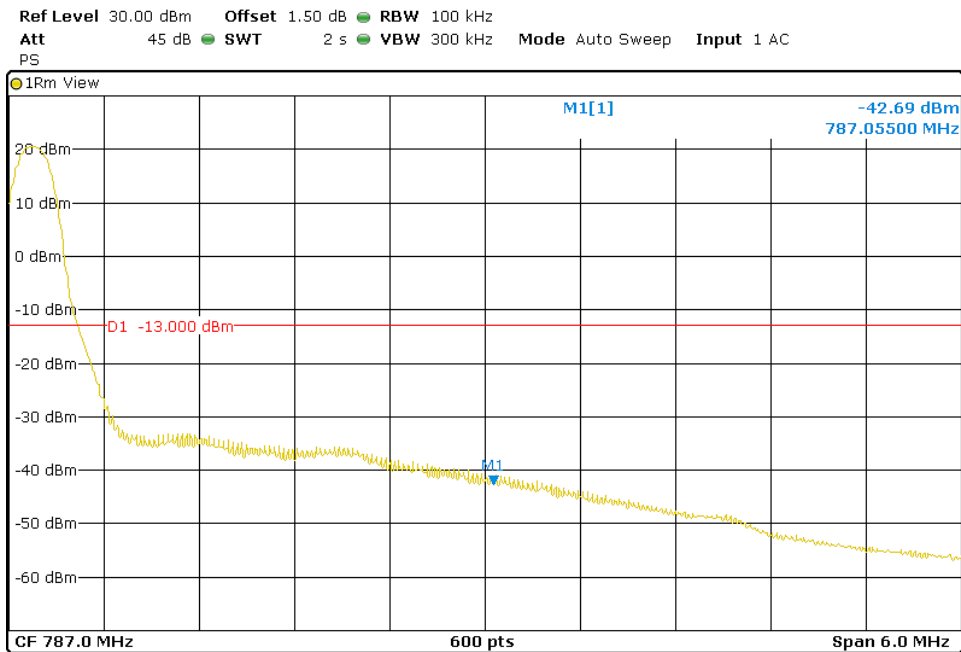

TEST RESULTS (Cont):

LTE QPSK MODULATION. RB = 25. Offset = 0. BW = 5 MHz

Lowest Channel

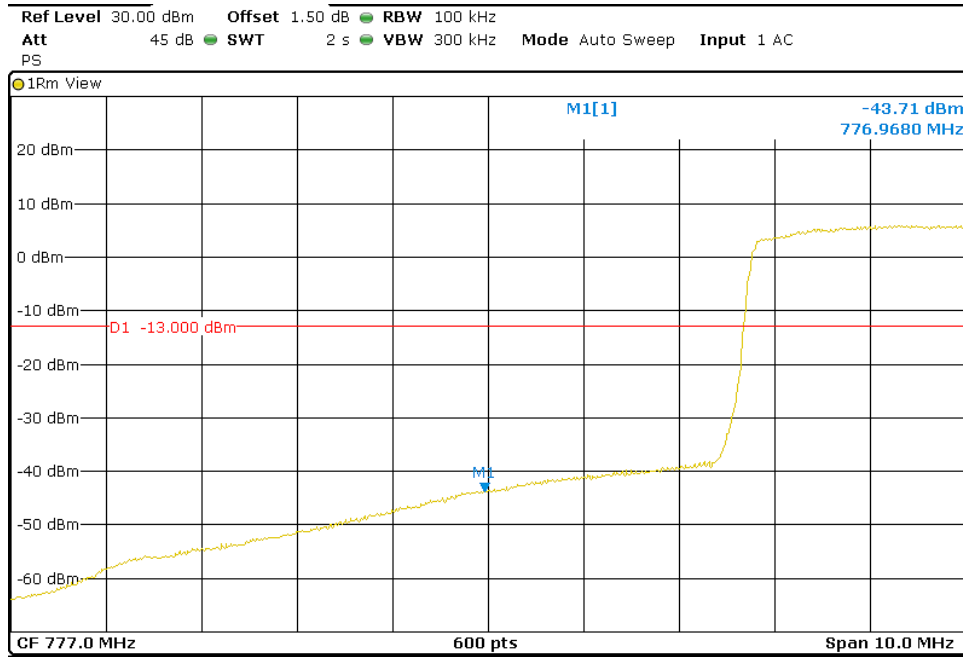

Highest Channel

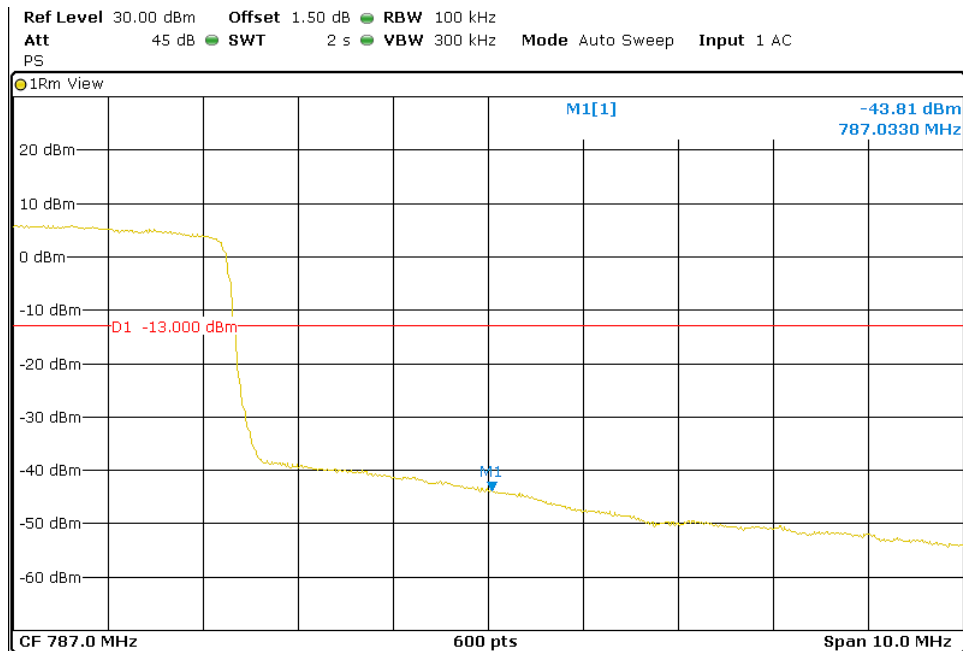

TEST RESULTS (Cont):

LTE QPSK MODULATION. RB = 1. Offset = 0. BW = 10 MHz

Lowest Channel

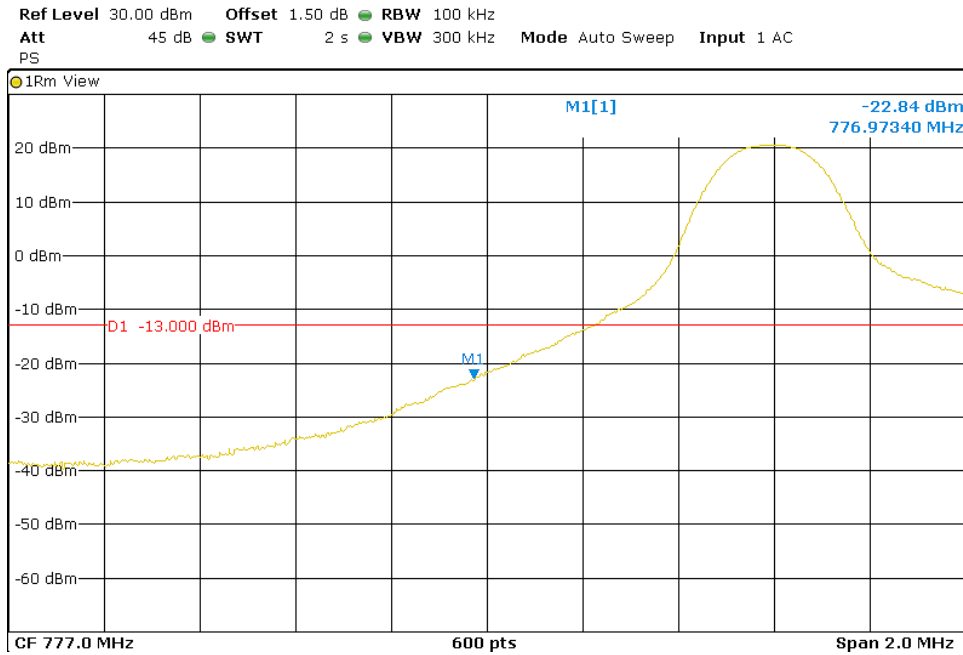

Highest Channel

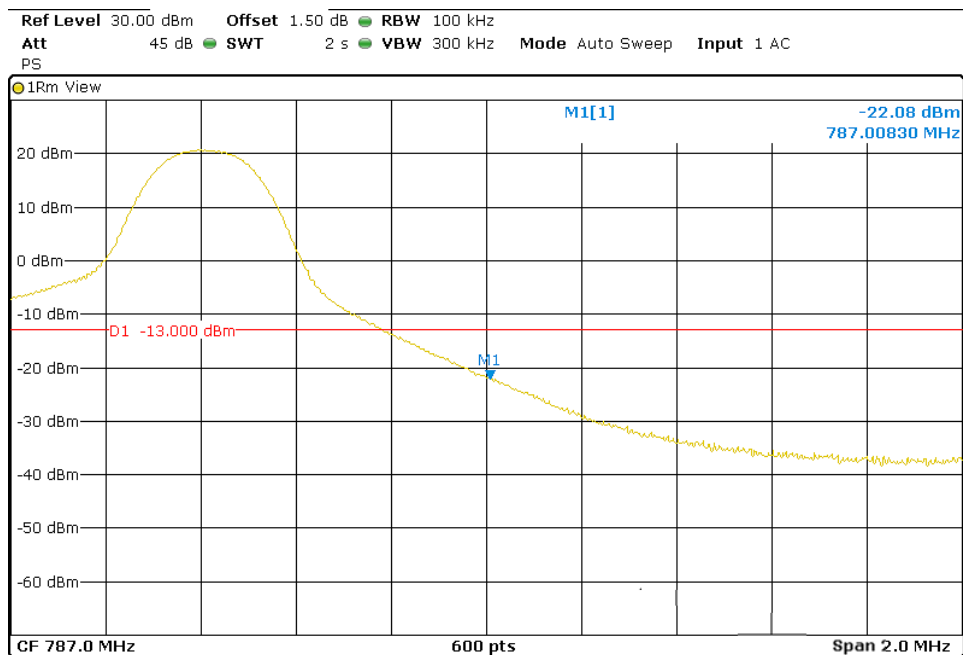

TEST RESULTS (Cont):

LTE QPSK MODULATION. RB = 50. Offset = 0. BW = 10 MHz

Lowest Channel

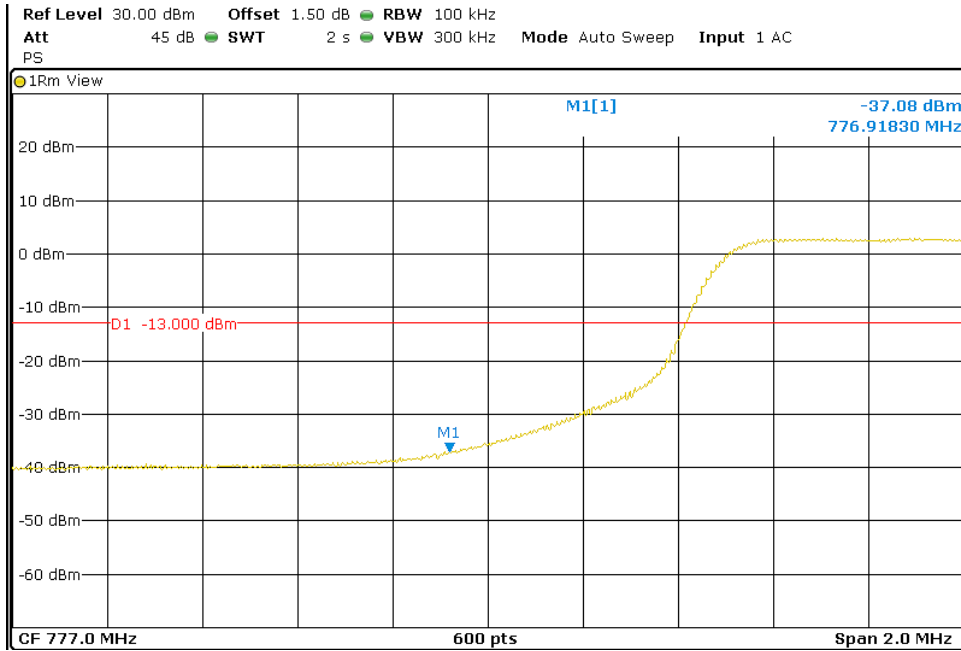

Highest Channel

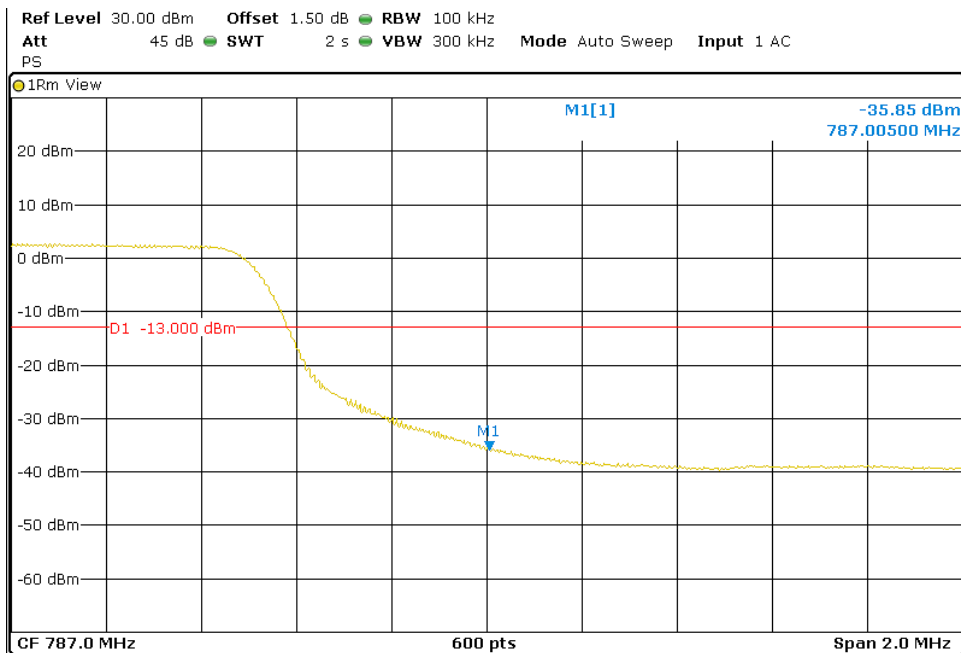

TEST A.7: RADIATED EMISSIONS

LIMITS:	Product standard:	FCC Part 27 / IC RSS-139/ IC RSS-130
	Test standard:	FCC §2.1053 and §27.53 /RSS-139 Clause 6.6/RSS-130 Clause 4.7

LIMITS

According to specification, the power of emissions shall be attenuated below the transmitter power (P) by a factor of at least $43 + 10 \log (P)$ dB. P in watts.

At P_o transmitting power of 2 watts (33 dBm), the specified minimum attenuation becomes $43+10\log (P_o)$. and the level in dBm relative to P_o becomes:

$$P_o \text{ (dBm)} - [43 + 10 \log (P_o \text{ in watts})] = -13 \text{ dBm}$$

TEST SETUP

The measurement was performed with the EUT inside an anechoic chamber. The spectrum was scanned from 30 MHz to at least the 10th harmonic of the highest frequency generated within the equipment.

The EUT was placed on a non-conductive stand at a 3-meter distance from the measuring antenna for measurements below 1 GHz and at 1-meter distance for measurements above 1 GHz.

Detected emissions were maximized at each frequency by rotating the EUT and adjusting the measuring antenna height and polarization. The maximum reading was recorded.

Radiated measurements < 1GHz

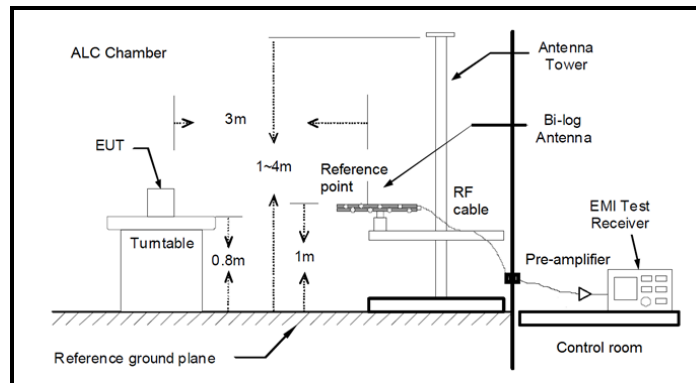

Radiated measurements > 1GHz

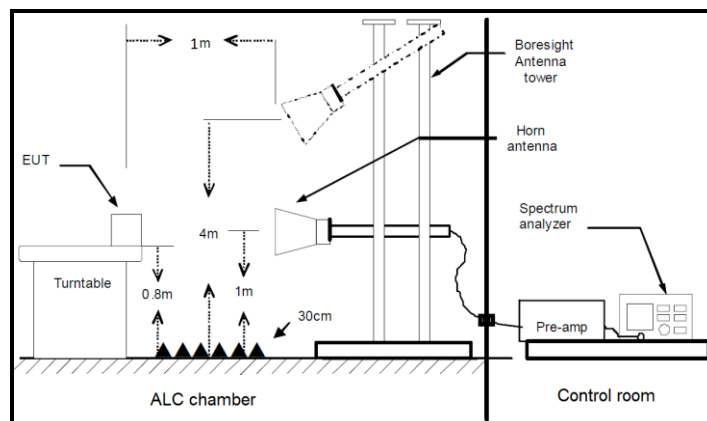

TESTED SAMPLES:	S/01
TESTED CONDITIONS MODES:	TC#01
TEST RESULTS:	PASS

RESULTS

A preliminary scan determined the QPSK 5 MHz bandwidth as the worst case. The configuration of Resource Blocks which is the worst case for conducted power was used.

The following plots show the results for this configuration.

No spurious signal was found at less than 20dB respect to the limit in all the frequency ranges.

LTE QPSK MODULATION. RB = 1. Offset = 0. BW = 5 MHz

FREQUENCY RANGE: 30-1000 MHz

Frequency (MHz)	PK+_CLRWR (dBm)	PK+_MAXH (dBm)	Comment
30.485000	-57.31	-52.60	
708.288667	-45.42	-37.21	
958.096000	-43.79	-36.79	

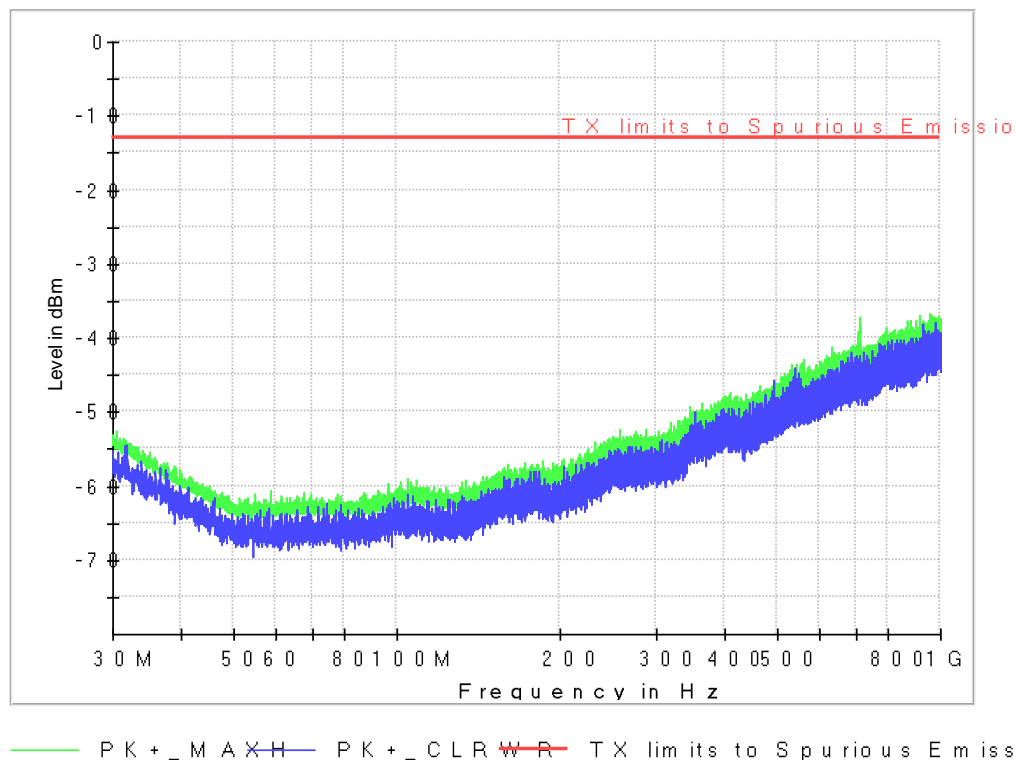

TEST RESULTS (Cont):

FREQUENCY RANGE: 1-18 GHz

Frequency (MHz)	PK+ CLRWR (dBm)	PK+ MAXH (dBm)	Comment
1730.400000	-52.82	-33.73	Fundamental
2133.466667	-49.54	-40.81	Fundamental
3460.000000	-48.49	-46.55	
6921.500000	-37.81	-35.84	
12276.500000	-49.64	-43.20	
13382.000000	-46.61	-40.86	

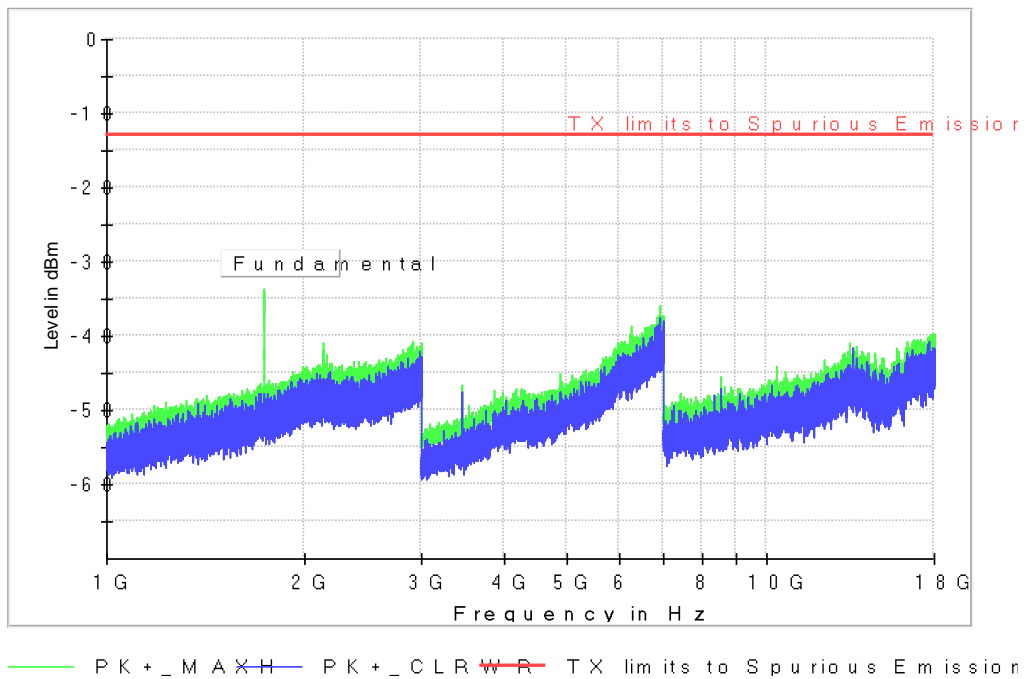

TESTED SAMPLES:	S/01
TESTED CONDITIONS MODES:	TC#02
TEST RESULTS:	PASS

RESULTS

A preliminary scan determined the QPSK 5 MHz bandwidth as the worst case. The configuration of Resource Blocks which is the worst case for conducted power was used.

The following tables and plots show the results for this configuration.

LTE QPSK MODULATION. RB = 1. Offset = 0. BW = 5 MHz

FREQUENCY RANGE: 30-1000 MHz

Frequency (MHz)	PK+_CLRWR (dBm)	PK+_MAXH (dBm)	Comment
709.323333	-44.77	-31.82	
750.160333	-43.61	-33.84	Fundamental
779.842333	-28.65	-25.43	Fundamental

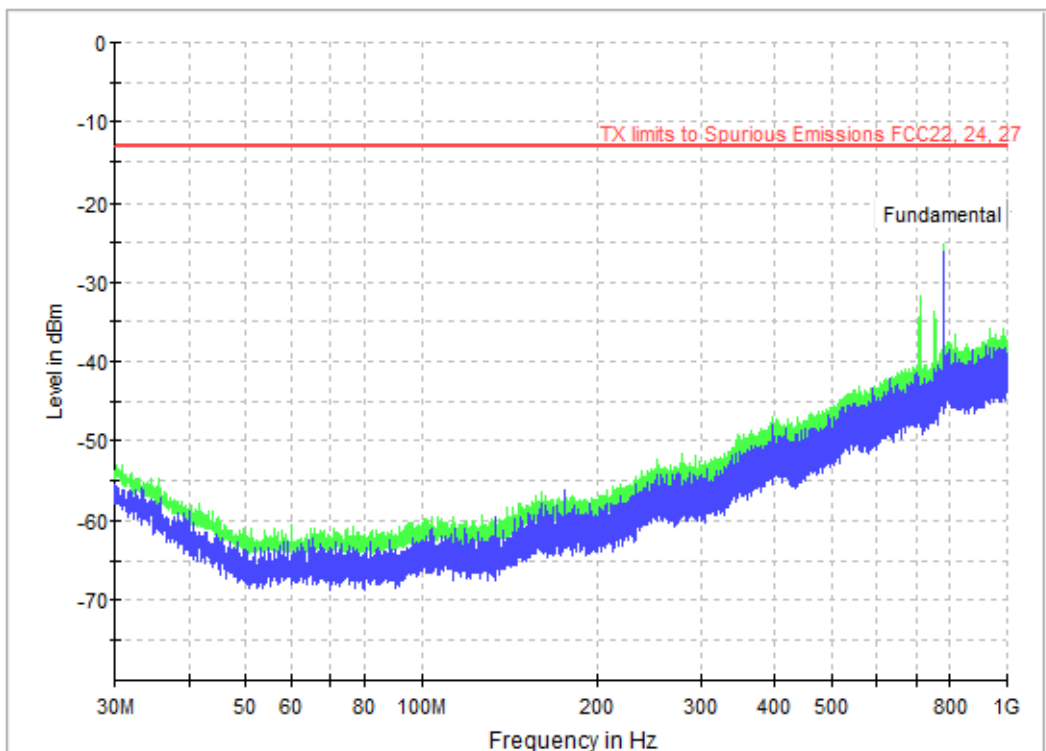

— PK+_MAXH — PK+_CLRWR — TX limits to Spurious Emissions FCC22, 24, 27

TEST RESULTS (Cont):

FREQUENCY RANGE: 1-18 GHz

Frequency (MHz)	PK+_CLRWR (dBm)	PK+_MAXH (dBm)	Comment
1559.666667	-41.66	-39.63	
2339.533333	-47.93	-35.10	
3119.000000	-55.91	-47.77	
6957.500000	-41.98	-35.79	
13071.000000	-48.51	-41.58	
17999.000000	-44.13	-39.96	

