

EN

ATTENTION!

- Avoid use in a humid or high temperature environment if possible.
- Don't hit, disassemble or re-assemble the product - this may lead to malfunction.
- High Temperatures can reduce charge efficiency.
- Smartphone power consumption can exceed charge power. Setup phone appropriately!

DE

ACHTUNG!

- Einsatz in einer feuchten Umgebung oder bei hohen Temperaturen nach Möglichkeit vermeiden.
- Nicht auf das Produkt einschlagen, zerlegen oder wieder zusammenbauen - dies kann zu Fehlfunktionen führen.
- Hohe Temperaturen können die Ladeleistung verringern.
- Der Stromverbrauch des Smartphones kann die Ladeleistung übersteigen. Telefon entsprechend einstellen!

FR

ATTENTION!

- Si possible, éviter d'utiliser le produit dans un environnement humide ou à des températures élevées.
- Ne pas frapper, démonter ou remonter le produit - cela peut entraîner un dysfonctionnement.
- Des températures élevées peuvent réduire la puissance de charge.
- La consommation d'énergie du smartphone peut dépasser la puissance de charge. Régler le téléphone en conséquence!

ES

¡ATENCIÓN!

- Si es posible, evita utilizarlo en un entorno húmedo o a altas temperaturas.
- No martillees, desmontes o vuelvas a montar el producto, ya que podrías provocar un mal funcionamiento.
- Las altas temperaturas pueden reducir el rendimiento de la carga.
- El consumo de energía del smartphone puede superar la potencia de carga. ¡Ajusta el teléfono en consecuencia!

FCC Statement

1. This device complies with Part 15 of the FCC Rules. Operation is subject to the following two conditions:
(1) This device may not cause harmful interference, and
(2) This device must accept any interference received, including interference that may cause undesired operation.
 2. Changes or modifications not expressly approved by the party responsible for compliance could void the user's authority to operate the equipment.
- NOTE: This equipment has been tested and found to comply with the limits for a Class B digital device, pursuant to Part 15 of the FCC Rules. These limits are designed to provide reasonable protection against harmful interference in a residential installation.
- This equipment generates uses and can radiate radio frequency energy and, if not installed and used in accordance with the instructions, may cause harmful interference to radio communications. However, there is no guarantee that interference will not occur in a particular installation. If this equipment does cause harmful interference to radio or television reception, which can be determined by turning the equipment off and on, the user is encouraged to try to correct the interference by one or more of the following measures:
- Reorient or relocate the receiving antenna.
 - Increase the separation between the equipment and receiver.
 - Connect the equipment into an outlet on a circuit different from that to which the receiver is connected.
 - Consult the dealer or an experienced radio/TV technician for help.

FCC Radiation Exposure Statement

This equipment complies with FCC radiation exposure limits set forth for an uncontrolled environment. This equipment should be installed and operated with minimum distance 20cm between the radiator & your body.

Technical Specifications

Input	USB-C: USB-PD USB-A: 5V/2A • 5V/3A QC 2.0/3.0
Wireless Output	Max 15W <i>Charge power is variable and depends on power source, phone model, temperature, etc.</i>
Recommended Operating Temperature	-10—40° C <i>Charge performance will drop above -40° C</i>
Power Consumption	8—20 mA (Standby)



SP
CONNECT



**CHARGING
PAD**

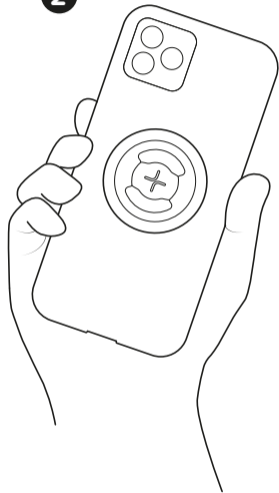
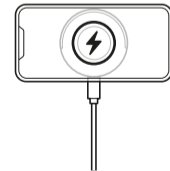
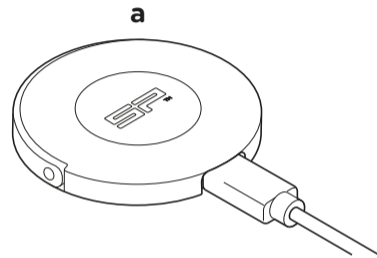
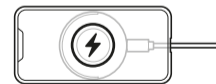
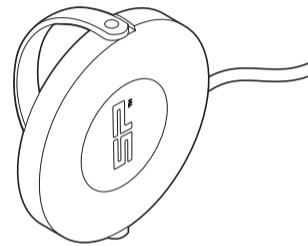
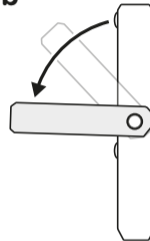
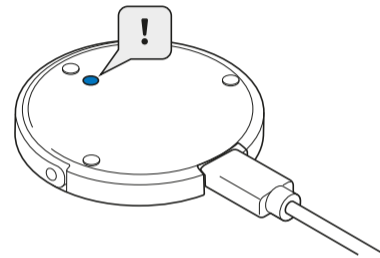

EN / DE / FR / ES

1

USB-C
Power Source
Stromquelle
Source de courant
Fuente de energía

2**3****b****4**

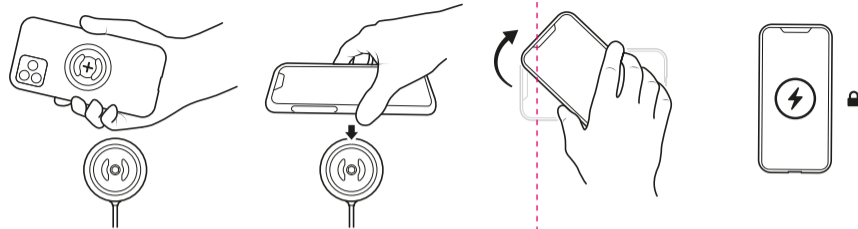
 RED	Ready / Bereit / Prêt / Listo
 BLUE	Charging / Lädt / Chargement / Cargando
 RED FLASH	Error / Fehler / Erreur / Error



EN

ATTENTION!

- Cut off power supply when not in use.
- Avoid use in a humid or high temperature environment if possible.
- Don't hit, disassemble or re-assemble the product - this may lead to malfunction.
- For waterproof connection use compatible SP Connect™ cables only.
- High temperatures can reduce charge efficiency.
- Smartphone power consumption can exceed charge power. Setup phone appropriately!

Setup Tips for Outdoor Navigation

- Outdoor navigation at high temperature reduces charge efficiency.
- Use adaptive screen brightness, consider using night mode, switch off screen occasionally.
- Use locally stored maps to avoid data traffic and power consumption.
- Turn off data traffic if not needed.
- Turn off unnecessary apps running in the background.
- Turn off Wi-Fi antenna while you are moving.

DE

ACHTUNG!

- Stromzufuhr unterbrechen, wenn nicht in Verwendung.
- Einsatz in einer feuchten Umgebung oder bei hohen Temperaturen nach Möglichkeit vermeiden.
- Nicht auf das Produkt einschlagen, zerlegen oder wieder zusammenbauen
 - dies kann zu Fehlfunktionen führen.
- Für eine wasserdichte Verbindung nur kompatible SP Connect™-Kabel verwenden.
- Hohe Temperaturen können die Ladeleistung verringern.

- Der Stromverbrauch des Smartphones kann die Ladeleistung übersteigen. Telefon entsprechend einstellen!

Tipps zur Einrichtung für die Navigation im Freien

- Navigation im Freien bei hohen Temperaturen verringert die Ladeleistung.
- Verwende eine angepasste Bildschirmhelligkeit, erwäge den Nachtmodus und schalte den Bildschirm gelegentlich aus.
- Verwende lokal gespeicherte Karten, um Datenverkehr und Stromverbrauch zu vermeiden.
- Schalte den Datenverkehr aus, wenn er nicht benötigt wird.
- Schalte unnötige Apps aus, die im Hintergrund laufen.
- Schalte die Wi-Fi-Antenne aus, wenn du dich bewegst.

FR

ATTENTION!

- Couper l'alimentation électrique lorsqu'il n'est pas utilisé.

- Si possible, éviter d'utiliser le produit dans un environnement humide ou à des températures élevées.
- Ne pas frapper, démonter ou remonter le produit • cela peut entraîner un dysfonctionnement.
- Pour une connexion étanche, utiliser uniquement des câbles SP Connect™ compatibles.
- Des températures élevées peuvent réduire la puissance de charge.
- La consommation d'énergie du smartphone peut dépasser la puissance de charge. Régler le téléphone en conséquence!

Conseils de configuration pour la navigation extérieure

- La navigation en extérieur à température élevée réduit l'efficacité de la charge.
- Utilisez une luminosité d'écran adaptative, pensez à utiliser le mode nuit, éteignez l'écran de temps en temps.
- Utilisez des cartes stockées localement pour éviter le trafic de données et la consommation d'énergie.
- Désactivez le trafic de données s'il n'est pas nécessaire.

- Désactivez les applications inutiles fonctionnant en arrière-plan.
- Éteignez l'antenne Wi-Fi lorsque vous vous déplacez.

ES

¡ATENCIÓN!

- Desconecta la fuente de alimentación cuando no la utilices.
- Si es posible, evita utilizarlo en un entorno húmedo o a altas temperaturas.
- No martillees, desmontes o vuelvas a montar el producto, ya que podrías provocar un mal funcionamiento.
- Utiliza sólo cables SP Connect™ compatibles para una conexión a prueba de agua.
- Las altas temperaturas pueden reducir el rendimiento de la carga.
- El consumo de energía del smartphone puede superar la potencia de carga. ¡Ajusta el teléfono en consecuencia!

Consejos de configuración para la navegación en exteriores

- La navegación en exteriores a altas

temperaturas reduce la eficiencia de la carga.

- Utiliza un brillo de pantalla adaptado, considera el uso del modo nocturno, apaga la pantalla de vez en cuando.
- Utiliza mapas almacenados localmente para evitar el tráfico de datos y el consumo de energía.
- Apaga el tráfico de datos si no es necesario.
- Apaga las aplicaciones innecesarias que se ejecutan en segundo plano.
- Apaga la antena Wi-Fi cuando estés en movimiento.

SP
CONNECT

CHARGING ANTI VIBRATION MODULE



EN / DE / FR / ES

1

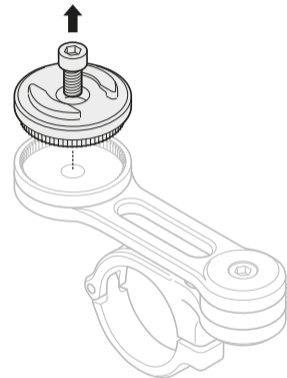

2

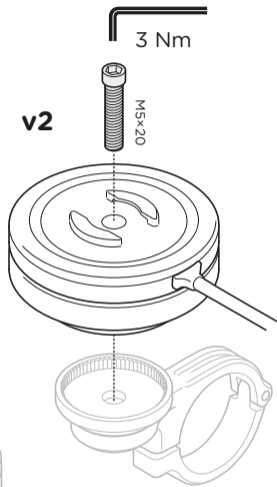
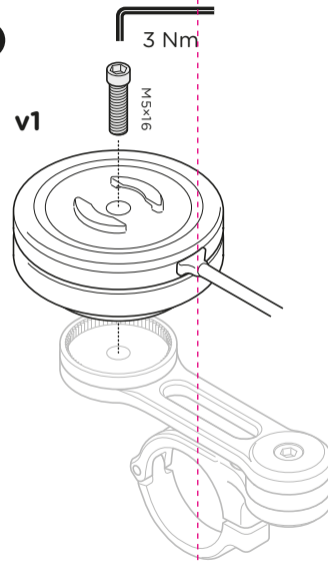

3

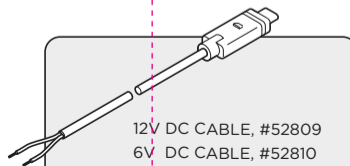
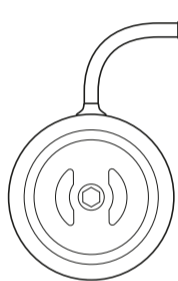

12V DC CABLE, #52809
6V DC CABLE, #52810

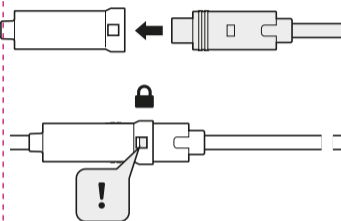

USB
Power Source
Stromquelle
Source de courant
Fuente de energía

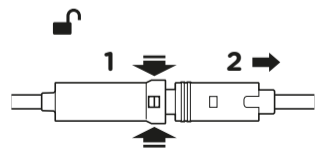

Technical Specifications

Input	USB-C: USB-PD USB-A: 5V/2A • 5V/3A QC 2.0/3.0
Wireless Output	Max 15W <i>Charge power is variable and depends on power source, phone model, temperature, etc.</i>
Recommended Operating Temperature	-10—40° C <i>Charge performance will drop above -40° C</i>
Power Consumption	8—20 mA (Standby)

IP65 RATED: No ingress of dust; complete protection against contact (dust tight). Water projected by a nozzle (6.3 mm) against enclosure from any direction shall have no harmful effects. Minimum operating temperature: 0°C / 32°F



FCC Statement

1. This device complies with Part 15 of the FCC Rules. Operation is subject to the following two conditions:
(1) This device may not cause harmful interference, and
(2) This device must accept any interference received, including interference that may cause undesired operation.

2. Changes or modifications not expressly approved by the party responsible for compliance could void the user's authority to operate the equipment.

NOTE: This equipment has been tested and found to comply with the limits for a Class B digital device, pursuant to Part 15 of the FCC Rules. These limits are designed to provide reasonable protection against harmful interference in a residential installation. This equipment generates uses and can radiate radio frequency energy and, if not installed and used in accordance with the instructions, may cause harmful interference to radio communications. However, there is no guarantee that interference will not occur in a particular installation. If this equipment does cause harmful interference to radio or television reception, which can be determined by turning the equipment off and on, the user is encouraged to try to correct the interference by one or more of the following measures:

- Reorient or relocate the receiving antenna.
- Increase the separation between the equipment and receiver.
- Connect the equipment into an outlet on a circuit different from that to which the receiver is connected.
- Consult the dealer or an experienced radio/TV technician for help.

FCC Radiation Exposure Statement

This equipment complies with FCC radiation exposure limits set forth for an uncontrolled environment. This equipment should be installed and operated with minimum distance 20cm between the radiator & your body.

Technical Specifications

Input	USB-C: USB-PD USB-A: 5V/2A • 5V/3A QC 2.0/3.0
Wireless Output	Max 15W <i>Charge power is variable and depends on power source, phone model, temperature, etc.</i>
Recommended Operating Temperature	-10—40° C <i>Charge performance will drop above -40° C</i>
Power Consumption	8—20 mA (Standby)

IP65 RATED: No ingress of dust; complete protection against contact (dust tight). Water projected by a nozzle (6.3 mm) against enclosure from any direction shall have no harmful effects. Minimum operating temperature: 0°C / 32°F

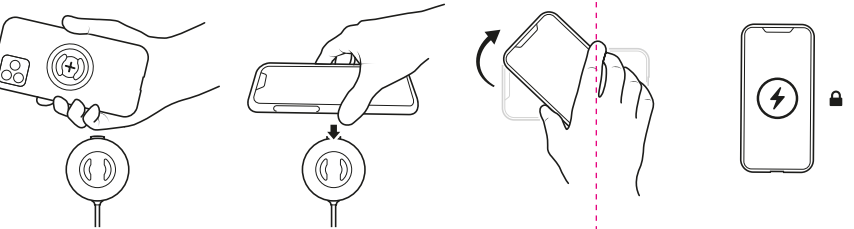

EN

ATTENTION!

- Cut off power supply when not in use.
- Avoid use in a humid or high temperature environment if possible.
- Don't hit, disassemble or re-assemble the product - this may lead to malfunction.
- For waterproof connection use compatible SP Connect™ cables only.
- High Temperatures can reduce charge efficiency.
- Smartphone power consumption can exceed charge power. Setup phone appropriately!

Setup Tips for Outdoor Navigation

- Outdoor navigation at high temperature reduces charge efficiency.
- Use adaptive screen brightness, consider using night mode, switch off screen occasionally.
- Use locally stored maps to avoid data traffic and power consumption.
- Turn off data traffic if not needed.
- Turn off unnecessary apps running in the background.
- Turn off Wi-Fi antenna while you are moving.

DE

ACHTUNG!

- Stromzufuhr unterbrechen, wenn nicht in Verwendung.
- Einsatz in einer feuchten Umgebung oder bei hohen Temperaturen nach Möglichkeit vermeiden.
- Nicht auf das Produkt einschlagen, zerlegen oder wieder zusammenbauen • dies kann zu Fehlfunktionen führen.
- Für eine wasserdichte Verbindung nur kompatible SP Connect™-Kabel verwenden.
- Hohe Temperaturen können die Ladeleistung verringern.

- Der Stromverbrauch des Smartphones kann die Ladeleistung übersteigen. Telefon entsprechend einstellen!

Tipps zur Einrichtung für die Navigation im Freien

- Navigation im Freien bei hohen Temperaturen verringert die Ladeleistung.
- Verwende eine angepasste Bildschirmhelligkeit, erwäge den Nachtmodus und schalte den Bildschirm gelegentlich aus.
- Verwende lokal gespeicherte Karten, um Datenverkehr und Stromverbrauch zu vermeiden.
- Schalte den Datenverkehr aus, wenn er nicht benötigt wird.
- Schalte unnötige Apps aus, die im Hintergrund laufen.
- Schalte die Wi-Fi-Antenne aus, wenn du dich bewegst.

FR

ATTENTION!

- Couper l'alimentation électrique lorsqu'il n'est pas utilisé.

- Si possible, éviter d'utiliser le produit dans un environnement humide ou à des températures élevées.

- Ne pas frapper, démonter ou remonter le produit • cela peut entraîner un dysfonctionnement.

- Pour une connexion étanche, utiliser uniquement des câbles SP Connect™ compatibles.

- Des températures élevées peuvent réduire la puissance de charge.

- La consommation d'énergie du smartphone peut dépasser la puissance de charge. Régler le téléphone en conséquence!

Conseils de configuration pour la navigation extérieure

- La navigation en extérieur à température élevée réduit l'efficacité de la charge.
- Utilisez une luminosité d'écran adaptative, pensez à utiliser le mode nuit, éteignez l'écran de temps en temps.
- Utilisez des cartes stockées localement pour éviter le trafic de données et la consommation d'énergie.
- Désactivez le trafic de données s'il n'est pas nécessaire.

- Désactivez les applications inutiles fonctionnant en arrière-plan.

- Éteignez l'antenne Wi-Fi lorsque vous vous déplacez.

ES

¡ATENCIÓN!

- Desconecta la fuente de alimentación cuando no la utilices.
- Si es posible, evita utilizarlo en un entorno húmedo o a altas temperaturas.
- No martillees, desmontes o vuelvas a montar el producto, ya que podrías provocar un mal funcionamiento.
- Utiliza sólo cables SP Connect™ compatibles para una conexión a prueba de agua.
- Las altas temperaturas pueden reducir el rendimiento de la carga.
- El consumo de energía del smartphone puede superar la potencia de carga. ¡Ajusta el teléfono en consecuencia!

Consejos de configuración para la navegación en exteriores

- La navegación en exteriores a altas

- temperaturas reduce la eficiencia de la carga.

- Utiliza un brillo de pantalla adaptado, considera el uso del modo nocturno, apaga la pantalla de vez en cuando.

- Utiliza mapas almacenados localmente para evitar el tráfico de datos y el consumo de energía.

- Apaga el tráfico de datos si no es necesario.

- Apaga las aplicaciones innecesarias que se ejecutan en segundo plano.

- Apaga la antena Wi-Fi cuando estés en movimiento.

SP
CONNECT

CHARGING
MODULE



EN / DE / FR / ES

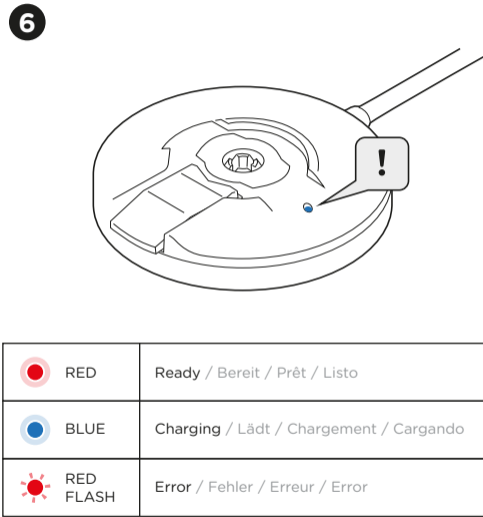
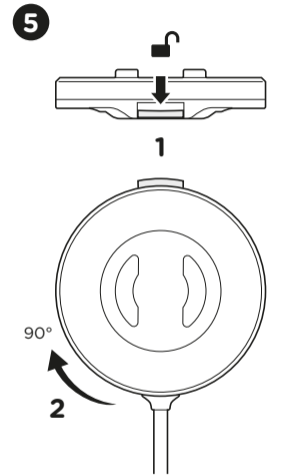
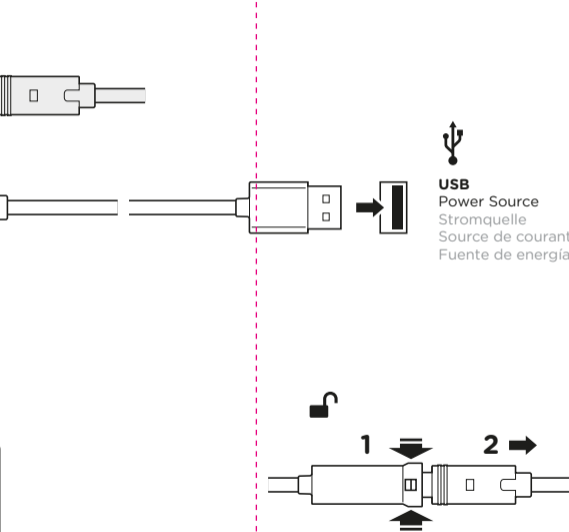
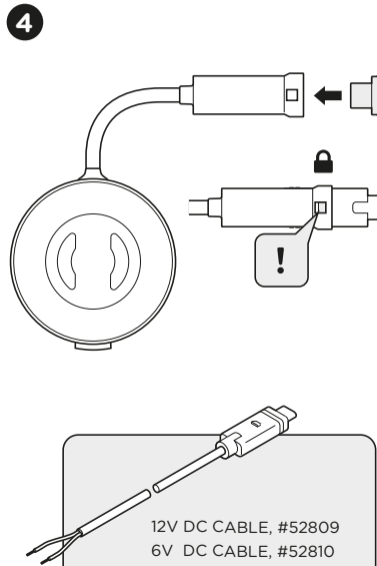
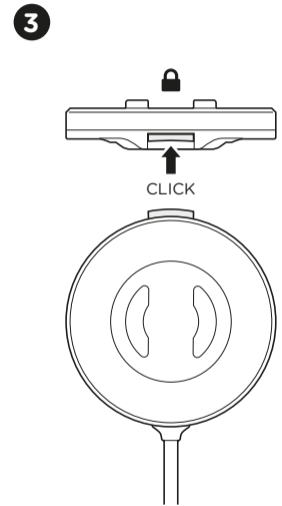
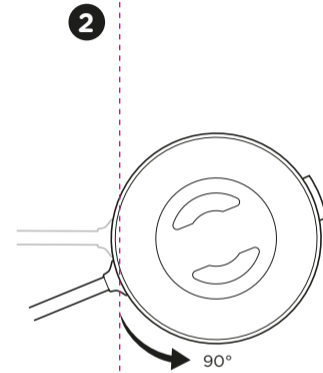
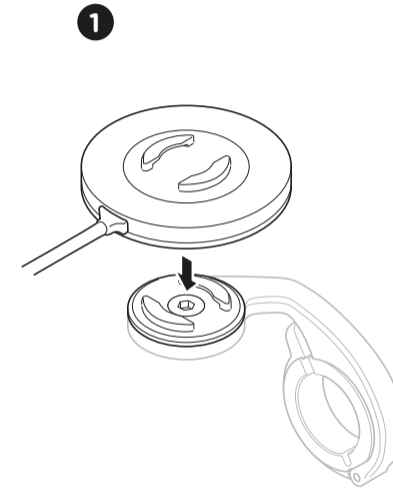

FCC Statement

1. This device complies with Part 15 of the FCC Rules. Operation is subject to the following two conditions:
 (1) This device may not cause harmful interference, and
 (2) This device must accept any interference received, including interference that may cause undesired operation.

2. Changes or modifications not expressly approved by the party responsible for compliance could void the user's authority to operate the equipment.

NOTE: This equipment has been tested and found to comply with the limits for a Class B digital device, pursuant to Part 15 of the FCC Rules. These limits are designed to provide reasonable protection against harmful interference in a residential installation. This equipment generates uses and can radiate radio frequency energy and, if not installed and used in accordance with the instructions, may cause harmful interference to radio communications. However, there is no guarantee that interference will not occur in a particular installation. If this equipment does cause harmful interference to radio or television reception, which can be determined by turning the equipment off and on, the user is encouraged to try to correct the interference by one or more of the following measures:

- Reorient or relocate the receiving antenna.
- Increase the separation between the equipment and receiver.
- Connect the equipment into an outlet on a circuit different from that to which the receiver is connected.
- Consult the dealer or an experienced radio/TV technician for help.

FCC Radiation Exposure Statement

This equipment complies with FCC radiation exposure limits set forth for an uncontrolled environment. This equipment should be installed and operated with minimum distance 20cm between the radiator & your body.

EN

ATTENTION!

- Avoid use in a humid or high temperature environment if possible.
- Don't hit, disassemble or re-assemble the product - this may lead to malfunction.
- High Temperatures can reduce charge efficiency.
- Smartphone power consumption can exceed charge power. Setup phone appropriately!

DE

ACHTUNG!

- Einsatz in einer feuchten Umgebung oder bei hohen Temperaturen nach Möglichkeit vermeiden.
- Nicht auf das Produkt einschlagen, zerlegen oder wieder zusammenbauen - dies kann zu Fehlfunktionen führen.
- Hohe Temperaturen können die Ladeleistung verringern.
- Der Stromverbrauch des Smartphones kann die Ladeleistung übersteigen. Telefon entsprechend einstellen!

FR

ATTENTION!

- Si possible, éviter d'utiliser le produit dans un environnement humide ou à des températures élevées.
- Ne pas frapper, démonter ou remonter le produit - cela peut entraîner un dysfonctionnement.
- Des températures élevées peuvent réduire la puissance de charge.
- La consommation d'énergie du smartphone peut dépasser la puissance de charge. Régler le téléphone en conséquence!

ES

¡ATENCIÓN!

- Si es posible, evita utilizarlo en un entorno húmedo o a altas temperaturas.
- No martillees, desmontes o vuelvas a montar el producto, ya que podrías provocar un mal funcionamiento.
- Las altas temperaturas pueden reducir el rendimiento de la carga.
- El consumo de energía del smartphone puede superar la potencia de carga. ¡Ajusta el teléfono en consecuencia!

FCC Statement

1. This device complies with Part 15 of the FCC Rules. Operation is subject to the following two conditions:
(1) This device may not cause harmful interference, and
(2) This device must accept any interference received, including interference that may cause undesired operation.
 2. Changes or modifications not expressly approved by the party responsible for compliance could void the user's authority to operate the equipment.
- NOTE: This equipment has been tested and found to comply with the limits for a Class B digital device, pursuant to Part 15 of the FCC Rules. These limits are designed to provide reasonable protection against harmful interference in a residential installation.
- This equipment generates uses and can radiate radio frequency energy and, if not installed and used in accordance with the instructions, may cause harmful interference to radio communications. However, there is no guarantee that interference will not occur in a particular installation. If this equipment does cause harmful interference to radio or television reception, which can be determined by turning the equipment off and on, the user is encouraged to try to correct the interference by one or more of the following measures:
- Reorient or relocate the receiving antenna.
 - Increase the separation between the equipment and receiver.
 - Connect the equipment into an outlet on a circuit different from that to which the receiver is connected.
 - Consult the dealer or an experienced radio/TV technician for help.

FCC Radiation Exposure Statement

This equipment complies with FCC radiation exposure limits set forth for an uncontrolled environment. This equipment should be installed and operated with minimum distance 20cm between the radiator & your body.

Technical Specifications

Input	USB-C: USB-PD USB-A: 5V/2A • 5V/3A QC 2.0/3.0
Wireless Output	Max 15W <i>Charge power is variable and depends on power source, phone model, temperature, etc.</i>
Recommended Operating Temperature	-10—40° C <i>Charge performance will drop above -40° C</i>
Power Consumption	8—20 mA (Standby)



SP
CONNECT

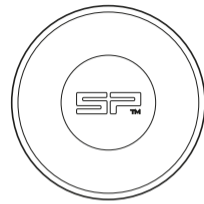

**CHARGING
VENT MOUNT**

EN / DE / FR / ES

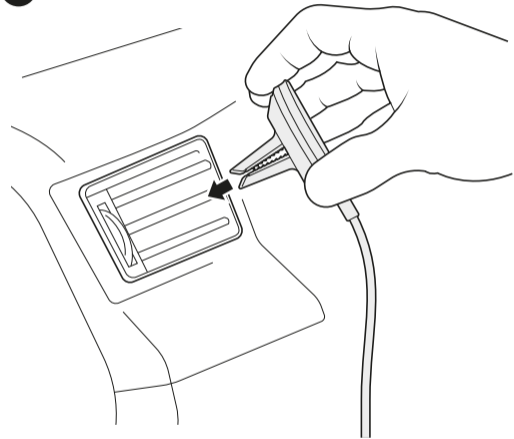
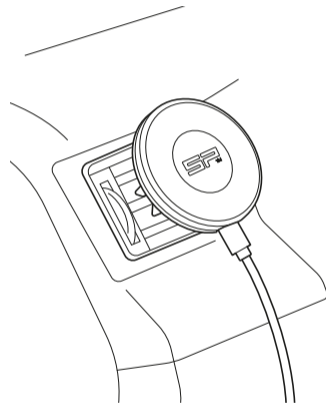
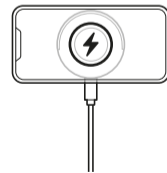
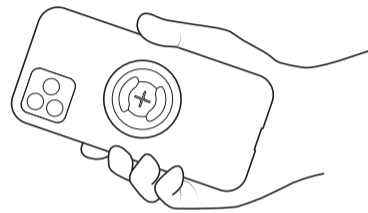
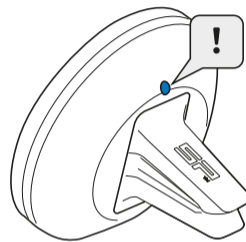
1

USB-C
Power Source
Stromquelle
Source de courant
Fuente de energía

2**3****4****5**

 RED	Ready / Bereit / Prêt / Listo
 BLUE	Charging / Lädt / Chargement / Cargando
 RED FLASH	Error / Fehler / Erreur / Error

EN

ATTENTION!

- Avoid use in a humid or high temperature environment if possible.
- Don't hit, disassemble or re-assemble the product - this may lead to malfunction.
- High Temperatures can reduce charge efficiency.
- Smartphone power consumption can exceed charge power. Setup phone appropriately!

DE

ACHTUNG!

- Einsatz in einer feuchten Umgebung oder bei hohen Temperaturen nach Möglichkeit vermeiden.
- Nicht auf das Produkt einschlagen, zerlegen oder wieder zusammenbauen - dies kann zu Fehlfunktionen führen.
- Hohe Temperaturen können die Ladeleistung verringern.
- Der Stromverbrauch des Smartphones kann die Ladeleistung übersteigen. Telefon entsprechend einstellen!

FR

ATTENTION!

- Si possible, éviter d'utiliser le produit dans un environnement humide ou à des températures élevées.
- Ne pas frapper, démonter ou remonter le produit - cela peut entraîner un dysfonctionnement.
- Des températures élevées peuvent réduire la puissance de charge.
- La consommation d'énergie du smartphone peut dépasser la puissance de charge. Régler le téléphone en conséquence!

ES

¡ATENCIÓN!

- Si es posible, evita utilizarlo en un entorno húmedo o a altas temperaturas.
- No martillees, desmontes o vuelvas a montar el producto, ya que podrías provocar un mal funcionamiento.
- Las altas temperaturas pueden reducir el rendimiento de la carga.
- El consumo de energía del smartphone puede superar la potencia de carga. ¡Ajusta el teléfono en consecuencia!

FCC Statement

1. This device complies with Part 15 of the FCC Rules. Operation is subject to the following two conditions:
(1) This device may not cause harmful interference, and
(2) This device must accept any interference received, including interference that may cause undesired operation.
 2. Changes or modifications not expressly approved by the party responsible for compliance could void the user's authority to operate the equipment.
- NOTE: This equipment has been tested and found to comply with the limits for a Class B digital device, pursuant to Part 15 of the FCC Rules. These limits are designed to provide reasonable protection against harmful interference in a residential installation.
- This equipment generates uses and can radiate radio frequency energy and, if not installed and used in accordance with the instructions, may cause harmful interference to radio communications. However, there is no guarantee that interference will not occur in a particular installation. If this equipment does cause harmful interference to radio or television reception, which can be determined by turning the equipment off and on, the user is encouraged to try to correct the interference by one or more of the following measures:
- Reorient or relocate the receiving antenna.
 - Increase the separation between the equipment and receiver.
 - Connect the equipment into an outlet on a circuit different from that to which the receiver is connected.
 - Consult the dealer or an experienced radio/TV technician for help.

FCC Radiation Exposure Statement

This equipment complies with FCC radiation exposure limits set forth for an uncontrolled environment. This equipment should be installed and operated with minimum distance 20cm between the radiator & your body.

Technical Specifications

Input	USB-C: USB-PD USB-A: 5V/2A • 5V/3A QC 2.0/3.0
Wireless Output	Max 15W <i>Charge power is variable and depends on power source, phone model, temperature, etc.</i>
Recommended Operating Temperature	-10—40° C <i>Charge performance will drop above -40° C</i>
Power Consumption	8—20 mA (Standby)

SP
CONNECT

CHARGING SUCTION MOUNT



EN / DE / FR / ES

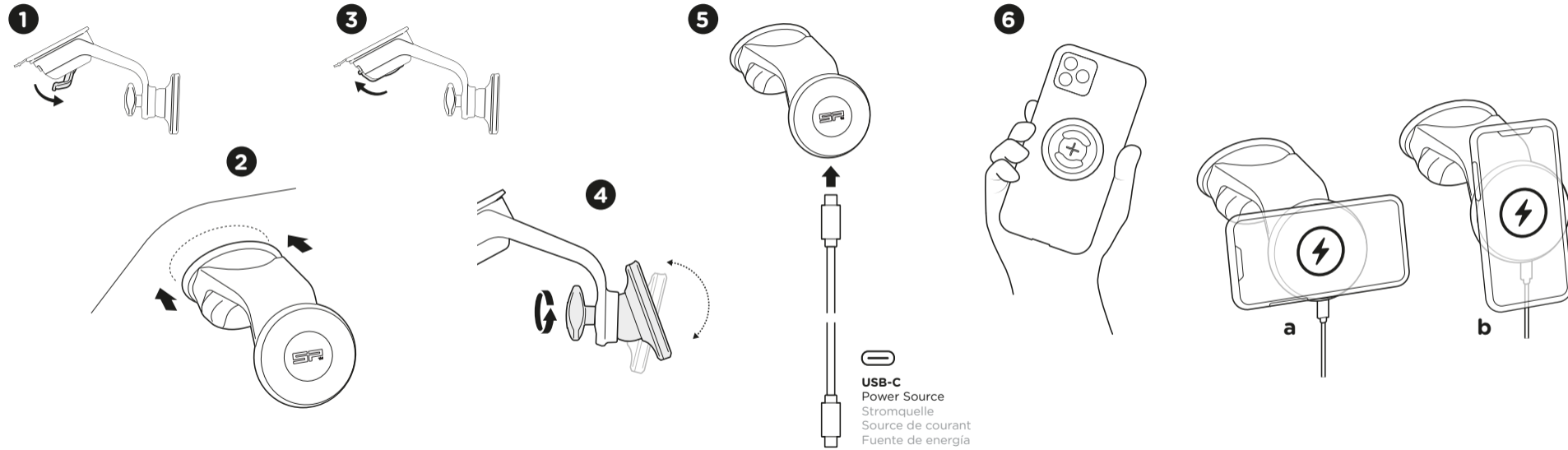

	RED	Ready / Bereit / Prêt / Listo
	BLUE	Charging / Lädt / Chargement / Cargando
	RED FLASH	Error / Fehler / Erreur / Error

EN

ATTENTION!

- Avoid use in a humid or high temperature environment if possible.
- Don't hit, disassemble or re-assemble the product - this may lead to malfunction.
- High Temperatures can reduce charge efficiency.
- Smartphone power consumption can exceed charge power. Setup phone appropriately!

DE

ACHTUNG!

- Einsatz in einer feuchten Umgebung oder bei hohen Temperaturen nach Möglichkeit vermeiden.
- Nicht auf das Produkt einschlagen, zerlegen oder wieder zusammenbauen - dies kann zu Fehlfunktionen führen.
- Hohe Temperaturen können die Ladeleistung verringern.
- Der Stromverbrauch des Smartphones kann die Ladeleistung übersteigen. Telefon entsprechend einstellen!

FR

ATTENTION!

- Si possible, éviter d'utiliser le produit dans un environnement humide ou à des températures élevées.
- Ne pas frapper, démonter ou remonter le produit - cela peut entraîner un dysfonctionnement.
- Des températures élevées peuvent réduire la puissance de charge.
- La consommation d'énergie du smartphone peut dépasser la puissance de charge. Régler le téléphone en conséquence!

ES

¡ATENCIÓN!

- Si es posible, evita utilizarlo en un entorno húmedo o a altas temperaturas.
- No martillees, desmontes o vuelvas a montar el producto, ya que podrías provocar un mal funcionamiento.
- Las altas temperaturas pueden reducir el rendimiento de la carga.
- El consumo de energía del smartphone puede superar la potencia de carga. ¡Ajusta el teléfono en consecuencia!

FCC Statement

1. This device complies with Part 15 of the FCC Rules. Operation is subject to the following two conditions:
(1) This device may not cause harmful interference, and
(2) This device must accept any interference received, including interference that may cause undesired operation.
 2. Changes or modifications not expressly approved by the party responsible for compliance could void the user's authority to operate the equipment.
- NOTE: This equipment has been tested and found to comply with the limits for a Class B digital device, pursuant to Part 15 of the FCC Rules. These limits are designed to provide reasonable protection against harmful interference in a residential installation.
- This equipment generates uses and can radiate radio frequency energy and, if not installed and used in accordance with the instructions, may cause harmful interference to radio communications. However, there is no guarantee that interference will not occur in a particular installation. If this equipment does cause harmful interference to radio or television reception, which can be determined by turning the equipment off and on, the user is encouraged to try to correct the interference by one or more of the following measures:
- Reorient or relocate the receiving antenna.
 - Increase the separation between the equipment and receiver.
 - Connect the equipment into an outlet on a circuit different from that to which the receiver is connected.
 - Consult the dealer or an experienced radio/TV technician for help.

FCC Radiation Exposure Statement

This equipment complies with FCC radiation exposure limits set forth for an uncontrolled environment. This equipment should be installed and operated with minimum distance 20cm between the radiator & your body.

Technical Specifications

Input	USB-C: USB-PD USB-A: 5V/2A • 5V/3A QC 2.0/3.0
Wireless Output	Max 15W <i>Charge power is variable and depends on power source, phone model, temperature, etc.</i>
Recommended Operating Temperature	-10—40° C <i>Charge performance will drop above -40° C</i>
Power Consumption	8—20 mA (Standby)





SPTM
CONNECT

CHARGING OFFICE STAND

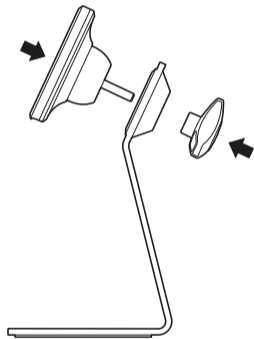
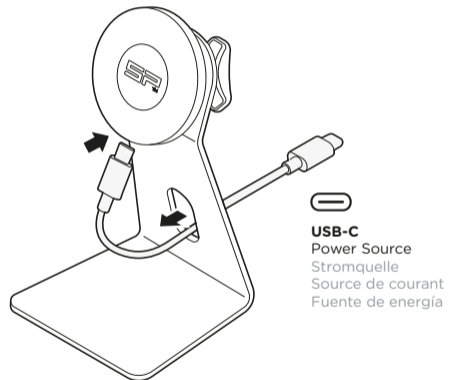
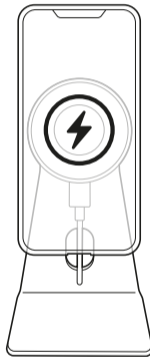
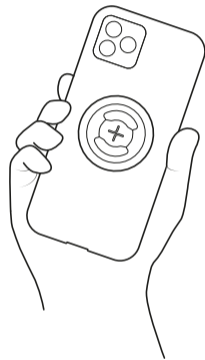
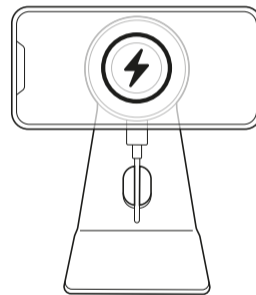
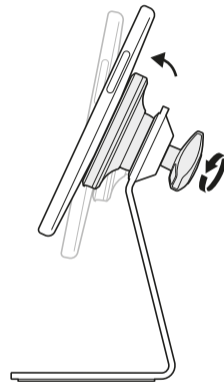

EN / DE / FR / ES

1**2****3****a****b****4****5**

 RED	Ready / Bereit / Prêt / Listo
 BLUE	Charging / Lädt / Chargement / Cargando
 RED FLASH	Error / Fehler / Erreur / Error