

FCC REPORT

(WCDMA)

Applicant: Neusoft Corporation
Address of Applicant: No.2 Xinxu Street, Hunnan New District, Shenyang, Liaoning, China Shenyang Liaoning CN 110179

Equipment Under Test (EUT)

Product Name: Wireless Digital Terminal

Model No.: S611G

Trade mark: Neusoft

FCC ID: 2ASMA-S611G

Applicable standards: FCC CFR Title 47 Part 2
FCC CFR Title 47 Part 22 Subpart H
FCC CFR Title 47 Part 24 Subpart E
FCC CFR Title 47 Part 27 Subpart L

Date of sample receipt: 17 Sep., 2019

Date of Test: 18 Sep., to 15 Oct., 2019

Date of report issued: 13 Nov., 2019

Test Result: PASS*

* In the configuration tested, the EUT complied with the standards specified above.

Authorized Signature:



Bruce Zhang
Laboratory Manager

This report details the results of the testing carried out on one sample. The results contained in this test report do not relate to other samples of the same product and does not permit the use of the CCIS product certification mark. The manufacturer should ensure that all products in series production are in conformity with the product sample detailed in this report.

This report may only be reproduced and distributed in full. If the product in this report is used in any configuration other than that detailed in the report, the manufacturer must ensure the new system complies with all relevant standards.

This document cannot be reproduced except in full, without prior written approval of the Company. Any unauthorized alteration, forgery or falsification of the content or appearance of this document is unlawful and offenders may be prosecuted to the fullest extent of the law. Unless otherwise stated the results shown in this test report refer only to the sample(s) tested and such sample(s) are retained for 90 days only.

2. Version

Version No.	Date	Description
00	16 Oct., 2019	Original
01	13 Nov., 2019	Update page 25

Tested by:

Mike.ou

Date:

13 Nov., 2019

Test Engineer

Reviewed by:

Winner Zhang

Date:

13 Nov., 2019

Project Engineer

3. Contents

	Page
1. COVER PAGE	1
2. VERSION	2
3. CONTENTS	3
4. TEST SUMMARY	4
5. GENERAL INFORMATION	5
5.1 CLIENT INFORMATION.....	5
5.2 GENERAL DESCRIPTION OF E.U.T.....	5
5.3 TEST MODES.....	7
5.4 DESCRIPTION OF SUPPORT UNITS.....	7
5.5 MEASUREMENT UNCERTAINTY.....	7
5.6 ADDITIONS TO, DEVIATIONS, OR EXCLUSIONS FROM THE METHOD.....	7
5.7 LABORATORY FACILITY.....	7
5.8 LABORATORY LOCATION.....	8
5.9 TEST INSTRUMENTS LIST.....	8
6. TEST RESULTS	9
6.1 CONDUCTED OUTPUT POWER, ERP AND EIRP.....	9
6.2 PEAK-TO-AVERAGE POWER RATIO.....	12
6.3 OCCUPY BANDWIDTH.....	14
6.4 MODULATION CHARACTERISTIC.....	19
6.5 OUT OF BAND EMISSION AT ANTENNA TERMINALS.....	19
6.6 FIELD STRENGTH OF SPURIOUS RADIATION MEASUREMENT.....	25
6.7 FREQUENCY STABILITY V.S. TEMPERATURE MEASUREMENT.....	29
6.8 FREQUENCY STABILITY V.S. VOLTAGE MEASUREMENT.....	31
7 TEST SETUP PHOTO	33
8 EUT CONSTRUCTIONAL DETAILS	34

4. Test Summary

Test Item	Section in CFR 47	Result
RF Exposure (SAR)	Part 1.1307 Part 2.1093	Pass (Please refer to SAR Report)
RF Output Power	Part 2.1046 Part 22.913 (a)(5) Part 24.232 (c) Part 27.50 (d)(4)	Pass
Peak-to-Average Power Ratio	Part 24.232 (d) Part 27.50(d)(5)	Pass
Modulation Characteristics	Part 2.1047	Pass
99% & -26 dB Occupied Bandwidth	Part 2.1049 Part 22.917(b) Part 24.238(b) Part 27.53(h)	Pass
Out of band emission at antenna terminals	Part 2.1053 Part 22.917 (a) Part 24.238 (a) Part 27.53 (h)	Pass
Field strength of spurious radiation	Part 22.917 (a) Part 24.238 (a) Part 27.53 (h)	Pass
Frequency stability vs. temperature	Part 22.355 Part 24.235 Part 27.54 Part 2.1055(a)(1)(b)	Pass
Frequency stability vs. voltage	Part 22.355 Part 24.235 Part 27.54 Part 2.1055(d)(2)	Pass
<p>Remark:</p> <ol style="list-style-type: none"> 1. Pass: The EUT complies with the essential requirements in the standard. 2. The cable insertion loss used by "RF Output Power" and other conduction measurement items is 0.5dB (provided by the customer). 		
Test Method:	ANSI/TIA-603-E-2016 ANSI C63.26-2015	

5. General Information

5.1 Client Information

Applicant:	Neusoft Corporation
Address:	No.2 Xinxu Street, Hunnan New District, Shenyang, Liaoning, China Shenyang Liaoning CN 110179
Manufacturer:	Neusoft Corporation
Address:	No.2 Xinxu Street, Hunnan New District, Shenyang, Liaoning, China Shenyang Liaoning CN 110179

5.2 General Description of E.U.T.

Product Name:	Wireless Digital Terminal
Model No.:	S611G
Operation Frequency range:	WCDMA Band V: 826.4MHz-846.6MHz WCDMA Band II: 1852.4 MHz-1907.6 MHz WCDMA Band IV: 1712.4 MHz-1752.6 MHz
Modulation type:	UMTS: QPSK,
Antenna type:	Internal Antenna
Antenna gain:	WCDMA Band V: -0.72 dBi WCDMA Band II: -0.72 dBi WCDMA Band IV: -0.72 dBi
Power supply:	Rechargeable Lithium polymer Battery DC3.85V-4600mAh
AC adapter:	Model: ICP12-050-2000B Input: AC100-240V, 50/60Hz, 0.3A Output: DC 5.0V, 2000mA
Test Sample Condition:	The test samples were provided in good working order with no visible defects.

Operation Frequency List:

WCDMA Band V		WCDMA Band II	
Channel	Frequency (MHz)	Channel	Frequency (MHz)
4132	826.40	9262	1852.40
4133	826.60	9263	1852.60
....
4182	836.40	9399	1879.80
4183	836.60	9400	1880.00
4184	836.80	9401	1880.20
...
4232	846.40	9537	1907.40
4233	846.60	9538	1907.60
WCDMA Band IV			
Channel	Frequency (MHz)		
1312	1712.40		
1313	1712.60		
....		
1412	1732.40		
1413	1732.60		
1414	1732.80		
...	...		
1512	1752.40		
1513	1752.60		

Regards to the operating frequency range over 10 MHz, the Lowest frequency, the middle frequency, and the highest frequency of channel were selected to perform the test, and the selected channel see below:

WCDMA Band V			WCDMA Band II		
Channel	Frequency(MHz)		Channel	Frequency(MHz)	
Lowest	4132	826.40	Lowest	9262	1852.40
Middle	4183	836.60	Middle	9400	1880.00
Highest	4233	846.60	Highest	9538	1907.60
WCDMA Band IV					
Channel	Frequency(MHz)				
Lowest	1312	1712.40			
Middle	1413	1732.60			
Highest	1513	1752.60			

5.3 Test modes

Operating Environment:	
Temperature:	Normal: 15°C ~ 35°C, Extreme: -30°C ~ +50°C
Humidity:	20 % ~ 75 % RH
Atmospheric Pressure:	1008 mbar
Voltage:	Nominal: 3.85Vdc, Extreme: Low 3.5 Vdc, High 4.35 Vdc
Test mode:	
RMC mode	Keep the EUT communication with simulated station in RMC mode
HSDPA	Keep the EUT communication with simulated station in HSDPA mode
HSUPA	Keep the EUT communication with simulated station in HSUPA mode
Remark: The EUT has been tested under continuous transmitting mode. Channel Low, Mid and High for each type band with rated data rate were chosen for full testing. The field strength of spurious radiation emission was measured as EUT stand-up position (H mode) and lie down position (E1, E2 mode) for these modes with power adaptor, earphone and Data cable. Just the worst case position (H mode) shown in report.	

5.4 Description of Support Units

Test Equipment	Manufacturer	Model No.	Serial No.
Simulated Station	Anritsu	MT8820C	6201026545

5.5 Measurement Uncertainty

Parameters	Expanded Uncertainty
Radiated Emission (9kHz ~ 30MHz)	±3.12 dB (k=2)
Radiated Emission (30MHz ~ 1000MHz)	±4.32 dB (k=2)
Radiated Emission (1GHz ~ 18GHz)	±5.38 dB (k=2)
Radiated Emission (18GHz ~ 40GHz)	±3.36 dB (k=2)

5.6 Additions to, deviations, or exclusions from the method

No

5.7 Laboratory Facility

<p>The test facility is recognized, certified, or accredited by the following organizations:</p> <ul style="list-style-type: none"> ● FCC - Designation No.: CN1211 Shenzhen Zhongjian Nanfang Testing Co., Ltd. has been accredited as a testing laboratory by FCC(Federal Communications Commission). The test firm Registration No. is 727551. ● ISED – CAB identifier.: CN0021 The 3m Semi-anechoic chamber of Shenzhen Zhongjian Nanfang Testing Co., Ltd. has been Registered by Certification and Engineering Bureau of Industry Canada for radio equipment testing with Registration No.: 10106A-1. ● CNAS - Registration No.: CNAS L6048 Shenzhen Zhongjian Nanfang Testing Co., Ltd. is accredited to ISO/IEC 17025:2005 General Requirements for the Competence of Testing and Calibration laboratories for the competence of testing. The Registration No. is CNAS L6048. ● A2LA - Registration No.: 4346.01 This laboratory is accredited in accordance with the recognized International Standard ISO/IEC 17025:2005 General requirements for the competence of testing and calibration laboratories. The test scope can be found as below link: https://portal.a2la.org/scopepdf/4346-01.pdf
--

5.8 Laboratory Location

Shenzhen Zhongjian Nanfang Testing Co., Ltd.
 Address: No. B-C, 1/F., Building 2, Laodong No.2 Industrial Park, Xixiang Road,
 Bao'an District, Shenzhen, Guangdong, China
 Tel: +86-755-23118282, Fax: +86-755-23116366
 Email: info@ccis-cb.com, Website: http://www.ccis-cb.com

5.9 Test Instruments list

Test Equipment	Manufacturer	Model No.	Serial No.	Cal. Date (mm-dd-yy)	Cal. Due date (mm-dd-yy)
3m SAC	SAEMC	9m*6m*6m	966	07-22-2017	07-21-2020
BiConiLog Antenna	SCHWARZBECK	VULB9163	497	03-18-2019	03-17-2020
Biconical Antenna	SCHWARZBECK	VUBA9117	359	06-22-2017	06-21-2020
Horn Antenna	SCHWARZBECK	BBHA9120D	916	03-18-2019	03-17-2020
Horn Antenna	SCHWARZBECK	BBHA9120D	1805	06-22-2017	06-21-2020
Horn Antenna	SCHWARZBECK	BBHA 9170	BBHA9170582	11-21-2018	11-20-2019
EMI Test Software	AUDIX	E3	Version: 6.110919b		
Pre-amplifier	HP	8447D	2944A09358	03-18-2019	03-17-2020
Pre-amplifier	CD	PAP-1G18	11804	03-18-2019	03-17-2020
Spectrum analyzer	Rohde & Schwarz	FSP30	101454	03-18-2019	03-17-2020
Spectrum analyzer	Rohde & Schwarz	FSP40	100363	11-21-2018	11-20-2019
EMI Test Receiver	Rohde & Schwarz	ESRP7	101070	03-18-2019	03-17-2020
Spectrum Analyzer	Agilent	N9020A	MY50510123	11-10-2018	11-09-2019
Signal Generator	Rohde & Schwarz	SMX	835454/016	03-18-2019	03-17-2020
Signal Generator	R&S	SMR20	1008100050	03-18-2019	03-17-2020
RF Switch Unit	MWRFTTEST	MW200	N/A	N/A	N/A
Test Software	MWRFTTEST	MTS8200	Version: 2.0.0.0		
Cable	ZDECL	Z108-NJ-NJ-81	1608458	03-18-2019	03-17-2020
Cable	MICRO-COAX	MFR64639	K10742-5	03-18-2019	03-17-2020
Cable	SUHNER	SUCOFLEX100	58193/4PE	03-18-2019	03-17-2020
DC Power Supply	XinNuoEr	WYK-10020K	1409050110020	10-31-2018	10-30-2019
Temperature Humidity Chamber	HengPu	HPGDS-500	20140828008	09-24-2018	09-23-2019
				09-24-2019	09-23-2020
Simulated Station	Rohde & Schwarz	CMW500	140493	07-16-2018	07-15-2019
				07-16-2019	07-15-2020

6. Test results

6.1 Conducted Output Power, ERP and EIRP

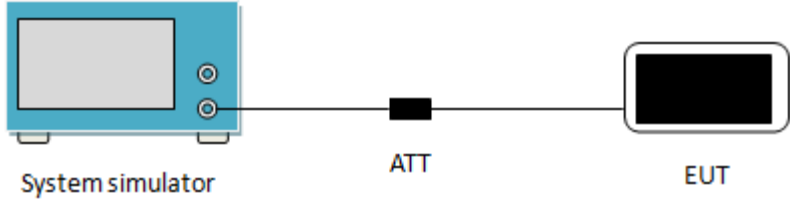
Test Requirement:	FCC part 22.913(a)(5), FCC part 24.232(c), FCC part 27.50(d)(4)
Limit:	WCDMA Band V: 7W, WCDMA Band II: 2W, WCDMA Band IV: 1W
Test setup:	 <p>The diagram illustrates the test setup. On the left is a blue 'System simulator' with a screen and two knobs. A line connects it to a black 'ATT' (attenuator) block. Another line connects the 'ATT' to a black 'EUT' (Equipment Under Test) device.</p>
Test Procedure:	The transmitter output was connected to a calibrated attenuator, the other end of which was connected to the simulated station. Transmitter output power was read off in dBm.
Test Instruments:	Refer to section 5.9 for details
Test mode:	Refer to section 5.3 for details
Test results:	Passed

Measurement Data:

EUT Mode		Burst Average power (dBm)		
		4132	4183	4233
		826.40 (MHz)	836.60 (MHz)	846.60 (MHz)
UMTS 850 HSDPA	Subtest 1	22.74	22.75	22.76
	Subtest 2	22.45	22.54	22.58
	Subtest 3	21.08	21.13	21.25
	Subtest 4	20.96	21.00	21.02
UMTS 850 HSUPA	Subtest 1	22.06	22.10	22.09
	Subtest 2	22.56	22.66	22.68
	Subtest 3	21.58	21.63	21.70
	Subtest 4	22.68	22.71	22.74
	Subtest 5	21.82	21.92	21.87
UMTS 850 RMC	12.2kbps	23.79	23.81	23.86
UMTS 850 AMR	12.2kbps	23.77	23.75	23.73
Antenna Gain (dBi)		-0.72		
Max. ERP (dBm)		20.99		
ERP Limit (dBm)		38.45		
EUT Mode		Burst Average power (dBm)		
		9262	9400	9538
		1852.40 (MHz)	1880.00 (MHz)	1907.60 (MHz)
UMTS 1900 HSDPA	Subtest 1	22.86	22.62	22.68
	Subtest 2	22.64	22.41	22.51
	Subtest 3	21.14	21.06	21.09
	Subtest 4	20.93	20.88	20.99
UMTS 1900 HSUPA	Subtest 1	22.08	22.00	22.01
	Subtest 2	22.72	22.56	22.58
	Subtest 3	21.66	21.53	21.52
	Subtest 4	22.82	22.63	22.64
	Subtest 5	21.99	21.80	21.72
UMTS 1900 RMC	12.2kbps	23.73	23.70	23.64
UMTS 1900 AMR	12.2kbps	23.70	23.66	23.62
Antenna Gain (dBi)		-0.72		
Max. EIRP (dBm)		23.01		
EIRP Limit (dBm)		33.00		
<p>Note: EIRP (dBm) = Burst Average power (dBm) + Antenna Gain (dBi). ERP (dBm) = EIRP (dBm) - 2.15 (dB).</p>				

EUT Mode		Burst Average power (dBm)		
		1312	1412	1513
		1712.40 (MHz)	1732.40 (MHz)	1752.60 (MHz)
UMTS 1700 HSDPA	Subtest 1	22.30	22.63	22.80
	Subtest 2	22.08	22.41	22.60
	Subtest 3	20.59	20.99	21.16
	Subtest 4	20.53	20.83	21.00
UMTS 1700 HSUPA	Subtest 1	21.52	21.89	21.99
	Subtest 2	22.17	22.52	22.69
	Subtest 3	21.20	21.48	21.62
	Subtest 4	22.23	22.58	22.17
	Subtest 5	21.42	21.70	21.82
UMTS 1700 RMC	12.2kbps	23.20	23.60	23.75
UMTS 1700 AMR	12.2kbps	23.14	23.57	23.72
Antenna Gain (dBi)		-0.72		
Max. EIRP (dBm)		23.03		
EIRP Limit (dBm)		30.00		

Note: EIRP (dBm) = Burst Average power (dBm) + Antenna Gain (dBi).

6.2 Peak-to-Average Power Ratio

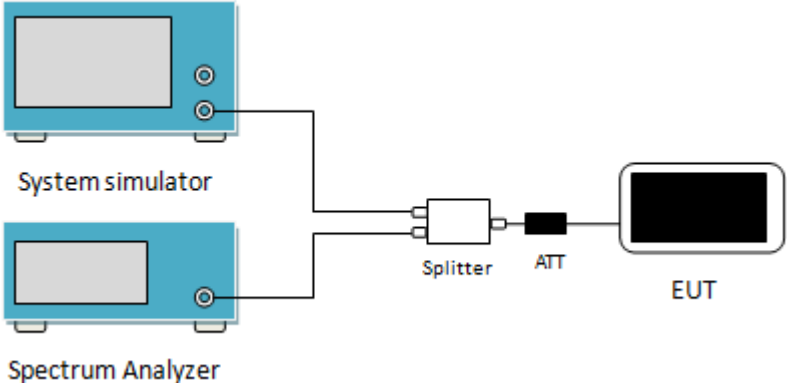
Test Requirement:	FCC part 24.232(d), FCC part 27.50(d)(5)
Limit:	The peak-to-average ratio (PAR) of the transmission may not exceed 13 dB.
Test setup:	 <p>The diagram shows a test setup. On the left, there are two blue rectangular units: the top one is labeled 'System simulator' and the bottom one is labeled 'Spectrum Analyzer'. Both have ports on their right side. These two units are connected to a central white rectangular unit labeled 'Splitter'. From the right side of the 'Splitter', a line goes to a black rectangular unit labeled 'ATT' (attenuator). From the right side of the 'ATT', a line goes to a white rectangular unit with a black screen labeled 'EUT' (Equipment Under Test).</p>
Test Procedure:	<ol style="list-style-type: none"> 1 The RF output of the transceiver was connected to a spectrum analyzer through appropriate attenuation. 2 Set the CCDF option in spectrum analyzer, $RBW \geq OBW$, 3 Set the EUT working in highest power level, measured and recorded the 0.1% as PAPR level. 4 Repeat step 1~3 at other frequency and modulations.
Test Instruments:	Refer to section 5.9 for details
Test mode:	Refer to section 5.3 for details
Test results:	Passed

Measurement Data:

Modulation	Test channel	PAPR
UMTS 850 RMC	4183	3.08
UMTS 1900 RMC	9400	3.20
UMTS1700 RMC	1413	3.04

Test plots as below:

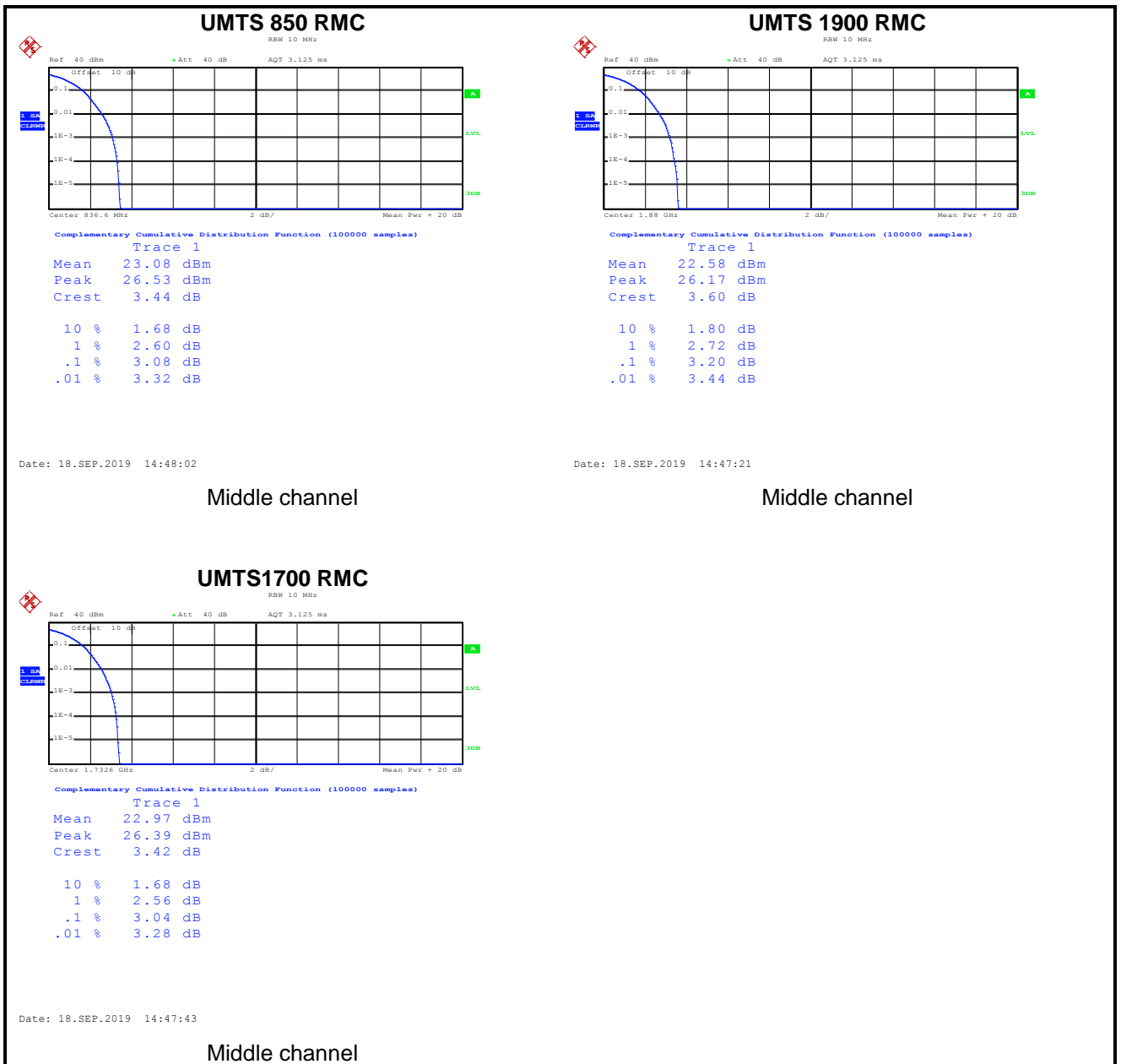

6.3 Occupy Bandwidth

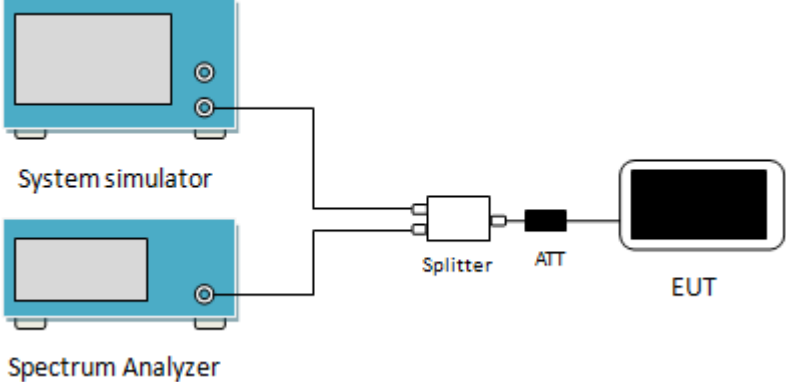
Test Requirement:	FCC part 22.917(b), FCC part 24.238(b), FCC Part 27.53(h)
Test setup:	 <p>The diagram shows a test setup for measuring occupied bandwidth. On the left, there are two blue rectangular units: the top one is labeled 'System simulator' and the bottom one is labeled 'Spectrum Analyzer'. Both have a screen and two circular ports on the right side. A single cable connects the top port of the System simulator to the top port of the Spectrum Analyzer. A second cable connects the bottom port of the System simulator to the top port of a white rectangular 'Splitter'. The bottom port of the Splitter is connected to a black rectangular 'ATT' (Attenuator). The right side of the ATT is connected to the left side of a black rectangular 'EUT' (Equipment Under Test).</p>
Test Procedure:	<ol style="list-style-type: none"> 1. The EUT's output RF connector was connected with a short cable to the spectrum analyzer 2. RBW was set to about 1% of emission BW, VBW= 3 times RBW. 3. -26dBc display line was placed on the screen (or 99% bandwidth), the occupied bandwidth is the delta frequency between the two points where the display line intersects the signal trace.
Test Instruments:	Refer to section 5.9 for details
Test mode:	Refer to section 5.3 for details
Test results:	Passed

Measurement Data:

EUT Mode	Channel	Frequency (MHz)	99% Occupy bandwidth (kHz)	-26dB bandwidth (kHz)
UMTS 850 12.2k RMC	4132	826.4	4180	4740
	4183	836.6	4120	4720
	4233	846.6	4140	4720
UMTS 1900 12.2k RMC	9262	1852.4	4160	4720
	9400	1880.0	4140	4700
	9538	1907.6	4140	4760
UMTS 1700 12.2k RMC	1312	1712.40	4140	4720
	1413	1732.60	4140	4700
	1513	1752.60	4140	4740

Test plot as follows:

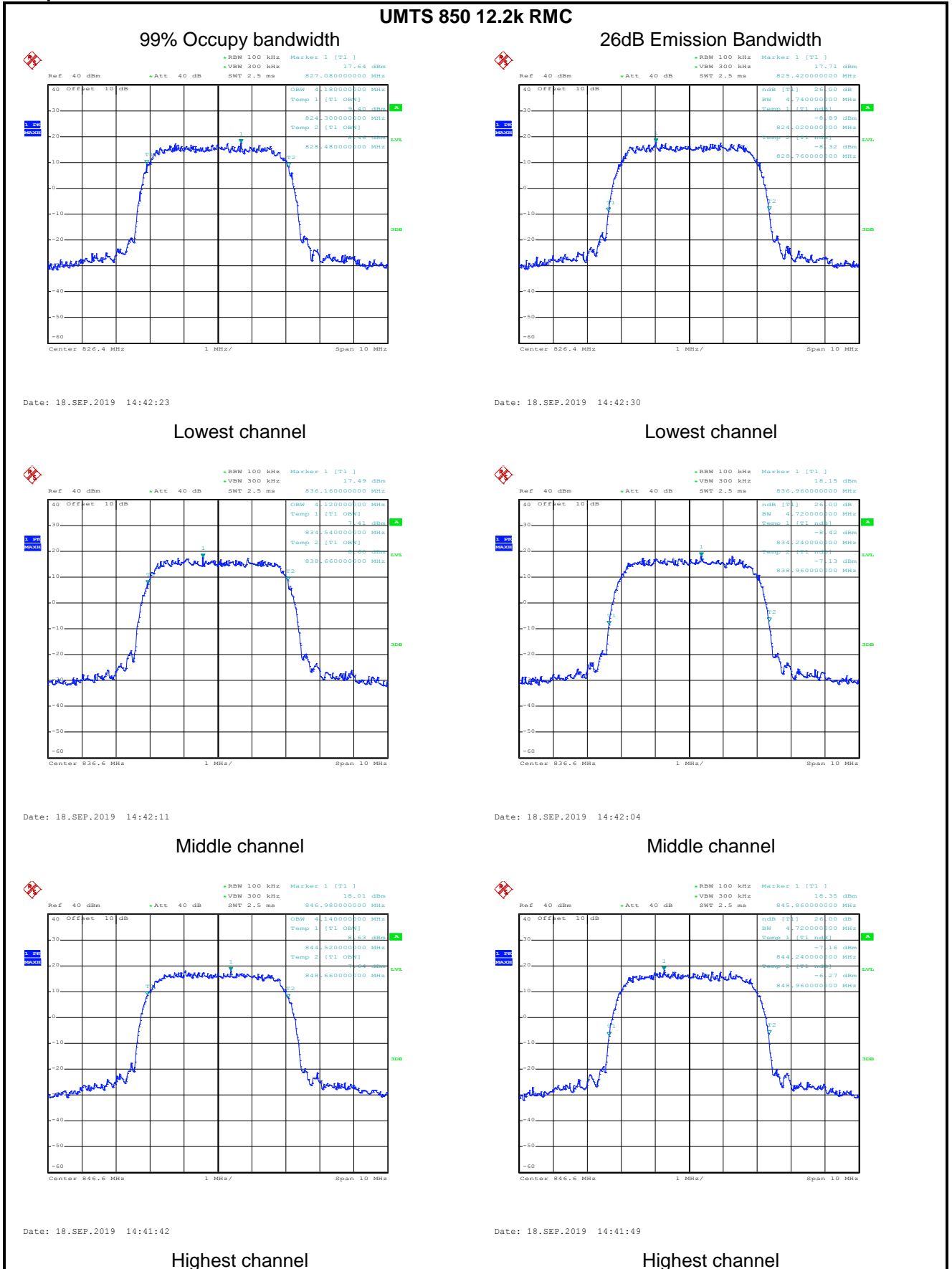

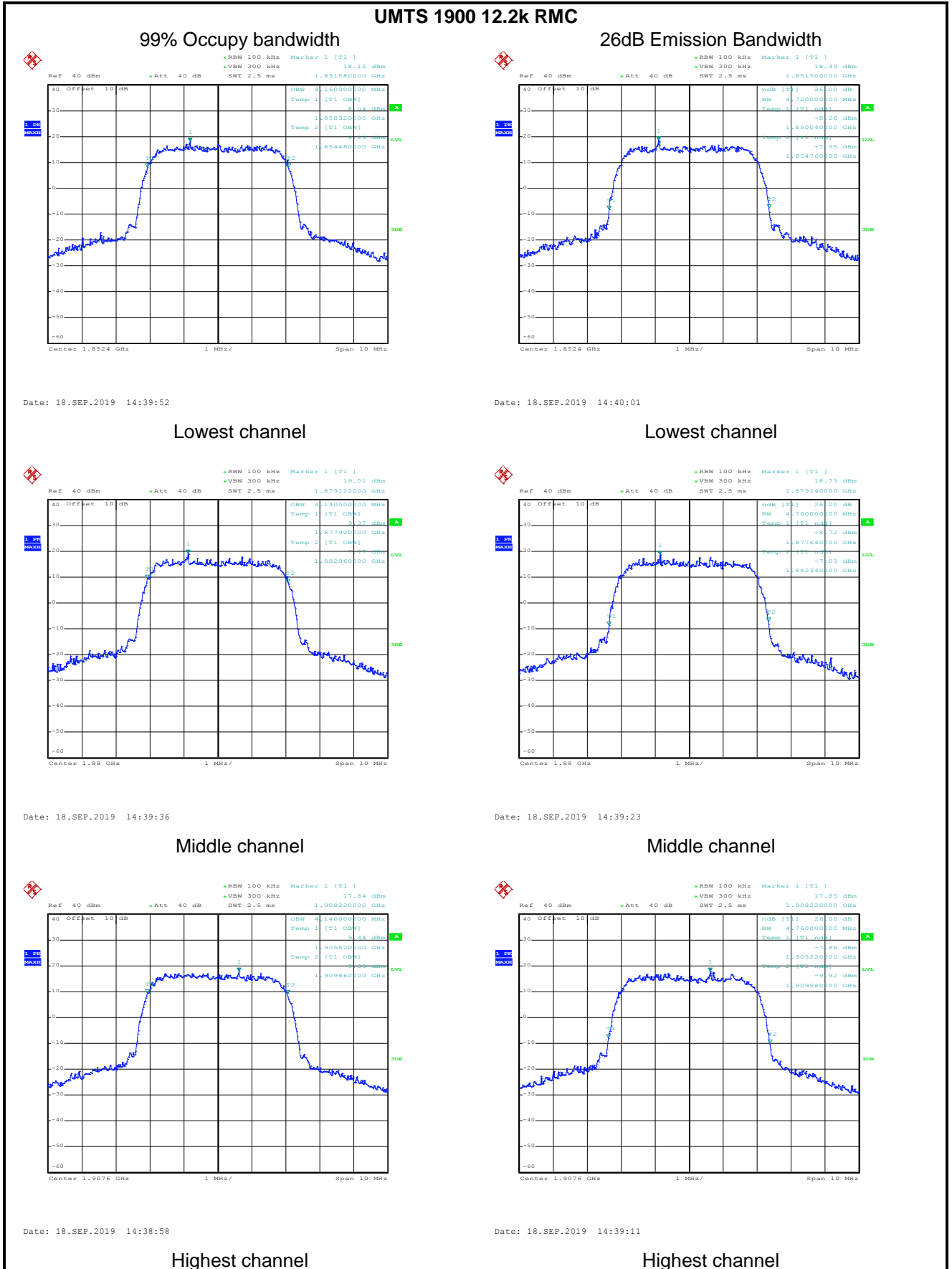

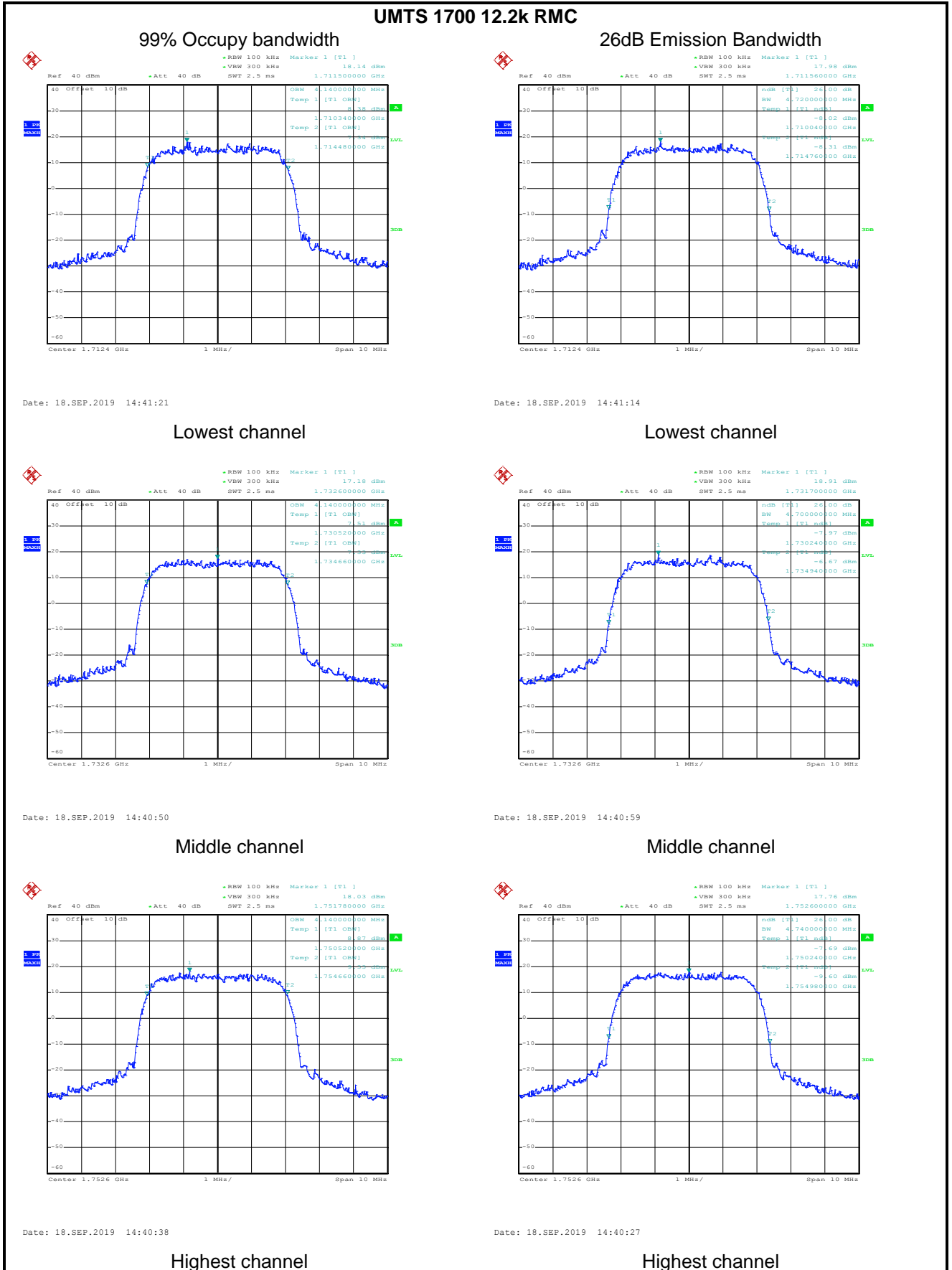

6.4 Modulation Characteristic

According to FCC § 2.1047(d), Part 22H & 24E & 27L there is no specific requirement for digital modulation, therefore modulation characteristic is not presented.

6.5 Out of band emission at antenna terminals

Test Requirement:	FCC part 22.917(a), FCC part 24.238(a), FCC Part 27.53 (h)
Limit:	-13dBm
Test setup:	
Test Procedure:	<ol style="list-style-type: none"> 1 The RF output of the transceiver was connected to a spectrum analyzer through appropriate attenuation. 2 For the out of band: For W850 set the RBW=100 kHz, VBW=300 kHz when below 1 GHz, For W1700 and W1900 set the RBW=1 MHz, VBW=3 MHz when below 1 GHz RBW =1 MHz, VBW=3 MHz when above 1 GHz, Start=30MHz, Stop= 10th harmonic. 3 Band Edge Requirements: In the 1 MHz bands immediately outside and adjacent to the frequency block, a resolution bandwidth of at least 1 percent of the emission bandwidth of the fundamental emission of the transmitter may be employed to measure the out of band Emissions.
Test Instruments:	Refer to section 5.9 for details
Test mode:	Refer to section 5.3 for details
Test results:	Passed

Test plots as follows (Spurious emission):

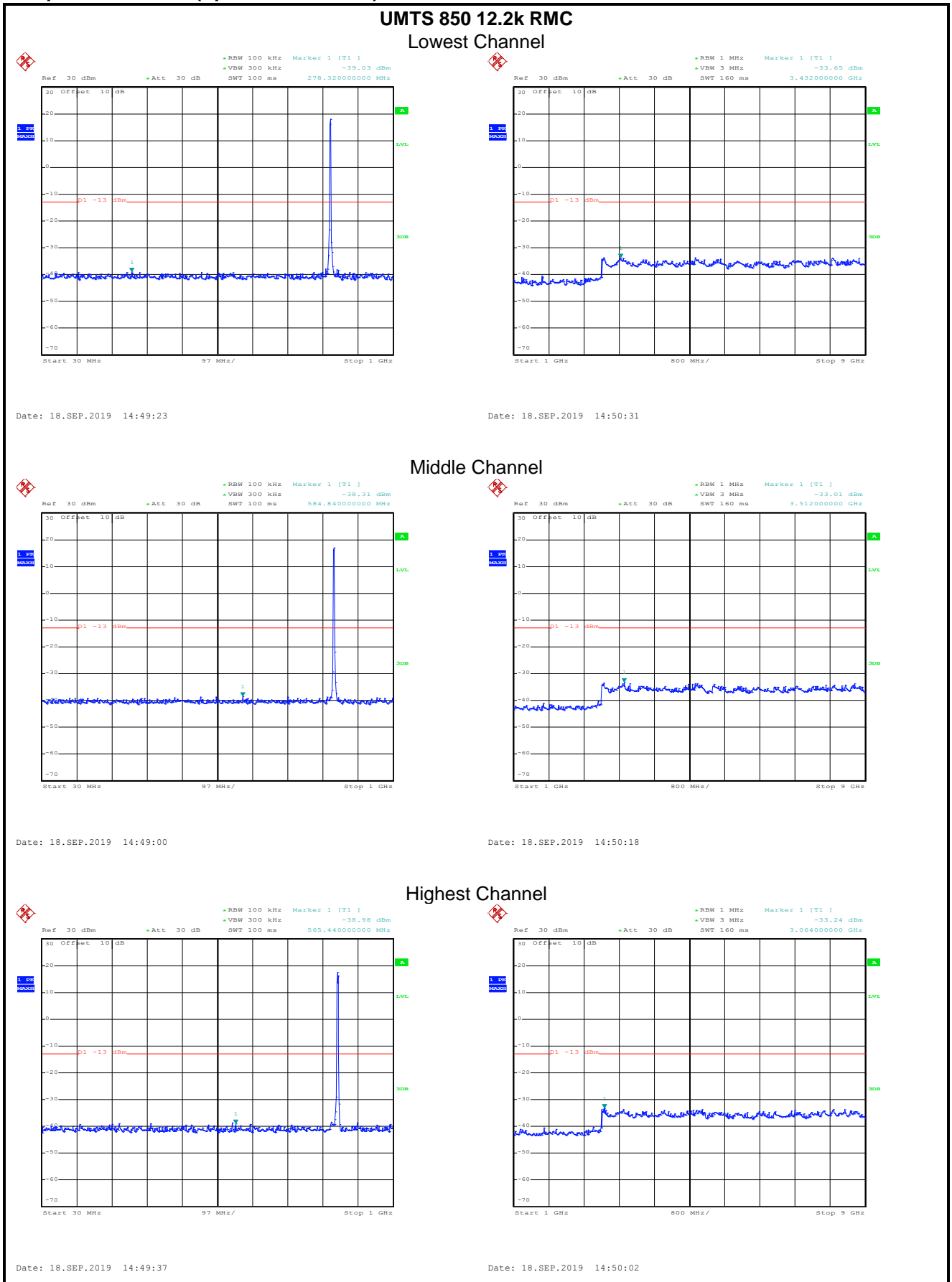

UMTS 1900 12.2k RMC Lowest Channel

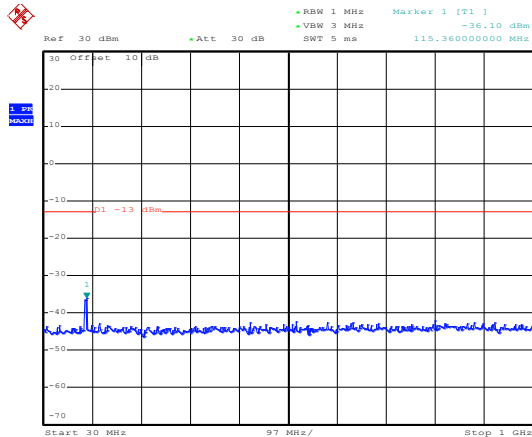

Date: 18.SEP.2019 14:53:21

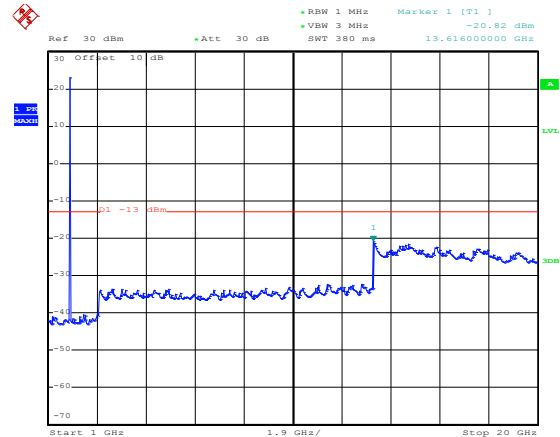

Date: 18.SEP.2019 14:55:04

Middle Channel

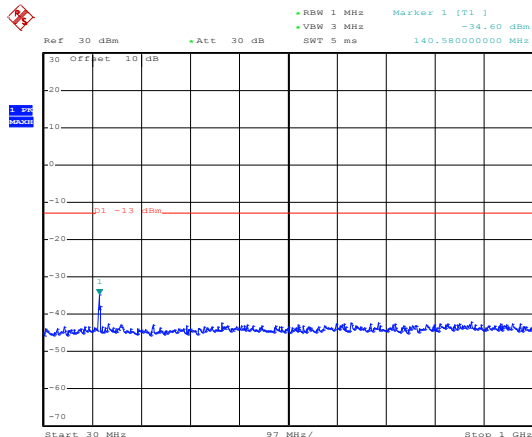

Date: 18.SEP.2019 14:53:07

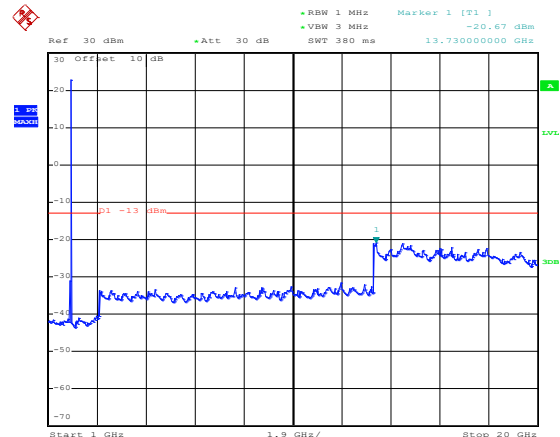

Date: 18.SEP.2019 14:54:37

Highest Channel

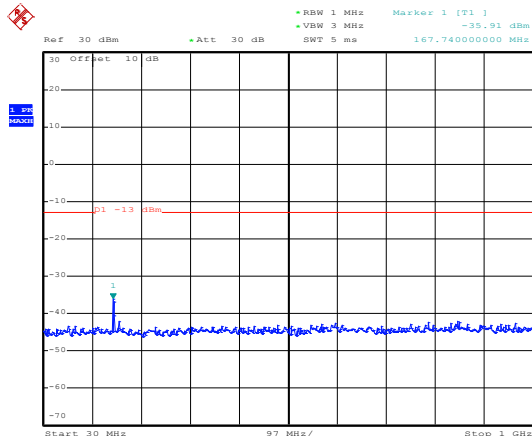

Date: 18.SEP.2019 14:53:34

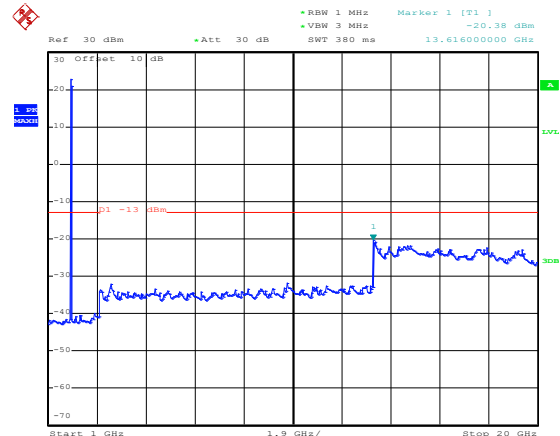

Date: 18.SEP.2019 14:54:08

UMTS 1700 12.2k RMC Lowest Channel

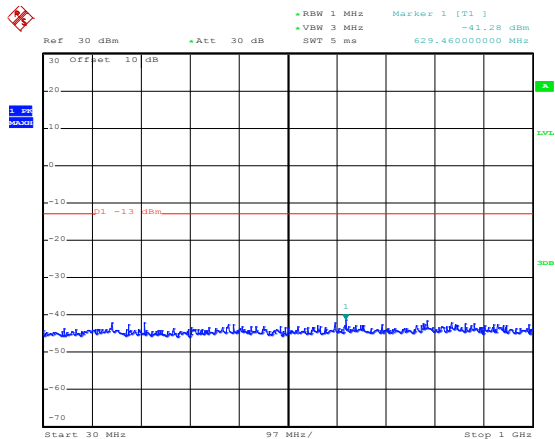

Date: 18.SEP.2019 14:52:43

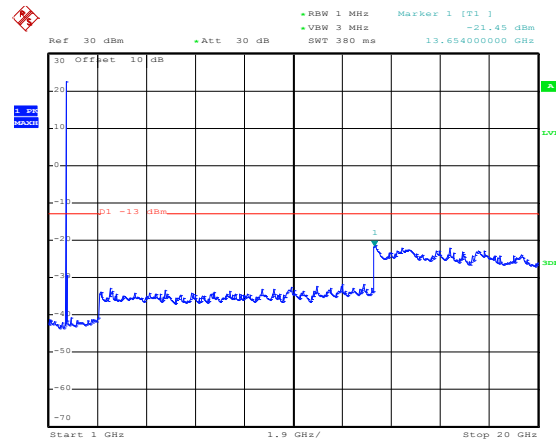

Date: 18.SEP.2019 14:51:27

Middle Channel

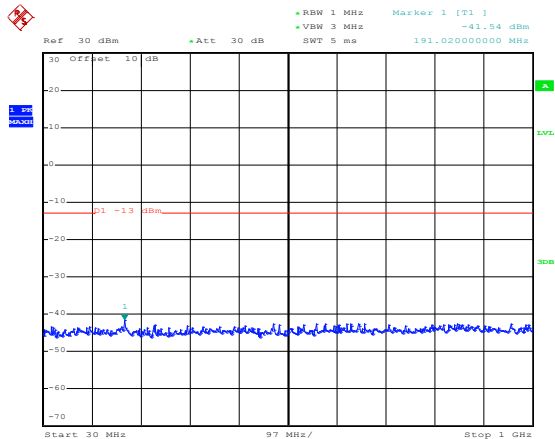

Date: 18.SEP.2019 14:52:30

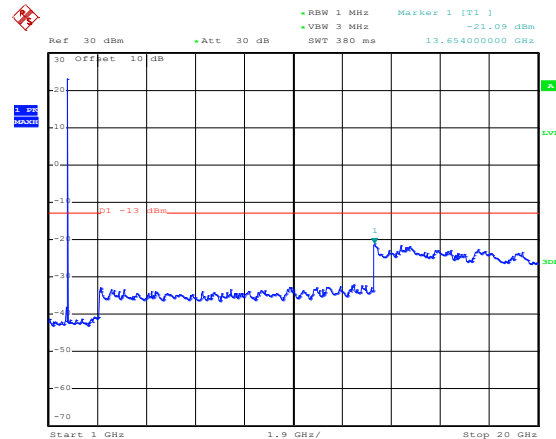

Date: 18.SEP.2019 14:51:08

Highest Channel

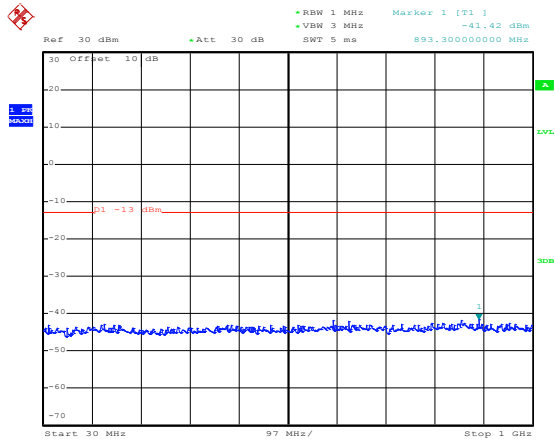

Date: 18.SEP.2019 14:52:16

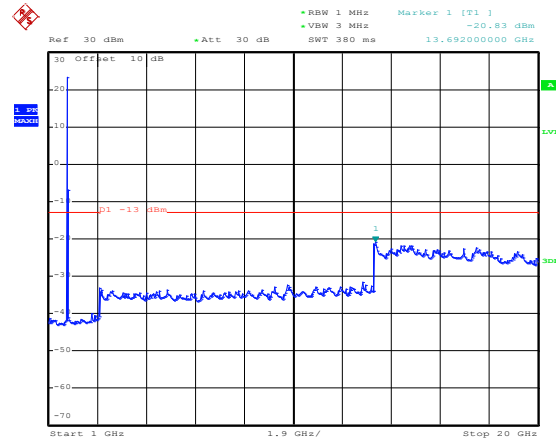

Date: 18.SEP.2019 14:51:56

Band edge emission:

UMTS 850 RMC 12.2kbps

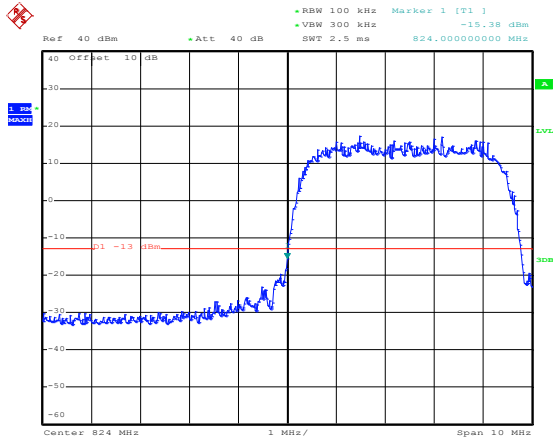

Date: 18.SEP.2019 14:43:19

Lowest channel

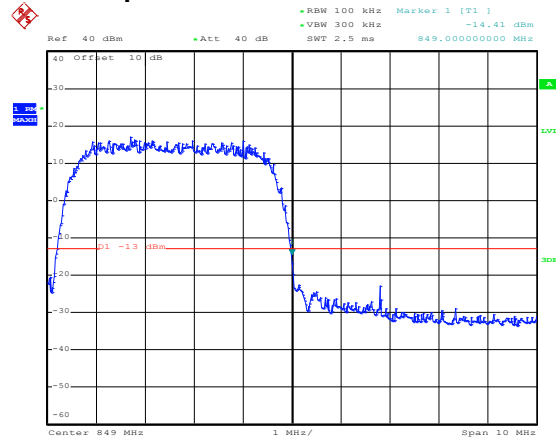

Date: 18.SEP.2019 14:44:17

Highest channel

UMTS 1900 RMC 12.2kbps

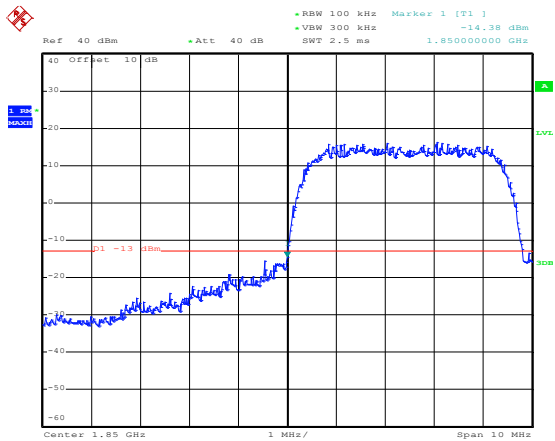

Date: 18.SEP.2019 14:46:24

Lowest channel

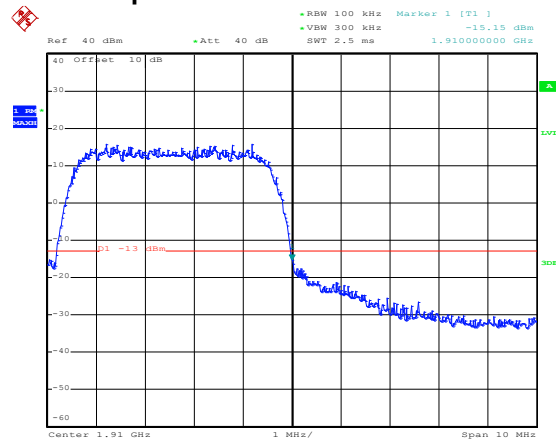

Date: 18.SEP.2019 14:46:51

Highest channel

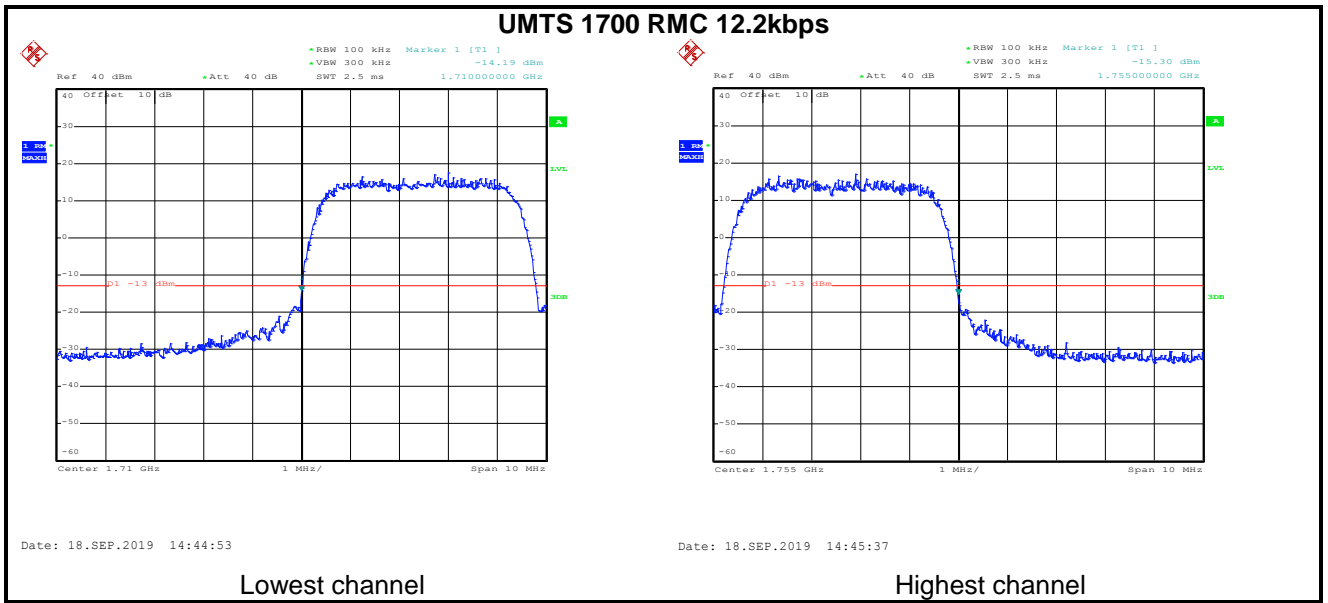

6.6 Field strength of spurious radiation measurement

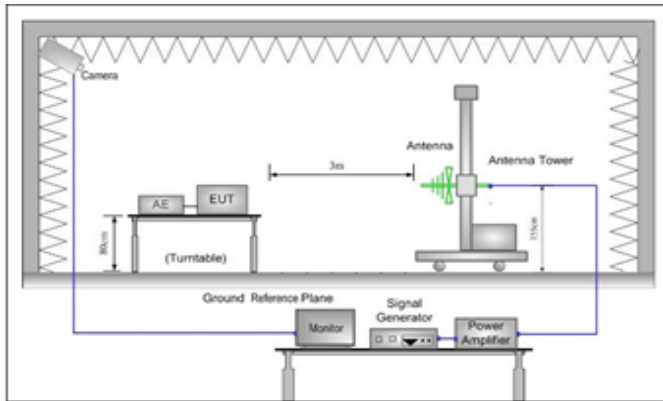
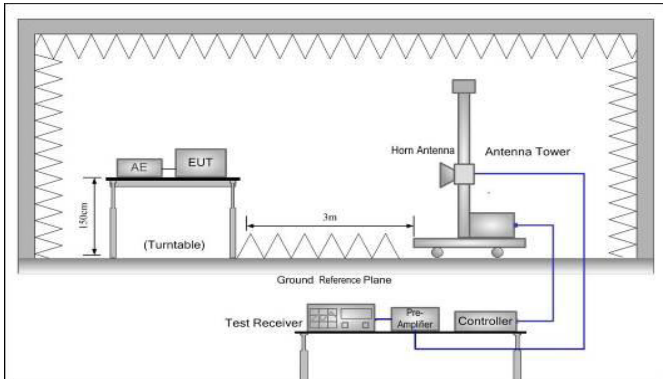
Test Requirement:	FCC part 22.917(a), FCC part 24.238(a), FCC part 27.53(h)
Limit:	-13dBm
Test setup:	<p>Below 1GHz</p>  <p>Above 1GHz</p> 
Test Procedure:	<ol style="list-style-type: none"> 1. The EUT was placed on an non-conductive turntable using a non-conductive support. The radiated emission at the fundamental frequency was measured at 3 m with a test antenna and EMI spectrum analyzer. 2. During the tests, the antenna height and the EUT azimuth were varied in order to identify the maximum level of emissions from the EUT. This maximization process was repeated with the EUT positioned in each of its three orthogonal orientations. 3. The frequency range up to tenth harmonic was investigated for each of three fundamental frequency (low, middle and high channels). Once spurious emission was identified, the power of the emission was determined using the substitution method. 4. The spurious emissions attenuation was calculated as the difference between radiated power at the fundamental frequency and the spurious emissions frequency. $\text{ERP / EIRP} = \text{S.G. output (dBm)} + \text{Antenna Gain(dB/dBi)} - \text{Cable Loss (dB)}$
Test Instruments:	Refer to section 5.9 for details
Test mode:	Refer to section 5.3 for details.
Test results:	Passed

Measurement Data (worst case):

WCDMA BAND V 12.2k RMC				
Lowest channel				
Frequency (MHz)	Spurious Emission		Limit (dBm)	Result
	Polarization	Level (dBm)		
1652.80	Vertical	-58.24	-13.00	Pass
2479.20	V	-52.97		
3305.60	V	-48.69		
1652.80	Horizontal	-58.69	-13.00	Pass
2479.20	H	-53.72		
3305.60	H	-49.57		
Middle channel				
Frequency (MHz)	Spurious Emission		Limit (dBm)	Result
	Polarization	Level (dBm)		
1673.20	Vertical	-58.31	-13.00	Pass
2509.80	V	-52.89		
3346.40	V	-48.72		
1673.20	Horizontal	-58.64	-13.00	Pass
2509.80	H	-53.75		
3346.40	H	-49.38		
Highest channel				
Frequency (MHz)	Spurious Emission		Limit (dBm)	Result
	Polarization	Level (dBm)		
1693.20	Vertical	-58.41	-13.00	Pass
2539.80	V	-52.94		
3386.40	V	-48.76		
1693.20	Horizontal	-58.61	-13.00	Pass
2539.80	H	-53.85		
3386.40	H	-49.47		
<i>Remark:</i>				
1. The emission levels of below 1 GHz are very lower than the limit and not show in test report.				

WCDMA Band II 12.2k RMC				
Lowest channel				
Frequency (MHz)	Spurious Emission		Limit (dBm)	Result
	Polarization	Level (dBm)		
3704.80	Vertical	-48.74	-13.00	Pass
5557.20	V	-43.93		
3704.80	Horizontal	-47.28	-13.00	Pass
5557.20	H	-43.19		
Middle channel				
Frequency (MHz)	Spurious Emission		Limit (dBm)	Result
	Polarization	Level (dBm)		
3760.00	Vertical	-48.59	-13.00	Pass
5640.00	V	-43.94		
3760.00	Horizontal	-47.37	-13.00	Pass
5640.00	H	-43.26		
Highest channel				
Frequency (MHz)	Spurious Emission		Limit (dBm)	Result
	Polarization	Level (dBm)		
3815.20	Vertical	-48.76	-13.00	Pass
5722.80	V	-43.89		
3815.20	Horizontal	-47.51	-13.00	Pass
5722.80	H	-43.24		
<i>Remark:</i>				
1. The emission levels of below 1 GHz are very lower than the limit and not show in test report.				

WCDMA Band IV 12.2k RMC				
Lowest channel				
Frequency (MHz)	Spurious Emission		Limit (dBm)	Result
	Polarization	Level (dBm)		
3424.40	Vertical	-39.55	-13.00	Pass
5136.60	V	-44.20		
3424.40	Horizontal	-36.88	-13.00	Pass
5136.60	H	-44.58		
Middle channel				
Frequency (MHz)	Spurious Emission		Limit (dBm)	Result
	Polarization	Level (dBm)		
3464.80	Vertical	-49.24	-13.00	Pass
5197.20	V	-43.89		
3464.80	Horizontal	-47.53	-13.00	Pass
5197.20	H	-43.76		
Highest channel				
Frequency (MHz)	Spurious Emission		Limit (dBm)	Result
	Polarization	Level (dBm)		
3505.20	Vertical	-48.89	-13.00	Pass
5257.80	V	-43.46		
3505.20	Horizontal	-47.59	-13.00	Pass
5257.80	H	-43.62		
<i>Remark:</i>				
1. The emission levels of below 1 GHz are very lower than the limit and not show in test report.				

6.7 Frequency stability V.S. Temperature measurement

Test Requirement:	FCC Part 22.355, FCC Part 24.235, FCC Part 27.54, FCC Part 2.1055(a)(1)(b)
Limit:	±2.5 ppm for WCDMA 850 Within authorized band for WCDMA 1700 and WCDMA 1900
Test setup:	
Test procedure:	<ol style="list-style-type: none"> 1. The equipment under test was connected to an external DC power supply and input rated voltage. 2. RF output was connected to a frequency counter or spectrum analyzer via feed through attenuators. 3. The EUT was placed inside the temperature chamber. 4. Set the spectrum analyzer RBW low enough to obtain the desired frequency resolution and measure EUT 25°C operating frequency as reference frequency. 5. Turn EUT off and set the chamber temperature to -30°C. After the temperature stabilized for approximately 30 minutes recorded the frequency. 6. Repeat step measure with 10°C increased per stage until the highest temperature of +50°C reached
Test Instruments:	Refer to section 5.9 for details
Test mode:	Refer to section 5.3 for details
Test results:	Passed

Measurement Data (the worst channel):

Reference Frequency: WCDMA BAND V 12.2k RMC Middle channel=4183 channel=836.6MHz					
Power supplied (Vdc)	Temperature (°C)	Frequency error		Limit (ppm)	Result
		Hz	ppm		
3.85	-30	178	0.212766	±2.5	Pass
	-20	156	0.186469		
	-10	134	0.160172		
	0	129	0.154196		
	10	127	0.151805		
	20	146	0.174516		
	30	102	0.121922		
	40	144	0.172125		
	50	156	0.186469		
Reference Frequency: WCDMA BAND II 12.2k RMC Middle channel=9400 channel=1880MHz					
Power supplied (Vdc)	Temperature (°C)	Frequency error		Limit (ppm)	Result
		Hz	ppm		
3.85	-30	196	0.104255	Within authorized band for WCDMA 1900	Pass
	-20	132	0.070213		
	-10	147	0.078191		
	0	158	0.084043		
	10	144	0.076596		
	20	127	0.067553		
	30	107	0.056915		
	40	138	0.073404		
	50	166	0.088298		
Reference Frequency: UMTS1700 12.2k RMC Middle channel=1413 channel=1732.6MHz					
Power supplied (Vdc)	Temperature (°C)	Frequency error		Limit (ppm)	Result
		Hz	ppm		
3.85	-30	175	0.101004	Within authorized band for WCDMA 1900	Pass
	-20	136	0.078495		
	-10	152	0.087729		
	0	147	0.084844		
	10	158	0.091192		
	20	123	0.070992		
	30	168	0.096964		
	40	129	0.074455		
	50	104	0.060025		

Note: Only the worst case shown in the report.

6.8 Frequency stability V.S. Voltage measurement

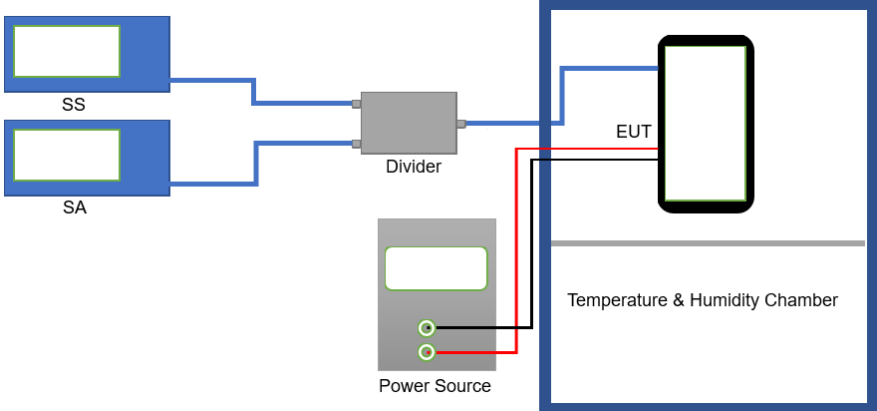
Test Requirement:	FCC Part 22.355, FCC Part 24.235, FCC Part 27.54, FCC Part 2.1055(d)(2)
Limit:	±2.5 ppm for WCDMA 850 Within authorized band for WCDMA 1700 and WCDMA 1900
Test setup:	 <p>The diagram illustrates the test setup. On the left, a Spectrum Analyzer (SA) and a Signal Source (SS) are connected to a Divider. The Divider is connected to an Equipment Under Test (EUT) inside a Temperature & Humidity Chamber. A Power Source is also connected to the EUT.</p>
Test procedure:	<ol style="list-style-type: none"> 1. Set chamber temperature to 25°C. Use a variable DC power source to power the EUT and set the voltage to rated voltage. 2. Set the spectrum analyzer RBW low enough to obtain the desired frequency resolution and recorded the frequency. 3. Reduce the input voltage to specify extreme voltage variation (+/- 15%) and endpoint, record the maximum frequency change.
Test Instruments:	Refer to section 5.9 for details
Test mode:	Refer to section 5.3 for details
Test results:	Passed

Measurement Data (the worst channel):

Reference Frequency: UMTS 850 12.2k RMC Middle channel=4183 channel=836.6MHz					
Temperature (°C)	Power supplied (Vdc)	Frequency error		Limit (ppm)	Result
		Hz	ppm		
25	4.35	78	0.093235	±2.5	Pass
	3.85	63	0.075305		
	3.50	54	0.064547		
Reference Frequency: UMTS 1900 12.2k RMC Middle channel=9400 channel=1880MHz					
Temperature (°C)	Power supplied (Vdc)	Frequency error		Limit (ppm)	Result
		Hz	ppm		
25	4.35	99	0.052660	Within authorized band for WCDMA 1900	Pass
	3.85	35	0.018617		
	3.50	47	0.025000		
Reference Frequency: UMTS1700 12.2k RMC Middle channel=1413 channel=1732.6MHz					
Temperature (°C)	Power supplied (Vdc)	Frequency error		Limit (ppm)	Result
		Hz	ppm		
25	4.35	88	0.050791	Within authorized band for WCDMA 1700	Pass
	3.85	47	0.027127		
	3.50	32	0.018469		
<i>Note: Only the worst case shown in the report.</i>					