

S.M.S.L

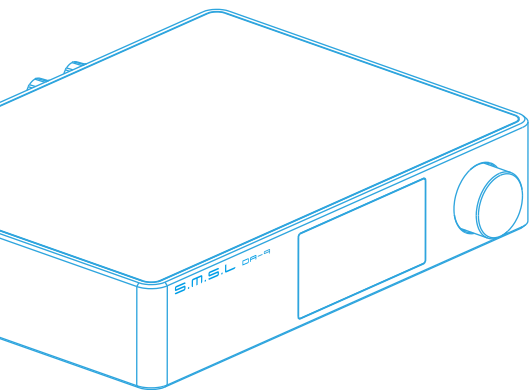

DA-9

USER MANUAL



Safety Notes

- Install this unit in a well ventilated, cool, dry, clean place-away from direct sunlight, heat sources, vibration, dust, moisture, or cold..
- Use the voltage specified on this unit Only. Using this unit with a higher voltage than specified is dangerous and may cause fire , damage to this unit, or personal injury. Our company will not be held responsible for any damage resulting from the use of this unit with a voltage other than that specified.
- Do not attempt to modify or fix this unit by yourself. Contact alesperson or customer service when any service is needed. The cabinet should never be opened for any reason.
- When not planning to use this unit for long periods of time (i.e. when going on vacation), disconnect the power cable from the AC wall outlet.

Important note:

The product specifications and information mentioned in this manual are for reference only. The content of this manual is subject to change without notice.

Warranty Terms

1.The Term of Service

Foshan Shuangmusanlin Technology Co., Ltd promises to offer good-quality products. If the product is broken in 7 days after purchasing when you use it normally, you can choose to send it back for return, replacement or repairing (only the product does not affect the second sales can be returned). Repairing for free in one year if you use it normally.

2.Date of purchase is in accordance with the date on invoice or receipt used by seller, and if you buy it on line, you can show the screenshot of trade.

3.If an inappropriate usage causes the unit damaged, the warranty will be void. As below.

- All damages by inappropriate use, including using it under non-normal working environment or without following the instructions.
- Dismantling, refitting, repairing by user in private.
- Causing damage by using some fittings instead of the designative or accredited ones.
- Cannot provide credible proof of purchase.

4.Sending it back to our company for repairing.

5.Contact your S.M.S.L Audio reseller for a return or replacement.

Features

- 2xGerman Infineon's new technology class D power amplifier chip, higher quality, efficiency up to 92%, further reducing power consumption;
- Using NJRC's electronic volume control chip NJW1194 from Japan, precise volume control and low distortion;
- The balanced design, from input to speaker output, greatly reducing distortion caused by signal transmission;
- Built-in SMSL SDB patented sound and treble/bass adjustment for easy matching of a variety of speakers and music;
- Subwoofer pre out for 2.1 system application.
- New Bluetooth 5.0 reception, better sound quality, longer transmission distance, support APT-X!
- All aluminum alloy CNC precision processing shell, anodizing technology and chamfering process, exquisite workmanship and delicate touch;
- Color LCD display and user-friendly operating system are simple and easy to understand, equipped with full-featured remote control function;
- Low power standby function to meet the latest European ErP2 standard;
- A large number of professional Hi-Fi audio components are used to enhance the sound experience;
- High quality gold-plated input and output terminals;
- Perfect protection circuit for overheating, overcurrent, etc.
- Built-in high quality power supply, specially designed for audio!

Specifications

Inputs	XLR , RCA , BT
THD+N	0.003%
SNR	111dB
Channel separation	96dB
Input Sensitivity / Input Impedance.....	250mV/47k Ω
Output Power	150Wx2(2 Ω) / 90Wx2(4 Ω) / 50Wx2(8 Ω)
Power Consumption	40W(Normal Volume)
Standby power	0.5W
Size	187.5X40X154mm(WxHxD)
Weight	0.96kg
Weight (In shipping carton).....	1.46kg

Remote control

- Install 2 x AAA batteries as instructions.
- When using the remote control, point it toward the remote control signal receiver on the main unit from a distance of 5 m (16 ft) or less. Do not place obstructions between the main unit and the remote control.
- The remote control might not work if the remote control signal receiver on the unit is exposed to direct sunlight or bright light. If this occurs, try moving the unit. Beware that use of this remote control could cause the unintentional operation of other devices that can be controlled by infra.

Operating the remote control

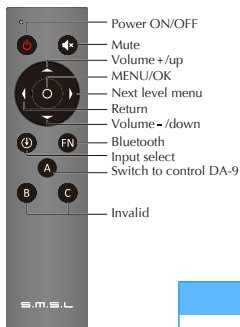

Note

1. This remote controller use 2 x R03/AAA batteries.
2. When you first operate DA-9, press the A key first.

Display Interface and Instructions

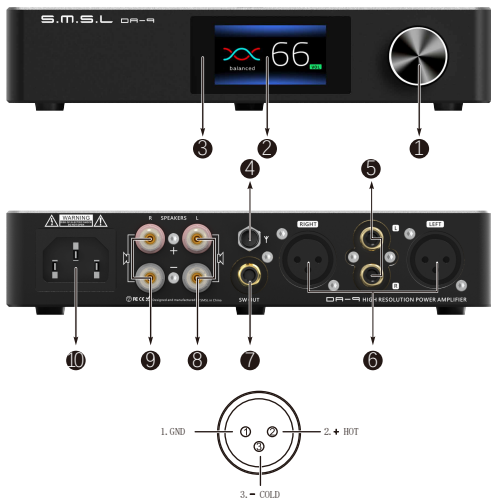

- | | | |
|----------------|-----------------------|------------------------|
| 1 Knob | 2 Display | 3 Remote window |
| 4 Antenna | 4 RCA | 6 XLR |
| 7 SW out | 8 Left channel output | 9 Right channel output |
| 10 Power input | | |

Note:

Please pay attention to the polarity when connecting the speakers, it must follow the mark on the unit, to avoid any effect to the sound quality.

User interface

1. Main

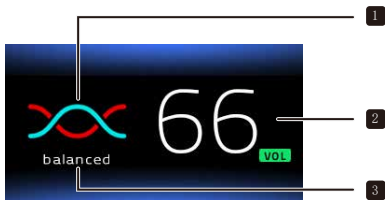

1. Input source icon
2. Volume Level
3. Red when muted
4. Input source name

Display Interface and Instructions

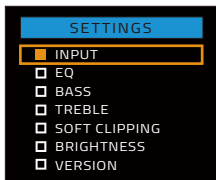

There are 6 pages of settings in this menu.

1. INPUT
2. EQ
3. BASS
4. TREBLE
5. SOFT CLIPPING
6. BRIGHTNESS
7. VERSION

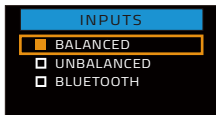

INPUTS

1. BALANCED
2. UNBALANCED
3. BLUETOOTH

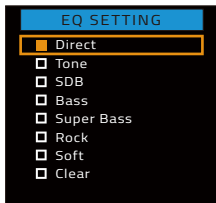

EQ Setting

1. Direct
2. Tone
3. SDB
4. Bass
5. Super Bass
6. Rock
7. Soft
8. Clear

Display Interface and Instructions

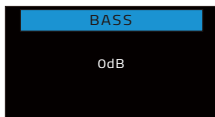

Bass adjustment range: -10dB ~ +10dB

When the EQ mode is Direct or other EQ mode, changing the Bass will change the EQ to Tone mode.



Treble adjustment range: -10dB ~ +10dB

When the EQ mode is Direct or other EQ mode, changing the Treble will change the EQ to Tone mode.

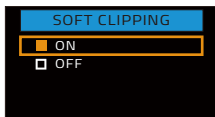

SOFT CLIPPING

1. ON
2. OFF



Brightness Level: 1 ~ 6

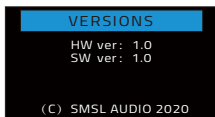

VERSIONS

(C) SMSL AUDIO 2020

Display Interface and Instructions

■ Bluetooth operating instructions

This product is equipped with a **Bluetooth button**, which is the **FN button** on the remote control. The functions of this button include:

- **Short press:** Switch directly to Bluetooth input, if Bluetooth loses connection, it is a reconnect;
- **Long press:** Disconnect the current device and allow pairing with other devices.

Connection:

- Step 1: Switch the input source in the SETTING MENU or press the Bluetooth button of the remote;
- Step 2: Turn on the Bluetooth function of the mobile phone, search for "SMSL BT5.0A", and tap to pairing. When the mobile phone displays "connected", it has been successfully connected.

Re-connection:

When you had lost the connection with the DA-9, for example, going out, and back home, some phones will not re-connect the DA-9 if the DA-9 has not been re-boot, so you can **press the Bluetooth button (FN)** on the remote to Re-connect.

Clear pairing: Long press the "Bluetooth" button(FN) on the remote control. After clearing the pairing, some phones may no longer be able to search for "SMSL BT5.0A". In this case, you need to delete the Bluetooth device "SMSL BT5.0A" which saved in the phone, and then search and pairing again.

■ Factory Reset

- Connect the power cord when pressing the power button, until the screen shows the logo. Then stop pressing and restart the unit.

FCC Warning:

This equipment has been tested and found to comply with the limits for a Class B digital device, pursuant to part 15 of the FCC Rules. These limits are designed to provide reasonable protection against harmful interference in a residential installation. This equipment generates, uses and can radiate radio frequency energy and, if not installed and used in accordance with the instructions, may cause harmful interference to radio communications. However, there is no guarantee that interference will not occur in a particular installation. If this equipment does cause harmful interference to radio or television reception, which can be determined by turning the equipment off and on, the user is encouraged to try to correct the interference by one or more of the following measures:

- Reorient or relocate the receiving antenna.
- Increase the separation between the equipment and receiver.
- Connect the equipment into an outlet on a circuit different from that to which the receiver is connected.
- Consult the dealer or an experienced radio/TV technician for help.

Caution: Any changes or modifications to this device not explicitly approved by manufacturer could void your authority to operate this equipment.

This device complies with part 15 of the FCC Rules. Operation is subject to the following two conditions:

(1) This device may not cause harmful interference, and (2) this device must accept any interference received, including interference that may cause undesired operation.

This equipment complies with FCC radiation exposure limits set forth for an uncontrolled environment. This equipment should be installed and operated with minimum distance 20cm between the radiator and your body.