

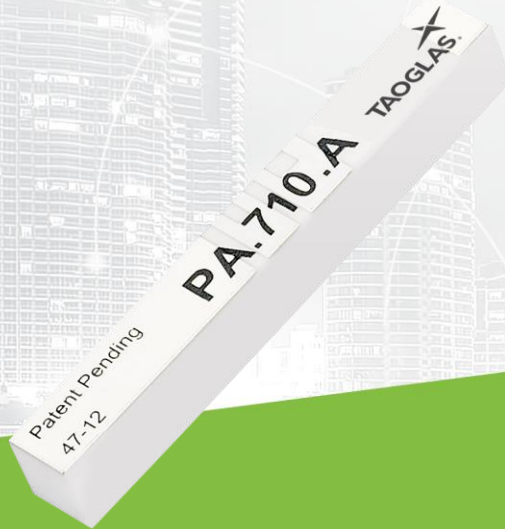

TAOGLAS®



Datasheet

Warrior

Part No:
PA.710.A

Description:

Warrior LTE/Cellular SMD Antenna
For 4G/3G/2G Applications

Features:

698MHz to 960MHz, 1710MHz to 2690MHz
High Efficiency Wideband Antenna
Manufactured in an IATF16949 Certified Facility
Surface Mount Distribution
Dimensions: 40 x 5 x 6 mm
RoHS & REACH Compliant

1. Introduction	3
2. Specifications	4
3. Antenna Characteristics	6
4. Radiation Patterns	9
5. Mechanical Drawing	26
6. Antenna Integration Guide	27
7. Packaging	35
<hr/>	
Changelog	36

Taoglas makes no warranties based on the accuracy or completeness of the contents of this document and reserves the right to make changes to specifications and product descriptions at any time without notice. Taoglas reserves all rights to this document and the information contained herein. Reproduction, use or disclosure to third parties without express permission is strictly prohibited.



1. Introduction



The Warrior, the revolutionary patent pending PA.710A is a 4G/3G/2G, High Efficiency SMD Ceramic antenna, operating at 698MHz to 960MHz and 1710MHz to 2690MHz. It uses high grade custom ceramic material and new design techniques to deliver the highest efficiencies on all bands when mounted on the device's main PCB. The exceptional wide-band response means it is the ideal antenna for all LTE applications that also need high efficiency and backward compatibility for 3G and 2G globally on all lower and upper bands. The PA.710 is delivered on tape and reel and mounted securely during the device PCB reflow process. The PA.710 also operates with great efficiency on worldwide NB-IoT and CAT-M frequency bands. For further information please contact your regional Taoglas customer support team.

1.1 Key Advantages

1. Highest efficiency in a small size, i.e. 40mm*5mm*6mm. A comparative antenna, for example metal/FR4/FPC/whip/rod/helix, would have much reduced efficiency in this configuration due to their different dielectric constants. Very high efficiency antennas are critical to 3G and 4G devices ability to deliver the stated data-speed rates of systems such as HSPA and LTE.
2. More resistant to detuning compared to other antenna integrations. If tuning is required it can be tuned for the device environment using a matching circuit, or other techniques on the main PCB itself. There is no need for new tooling, thereby saving money if customization is required.
3. Highly reliable and robust– its predecessors the PA.25A and PA700A antennas are used by the world’s leading automotive makers in extremely challenging environments. The antenna meets all temperature and mechanical specs required (vibration, drop tests, etc)
4. Easy to integrate. Other antenna designs come in irregular shapes and sizes making them more difficult to integrate.
5. Surface Mount Distribution (Directly On-Board) antenna saves on labor, cable and connector costs, leads to higher integration yield rates, and reduces losses in transmission.
6. Minimum Transmission and Reception Losses - these are kept to absolute minimum resulting in much improved OTA (over the air), i.e. TRP (Total Radiated Power)/TIS (Total Isotropic Radiation), device performance compared to similar efficiency cable and connector antenna solutions. This means it is an ideal antenna to be used for devices that need to pass for example USA carrier network approvals
7. RSE Reductions – will help to eliminate radiated spurious emission failures compared to other antenna technologies as the required layout for the antenna can deliver natural isolation between the onboard noise and the antenna itself. Also the antenna can be matched better to the system with the matching circuit function.
8. High Gain in Both Polarization Planes - Achieves moderate to high gain in both vertical and horizontal polarization planes. This feature is very useful in certain wireless communications where the antenna orientation is not fixed and the reflections or multipath signals may be present from any plane. In those cases, the important parameter to be considered is the total field strength, which is the vector sum of the signal from the horizontal and vertical polarization planes at any instant in time.

2. Specifications

Electrical				
Operation Frequency (MHz)	698~960	1710 ~2170	2300 ~2400MHz	2490 ~2690MHz
Peak Gain	1.0dBi	3.2dBi	3.5dBi	3.5dBi
Average Gain	-2.3dB	-1.5dB	-1.8dB	-1.5dB
Efficiency	60%	70%	65%	70%
VSWR	<3.0:1			
Impedance	50Ω			
Polarization	Linear			
Radiation Properties	Omni-directional			
Max Input Power	5 W			

The PA.710 antenna performance was measured with Taoglas PAD.710.A EVB.

Mechanical	
Dimensions (mm)	40 x 5 x 6 mm
Material	Ceramic
Termination	Ag (environmental-friendly Pb free)
EVB Connector	SMA(F)
Environmental	
Operation Temperature	-40°C to 85°C
Storage Temperature	-40°C to 105°C
Moisture Sensitivity Level	3
RoHs Compliant	Yes

5G/4G Bands			
Band Number	5GNR / FR1 / LTE / LTE-Advanced / WCDMA / HSPA / HSPA+ / TD-SCDMA		
	Uplink	Downlink	Covered
1	UL: 1920 to 1980	DL: 2110 to 2170	✓
2	UL: 1850 to 1910	DL: 1930 to 1990	✓
3	UL: 1710 to 1785	DL: 1805 to 1880	✓
4	UL: 1710 to 1755	DL: 2110 to 2155	✓
5	UL: 824 to 849	DL: 869 to 894	✓
7	UL: 2500 to 2570	DL: 2620 to 2690	✓
8	UL: 880 to 915	DL: 925 to 960	✓
9	UL: 1749.9 to 1784.9	DL: 1844.9 to 1879.9	✓
11	UL: 1427.9 to 1447.9	DL: 1475.9 to 1495.9	✗
12	UL: 699 to 716	DL: 729 to 746	✓
13	UL: 777 to 787	DL: 746 to 756	✓
14	UL: 788 to 798	DL: 758 to 768	✓
17	UL: 704 to 716	DL: 734 to 746	✓
18	UL: 815 to 830	DL: 860 to 875	✓
19	UL: 830 to 845	DL: 875 to 890	✓
20	UL: 832 to 862	DL: 791 to 821	✓
21	UL: 1447.9 to 1462.9	DL: 1495.9 to 1510.9	✗
22	UL: 3410 to 3490	DL: 3510 to 3590	✗
23	UL: 2000 to 2020	DL: 2180 to 2200	✓
24	UL: 1625.5 to 1660.5	DL: 1525 to 1559	✓
25	UL: 1850 to 1915	DL: 1930 to 1995	✓
26	UL: 814 to 849	DL: 859 to 894	✓
27	UL: 807 to 824	DL: 852 to 869	✓
28	UL: 703 to 748	DL: 758 to 803	✓
29	UL: -	DL: 717 to 728	✓
30	UL: 2305 to 2315	DL: 2350 to 2360	✓
31	UL: 452.5 to 457.5	DL: 462.5 to 467.5	✗
32	UL: -	DL: 1452 - 1496	✓
35		1850 to 1910	✓
38		2570 to 2620	✓
39		1880 to 1920	✓
40		2300 to 2400	✓
41		2496 to 2690	✓
42		3400 to 3600	✗
43		3600 to 3800	✗
48		3550 to 3700	✗
66	UL: 1710-1780	DL: 2110-2200	✓
71		617 to 698	✓
74/75/76		1427 to 1518	✓
78		3300 to 3800	✗
79		4400 to 5000	✗
85	698-716	728-746	✓

*Covered bands represent an efficiency greater than 20%

3. Antenna Characteristics

3.1 Return Loss

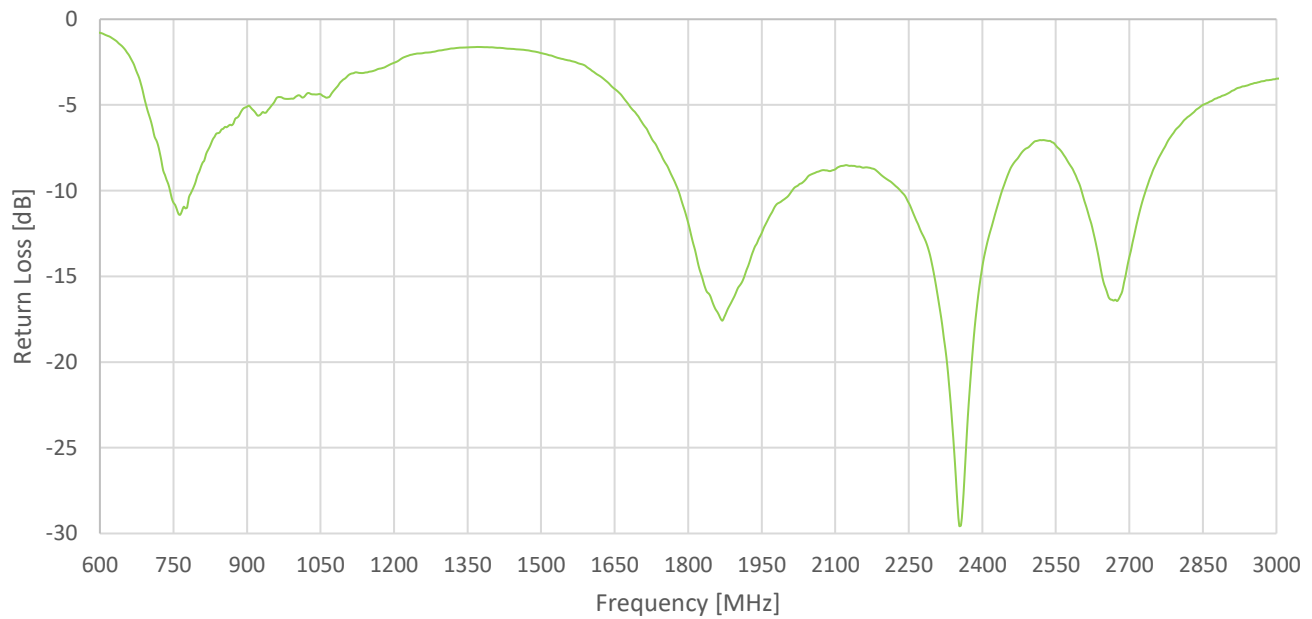

3.2 VSWR

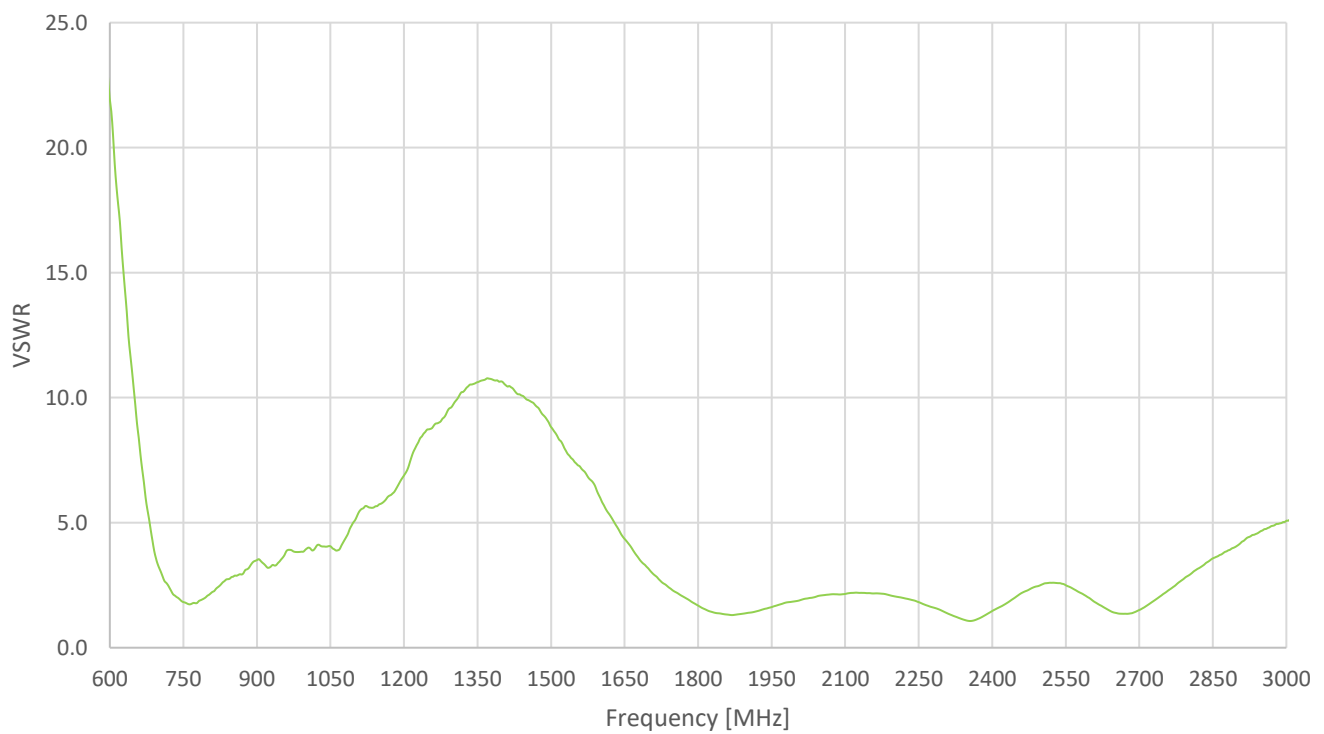

3.3 Efficiency

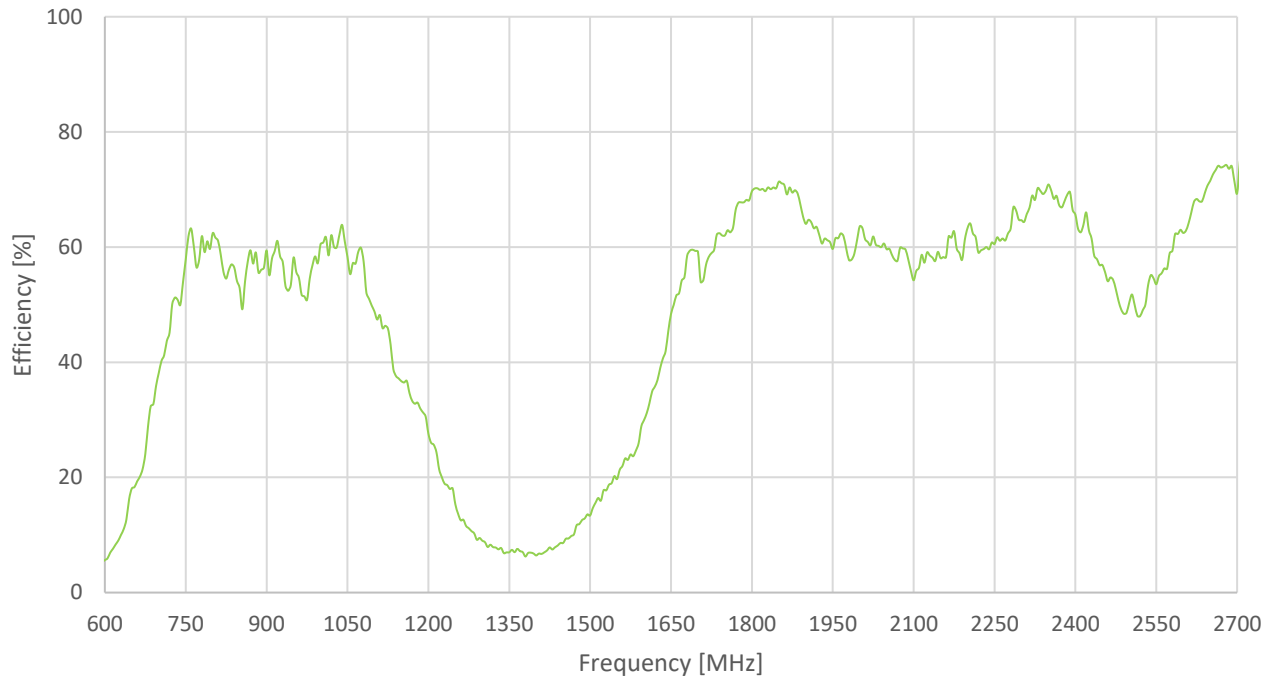

3.4 Peak Gain

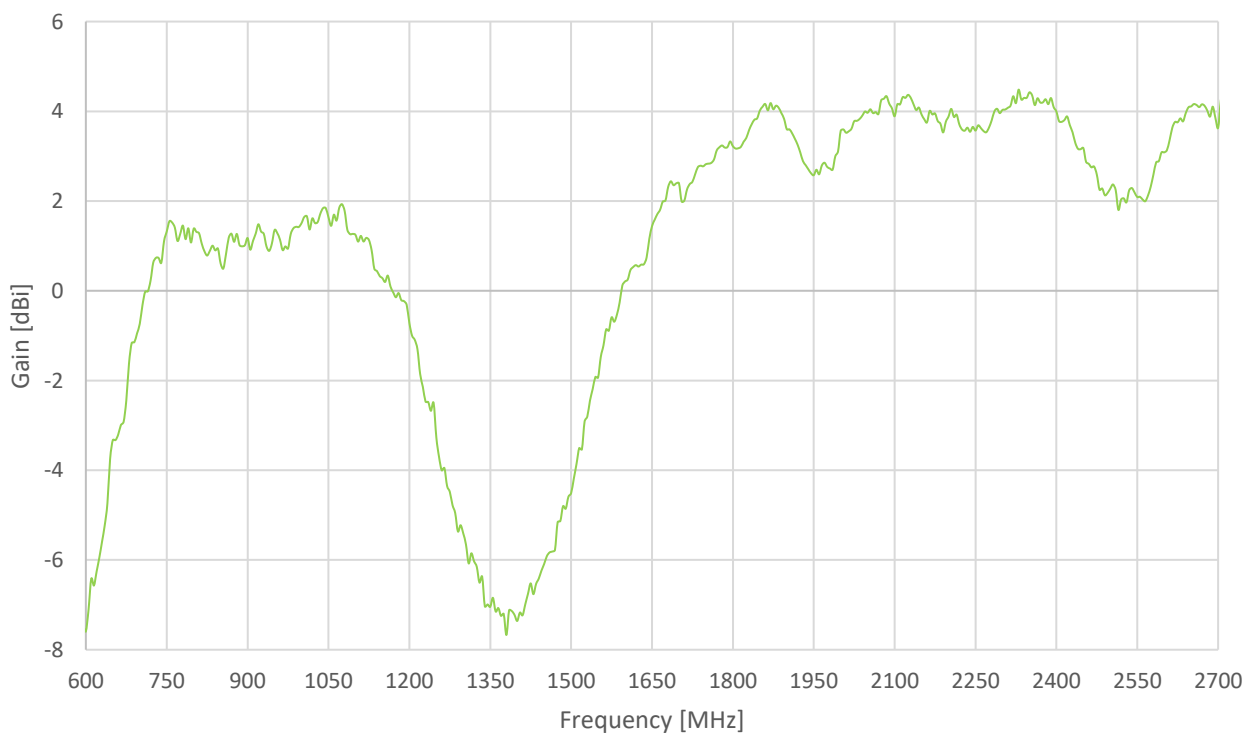

3.5 Average Gain

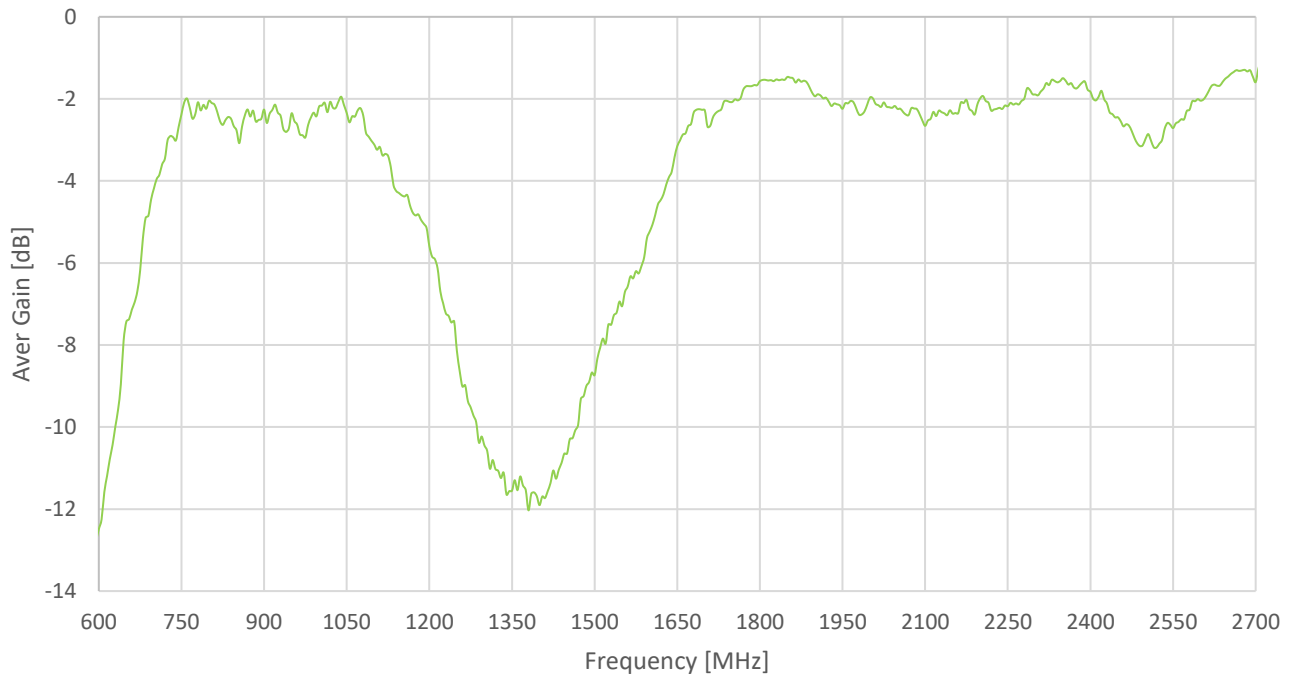

4. Radiation Patterns

4.1 Test Setup

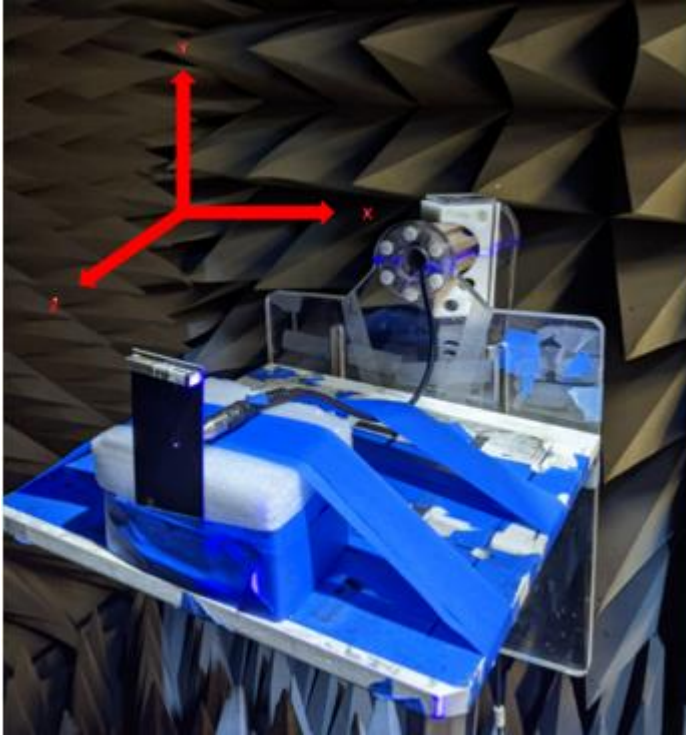

Chamber Set-up

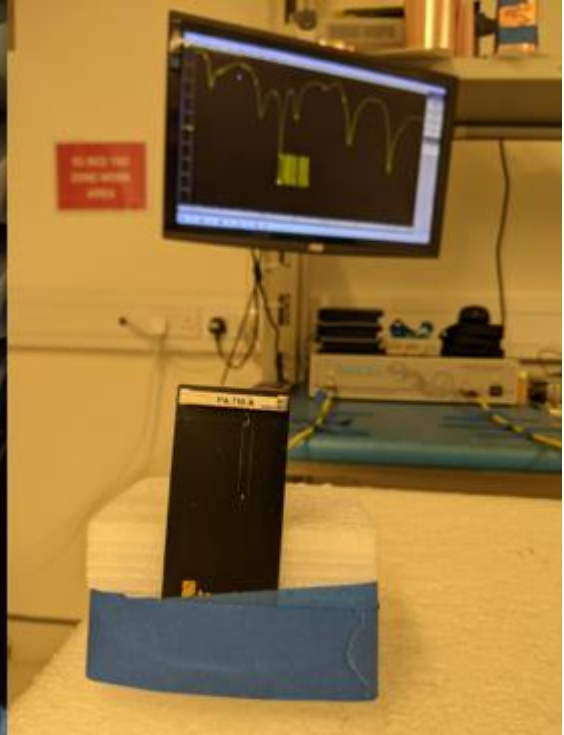

VNA Test Set-Up

4.2 3D and 2D Radiation Patterns

700MHz

Azimuth = 0.0
Elevation = 0.0
Roll = -35.0

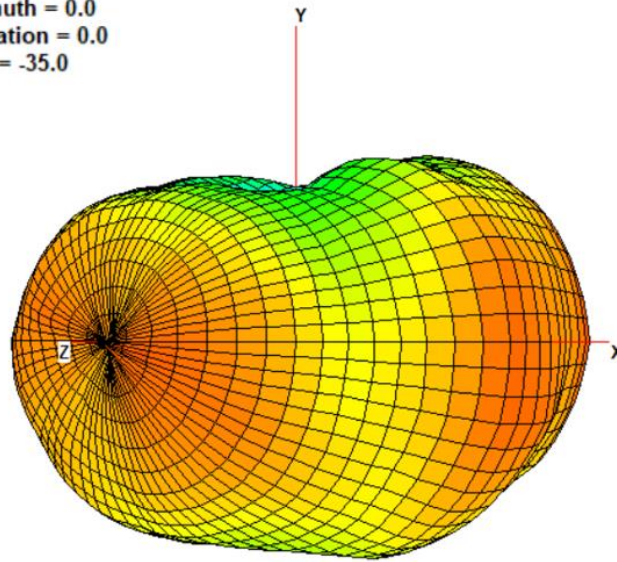

XY Plane

XZ Plane

YZ Plane

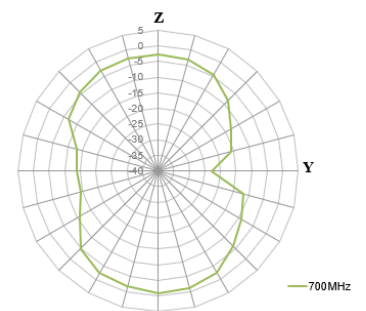
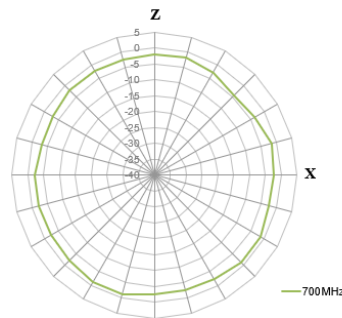
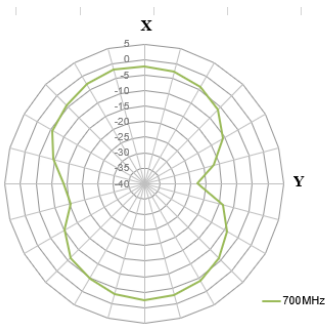

800MHz

Azimuth = 0.0
Elevation = 0.0
Roll = -35.0

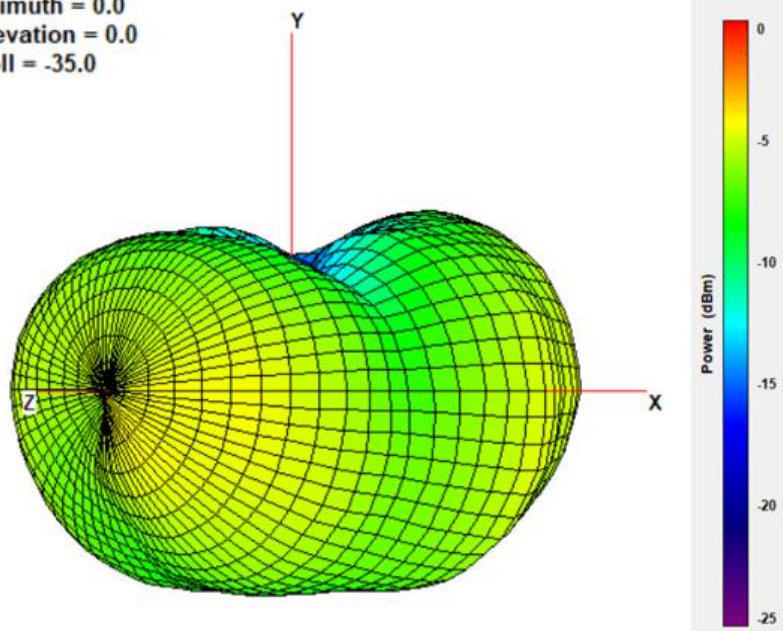

XY Plane

XZ Plane

YZ Plane

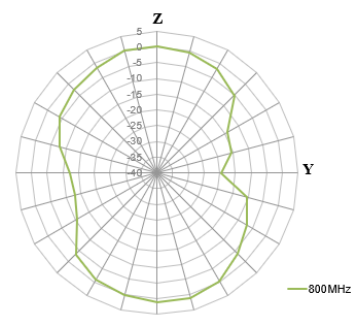
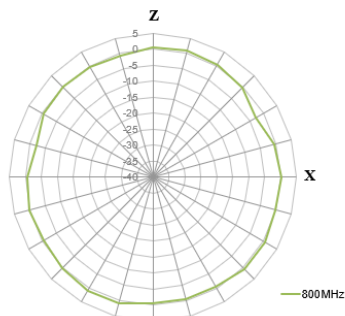
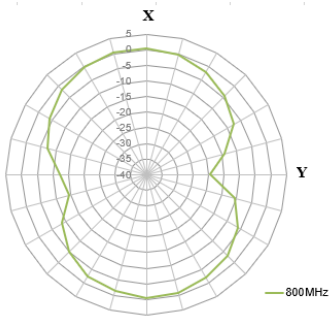

900MHz

Azimuth = 0.0
Elevation = 0.0
Roll = -35.0

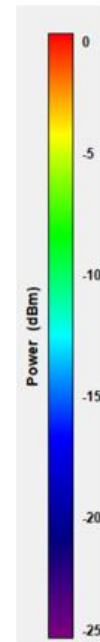
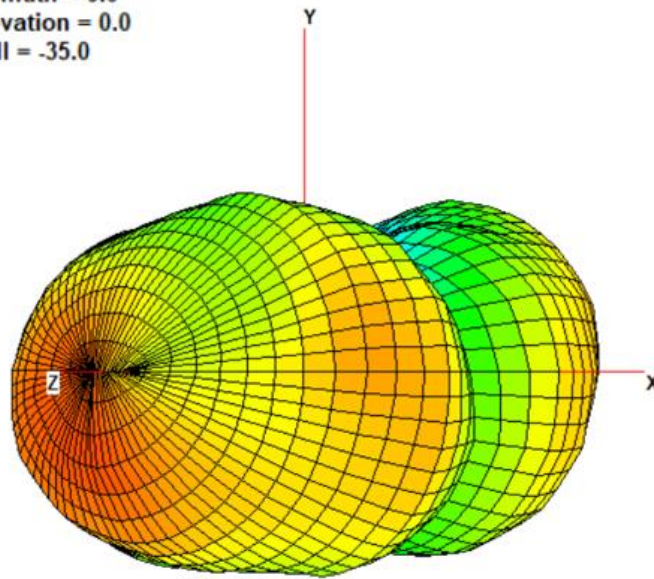

XY Plane

XZ Plane

YZ Plane

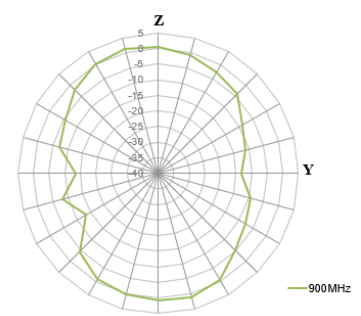
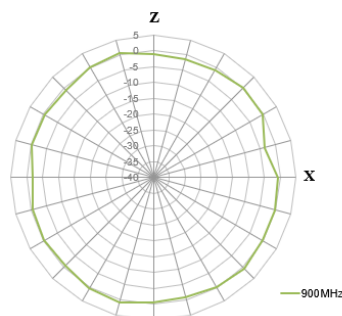
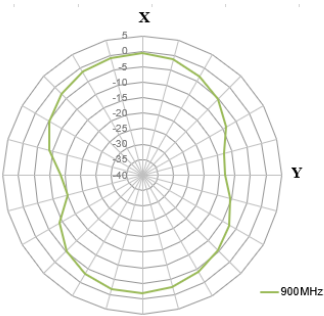

1710MHz

Azimuth = 0.0
Elevation = 0.0
Roll = -35.0

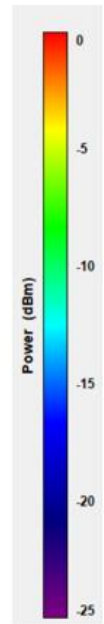
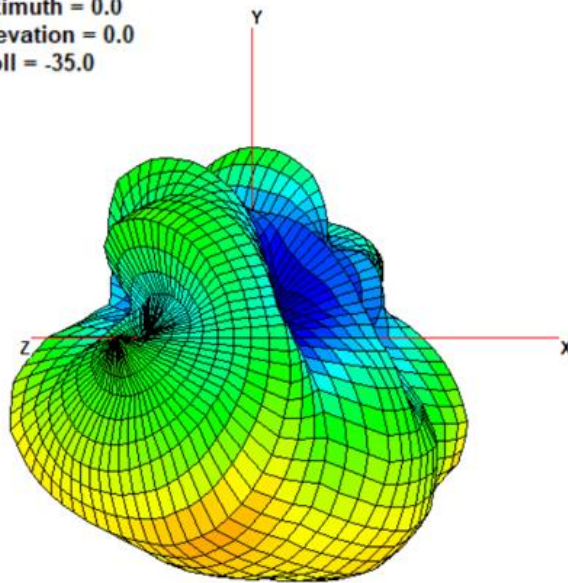

XY Plane

XZ Plane

YZ Plane

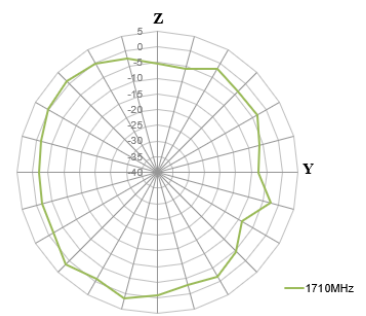
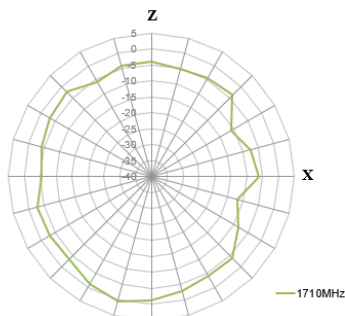
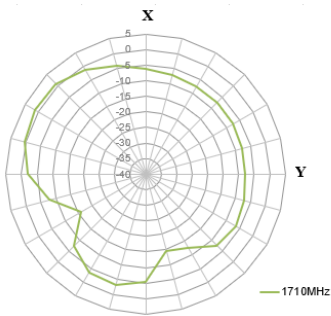

1805MHz

Azimuth = 0.0
Elevation = 0.0
Roll = -35.0

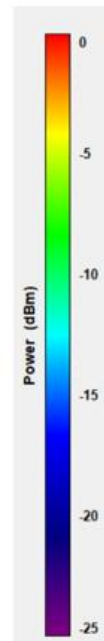
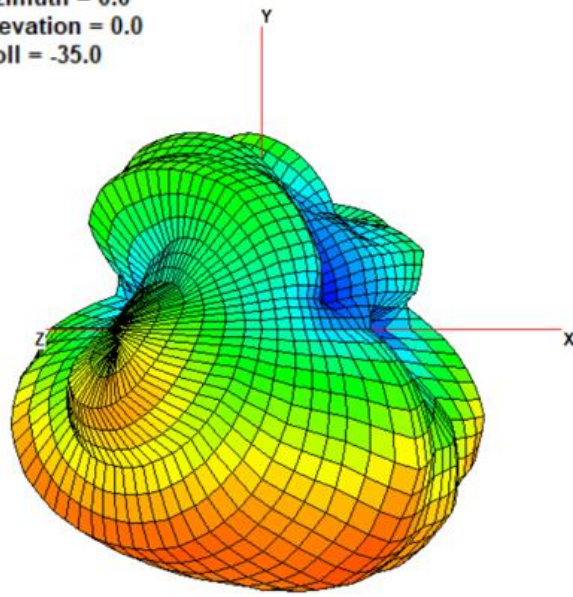

XY Plane

XZ Plane

YZ Plane

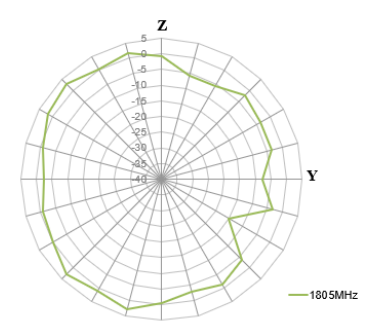
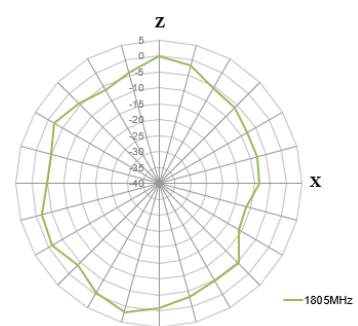
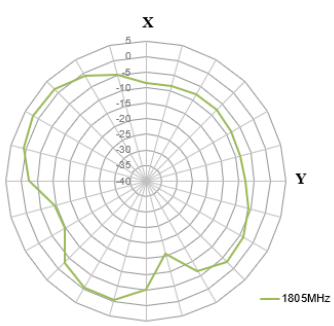

1910MHz

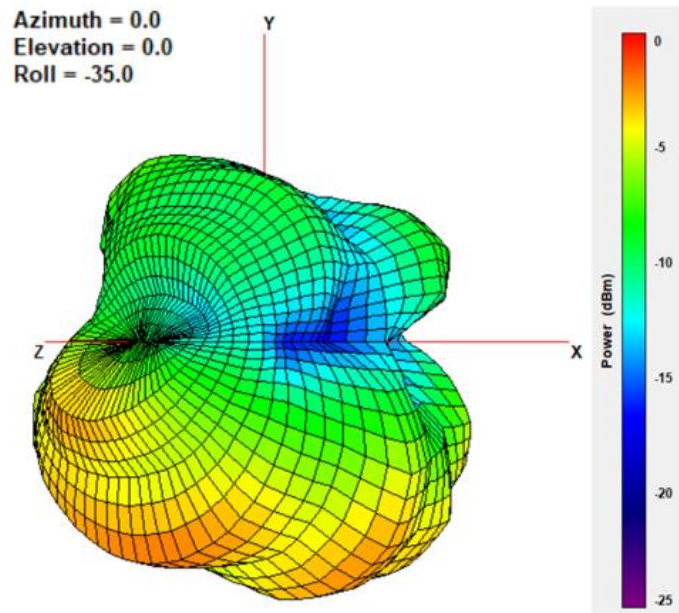

XY Plane

XZ Plane

YZ Plane

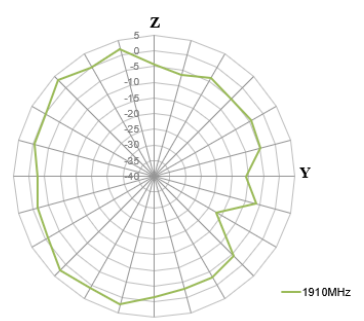
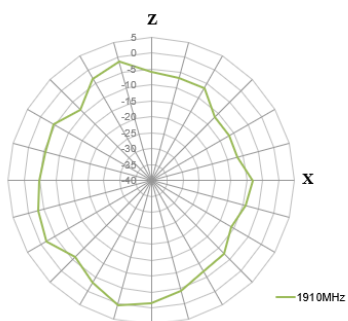
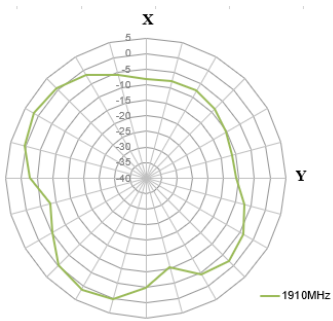

1990MHz

Azimuth = 0.0
 Elevation = 0.0
 Roll = -35.0

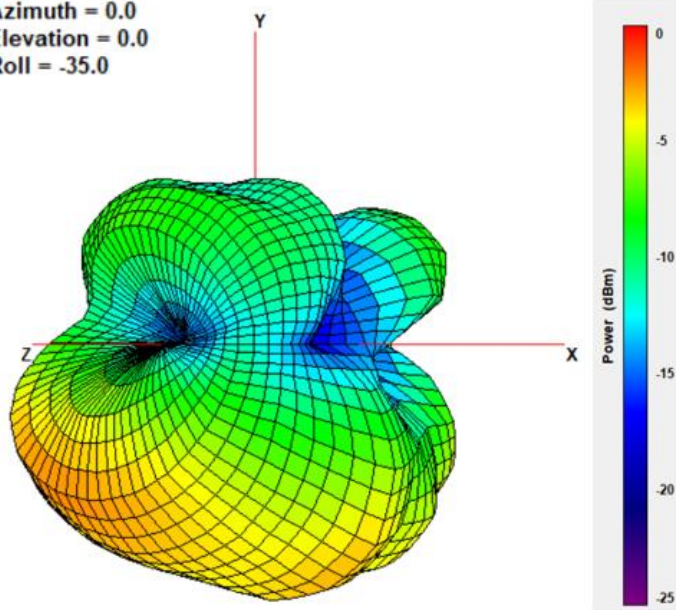

XY Plane

XZ Plane

YZ Plane

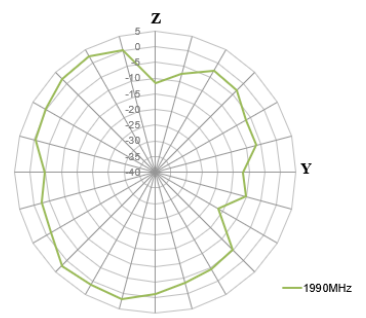
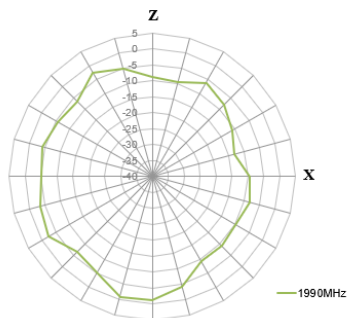
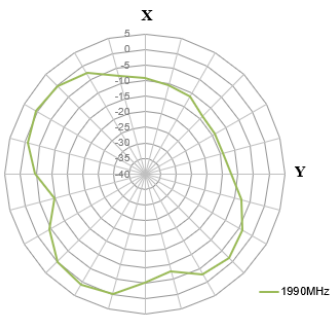

2170MHz

Azimuth = 0.0
Elevation = 0.0
Roll = -35.0

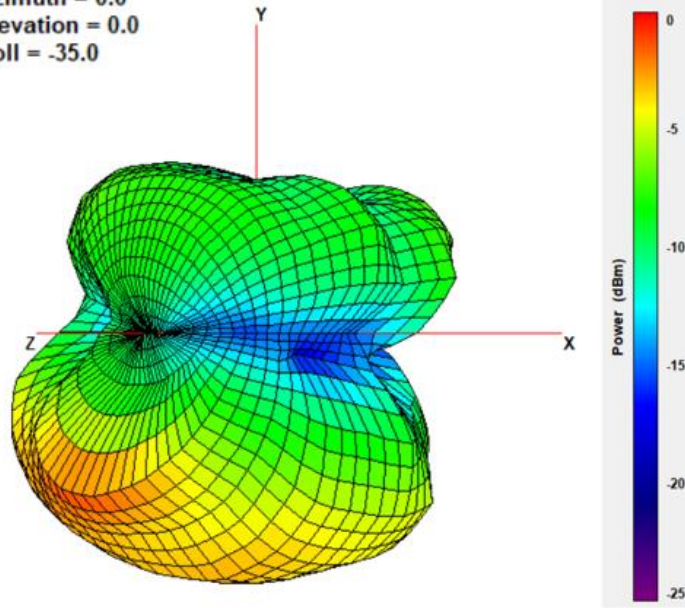

XY Plane

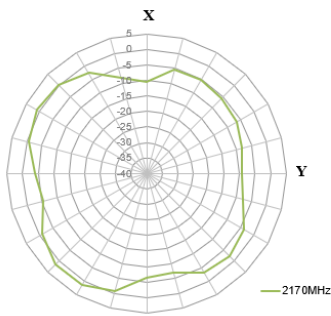

XZ Plane

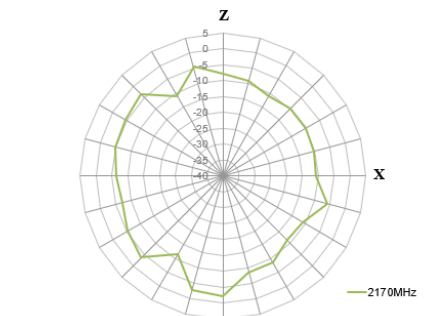

YZ Plane

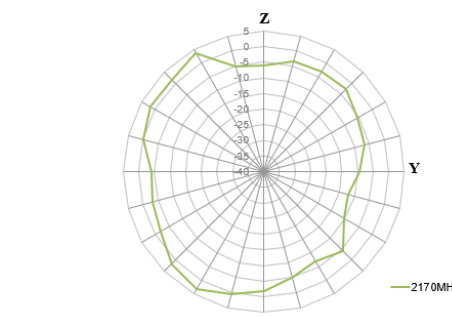

2400MHz

Azimuth = 0.0
 Elevation = 0.0
 Roll = -35.0

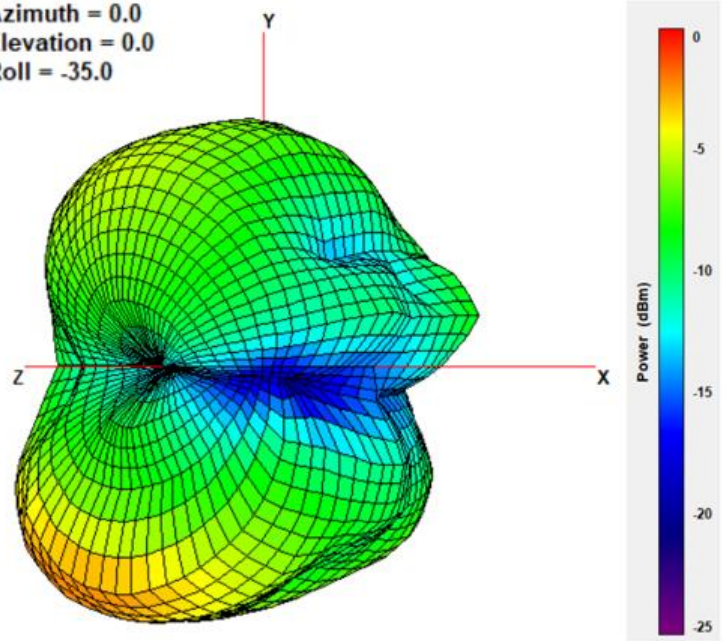

XY Plane

XZ Plane

YZ Plane

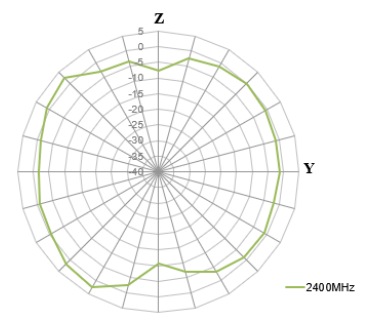
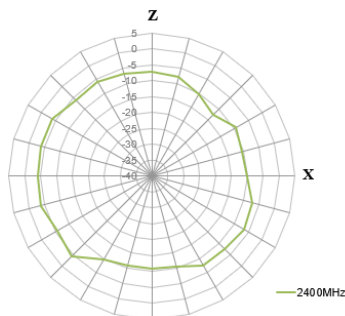
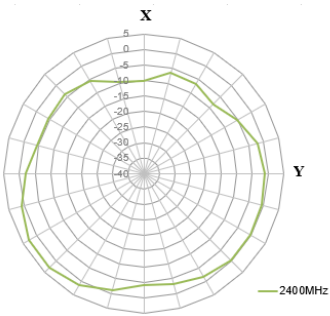

2500MHz

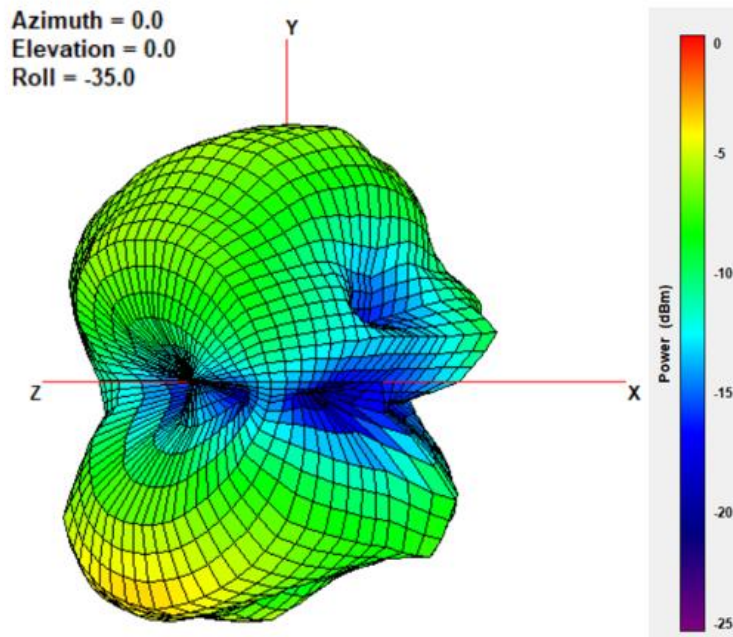

XY Plane

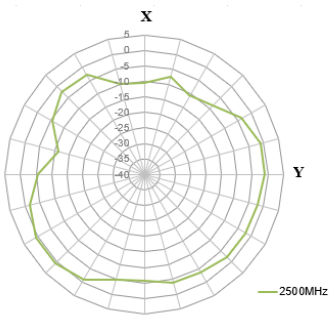

XZ Plane

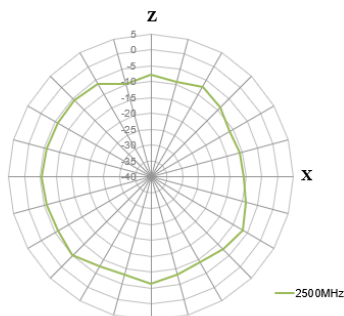

YZ Plane

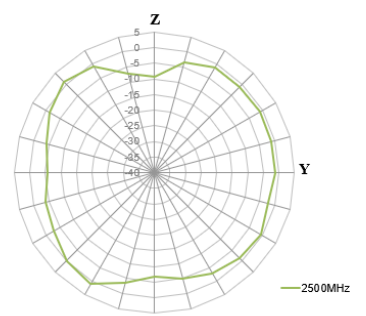

2600MHz

Azimuth = 0.0
Elevation = 0.0
Roll = -35.0

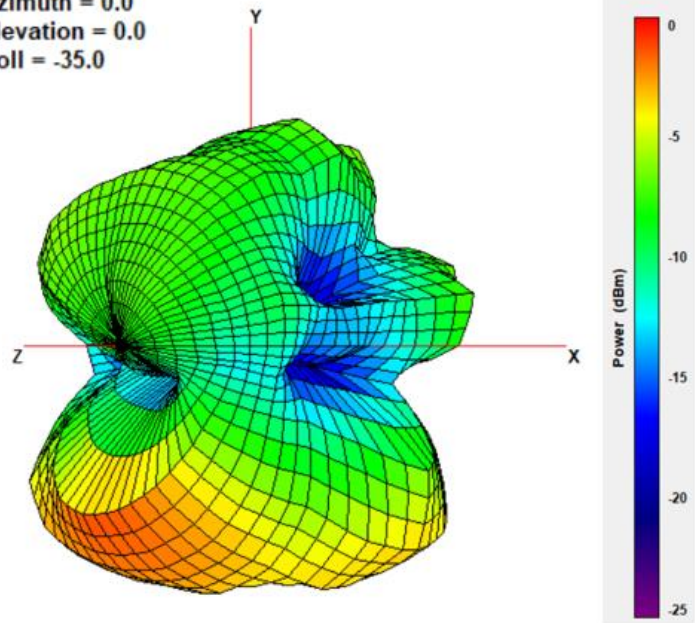

XY Plane

XZ Plane

YZ Plane

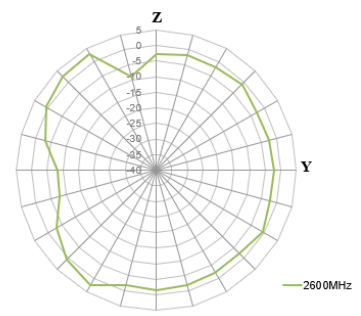
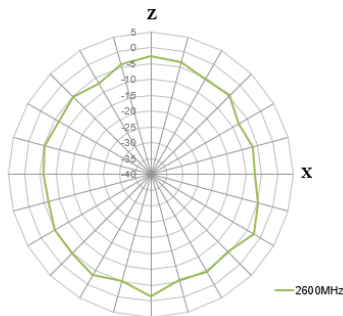
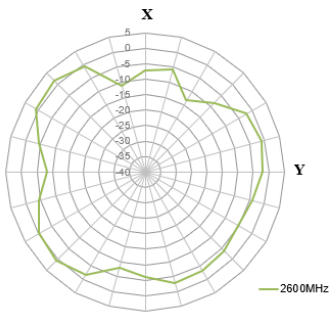

2700MHz

Azimuth = 0.0
Elevation = 0.0
Roll = -35.0

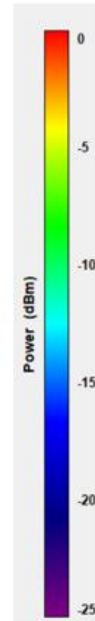
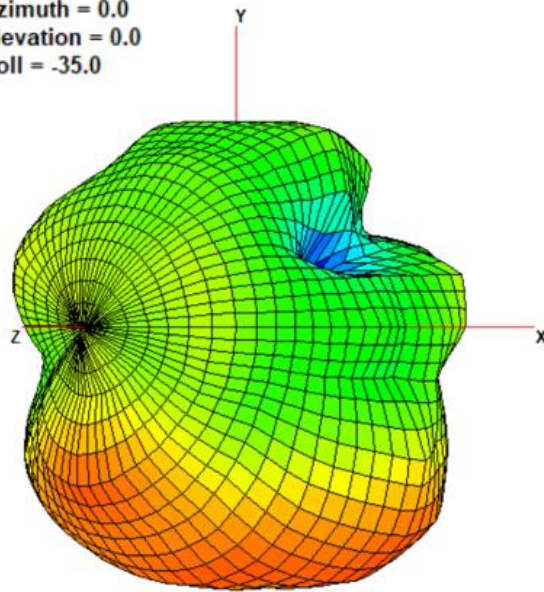

XY Plane

XZ Plane

YZ Plane

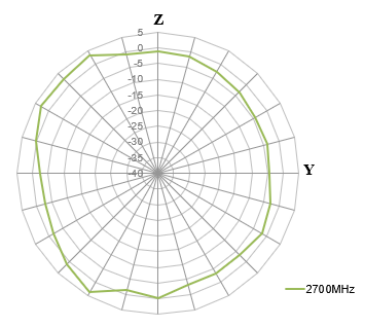
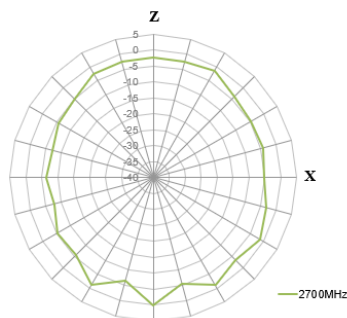
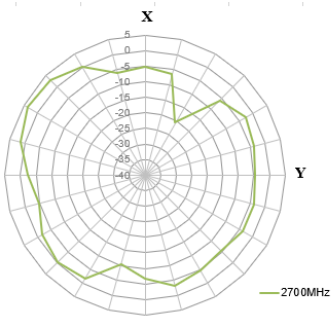

5. Mechanical Drawing (Units: mm)

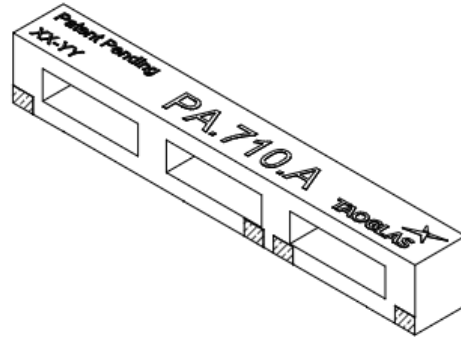

ISOMETRIC VIEW

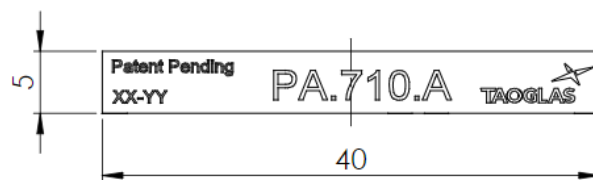

TOP VIEW

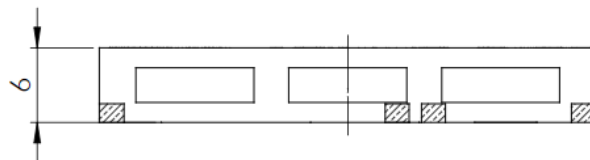

FRONT VIEW

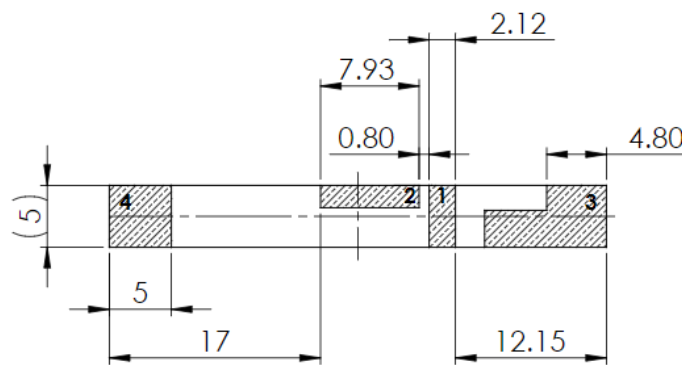

BOTTOM VIEW

5.1 Footprint

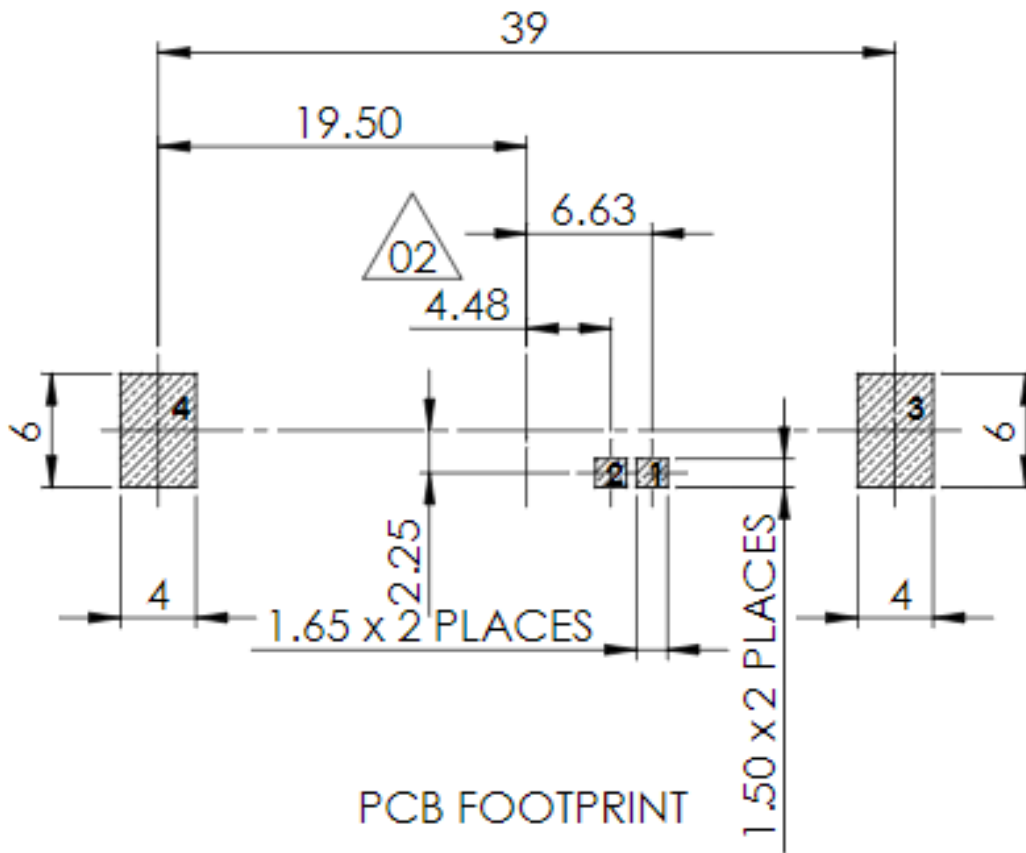

<u>PIN:</u>	<u>DESCRIPTION:</u>
1	FEED (50 OHM)
2	GND
3,4	NC

6. Antenna Intergration Guide

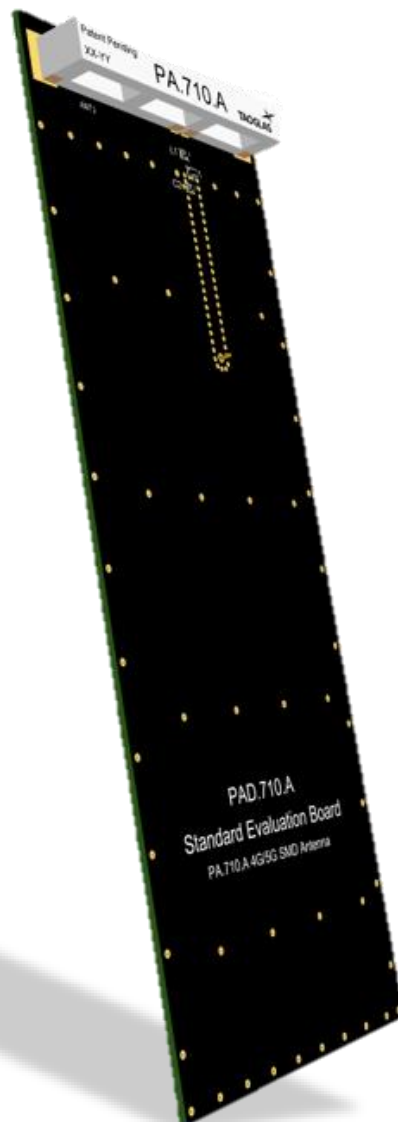
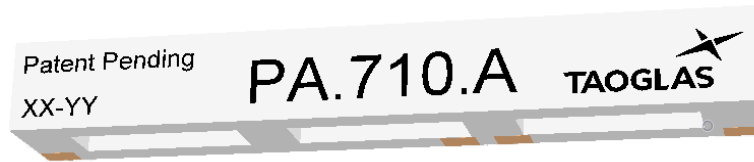

6.1 Schematic Symbol and Pin Definition

The circuit symbol for the antenna is shown below. The antenna has 4 pins with only two pins (Pin 1 and Pin 2) as functional. Pins 3 and 4 are for mechanical strength

Pin	Description
1	RF Feed
2	Ground
3, 4	Mechanical, Not Connected

PA.710.A ANT1

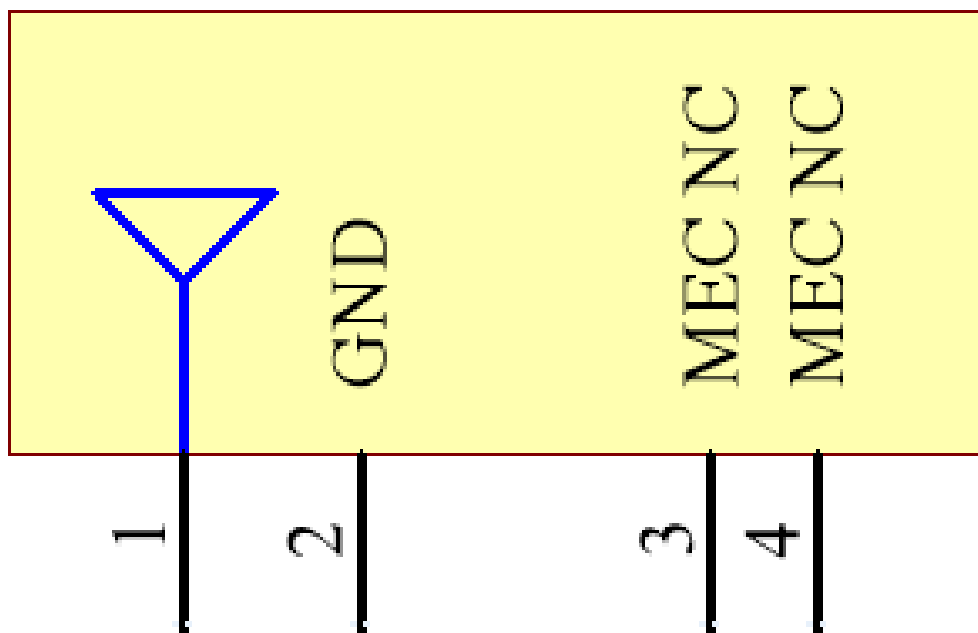

Please note you can download the design files, 3D model, 2D drawings and CST simulation files from the website here:

<https://www.taoglas.com/product/warrior-pa-710-a-wide-band-2g3g4g-smd-pifa-antenna-2/>

6.2 Antenna Integration

Whatever the size of the PCB, the antenna should ideally be placed on the PCB's shortest side, to take advantage of the ground plane. Optimized matching components can be placed as shown.

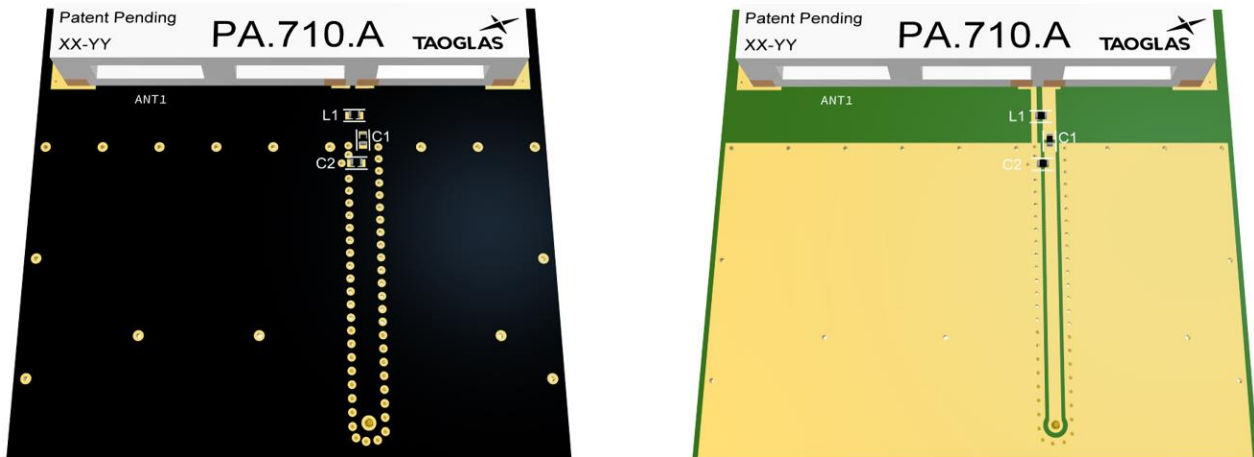

6.3 PCB Layout

The footprint and clearance on the PCB must meet the antenna specification. An example of the PCB layout shows the antenna footprint with clearance. Note the placement of the optimized components. L1 is positioned outside the ground plane and C1 is sitting across the ground plane and the copper clearance area. C2 is optional as a component but it is recommended to include these pads in case they are needed.

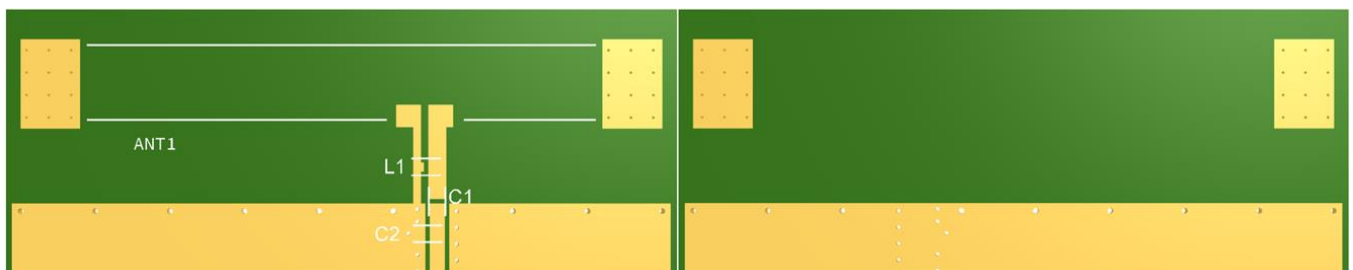

Topside

Bottom Side

6.4 PCB Keep Out

Below shows the antenna footprint and clearance through ALL layers on the PCB. Only the antenna pads and connections to feed and GND are present within this clearance area (marked RED). The clearance area extends to 5mm from the antenna mechanical pads to the ground area. This clearance area includes the bottom side and ALL internal layers on the PCB

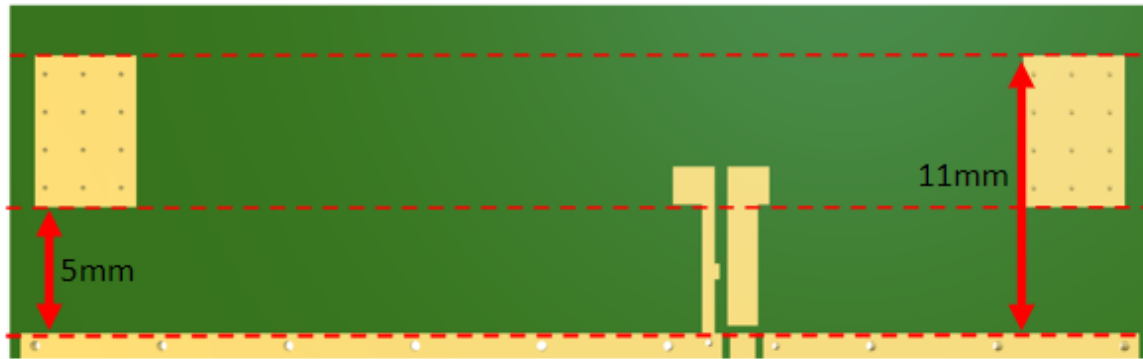

Topside



Bottom Side

6.5 Evaluation Board



6.6 Evaluation Board Ground Plane Length

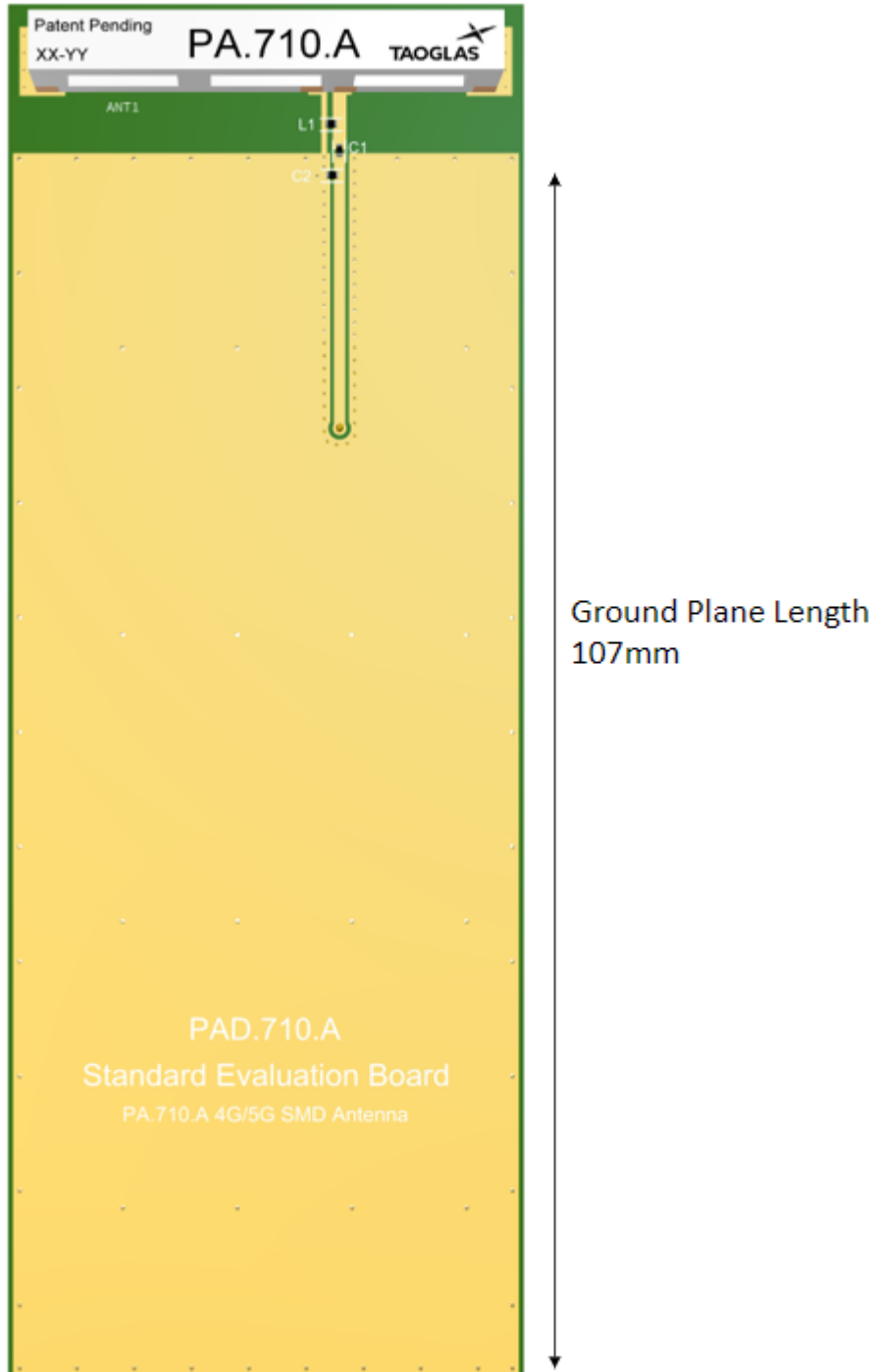

6.7 Evaluation Board Matching Circuit

A matching component (L1) in parallel with the PA.710.A is required for the antenna to have optimal performance on the evaluation board, located outside of the ground plane in the space specified in the above images. Additional matching components may be necessary for your device, so we recommend incorporating extra component footprints, forming a “pi” network, between the cellular module and the edge of the ground plane.

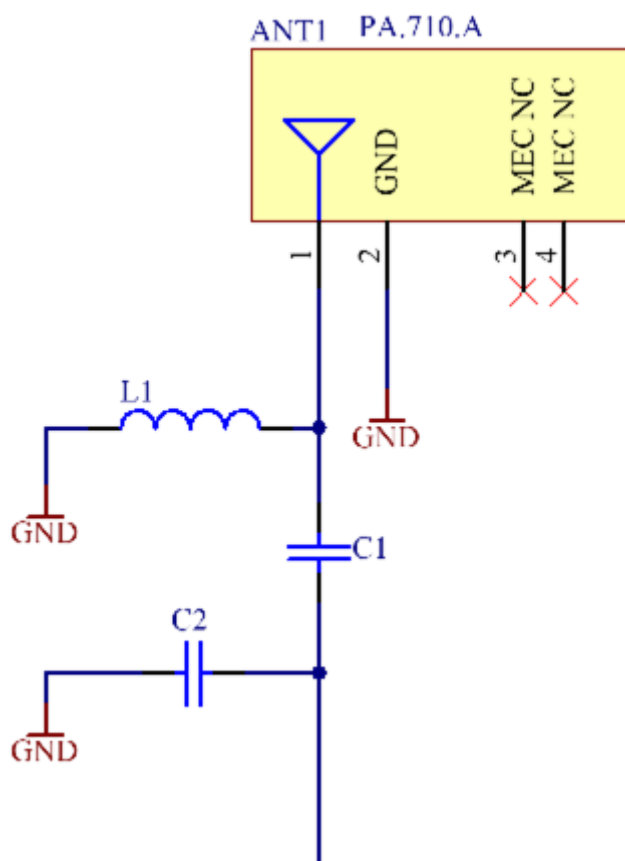

Designator	Type	Value
L1	Inductor	5.6nH
C1	Capacitor	4.3pF
C2	Capacitor	Not Fitted

6.8 PCB Footprint Information

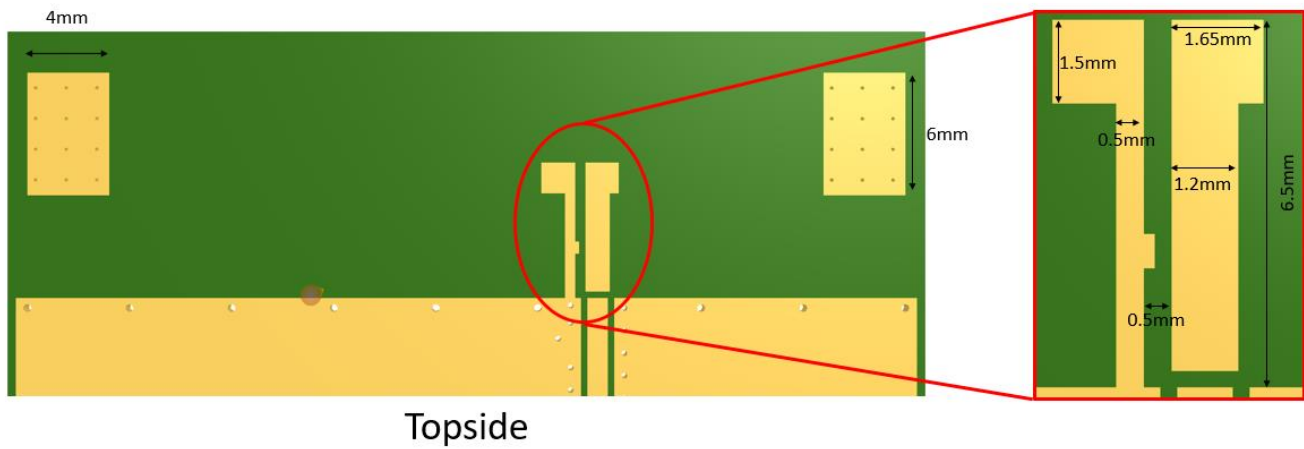

6.9 Vias in Mechanical Pads

Vias are placed in the “no-connect” pads to provide mechanical strength for the pad. These vias are 0.2mm and plated. These vias should be filled with a non-conductive material. Please ensure that the topside surface finish is flat on these pads and the RF Feed and Ground Pad. Vias are covered with soldermask (tenting) on the bottom side.



7. Packaging

450 pc PA.710.A
 1 reel per small inner box
 Dimensions - 330*50mm
 Weight - 2.1kg

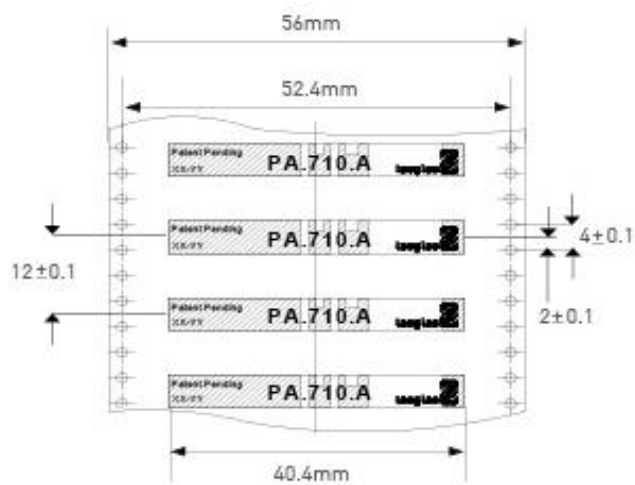
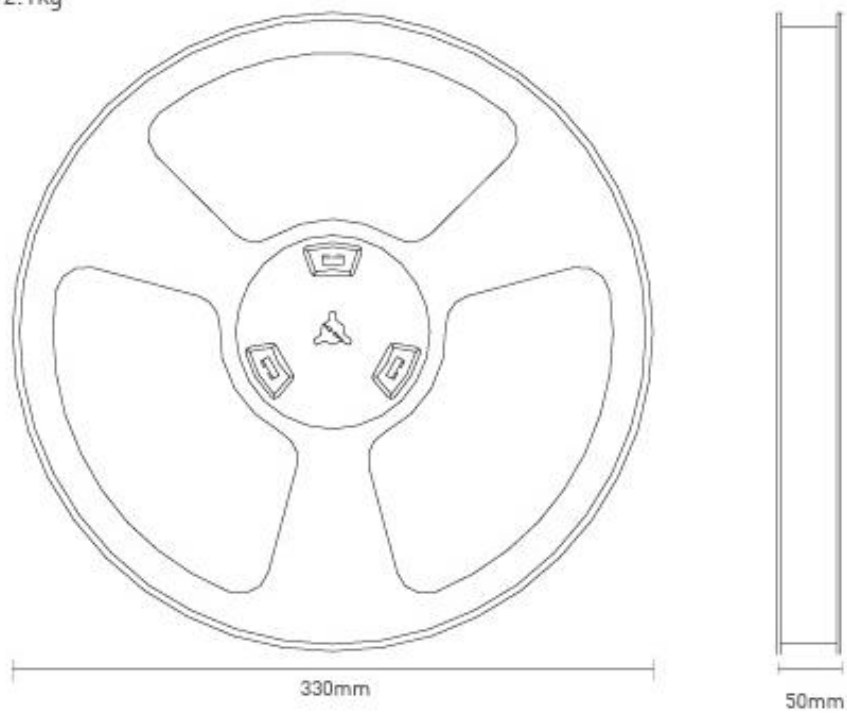

450 pc PA.710.A
 1 reel in small inner box
 Dimensions - 350*350*70
 Weight - 2.4Kg

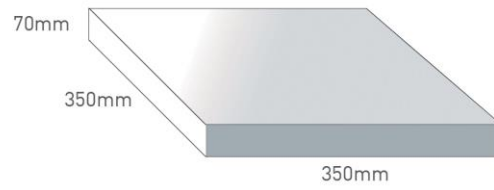

3 boxes / 1350 pcs in one carton
 Carton Dimensions - 370*360*275
 Weight - 8.1Kg

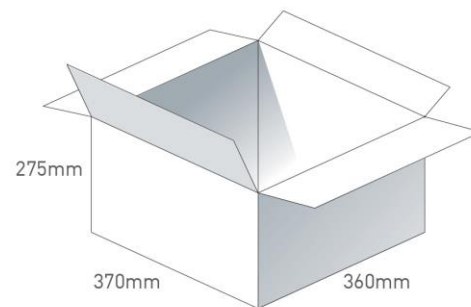

Pallet Dimensions 1110mm*1320mm*1100mm
 36 Cartons per Pallet
 9 Cartons per layer
 4 Layers

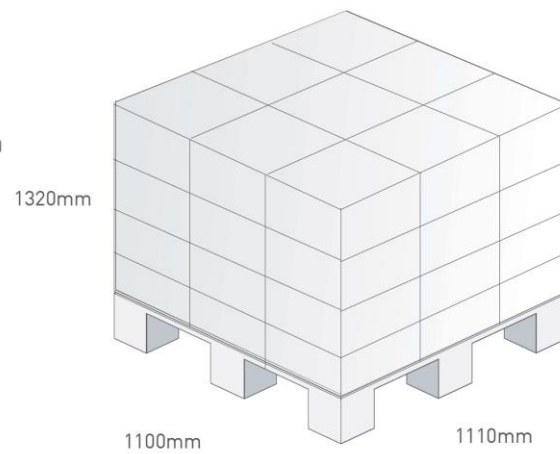

10. Solder Reflow Profile

The PA.710.A can be assembled by following the recommended soldering temperatures as follows:

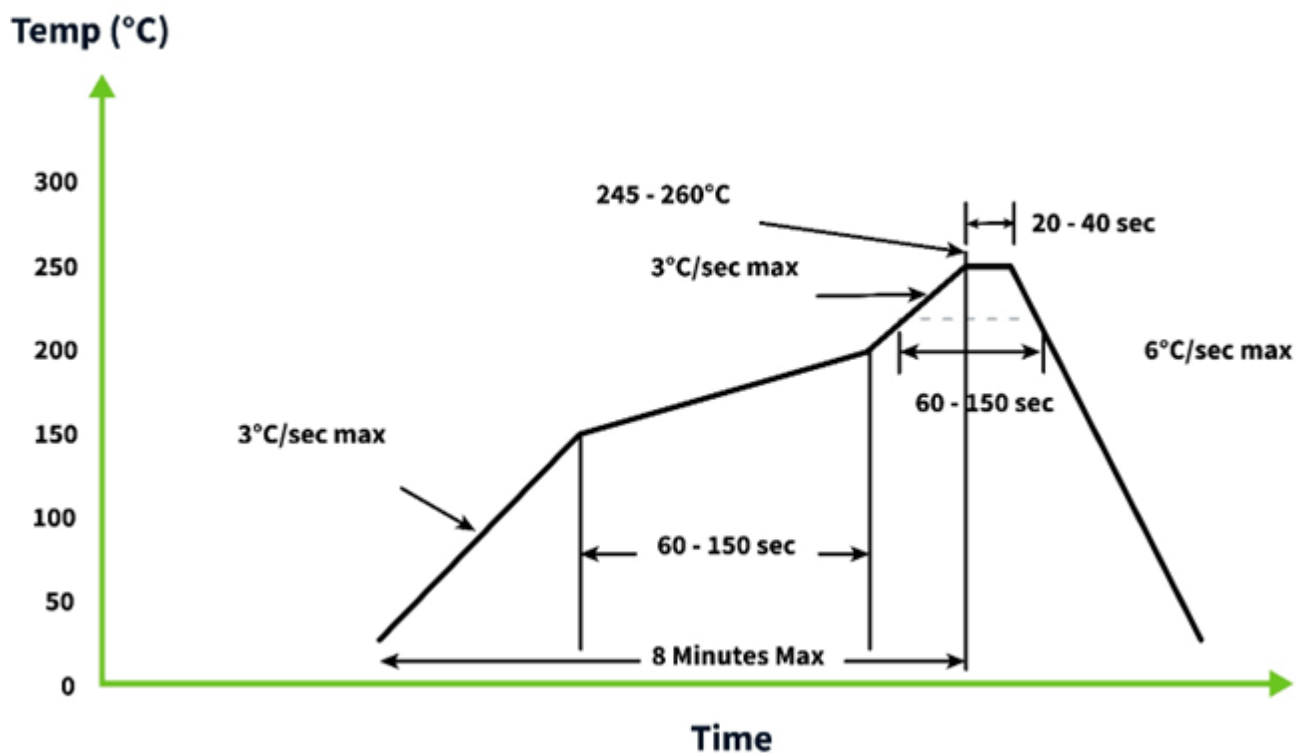

*Temperatures listed within a tolerance of +/- 10° C

Smaller components are typically mounted on the first pass, however, we do advise mounting the PA.710.A when placing larger components on the board during subsequent reflows.

Note: Soldering flux classified ROL0 under IPC J-STD-004 is recommended.

Changelog for the datasheet

SPE-12-8-126 - PA.710.A

Revision: M (Current Version)	
Date:	2023-10-24
Changes:	Updated Solder Reflow Profile
Changes Made by:	Cesar Sousa

Previous Revisions

Revision: L	
Date:	2022-01-05
Changes:	Amended footprint drawing
Changes Made by:	Gary West

Revision: G	
Date:	2018-04-04
Changes:	Corrected axes in test setup photo
Changes Made by:	Andy Mahoney

Revision: K	
Date:	2021-04-07
Changes:	Update datasheet template and added antenna integration guide.
Changes Made by:	Gary West

Revision: F	
Date:	2017-09-12
Changes:	Corrected axes in test setup photo
Changes Made by:	Andy Mahoney

Revision: J (Current Version)	
Date:	2020-11-06
Changes:	Specifications table amended - Moisture Sensitivity Level 3
Changes Made by:	Dan Cantwell

Revision: E	
Date:	2017-04-24
Changes:	Updated Packaging Spec
Changes Made by:	Peter Monahan

Revision: I	
Date:	2019-02-14
Changes:	Change to IP Rating
Changes Made by:	David Connolly

Revision: D	
Date:	2017-05-04
Changes:	Corrected formatting issues
Changes Made by:	Aine Doyle

Revision: H	
Date:	2018-08-14
Changes:	Re-tested "Bent on Ground Planer Edge" configuration
Changes Made by:	Carol Faughnan

Revision: C	
Date:	2013-12-03
Changes:	LTE Table added
Changes Made by:	Andy Mahoney

Previous Revisions (Continued)

Revision: B	
Date:	2012-01-02
Changes:	Drawings Updated
Changes Made by:	Aine Doyle

Revision: A (Original First Release)	
Date:	2012-03-12
Notes:	
Author:	Wayne Yang



TAOGLAS®

www.taoglas.com



Mouser Electronics

Authorized Distributor

Click to View Pricing, Inventory, Delivery & Lifecycle Information:

[Taoglas:](#)

[PA.710.A](#) [PAD.710.A](#)