

Antenna Specification

Specifications Summary

ITEM	SPEC.	
Model Name	IBM 2.4 GHz	
Center Frequency	2400 MHz 2430 MHz 2480 MHz	-0.01 dBi 0.00 dBi -1.61 dBi
MAX.GAIN	0.00 dBi	
Polarization	Vertical	
Azimuth Beam Pattern	Omni-directional	
Impedance	50Ω	
Antenna Length	3.3cm	

Antenna Photo&Length(mm)

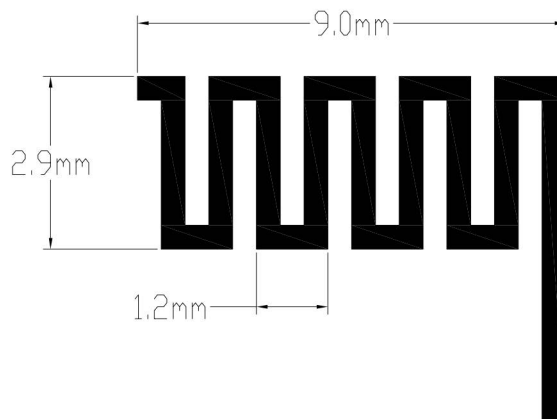

Name and address of the antenna manufacturer	Shen Zhen Dx-Smart Technology Co.,Ltd 601, 6th Floor, Block A, Huafeng Zhigu (Hangcheng High-tech Industrial Park), Hangcheng Road, Hangcheng Street, Baoan District, Shenzhen
Test Address	Floor 5, Building 3, Langwei Jingzhong Industrial Zone, Pingshan Street, Pingshan New District, Shenzhen City
Test Date	2022/9/21
Test Instrument	Vector network analyzer - R&S ZVB20

1. Mainantenna:2400MHz

1.1 Horizontal

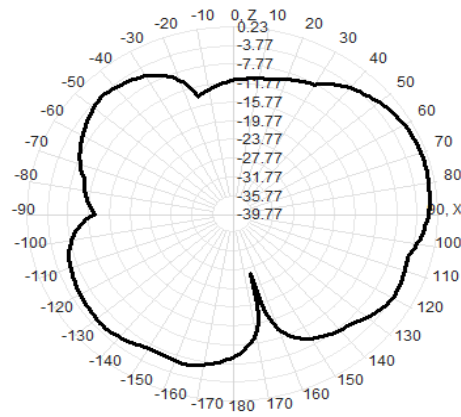

Frequency(MHZ):2400

Antenna Polarity: Horizontal

Maximum Value(dBi): -0.99

AverageGain(dBi):-4.73

MinimumGain(dBi):-25.89

1.2 Vertical

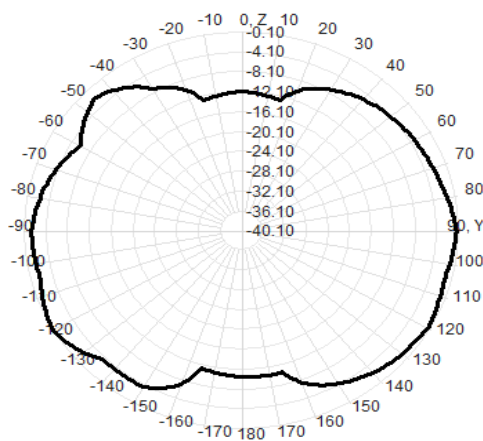

Frequency(MHZ):2400

Antenna Polarity: Vertical

Maximum Value(dBi):-0.01

AverageGain(dBi):-1.59

MinimumGain(dBi):-13.25

2. Mainantenna:2430MHz

2.1 Horizontal

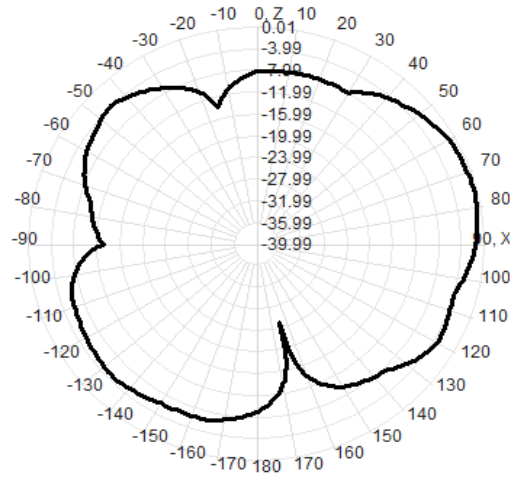

Frequency(MHZ):2430

Antenna Polarity: Horizontal

Maximum Value(dBi):-0.68

Average Gain(dBi):-3.01

Minimum Gain(dBi):-26.54

2.2 Vertical

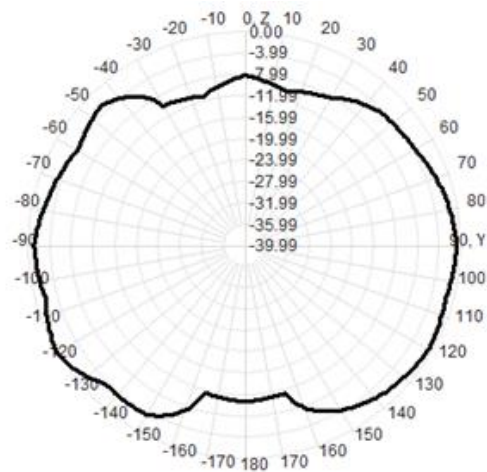

Frequency(MHZ):2430

Antenna Polarity: Vertical

Maximum Value(dBi):0.00

Average Gain(dBi):-0.89

Minimum Gain(dBi):-11.08

3. Mainantenna:2480MHz

3.1 Horizontal

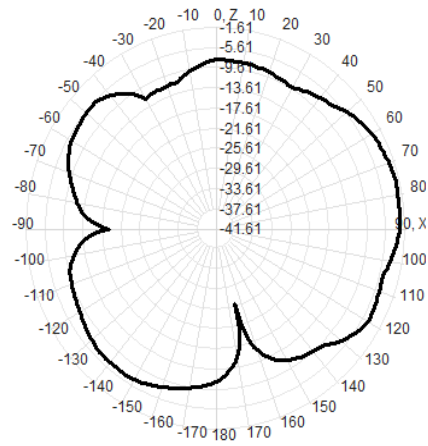

Frequency(MHZ):2480

Antenna Polarity: Horizontal

Maximum Value(dBi):-2.65

Average Gain(dBi):-5.08

Minimum Gain(dBi):-26.93

3.2 Vertical

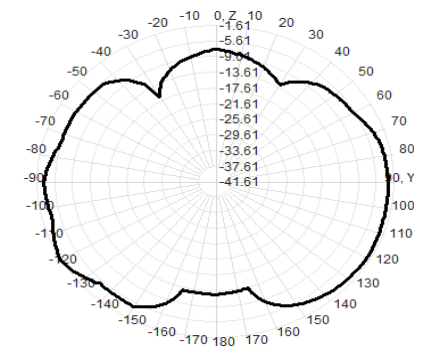

Frequency(MHZ):2480

Antenna Polarity: Vertical

Maximum Value(dBi):-1.61

Average Gain(dBi):-3.30

Minimum Gain(dBi):-16.98