

Hi!

Let's get started.

Sonic Blast

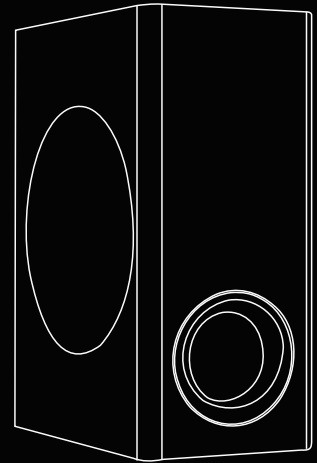

Model No.: HD-112LD-F

What's you get	03
Product Structure	04
Sound Bar main unit	4.1
Subwoofer	4.2
Remote	4.3
Place your Sound Bar and Subwoofer	05
Place on the cabinet	5.1
Mount the sound bar on the wall	5.2
How to use?	06
Connecting Electrical Power	6.1
Soundbar connect to subwoofer	6.2
Connecting with a TV	6.3
Connect to your TV	07
Optical	7.1
TV-ARC	7.2
Coaxial	7.3
AUX	7.4
External speaker and PCM settings	08
Pair with your BT device	09
USB	10
Specification	11
FAQ	12

1. Read these Instructions.
 2. Keep these Instructions.
 3. Heed all Warnings.
 4. Follow all instructions.
 5. Do not use this apparatus near water.
 6. Clean only with a dry cloth.
 7. Do not block any ventilation openings. Install in accordance with the manufacturer's instructions.
 8. Do not install near any heat sources such as radiators, heat registers, stoves, or other apparatus (including amplifiers) that produce heat.
 9. Do not defeat the safety purpose of the polarized or grounding - type plug. A polarized plug has two blades with one wider than the other. A grounding type plug has two blades and a third grounding prong. The wide blade or the third prong are provided for your safety. When the provided plug does not fit into your outlet, consult an electrician for replacement of the obsolete outlet.
 10. Protect the power cord from being walked on or pinched particularly at plugs, convenience receptacles, and the point where they exit from the apparatus.
 11. Only use attachments/accessories specified by the manufacturer.
-
12.  Use only with a cart, stand, tripod, bracket, or table specified by the manufacturer, or sold with the apparatus. When a cart is used, use caution when moving the cart/apparatus combination to avoid injury from tip-over.
-

13. Unplug this apparatus during lightning storms or when unused for long periods of time.
14. Refer all servicing to qualified service personnel. Servicing is required when the apparatus has been damaged in any way, such as power-supply cord or plug is damaged, liquid has been spilled or objects have fallen into the apparatus, the apparatus has been exposed to rain or moisture, does not operate normally, or has been dropped.

Special note: When placing your unit on a lacquered or natural finish, protect your furniture with a cloth or other protective material.

FCC Warnings

WARNING: Changes or modifications to this unit not expressly approved by the party responsible for compliance could void the user's authority to operate the equipment.

This device complies with part 15 of the FCC Rules. Operation is subject to the following two conditions: (1) This device may not cause harmful interference, and (2) this device must accept any interference received, including interference that may cause undesired operation.

NOTE: This equipment has been tested and found to comply with the limits for a Class B digital device, pursuant to Part 15 of the FCC Rules. These limits are designed to provide reasonable protection against harmful interference in a residential installation. This equipment generates, uses, and can radiate radio frequency energy and, if not installed and used in accordance with the instructions, may cause harmful interference to radio communications. However, there is no guarantee that interference will not occur in a particular installation. If this equipment does cause harmful interference to radio or television reception, which can be determined by turning the equipment off and on, the user is encouraged to try to correct the interference by one or more of the following measures:

- Reorient or relocate the receiving antenna.
- Increase the separation between the equipment and receiver.
- Connect the equipment into an outlet on a circuit different from that to which the receiver is connected.
- Consult the dealer or an experienced radio/TV technician for help.

FCC Radiation Exposure Statement:

This equipment complies with FCC radiation exposure limits set forth for an uncontrolled environment. This equipment should be installed and operated with minimum distance 20cm between the radiator & your body.

Additional Warnings

The apparatus shall not be exposed to dripping or splashing and that no objects filled with liquids, such as vases, shall be placed on apparatus.

L'appareil ne doit pas être exposé aux écoulements ou aux éclaboussures et aucun objet ne contenant de liquide, tel qu'un vase, ne doit être placé sur l'objet.

Battery shall not be exposed to excessive heat such as sunshine, fire or the light.

Les piles ne doivent pas être exposées à de forte chaleur, tel qu'à la lumière du soleil, au feu ou autres choses de semblable.

Caution marking is located at the rear or bottom of the apparatus.
Attention marquage est situé sur le panneau arrière ou inférieur de l'unité.

The marking information is located at the rear or bottom of apparatus.
Le marquage est situé sur le panneau arrière ou inférieur de l'unité.



This symbol indicates that this product incorporates double insulation between hazardous mains voltage and user accessible parts.

What's you get

Make sure you read all the safety information before you use this product.



Soundbar

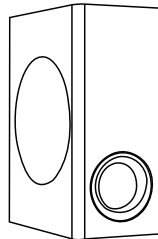

Subwoofer

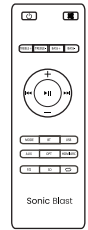

Remote control



Digital Optical cable



Stereo RCA to 3.5mm audio cable



Stereo 3.5mm to 3.5mm audio cable



Digital COAX cable



Power cable



Mount screws



User's guide

4.1 Sound Bar main unit

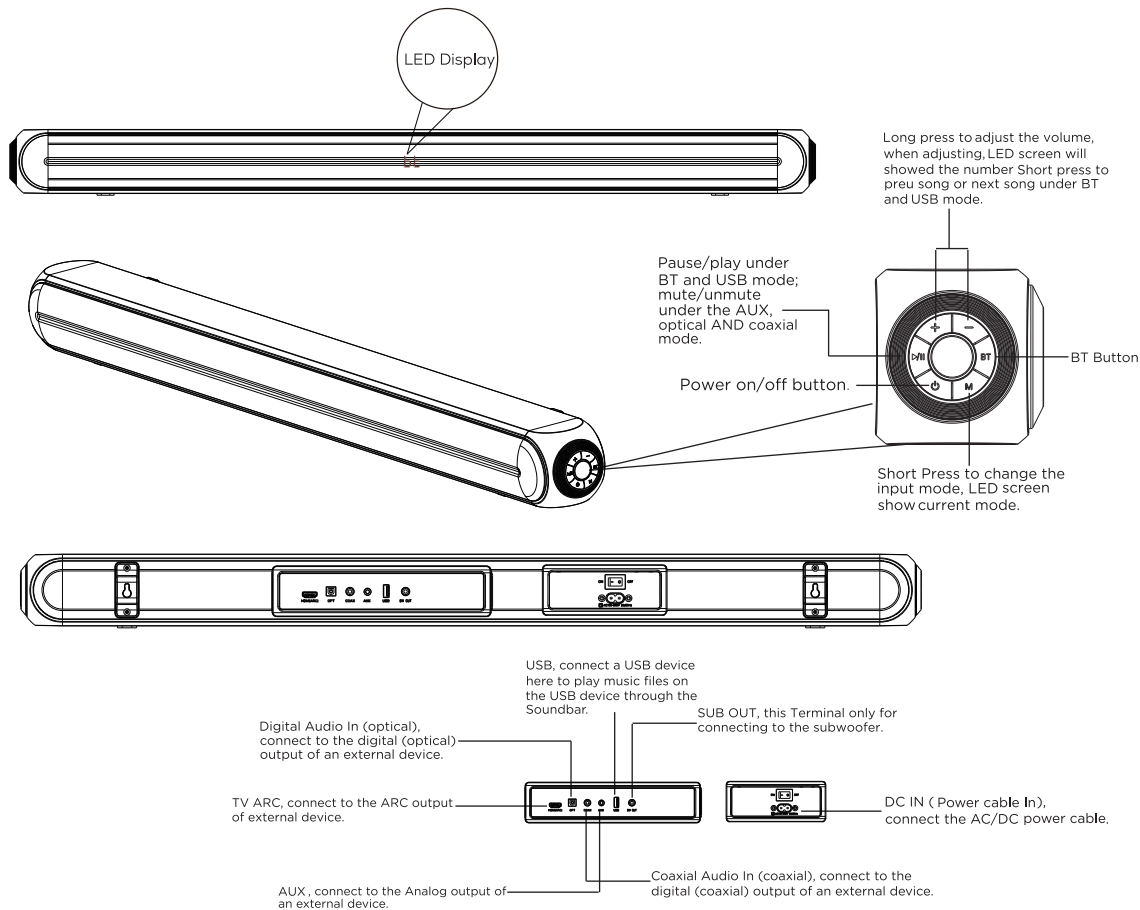



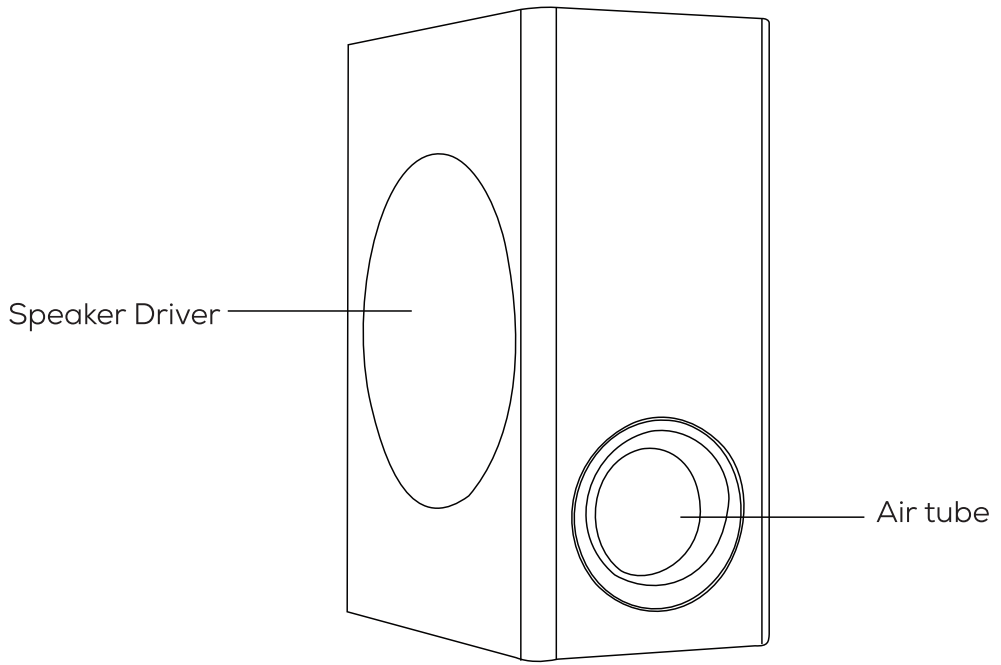



4.2 Subwoofer



4.3 Remote

Power the remote by inserting 2 pcs of AAA batteries (not supplied)

Botón	Función	Botón	Función
	Encendido / Apagado	MODE	Alternar entre BT/USB/AUX/OPT/COAX/HDMI(ARC)
	Mudo / Recuperar volumen	BT	Modo BT
TREBLE+	Aumenta agudos	USB	Modo USB
TREBLE-	Reduce agudos	AUX	Modo AUX
BASS +	Aumenta bajos	OPT	Modo Optico
BASS-	Reduce bajos	HDMI	Modo HDMI(ARC)
+	Aumenta volúmen	EQ	Alternar distintos EQ
-	Reduce volúmen	3D	3D envolvente on/off
	Pista anterior		Modos de repetición en USB
	Reproducir / Pausa		
	Pista Siguiente		

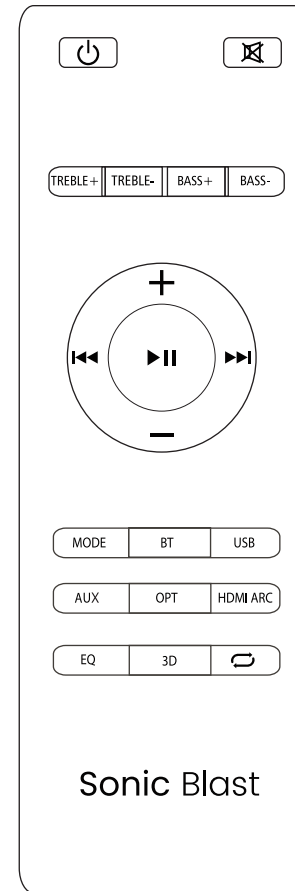

05 Place your Sound Bar and Subwoofer

5.1 Place on the cabinet

The ideal place to position the Sound Bar is centered underneath your TV.

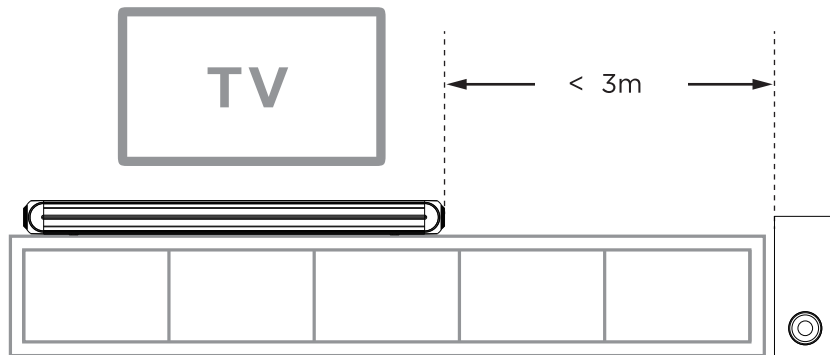

05 Place your Sound Bar and Subwoofer

5.2 Mount the sound bar on the wall

Tools & fixings required

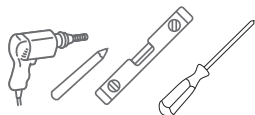

1/. Drill fitted with masonry drill bit 2/. Screwdriver 3/. Level Ruler
4/. Pencil

- Use the level ruler to mark two mounting holes with a pencil. Drill two screw holes at each marking on the wall. **1**
- Secure the supplied anchors and screws into the hole. Please make sure the screws are protruding 5mm in the wall. *Anchors are only required when mounting onto a solid wall. **2**
- Hang the sound bar on the fastening screws. **3**
- Gently push the sound bar down to lock and secure it in place. **4**

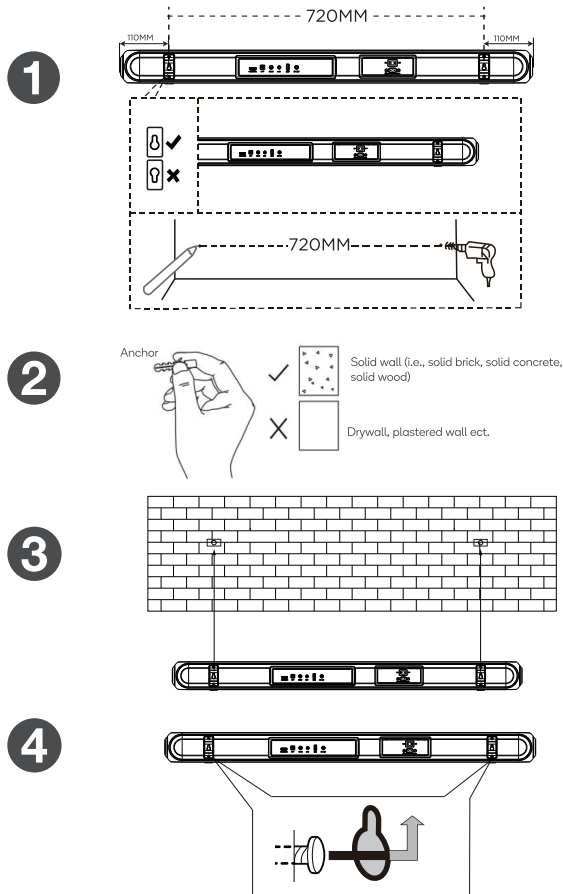

6.1 Connecting Electrical Power

1. Using the power adapter to connect the unit to electrical outlet in the figure
2. Press the power button to power on the Soundbar (LED screen will turn on)

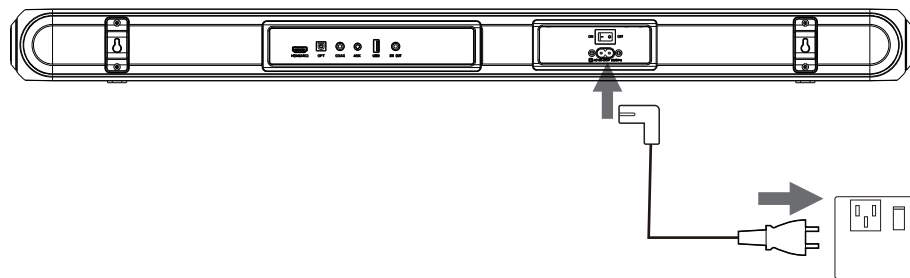

6.2 Soundbar connect to subwoofer

1. Insert the subwoofer plug into the SW port of the sound bar.

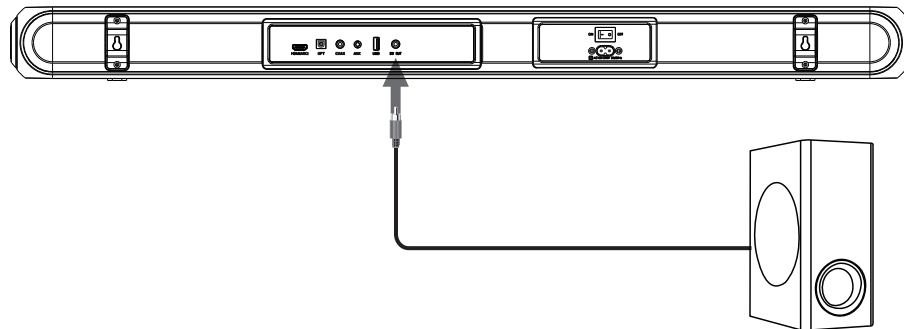

6.3 Connecting with a TV

There are 4 ways to connect your sound bar to the TV (listed in order that we recommend): Optical (refer to 7.1),TV ARC (refer to 7.2), and COAX (refer to 7.3),AUX (refer to 7.4) .

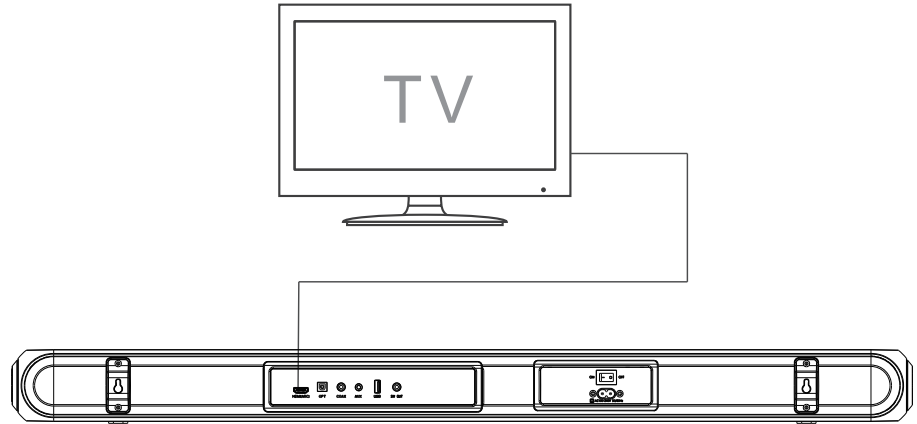

7.1 Optical

- Connect the Sound Bar with your TV through the supplied Optical cable.
- Select "OPT" on LED screen by pressing the "OPT" button on the remote.
- Play TV show to test the soundbar.

Note: If no sound or cracking noise, please change the TV audio output to external speaker and PCM. Saving the settings. (Refer to 08)

7.2 TV-ARC

- Connect the Sound Bar with your TV through an ARC cable.
- Select "ARC" on LED screen by pressing the "ARC" button on the remote.
- Play TV show to test the soundbar.

Note: If no sound or cracking noise, please set the TV audio output to external speaker (refer to 08), saving the setting. Then back to audio (sound setting) --- select expert setting --- digital audio output --- select TV-ARC (per some TV, please choose CEC, then activate the ARC), save the setting.

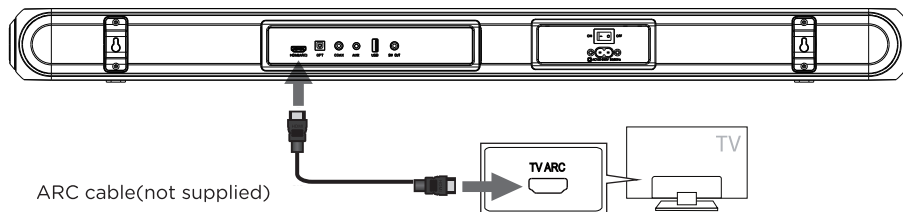
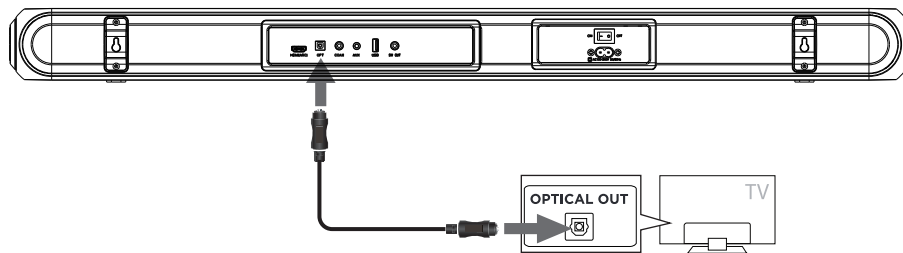

7.3 Coaxial

- Connect the Sound Bar with your TV through the Coaxial cable.
- Select "COA" on LED screen by pressing the "INPUT" button on the remote.
- Play TV show to test the soundbar.

Note: If no sound or cracking noise, please set your TV's audio output to external speaker and PCM. Saving the settings. (Refer to 08)

7.4 AUX

- Connect the Sound Bar with your TV through an AUX cable.
- Select "AUX" on LED screen by pressing the "INPUT" button on the remote.
- Play TV show to test the soundbar.

Note: 1.If no sound or cracking noise, please change the TV audio output to external speaker. Saving the settings. (Refer to 08)

2.You can use the 3.5mm to 3.5mm audio cable (not supplied) to connect or 3.5mm to RCA cable (supplied) to connect it. Choose only one connection from above it, it depends on your TV's audio output jack.

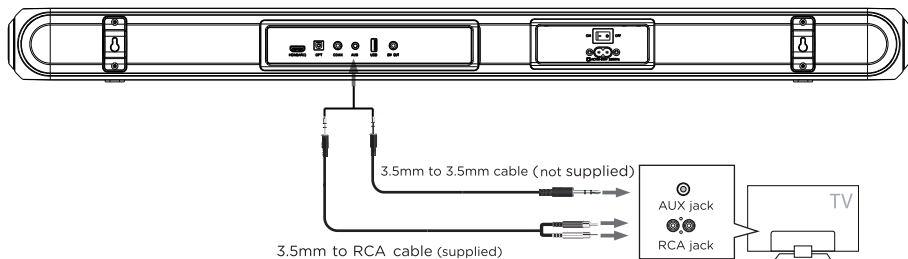
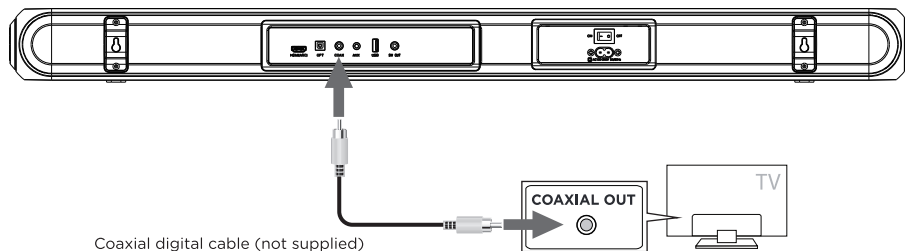

08 External speaker and PCM settings

Please note almost all the TV audio output is the analog signal and the internal speaker, but the optical cable and coaxial cable is the digital signal,so when you want to hook up the soundbar on your TV through optical or coaxial cable, you must change the TV audio output to digital output(PCM or SPDIF)and external speaker.

- 1 : How to set PCM on your TV
 - 1.Enter your TV's settings menu.
 - 2.Select the Audio or sound settings option.
 - 3.Select the audio out or digital out setting.
 - 4.Change setting to PCM.(some TVs called SPDIF)
- 2: How to disable the TV internal speaker
 - 1.Enter your TV's settings menu.
 - 2.Select the Audio or sound settings option.
 - 3.Select the TV speaker.
 - 4.Select the Extenral speaker.(or disable the TV speaker)
- 3: Please kindly make sure you have changed the TV audio output correctly, if TV still no sound, or output crack sound, or popping sound, please kindly share your TV brand, model number,and order ID with us through service mail:support@Sonic-Blast.com.cn , so we can guide you to fix the problem.
- 4: If you do not know how to set the TV audio to PCM, please kindly refer to your TV manual or call the TV manufacturer for help.

Pair with your BT device

You can stream music from your mobile device via Bluetooth.

- Select "BT" on LED screen by pressing the "BT" button on the remote.
- Turn on the BT device and select "SonicBlast-112LD" from the list, connect it.
- Play music to test it.

Note: Bluetooth wireless range reaches 30 feet in the open area.

If you want to pair with another device, please refer to the steps above.



BT Device

1. Connect your USB device to the USB jack on the Soundbar.
2. Select “USB” on LED screen by pressing the “INPUT” button on the remote.
3. Play music files from the USB device through the Soundbar.

Note: Only for USB flash drive to play MP3 music and update firmware, can not compatible with other usb devices.

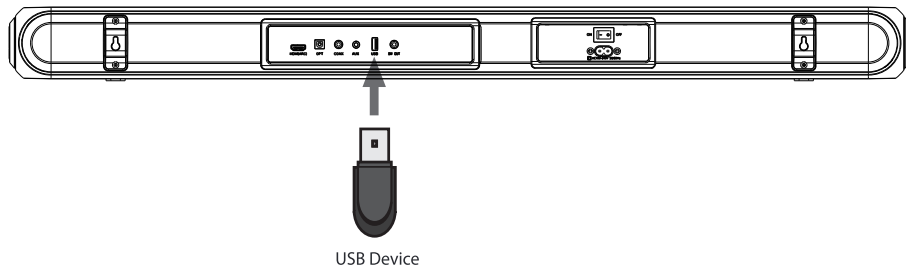

Modes:	Music, Movie,Game, and News.
Power Supply:	AC In 100-240V, 50Hz/60Hz
Input Volt:	100V-240V
LED Display:	Yes
Sound Bar:	Four Full Rang Drivers +5.25" Subwoofer
Inputs:	One AUX Stereo Audio, One USB, One ARC, BT (Wireless), One Optical, One Coaxial
Sound Pressure Level (System):	110 dB
Frequency Response (System):	50 Hz to 20KHz
Compliances:	FCC
Place of Origin:	China
Soundbar Dimension:	31.5"x 2.95 " x 3.15"
Subwoofer Dimension:	8.6 "x 5.9 "x 13.3 "

No Sound	<ol style="list-style-type: none"> 1. Please check if the soundbar is consistent with the input mode of Sound Source by following the manual. 2. Press the Volume+ button on the remote or soundbar to volume up. 3. Please check the output devices if the output of sound source is working. 	Please make sure all the soundbar ports are input ports and all the connected devices are audio output.
No sound when TV is connected with optical.	<ol style="list-style-type: none"> 1. Set up the optical output. 2. Set up the audio output format--PCM. 3. Adjust to optical mode, and the Led indicates white lightning. 4. Please check if the optical is connected with TV effectively. 5. Volume up the soundbar. 	Please take out the transparent antidust caps on two sides of optical. One side of optical indicates the white lightning when TV is connected well, and then plug the other side of optical into the optical port of soundbar.
Devices can't connect with BT	<ol style="list-style-type: none"> 1. Select "BT" on LED screen by pressing the "BT" button on the remote. 2. Reboot the cellphone or bluetooth devices, search again. 3. Please make sure the soundbar is disconnected with other BT devices, shut off and try again. 4. Please check if there is strong interfering signal around, such as: WIFI, 2.4G; try to use in other space. 5. Please try to use other BT devices to test if the BT device has problem of its own. 	The BT is only connected with one device, other devices cant search it when it has connected.
The distance of BT is short or on and off	<ol style="list-style-type: none"> 1. Please check if there is strong interfering signal around, such as: WIFI, 2.4G; try to use in other space. 2. Reboot the cellphone or BT devices, then reconnect. 3. Please make sure there is no obstacle between the soundbar and BT device in case of blocking the signal. 4. Power off the soundbar and then reboot. 	The working distance of BT is 10m (empty place).

The remote is not working	<ol style="list-style-type: none"> 1. Please check if the positive and negative of battery is right. (There is noted on the battery's compartment) 2. Please check if the receiving location is blocked beside the LED on soundbar. 3. The working distance of remote is 6-8m (empty place). 	Please make sure all the soundbar ports are input ports and all the connected devices are audio output.
The sound is low or bad	<ol style="list-style-type: none"> 1. Please make sure if the volume of output device is big. 2. Please try to play with other devices to test if the working device has problem of its own. 3. The product is designed for home, it would be much better if the space is moderate. 	The location of soundbar can affect your experience in some extent.
The sound is inconsistent with the sound of TV	Please set up and shut off the sound of TV.	Check the TV's manual.
BT can't be connected	<ol style="list-style-type: none"> 1. Check if the Sound Bar is connected with the third BT device. 2. Be sure that there are no solid obstructions between the Sound Bar and source device. (Within 30 feet) 3. Press and hold BT button on remote for 3 seconds, and connect it again. 	LED screen keeping display BT.
No sound or crack sound from streaming video APP	Please note the streaming video APP default audio if Dolby or DTS, such as Netflix, Youtube, Amazon prime video, Hulu and HBO, but this soundbar do not support the Dolby and DTS.	<p>Please kindly disable the Dolby and DTS on your app. here is the method for Netflix in below:</p> <p>Step 1, launch the Netflix APP</p> <p>Step 2, Select the TV show or Movie</p> <p>Step 3, While your TV show or movie is playing, press the Down arrow on your remote</p> <p>Step 4, Select Audio&Subtitles, disable the Dolby and DTS, save settings</p> <p>Step 5, play the video to test sound</p> <p>Kindly note the method may differ according to your device, more method, please visit this link: support@Sonic-Blast.com.cn</p>

Sound Bar

FCC ID: 2ASKO-HD-112LD-F



This device complies with part 15 of the FCC Rules. Operation is subject to the following two conditions: (1) this device may not cause harmful interference, and (2) this device must accept any interference received, including interference that may cause undesired operation

Thanks for reading!