

TEST REPORT

Test report no.: 1-6031/18-01-07



BNetzA-CAB-02/21-102

Testing laboratory

CTC advanced GmbH

Untertuerkheimer Strasse 6 – 10
66117 Saarbruecken / Germany
Phone: + 49 681 5 98 - 0
Fax: + 49 681 5 98 - 9075
Internet: <http://www.ctcadvanced.com>
e-mail: mail@ctcadvanced.com

Accredited Testing Laboratory:

The testing laboratory (area of testing) is accredited according to DIN EN ISO/IEC 17025 (2005) by the Deutsche Akkreditierungsstelle GmbH (DAkkS). The accreditation is valid for the scope of testing procedures as stated in the accreditation certificate with the registration number: D-PL-12076-01-03

Applicant

Broadband TelCom Power Inc.
1719 S. Grand Ave.
CA 92705 Santa Ana / US
Phone: -/-
Contact: Larry Hayashigawa
e-mail: larryh@btcpower.com
Phone: +1 (714) 259-7996

Manufacturer

Leipzig Electronic Systems GmbH
Hertzstrasse 2
04329 Leipzig / GERMANY

Test standard/s

FCC - Title 47 CFR Part 15	FCC - Title 47 of the Code of Federal Regulations; Chapter I; Part 15 - Radio frequency devices
RSS - 210 Issue 9	Spectrum Management and Telecommunications Radio Standards Specification - Licence-Exempt Radio Apparatus: Category I Equipment
RSS - Gen Issue 4	Spectrum Management and Telecommunications Radio Standards Specifications - General Requirements and Information for the Certification of Radio Apparatus

For further applied test standards please refer to section 3 of this test report.

Test Item

Kind of test item: Charging box for electric vehicle
Model name: eBox professional
FCC ID: 2ASKCACCU205
IC: TBD
Frequency: 13.56 MHz
Technology tested: RFID
Antenna: Integrated antenna
Power supply: 93.5 V to 126.5 V AC by mains
Temperature range: -20°C to +55°C



This test report is electronically signed and valid without handwritten signature. For verification of the electronic signatures, the public keys can be requested at the testing laboratory.

Test report authorized:

Christoph Schneider
Lab Manager
Radio Communications & EMC

Test performed:

Tobias Wittenmeier
Testing Manager
Radio Communications & EMC

1 Table of contents

1	Table of contents	2
2	General information	3
2.1	Notes and disclaimer	3
2.2	Application details.....	3
2.3	Test laboratories sub-contracted	3
3	Test standard/s and references	4
4	Test environment.....	5
5	Test item.....	5
5.1	General description.....	5
5.2	Additional information	5
6	Description of the test setup.....	6
6.1	Shielded semi anechoic chamber.....	7
6.2	Shielded fully anechoic chamber	8
6.3	Frequency error	9
7	Sequence of testing	10
7.1	Sequence of testing radiated spurious 9 kHz to 30 MHz.....	10
7.2	Sequence of testing radiated spurious 30 MHz to 1 GHz.....	11
8	Measurement uncertainty	12
9	Summary of measurement results	13
10	Additional comments	13
11	Measurement results	14
11.1	Occupied bandwidth.....	14
11.2	Field strength of the fundamental	16
11.3	Field strength of the harmonics and spurious	17
11.4	Conducted limits	21
11.5	Frequency error	24
12	Observations	30
Annex A	Glossary.....	31
Annex B	Document history	32
Annex C	Accreditation Certificate	32

2 General information

2.1 Notes and disclaimer

The test results of this test report relate exclusively to the test item specified in this test report. CTC advanced GmbH does not assume responsibility for any conclusions and generalizations drawn from the test results with regard to other specimens or samples of the type of the equipment represented by the test item.

The test report may only be reproduced or published in full. Reproduction or publication of extracts from the report requires the prior written approval of CTC advanced GmbH.

The testing service provided by CTC advanced GmbH has been rendered under the current "General Terms and Conditions for CTC advanced GmbH".

CTC advanced GmbH will not be liable for any loss or damage resulting from false, inaccurate, inappropriate or incomplete product information provided by the customer.

Under no circumstances does the CTC advanced GmbH test report include any endorsement or warranty regarding the functionality, quality or performance of any other product or service provided.

Under no circumstances does the CTC advanced GmbH test report include or imply any product or service warranties from CTC advanced GmbH, including, without limitation, any implied warranties of merchantability, fitness for purpose, or non-infringement, all of which are expressly disclaimed by CTC advanced GmbH.

All rights and remedies regarding vendor's products and services for which CTC advanced GmbH has prepared this test report shall be provided by the party offering such products or services and not by CTC advanced GmbH. In no case this test report can be considered as a Letter of Approval.

This test report is electronically signed and valid without handwritten signature. For verification of the electronic signatures, the public keys can be requested at the testing laboratory.

2.2 Application details

Date of receipt of order:	2018-06-25
Date of receipt of test item:	2018-06-26
Start of test:	2018-07-02
End of test:	2018-07-02
Person(s) present during the test:	-/-

2.3 Test laboratories sub-contracted

None

3 Test standard/s and references

Test standard	Date	Description
FCC - Title 47 CFR Part 15		FCC - Title 47 of the Code of Federal Regulations; Chapter I; Part 15 - Radio frequency devices
RSS - 210 Issue 9	August 2016	Spectrum Management and Telecommunications Radio Standards Specification - Licence-Exempt Radio Apparatus: Category I Equipment
RSS - Gen Issue 5	April 2018	General Requirements for Compliance of Radio Apparatus

Guidance	Version	Description
ANSI C63.4-2014	-/-	American national standard for methods of measurement of radio-noise emissions from low-voltage electrical and electronic equipment in the range of 9 kHz to 40 GHz
ANSI C63.10-2013	-/-	American national standard of procedures for compliance testing of unlicensed wireless devices

4 Test environment

Temperature	:	T_{nom} T_{max} T_{min}	+20 °C during room temperature tests +55 °C during high temperature tests -20 °C during low temperature tests
Relative humidity content	:		55 %
Barometric pressure	:		1021 hpa
Power supply	:	V_{nom} V_{max} V_{min}	110 V AC by mains 126.5 V 93.5 V

5 Test item

5.1 General description

Kind of test item	:	Charging box for electric vehicle
Type identification	:	eBox professional
HMN	:	eBox professional
PMN	:	eBox professional
HVIN	:	-/-
FVIN	:	Rel 01.00 / ARN14
HW hardware status	:	-/-
SW software status	:	App 1.x
FW firmware status	:	Router Core 3.x
Frequency band	:	13.56 MHz
Type of modulation	:	ASK
Number of channels	:	1
Antenna	:	Integrated antenna
Power supply	:	93.5 V to 126.5 V AC by mains
Temperature range	:	-20°C to +55°C

5.2 Additional information

The content of the following annexes is defined in the QA. It may be that not all of the listed annexes are necessary for this report, thus some values in between may be missing.

Test setup and EUT photos are included in test report:

- 1-6031/18-01-01_AnnexA
- 1-6031/18-01-01_AnnexB
- 1-6031/18-01-01_AnnexD

6 Description of the test setup

Typically, the calibrations of the test apparatus are commissioned to and performed by an accredited calibration laboratory. The calibration intervals are determined in accordance with the DIN EN ISO/IEC 17025. In addition to the external calibrations, the laboratory executes comparison measurements with other calibrated test systems or effective verifications. Weekly chamber inspections and range calibrations are performed. Where possible, RF generating and signaling equipment as well as measuring receivers and analyzers are connected to an external high-precision 10 MHz reference (GPS-based or rubidium frequency standard).

In order to simplify the identification of the equipment used at some special tests, some items of test equipment and ancillaries can be provided with an identifier or number in the equipment list below (Lab/Item).

Agenda: Kind of Calibration

k	calibration / calibrated	EK	limited calibration
ne	not required (k, ev, izw, zw not required)	zw	cyclical maintenance (external cyclical maintenance)
ev	periodic self verification	izw	internal cyclical maintenance
Ve	long-term stability recognized	g	blocked for accredited testing
v/k!	Attention: extended calibration interval		
NK!	Attention: not calibrated	*)	next calibration ordered / currently in progress

6.1 Shielded semi anechoic chamber

The radiated measurements are performed in vertical and horizontal plane in the frequency range from 30 MHz to 1 GHz in semi-anechoic chambers. The EUT is positioned on a non-conductive support with a height of 0.80 m above a conductive ground plane that covers the whole chamber. The receiving antennas are conform to specifications ANSI C63. These antennas can be moved over the height range between 1.0 m and 4.0 m in order to search for maximum field strength emitted from EUT. The measurement distances between EUT and receiving antennas are indicated in the test setups for the various frequency ranges. For each measurement, the EUT is rotated in all three axes until the maximum field strength is received. The wanted and unwanted emissions are received by spectrum analyzers where the detector modes and resolution bandwidths over various frequency ranges are set according to requirement ANSI C63.

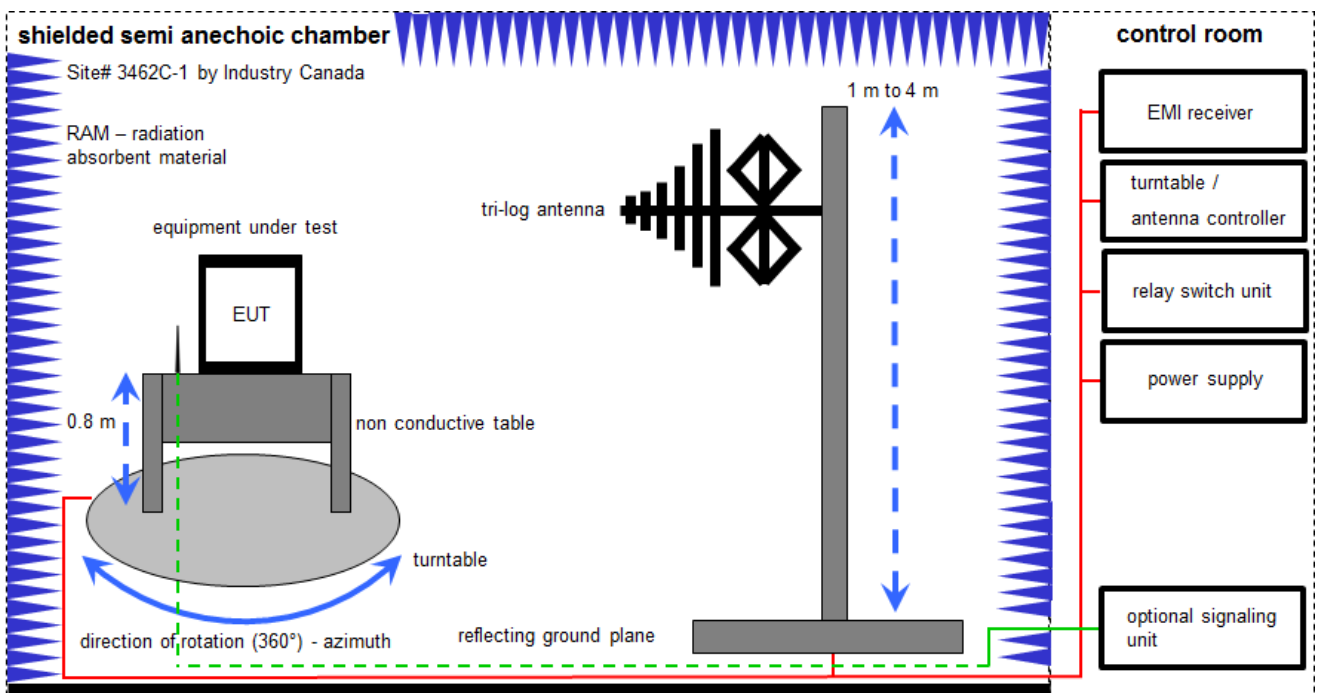

Measurement distance: tri-log antenna 10 meter

$$FS = UR + CL + AF$$

(FS-field strength; UR-voltage at the receiver; CL-loss of the cable; AF-antenna factor)

Example calculation:

$$FS [dB\mu V/m] = 12.35 [dB\mu V/m] + 1.90 [dB] + 16.80 [dB/m] = 31.05 [dB\mu V/m] (35.69 \mu V/m)$$

Equipment table:

No.	Lab / Item	Equipment	Type	Manufact.	Serial No.	INV. No Cetecom	Kind of Calibration	Last Calibration	Next Calibration
1	A	Switch-Unit	3488A	HP	2719A14505	300000368	ev	-/-	-/-
2	A	EMI Test Receiver	ESCI 3	R&S	100083	300003312	k	08.03.2017	08.03.2018
3	A	Antenna Tower	Model 2175	ETS-Lindgren	64762	300003745	izw	-/-	-/-
4	A	Positioning Controller	Model 2090	ETS-Lindgren	64672	300003746	izw	-/-	-/-
5	A	Turntable Interface-Box	Model 105637	ETS-Lindgren	44583	300003747	izw	-/-	-/-
6	A	TRILOG Broadband Test-Antenna 30 MHz - 3 GHz	VULB9163	Schwarzbeck	295	300003787	k	25.04.2016	25.04.2018

6.2 Shielded fully anechoic chamber

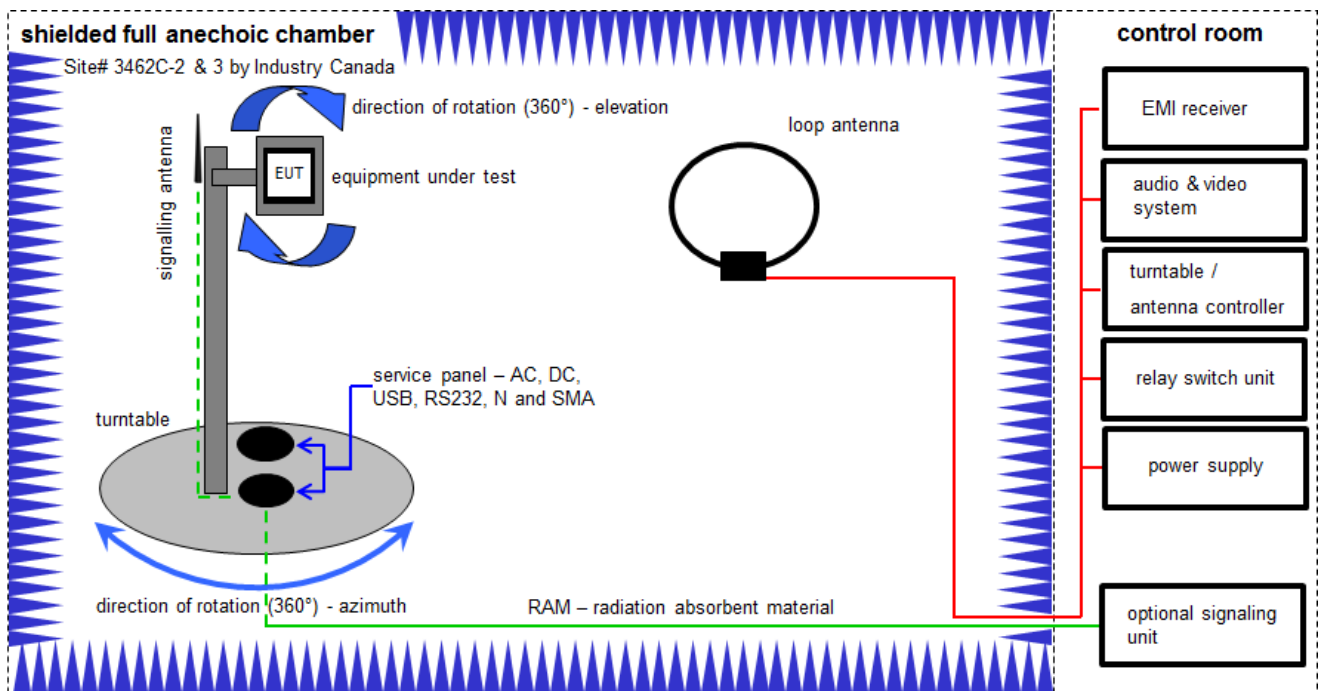

Measurement distance: loop antenna 3 meter / 1 meter

$$FS = UR + CA + AF$$

(FS-field strength; UR-voltage at the receiver; CA-loss of the signal path; AF-antenna factor)

Example calculation:

$$FS [dB\mu V/m] = 40.0 [dB\mu V/m] + (-35.8) [dB] + 32.9 [dB/m] = 37.1 [dB\mu V/m] (71.61 \mu V/m)$$

Equipment table:

No.	Lab / Item	Equipment	Type	Manufacturer	Serial No.	INV. No.	Kind of Calibration	Last Calibration	Next Calibration
1	A	Active Loop Antenna 9 kHz to 30 MHz	6502	EMCO	2210	300001015	k	07.07.2017	06.07.2019
2	A	Anechoic chamber	FAC 3/5m	MWB / TDK	87400/02	300000996	ev	-/-	-/-
3	A	Switch / Control Unit	3488A	HP	*	300000199	ne	-/-	-/-
4	A	EMI Test Receiver 20Hz- 26,5GHz	ESU26	R&S	100037	300003555	k	20.12.2017	19.12.2018
5	A	4U RF Switch Platform	L4491A	Agilent Technologies	MY50000037	300004509	ne	-/-	-/-
6	A	NEXIO EMV-Software	BAT EMC V3.16.0.49	EMCO		300004682	ne	-/-	-/-
7	A	PC	ExOne	F+W		300004703	ne	-/-	-/-

6.3 Frequency error

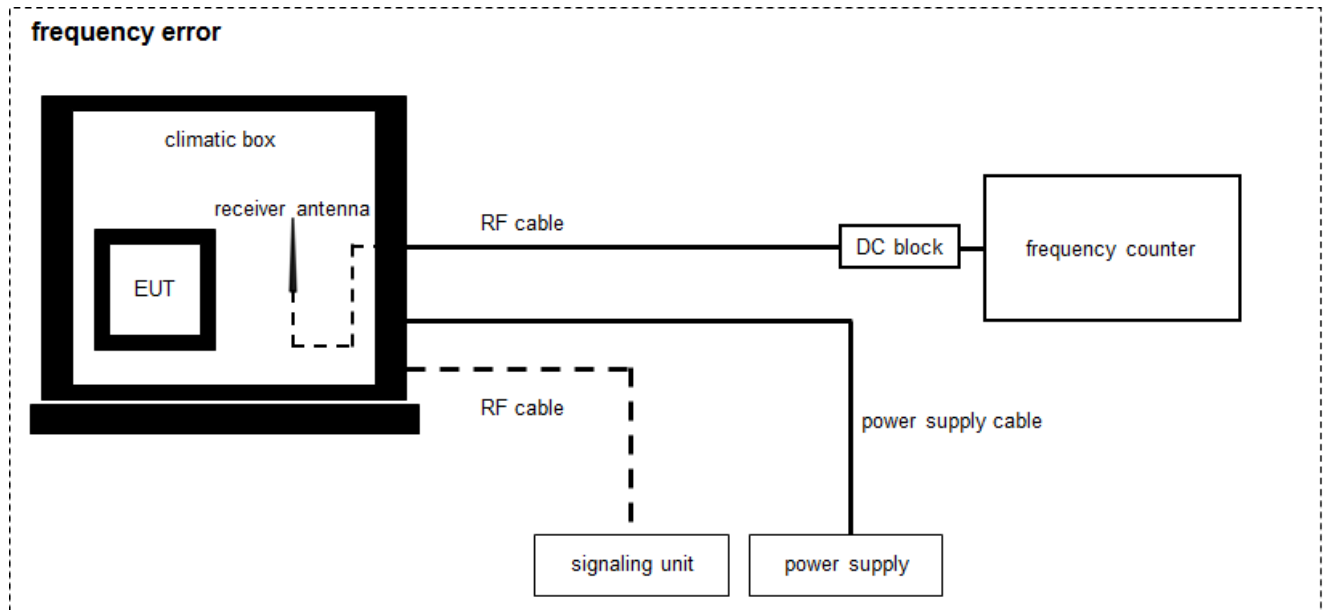

Equipment table:

No.	Lab / Item	Equipment	Type	Manufacturer	Serial No.	INV. No.	Kind of Calibration	Last Calibration	Next Calibration
1	A	Signal- and Spectrum Analyzer	FSW26	R&S	101455	300004528	k	20.12.2017	19.12.2018
2	A	Loop Antenna		ZEG TS Steinfurt		400001208	ev	-/-	-/-
3	A	RF Cable BNC	RG58	Huber & Suhner		400001209	ev	-/-	-/-
4	A	Climatic Box	VT 4011	Voetsch Industrietechnik	58566230600010	300005363	ev	01.06.2017	31.05.2019

7 Sequence of testing

7.1 Sequence of testing radiated spurious 9 kHz to 30 MHz

Setup

- The equipment is set up to simulate normal operation mode as described in the user manual or defined by the manufacturer.
- If the EUT is a tabletop system, it is placed on a table with 0.8 m height.
- If the EUT is a floor standing device, it is placed directly on the turn table.
- Auxiliary equipment and cables are positioned to simulate normal operation conditions as described in ANSI C 63.4.
- The AC power port of the EUT (if available) is connected to a power outlet below the turntable.
- Measurement distance is 3 m (see ANSI C 63.4) – see test details.
- EUT is set into operation.

Premeasurement*

- The turntable rotates from 0° to 315° using 45° steps.
- The antenna height is 1 m.
- At each turntable position the analyzer sweeps with positive-peak detector to find the maximum of all emissions.

Final measurement

- Identified emissions during the pre-measurement are maximized by the software by rotating the turntable from 0° to 360°.
- Loop antenna is rotated about its vertical axis for maximum response at each azimuth about the EUT. (For certain applications, the loop antenna plane may also need to be positioned horizontally at the specified distance from the EUT)
- The final measurement is done in the position (turntable and elevation) causing the highest emissions with quasi-peak (as described in ANSI C 63.4).
- Final levels, frequency, measuring time, bandwidth, turntable position, correction factor, margin to the limit and limit will be recorded. A plot with the graph of the premeasurement and the limit is stored.

*)Note: The sequence will be repeated three times with different EUT orientations.

7.2 Sequence of testing radiated spurious 30 MHz to 1 GHz

Setup

- The equipment is set up to simulate normal operation mode as described in the user manual or defined by the manufacturer.
- If the EUT is a tabletop system, a table with 0.8 m height is used, which is placed on the ground plane.
- If the EUT is a floor standing device, it is placed on the ground plane with insulation between both.
- Auxiliary equipment and cables are positioned to simulate normal operation conditions as described in ANSI C 63.4.
- The AC power port of the EUT (if available) is connected to a power outlet below the turntable.
- Measurement distance is 10 m or 3 m (see ANSI C 63.4) – see test details.
- EUT is set into operation.

Premeasurement

- The turntable rotates from 0° to 315° using 45° steps.
- The antenna is polarized vertical and horizontal.
- The antenna height changes from 1 m to 3 m.
- At each turntable position, antenna polarization and height the analyzer sweeps three times in peak to find the maximum of all emissions.

Final measurement

- The final measurement is performed for at least six highest peaks according to the requirements of the ANSI C63.4.
- Based on antenna and turntable positions at which the peak values are measured the software maximize the peaks by changing turntable position $\pm 45^\circ$ and antenna height between 1 and 4 m.
- The final measurement is done with quasi-peak detector (as described in ANSI C 63.4).
- Final levels, frequency, measuring time, bandwidth, antenna height, antenna polarization, turntable angle, correction factor, margin to the limit and limit are recorded. A plot with the graph of the premeasurement with marked maximum final results and the limit is stored.

8 Measurement uncertainty

Measurement uncertainty	
Test case	Uncertainty
Occupied bandwidth	± used RBW
Field strength of the fundamental	± 3 dB
Field strength of the harmonics and spurious	± 3 dB
Receiver spurious emissions and cabinet radiations	± 3 dB
Conducted limits	± 2.6 dB

9 Summary of measurement results

<input checked="" type="checkbox"/>	No deviations from the technical specifications were ascertained
<input type="checkbox"/>	There were deviations from the technical specifications ascertained
<input type="checkbox"/>	This test report is only a partial test report. The content and verdict of the performed test cases are listed below.

TC Identifier	Description	Verdict	Date	Remark
RF-Testing	CFR Part 15 RSS 210 Issue 9 RSS Gen Issue 5	See table!	2019-04-16	-/-

Test specification clause	Test case	Temperature conditions	Power source conditions	C	NC	NA	NP	Remark
RSS Gen Issue 5	Occupied bandwidth	Nominal	Nominal	<input checked="" type="checkbox"/>	<input type="checkbox"/>	<input type="checkbox"/>	<input type="checkbox"/>	-/-
§ 15.225 (a) RSS 210 Issue 9	Field strength of the fundamental	Nominal	Nominal	<input checked="" type="checkbox"/>	<input type="checkbox"/>	<input type="checkbox"/>	<input type="checkbox"/>	-/-
§ 15.209 & § 15.225 (b-d)	Field strength of the harmonics and spurious	Nominal	Nominal	<input checked="" type="checkbox"/>	<input type="checkbox"/>	<input type="checkbox"/>	<input type="checkbox"/>	-/-
§ 15.109	Receiver spurious emissions and cabinet radiations	Nominal	Nominal	<input type="checkbox"/>	<input type="checkbox"/>	<input checked="" type="checkbox"/>	<input type="checkbox"/>	-/-
§15.107 §15.207	Conducted limits	Nominal	Nominal	<input checked="" type="checkbox"/>	<input type="checkbox"/>	<input type="checkbox"/>	<input type="checkbox"/>	-/-
§ 15.225 (e) RSS 210 Issue 9	Frequency tolerance	Normal & extreme conditions	Normal & extreme conditions	<input checked="" type="checkbox"/>	<input type="checkbox"/>	<input type="checkbox"/>	<input type="checkbox"/>	-/-

Note:

- C Compliant
- NC Not compliant
- NA Not applicable
- NP Not performed

10 Additional comments

Reference documents: None

Special test descriptions: None

Configuration descriptions: None

11 Measurement results

11.1 Occupied bandwidth

Measurement:

The emission bandwidth (x dB) is defined as the frequency range between two points, one above and one below the carrier frequency, at which the spectral density of the emission is attenuated x dB below the maximum in-band spectral density of the modulated signal.

Measurement parameters	
Detector:	Peak
Resolution bandwidth:	1 % – 5 % of the occupied bandwidth
Video bandwidth:	≥ 3x RBW
Trace mode:	Max hold
Analyser function:	99 % power function
Used equipment:	See chapter 6.3
Measurement uncertainty:	See chapter 8

Limit:

IC
for RSP-100 test report coversheet only

Result:

99% emission bandwidth
831.767 kHz

Plot:

Plot 1: 99 % emission bandwidth

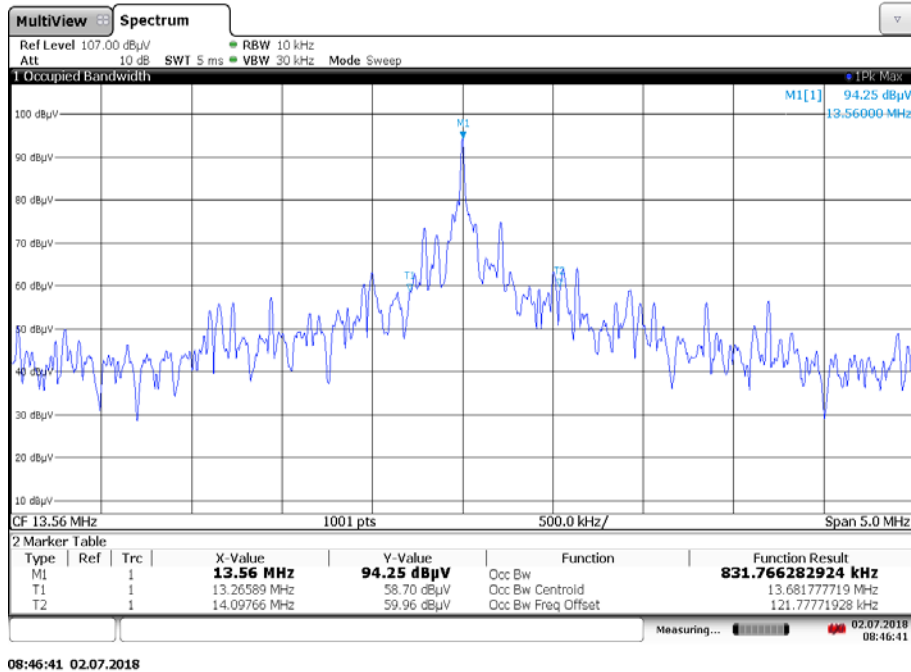

11.2 Field strength of the fundamental

Measurement:

The maximum detected field strength for the carrier signal.

Measurement parameters	
Detector:	Quasi peak / peak (worst case)
Resolution bandwidth:	120 kHz
Video bandwidth:	≥ 3x RBW
Trace mode:	Max hold
Used equipment:	See chapter 6.2
Measurement uncertainty:	See chapter 8

Limit:

FCC & IC		
Frequency (MHz)	Field strength (µV/m)	Measurement distance (m)
13.553 to 13.567	15,848 (84 dBµV/m)	30

Recalculation:

According to ANSI C63.10		
Frequency	Formula	Correction value
13.56 MHz	$FS_{\text{limit}} = FS_{\text{max}} - 40 \log\left(\frac{d_{\text{nearfield}}}{d_{\text{measure}}}\right) - 20 \log\left(\frac{d_{\text{limit}}}{d_{\text{nearfield}}}\right)$ <p> FS_{limit} is the calculation of field strength at the limit distance, expressed in dBµV/m FS_{max} is the measured field strength, expressed in dBµV/m $d_{\text{nearfield}}$ is the $\lambda/2\pi$ distance d_{measure} is the distance of the measurement point from EUT d_{limit} is the reference limit distance </p>	-21.4 from 3m to 30m

Result:

Field strength of the fundamental		
Frequency	13.56 MHz	
Distance	@ 3 m	@ 30 m
Measured / calculated value	30.94 dBµV/m	9.54 dBµV/m

11.3 Field strength of the harmonics and spurious

Measurement:

The maximum detected field strength for the harmonics and spurious.

Measurement parameters	
Detector:	Quasi peak / average or peak (worst case – pre-scan)
Resolution bandwidth:	F < 150 kHz: 200 Hz 150 kHz < F < 30 MHz: 9 kHz 30 MHz < F < 1 GHz: 120 kHz
Video bandwidth:	F < 150 kHz: 1 kHz 150 kHz < F < 30 MHz: 100 kHz 30 MHz < F < 1 GHz: 300 kHz
Trace mode:	Max hold
Used equipment:	See chapter 6.1, 6.2
Measurement uncertainty:	See chapter 8

Limit:

FCC & IC		
Frequency (MHz)	Field strength (dB μ V/m)	Measurement distance (m)
0.009 – 0.490	2400/F(kHz)	300
0.490 – 1.705	24000/F(kHz)	30
1.705 – 30	30 (29.5 dB μ V/m)	30
30 – 88	100 (40 dB μ V/m)	3
88 – 216	150 (43.5 dB μ V/m)	3
216 – 960	200 (46 dB μ V/m)	3

Note: For a reduced measurement distance, please take a look at the limit line and the ANSI C63.10-2013 sub clause 6.4 radiated emissions from unlicensed wireless devices below 30 MHz.

Result:

Detected emissions			
Frequency (MHz)	Detector	Resolution bandwidth (kHz)	Detected value (dB μ V/m @ 3m)
No Peak closer to 10 dB detected			

Plots:

Plot 1: 9 kHz – 30 MHz, magnetic emissions (0 degree)

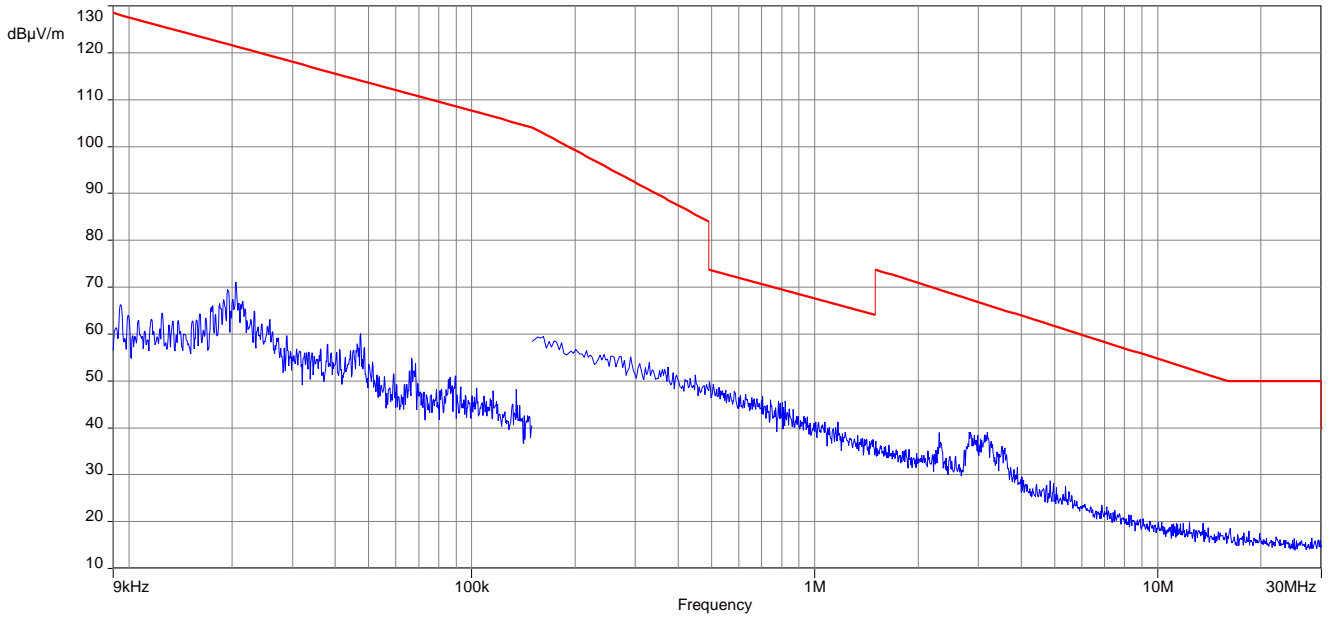

Plot 2: 9 kHz – 30 MHz, magnetic emissions (90 degree)

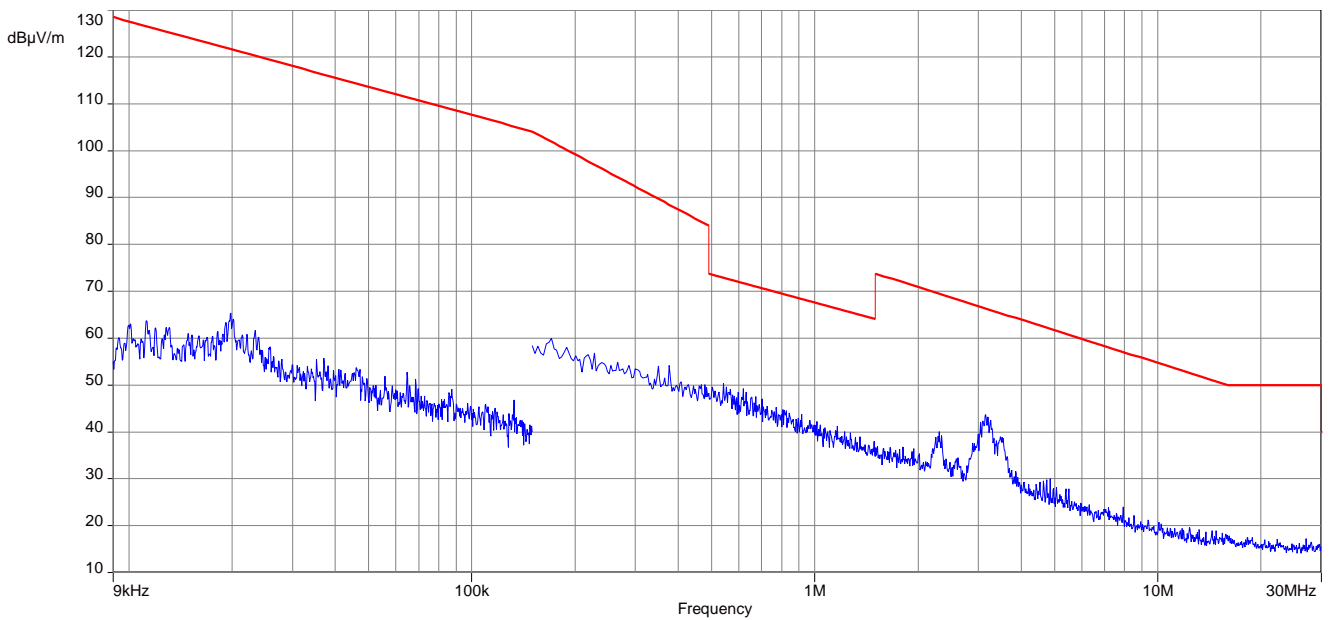

Plot 3: 9 kHz – 30 MHz, magnetic emissions (Antenna position horizontally w.r.t EUT)

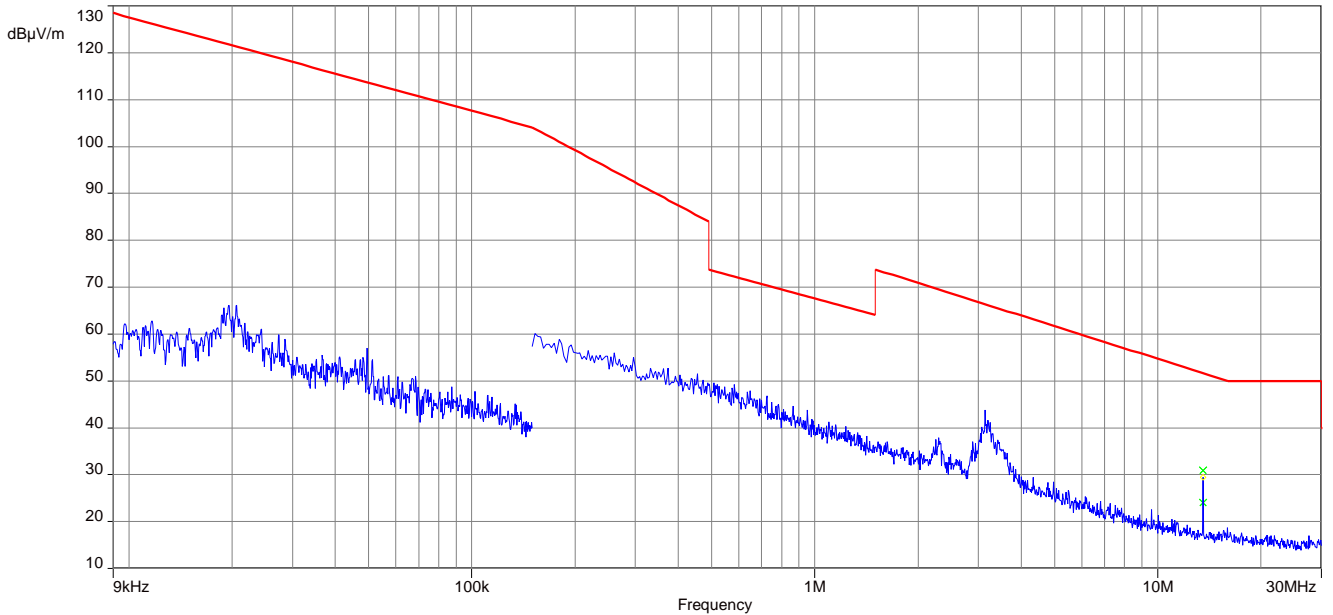

Plot 4: Spectrum mask (the limits are recalculated according to the ANSI C63.10-2013 sub clause 6.4)

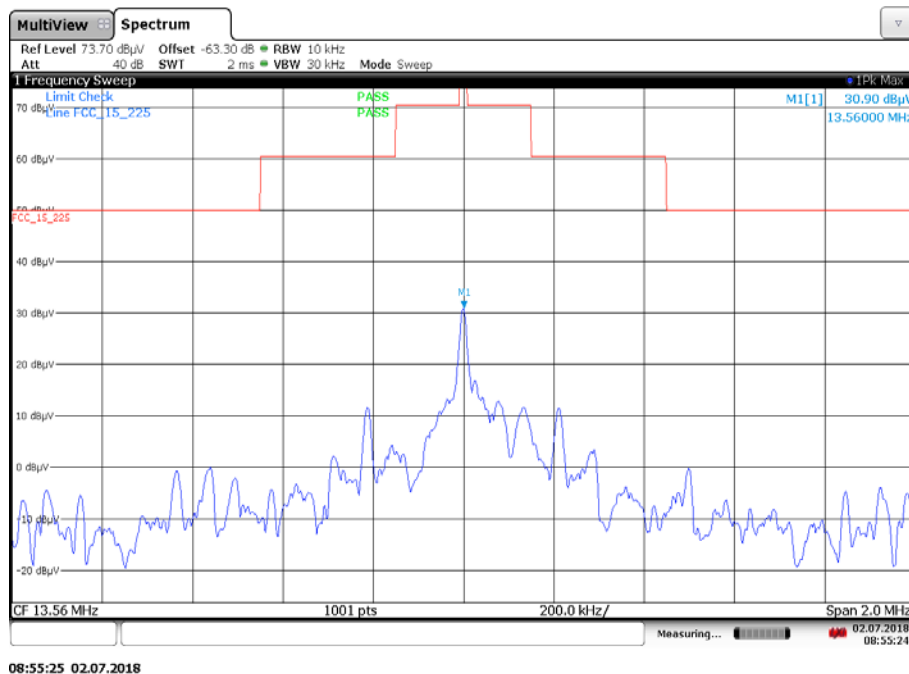

Plot 3: 30 MHz – 1 GHz, vertical and horizontal polarization

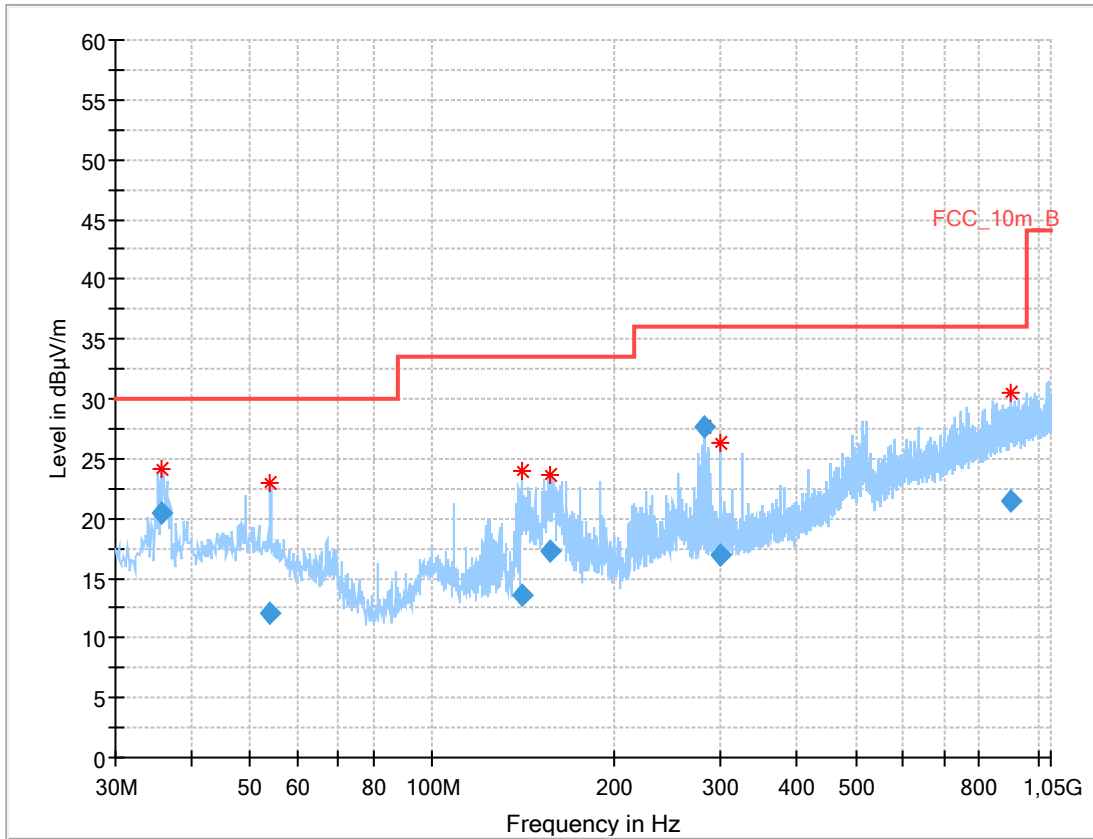

Final_Result

Frequency (MHz)	QuasiPeak (dBµV/m)	Limit (dBµV/m)	Margin (dB)	Meas. Time (ms)	Bandwidth (kHz)	Height (cm)	Pol	Azimuth (deg)	Corr. (dB)
35.733	20.53	30.0	9.47	1000	120	100.0	V	322.0	12.7
53.749	12.15	30.0	17.85	1000	120	200.0	V	31.0	13.3
140.348	13.57	33.5	19.93	1000	120	103.0	V	-14.0	8.9
156.338	17.29	33.5	16.21	1000	120	100.0	V	-6.0	9.5
281.108	27.57	36.0	8.43	1000	120	273.0	H	210.0	14.1
298.246	16.98	36.0	19.02	1000	120	400.0	H	15.0	14.4
904.820	21.40	36.0	14.60	1000	120	273.0	H	323.0	24.2

11.4 Conducted limits

Measurement:

Measurement of the conducted spurious emissions for an intentional radiator that is designed to be connected to the public utility (AC) power line.

Measurement parameters	
Detector:	Quasi peak / average or peak (worst case – pre-scan)
Resolution bandwidth:	F < 150 kHz: 200 Hz F > 150 kHz: 9 kHz
Video bandwidth:	F < 150 kHz: 1 kHz F > 150 kHz: 100 kHz
Trace mode:	Max hold
Used equipment:	See chapter 6.1
Measurement uncertainty:	See chapter 8

Limit:

FCC & IC		
Frequency (MHz)	Quasi-peak (dB μ V/m)	Average (dB μ V/m)
0.15 – 0.5	66 to 56*	56 to 46*
0.5 – 5	56	46
5 – 30.0	60	50

Result: see table below Plots!

Plots:

Plot 1: Neutral Line

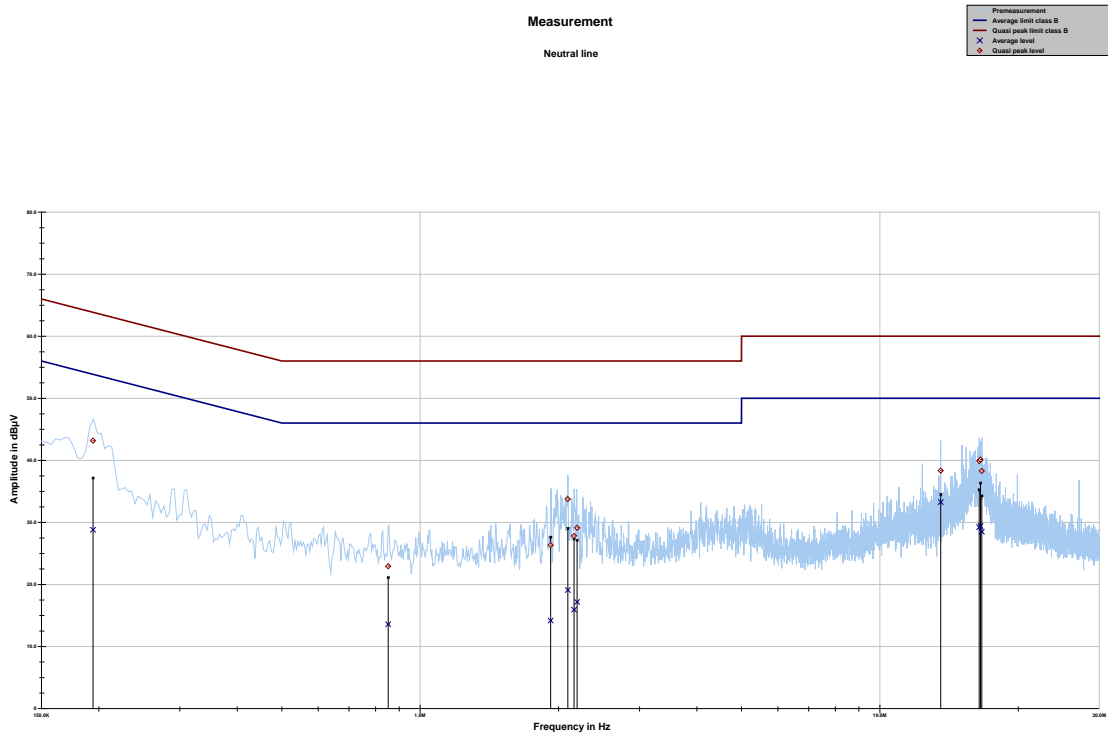

Project ID: 1-6031/18-01-

Neutral Line

Frequency MHz	Quasi peak level dBµV	Margin quasi peak dB	Limit QP dBµV	Average level dBµV	Margin average dB	Limit AV dBµV
0.194298	43.17	20.68	63.851	28.80	25.93	54.734
0.851847	22.93	33.07	56.000	13.57	32.43	46.000
1.922.613	26.33	29.67	56.000	14.18	31.82	46.000
2.095.502	33.74	22.26	56.000	19.09	26.91	46.000
2.161.208	27.82	28.18	56.000	15.92	30.08	46.000
2.194.724	29.12	26.88	56.000	17.18	28.82	46.000
13.561.867	38.35	21.65	60.000	33.27	16.73	50.000
16.443.439	39.89	20.11	60.000	29.22	20.78	50.000
16.548.150	40.12	19.88	60.000	29.39	20.61	50.000
16.657.795	38.30	21.70	60.000	28.50	21.50	50.000

Plot 2: Phase Line

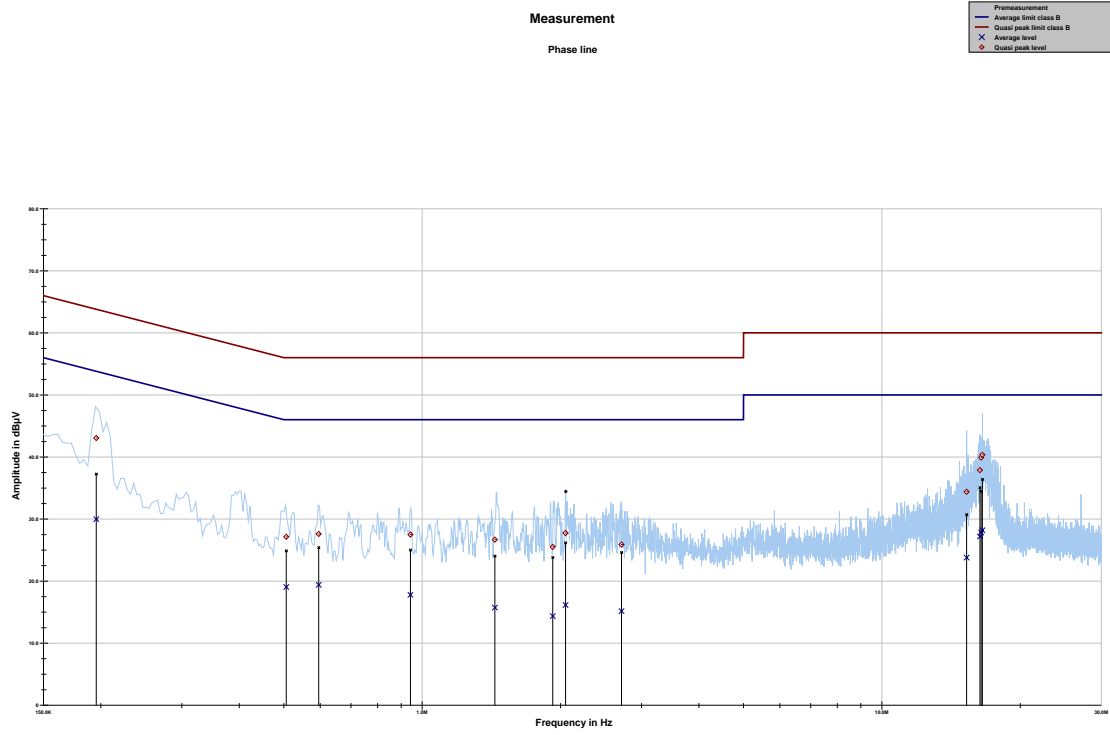

Project ID: 1-6031/18-01-

Phase Line:

Frequency MHz	Quasi peak level dBµV	Margin quasi peak dB	Limit QP dBµV	Average level dBµV	Margin average dB	Limit AV dBµV
0.195468	43.06	20.74	63.801	29.97	24.73	54.701
0.506208	27.14	28.86	56.000	19.04	26.96	46.000
0.595657	27.59	28.41	56.000	19.38	26.62	46.000
0.942895	27.50	28.50	56.000	17.79	28.21	46.000
1.439.541	26.67	29.33	56.000	15.73	30.27	46.000
1.923.602	25.51	30.49	56.000	14.36	31.64	46.000
2.050.773	27.74	28.26	56.000	16.14	29.86	46.000
2.714.213	25.89	30.11	56.000	15.16	30.84	46.000
15.286.710	34.39	25.61	60.000	23.79	26.21	50.000
16.340.444	37.89	22.11	60.000	27.19	22.81	50.000
16.441.897	39.90	20.10	60.000	27.83	22.17	50.000
16.546.161	40.34	19.66	60.000	28.18	21.82	50.000

11.5 Frequency error

Measurement:

The maximum detected field strength for the spurious.

Measurement parameters	
Detector:	Peak detector
Resolution bandwidth:	10 Hz / 100 Hz
Video bandwidth:	> RBW
Trace mode:	Max hold
Used equipment:	See chapter 6.3
Measurement uncertainty:	See chapter 8

Limit:

FCC & IC
<p>The frequency tolerance of the carrier signal shall be maintained within +/- 0.01% of the operating frequency over a temperature variation of -20 degrees to +50 degrees C at normal supply voltage, and for a variation in the primary supply voltage from 85% to 115% of the rated supply voltage at a temperature of 20 degrees C. (± 1.356 kHz)</p> <p>Carrier frequency stability shall be maintained to $\pm 0.01\%$ (± 100 ppm)</p>

Result: Temperature variation

Frequency tolerance			
Measured frequency (MHz)	Frequency error (kHz)	Conditions	Result
13.56015	0.15	-20 °C & 100% voltage	compliant
13.56014	0.14	-10 °C & 100% voltage	compliant
13.56015	0.15	0 °C & 100% voltage	compliant
13.56016	0.16	+10 °C & 100% voltage	compliant
13.56014	0.14	+20 °C & 100% voltage	compliant
13.56012	0.12	+30 °C & 100% voltage	compliant
13.56008	0.08	+40 °C & 100% voltage	compliant
13.56005	0.05	+50 °C & 100% voltage	compliant

Result: Voltage variation

Frequency tolerance			
Measured frequency (MHz)	Frequency error (kHz)	Conditions	Result
13.56010	0.10	+20 °C & 85% voltage	compliant
13.56014	0.14	+20 °C & 100% voltage	compliant
13.56010	0.10	+20 °C & 115% voltage	compliant

Plots

Plot 1: -20° C, V_{nom}

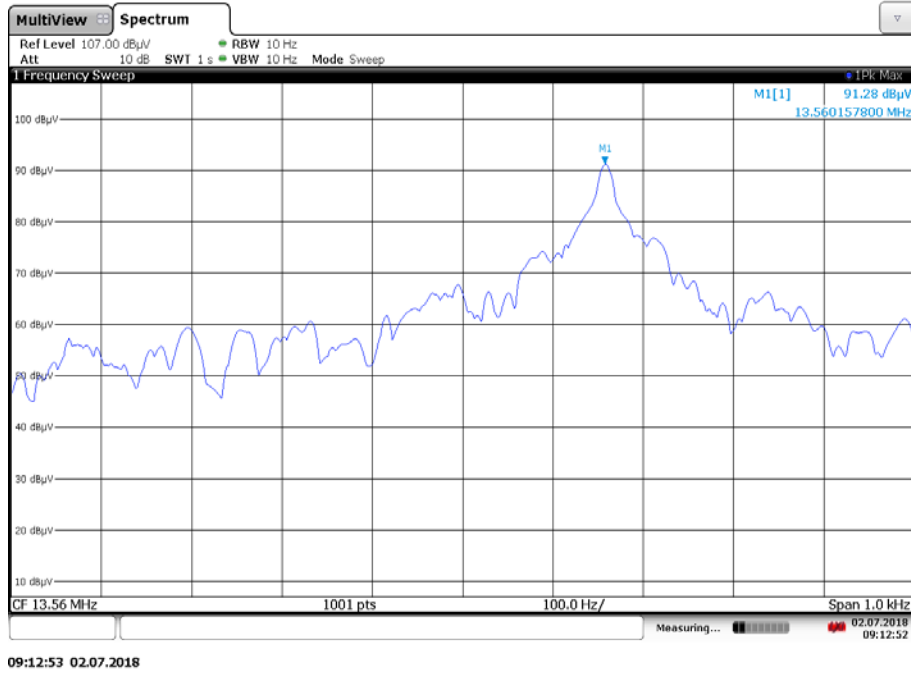

Plot 2: -10° C, V_{nom}

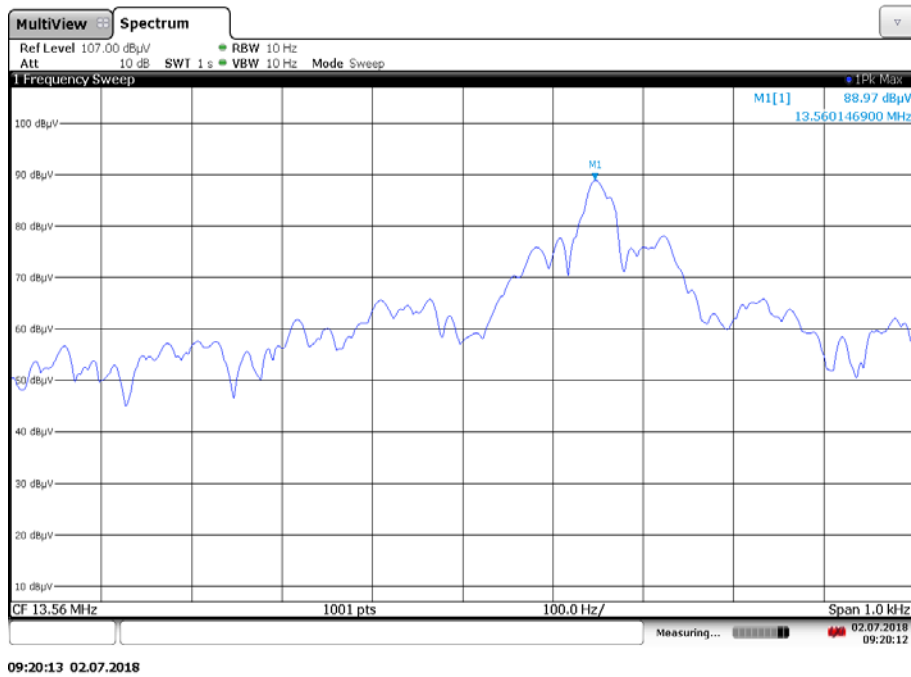

Plot 3: 0° C, V_{nom}

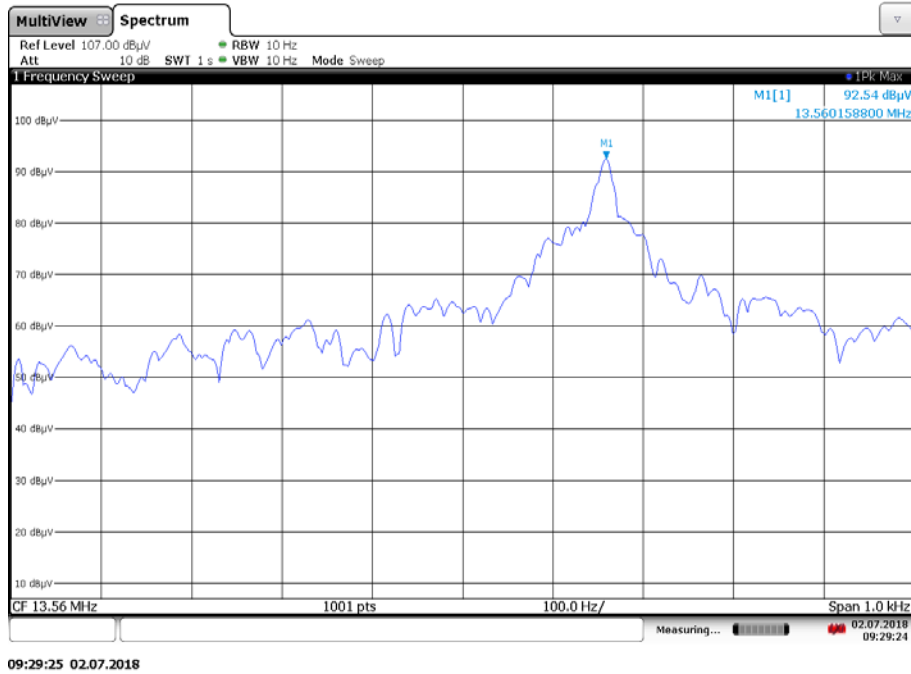

Plot 4: 10° C, V_{nom}

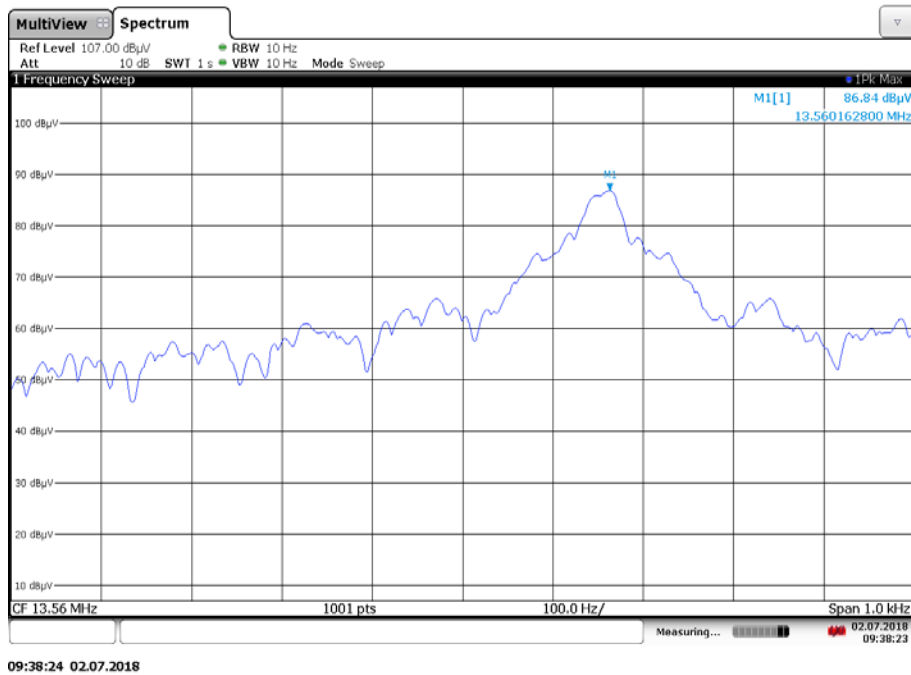

Plot 5: 20° C, V_{nom}

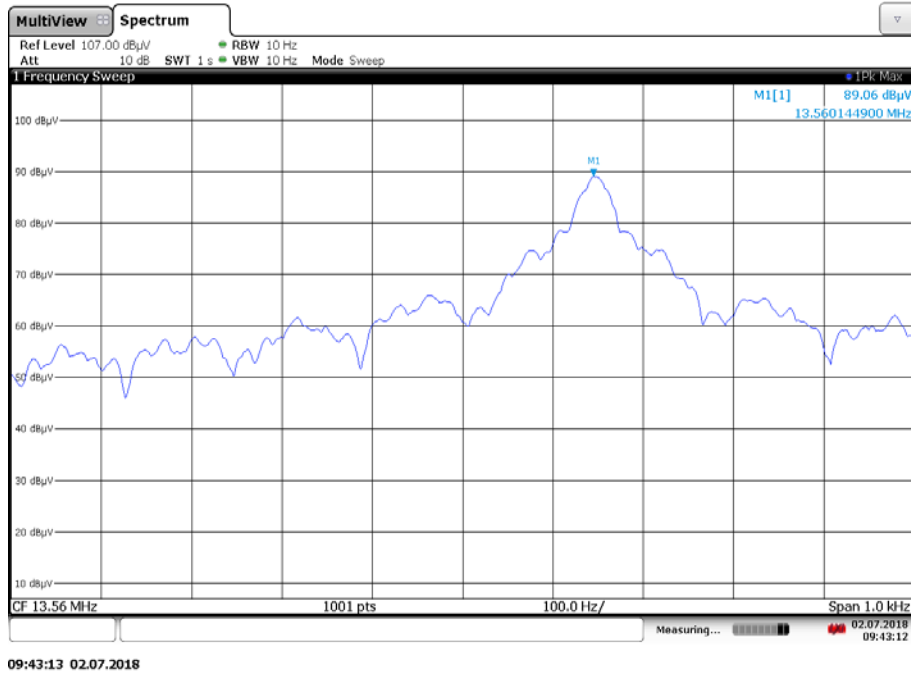

Plot 6: 30° C, V_{nom}

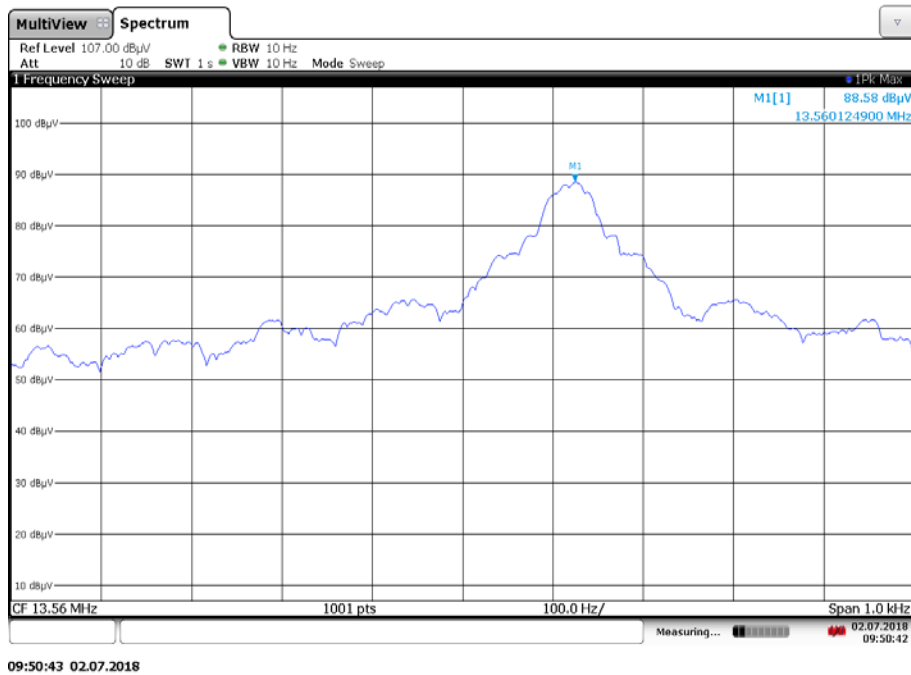

Plot 7: 40° C, V_{nom}

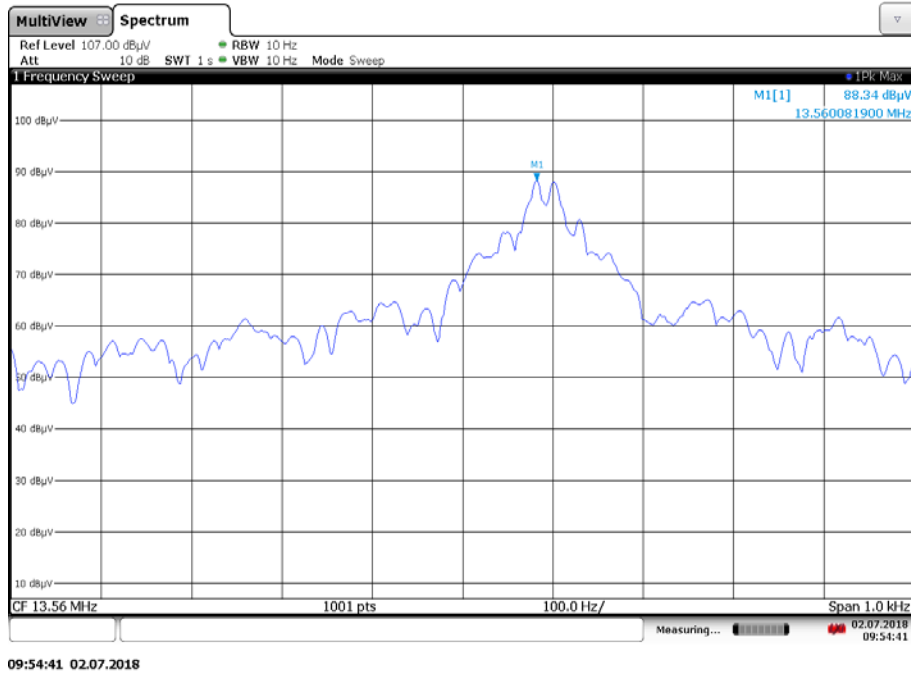

Plot 8: 50° C, V_{nom}

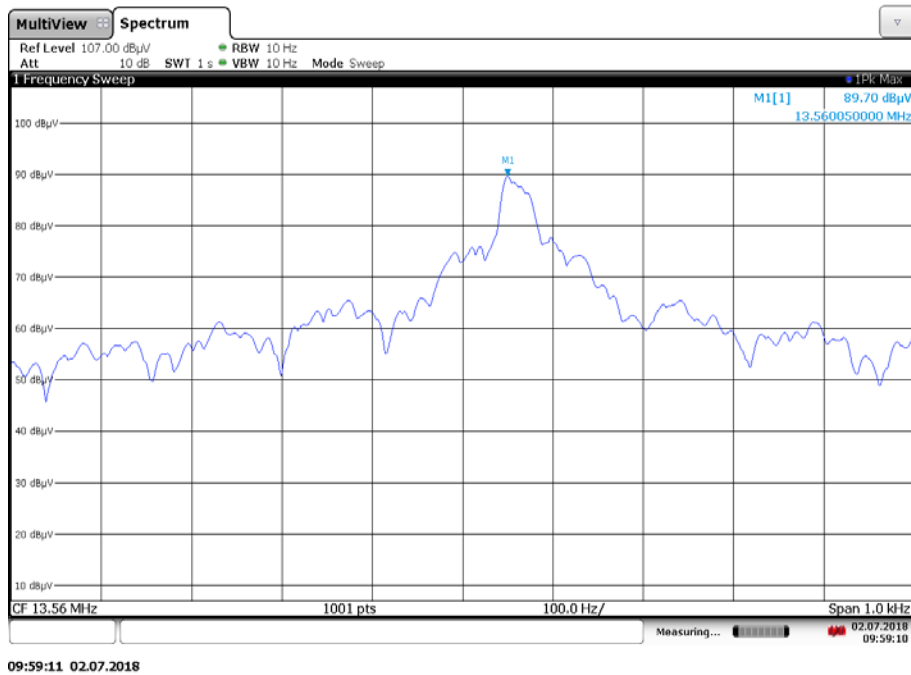

Plot 9: 20° C, V_{high}

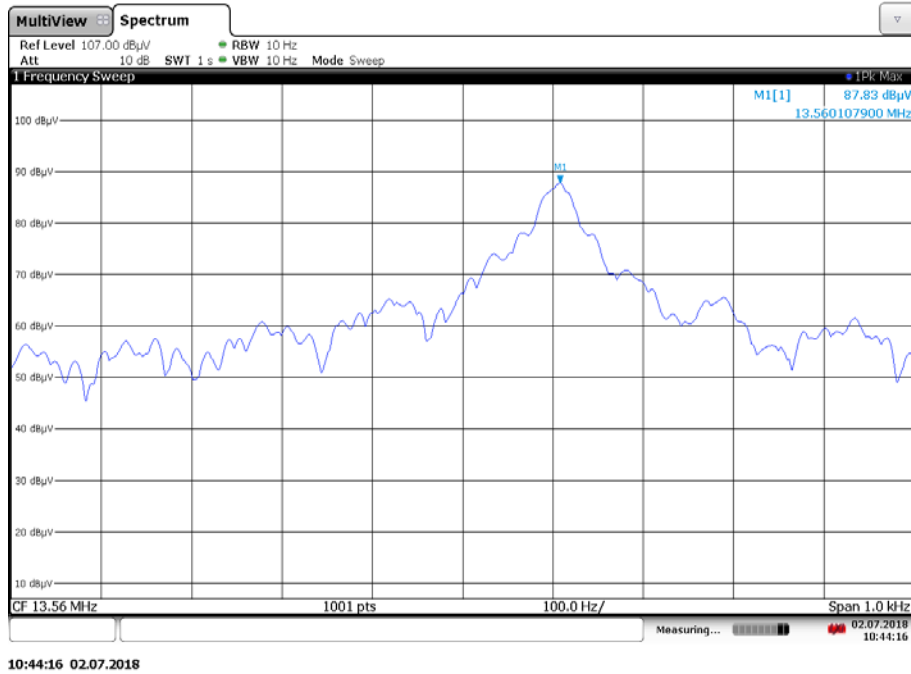

Plot 10: 20° C, V_{low}

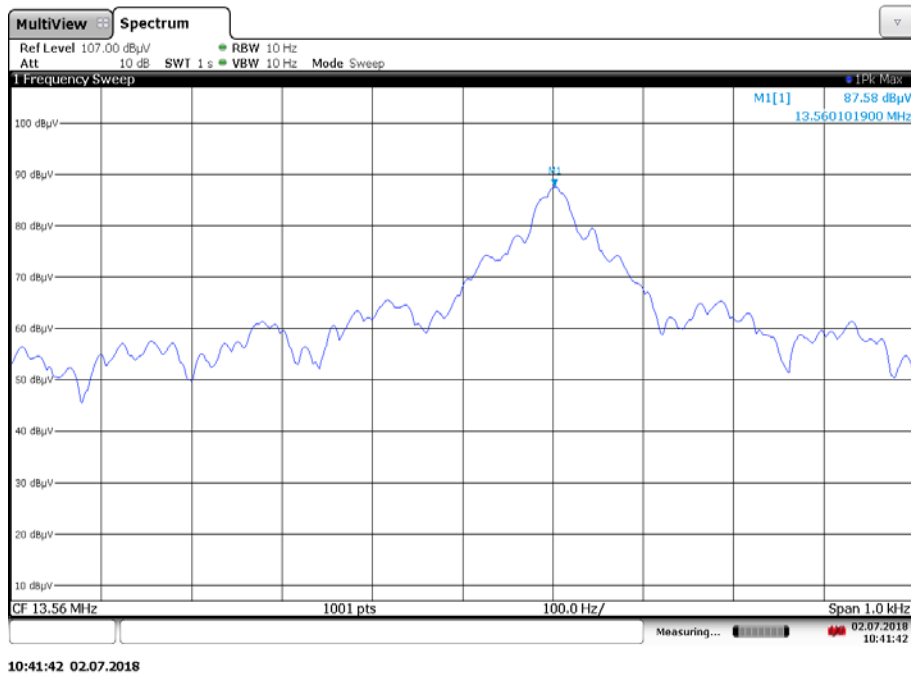

12 Observations

No observations except those reported with the single test cases have been made.

Annex A Glossary

EUT	Equipment under test
DUT	Device under test
UUT	Unit under test
GUE	GNSS User Equipment
ETSI	European Telecommunications Standards Institute
EN	European Standard
FCC	Federal Communications Commission
FCC ID	Company Identifier at FCC
IC	Industry Canada
PMN	Product marketing name
HMN	Host marketing name
HVIN	Hardware version identification number
FVIN	Firmware version identification number
EMC	Electromagnetic Compatibility
HW	Hardware
SW	Software
Inv. No.	Inventory number
S/N or SN	Serial number
C	Compliant
NC	Not compliant
NA	Not applicable
NP	Not performed
PP	Positive peak
QP	Quasi peak
AVG	Average
OC	Operating channel
OCW	Operating channel bandwidth
OBW	Occupied bandwidth
OOB	Out of band
DFS	Dynamic frequency selection
CAC	Channel availability check
OP	Occupancy period
NOP	Non occupancy period
DC	Duty cycle
PER	Packet error rate
CW	Clean wave
MC	Modulated carrier
WLAN	Wireless local area network
RLAN	Radio local area network
DSSS	Dynamic sequence spread spectrum
OFDM	Orthogonal frequency division multiplexing
FHSS	Frequency hopping spread spectrum
GNSS	Global Navigation Satellite System
C/N₀	Carrier to noise-density ratio, expressed in dB-Hz

Annex B Document history

Version	Applied changes	Date of release
-/-	Initial release	2019-04-16

Annex C Accreditation Certificate

first page	last page
 <p>DAkKS Deutsche Akkreditierungsstelle</p> <p>Deutsche Akkreditierungsstelle GmbH</p> <p>Entrusted according to Section 8 subsection 1 AkkStelleG in connection with Section 1 subsection 1 AkkStelleGBV Signatory to the Multilateral Agreements of EA, ILAC and IAF for Mutual Recognition</p> <p>Accreditation</p> <p>The Deutsche Akkreditierungsstelle GmbH attests that the testing laboratory CTC advanced GmbH Untertürkheimer Straße 6-10, 66117 Saarbrücken</p> <p>is competent under the terms of DIN EN ISO/IEC 17025:2005 to carry out tests in the following fields: Telecommunication</p> <p>The accreditation certificate shall only apply in connection with the notice of accreditation of 02.06.2017 with the accreditation number D-PL-12076-01 and is valid until 21.04.2021. It comprises the cover sheet, the reverse side of the cover sheet and the following annex with a total of 43 pages.</p> <p>Registration number of the certificate: D-PL-12076-01-03</p> <p>Frankfurt, 02.06.2017</p> <p>Dipl.-Ing. (FH) Ralf Böker Head of Division</p>	 <p>Deutsche Akkreditierungsstelle GmbH</p> <p>Office Berlin Spittelmarkt 10 10117 Berlin</p> <p>Office Frankfurt am Main Europa-Allee 52 60327 Frankfurt am Main</p> <p>Office Braunschweig Bundesallee 100 38116 Braunschweig</p> <p>The publication of extracts of the accreditation certificate is subject to the prior written approval by Deutsche Akkreditierungsstelle GmbH (DAKKS). Exempted is the unchanged form of separate disseminations of the cover sheet by the conformity assessment body mentioned overleaf.</p> <p>No impression shall be made that the accreditation also extends to fields beyond the scope of accreditation attested by DAKKS.</p> <p>The accreditation was granted pursuant to the Act on the Accreditation Body (AkkStelleG) of 31 July 2009 (Federal Law Gazette I p. 2625) and the Regulation (EC) No 765/2008 of the European Parliament and of the Council of 9 July 2008 setting out the requirements for accreditation and market surveillance relating to the marketing of products (Official Journal of the European Union L 218 of 9 July 2008, p. 30). DAKKS is a signatory to the Multilateral Agreements for Mutual Recognition of the European co-operation for Accreditation (EA), International Accreditation Forum (IAF) and International Laboratory Accreditation Cooperation (ILAC). The signatories to these agreements recognise each other's accreditations.</p> <p>The up-to-date state of membership can be retrieved from the following websites: EA: www.european-accreditation.org ILAC: www.ilac.org IAF: www.iaf.nu</p>

Note: The current certificate annex is published on the website (link see below) of the Accreditation Body DAkKS or may be received by CTC advanced GmbH on request

<https://www.dakks.de/as/ast/d/D-PL-12076-01-03e.pdf>