

### FCC Part 15 C Notice

CAUTION: Changes or modifications not expressly approved by the party responsible for compliance could void the user's authority to operate the equipment.

NOTE: This equipment has been tested and found to comply with the limits for a Class B digital device, pursuant to Part 15 of the FCC Rules. These limits are designed to provide reasonable protection against harmful interference in a residential installation. This equipment generates, uses and can radiate radio frequency energy and, if not installed and used in accordance with the instructions, may cause harmful interference to radio communications. However, there is no guarantee that interference will not occur in a particular installation. If this equipment does cause harmful interference to radio or television reception, which can be determined by turning the equipment off and on, the user is encouraged to try to correct the interference by one or more of the following measures:

- Reorient or relocate the receiving antenna.
- Increase the separation between the equipment and receiver.
- Connect the equipment into an outlet on a circuit different from that to which the receiver is connected.
- Consult the dealer or experienced radio/TV technician for help.

This device complies with Part 15 of the FCC Rules. Operation is subject to the following two conditions :

- (1) This device may not cause harmful interference, and
- (2) this device must accept any interference received, including interference that may cause undesired operation.

### ISED NOTICE: CANADA ONLY.

This device contains licence-exempt transmitter(s)/receiver(s) that comply with Innovation, Science and Economic Development Canada's licence-exempt RSS(s). Operation is subject to the following two conditions:

1. This device may not cause interference.
  2. This device must accept any interference, including interference that may cause undesired operation of the device.
- L'émetteur/récepteur exempt de licence contenu dans le présent appareil est conforme aux CNR d'Innovation, Sciences et Développement économique Canada applicables aux appareils radio exempts de licence. L'exploitation est autorisée aux deux conditions suivantes :

1. L'appareil ne doit pas produire de brouillage;
2. L'appareil doit accepter tout brouillage radioélectrique subi, même si le brouillage est susceptible d'en compromettre le fonctionnement.

### CAN ICES-003(B) / NMB-003(B)

This product meets the applicable Innovation, Science and Economic Development Canada technical specifications.  
Ce produit répond aux spécifications techniques pertinentes d'Innovation, Science et Développement économique applicables.



Conforms to safety requirements of RSS210, ASTM, CPSIA and FCC.

Voyage Aeronautics™ is the registered trademark of Amax Group USA, LLC.  
AMAX Group USA Address: 12645 Memorial Dr Suite F1 #388 Houston, TX 77024  
© 2021 All Rights Reserved. visit us at [www.amaxbrands.com](http://www.amaxbrands.com)

Made in China  
C001-CA-V 1.0

# VA-2080

## ULTRA COMPACT FOLDING MICRO DRONE



### INSTRUCTION BOOKLET

**WARNING:** Never leave product charging unattended for extended periods of time. Always disconnect VA-2080 from charger immediately after the VA-2080 is fully charged. Please refer to enclosed safety instructions.

### PACKAGE CONTAINS:



VA-2080



2.4G Wireless Controller



USB Charging Cord



Spare Parts



Instruction Booklet

Colors and styles may vary slightly.

## TABLE OF CONTENTS

Features .....	2
Remote Control Battery Installation .....	2
Charging the VA-2080.....	2
VA-2080 Diagram, Remote Diagram .....	3
Preparing for Flight .....	4
Syncing Your VA-2080.....	4
Flying Tips .....	4
Now You Are Ready To Fly ! .....	5
Recognizing the Front and Rear of the VA-2080 .....	5
Automatically Take Off / Land .....	5
Understanding The Altitude Lock .....	5
Speed Setting Button .....	5
T (Training)Mode .....	5
Understanding Trim Adjustments.....	6
Forward / Backward Trim .....	6
Banking Left / Right Trim .....	6
Flight Control .....	7
Calibrating the VA-2080.....	8
How To Do 360° Stunt Rolls .....	8
VA-2080 Warning:.....	9
Battery Warnings, Care and Maintenance .....	9
Replacing the Propeller Blade .....	9
Limited 90-Day Warranty.....	10
FCC Part 15 C Notice .....	11

## FEATURES

- Air Pressure Sensor Locks Flight Altitude
- Built In 6 Axis Gyroscopic Chip Keeps the VA-2080 Extremely Stable in All Conditions
- Automatically Starts and Lands
- Different Speed Settings for Slow to High Speed Flying
- Head Light

## REMOTE CONTROL BATTERY INSTALLATION

1. Unscrew and remove the battery cover from the back of the remote control as shown in diagram A.
2. Install 2 "AAA" alkaline batteries into the battery compartment as shown in the diagram A1.
3. Replace the battery cover and secure it.

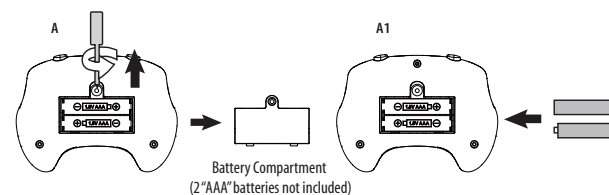

## CHARGING YOUR VA-2080 BATTERY

1. Turn the VA-2080 Off. Plug the charging cable into the VA-2080 charging socket. (see diagram B).
2. Connect the USB end of the cable to your computer's USB port or a USB wall charger (see diagram B1). The red LED on the USB plug lights up when charging is complete. Note: If the red LED lights up, either the charging is complete or the USB plug is not properly connected.
3. Average charging time is approximately 40 minutes (via 5.0V = 2A USB wall charger). The VA-2080 operates for approximately 5-6 minutes on full charge.

**Note: Periodically examine the charger for external damage. External damage to the charger may result in the risk of fire, electric shock, or injury to persons. Never use a damaged adapter.**

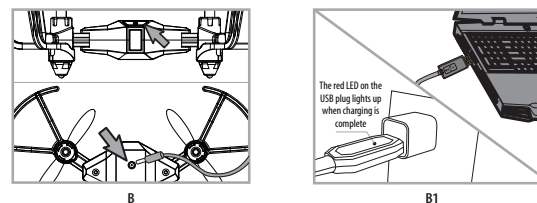

**IMPORTANT: ALWAYS REMEMBER TO UNPLUG YOUR CHARGING CORD WHEN NOT IN USE!**

## HOW TO EXPAND AND FOLD YOUR VA-2080

Before flying your VA-2080, you need to expand the foldable arms out. Turn your VA-2080 over, bottom side facing you, pull and expand the 4 arms as shown in the diagram below carefully. Make sure the arms are fully expanded to the position with a click sound. After flying your VA-2080, it is recommended to fold all 4 arms back in. When expanding or folding your VA-2080, make sure to be gentle. (see diagram C)

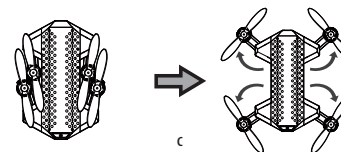

Thank you for purchasing the 2.4 G Indoor /Outdoor VA-2080. Please read this instruction booklet as it contains valuable information on how to properly fly and care for your VA-2080.

## VA-2080 DIAGRAM

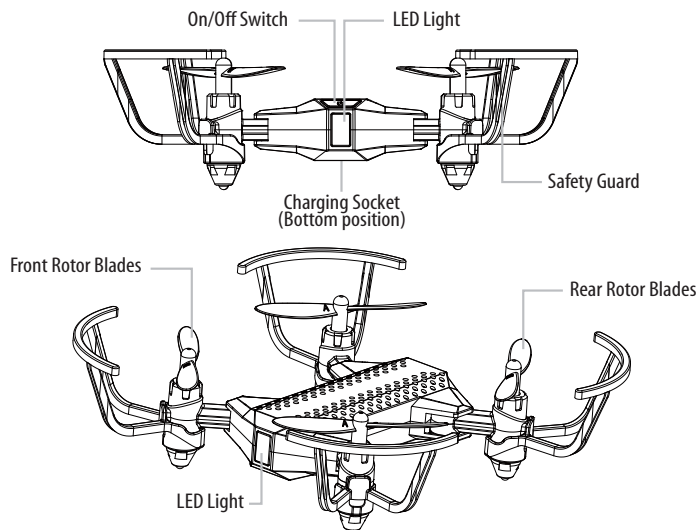

## REMOTE DIAGRAM

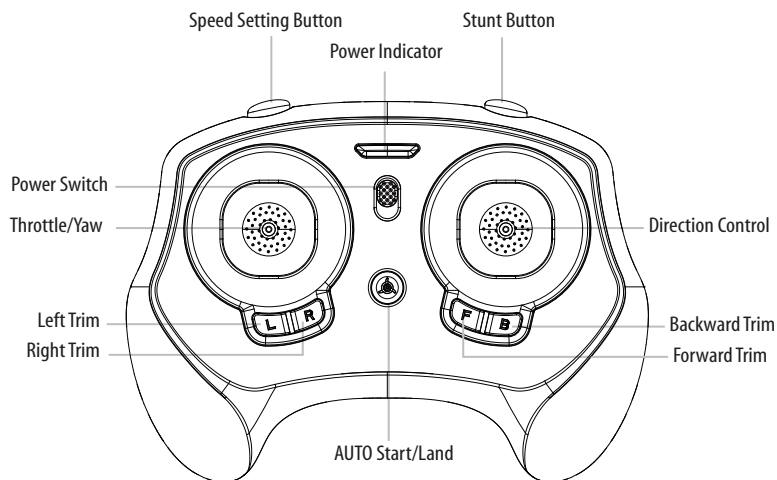

## WARNING

**DO NOT FLY YOUR VA-2080 IN FOUL WEATHER!**



## PREPARING FOR FLIGHT

- Verify that there are 2 "AAA" batteries inside the remote control unit and the VA-2080 has been fully charged.
  - Make sure to be in a large space with an open radius of at least 50 feet.
  - Make sure the empty space has no obstacles or rivers. Set your VA-2080 on a clean flat surface before take-off.
- DO NOT ATTEMPT TO FLY YOUR VA-2080 IF THERE IS RAIN, SNOW, HEAVY WINDS, THUNDER OR LIGHTNING OUTDOORS. IT COULD DAMAGE YOUR PRODUCT.**

## SYNCING YOUR VA-2080

**Important!** When syncing your VA-2080 quadcopter with the controller always make sure that the quadcopter is on a flat level surface and that your digital trim settings are in the center position. This ensures that the 6 Axis gyro is properly programmed to mimic your trim settings.

Your VA-2080 utilizes an automatic 2.4G channel selection system that allows up to 8 people to fly side by side in the same wireless range with no interference.

### For One-Person Play:

1. Before starting, make sure that the power on both your controller and VA-2080 are in the OFF position. Make sure that there are no other 2.4G devices in the area as well.
2. Press On/Off switch and hold for 2 seconds turn ON the VA-2080 and set it down on a flat surface. The LED indicator lights of the VA-2080 should begin to flash rapidly.
3. Turn ON the remote, you will hear two short beeps. The VA-2080's LED lights flash rapidly. Push the throttle on the left all the way forward (1 beep) and then pull the throttle all the way back. A 2nd beep will sound and the VA-2080's lights should turn to solid. This indicates your controller and the quadcopter are successfully synced. If not, repeat above steps.

### For Multi Person Play:

4. Before starting, make sure that the power on all VA-2080 drones and Controllers are in the OFF position. Make sure that there are no other 2.4 G devices in the area.
5. Each person will have to sync their VA-2080 individually at a different time to avoid interference. Follow steps 1 to 3 above making sure that no one else is syncing at the same time.
6. After syncing a player's VA-2080, it should be left ON until all players have synced their VA-2080 quadcopters.
7. Should there be a mistake or interference, all players must turn off their controllers and VA-2080 quadcopters for up to 60 seconds and then begin the process again.

## FLYING TIPS

- It is recommended that you operate the VA-2080 in a wide space. The ideal space should have a 61 m/200 ft radius.
- Parental guidance or adult supervision is suggested at all times.
- If you are flying the VA-2080 with others, make sure all spectators are behind you.
- For best performance, it is recommended that you operate the VA-2080 in zero wind conditions. Wind can greatly affect the performance of the VA-2080.

## NOW YOU ARE READY TO FLY!

If you have successfully synced your VA-2080 to your controller as explained on page 4 you are now ready to fly. Before beginning to fly your drone you should familiarize yourself with how to start and stop the rotors, how to use your take off and auto land feature and how the controls work. Please carefully read and familiarize yourself with various control features explained in the next few pages. Once again as a beginner pilot you should learn how to control your drone in a large open field or park on a day with zero or very light wind. Do not try to fly your VA-2080 too high until you become a more experienced pilot.

## RECOGNIZING THE FRONT AND REAR OF THE VA-2080

Even though the VA-2080 has four rotors there is still a front or forward-facing direction and back or backwards-facing direction. The Front and forward-facing direction of the VA-2080 is the side with white color head light. The rear and back of the VA-2080 is where the power ON/OFF is. The VA-2080 when in flight will also help you keep aware of the orientation with lighted LED lights in the arms of the VA-2080.

**NOTE:** The front of the VA-2080 displays WHITE LED lights and the back of the VA-2080 displays RED LED lights.

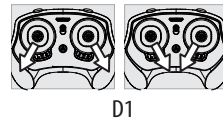
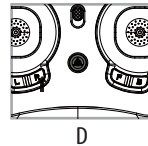
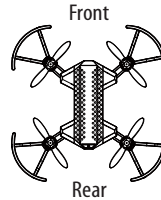

## AUTOMATICALLY TAKE OFF / LAND

Make sure you have properly synced The VA-2080.

- simply press the Auto Start/Land button, your VA-2080 will automatically take off.
- To stop or land the VA-2080 just Press the Auto Start/Land button again and the VA-2080 will descend and land automatically (see diagram D).

**Tips:** You also can move the two control sticks simultaneously down inside or outside corners, hold them till you hear a "beep" and the blades start spinning. Release the control sticks and push the throttle stick slowly to take off manually (see diagram D1).

## UNDERSTANDING THE ALTITUDE LOCK

The VA-2080 has a unique Altitude Lock function. With the help of air pressure sensor you can control, your VA-2080 more stable than ever. The sensor locks in the altitude of the drone while allowing the user to adjust the directional control without having to hold the throttle.

After starting the Drone, fly upwards to a safe height. Once at a safe height, let go of the throttle control, your VA-2080 should lock in the altitude and allow the user to focus on getting used to the directional controls.

**NOTE:** The altitude sensor does have some tolerance based on atmospheric conditions and could have a slight variation in altitude.

## SPEED SETTING BUTTON

The VA-2080 has 3 speed settings; 1 (SLOW), 2 (MEDIUM) and 3 (HIGH). The Default setting when you first turn on your VA-2080 is 1 (SLOW). To change speed, just press and release the speed setting button (see remote diagram on page 3). Speed level is indicated by number of beeping sounds, one beeping sound for slow speed, two for medium speed and three for high speed.

## T (Training) MODE

Simply press and hold the Speed Button, you will hear a long beep indicating you are in T Mode now. T mode allows you to learn how to operate your VA-2080 at a very slow speed. Also there are maximum and minimum height limits set to avoid crashing to ceiling or floor in T mode. To exit T mode just press the speed setting button again.

## UNDERSTANDING TRIM ADJUSTMENTS

### Forward/Backward Trim

- If your VA-2080 is moving forwards or backwards automatically, you may need to adjust the FORWARD/BACKWARD TRIM buttons.
- If your VA-2080 flies forward, push and release the Backward TRIM button repeatedly until the moving stops and proper flight is maintained.
- If your VA-2080 flies backwards, push and release the Forward TRIM button in the same manner until the problem is resolved.
- From time to time you may have to adjust the FORWARD/BACKWARD TRIM to ensure the VA-2080 will hover in mid-air and respond accurately to your commands.

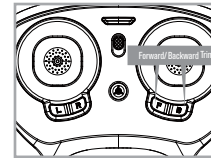

Forward/Backward Trim Controls

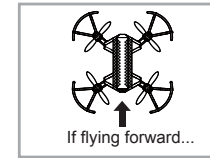

Push backward trim button

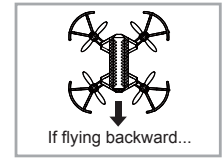

Push forward trim button

### Banking Left/Right Trim

- If your VA-2080 is not steadily hovering and is banking to the left or right automatically, you may need to adjust the BANKING TRIM buttons.
- If your VA-2080 banks to the left, push and release the R Trim button repeatedly until the banking stops and proper flight is maintained.
- If your VA-2080 banks to the right, push and release the L Trim button in the same manner until the problem is resolved.
- From time to time you may have to adjust the BANKING TRIM to ensure the VA-2080 will and respond accurately to your commands.

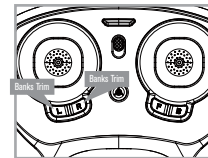

Left/Right Banking Controls

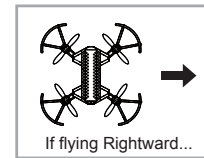

Push the " L " trim button to increase left banking sensitivity

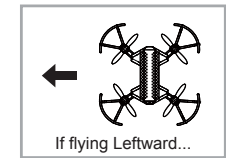

Push the " R " trim button to increase Right banking sensitivity

**NOTE:** The use of the Trim buttons are accompanied with a beep tone. A single long beep indicates the product is centre-trimmed. No beeping after press the trim button indicates the product is trimmed to the maximum on a particular side.

## FLIGHT CONTROL



Move the Throttle up to increase the speed of the motors and the VA-2080 will rise up.



Move the Throttle down to decrease the speed of the motors and the VA-2080 will descend.

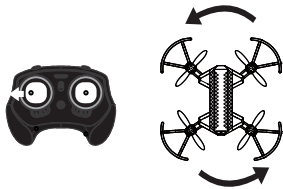

Move the Throttle stick left and the VA-2080 will rotate left.

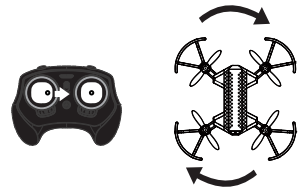

Move the Throttle stick right and the VA-2080 will rotate right.

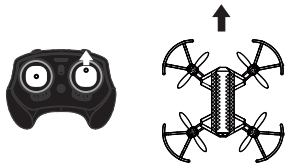

Move the Direction Control up and the VA-2080 will move forward.

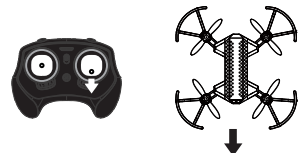

Move the Direction Control down and the VA-2080 will move backward.

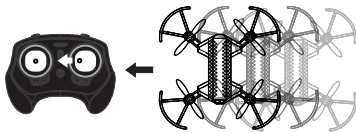

Move the Direction Control left and the VA-2080 will bank to the left.

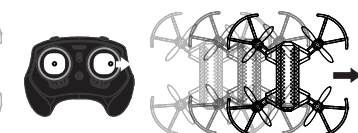

Move the Direction Control right and the VA-2080 will bank to the right.

## CALIBRATING THE VA-2080

If the VA-2080 becomes unstable during the course of flying, you may need to calibrate the internal gyros. To do this place the VA-2080 on a flat level surface. Do not start the blades. Instead move both the throttle and control stick down and to the right corner. The LEDs on the VA-2080 will flash quickly and then remain solid. This indicates your drone has been recalibrated (see diagram E).

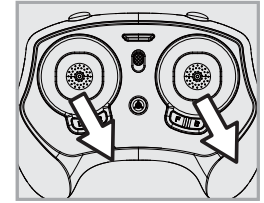

## HOW TO DO 360° STUNT ROLLS

1. In order to make your VA-2080 do 360° rolls you must fully charge your battery.  
Note: The VA-2080 will not do 360° stunt rolls under low battery indication.
2. Once you are ready to attempt a 360° roll, simply depress and let go of the "STUNT" button on the top right hand side of your controller (see Remote Diagram on page 3). You will hear beeping sounds, this means you are now in "STUNT MODE."
3. Now quickly move your right control stick in any of 4 directions; up, down, left or right. Your VA-2080 drone will instantly roll in the associated direction. See diagram below.  
Note: After performed the stunt roll, the beeping sounds will stop. Repeat step 2 to 3 if you wish to do it again.

360° Stunt Roll

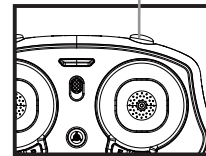

F

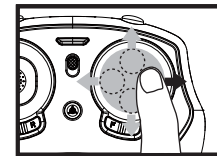

G

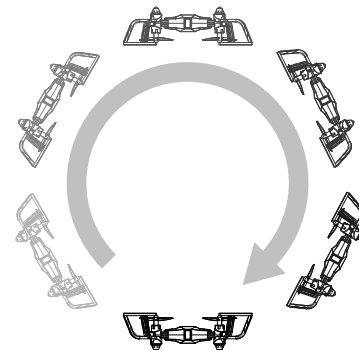

## VA-2080 WARNING:

The VA-2080 is designed for INDOOR and OUTDOOR use. The VA-2080 blades revolve at high speeds and can cause damage to the user, spectators and animals. Stand away from the VA-2080 to reduce the risk of getting into the flight path. Warn spectators that you will be flying your VA-2080 so that they are aware of its position. Before flight, inspect the rotor blades to make certain that the blades are securely fastened to the VA-2080.

### WARNING!

- Choking/Cutting Hazard. Small Parts/Sharp Rotor Blades.
- Keep hands, hair and loose clothing away from the propeller when the power switch is turned to the ON position.
- Turn off the transmitter and VA-2080 power switches when not in use.
- The included charger is built specifically for the VA-2080 Li-Poly battery. Do not use it to charge any other battery.
- New alkaline batteries are recommended for maximum performance.
- Parental supervision recommended when flying VA-2080.

## BATTERY WARNINGS

### RECHARGEABLE BATTERY:

This VA-2080 uses a Li-Poly rechargeable battery. If battery no longer stays charged, dispose of battery properly according to local disposal requirements.

### CONTROLLER BATTERIES:

Remote control requires 2 "AAA" batteries (not included). Please read the important battery safety warning below.

- Do not mix alkaline, standard (carbon-zinc) and rechargeable batteries (nickel metal hydride).
- Do not mix old and new batteries.
- Non-rechargeable batteries are not to be recharged.
- Rechargeable batteries are to be removed from the item before being charged (if removable).
- Rechargeable batteries are only to be charged under adult supervision.
- Exhausted batteries should be removed immediately and must be recycled or disposed of properly according to state or local government ordinances and regulations.
- The supply terminals are not to be short-circuited.
- Only batteries of the same or equivalent type as recommended are to be used.
- Batteries are to be inserted with the correct polarity (see inside booklet for diagram).
- Do not dispose of batteries in a fire - batteries may leak or explode.

## CARE AND MAINTENANCE

- Always remove the batteries from the wireless remote control when it is not being used for an extended period of time.
- To clean, gently wipe the remote control and VA-2080 with a clean damp cloth.
- Keep the toy away from direct heat or sunlight.
- Do not submerge the toy into water. This can damage the unit beyond repair.
- Parental guidance recommended when installing or replacing the batteries.

## REPLACING THE PROPELLER BLADE

Your VA-2080 propeller system is a precision instrument that may need repair or replacement from time to time for optimal flight function. Crash landing from high-speed aerial flights may cause damage to your VA-2080's propellers.

1. VA-2080 have four blades, Please note that the four blades of the VA-2080 are labeled with an embossed A or B (see the diagram F).
2. When replacing the propeller blades, gently remove the blade from the rotor shaft. Make sure to match the indication letter on the blade with the letter on the aircraft.
3. Replace the broken blade with the correct spare blade.

Blade Front Left = A  
Blade Front Right = B

Blade Rear Left = B  
Blade Rear Right = A

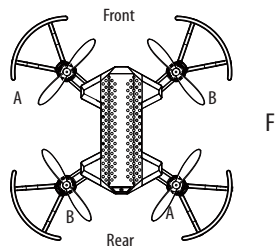

## Limited 90-Day Warranty

NORTH AMERICA

AMAX Group USA warrants to the original consumer that this product is free from any electrical or mechanical defects for a period of 90 DAYS from the date of purchase. If any such defect is discovered within the warranty period, AMAX Group USA will repair or replace the unit free of charge upon receipt of the unit, shipped postage prepaid and insured to our warranty center ALONG WITH THE ORIGINAL RECEIPT evidencing that the product was purchased from an approved AMAX retail partner and that the product is still within the 90 day warranty period. The warranty covers normal consumer use and does not cover damage that occurs in shipment or failure that results from alterations, accident, misuse, abuse, neglect, wear and tear, inadequate maintenance, commercial use or unreasonable use of the unit. Removal of any parts/components voids all warranties. This warranty does not cover cost of repairs made or attempted outside by third-party individuals or companies. Any applicable implied warranties, including warranties of merchantability and fitness, are hereby limited to 90 DAYS from the date of purchase. Consequential or incidental damages resulting from a breach of any applicable express or implied warranties are hereby excluded. Some states do not allow limitations on the duration of implied warranties and do not allow exclusion of incidental or consequential damages, so the above limitations and exclusions in these instances may not apply.

### REPAIR/REPLACE PRODUCT

If your product begins to malfunction or stop working, immediately contact our warranty center (contact details listed below). If it is determined that a return is necessary, our warranty department will issue you an RMA number/form and an address to the nearest return center for shipping the product to us. When honoring the warranty, AMAX reserves the right to either repair, replace or refund the product.

### IMPORTANT NOTICE:

We will reject and return to sender returns that are not accompanied by an AMAX issued RMA form and RMA number so make sure to contact our warranty center before attempting to return your product!

### PREPARATION FOR SHIPPING YOUR PRODUCT:

Please repack your product in a durable box, preferably in the original carton, and send it prepaid, and adequately insured. Include the RMA form that was issued by our warranty department along with your daytime telephone number and email address inside the shipping carton. If your warranty has expired and you still require service please contact our customer care team. For further information please send all inquiries to: [customercare@amaxbrands.com](mailto:customercare@amaxbrands.com)

### IMPORTANT NOTICE!

**DO NOT ATTEMPT TO SHIP YOUR PRODUCT BACK  
WITHOUT FIRST CONTACTING OUR WARRANTY  
DEPARTMENT AT:**

[www.amaxbrands.com](http://www.amaxbrands.com)

Email: [customercare@amaxbrands.com](mailto:customercare@amaxbrands.com)