

**CFR 47 FCC PART 15 SUBPART E
ISED RSS-247 ISSUE 2**

TEST REPORT

For

ASC-2680 HD Video Drone

FCC MODEL NUMBER: CT-6483

IC MODEL NUMBER: CT-6483R

REPORT NUMBER: 4790858924-RF-8

ISSUE DATE: June 9, 2023

FCC ID: 2ASK3CT-6483R

IC: 24796-CT6483R

Prepared for

**AMAX INDUSTRIAL GROUP CHINA CO.,LTD
OFFICE NO.3 10/F WITTY COMMERCIAL BUILDING 1A-1L TUNG CHOI STREET
MONGKOK KOWLOON HONG KONG**

Prepared by

UL Verification Services (Guangzhou) Co., Ltd, Song Shan Lake Branch

Building 10, Innovation Technology Park, No. 1, Li Bin Road, Song Shan Lake Hi-Tech Development Zone Dongguan, 523808, People's Republic of China

Tel: +86 769 22038881

Fax: +86 769 33244054

Website: www.ul.com

The results reported herein have been performed in accordance with the laboratory's terms of accreditation. This report shall not be reproduced except in full without the written approval of the Laboratory. The results in this report apply to the test sample(s) mentioned above at the time of the testing period only and are not to be used to indicate applicability to other similar products.

Revision History

Rev.	Issue Date	Revisions	Revised By
V0	June 9, 2023	Initial Issue	

Summary of Test Results

Test Item	Clause	Limit/Requirement	Result
ON TIME AND DUTY CYCLE	ANSI C63.10-2013, Clause 12.2	None; for reporting purposes only.	Pass
6dB AND 26dB EMISSION BANDWIDTH AND 99% OCCUPIED BANDWIDTH	KDB 789033 D02 v02r01 Section C.1	FCC Part 15.407 (a)/(e), RSS-247 Issue 2, Clause 6.2.1.2 RSS-Gen Clause 6.7	Pass
CONDUCTED OUTPUT POWER	KDB 789033 D02 v02r01 Section E.3.a	FCC 15.407 (a) RSS-247 Clause 6.2	Pass
POWER SPECTRAL DENSITY	KDB 789033 D02 v02r01 Section F	FCC 15.407 (a) RSS-247 Clause 6.2	Pass
AC Power Line Conducted Emission	ANSI C63.10-2013, Clause 6.2.	FCC 15.207 RSS-GEN Clause 8.8	N/A (Note 2)
Radiated Emissions and Band Edge Measurement	KDB 789033 D02 v02r01 Section G.3, G.4, G.5, and G.6	FCC 15.407 (b) FCC 15.209 FCC 15.205 RSS-247 Clause 6.2 RSS-GEN Clause 8.9	Pass
FREQUENCY STABILITY	ANSI C63.10-2013, Clause 6.8	FCC 15.407 (g)	Pass
Antenna Requirement	/	FCC 47 CFR Part 15.203/ 15.407(a)(1) (2), RSS-Gen Issue 5, Clause 6.8	Pass

Note:

1. N/A: In this whole report not applicable.
2. The EUT is power by battery and can't be charged during normal use.

*This test report is only published to and used by the applicant, and it is not for evidence purpose in China.

*The measurement result for the sample received is <Pass> according to <CFR 47 FCC PART 15 SUBPART E and ISED RSS-247 ISSUE 2> when <Accuracy Method> decision rule is applied.

CONTENTS

1. ATTESTATION OF TEST RESULTS	6
2. TEST METHODOLOGY	7
3. FACILITIES AND ACCREDITATION	7
4. CALIBRATION AND UNCERTAINTY	8
4.1. <i>MEASURING INSTRUMENT CALIBRATION</i>	8
4.2. <i>MEASUREMENT UNCERTAINTY</i>	8
5. EQUIPMENT UNDER TEST	9
5.1. <i>DESCRIPTION OF EUT</i>	9
5.2. <i>CHANNEL LIST</i>	9
5.3. <i>MAXIMUM CONDUCTED POWER</i>	9
5.4. <i>TEST CHANNEL CONFIGURATION</i>	9
5.5. <i>THE WORSE CASE POWER SETTING PARAMETER</i>	10
5.6. <i>DESCRIPTION OF AVAILABLE ANTENNAS</i>	10
5.7. <i>THE WORSE CASE CONFIGURATIONS</i>	10
5.8. <i>DESCRIPTION OF TEST SETUP</i>	11
6. MEASURING EQUIPMENT AND SOFTWARE USED	12
7. ANTENNA PORT TEST RESULTS	14
7.1. <i>ON TIME AND DUTY CYCLE</i>	14
7.2. <i>6DB AND 26DB EMISSION BANDWIDTH AND 99% OCCUPIED BANDWIDTH</i> ...	15
7.3. <i>CONDUCTED OUTPUT POWER</i>	17
7.4. <i>POWER SPECTRAL DENSITY</i>	19
7.5. <i>FREQUENCY STABILITY</i>	21
8. RADIATED TEST RESULTS	23
8.1. <i>RESTRICTED BANDEDGE</i>	33
8.2. <i>SPURIOUS EMISSIONS (1 GHZ ~ 7 GHZ)</i>	37
8.3. <i>SPURIOUS EMISSIONS (7 GHZ ~ 18 GHZ)</i>	43
8.4. <i>SPURIOUS EMISSIONS (18 GHZ ~ 26 GHZ)</i>	55
8.5. <i>SPURIOUS EMISSIONS (9 KHZ ~ 30 MHZ)</i>	57
8.6. <i>SPURIOUS EMISSIONS (26 GHZ ~ 40 GHZ)</i>	60
8.7. <i>SPURIOUS EMISSIONS (30 MHZ ~ 1 GHZ)</i>	62
8.8. <i>SPURIOUS EMISSIONS FOR SIMULTANEOUS TRANSMISSION</i>	64

9.	ANTENNA REQUIREMENT	68
10.	TEST DATA	69
10.1.	<i>APPENDIX A1: EMISSION BANDWIDTH.....</i>	69
10.1.1.	Test Result	69
10.1.2.	Test Graphs	70
10.2.	<i>APPENDIX A2: OCCUPIED CHANNEL BANDWIDTH</i>	72
10.2.1.	Test Result	72
10.2.2.	Test Graphs	73
10.3.	<i>APPENDIX A3: MIN EMISSION BANDWIDTH</i>	75
10.3.1.	Test Result	75
10.3.2.	Test Graphs	76
10.4.	<i>APPENDIX B: MAXIMUM AVERAGE CONDUCTED OUTPUT POWER.....</i>	78
10.4.1.	Test Result	78
10.5.	<i>APPENDIX C: MAXIMUM POWER SPECTRAL DENSITY</i>	79
10.5.1.	Test Result	79
10.5.2.	Test Graphs	80
10.6.	<i>APPENDIX G: FREQUENCY STABILITY</i>	82
10.6.1.	Test Result	82
10.7.	<i>APPENDIX H: DUTY CYCLE.....</i>	83
10.7.1.	Test Result	83
10.7.2.	Test Graphs	84

1. ATTESTATION OF TEST RESULTS

Applicant Information

Company Name: AMAX INDUSTRIAL GROUP CHINA CO.,LTD
 Address: OFFICE NO.3 10/F WITTY COMMERCIAL BUILDING 1A-1L
 TUNG CHOI STREET MONGKOK KOWLOON HONG KONG

Manufacturer Information

Company Name: AMAX INDUSTRIAL GROUP CHINA CO.,LTD
 Address: OFFICE NO.3 10/F WITTY COMMERCIAL BUILDING 1A-1L
 TUNG CHOI STREET MONGKOK KOWLOON HONG KONG

EUT Information

EUT Name: ASC-2680 HD Video Drone
 FCC Model: CT-6483
 IC Model: CT-6483R
 Sample Received Date: May 22, 2023
 Sample Status: Normal
 Sample ID: 6099249
 Date of Tested: May 23, 2023 to June 8, 2023

APPLICABLE STANDARDS	
STANDARD	TEST RESULTS
CFR 47 FCC PART 15 SUBPART E ISED RSS-247 ISSUE 2	Pass

Prepared By:

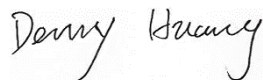

Denny Huang
 Senior Project Engineer

Checked By:



Kebo Zhang
 Senior Project Engineer

Approved By:



Stephen Guo
 Operations Manager

2. TEST METHODOLOGY

All tests were performed in accordance with the standard CFR 47 FCC PART 15 SUBPART E ISED RSS-247 ISSUE 2, ANSI C63.10-2013, CFR 47 FCC Part 2, KDB 789033 D02 v02r01, RSS-GEN Issue 5, KDB414788 D01 Radiated Test Site v01.

3. FACILITIES AND ACCREDITATION

Accreditation Certificate	<p>A2LA (Certificate No.: 4102.01) UL Verification Services (Guangzhou) Co., Ltd. Song Shan Lake Branch. has been assessed and proved to be in compliance with A2LA.</p> <p>FCC (FCC Designation No.: CN1187) UL Verification Services (Guangzhou) Co., Ltd. Song Shan Lake Branch. Has been recognized to perform compliance testing on equipment subject to the Commission's Declaration of Conformity (DoC) and Certification rules</p> <p>ISED (Company No.: 21320) UL Verification Services (Guangzhou) Co., Ltd. Song Shan Lake Branch. has been registered and fully described in a report filed with ISED. The Company Number is 21320 and the test lab Conformity Assessment Body Identifier (CABID) is CN0046.</p> <p>VCCI (Registration No.: G-20019, R-20004, C-20012 and T-20011) UL Verification Services (Guangzhou) Co., Ltd. Song Shan Lake Branch. has been assessed and proved to be in compliance with VCCI, the Membership No. is 3793. Facility Name: Chamber D, the VCCI registration No. is G-20019 and R-20004 Shielding Room B , the VCCI registration No. is C-20012 and T-20011</p>
---------------------------	--

Note 1:

All tests measurement facilities use to collect the measurement data are located at Building 10, Innovation Technology Park, No. 1, Li Bin Road, Song Shan Lake Hi-Tech Development Zone Dongguan, 523808, People's Republic of China.

Note 2:

The test anechoic chamber in UL Verification Services (Guangzhou) Co., Ltd. Song Shan Lake Branch had been calibrated and compared to the open field sites and the test anechoic chamber is shown to be equivalent to or worst case from the open field site.

Note 3:

For below 30 MHz, lab had performed measurements at test anechoic chamber and comparing to measurements obtained on an open field site. And these measurements below 30 MHz had been correlated to measurements performed on an OFS.

4. CALIBRATION AND UNCERTAINTY

4.1. MEASURING INSTRUMENT CALIBRATION

The measuring equipment utilized to perform the tests documented in this report has been calibrated in accordance with the manufacturer's recommendations and is traceable to recognized national standards.

4.2. MEASUREMENT UNCERTAINTY

Where relevant, the following measurement uncertainty levels have been estimated for tests performed on the apparatus:

Test Item	Uncertainty
Conduction emission	3.62 dB
Radiated Emission (Included Fundamental Emission) (9 kHz ~ 30 MHz)	2.2 dB
Radiated Emission (Included Fundamental Emission) (30 MHz ~ 1 GHz)	4.00 dB
Radiated Emission (Included Fundamental Emission) (1 GHz to 40 GHz)	5.78 dB (1 GHz ~ 18 GHz)
	5.23 dB (18 GHz ~ 26 GHz)
	5.37 dB (26 GHz ~ 40 GHz)
Duty Cycle	±0.028%
Emission Bandwidth and 99% Occupied Bandwidth	±0.0196%
Maximum Conducted Output Power	±0.766 dB
Maximum Power Spectral Density Level	±1.22 dB
Frequency Stability	±2.76%
Conducted Band-edge Compliance	±1.328 dB
Conducted Unwanted Emissions In Non-restricted Frequency Bands	±0.746 dB (9 kHz ~ 1 GHz)
	±1.328dB (1 GHz ~ 26 GHz)
Note: This uncertainty represents an expanded uncertainty expressed at approximately the 95% confidence level using a coverage factor of k=2.	

5. EQUIPMENT UNDER TEST

5.1. DESCRIPTION OF EUT

EUT Name	ASC-2680 HD Video Drone
FCC Model:	CT-6483
IC Model:	CT-6483R
Radio Technology	WLAN (IEEE 802.11a/n HT20/ac VHT20)
Operation Frequency	UNII-3: 5725 ~ 5850 MHz
Modulation	IEEE 802.11a: OFDM (64QAM, 16QAM, QPSK, BPSK) IEEE 802.11n HT20: OFDM (64QAM, 16QAM, QPSK, BPSK) IEEE 802.11ac VHT20: OFDM (256QAM, 64QAM, 16QAM, QPSK, BPSK)
Ratings	DC 3.8 V

5.2. CHANNEL LIST

UNII-3 (For Bandwidth=20MHz)		UNII-3 (For Bandwidth=40MHz)		UNII-3 (For Bandwidth=80MHz)	
Channel	Frequency (MHz)	Channel	Frequency (MHz)	Channel	Frequency (MHz)
149	5745	/	/	/	/
153	5765	/	/		
157	5785				
161	5805				
165	5825				

5.3. MAXIMUM CONDUCTED POWER

IEEE Std. 802.11	Frequency (MHz)	Maximum Average Conducted Power (dBm)
a	5725 ~ 5850	17.47
n HT20		17.22

Note: 802.11ac VHT20 test data covered by 802.11n HT20.

5.4. TEST CHANNEL CONFIGURATION

UNII-3 Test Channel Configuration		
IEEE Std.	Test Channel Number	Frequency
802.11a	CH 149(Low Channel), CH 157(MID Channel), CH 165(High Channel)	5745 MHz, 5785 MHz, 5825 MHz
802.11n HT20	CH 149(Low Channel), CH 157(MID Channel), CH 165(High Channel)	5745 MHz, 5785 MHz, 5825 MHz

Note: 802.11ac VHT20 test data covered by 802.11n HT20.

5.5. THE WORSE CASE POWER SETTING PARAMETER

The Worst Case Power Setting Parameter	
Test Software	sscom

Mode	Rate	Channel	Soft set value
			ANT1
11a	6M	149	67
		157	67
		165	69
11n HT20	MCS0	149	69
		157	65
		165	67
11ac VHT20	MCS0	149	Cover by 802.11n HT20
		157	
		165	

5.6. DESCRIPTION OF AVAILABLE ANTENNAS

Antenna No.	Frequency Band	Antenna Type	Maximum Antenna Gain (dBi)
1	5745 MHz ~ 5825 MHz	Copper tube	2.75

IEE Std. 802.11	Transmit and Receive Mode	Description
802.11a	<input checked="" type="checkbox"/> 1TX, 1RX	ANT 1 can be used as transmitting/receiving antenna.
802.11n HT20	<input checked="" type="checkbox"/> 1TX, 1RX	ANT 1 can be used as transmitting/receiving antenna.
802.11ac VHT20	<input checked="" type="checkbox"/> 1TX, 1RX	ANT 1 can be used as transmitting/receiving antenna.

5.7. THE WORSE CASE CONFIGURATIONS

The EUT was tested in the following configuration(s):

Controlled in test mode using a software application on the EUT supplied by customer. The application was used to enable a continuous transmission and to select the mode, test channels, bandwidth, data rates as required.

Test channels referring to section 5.5.

Maximum power setting referring to section 5.6.

Worst case Data Rates declared by the customer:

802.11a 20 mode: 6 Mbps

802.11n HT20 mode: MCS0

802.11ac VHT20 mode: MCS0

The measured additional path loss was included in any path loss calculations for all RF cable used during tested.

5.8. DESCRIPTION OF TEST SETUP

SUPPORT EQUIPMENT

Item	Equipment	Brand Name	Model Name	Remarks
1	Laptop	Lenovo	XIAOXIN 5000	/
2	UART	/	/	/

I/O CABLES

Cable No	Port	Connector Type	Cable Type	Cable Length(m)	Remarks
1	DC	/	/	1	/

ACCESSORIES

Item	Accessory	Brand Name	Model Name	Description
1	/	/	/	/

TEST SETUP

The EUT can work in engineering mode with a software through a Laptop.

SETUP DIAGRAM FOR TESTS

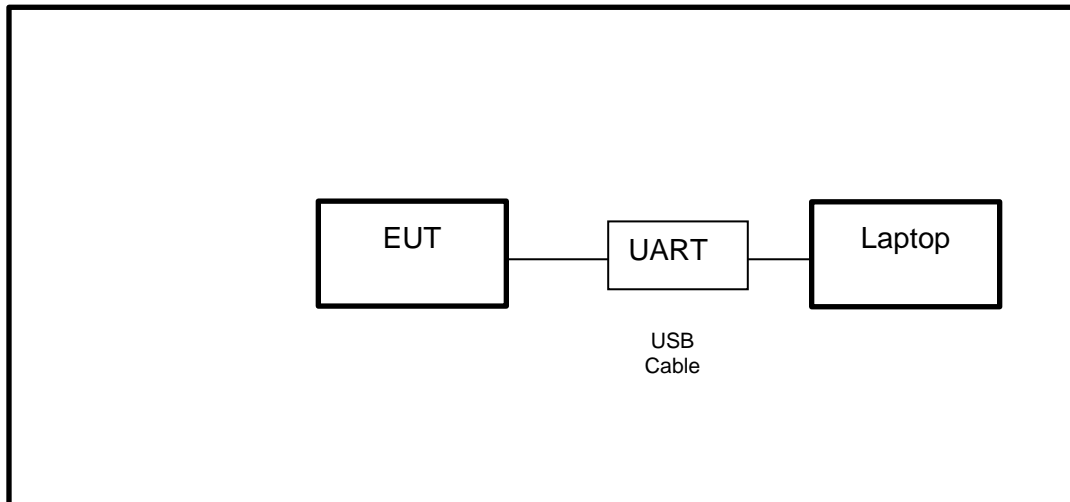

6. MEASURING EQUIPMENT AND SOFTWARE USED

R&S TS 8997 Test System					
Equipment	Manufacturer	Model No.	Serial No.	Last Cal.	Due. Date
Power sensor, Power Meter	R&S	OSP120	100921	Mar.31,2023	Mar.30,2024
Vector Signal Generator	R&S	SMBV100A	261637	Oct.17, 2022	Oct.16, 2023
Signal Generator	R&S	SMB100A	178553	Oct.17, 2022	Oct.16, 2023
Signal Analyzer	R&S	FSV40	101118	Oct.17, 2022	Oct.16, 2023
Software					
Description	Manufacturer	Name		Version	
For R&S TS 8997 Test System	Rohde & Schwarz	EMC 32		10.60.10	
Tonsend RF Test System					
Equipment	Manufacturer	Model No.	Serial No.	Last Cal.	Due. Date
Wideband Radio Communication Tester	R&S	CMW500	155523	Oct.17, 2022	Oct.16, 2023
Wireless Connectivity Tester	R&S	CMW270	1201.0002N75-102	Sep.28, 2022	Sep.27, 2023
PXA Signal Analyzer	Keysight	N9030A	MY55410512	Oct.17, 2022	Oct.16, 2023
MXG Vector Signal Generator	Keysight	N5182B	MY56200284	Oct.17, 2022	Oct.16, 2023
MXG Vector Signal Generator	Keysight	N5172B	MY56200301	Oct.17, 2022	Oct.16, 2023
DC power supply	Keysight	E3642A	MY55159130	Oct.17, 2022	Oct.16, 2023
Temperature & Humidity Chamber	SANMOOD	SG-80-CC-2	2088	Oct.17, 2022	Oct.16, 2023
Attenuator	Aglient	8495B	2814a12853	Oct.18, 2022	Oct.17, 2023
RF Control Unit	Tonscend	JS0806-2	23B80620666	April 18,2023	April 17,2024
Software					
Description	Manufacturer	Name		Version	
Tonsend SRD Test System	Tonsend	JS1120-3 RF Test System		V3.2.22	

Conducted Emissions					
Equipment	Manufacturer	Model No.	Serial No.	Last Cal.	Due Date
EMI Test Receiver	R&S	ESR3	101961	Oct.17, 2022	Oct.16, 2023
Two-Line V-Network	R&S	ENV216	101983	Oct.17, 2022	Oct.16, 2023
Software					
Description		Manufacturer	Name	Version	
Test Software for Conducted Emissions		Farad	EZ-EMC	Ver. UL-3A1	

Radiated Emissions					
Equipment	Manufacturer	Model No.	Serial No.	Last Cal.	Due Date
MXE EMI Receiver	KESIGHT	N9038A	MY56400036	Oct.17, 2022	Oct.16, 2023
Hybrid Log Periodic Antenna	TDK	HLP-3003C	130959	Aug.02, 2021	Aug.01, 2024
Preamplifier	HP	8447D	2944A09099	Oct.17, 2022	Oct.16, 2023
EMI Measurement Receiver	R&S	ESR26	101377	Oct.17, 2022	Oct.16, 2023
Horn Antenna	TDK	HRN-0118	130940	July 20, 2021	July 19, 2024
Preamplifier	TDK	PA-02-0118	TRS-305-00067	Oct.17, 2022	Oct.16, 2023
Horn Antenna	Schwarzbeck	BBHA9170	697	July 20, 2021	July 19, 2024
Preamplifier	TDK	PA-02-2	TRS-307-00003	Oct.17, 2022	Oct.16, 2023
Preamplifier	TDK	PA-02-3	TRS-308-00002	Oct.17, 2022	Oct.16, 2023
Loop antenna	Schwarzbeck	1519B	00008	Dec.14, 2021	Dec.13, 2024
Preamplifier	TDK	PA-02-001-3000	TRS-302-00050	Oct.17, 2022	Oct.16, 2023
Highpass Filter	Wainwright	WHKX10-5850-6500-1800-40SS	4	Oct.17, 2022	Oct.16, 2023
Band Reject Filter	Wainwright	WRCJV12-5695-5725-5850-5880-40SS	4	Oct.17, 2022	Oct.16, 2023
Software					
Description		Manufacturer	Name	Version	
Test Software for Radiated Emissions		Farad	EZ-EMC	Ver. UL-3A1	

7. ANTENNA PORT TEST RESULTS

7.1. ON TIME AND DUTY CYCLE

LIMITS

None; for reporting purposes only.

TEST PROCEDURE

Refer to KDB 789033 D02 General U-NII Test Procedures New Rules v02r01 section II.B.

The zero-span mode on a spectrum analyzer or EMI receiver, if the response time and spacing between bins on the sweep are sufficient to permit accurate measurements of the on and off times of the transmitted signal. Set the center frequency of the instrument to the center frequency of the transmission. Set $RBW \geq EBW$ if possible; otherwise, set RBW to the largest available value. Set $VBW \geq RBW$. Set detector = peak or average. The zero-span measurement method shall not be used unless both RBW and VBW are $> 50/T$, where T is defined in II.B.1.a), and the number of sweep points across duration T exceeds 100. (For example, if VBW and/or RBW are limited to 3 MHz, then the zero-span method of measuring duty cycle shall not be used if $T \leq 16.7$ microseconds.)

TEST SETUP

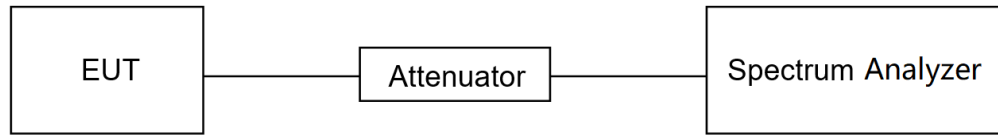

TEST ENVIRONMENT

Temperature	22.6 °C	Relative Humidity	57%
Atmosphere Pressure	101 kPa	Test Voltage	DC 3.8 V

TEST RESULTS

Please refer to section "Test Data" - Appendix H

7.2. 6DB AND 26DB EMISSION BANDWIDTH AND 99% OCCUPIED BANDWIDTH

LIMITS

CFR 47 FCC Part15, Subpart E ISED RSS-247 ISSUE 2		
Test Item	Limit	Frequency Range (MHz)
26 dB Emission Bandwidth	For reporting purposes only.	5150 ~ 5250
6 dB Emission Bandwidth	The minimum 6 dB emission bandwidth shall be 500 kHz.	5725 ~ 5850
99 % Occupied Bandwidth	For reporting purposes only.	5150 ~ 5825 (For ISED)

TEST PROCEDURE

Refer to KDB 789033 D02 General U-NII Test Procedures New Rules v02r01 section II.C1. for 26 dB Emission Bandwidth; section II.C2. for 6 dB Emission Bandwidth; section II.D. for 99 % Occupied Bandwidth.

Connect the EUT to the spectrum analyzer and use the following settings:

Center Frequency	The center frequency of the channel under test
Detector	Peak
RBW	For 6 dB Emission Bandwidth: RBW=100 kHz For 26 dB Emission bandwidth: approximately 1 % of the EBW. For 99 % Occupied Bandwidth: approximately 1 % ~ 5 % of the OBW.
VBW	For 6 dB Bandwidth: $\geq 3 \times \text{RBW}$ For 26 dB Bandwidth: $> 3 \times \text{RBW}$ For 99 % Bandwidth: $> 3 \times \text{RBW}$
Trace	Max hold
Sweep	Auto couple

a) Use the 99 % power bandwidth function of the instrument, allow the trace to stabilize and report the measured bandwidth.

b) Allow the trace to stabilize and measure the maximum width of the emission that is constrained by the frequencies associated with the two outermost amplitude points (upper and lower frequencies) that are attenuated by 6/26 dB relative to the maximum level measured in the fundamental emission.

TEST SETUP

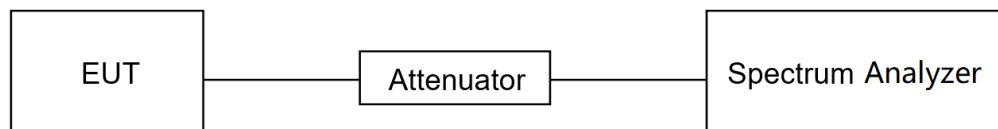

TEST ENVIRONMENT

Temperature	22.6 °C	Relative Humidity	57%
Atmosphere Pressure	101 kPa	Test Voltage	DC 3.8 V

TEST RESULTS

Please refer to section "Test Data" - Appendix A1 & A2 & A3

7.3. CONDUCTED OUTPUT POWER

LIMITS

CFR 47 FCC Part15, Subpart E		
Test Item	Limit	Frequency Range (MHz)
Conducted Output Power	<input type="checkbox"/> Outdoor Access Point: 1 W (30 dBm) <input type="checkbox"/> Indoor Access Point: 1 W (30 dBm) <input type="checkbox"/> Fixed Point-To-Point Access Points: 1 W (30 dBm) <input type="checkbox"/> Client Devices: 250 mW (24 dBm)	5150 ~ 5250
	Shall not exceed 1 Watt (30 dBm).	5725 ~ 5850

ISED RSS-247 ISSUE 2		
Test Item	Limit	Frequency Range (MHz)
Conducted Output Power or e.i.r.p.	The maximum e.i.r.p. shall not exceed 200 mW (23 dBm) or $10 + 10 \log_{10} B$, dBm, whichever power is less. B is the 99 % emission bandwidth in megahertz.	5150 ~ 5250
	Shall not exceed 1 Watt (30 dBm). The e.i.r.p. shall not exceed 4 W	5725 ~ 5850

Note:

The above limits are based upon the maximum antenna gain does not exceed 6 dBi. If transmitting antennas of directional gain greater than 6 dBi are used, the maximum conducted output power shall be reduced by the amount in dB that the directional gain of the antenna exceeds 6 dBi.

TEST PROCEDURE

Refer to KDB 789033 D02 General U-NII Test Procedures New Rules v02r01 section II.E.

Method PM (Measurement using an RF average power meter):

(i) Measurements may be performed using a wideband RF power meter with a thermocouple detector or equivalent if all of the following conditions are satisfied:

- a. The EUT is configured to transmit continuously or to transmit with a constant duty cycle.
- b. At all times when the EUT is transmitting, it must be transmitting at its maximum power control level.
- c. The integration period of the power meter exceeds the repetition period of the transmitted signal by at least a factor of five.

(ii) If the transmitter does not transmit continuously, measure the duty cycle, x , of the transmitter output signal as described in II.B.

(iii) Measure the average power of the transmitter. This measurement is an average over both the on and off periods of the transmitter.

(iv) Adjust the measurement in dBm by adding $10 \log (1/x)$ where x is the duty cycle (e.g., $10 \log (1/0.25)$ if the duty cycle is 25 %).

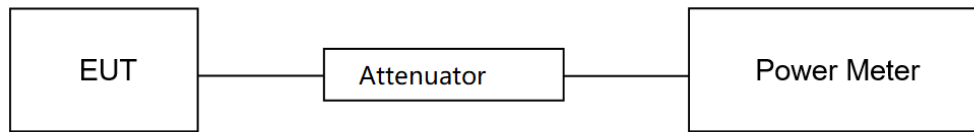
TEST SETUP**TEST ENVIRONMENT**

Temperature	22.6 °C	Relative Humidity	57%
Atmosphere Pressure	101 kPa	Test Voltage	DC 3.8 V

TEST RESULTS

Please refer to section "Test Data" - Appendix B

7.4. POWER SPECTRAL DENSITY

LIMITS

CFR 47 FCC Part15, Subpart E		
Test Item	Limit	Frequency Range (MHz)
Power Spectral Density	<input type="checkbox"/> Outdoor Access Point: 17 dBm/MHz <input type="checkbox"/> Indoor Access Point: 17 dBm/MHz <input type="checkbox"/> Fixed Point-To-Point Access Points: 17 dBm/MHz <input type="checkbox"/> Client Devices: 11 dBm/MHz	5150 ~ 5250
	30 dBm/500kHz	5725 ~ 5850

ISED RSS-247 ISSUE 2		
Test Item	Limit	Frequency Range (MHz)
Power Spectral Density	The e.i.r.p. spectral density shall not exceed 10 dBm in any 1.0 MHz band.	5150 ~ 5250
	30 dBm / 500 kHz	5725 ~ 5850

Note:

The above limits are based upon the maximum antenna gain does not exceed 6 dBi. If transmitting antennas of directional gain greater than 6 dBi are used, maximum power spectral density shall be reduced by the amount in dB that the directional gain of the antenna exceeds 6 dBi.

TEST PROCEDURE

Refer to KDB 789033 D02 General U-NII Test Procedures New Rules v02r01 section II.F.

Connect the EUT to the spectrum analyzer and use the following settings:

For U-NII-3:

Center Frequency	The center frequency of the channel under test
Detector	RMS
RBW	500 kHz
VBW	$\geq 3 \times$ RBW
Span	Encompass the entire emissions bandwidth (EBW) of the signal
Trace	Max hold
Sweep time	Auto

Allow trace to fully stabilize and Use the peak search function on the instrument to find the peak of the spectrum and record its value.

Add $10 \log(1/x)$, where x is the duty cycle, to the peak of the spectrum, the result is the Maximum PSD over 1 MHz / 500 kHz reference bandwidth.

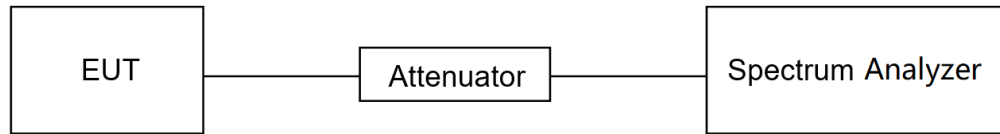
TEST SETUP**TEST ENVIRONMENT**

Temperature	22.6 °C	Relative Humidity	57%
Atmosphere Pressure	101 kPa	Test Voltage	DC 3.8 V

TEST RESULTS

Please refer to section "Test Data" - Appendix C

7.5. FREQUENCY STABILITY

LIMITS

The frequency of the carrier signal shall be maintained within band of operation.

TEST PROCEDURE

1. The EUT was placed inside an environmental chamber as the temperature in the chamber was varied between 0 °C ~ 40 °C (declared by customer).
2. The temperature was incremented by 10 °C intervals and the unit allowed to stabilize at each temperature before each measurement. The center frequency of the transmitting channel was evaluated at each temperature and the frequency deviation from the channel's center frequency was recorded.
3. The primary supply voltage is varied from 85 % to 115 % of the nominal value for non hand-carried battery and AC powered equipment. For hand-carried, battery-powered equipment, primary supply voltage is reduced to the battery operating end point which shall be specified by the manufacturer.

Connect the EUT to the spectrum analyzer and use the following settings:

Center Frequency	The center frequency of the channel under test
Detector	Peak
RBW	10 kHz
VBW	$\geq 3 \times \text{RBW}$
Span	Encompass the entire emissions bandwidth (EBW) of the signal
Trace	Max hold
Sweep time	Auto

4. While maintaining a constant temperature inside the environmental chamber, turn the EUT on and record the operating frequency at startup, and at 2 minutes, 5 minutes, and 10 minutes after the EUT is energized.
5. Allow the trace to stabilize, find the peak value of the power envelope and record the frequency, then calculated the frequency drift.

TEST ENVIRONMENT

	Normal Test Conditions	Extreme Test Conditions
Relative Humidity	20 % - 75 %	/
Atmospheric Pressure	100 kPa ~ 102 kPa	/
Temperature	T _N (Normal Temperature): 22 °C ~ 28 °C	T _L (Low Temperature): -10 °C
		T _H (High Temperature): 55 °C
Supply Voltage	V _N (Normal Voltage): DC 3.8 V	V _L (Low Voltage): DC 3.23 V
		V _H (High Voltage): DC 4.37 V

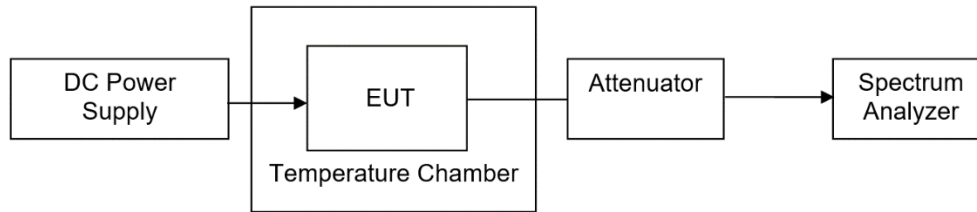
TEST SETUP

TEST ENVIRONMENT

Temperature	22.6 °C	Relative Humidity	57%
Atmosphere Pressure	101 kPa	Test Voltage	DC 3.8 V

TEST RESULTS

Please refer to section "Test Data" - Appendix G

8. RADIATED TEST RESULTS

LIMITS

Refer to CFR 47 FCC §15.205, §15.209 and §15.407 (b).

Refer to ISED RSS-GEN Clause 8.9, Clause 8.10 and ISED RSS-247 6.2.

Radiation Disturbance Test Limit for FCC (Class B) (9 kHz ~ 1 GHz)

Emissions radiated outside of the specified frequency bands above 30 MHz			
Frequency Range (MHz)	Field Strength Limit (uV/m) at 3 m	Field Strength Limit (dBuV/m) at 3 m	
		Quasi-Peak	
30 - 88	100	40	
88 - 216	150	43.5	
216 - 960	200	46	
Above 960	500	54	
Above 1000	500	Peak	Average
		74	54

FCC Emissions radiated outside of the specified frequency bands below 30 MHz		
Frequency (MHz)	Field strength (microvolts/meter)	Measurement distance (meters)
0.009-0.490	2400/F(kHz)	300
0.490-1.705	24000/F(kHz)	30
1.705-30.0	30	30

ISED General field strength limits at frequencies below 30 MHz

Table 6 – General field strength limits at frequencies below 30 MHz		
Frequency	Magnetic field strength (H-Field) (uA/m)	Measurement distance (m)
9 - 490 kHz ^{Note 1}	6.37/F (F in kHz)	300
490 - 1705 kHz	63.7/F (F in kHz)	30
1.705 - 30 MHz	0.08	30

Note 1: The emission limits for the ranges 9-90 kHz and 110-490 kHz are based on measurements employing a linear average detector.

ISED Restricted bands refer to ISED RSS-GEN Clause 8.10

Table 7 – Restricted frequency bands ^{Note 1}		
MHz	MHz	GHz
0.090 - 0.110	149.9 - 150.05	9.0 - 9.2
0.495 - 0.505	156.52475 - 156.52525	9.3 - 9.5
2.1735 - 2.1905	156.7 - 156.9	10.6 - 12.7
3.020 - 3.026	162.0125 - 167.17	13.25 - 13.4
4.125 - 4.128	167.72 - 173.2	14.47 - 14.5
4.17725 - 4.17775	240 - 285	15.35 - 16.2
4.20725 - 4.20775	322 - 335.4	17.7 - 21.4
5.677 - 5.683	399.9 - 410	22.01 - 23.12
6.215 - 6.218	608 - 614	23.6 - 24.0
6.26775 - 6.26825	960 - 1427	31.2 - 31.8
6.31175 - 6.31225	1435 - 1626.5	36.43 - 36.5
8.291 - 8.294	1645.5 - 1646.5	Above 38.6
8.362 - 8.366	1660 - 1710	
8.37625 - 8.38675	1718.8 - 1722.2	
8.41425 - 8.41475	2200 - 2300	
12.29 - 12.293	2310 - 2390	
12.51975 - 12.52025	2483.5 - 2500	
12.57675 - 12.57725	2655 - 2900	
13.36 - 13.41	3260 - 3267	
16.42 - 16.423	3332 - 3339	
16.69475 - 16.69525	3345.8 - 3358	
16.80425 - 16.80475	3500 - 4400	
25.5 - 25.67	4500 - 5150	
37.5 - 38.25	5350 - 5460	
73 - 74.6	7250 - 7750	
74.8 - 75.2	8025 - 8500	
108 - 138		

Note 1: Certain frequency bands listed in table 7 and in bands above 38.6 GHz are designated for licence-exempt applications. These frequency bands and the requirements that apply to related devices are set out in the 200 and 300 series of RSSs.

FCC Restricted bands of operation refer to FCC §15.205 (a):

MHz	MHz	MHz	GHz
0.090-0.110	16.42-16.423	399.9-410	4.5-5.15
¹ 0.495-0.505	16.69475-16.69525	608-614	5.35-5.46
2.1735-2.1905	16.80425-16.80475	960-1240	7.25-7.75
4.125-4.128	25.5-25.67	1300-1427	8.025-8.5
4.17725-4.17775	37.5-38.25	1435-1626.5	9.0-9.2
4.20725-4.20775	73-74.6	1645.5-1646.5	9.3-9.5
6.215-6.218	74.8-75.2	1660-1710	10.6-12.7
6.26775-6.26825	108-121.94	1718.8-1722.2	13.25-13.4
6.31175-6.31225	123-138	2200-2300	14.47-14.5
8.291-8.294	149.9-150.05	2310-2390	15.35-16.2
8.362-8.366	156.52475-156.52525	2483.5-2500	17.7-21.4
8.37625-8.38675	156.7-156.9	2690-2900	22.01-23.12
8.41425-8.41475	162.0125-167.17	3260-3267	23.6-24.0
12.29-12.293	167.72-173.2	3332-3339	31.2-31.8
12.51975-12.52025	240-285	3345.8-3358	36.43-36.5
12.57675-12.57725	322-335.4	3600-4400	(²)
13.36-13.41			

Note: ¹Until February 1, 1999, this restricted band shall be 0.490-0.510 MHz.

²Above 38.6c

Limits of unwanted/undesirable emission out of the restricted bands refer to CFR 47 FCC §15.407 (b) and ISSED RSS-247 6.2.

LIMITS OF RADIATED EMISSION MEASUREMENT (Above 1GHz)		
Frequency Range (MHz)	EIRP Limit	Field Strength Limit (dBuV/m) at 3 m
5150~5250 MHz	PK: -27 (dBm/MHz)	PK:68.2(dBμV/m)
5725~5850 MHz	PK: -27 (dBm/MHz) *1 PK: 10 (dBm/MHz) *2 PK: 15.6 (dBm/MHz) *3 PK: 27 (dBm/MHz) *4	PK: 68.2(dBμV/m) *1 PK: 105.2 (dBμV/m) *2 PK: 110.8(dBμV/m) *3 PK: 122.2 (dBμV/m) *4
Note: *1 beyond 75 MHz or more above of the band edge. *2 below the band edge increasing linearly to 10 dBm/MHz at 25 MHz above. *3 below the band edge increasing linearly to a level of 15.6 dBm/MHz at 5 MHz above. *4 from 5 MHz above or below the band edge increasing linearly to a level of 27 dBm/MHz at the band edge.		

TEST PROCEDURE

Below 30 MHz

The setting of the spectrum analyzer

RBW	200 Hz (From 9 kHz to 0.15 MHz)/ 9 kHz (From 0.15 MHz to 30 MHz)
VBW	200 Hz (From 9 kHz to 0.15 MHz)/ 9 kHz (From 0.15 MHz to 30 MHz)
Sweep	Auto

1. The testing follows the guidelines in ANSI C63.10-2013 clause 6.4.
2. The EUT was arranged to its worst case and then turntable (from 0 degree to 360 degrees) to find the maximum reading. A pre-amp and a high pass filter are used for the test in order to get better signal level. Both Horizontal, Face-on and Face-off polarizations of the antenna are set to make the measurement.
3. The EUT was placed on a turntable with 80 cm above ground.
4. The EUT was set 3 meters from the interference receiving antenna, which was mounted on the top of a 1 m height antenna tower.
5. The radiated emission limits are based on measurements employing a CISPR quasi-peak detector except for the frequency bands 9-90 kHz, 110-490 kHz and above 1000 MHz Radiated emission limits in these three bands are based on measurements employing an average detector.
6. For measurement below 1 GHz, the initial step in collecting conducted emission data is a spectrum analyzer peak detector mode pre-scanning the measurement frequency range. Significant peaks are then marked and then Quasi Peak and average detector mode re-measured. If the emission level of the EUT measured by the peak detector is 3 dB lower than the applicable limit, the peak emission level will be reported. Otherwise, the emission measurement will be repeated using the quasi-peak and average detector and reported.
7. Although these tests were performed other than open field site, adequate comparison measurements were confirmed against 30m open field site. Therefore sufficient tests were made to demonstrate that the alternative site produces results that correlate with the ones of tests made in an open field site based on KDB 414788.
8. The limits in CFR 47, Part 15, Subpart C, paragraph 15.209 (a), are identical to those in RSS-GEN Section 8.9, Table 6, since the measurements are performed in terms of magnetic field strength and converted to electric field strength levels (as reported in the table) using the free space impedance of 377Ω . For example, the measurement frequency X KHz resulted in a level of Y dBuV/m, which is equivalent to $Y-51.5 = Z$ dBuA/m, which has the same margin, W dB, to the corresponding RSS-GEN Table 6 limit as it has to be 15.209(a) limit.

Below 1 GHz and above 30 MHz

The setting of the spectrum analyzer

RBW	120 kHz
VBW	300 kHz
Sweep	Auto
Detector	Peak/QP
Trace	Max hold

1. The testing follows the guidelines in ANSI C63.10-2013 clause 6.5.
2. The EUT was arranged to its worst case and then tune the antenna tower (from 1 m to 4 m) and turntable (from 0 degree to 360 degrees) to find the maximum reading. A pre-amp and a high pass filter are used for the test in order to get better signal level. Both horizontal and vertical polarizations of the antenna are set to make the measurement.
3. The EUT was placed on a turntable with 80 cm above ground.
4. The EUT was set 3 meters from the interference receiving antenna, which was mounted on the top of a variable height antenna tower.
5. For measurement below 1 GHz, the initial step in collecting conducted emission data is a spectrum analyzer peak detector mode pre-scanning the measurement frequency range. Significant peaks are then marked and then Quasi Peak detector mode re-measured. If the emission level of the EUT measured by the peak detector is 3 dB lower than the applicable limit, the peak emission level will be reported. Otherwise, the emission measurement will be repeated using the quasi-peak detector and reported.

Above 1 GHz

The setting of the spectrum analyzer

RBW	1 MHz
VBW	PEAK: 3 MHz AVG: see note 6
Sweep	Auto
Detector	Peak
Trace	Max hold

1. The testing follows the guidelines in KDB 789033 D02 General U-NII Test Procedures New Rules v02r01 section II.G.3 ~ II.G.6.
2. The EUT was arranged to its worst case and then tune the antenna tower (from 1 m to 4 m) and turntable (from 0 degree to 360 degrees) to find the maximum reading. A pre-amp and a high pass filter are used for the test in order to get better signal level. Both horizontal and vertical polarizations of the antenna are set to make the measurement.
3. The EUT was placed on a turntable with 1.5 m above ground.
4. The EUT was set 3 meters from the interference receiving antenna, which was mounted on the top of a variable height antenna tower.
5. For measurement above 1 GHz, the emission measurement will be measured by the peak detector. This peak level, once corrected, must comply with the limit specified in Section 15.209.
6. For measurements above 1 GHz the resolution bandwidth is set to 1 MHz, then the video bandwidth is set to 3 MHz for peak measurements and 1 MHz resolution bandwidth with 1/T video bandwidth with peak detector for average measurements. For the Duty Cycle please refer to clause 7.1.ON TIME AND DUTY CYCLE.

For Restricted Bandedge:

Note:

1. Measurement = Reading Level + Correct Factor.
2. If the peak values are less than the average limit of 54 dBuV/m, the average result is deemed to comply with average limit.
3. Peak: Peak detector.
4. AVG: $VBW=1/Ton$, where: Ton is the transmitting duration.
5. For the transmitting duration, please refer to clause 7.1.
6. Only the worst data was recorded, if it complies with the limit, the other emissions deemed to comply with the limit.
7. Both horizontal and vertical have been tested, only the worst data was recorded in the report.
8. All modes, channels and antennas have been tested, only the worst data was recorded in the report.

For Radiate Spurious emission (9 kHz ~ 30 MHz):

Note:

1. Measurement = Reading Level + Correct Factor.
2. If the peak values are less than the QP limit, the QP result is deemed to comply with QP limit.
3. All 3 polarizations (Horizontal, Face-on and Face-off) of the loop antenna had been tested, but only the worst data recorded in the report.
4. All modes, channels and antennas have been tested, only the worst data was recorded in the report.

For Radiate Spurious Emission (30 MHz ~ 1 GHz):

Note:

1. Result Level = Read Level + Correct Factor.
2. If the peak values are less than the QP limit, the QP result is deemed to comply with QP limit.
3. All modes, channels and antennas have been tested, only the worst data was recorded in the report.

For Radiate Spurious Emission (1 GHz ~ 7 GHz):

1. Measurement = Reading Level + Correct Factor.
2. If the peak values are less than the average limit of 54 dBuV/m, the average result is deemed to comply with average limit.
3. Peak: Peak detector.
4. AVG: $VBW=1/Ton$, where: Ton is the transmitting duration.
5. For the transmitting duration, please refer to clause 7.1.
6. Filter losses were only considered in the spurious frequency bands and the authorized band was not corrected for Band reject filter losses.
7. Proper operation of the transmitter prior to adding the filter to the measurement chain.
8. Since non-restricted band peak emissions are less than the average limit, they also comply with the -27dBm/MHz (68.2dBuV/m) limit.
9. All modes, channels and antennas have been tested, only the worst data was recorded in the report.

For Radiate Spurious Emission (7 GHz ~ 18 GHz):

Note:

1. Peak Result = Reading Level + Correct Factor.
2. If the peak values are less than the average limit of 54 dBuV/m, the average result is deemed to comply with average limit.
3. Peak: Peak detector.
4. AVG: $VBW=1/Ton$, where: Ton is the transmitting duration.
5. For the transmitting duration, please refer to clause 7.1.
6. Filter losses were only considered in the spurious frequency bands and the authorized band was not corrected for High Pass Filter losses.
7. Proper operation of the transmitter prior to adding the filter to the measurement chain.
8. Since non-restricted band peak emissions are less than the average limit, they also comply with the -27dBm/MHz (68.2dBuV/m) limit.
9. All modes, channels and antennas have been tested, only the worst data was recorded in the report.

For Radiate Spurious emission (18 GHz ~ 26 GHz):

Note:

1. Measurement = Reading Level + Correct Factor.
2. If the peak values are less than the average limit of 54 dBuV/m, the average result is deemed to comply with average limit.
3. Peak: Peak detector.
4. All modes, channels and antennas have been tested, only the worst data was recorded in the report.

For Radiate Spurious emission (26 GHz ~ 40 GHz):

Note:

1. Measurement = Reading Level + Correct Factor.
2. If the peak values are less than the average limit of 54 dBuV/m, the average result is deemed to comply with average limit.
3. Peak: Peak detector.
4. All modes, channels and antennas have been tested, only the worst data was recorded in the report.

TEST SETUP

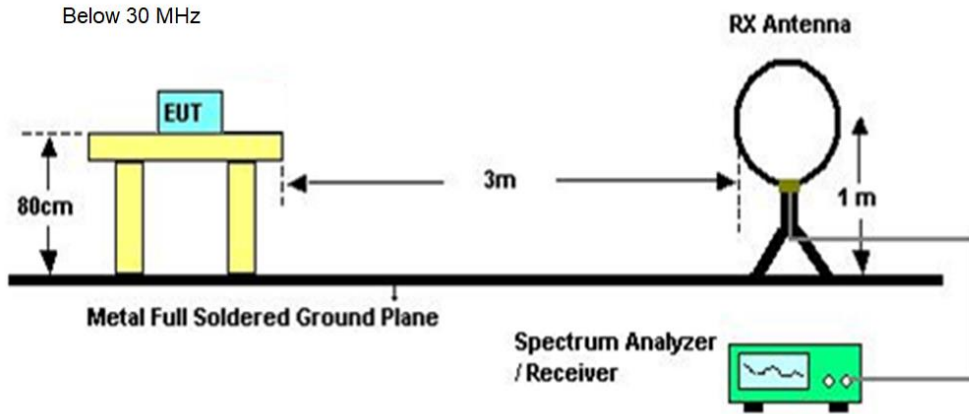

Below 1 GHz and above 30 MHz

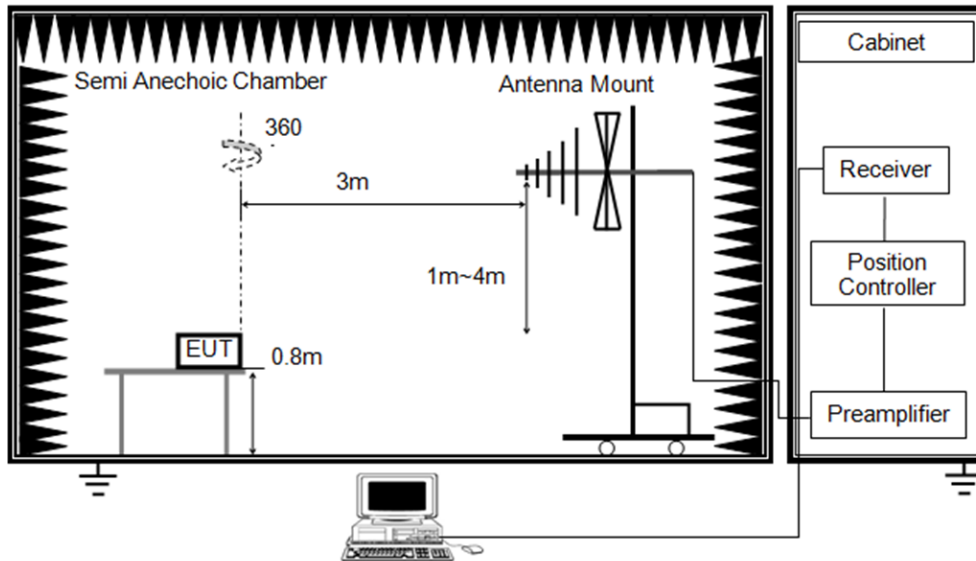

Above 1 GHz

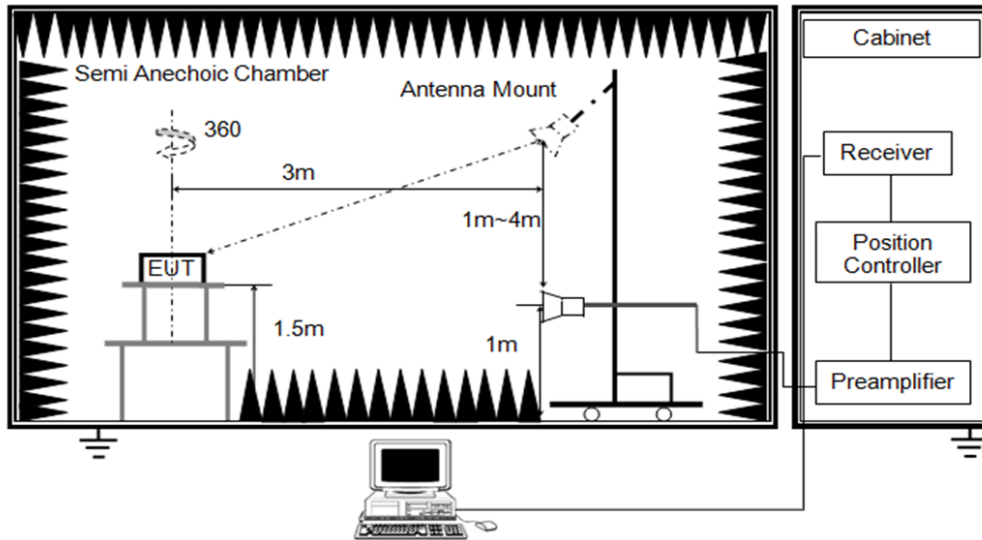

TEST ENVIRONMENT

Temperature	24.3 °C	Relative Humidity	61%
Atmosphere Pressure	101 kPa	Test Voltage	DC 3.8 V

TEST RESULTS

8.1. RESTRICTED BANDEDGE

Test Mode:	802.11a 20 Peak	Channel:	5745 MHz
Polarity:	Horizontal	Test Voltage:	DC 3.8 V

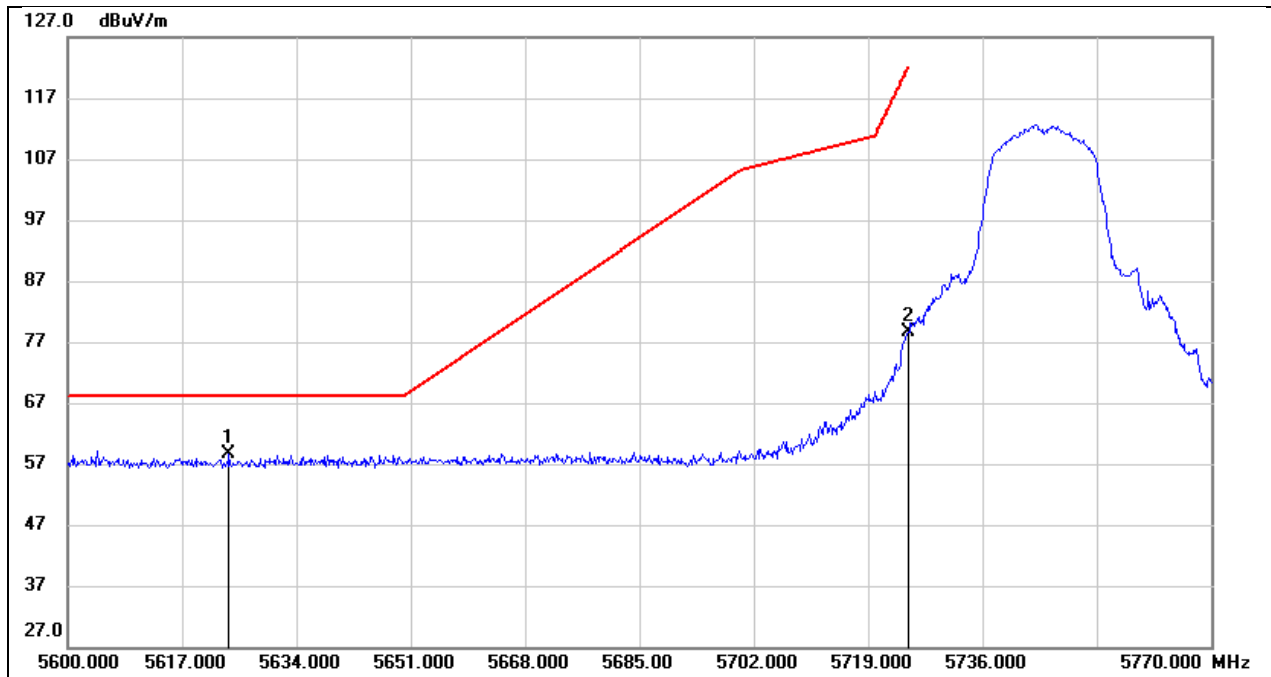

No.	Frequency (MHz)	Reading (dBuV)	Correct (dB/m)	Result (dBuV/m)	Limit (dBuV/m)	Margin (dB)	Remark
1	5623.970	17.60	40.99	58.59	68.20	-9.61	peak
2	5725.000	37.30	41.27	78.57	122.20	-43.63	peak

Test Mode:	802.11a 20 Peak	Channel:	5825 MHz
Polarity:	Horizontal	Test Voltage:	DC 3.8 V

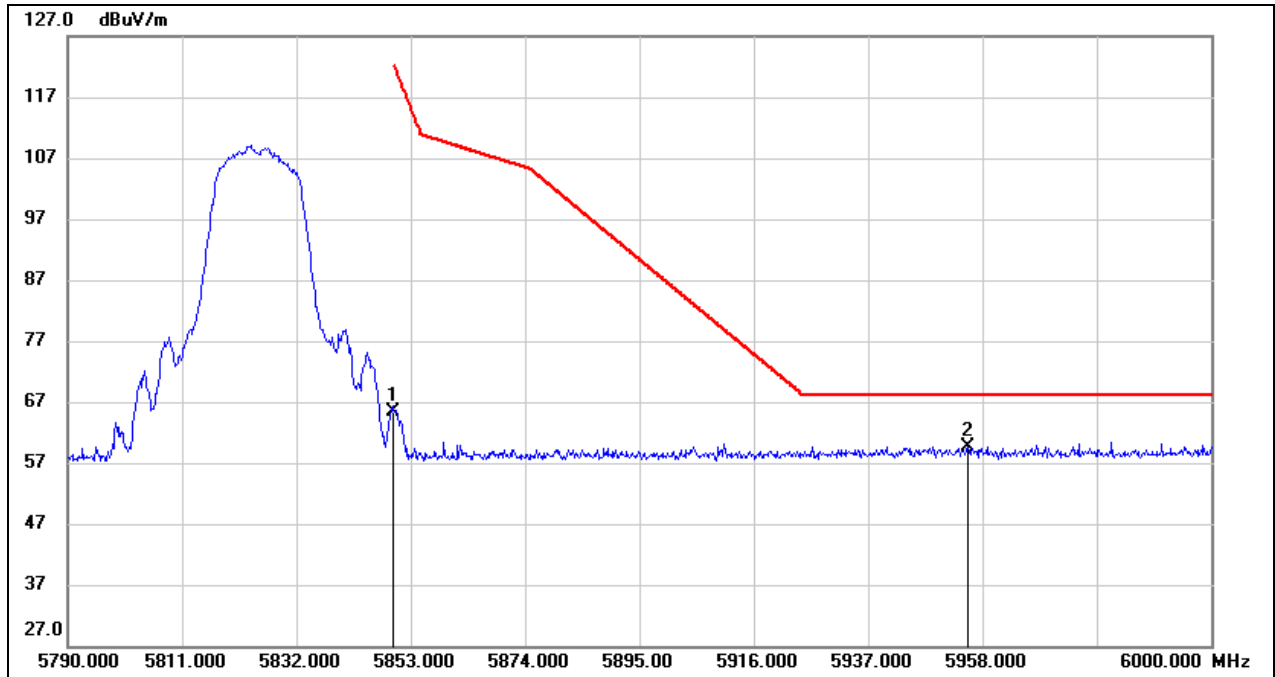

No.	Frequency (MHz)	Reading (dBuV)	Correct (dB/m)	Result (dBuV/m)	Limit (dBuV/m)	Margin (dB)	Remark
1	5850.000	23.82	41.60	65.42	122.20	-56.78	peak
2	5955.270	17.86	41.88	59.74	68.20	-8.46	peak

Test Mode:	802.11n HT20 Peak	Channel:	5745 MHz
Polarity:	Horizontal	Test Voltage:	DC 3.8 V

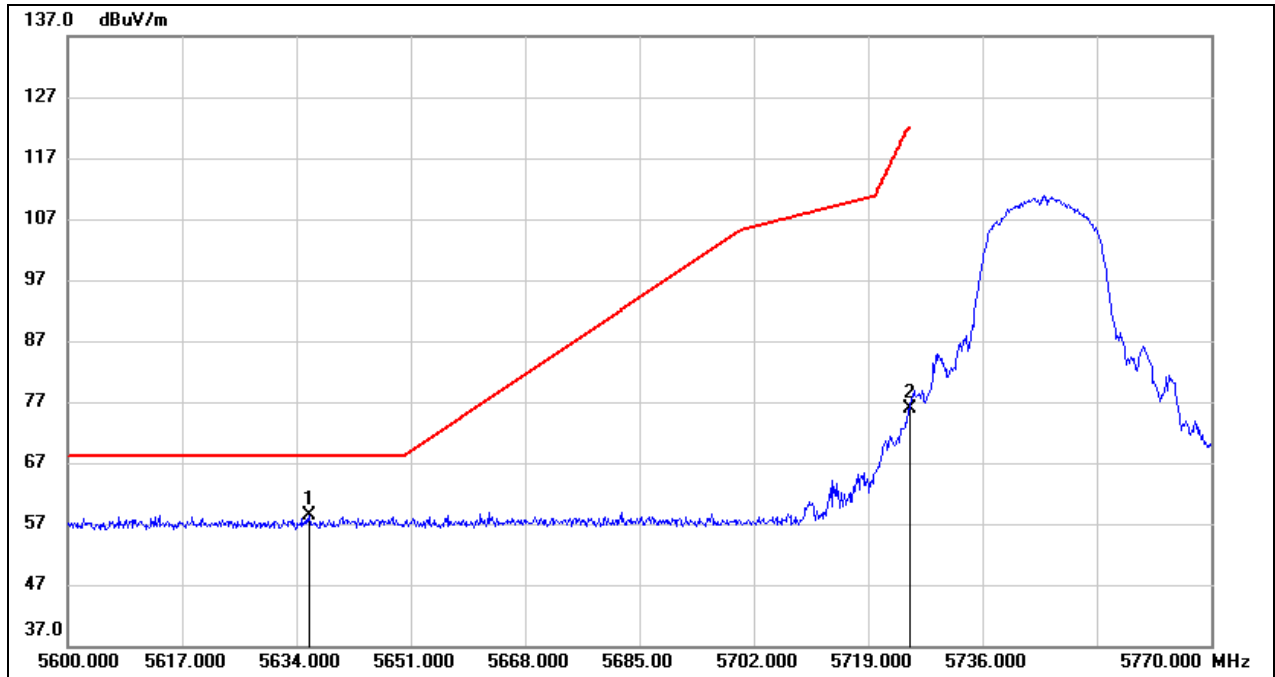

No.	Frequency (MHz)	Reading (dBuV)	Correct (dB/m)	Result (dBuV/m)	Limit (dBuV/m)	Margin (dB)	Remark
1	5635.870	17.25	41.03	58.28	68.20	-9.92	peak
2	5725.000	34.64	41.27	75.91	122.20	-46.29	peak

Test Mode:	802.11n HT20 Peak	Channel:	5825 MHz
Polarity:	Horizontal	Test Voltage:	DC 3.8 V

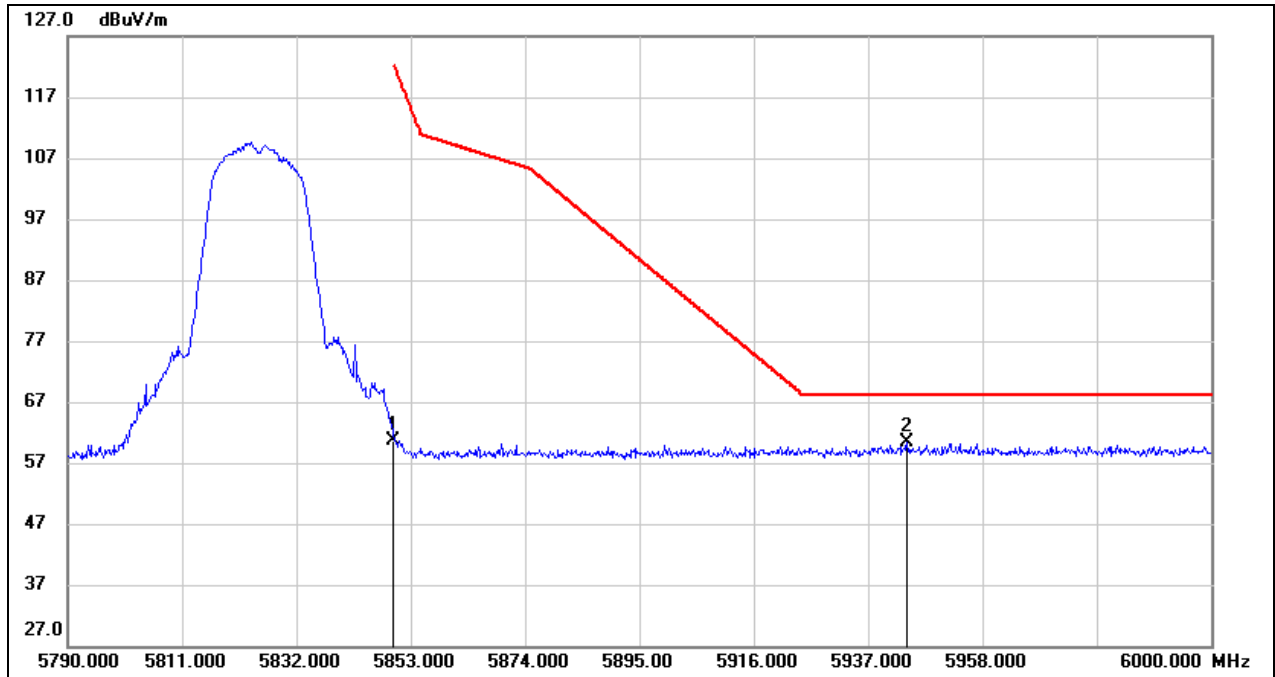

No.	Frequency (MHz)	Reading (dBuV)	Correct (dB/m)	Result (dBuV/m)	Limit (dBuV/m)	Margin (dB)	Remark
1	5850.000	19.13	41.60	60.73	122.20	-61.47	peak
2	5944.140	18.59	41.85	60.44	68.20	-7.76	peak

8.2. SPURIOUS EMISSIONS (1 GHZ ~ 7 GHZ)

Test Mode:	802.11a 20	Channel:	5745 MHz
Polarity:	Horizontal	Test Voltage:	DC 3.8 V

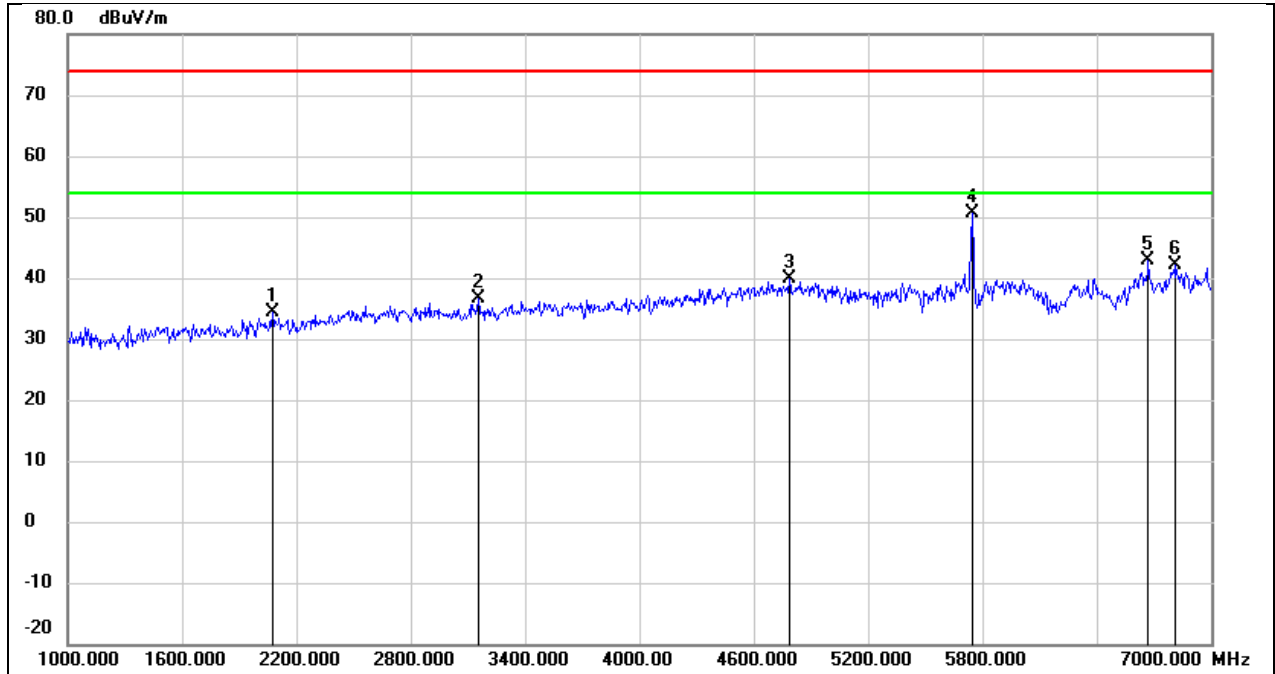

No.	Frequency (MHz)	Reading (dBuV)	Correct (dB/m)	Result (dBuV/m)	Limit (dBuV/m)	Margin (dB)	Remark
1	2074.000	45.03	-10.68	34.35	74.00	-39.65	peak
2	3154.000	43.15	-6.63	36.52	74.00	-37.48	peak
3	4786.000	40.83	-1.00	39.83	74.00	-34.17	peak
4	5745.000	49.42	1.12	50.54	/	/	Fundamental
5	6670.000	38.29	4.57	42.86	74.00	-31.14	peak
6	6814.000	36.87	5.28	42.15	74.00	-31.85	peak

Test Mode:	802.11a 20	Channel:	5745 MHz
Polarity:	Vertical	Test Voltage:	DC 3.8 V

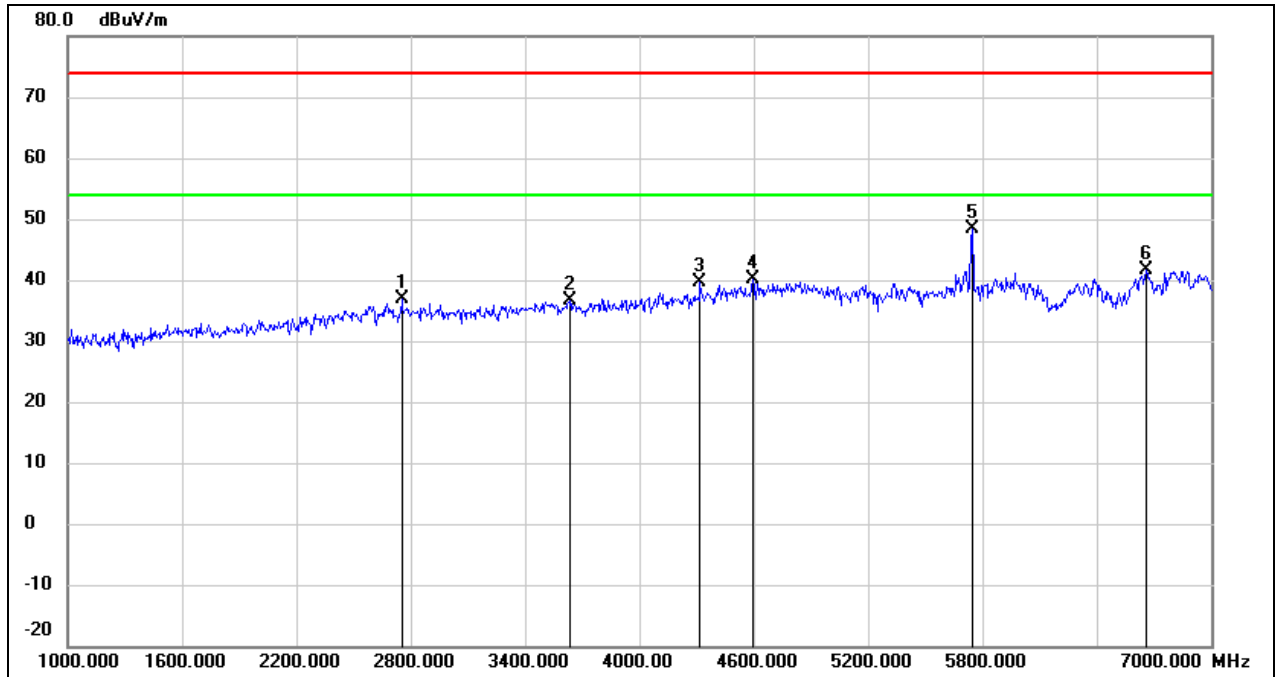

No.	Frequency (MHz)	Reading (dBuV)	Correct (dB/m)	Result (dBuV/m)	Limit (dBuV/m)	Margin (dB)	Remark
1	2752.000	44.54	-7.73	36.81	74.00	-37.19	peak
2	3634.000	42.03	-5.48	36.55	74.00	-37.45	peak
3	4318.000	42.55	-2.99	39.56	74.00	-34.44	peak
4	4594.000	41.99	-1.76	40.23	74.00	-33.77	peak
5	5745.000	47.16	1.12	48.28	/	/	Fundamental
6	6658.000	37.08	4.49	41.57	74.00	-32.43	peak

Test Mode:	802.11a 20	Channel:	5785 MHz
Polarity:	Horizontal	Test Voltage:	DC 3.8 V

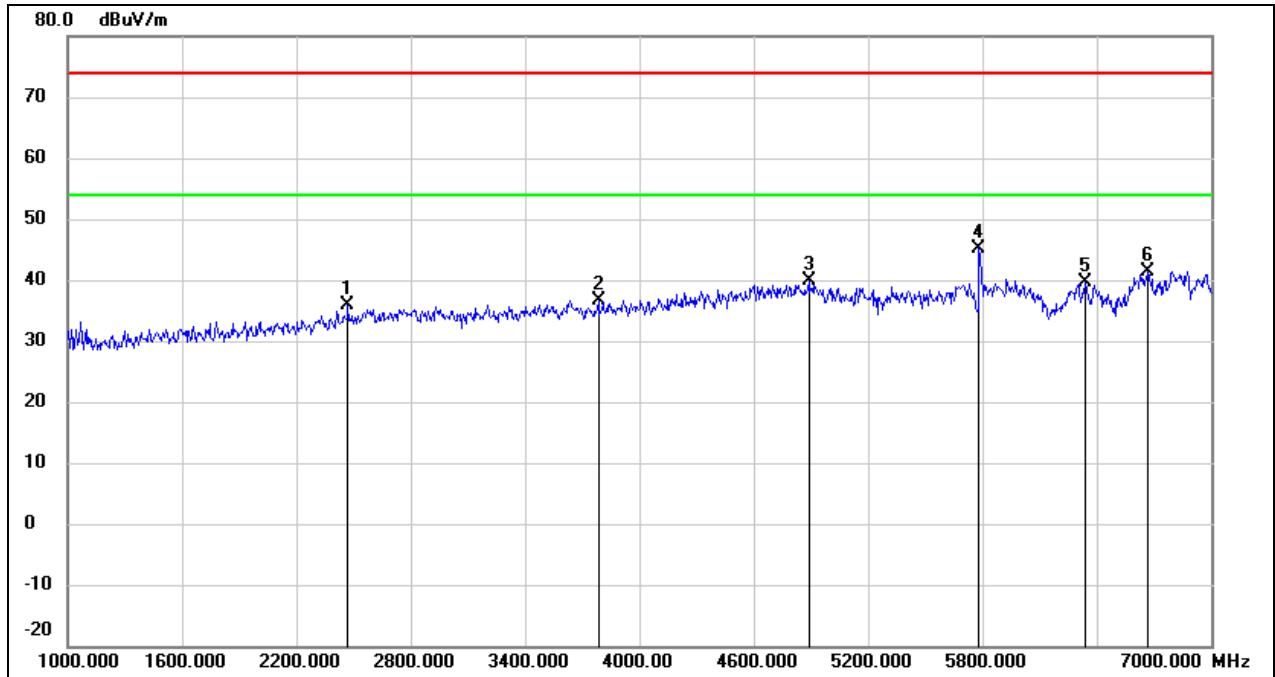

No.	Frequency (MHz)	Reading (dBuV)	Correct (dB/m)	Result (dBuV/m)	Limit (dBuV/m)	Margin (dB)	Remark
1	2470.000	44.58	-8.65	35.93	74.00	-38.07	peak
2	3784.000	41.82	-5.07	36.75	74.00	-37.25	peak
3	4888.000	40.42	-0.60	39.82	74.00	-34.18	peak
4	5785.000	44.02	1.23	45.25	/	/	Fundamental
5	6340.000	36.57	3.12	39.69	74.00	-34.31	peak
6	6670.000	36.77	4.57	41.34	74.00	-32.66	peak

Test Mode:	802.11a 20	Channel:	5785 MHz
Polarity:	Vertical	Test Voltage:	DC 3.8 V

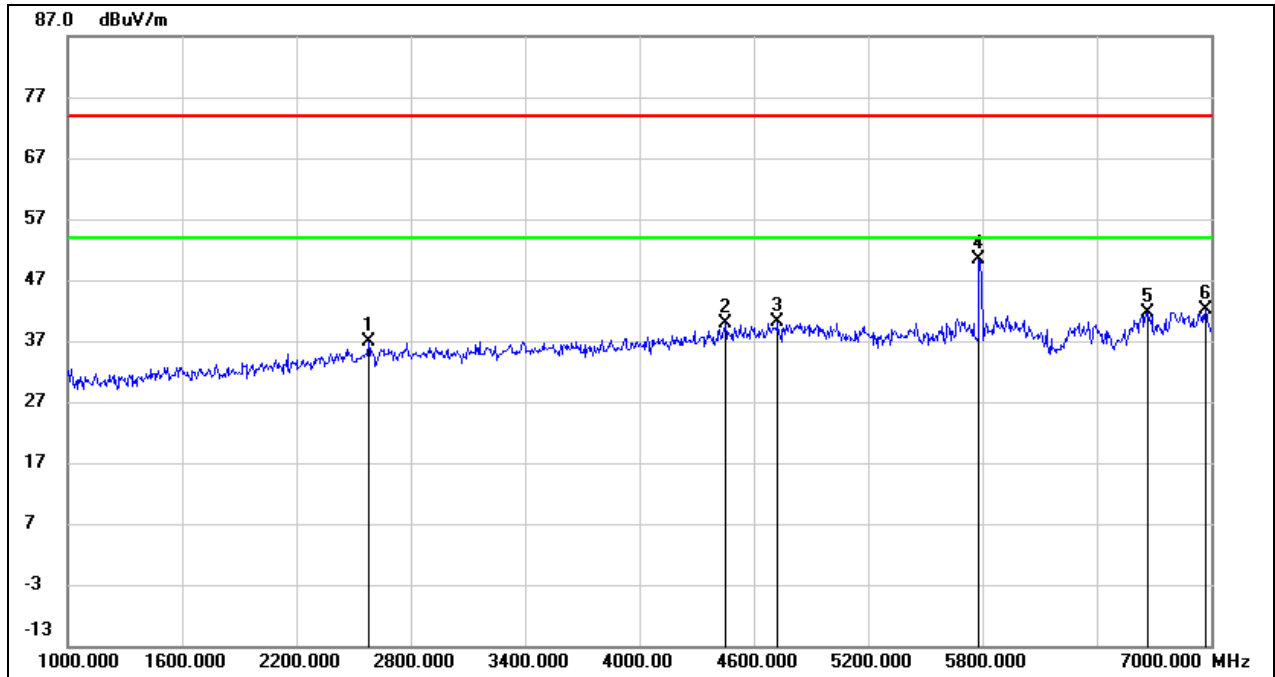

No.	Frequency (MHz)	Reading (dBuV)	Correct (dB/m)	Result (dBuV/m)	Limit (dBuV/m)	Margin (dB)	Remark
1	2578.000	45.16	-8.26	36.90	74.00	-37.10	peak
2	4450.000	42.14	-2.37	39.77	74.00	-34.23	peak
3	4726.000	41.25	-1.24	40.01	74.00	-33.99	peak
4	5785.000	49.24	1.23	50.47	/	/	Fundamental
5	6664.000	37.06	4.54	41.60	74.00	-32.40	peak
6	6970.000	36.06	6.05	42.11	74.00	-31.89	peak

Test Mode:	802.11a 20	Channel:	5825 MHz
Polarity:	Horizontal	Test Voltage:	DC 3.8 V

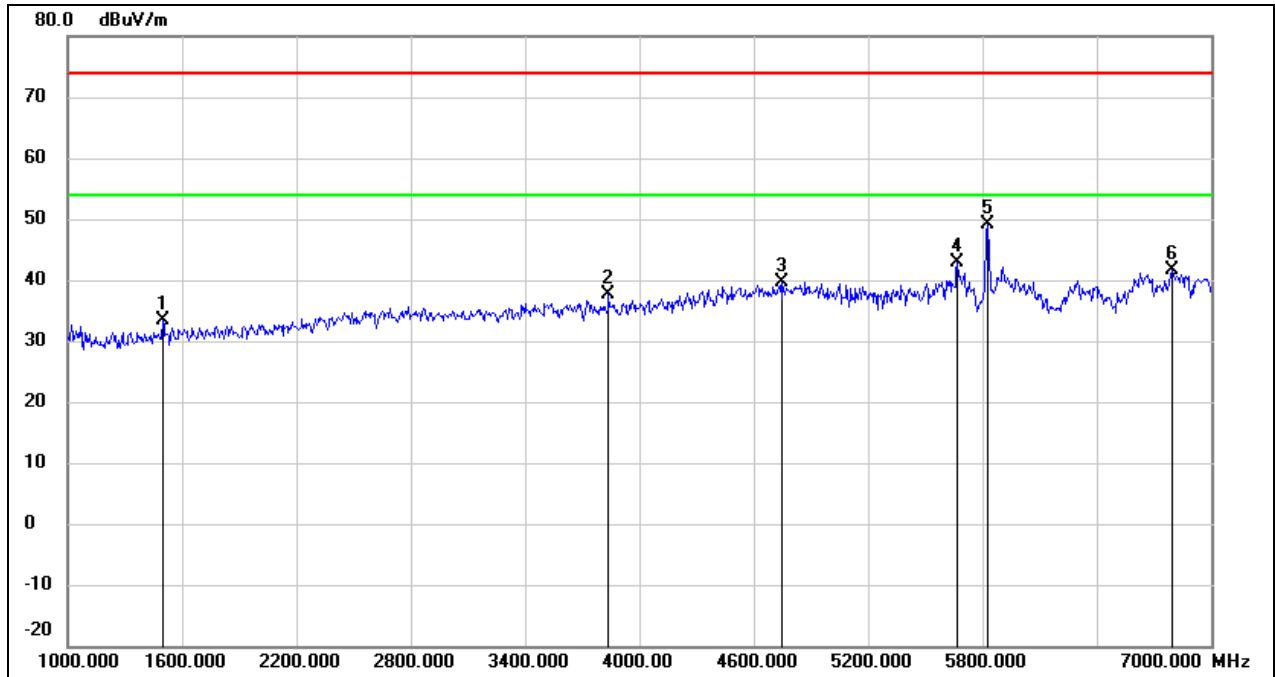

No.	Frequency (MHz)	Reading (dBuV)	Correct (dB/m)	Result (dBuV/m)	Limit (dBuV/m)	Margin (dB)	Remark
1	1498.000	46.18	-12.72	33.46	74.00	-40.54	peak
2	3838.000	42.56	-4.92	37.64	74.00	-36.36	peak
3	4750.000	40.76	-1.14	39.62	74.00	-34.38	peak
4	5668.000	41.86	0.91	42.77	74.00	-31.23	peak
5	5825.000	47.72	1.36	49.08	/	/	Fundamental
6	6796.000	36.37	5.19	41.56	74.00	-32.44	peak

Test Mode:	802.11a 20	Channel:	5825 MHz
Polarity:	Vertical	Test Voltage:	DC 3.8 V

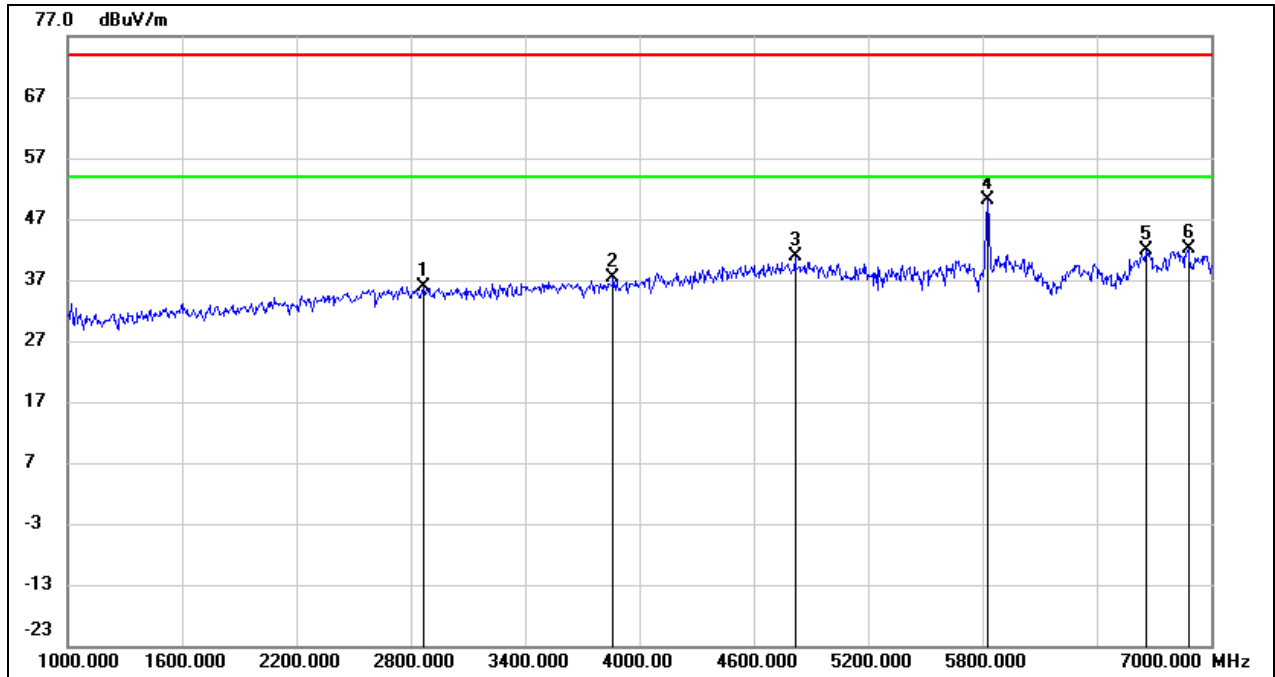

No.	Frequency (MHz)	Reading (dBuV)	Correct (dB/m)	Result (dBuV/m)	Limit (dBuV/m)	Margin (dB)	Remark
1	2866.000	43.33	-7.38	35.95	74.00	-38.05	peak
2	3862.000	42.14	-4.86	37.28	74.00	-36.72	peak
3	4816.000	41.89	-0.89	41.00	74.00	-33.00	peak
4	5825.000	48.68	1.36	50.04	/	/	Fundamental
5	6658.000	37.46	4.49	41.95	74.00	-32.05	peak
6	6880.000	36.64	5.60	42.24	74.00	-31.76	peak

8.3. SPURIOUS EMISSIONS (7 GHZ ~ 18 GHZ)

Test Mode:	802.11a 20	Channel:	5745 MHz
Polarity:	Horizontal	Test Voltage:	DC 3.8 V

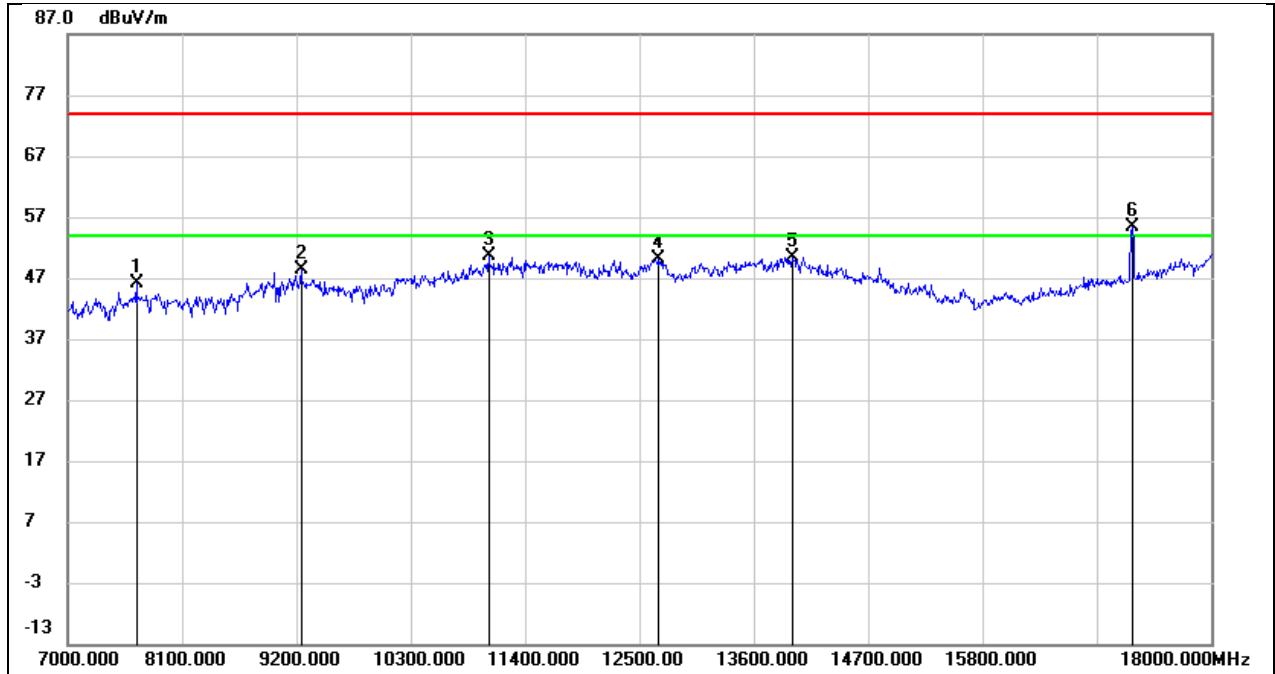

No.	Frequency (MHz)	Reading (dBuV)	Correct (dB/m)	Result (dBuV/m)	Limit (dBuV/m)	Margin (dB)	Remark
1	7660.000	39.31	6.73	46.04	74.00	-27.96	peak
2	9244.000	37.78	10.49	48.27	74.00	-25.73	peak
3	11048.000	35.60	14.91	50.51	74.00	-23.49	peak
4	12687.000	32.19	18.05	50.24	74.00	-23.76	peak
5	13974.000	28.59	21.82	50.41	74.00	-23.59	peak
6	17241.000	33.72	21.62	55.34	74.00	-18.66	peak

Test Mode:	802.11a 20	Channel:	5745 MHz
Polarity:	Vertical	Test Voltage:	DC 3.8 V

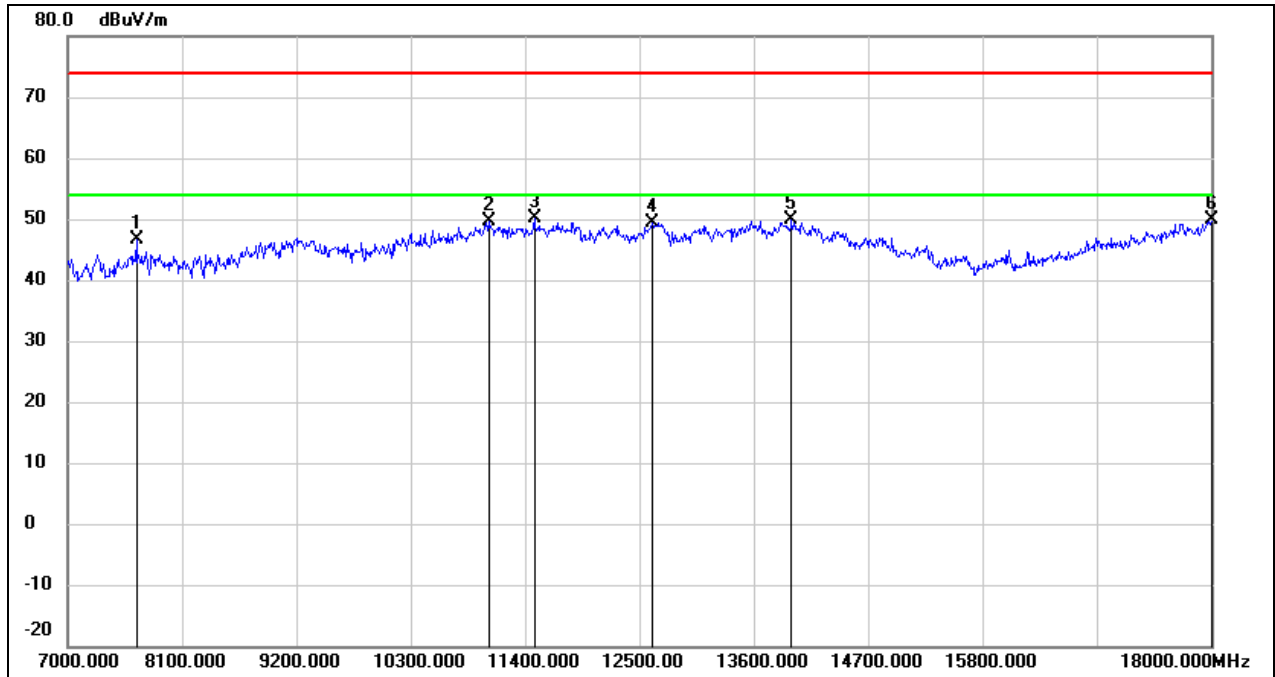

No.	Frequency (MHz)	Reading (dBuV)	Correct (dB/m)	Result (dBuV/m)	Limit (dBuV/m)	Margin (dB)	Remark
1	7660.000	39.80	6.73	46.53	74.00	-27.47	peak
2	11048.000	34.70	14.91	49.61	74.00	-24.39	peak
3	11488.000	33.42	16.72	50.14	74.00	-23.86	peak
4	12621.000	31.43	17.98	49.41	74.00	-24.59	peak
5	13963.000	28.06	21.78	49.84	74.00	-24.16	peak
6	18000.000	23.64	26.12	49.76	74.00	-24.24	peak

Test Mode:	802.11a 20	Channel:	5785 MHz
Polarity:	Horizontal	Test Voltage:	DC 3.8 V

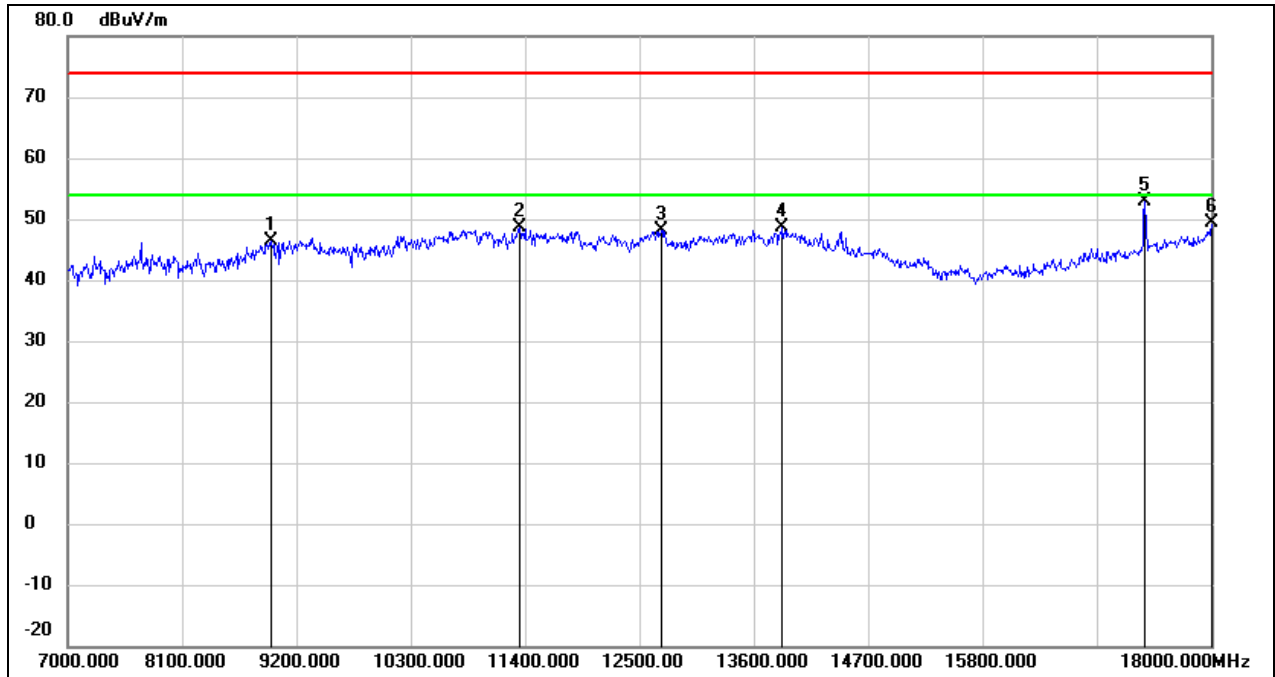

No.	Frequency (MHz)	Reading (dBuV)	Correct (dB/m)	Result (dBuV/m)	Limit (dBuV/m)	Margin (dB)	Remark
1	8958.000	36.44	10.05	46.49	74.00	-27.51	peak
2	11345.000	32.42	16.14	48.56	74.00	-25.44	peak
3	12709.000	30.14	18.09	48.23	74.00	-25.77	peak
4	13875.000	27.09	21.57	48.66	74.00	-25.34	peak
5	17362.000	30.81	22.12	52.93	74.00	-21.07	peak
6	18000.000	23.15	26.12	49.27	74.00	-24.73	peak

Test Mode:	802.11a 20	Channel:	5785 MHz
Polarity:	Vertical	Test Voltage:	DC 3.8 V

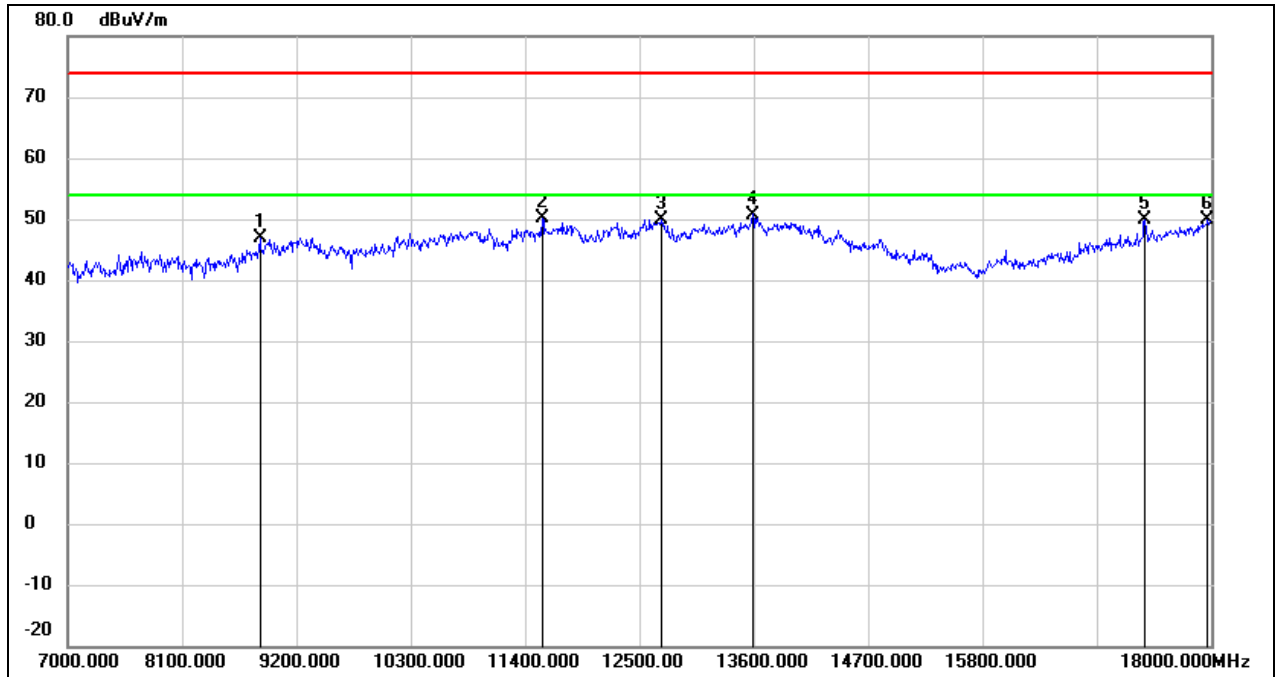

No.	Frequency (MHz)	Reading (dBuV)	Correct (dB/m)	Result (dBuV/m)	Limit (dBuV/m)	Margin (dB)	Remark
1	8848.000	37.65	9.29	46.94	74.00	-27.06	peak
2	11565.000	33.16	16.89	50.05	74.00	-23.95	peak
3	12709.000	31.71	18.09	49.80	74.00	-24.20	peak
4	13589.000	29.89	20.86	50.75	74.00	-23.25	peak
5	17362.000	27.76	22.12	49.88	74.00	-24.12	peak
6	17967.000	24.05	25.89	49.94	74.00	-24.06	peak

Test Mode:	802.11a 20	Channel:	5825 MHz
Polarity:	Horizontal	Test Voltage:	DC 3.8 V

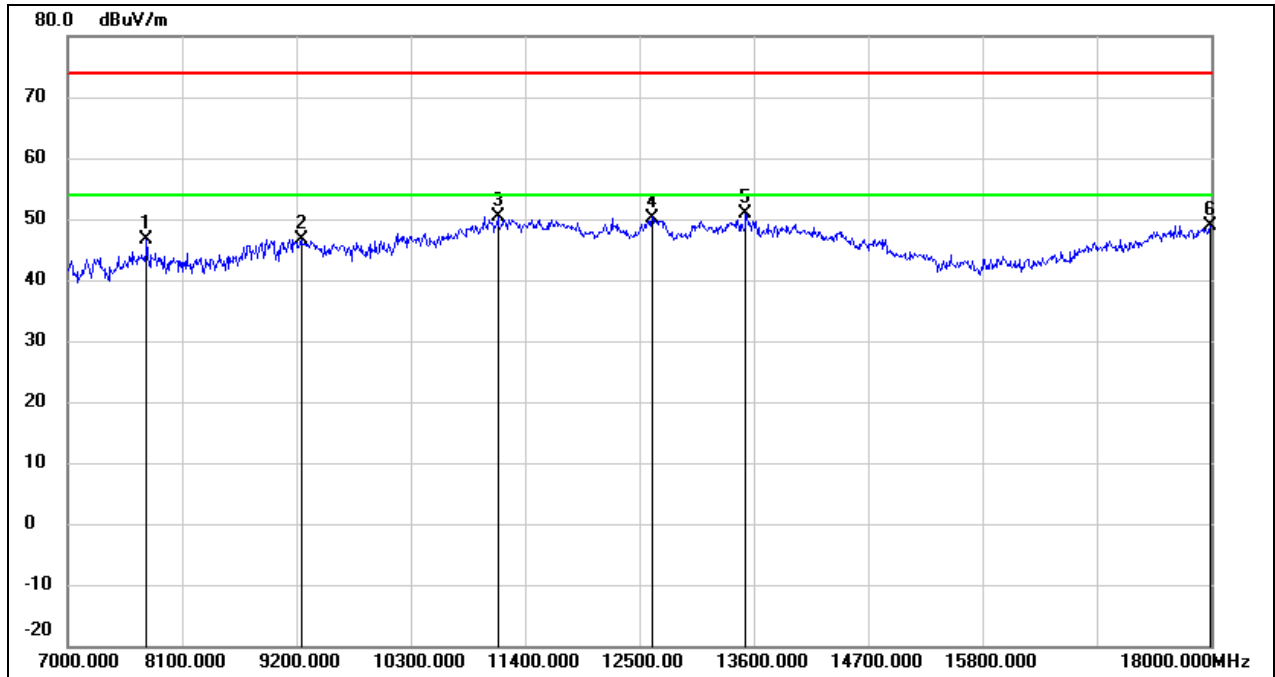

No.	Frequency (MHz)	Reading (dBuV)	Correct (dB/m)	Result (dBuV/m)	Limit (dBuV/m)	Margin (dB)	Remark
1	7759.000	39.87	6.64	46.51	74.00	-27.49	peak
2	9244.000	36.22	10.49	46.71	74.00	-27.29	peak
3	11136.000	35.16	15.27	50.43	74.00	-23.57	peak
4	12621.000	32.27	17.98	50.25	74.00	-23.75	peak
5	13523.000	30.09	20.70	50.79	74.00	-23.21	peak
6	17989.000	22.81	26.04	48.85	74.00	-25.15	peak

Test Mode:	802.11a 20	Channel:	5825 MHz
Polarity:	Vertical	Test Voltage:	DC 3.8 V

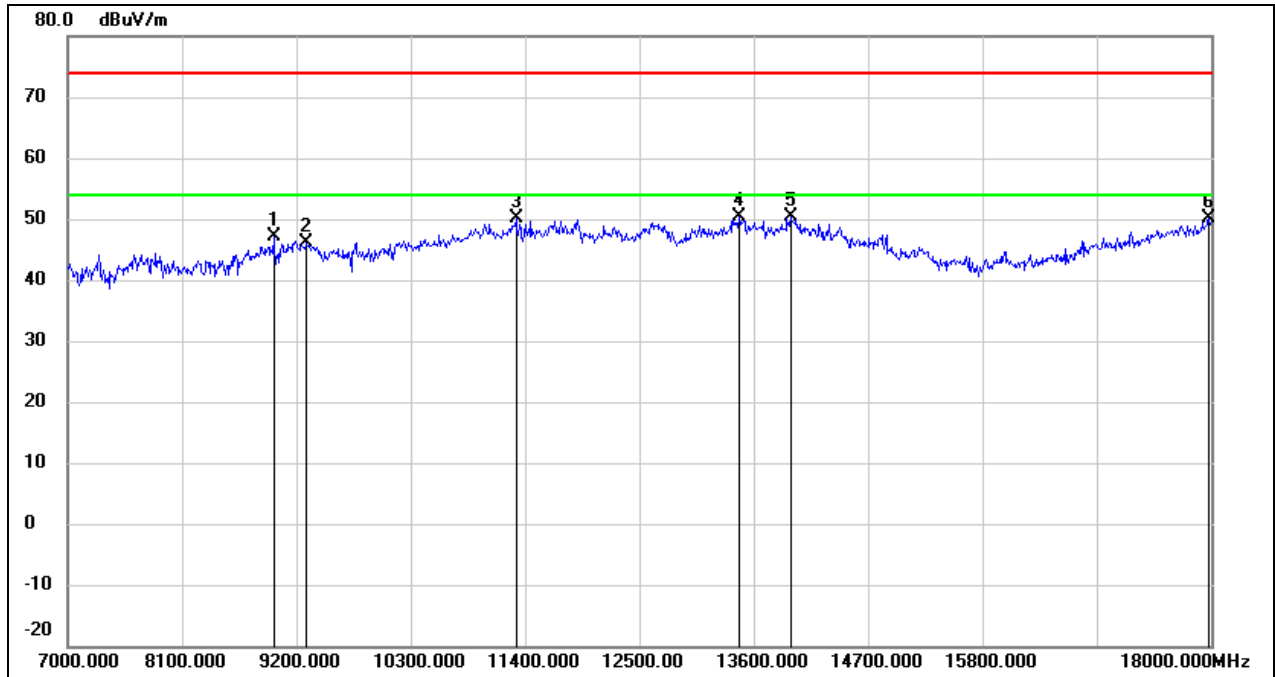

No.	Frequency (MHz)	Reading (dBuV)	Correct (dB/m)	Result (dBuV/m)	Limit (dBuV/m)	Margin (dB)	Remark
1	8980.000	36.83	10.21	47.04	74.00	-26.96	peak
2	9299.000	35.69	10.53	46.22	74.00	-27.78	peak
3	11312.000	34.15	16.00	50.15	74.00	-23.85	peak
4	13457.000	29.98	20.46	50.44	74.00	-23.56	peak
5	13952.000	28.51	21.76	50.27	74.00	-23.73	peak
6	17978.000	24.07	25.97	50.04	74.00	-23.96	peak

Test Mode:	802.11n HT20	Channel:	5745 MHz
Polarity:	Horizontal	Test Voltage:	DC 3.8 V

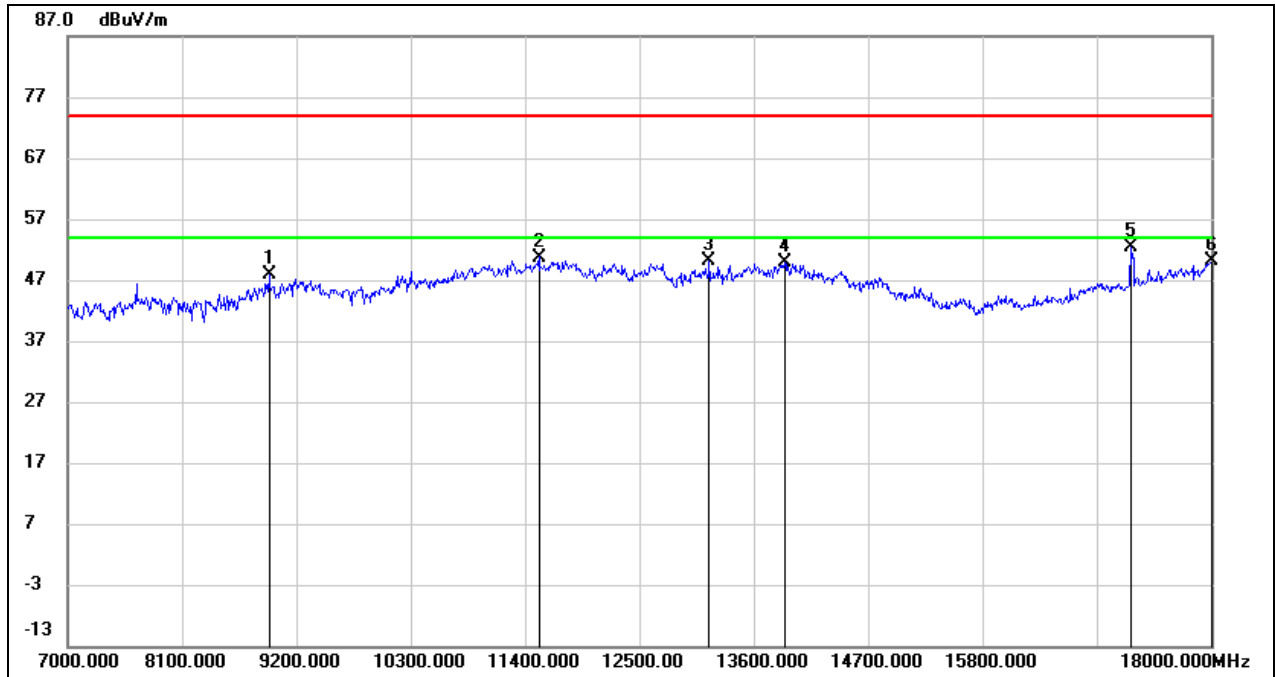

No.	Frequency (MHz)	Reading (dBuV)	Correct (dB/m)	Result (dBuV/m)	Limit (dBuV/m)	Margin (dB)	Remark
1	8936.000	38.05	9.90	47.95	74.00	-26.05	peak
2	11532.000	33.92	16.83	50.75	74.00	-23.25	peak
3	13171.000	31.03	19.20	50.23	74.00	-23.77	peak
4	13897.000	28.26	21.62	49.88	74.00	-24.12	peak
5	17230.000	30.80	21.57	52.37	74.00	-21.63	peak
6	18000.000	23.93	26.12	50.05	74.00	-23.95	peak

Test Mode:	802.11n HT20	Channel:	5745 MHz
Polarity:	Vertical	Test Voltage:	DC 3.8 V

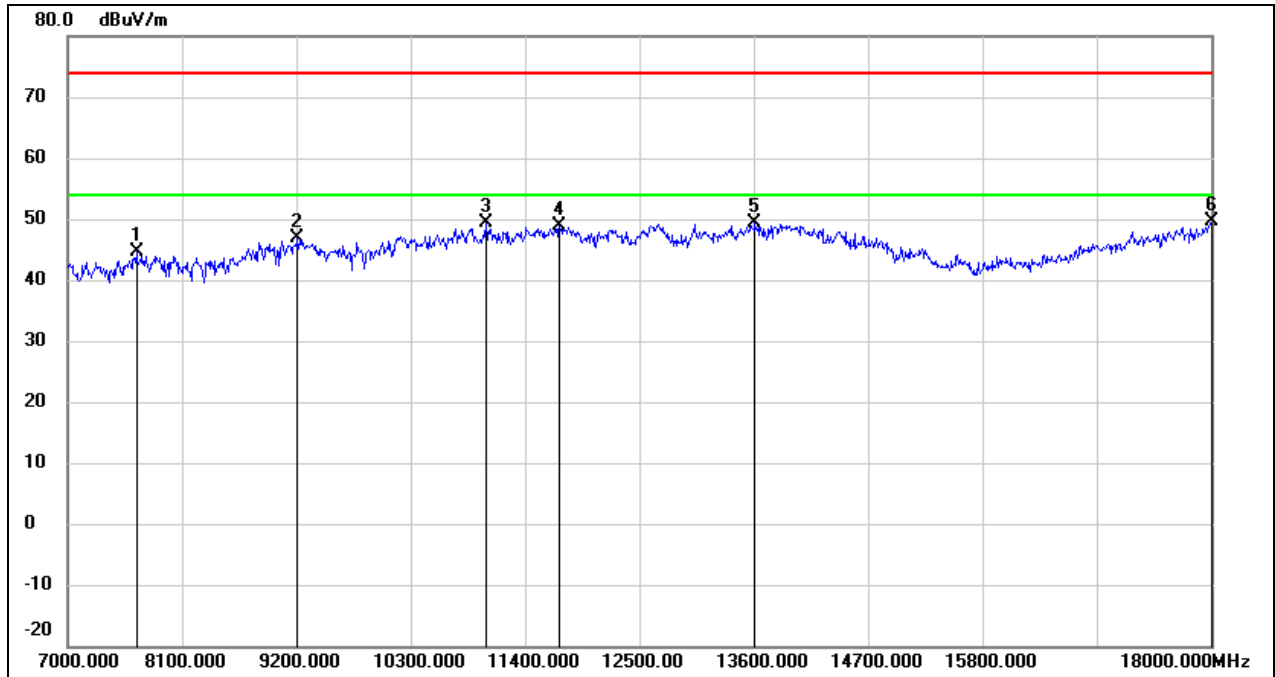

No.	Frequency (MHz)	Reading (dBuV)	Correct (dB/m)	Result (dBuV/m)	Limit (dBuV/m)	Margin (dB)	Remark
1	7660.000	37.97	6.73	44.70	74.00	-29.30	peak
2	9211.000	36.30	10.47	46.77	74.00	-27.23	peak
3	11026.000	34.58	14.82	49.40	74.00	-24.60	peak
4	11730.000	31.61	17.19	48.80	74.00	-25.20	peak
5	13611.000	28.43	20.92	49.35	74.00	-24.65	peak
6	18000.000	23.56	26.12	49.68	74.00	-24.32	peak

Test Mode:	802.11n HT20	Channel:	5785 MHz
Polarity:	Horizontal	Test Voltage:	DC 3.8 V

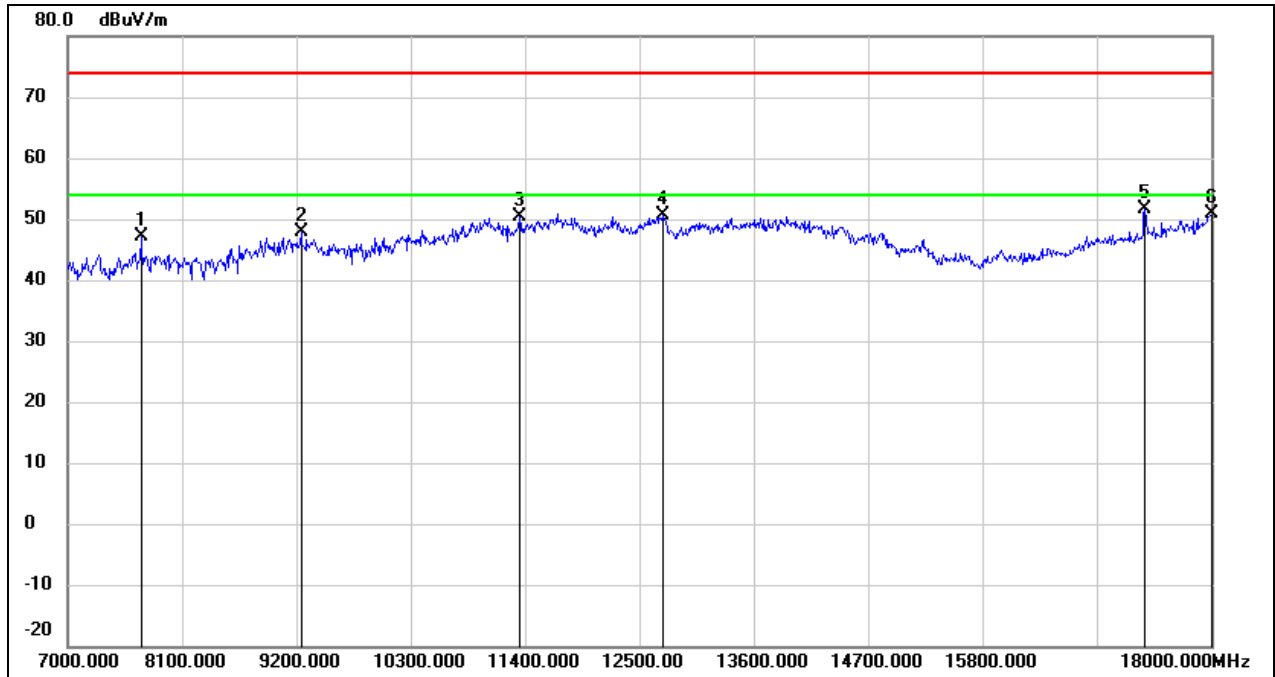

No.	Frequency (MHz)	Reading (dBuV)	Correct (dB/m)	Result (dBuV/m)	Limit (dBuV/m)	Margin (dB)	Remark
1	7704.000	40.43	6.69	47.12	74.00	-26.88	peak
2	9244.000	37.37	10.49	47.86	74.00	-26.14	peak
3	11345.000	34.26	16.14	50.40	74.00	-23.60	peak
4	12720.000	32.43	18.09	50.52	74.00	-23.48	peak
5	17362.000	29.52	22.12	51.64	74.00	-22.36	peak
6	18000.000	24.64	26.12	50.76	74.00	-23.24	peak

Test Mode:	802.11n HT20	Channel:	5785 MHz
Polarity:	Vertical	Test Voltage:	DC 3.8 V

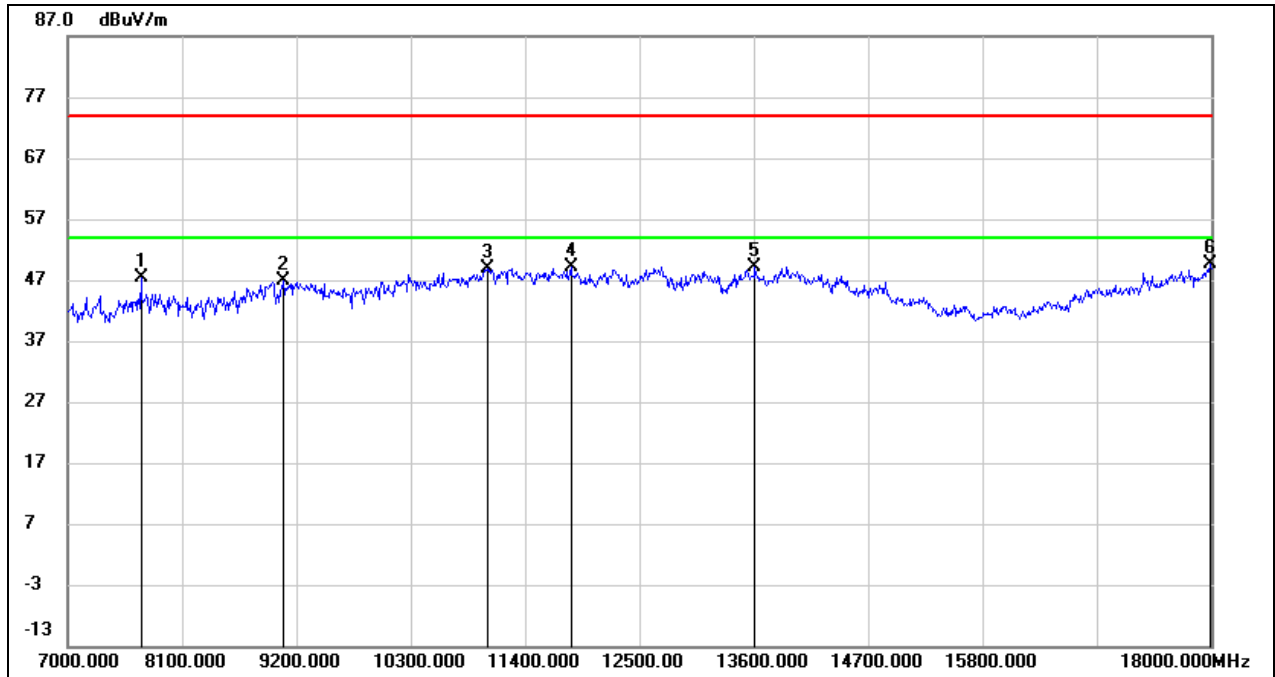

No.	Frequency (MHz)	Reading (dBuV)	Correct (dB/m)	Result (dBuV/m)	Limit (dBuV/m)	Margin (dB)	Remark
1	7704.000	40.59	6.69	47.28	74.00	-26.72	peak
2	9079.000	36.59	10.39	46.98	74.00	-27.02	peak
3	11037.000	34.00	14.87	48.87	74.00	-25.13	peak
4	11840.000	31.63	17.40	49.03	74.00	-24.97	peak
5	13611.000	28.21	20.92	49.13	74.00	-24.87	peak
6	17989.000	23.50	26.04	49.54	74.00	-24.46	peak

Test Mode:	802.11n HT20	Channel:	5825 MHz
Polarity:	Horizontal	Test Voltage:	DC 3.8 V

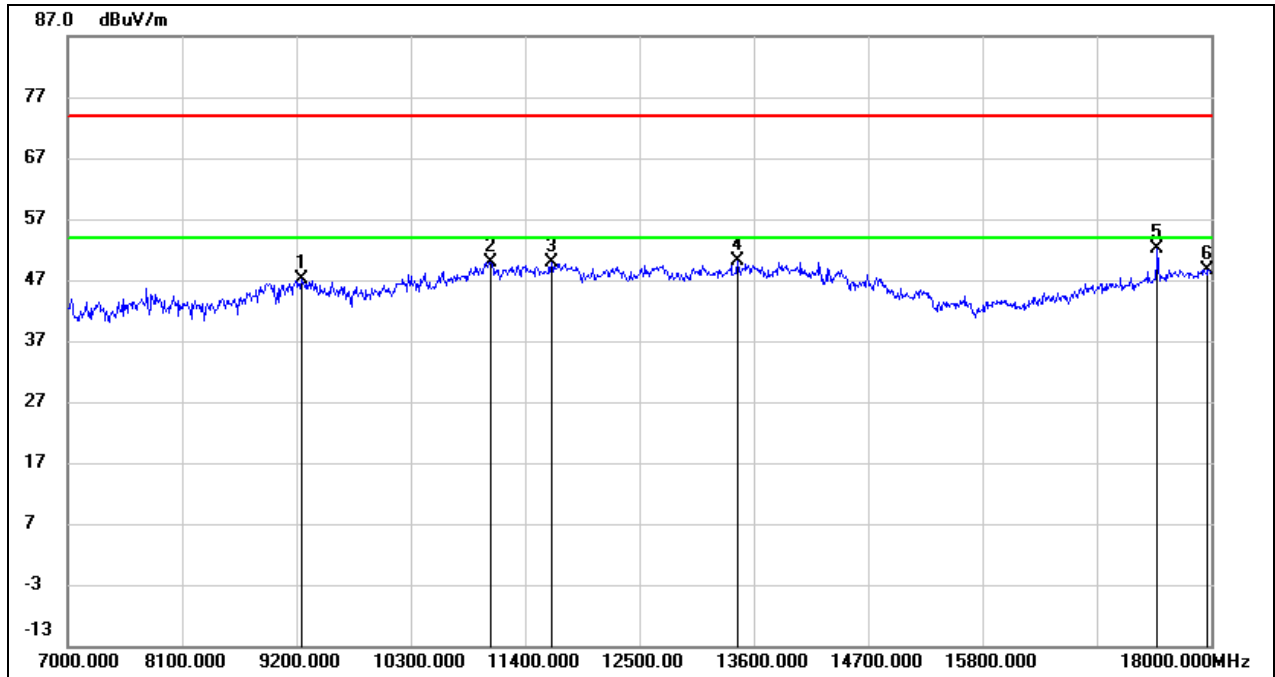

No.	Frequency (MHz)	Reading (dBuV)	Correct (dB/m)	Result (dBuV/m)	Limit (dBuV/m)	Margin (dB)	Remark
1	9255.000	36.51	10.51	47.02	74.00	-26.98	peak
2	11070.000	34.97	15.01	49.98	74.00	-24.02	peak
3	11653.000	32.71	17.05	49.76	74.00	-24.24	peak
4	13446.000	29.72	20.41	50.13	74.00	-23.87	peak
5	17483.000	29.57	22.62	52.19	74.00	-21.81	peak
6	17967.000	22.79	25.89	48.68	74.00	-25.32	peak

Test Mode:	802.11n HT20	Channel:	5825 MHz
Polarity:	Vertical	Test Voltage:	DC 3.8 V

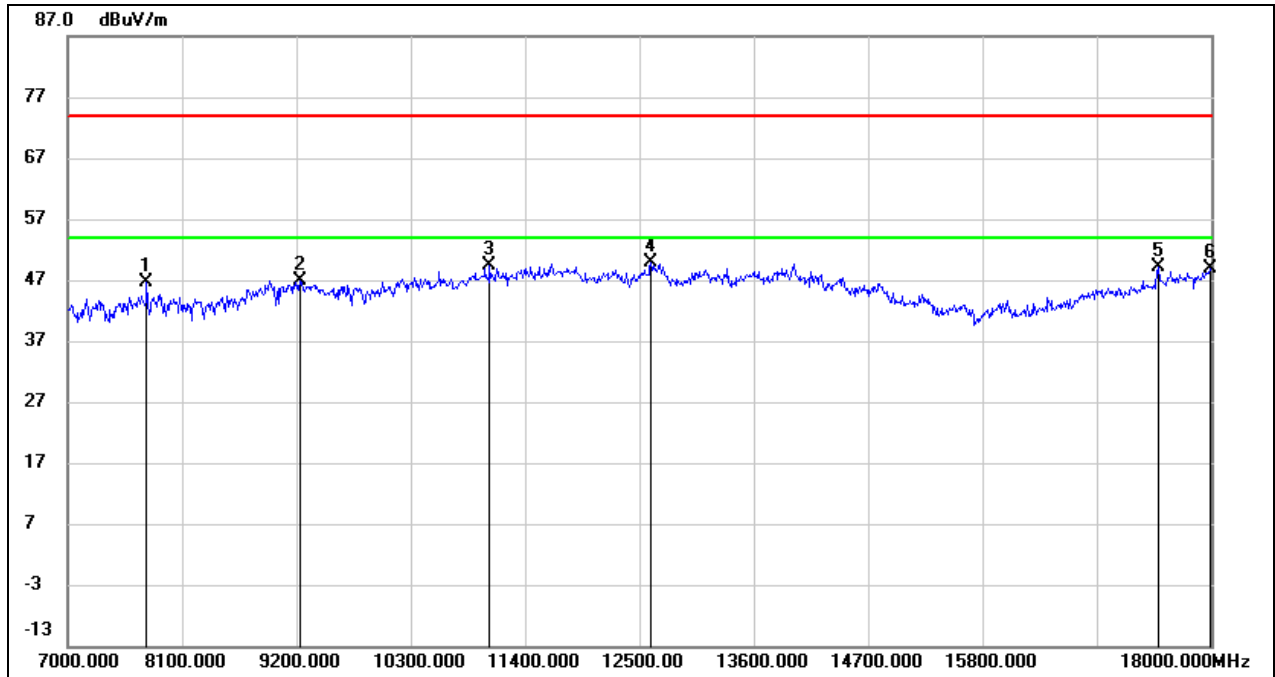

No.	Frequency (MHz)	Reading (dBuV)	Correct (dB/m)	Result (dBuV/m)	Limit (dBuV/m)	Margin (dB)	Remark
1	7759.000	39.88	6.64	46.52	74.00	-27.48	peak
2	9233.000	36.37	10.48	46.85	74.00	-27.15	peak
3	11059.000	34.52	14.96	49.48	74.00	-24.52	peak
4	12610.000	31.81	17.97	49.78	74.00	-24.22	peak
5	17494.000	26.43	22.67	49.10	74.00	-24.90	peak
6	17989.000	22.73	26.04	48.77	74.00	-25.23	peak

8.4. SPURIOUS EMISSIONS (18 GHZ ~ 26 GHZ)

Test Mode:	802.11a 20	Channel:	5785 MHz
Polarity:	Horizontal	Test Voltage:	DC 3.8 V

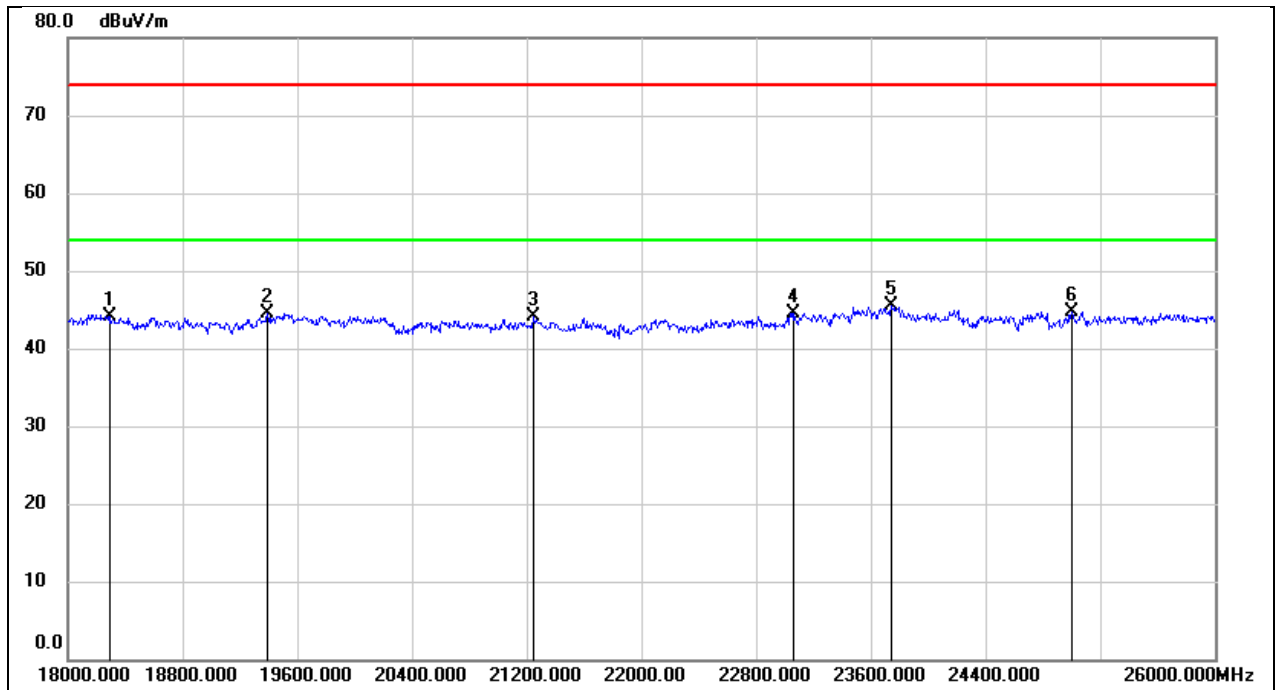

No.	Frequency (MHz)	Reading (dBuV)	Correct (dB/m)	Result (dBuV/m)	Limit (dBuV/m)	Margin (dB)	Remark
1	18296.000	49.63	-5.50	44.13	74.00	-29.87	peak
2	19392.000	50.12	-5.57	44.55	74.00	-29.45	peak
3	21248.000	48.79	-4.77	44.02	74.00	-29.98	peak
4	23064.000	47.99	-3.42	44.57	74.00	-29.43	peak
5	23744.000	48.65	-3.20	45.45	74.00	-28.55	peak
6	25000.000	46.86	-2.10	44.76	74.00	-29.24	peak

Test Mode:	802.11a 20	Channel:	5785 MHz
Polarity:	Vertical	Test Voltage:	DC 3.8 V

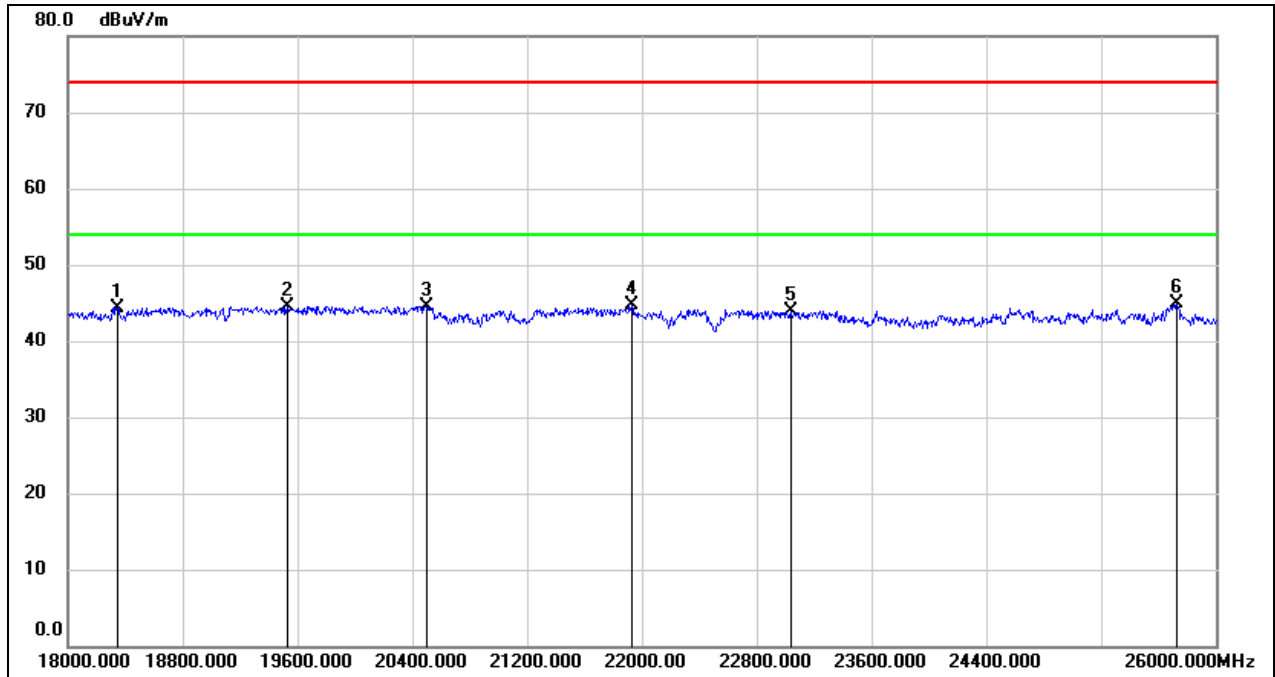

No.	Frequency (MHz)	Reading (dBuV)	Correct (dB/m)	Result (dBuV/m)	Limit (dBuV/m)	Margin (dB)	Remark
1	18344.000	49.84	-5.44	44.40	74.00	-29.60	peak
2	19528.000	50.00	-5.52	44.48	74.00	-29.52	peak
3	20496.000	49.91	-5.35	44.56	74.00	-29.44	peak
4	21928.000	49.05	-4.43	44.62	74.00	-29.38	peak
5	23040.000	47.33	-3.43	43.90	74.00	-30.10	peak
6	25728.000	45.61	-0.72	44.89	74.00	-29.11	peak

8.5. SPURIOUS EMISSIONS (9 KHZ ~ 30 MHZ)

Test Mode:	802.11a 20	Channel:	5785 MHz
Polarity:	Loop Antenna Face On To The EUT	Test Voltage	DC 12 V

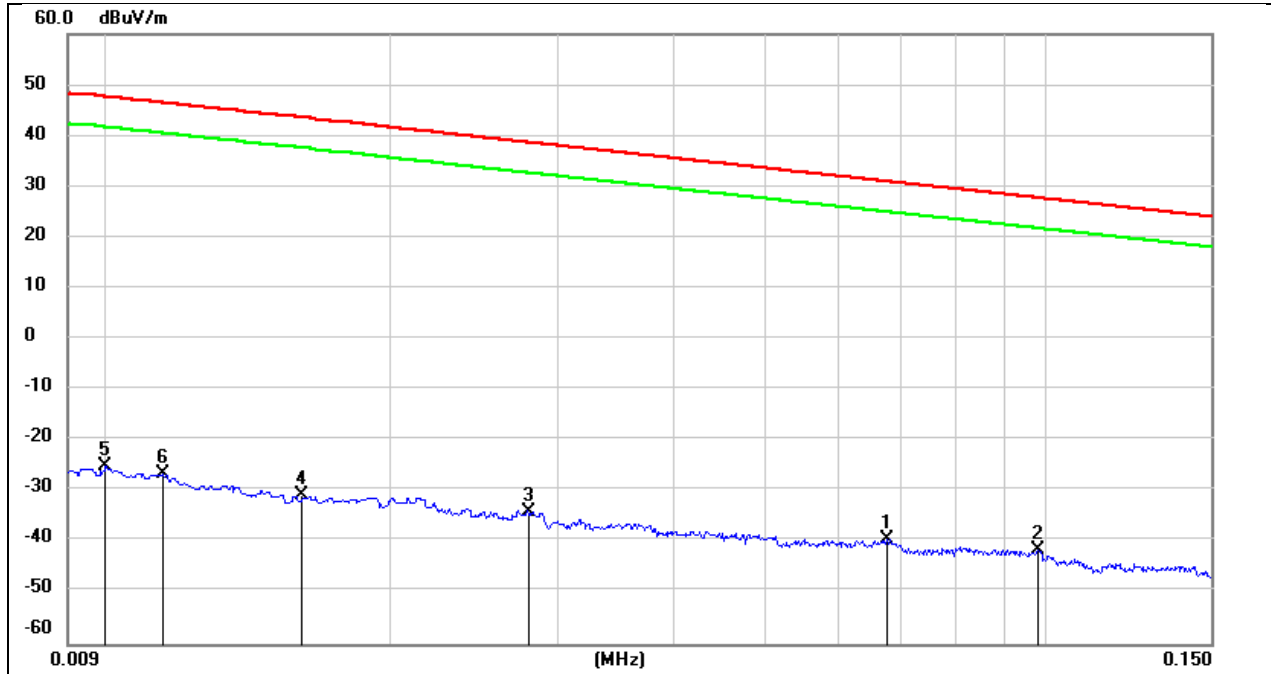

No.	Frequency (MHz)	Reading (dBuV)	Correct (dB/m)	Result (dBuV/m)	Result (dBuA/m)	Limit (dBuV/m)	Limit (dBuA/m)	Margin (dB)	Remark
1	0.0675	62.14	-101.56	-39.42	-90.92	31.02	-20.48	-70.44	peak
2	0.0981	60.27	-101.78	-41.51	-93.01	27.77	-23.73	-69.28	peak
3	0.028	67.29	-101.38	-34.09	-85.59	38.66	-12.84	-72.75	peak
4	0.016	70.47	-101.37	-30.9	-82.40	43.52	-7.98	-74.42	peak
5	0.01	76.22	-101.4	-25.18	-76.68	47.6	-3.9	-72.78	peak
6	0.0114	74.88	-101.4	-26.52	-78.02	46.46	-5.04	-72.98	peak

Test Mode:	802.11a 20	Channel:	5785 MHz
Polarity:	Loop Antenna Face On To The EUT	Test Voltage	DC 12 V

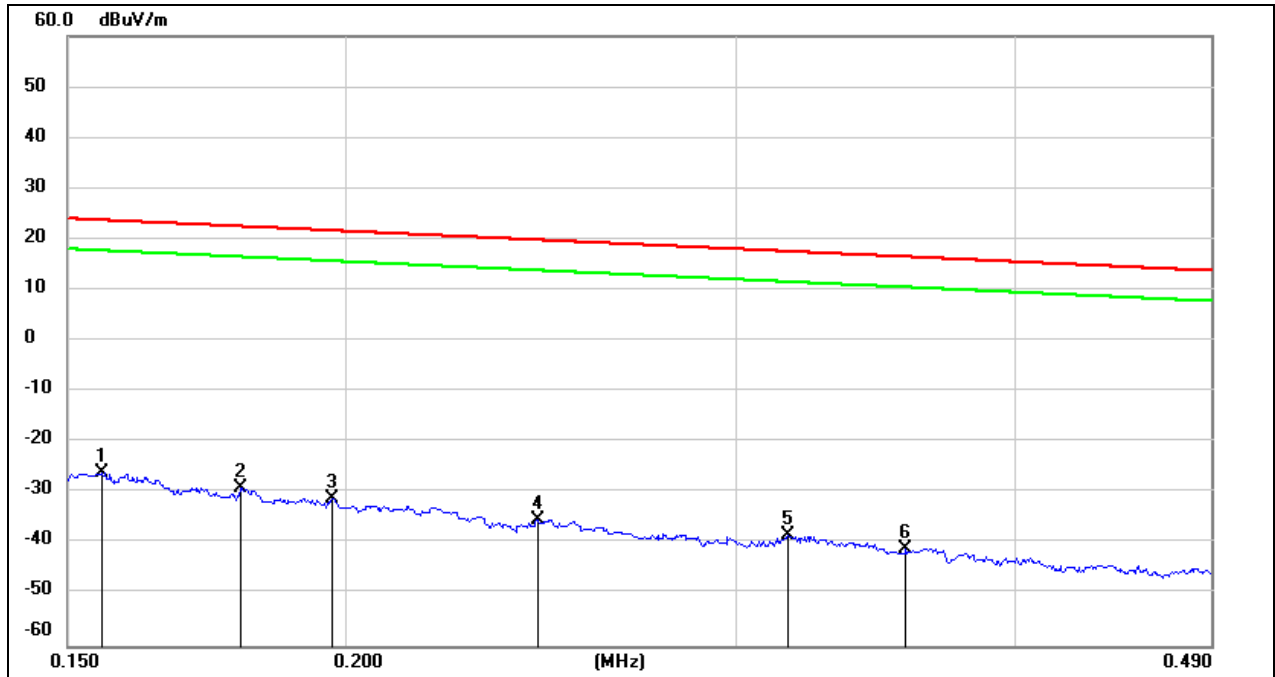

No.	Frequency (MHz)	Reading (dBuV)	Correct (dB/m)	Result (dBuV/m)	Result (dBuA/m)	Limit (dBuV/m)	Limit (dBuA/m)	Margin (dB)	Remark
1	0.1554	75.77	-101.65	-25.88	-77.38	23.77	-27.73	-49.65	peak
2	0.1794	72.77	-101.68	-28.91	-80.41	22.53	-28.97	-51.44	peak
3	0.1973	70.64	-101.71	-31.07	-82.57	21.7	-29.8	-52.77	peak
4	0.2442	66.53	-101.79	-35.26	-86.76	19.85	-31.65	-55.11	peak
5	0.3163	63.7	-101.87	-38.17	-89.67	17.6	-33.9	-55.77	peak
6	0.3573	61.08	-101.91	-40.83	-92.33	16.54	-34.96	-57.37	peak

Test Mode:	802.11a 20	Channel:	5785 MHz
Polarity:	Loop Antenna Face On To The EUT	Test Voltage	DC 12 V

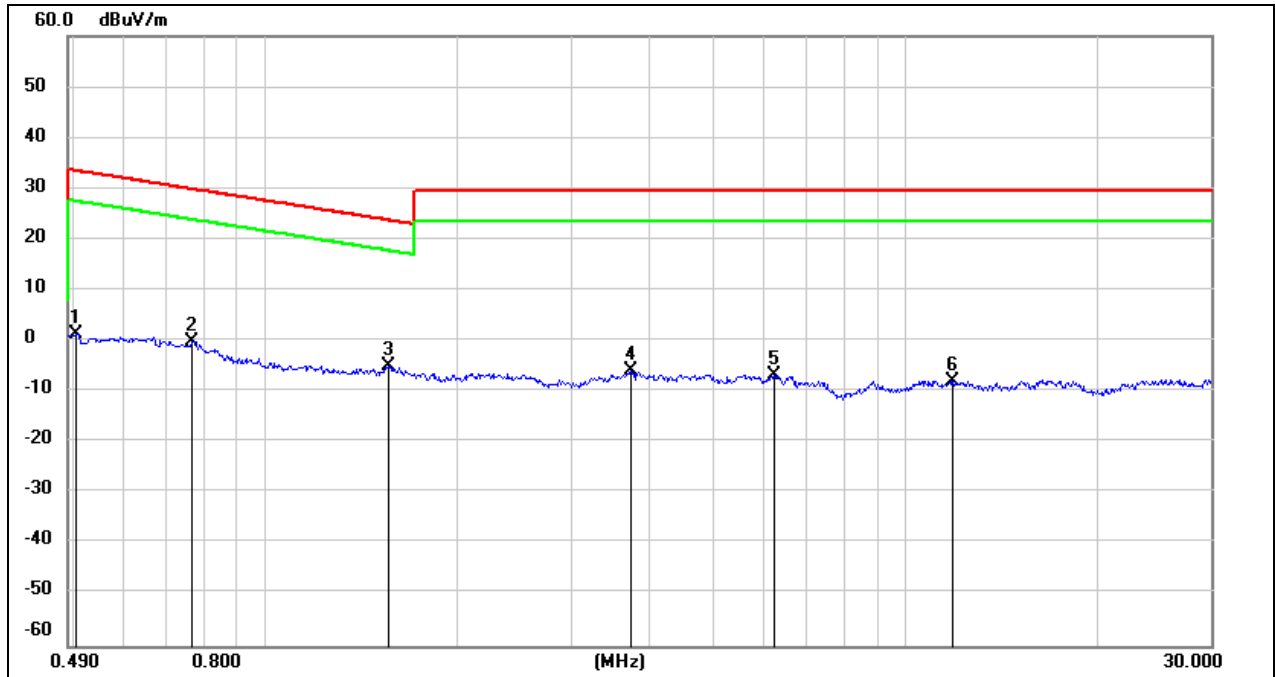

No.	Frequency (MHz)	Reading (dBuV)	Correct (dB/m)	Result (dBuV/m)	Result (dBuA/m)	Limit (dBuV/m)	Limit (dBuA/m)	Margin (dB)	Remark
1	0.5039	63.43	-62.07	1.36	-50.14	33.56	-17.94	-32.20	peak
2	0.7641	61.92	-62.12	-0.2	-51.70	29.94	-21.56	-30.14	peak
3	1.5564	57.18	-62.02	-4.84	-56.34	23.76	-27.74	-28.60	peak
4	3.71	55.7	-61.41	-5.71	-57.21	29.54	-21.96	-35.25	peak
5	6.2445	54.63	-61.32	-6.69	-58.19	29.54	-21.96	-36.23	peak
6	11.8513	53.06	-60.88	-7.82	-59.32	29.54	-21.96	-37.36	peak

8.6. SPURIOUS EMISSIONS (26 GHZ ~ 40 GHZ)

Test Mode:	802.11a 20	Channel:	5785 MHz
Polarity:	Horizontal	Test Voltage:	DC 3.8 V

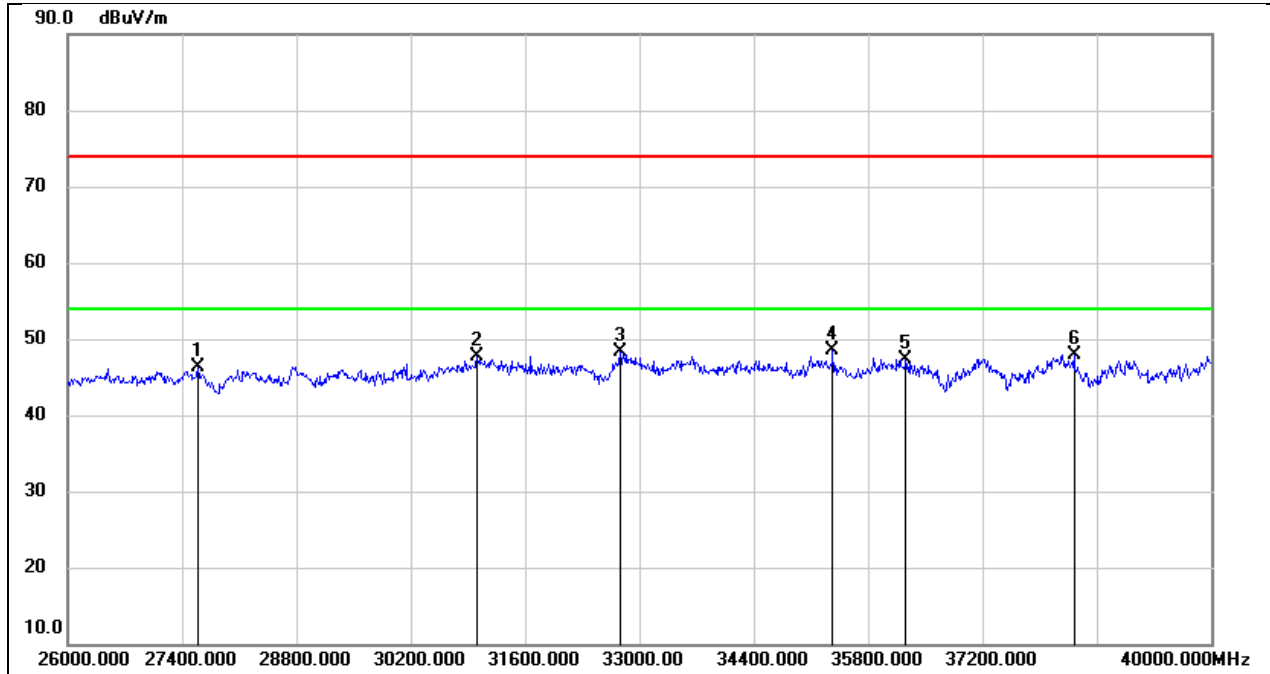

No.	Frequency (MHz)	Reading (dBuV)	Correct (dB/m)	Result (dBuV/m)	Limit (dBuV/m)	Margin (dB)	Remark
1	27596.000	49.71	-3.46	46.25	74.00	-27.75	peak
2	31012.000	48.33	-0.71	47.62	74.00	-26.38	peak
3	32762.000	49.45	-1.21	48.24	74.00	-25.76	peak
4	35366.000	45.90	2.59	48.49	74.00	-25.51	peak
5	36262.000	44.10	3.28	47.38	74.00	-26.62	peak
6	38320.000	44.06	3.77	47.83	74.00	-26.17	peak

Test Mode:	802.11a 20	Channel:	5785 MHz
Polarity:	Vertical	Test Voltage:	DC 3.8 V

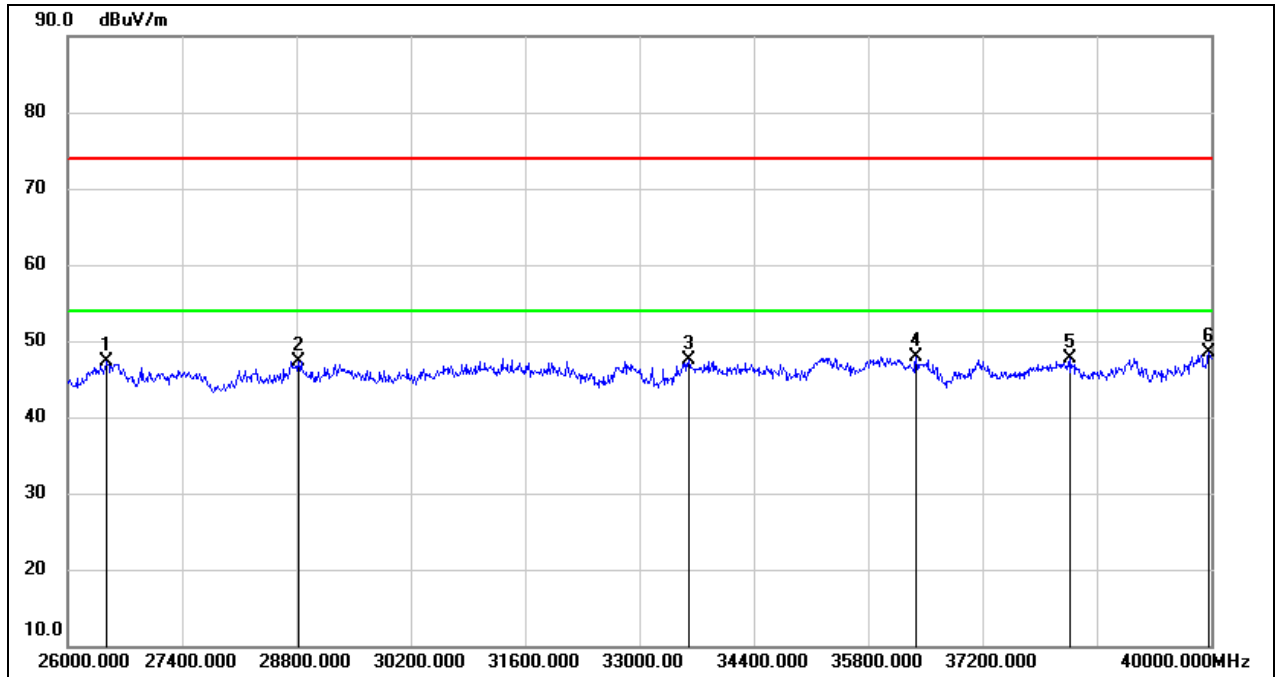

No.	Frequency (MHz)	Reading (dBuV)	Correct (dB/m)	Result (dBuV/m)	Limit (dBuV/m)	Margin (dB)	Remark
1	26476.000	52.03	-4.78	47.25	74.00	-26.75	peak
2	28828.000	48.13	-0.79	47.34	74.00	-26.66	peak
3	33602.000	47.01	0.46	47.47	74.00	-26.53	peak
4	36388.000	44.32	3.52	47.84	74.00	-26.16	peak
5	38278.000	43.82	3.82	47.64	74.00	-26.36	peak
6	39972.000	43.45	5.13	48.58	74.00	-25.42	peak

8.7. SPURIOUS EMISSIONS (30 MHz ~ 1 GHz)

Test Mode:	802.11a 20	Channel:	5785 MHz
Polarity:	Horizontal	Test Voltage:	DC 3.8 V

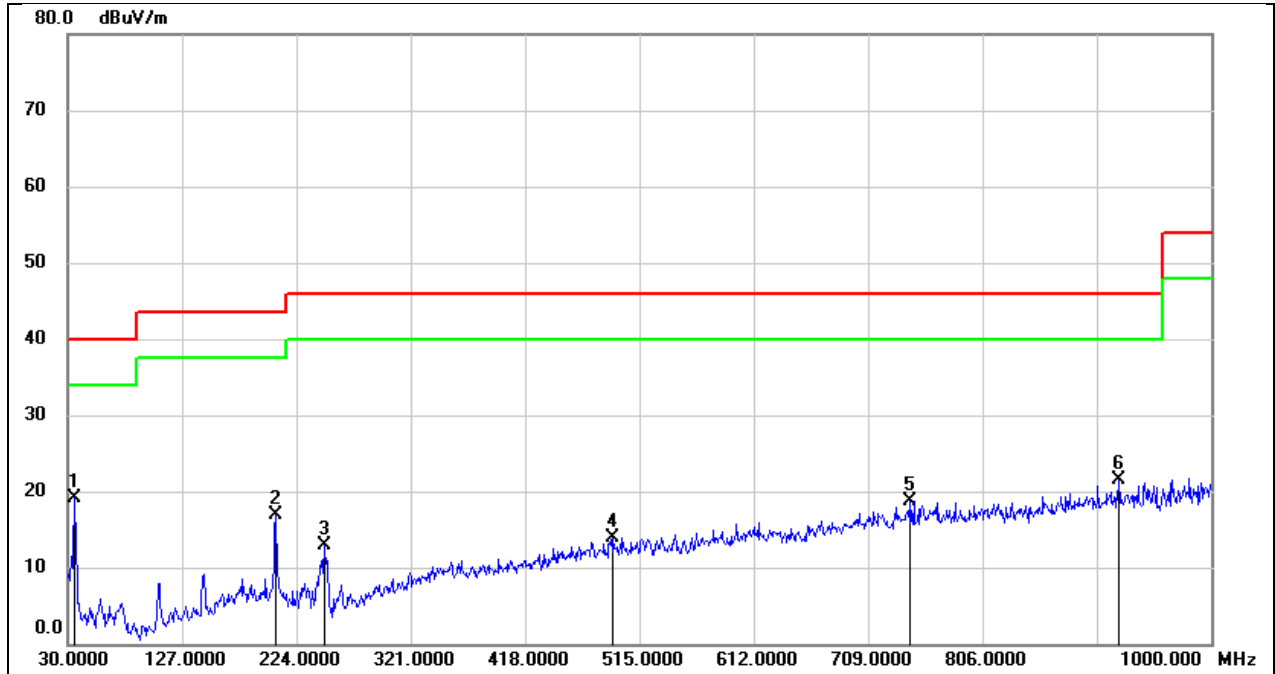

No.	Frequency (MHz)	Reading (dBuV)	Correct (dB/m)	Result (dBuV/m)	Limit (dBuV/m)	Margin (dB)	Remark
1	35.8200	38.31	-19.15	19.16	40.00	-20.84	QP
2	206.5399	33.83	-16.89	16.94	43.50	-26.56	QP
3	247.2800	31.68	-18.82	12.86	46.00	-33.14	QP
4	492.6900	24.70	-10.86	13.84	46.00	-32.16	QP
5	744.8900	25.77	-7.16	18.61	46.00	-27.39	QP
6	921.4300	26.05	-4.64	21.41	46.00	-24.59	QP

Test Mode:	802.11a 20	Channel:	5785 MHz
Polarity:	Vertical	Test Voltage:	DC 3.8 V

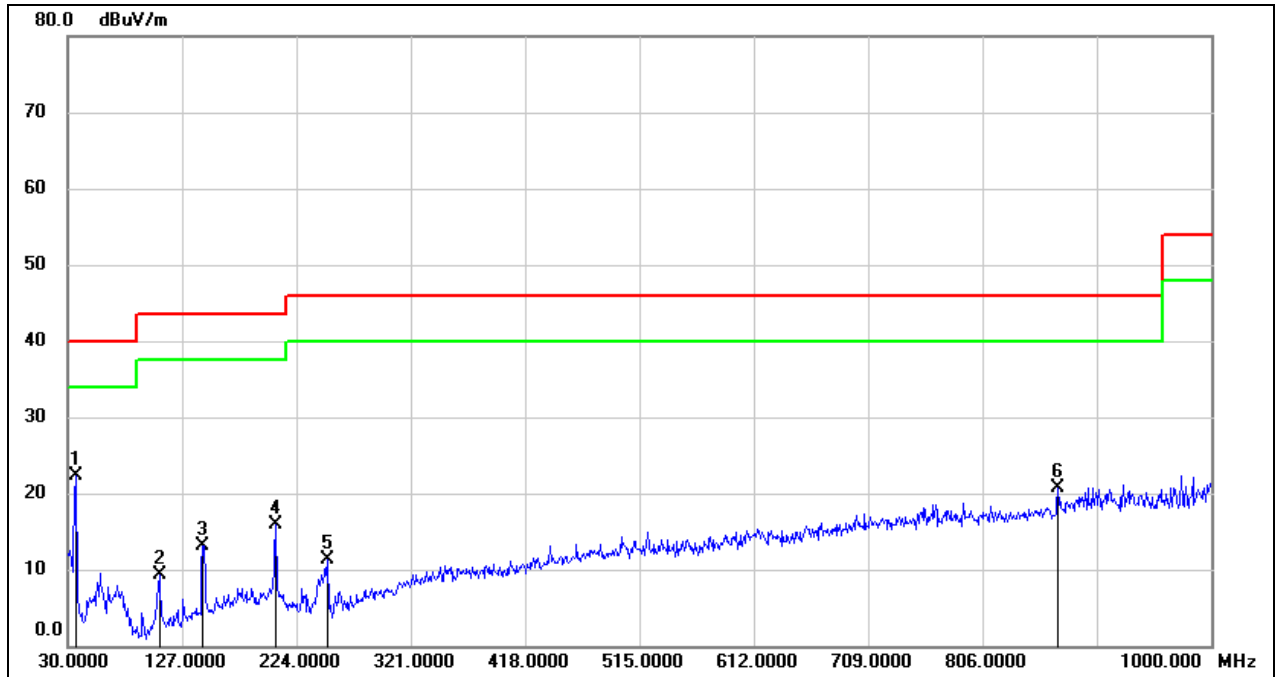

No.	Frequency (MHz)	Reading (dBuV)	Correct (dB/m)	Result (dBuV/m)	Limit (dBuV/m)	Margin (dB)	Remark
1	36.7900	41.59	-19.30	22.29	40.00	-17.71	QP
2	107.6000	29.91	-20.52	9.39	43.50	-34.11	QP
3	144.4600	31.71	-18.64	13.07	43.50	-30.43	QP
4	206.5399	32.87	-16.89	15.98	43.50	-27.52	QP
5	250.1900	30.16	-18.95	11.21	46.00	-34.79	QP
6	870.0200	26.27	-5.59	20.68	46.00	-25.32	QP

8.8. SPURIOUS EMISSIONS FOR SIMULTANEOUS TRANSMISSION

SPURIOUS EMISSIONS (2.4G MID CHANNEL, UNII-3 BAND MID CHANNEL, WORST-CASE CONFIGURATION, HORIZONTAL)

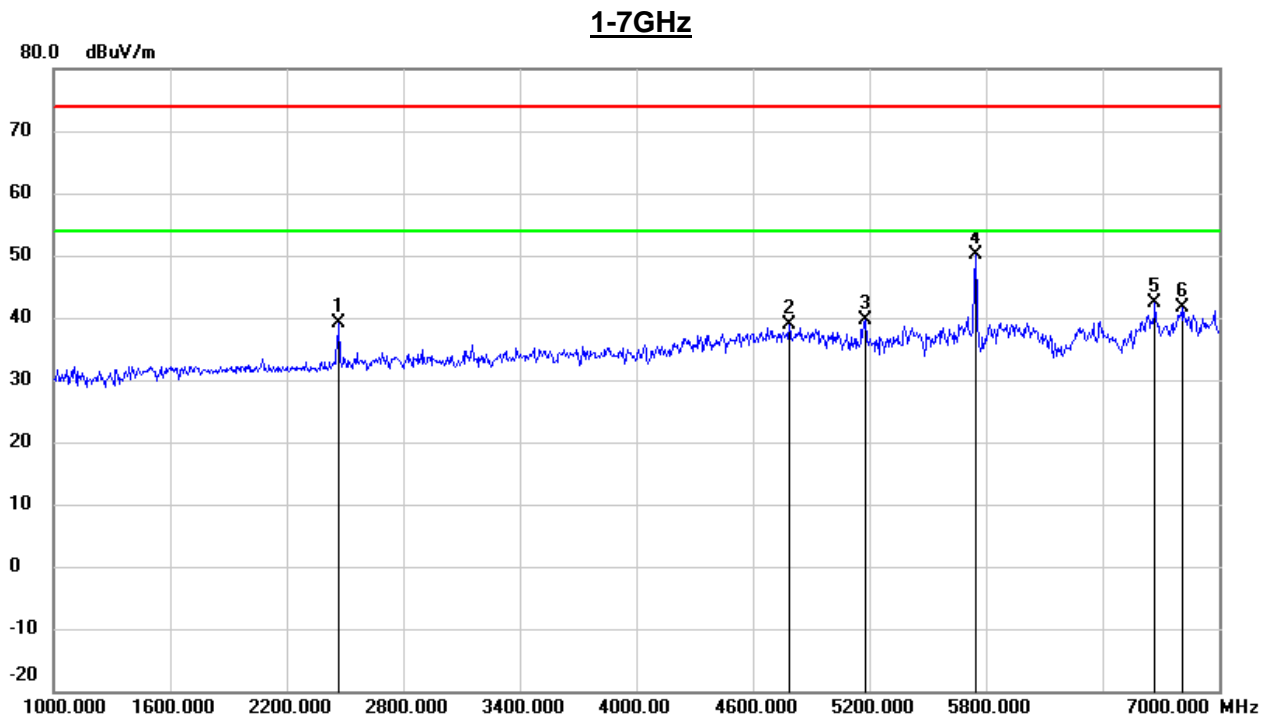

No.	Frequency (MHz)	Reading (dBuV)	Correct (dB/m)	Result (dBuV/m)	Limit (dBuV/m)	Margin (dB)	Remark
1	2466.000	47.82	-8.66	39.16	74.00	-34.84	peak
2	4786.000	39.83	-1.00	38.83	74.00	-35.17	peak
3	5182.000	39.62	0.06	39.68	74.00	-34.32	peak
4	5746.000	48.92	1.12	50.04	74.00	-23.96	peak
5	6670.000	37.79	4.57	42.36	74.00	-31.64	peak
6	6814.000	36.37	5.28	41.65	74.00	-32.35	peak

Note: 1. Measurement = Reading Level + Correct Factor.

2. If Peak Result complies with AV limit, AV Result is deemed to comply with AV limit.

3. Peak: Peak detector.

4. Filter losses were only considered in the spurious frequency bands and the authorized band was not corrected for Band reject filter losses.

5. Proper operation of the transmitter prior to adding the filter to the measurement chain.

6. Owing to the highest peak level of unwanted emission out of the restricted bands complies with the lowest limit(54dBuV/m), so all the test point was deemed to comply with the limits list in the standard.

7-18GHz

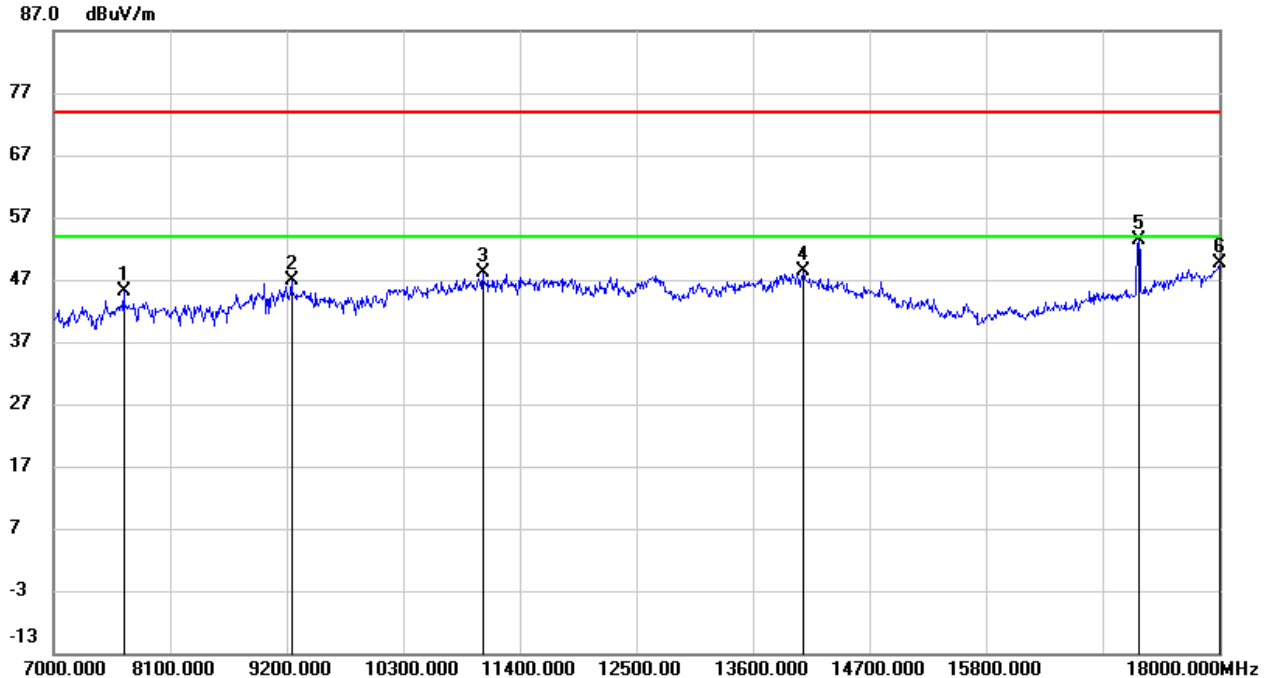

No.	Frequency (MHz)	Reading (dBuV)	Correct (dB/m)	Result (dBuV/m)	Limit (dBuV/m)	Margin (dB)	Remark
1	7660.000	38.31	6.73	45.04	74.00	-28.96	peak
2	9244.000	36.28	10.49	46.77	74.00	-27.23	peak
3	11048.000	33.10	14.91	48.01	74.00	-25.99	peak
4	14073.000	26.80	21.57	48.37	74.00	-25.63	peak
5	17241.000	31.72	21.62	53.34	74.00	-20.66	peak
6	18000.000	23.44	26.12	49.56	74.00	-24.44	peak

Note: 1. Measurement = Reading Level + Correct Factor.

2. If Peak Result complies with AV limit, AV Result is deemed to comply with AV limit.

3. Peak: Peak detector.

4. Filter losses were only considered in the spurious frequency bands and the authorized band was not corrected for High Pass Filter losses.

5. Proper operation of the transmitter prior to adding the filter to the measurement chain.

6. Owing to the highest peak level of unwanted emission out of the restricted bands complies with the lowest limit(54dBuV/m), so all the test point was deemed to comply with the limits list in the standard.

SPURIOUS EMISSIONS (2.4G MID CHANNEL, UNII-3 BAND MID CHANNEL, WORST-CASE CONFIGURATION, VERTICAL)

1-7GHz

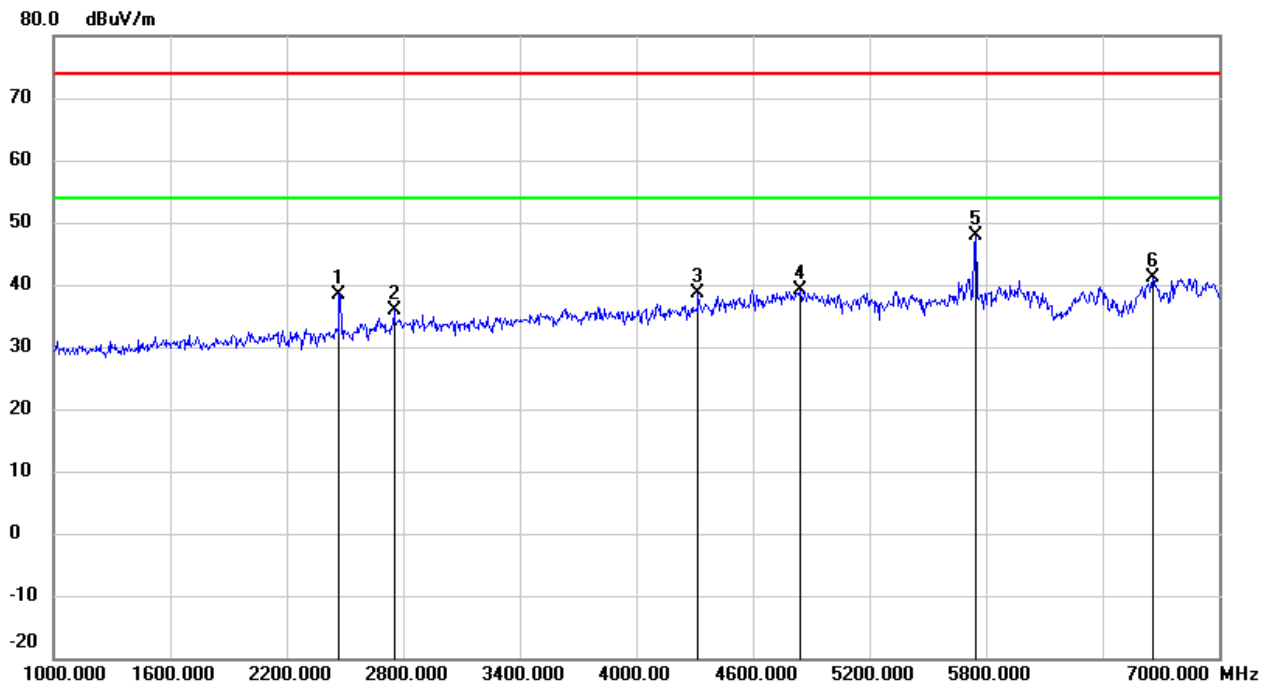

No.	Frequency (MHz)	Reading (dBuV)	Correct (dB/m)	Result (dBuV/m)	Limit (dBuV/m)	Margin (dB)	Remark
1	2466.000	47.07	-8.66	38.41	74.00	-35.59	peak
2	2752.000	43.54	-7.73	35.81	74.00	-38.19	peak
3	4318.000	41.55	-2.99	38.56	74.00	-35.44	peak
4	4840.000	40.03	-0.78	39.25	74.00	-34.75	peak
5	5746.000	46.66	1.12	47.78	74.00	-26.22	peak
6	6658.000	36.58	4.49	41.07	74.00	-32.93	peak

- Note: 1. Measurement = Reading Level + Correct Factor.
 2. If Peak Result complies with AV limit, AV Result is deemed to comply with AV limit.
 3. Peak: Peak detector.
 4. Filter losses were only considered in the spurious frequency bands and the authorized band was not corrected for Band reject filter losses.
 5. Proper operation of the transmitter prior to adding the filter to the measurement chain.
 6. Owing to the highest peak level of unwanted emission out of the restricted bands complies with the lowest limit(54dBuV/m), so all the test point was deemed to comply with the limits list in the standard.

7-18GHz

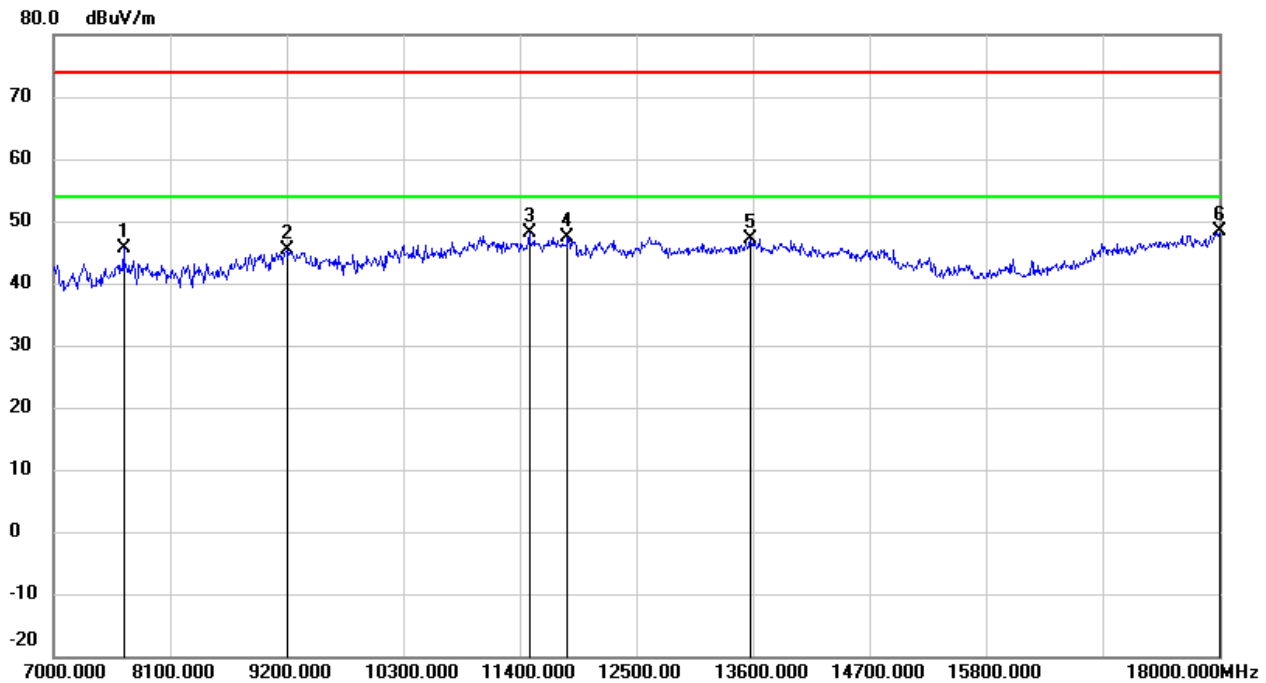

No.	Frequency (MHz)	Reading (dBuV)	Correct (dB/m)	Result (dBuV/m)	Limit (dBuV/m)	Margin (dB)	Remark
1	7660.000	38.80	6.73	45.53	74.00	-28.47	peak
2	9200.000	34.81	10.46	45.27	74.00	-28.73	peak
3	11488.000	31.42	16.72	48.14	74.00	-25.86	peak
4	11851.000	29.90	17.43	47.33	74.00	-26.67	peak
5	13578.000	26.30	20.83	47.13	74.00	-26.87	peak
6	18000.000	22.14	26.12	48.26	74.00	-25.74	peak

Note: 1. Measurement = Reading Level + Correct Factor.
 2. If Peak Result complies with AV limit, AV Result is deemed to comply with AV limit.
 3. Peak: Peak detector.
 4. Filter losses were only considered in the spurious frequency bands and the authorized band was not corrected for High Pass Filter losses.
 5. Proper operation of the transmitter prior to adding the filter to the measurement chain.
 6. Owing to the highest peak level of unwanted emission out of the restricted bands complies with the lowest limit(54dBuV/m), so all the test point was deemed to comply with the limits list in the standard.

9. ANTENNA REQUIREMENT

REQUIREMENT

Please refer to FCC part 15.203

An intentional radiator shall be designed to ensure that no antenna other than that furnished by the responsible party shall be used with the device. The use of a permanently attached antenna or of an antenna that uses a unique coupling to the intentional radiator shall be considered sufficient to comply with the provisions of this section. The manufacturer may design the unit so that a broken antenna can be replaced by the user, but the use of a standard antenna jack or electrical connector is prohibited.

Please refer to FCC §15.407(a)(1)(2)(3)

If transmitting antennas of directional gain greater than 6 dBi are used, both the maximum conducted output power and the maximum power spectral density shall be reduced by the amount in dB that the directional gain of the antenna exceeds 6 dBi.

DESCRIPTION

Pass

10. TEST DATA

10.1. APPENDIX A1: EMISSION BANDWIDTH

10.1.1. Test Result

Test Mode	Antenna	Channel	26db EBW [MHz]	FL[MHz]	FH[MHz]	Verdict
11A	Ant1	5745	18.88	5735.68	5754.56	PASS
		5785	18.92	5775.80	5794.72	PASS
		5825	19.48	5815.28	5834.76	PASS
11N20SISO	Ant1	5745	20.16	5734.88	5755.04	PASS
		5785	19.92	5775.12	5795.04	PASS
		5825	19.84	5815.00	5834.84	PASS

10.1.2. Test Graphs

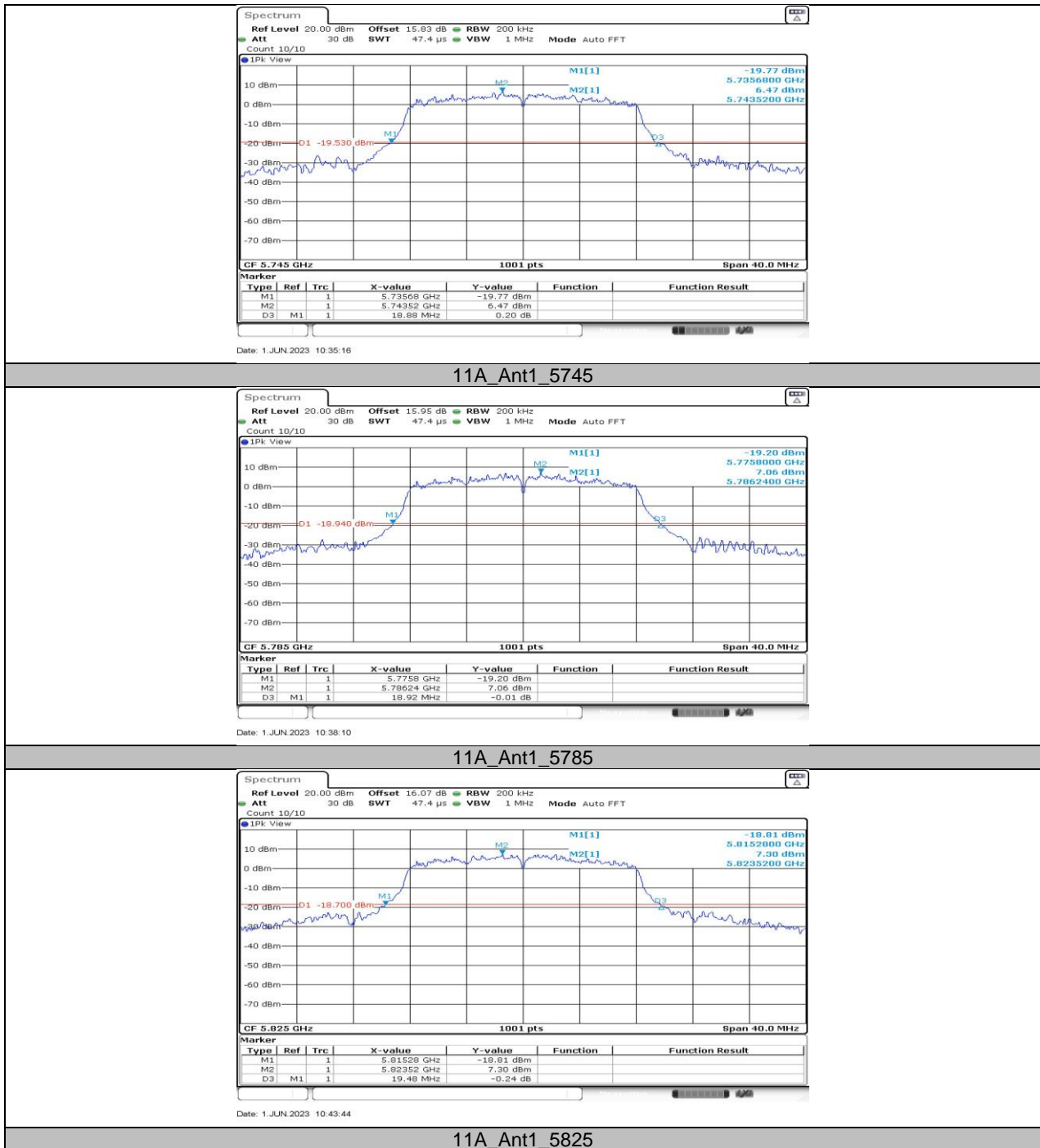

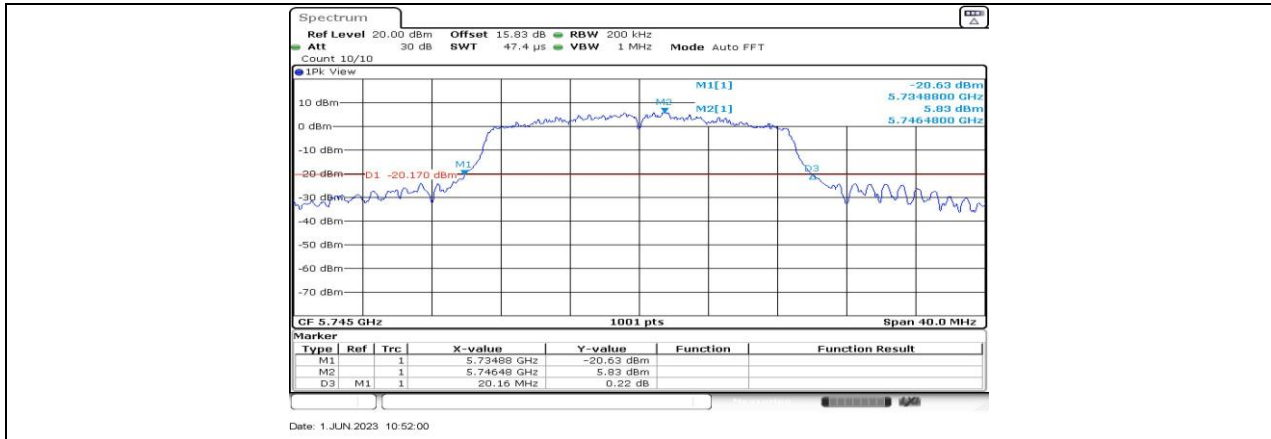

11N20SISO_Ant1_5745



11N20SISO_Ant1_5785

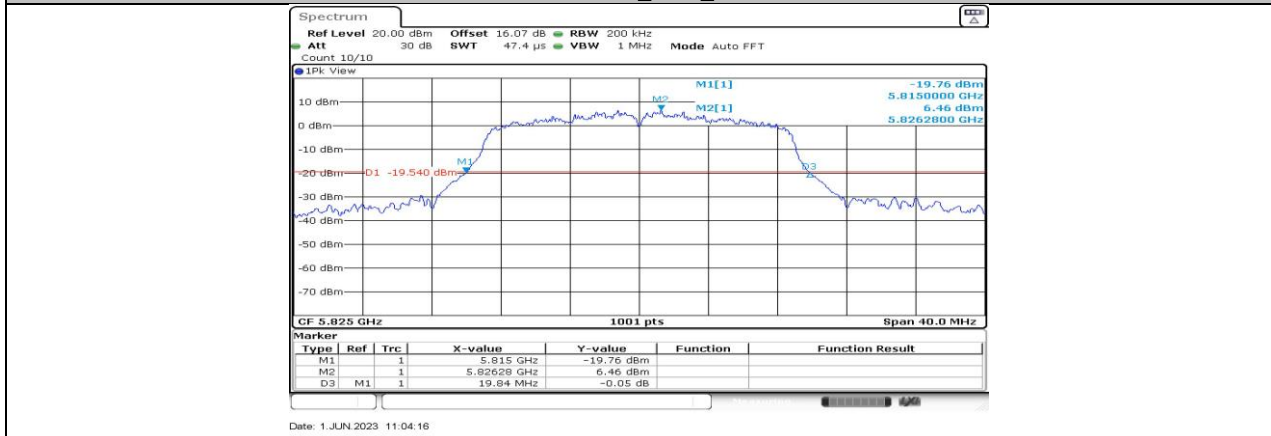

11N20SISO_Ant1_5825

10.2. APPENDIX A2: OCCUPIED CHANNEL BANDWIDTH

10.2.1. Test Result

Test Mode	Antenna	Channel	OCB [MHz]	FL[MHz]	FH[MHz]	Verdict
11A	Ant1	5745	16.703	5736.6484	5753.3516	PASS
		5785	16.703	5776.7283	5793.4316	PASS
		5825	16.903	5816.6484	5833.5514	PASS
11N20SISO	Ant1	5745	17.822	5736.0889	5753.9111	PASS
		5785	17.702	5776.1688	5793.8711	PASS
		5825	17.582	5816.2088	5833.7912	PASS

10.2.2. Test Graphs

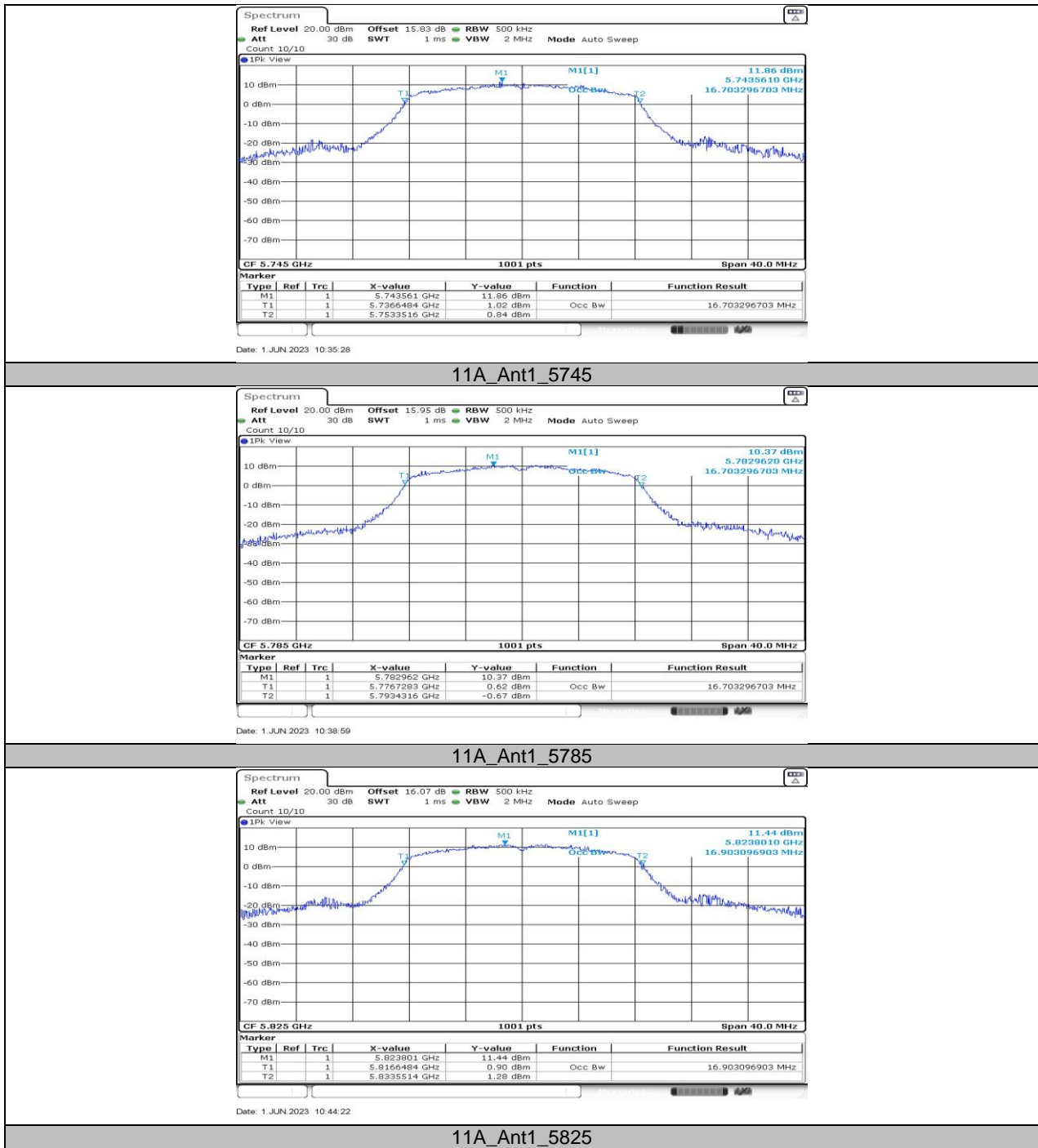

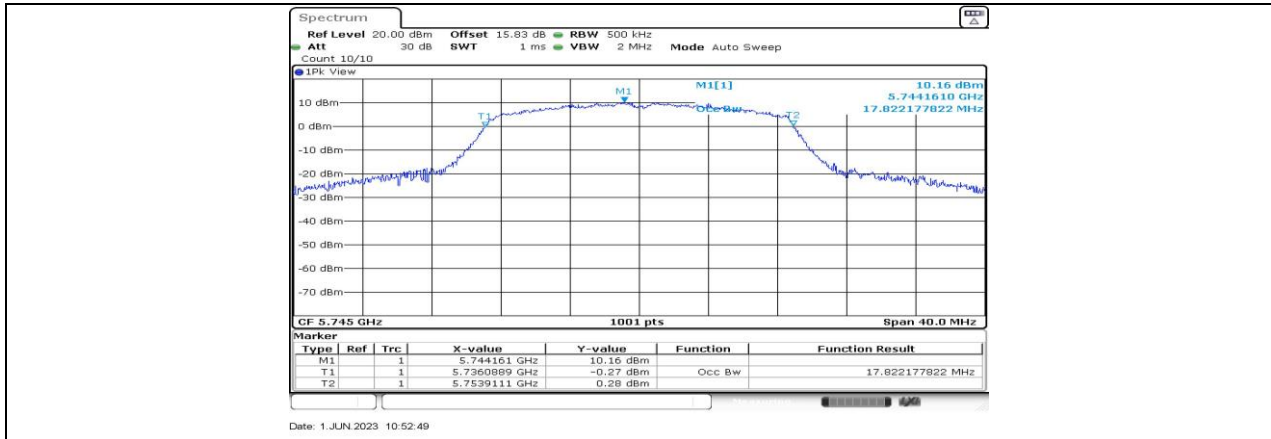

11N20SISO_Ant1_5745

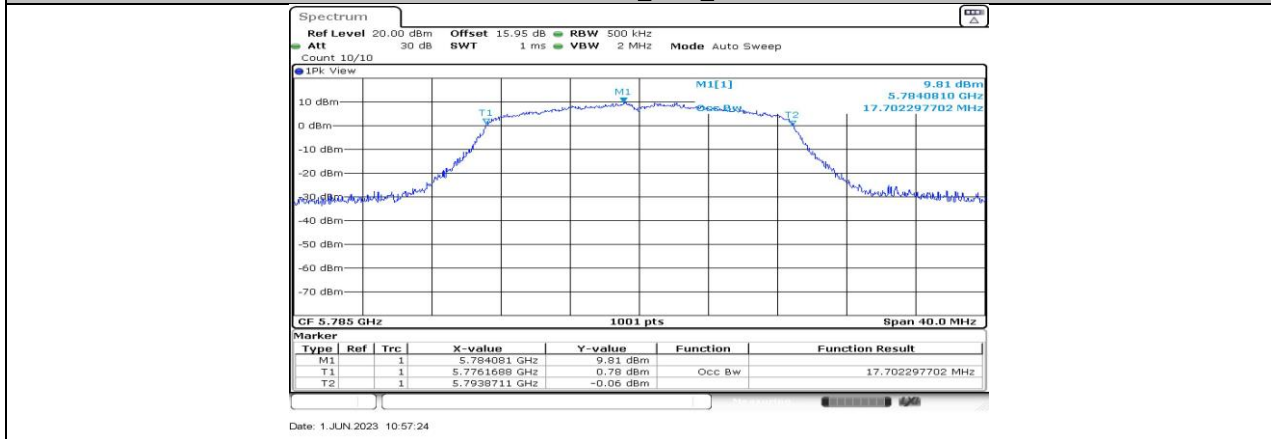

11N20SISO_Ant1_5785



11N20SISO_Ant1_5825

10.3. APPENDIX A3: MIN EMISSION BANDWIDTH

10.3.1. Test Result

Test Mode	Antenna	Channel	6db EBW [MHz]	FL[MHz]	FH[MHz]	Limit[MHz]	Verdict
11A	Ant1	5745	15.08	5737.48	5752.56	≥ 0.5	PASS
		5785	15.08	5777.48	5792.56	≥ 0.5	PASS
		5825	15.12	5817.44	5832.56	≥ 0.5	PASS
11N20SISO	Ant1	5745	15.08	5737.48	5752.56	≥ 0.5	PASS
		5785	15.12	5777.44	5792.56	≥ 0.5	PASS
		5825	15.08	5817.48	5832.56	≥ 0.5	PASS

10.3.2. Test Graphs

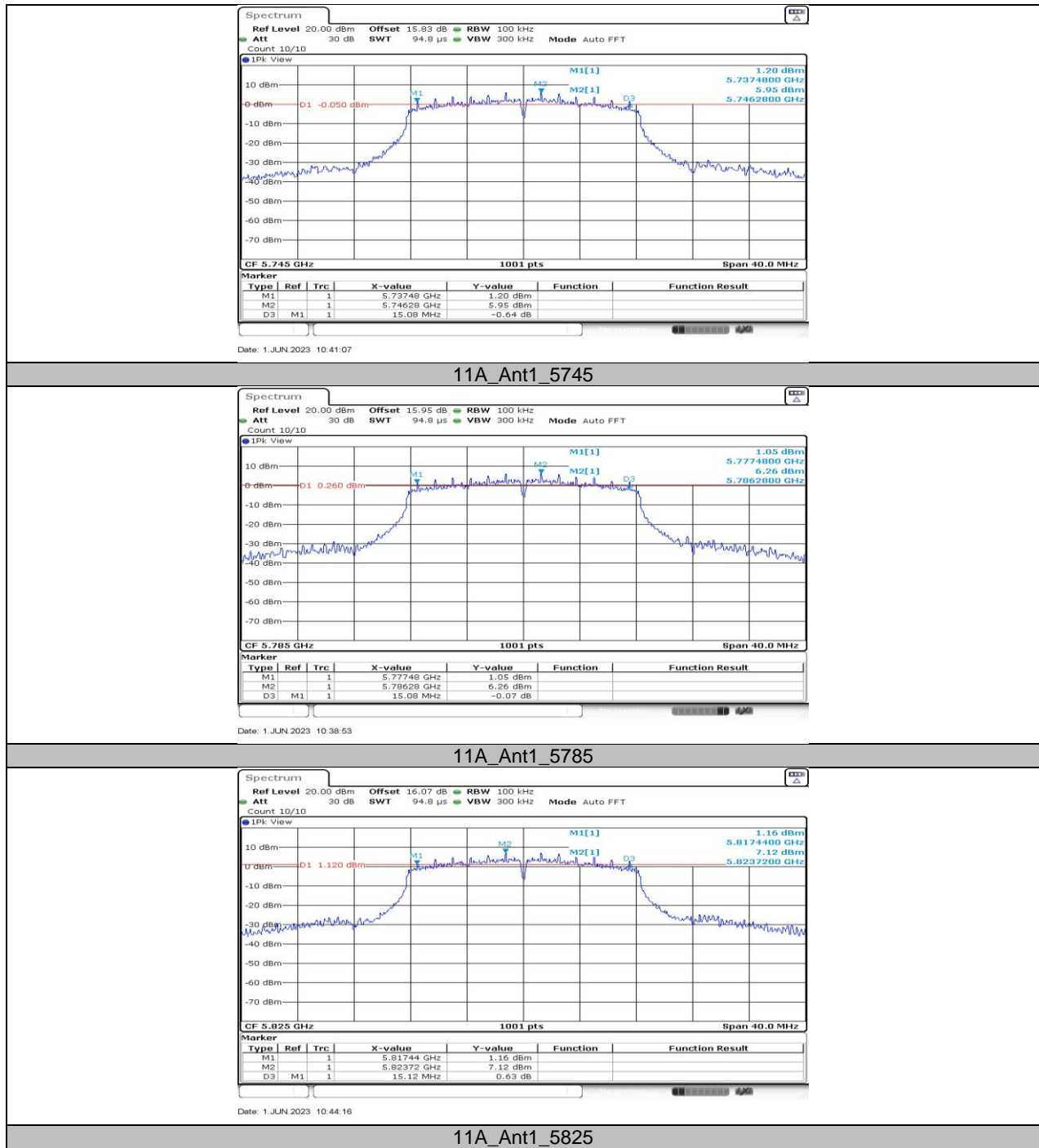

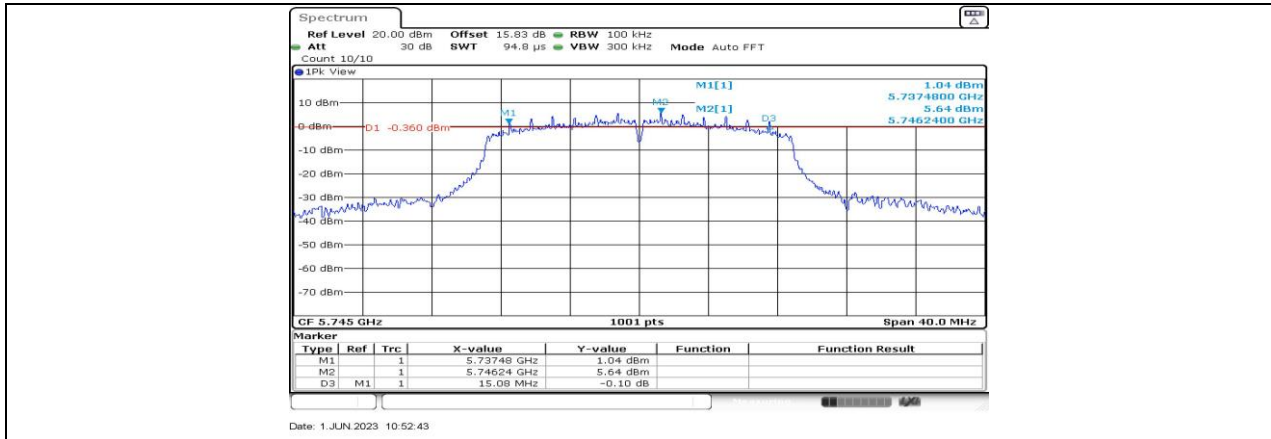

11N20SISO_Ant1_5745

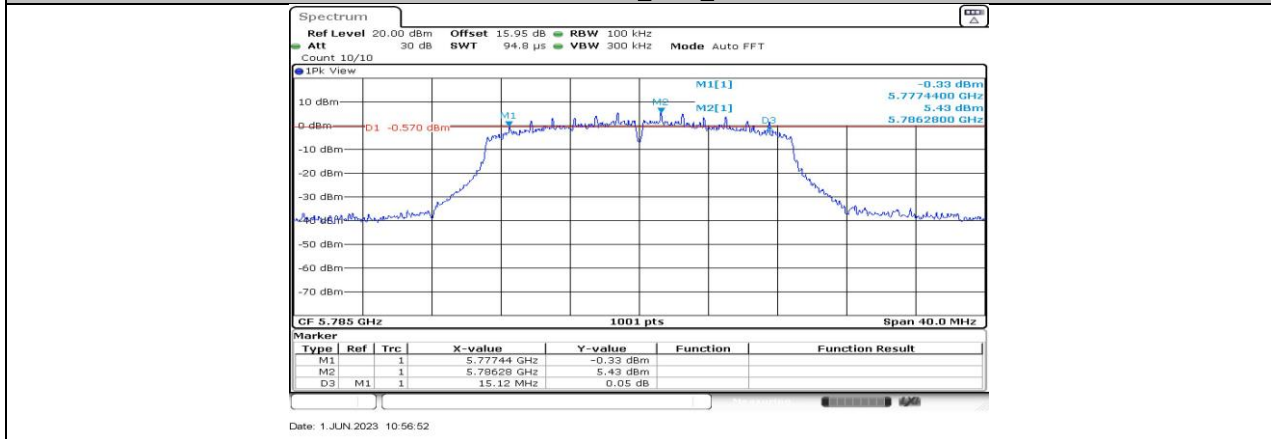

11N20SISO_Ant1_5785

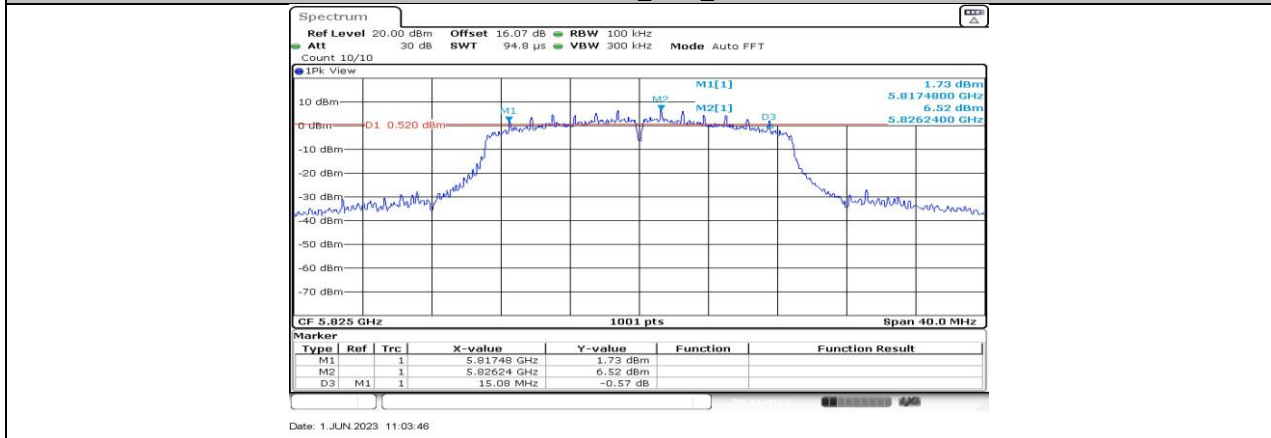

11N20SISO_Ant1_5825

10.4. APPENDIX B: MAXIMUM AVERAGE CONDUCTED OUTPUT POWER

10.4.1. Test Result

Test Mode	Antenna	Channel	Result[dBm]	Limit[dBm]	Verdict
11A	Ant1	5745	17.35	≤30.00	PASS
		5785	17.47	≤30.00	PASS
		5825	16.97	≤30.00	PASS
11N20SISO	Ant1	5745	16.95	≤30.00	PASS
		5785	17.22	≤30.00	PASS
		5825	17.05	≤30.00	PASS

Note: 1. Conducted Power=Meas. Level+ Correction Factor

2. The Duty Cycle Factor (refer to section 7.1) had already compensated to the test data.

10.5. APPENDIX C: MAXIMUM POWER SPECTRAL DENSITY

10.5.1. Test Result

Test Mode	Antenna	Channel	Result [dBm/MHz]	Limit[dBm/MHz]	Verdict
11A	Ant1	5745	3.14	≤30.00	PASS
		5785	3.12	≤30.00	PASS
		5825	2.95	≤30.00	PASS
11N20SISO	Ant1	5745	1.62	≤30.00	PASS
		5785	1.7	≤30.00	PASS
		5825	2.27	≤30.00	PASS

Note: 1.The Result and Limit Unit is dBm/500 kHz in the band 5.725–5.85 GHz.

2.The Duty Cycle Factor and RBW Factor is compensated in the graph.

10.5.2. Test Graphs

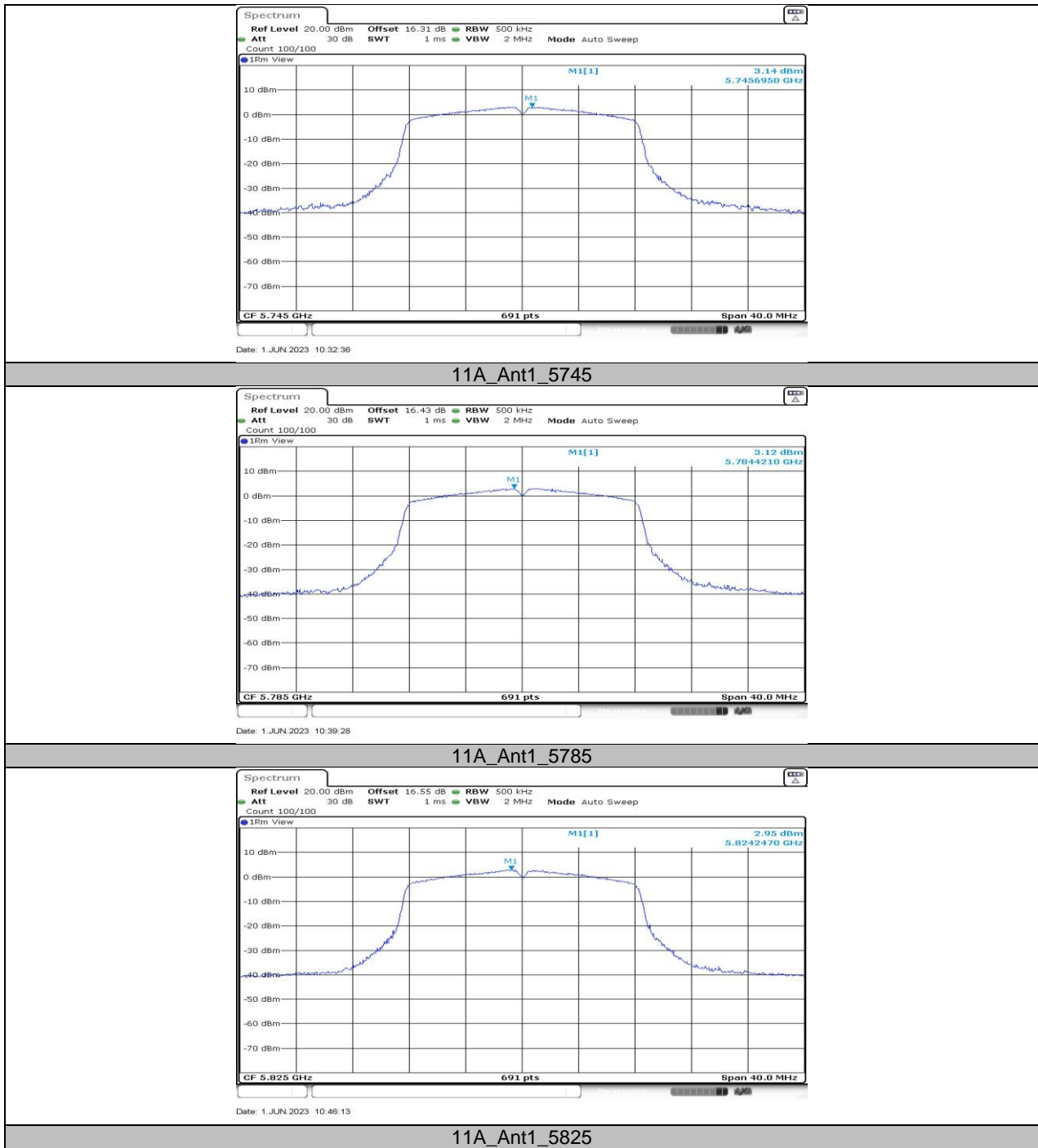



11N20SISO_Ant1_5745



11N20SISO_Ant1_5785



11N20SISO_Ant1_5825

10.6. APPENDIX G: FREQUENCY STABILITY

10.6.1. Test Result

Frequency Error vs. Voltage									
802.11a: 5745 MHz									
Temp.	Volt.	0 Minute		2 Minute		5 Minute		10 Minute	
		Freq.Error (MHz)	Tolerance (ppm)	Freq.Error (MHz)	Tolerance (ppm)	Freq.Error (MHz)	Tolerance (ppm)	Freq.Error (MHz)	Tolerance (ppm)
TN	VL	5744.9902	-1.71	5744.9904	-1.66	5744.9977	-0.41	5744.9893	-1.86
TN	VN	5744.9767	-4.06	5744.9786	-3.73	5745.0132	2.30	5745.0196	3.41
TN	VH	5745.0080	1.39	5745.0127	2.20	5745.0115	2.00	5745.0224	3.89
Frequency Error vs. Temperature									
802.11a: 5745 MHz									
Temp.	Volt.	0 Minute		2 Minute		5 Minute		10 Minute	
		Freq.Error (MHz)	Tolerance (ppm)	Freq.Error (MHz)	Tolerance (ppm)	Freq.Error (MHz)	Tolerance (ppm)	Freq.Error (MHz)	Tolerance (ppm)
55	VN	5744.9921	-1.37	5745.0093	1.61	5745.0152	2.64	5745.0243	4.22
50	VN	5745.0228	3.98	5744.9815	-3.21	5745.0014	0.24	5744.9775	-3.92
40	VN	5745.0052	0.91	5745.0071	1.24	5745.0175	3.05	5745.0126	2.20
30	VN	5744.9812	-3.27	5745.0137	2.38	5745.0218	3.80	5744.9959	-0.71
20	VN	5744.9781	-3.82	5745.0061	1.07	5745.0234	4.08	5745.0136	2.36
10	VN	5745.0068	1.18	5745.0173	3.00	5745.0181	3.15	5745.0038	0.67
0	VN	5744.9770	-4.00	5744.9833	-2.91	5744.9851	-2.59	5745.0063	1.09
-10	VN	5744.9894	-1.85	5744.9988	-0.21	5744.9902	-1.71	5745.0040	0.70

Note:

1. All antennas, test modes and test channels have been tested, only the worst data record in the report.
2. For the detail Test Conditions, please refer to section 10 TEST ENVIRONMENT.

10.7. APPENDIX H: DUTY CYCLE

10.7.1. Test Result

Test Mode	On Time (msec)	Period (msec)	Duty Cycle x (Linear)	Duty Cycle (%)	Duty Cycle Correction Factor (dB)	1/T Minimum VBW (kHz)	Final setting For VBW (kHz)
11A	2.07	2.31	0.8961	89.61	0.48	0.48	0.01
11N20SISO	1.9	2.15	0.8837	88.37	0.54	0.53	1

Note:

Duty Cycle Correction Factor=10log (1/x).

Where: x is Duty Cycle (Linear)

Where: T is On Time

If that calculated VBW is not available on the analyzer then the next higher value should be used.

10.7.2. Test Graphs

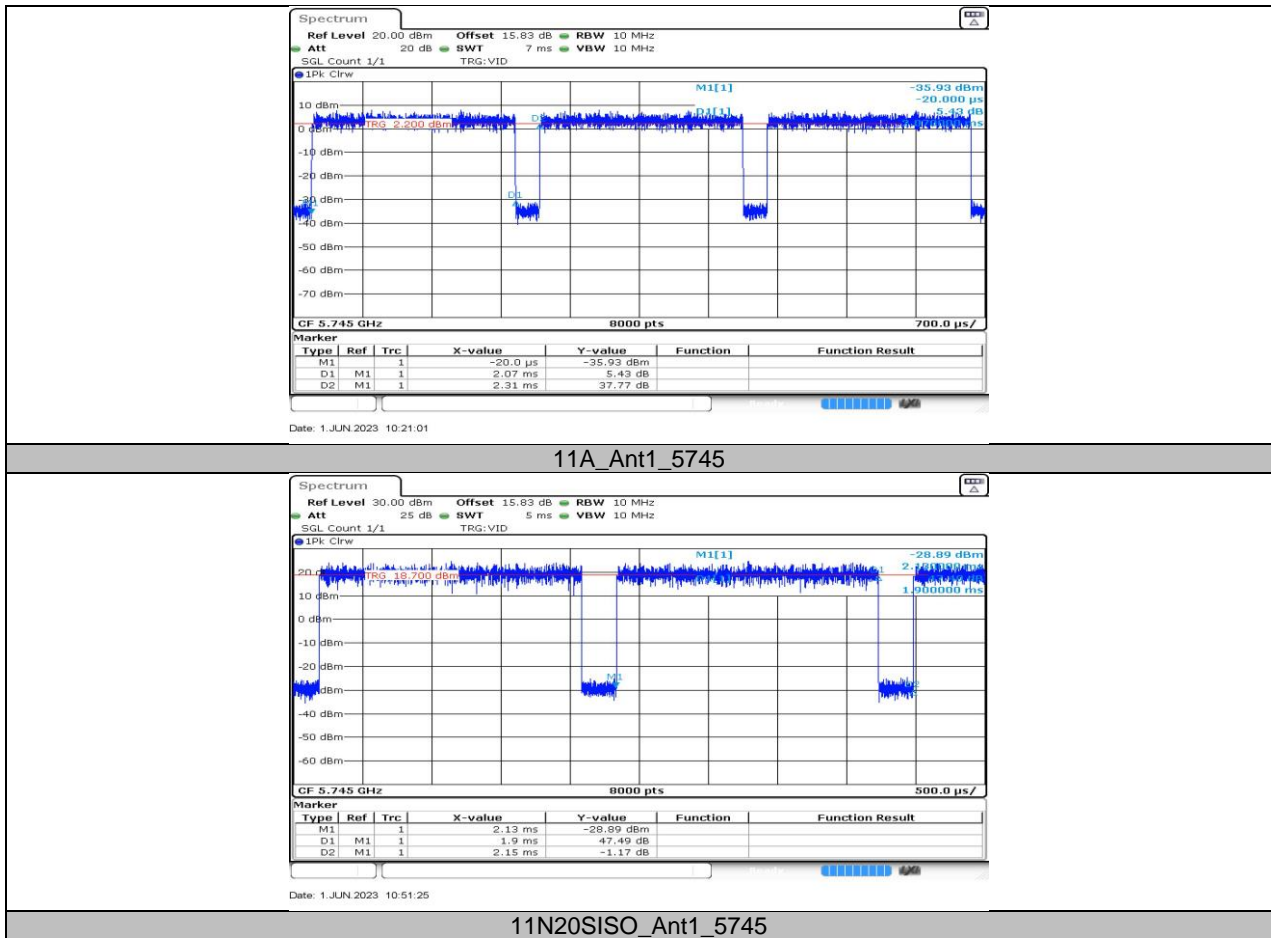

END OF REPORT