

# Test Report

FCC ID: 2ASJR-CM2-1112120

Date of issue: June 15, 2019

|                     |  |
|---------------------|--|
| Report Number:      | MTi190614E097                                      |
| Sample Description: | GT-Sense SMA Connectors                            |
| Model(s):           | CM2-1112120, CM2-1102120                           |
| Applicant:          | Globetracker, ApS                                  |
| Address:            | Strandgade 91, 4th Floor, DK-1401 Copenhagen K, DK |
| Date of Test:       | Feb. 25, 2019 to June 15, 2019                     |

Shenzhen Microtest Co., Ltd.  
<http://www.mtitest.com>

## Table of Contents

|  |           |
|--|-----------|
| <b>1. GENERAL INFORMATION.....</b>                                 | <b>5</b>  |
| 1.1. DESCRIPTION OF EUT.....                                       | 5         |
| 1.2. OPERATION CHANNEL LIST.....                                   | 5         |
| 1.3. TEST CHANNEL LIST.....  | 6         |
| 1.4. ANCILLARY EQUIPMENT LIST.....                                 | 6         |
| 1.5. DESCRIPTION OF SUPPORT UNITS.....                             | 6         |
| <b>2. SUMMARY OF TEST RESULTS.....</b>                             | <b>7</b>  |
| <b>3. TEST FACILITIES AND ACCREDITATIONS.....</b>                  | <b>8</b>  |
| .....  | 8         |
| .....  | 8         |
| 3.1. TEST LABORATORY.....  | 8         |
| 3.2. ENVIRONMENTAL CONDITIONS.....                                 | 8         |
| 3.3. MEASUREMENT UNCERTAINTY.....                                  | 8         |
| 3.4. TEST SOFTWARE.....  | 8         |
| <b>4. EQUIPMENT LIST.....</b>                                      | <b>9</b>  |
| <b>5. TEST RESULT.....</b>   | <b>10</b> |
| 5.1. ANTENNA REQUIREMENT.....                                      | 10        |
| .....  | 10        |
| .....  | 10        |
| .....  | 10        |
| .....  | 10        |
| .....  | 10        |
| .....  | 10        |
| 5.1.1 STANDARD REQUIREMENT.....                                    | 10        |
| 5.1.2 EUT ANTENNA.....   | 10        |
| 5.2. PEAK OUTPUT POWER TEST.....                                   | 11        |
| .....  | 11        |
| 5.2.1 LIMIT.....   | 11        |
| 5.2.2 TEST SETUP.....  | 11        |
| 5.2.3 TEST PROCEDURE.....  | 11        |
| 5.2.4 EUT OPERATION CONDITION.....                                 | 11        |
| 5.2.5 TEST RESULTS.....  | 11        |
| 5.3. CONDUCTED EMISSION.....                                       | 14        |
| .....  | 14        |
| 5.3.1 LIMITS.....  | 14        |
| 5.3.2 TEST SETUP.....  | 14        |
| 5.3.3 TEST PROCEDURE.....  | 15        |
| 5.3.4 TEST RESULTS.....  | 15        |
| 5.4 RADIATED SPURIOUS EMISSION.....                                | 20        |
| 5.4.1 LIMITS.....  | 20        |
| 5.4.2 TEST SETUP.....  | 21        |
| 5.4.3 TEST PROCEDURE.....  | 22        |
| 5.4.4 TEST RESULTS.....  | 23        |
| 5.4.4.1 RADIATION EMISSION.....                                    | 23        |
| 5.4.4.2 BANDEDGE-RADIATED.....                                     | 27        |
| 5.4.4.3 SPURIOUS EMISSION IN RESTRICTED BAND 3260MHZ-18000MHZ..... | 28        |
| 5.5 POWER SPECTRAL DENSITY TEST.....                               | 29        |
| 5.5.1 LIMIT.....   | 29        |
| 5.5.2 TEST PROCEDURE.....  | 29        |
| 5.5.3 TEST SETUP.....  | 29        |
| 5.5.4 EUT OPERATION CONDITIONS.....                                | 29        |

|   |           |
|---|-----------|
| 5.5.5 TEST RESULTS.....                   | 30        |
| 5.6 6DB BANDWIDTH.....                    | 32        |
| 5.6.1 LIMIT.....                          | 32        |
| 5.6.2 TEST PROCEDURE.....                 | 32        |
| 5.6.3 TEST SETUP.....                     | 32        |
| 5.6.4 EUT OPERATION CONDITIONS.....       | 32        |
| 5.6.5 TEST RESULT.....                    | 32        |
| 5.7 CONDUCTED BANDEDGE.....               | 35        |
| 5.7.1 LIMITS.....                         | 35        |
| 5.7.2 TEST SETUP.....                     | 35        |
| 5.7.3 TEST PROCEDURE.....                 | 35        |
| 5.7.4 EUT OPERATION CONDITIONS.....       | 35        |
| 5.7.5 TEST RESULT.....                    | 35        |
| <b>PHOTOGRAPHS OF THE TEST SETUP.....</b> | <b>37</b> |
| <b>PHOTOGRAPHS OF THE EUT.....</b>        | <b>39</b> |

## PRODUCT INFORMATION

Applicant's name: Globetracker, ApS

Address: Strandgade 91, 4th Floor, DK-1401 Copenhagen K, DK

Manufacture's Name: Danchell

Address: Lyngvej 8-DK-4450 4450 Jyderup Denmark

Product name: GT-Sense SMA Connectors

Trademark: GT-Sense

Model name: CM2-1112120, CM2-1102120

Standards: FCC Part 15.247

Test Procedure: ANSI C63.10:2013  
KDB 558074 D01 DTS Meas Guidance v05r02

*This device described above has been tested by Shenzhen Microtest Co., Ltd and the test results show that the equipment under test (EUT) is in compliance with the FCC requirements. And it is applicable only to the tested sample identified in the report.*

Tested by:



Demi Mu

June 15, 2019

Reviewed by:



Blue Zheng

June 15, 2019

Approved by:



Smith Chen

June 15, 2019

## 1. General Information

### 1.1. Description of EUT

|                              |  |
|------------------------------|--|
| Product name:                | GT-Sense SMA Connectors  |
| Model name:                  | CM2-1112120  |
| Serial model:                | CM2-1102120  |
| Difference in series models: | All the model are the same circuit and RF module, except the CM2-110210 has some temperature, humidity and pressure sensors removed. |
| Operation frequency:         | 2402-2480MHz   |
| Modulation type:             | GFSK   |
| Bit Rate of transmitter:     | 1 Mbps   |
| Antenna type:                | Chip Antenna   |
| Antenna gain:                | 0.5dBi   |
| Max. output power:           | -1.570dBm  |
| Hardware version:            | 3  |
| Software version:            | 60_3   |
| Power supply:                | DC 3.7V from battery or DC 36V from adapter  |
| Adapter information:         | N/A  |
| Battery:                     | DC 3.7V 1800mAh  |

### 1.2. Operation channel list

| Channel No. | Frequency (MHz) | Channel No. | Frequency (MHz) | Channel No. | Frequency (MHz) | Channel No. | Frequency (MHz) |
|-------------|-----------------|-------------|-----------------|-------------|-----------------|-------------|-----------------|
| 0           | 2402            | 10          | 2422            | 20          | 2442            | 30          | 2462            |
| 1           | 2404            | 11          | 2424            | 21          | 2444            | 31          | 2464            |
| 2           | 2406            | 12          | 2426            | 22          | 2446            | 32          | 2466            |
| 3           | 2408            | 13          | 2428            | 23          | 2448            | 33          | 2468            |
| 4           | 2410            | 14          | 2430            | 24          | 2450            | 34          | 2470            |
| 5           | 2412            | 15          | 2432            | 25          | 2452            | 35          | 2472            |
| 6           | 2414            | 16          | 2434            | 26          | 2454            | 36          | 2474            |
| 7           | 2416            | 17          | 2436            | 27          | 2456            | 37          | 2476            |
| 8           | 2418            | 18          | 2438            | 28          | 2458            | 38          | 2478            |

|   |      |    |      |    |      |    |      |
|---|------|----|------|----|------|----|------|
| 9 | 2420 | 19 | 2440 | 29 | 2460 | 39 | 2480 |
|---|------|----|------|----|------|----|------|

1.3. Test channel list

| Channel | Channel | Frequency (MHz) |
|---------|---------|-----------------|
| Low     | 00      | 2402            |
| Middle  | 19      | 2440            |
| High    | 39      | 2480            |

1.4. Ancillary equipment list

| Equipment | Model | S/N | Manufacturer | Certificate type |
|-----------|-------|-----|--------------|------------------|
| Adapter   | /     | /   | /            | /                |

1.5. Description of Support Units

The EUT has been tested as an independent unit together with other necessary accessories or support units. The following support units or accessories were used to form a representative test configuration during the tests.

| Item | Equipment | Brand | Model/Type No. | Series No. | Note |
|------|-----------|-------|----------------|------------|------|
| /    | /         | /     | /              | /          |      |
| /    | /         | /     | /              | /          |      |

Note:

(1)The support equipment was authorized by Declaration of Confirmation.

(2)For detachable type I/O cable should be specified the length in cm in 『Length』 column.

## 2. Summary of Test Results

Test procedures according to the technical standards:

| No. | Standard Section    | Test Item                  | Result | Remark |
|-----|---------------------|----------------------------|--------|--------|
| 1   | 15.203              | Antenna Requirement        | Pass   |        |
| 2   | 15.247 (b)          | Peak Output Power          | Pass   |        |
| 3   | 15.207              | Conducted Emission         | Pass   |        |
| 4   | 15.247 (d) & 15.209 | Radiated Spurious Emission | Pass   |        |
| 5   | 15.247 (e)          | Power Spectral Density     | Pass   |        |
| 6   | 15.247 (a)(2)       | 6dB Bandwidth              | Pass   |        |
| 7   | 15.205              | Band Edge Emission         | Pass   |        |

### 3. Test Facilities and Accreditations

#### 3.1. Test laboratory

|                       |   |
|-----------------------|---|
| Test Laboratory       | Shenzhen Microtest Co., Ltd   |
| Location              | No.102A & 302A, East Block, Hengfang Industrial Park, Xingye Road, Xixiang, Bao'an District, Shenzhen, Guangdong, China |
| FCC Registration No.: | 448573  |

#### 3.2. Environmental conditions

|                      |              |
|----------------------|--------------|
| Temperature:         | 15°C~35°C    |
| Humidity             | 20%~75%      |
| Atmospheric pressure | 98kPa~101kPa |

#### 3.3. Measurement uncertainty

The reported uncertainty of measurement  $y \pm U$  where expanded uncertainty  $U$  is based on a standard uncertainty multiplied by a coverage factor of  $k=2$  providing a level of confidence of approximately 95 %

| No. | Item                          | Uncertainty             |
|-----|-------------------------------|-------------------------|
| 1   | Conducted Emission Test       | $\pm 1.38\text{dB}$     |
| 2   | RF power, conducted           | $\pm 0.16\text{dB}$     |
| 3   | Spurious emissions, conducted | $\pm 0.21\text{dB}$     |
| 4   | All emissions, radiated(<1G)  | $\pm 4.68\text{dB}$     |
| 5   | All emissions, radiated(>1G)  | $\pm 4.89\text{dB}$     |
| 6   | Temperature                   | $\pm 0.5^\circ\text{C}$ |
| 7   | Humidity                      | $\pm 2\%$               |

#### 3.4. Test software

| Software Name  | Manufacturer | Model | Version   |
|----------------|--------------|-------|-----------|
| RF Test System | Farad        | LZ-RF | Lz_Rf 3A3 |



#### 4. Equipment list

| Equipment No. | Equipment Name                       | Manufacturer                  | Model          | Serial No.    | Calibration date | Due date   |
|---------------|--------------------------------------|-------------------------------|----------------|---------------|------------------|------------|
| MTI-E001      | Spectrum Analyzer                    | Agilent                       | E4407B         | MY41441082    | 2018/09/18       | 2019/09/17 |
| MTI-E004      | EMI Test Receiver                    | Rohde&schwarz                 | ESPI           | 1000314       | 2018/09/18       | 2019/09/17 |
| MTI-E006      | Broadband antenna                    | schwarzbeck                   | VULB9163       | 872           | 2018/09/18       | 2019/09/17 |
| MTI-E007      | Horn antenna                         | schwarzbeck                   | BBHA9120D      | 1201          | 2018/09/18       | 2019/09/17 |
| MTI-E014      | amplifier                            | America                       | 8447D          | 3113A06150    | 2018/09/18       | 2019/09/17 |
| MTI-E015      | Conduction Immunity Signal Generator | Schloder                      | CDG6000        | 126A1343/2015 | 2018/09/18       | 2019/09/17 |
| MTI-E016      | Coupled decoupling network           | Schloder                      | CND M2/M3      | A2210332/2015 | 2018/09/18       | 2019/09/17 |
| MTI-E034      | amplifier                            | Agilent                       | 8449B          | 3008A02400    | 2018/09/18       | 2019/09/17 |
| MTI-E037      | Artificial power network             | Schwarzbeck                   | NSLK8127       | #841          | 2018/09/18       | 2019/09/17 |
| MTI-E040      | Spectrum analyzer                    | Agilent                       | N9020A         | MY49100060    | 2018/09/18       | 2019/09/17 |
| MTI-E041      | Signal generator                     | Agilent                       | N5182A         | MY49060455    | 2018/09/18       | 2019/09/17 |
| MTI-E042      | Analog signal generator              | Agilent                       | E4421B         | GB40051240    | 2018/09/18       | 2019/09/17 |
| MTI-E043      | Power sensor                         | Dare Instruments              | RPR3006W       | 16I00054SN016 | 2018/09/18       | 2019/09/17 |
| MTI-E047      | 10dB attenuator                      | Mini-Circuits                 | UNAT-10+       | 15542         | 2018/09/18       | 2019/09/17 |
| MTI-E049      | spectrum analyzer                    | Rohde&schwarz                 | FSP-38         | 100019        | 2018/09/18       | 2019/09/17 |
| MTI-E050      | PSG Signal generator                 | Agilent                       | E8257D         | MY46520873    | 2018/09/18       | 2019/09/17 |
| MTI-E061      | Active Loop Antenna 9kHz - 30MHz     | Schwarzbeck                   | FMZB 1519 B    | 00044         | 2018/09/18       | 2019/09/17 |
| MTI-E052      | 18-40GHz amplifier                   | Chengdu step Micro Technology | ZLNA-18-40G-21 | 1608001       | 2018/09/18       | 2019/09/17 |
| MTI-E053      | 15-40G Antenna                       | Schwarzbeck                   | BBHA9170       | BBHA9170582   | 2018/09/18       | 2019/09/17 |
| MTI-E058      | Artificial power network             | Schwarzbeck                   | NSLK8127       | #841          | 2018/09/18       | 2019/09/17 |

Note: the calibration interval of the above test instruments is 12 months and the calibrations are traceable to international system unit (SI).

## 5. Test Result

### 5.1. Antenna requirement

#### 5.1.1 Standard requirement

15.203 requirement: For intentional device, according to 15.203: an intentional radiator shall be designed to ensure that no antenna other than that furnished by the responsible party shall be used with the device

#### 5.1.2 EUT Antenna

The EUT antenna is Chip antenna (0.5dBi). It comply with the standard requirement. In case of replacement of broken antenna the same antenna type must be used.

## 5.2. Peak output power test

### 5.2.1 Limit

| FCC Part15 Subpart C |                   |                 |                       |
|----------------------|-------------------|-----------------|-----------------------|
| Section              | Test Item         | Limit           | Frequency Range (MHz) |
| 15.247(b)(3)         | Peak output power | 1 watt or 30dBm | 2400-2483.5           |

### 5.2.2 Test setup

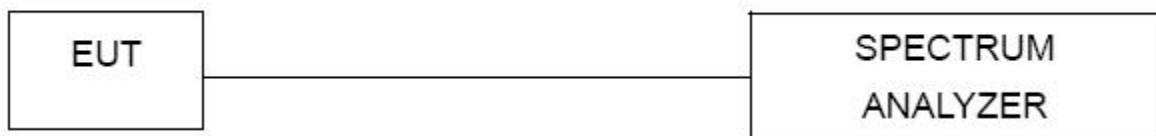

### 5.2.3 Test procedure

- (1) The EUT was directly connected to the spectrum analyzer and antenna output port as show in the block diagram above.
- (2) Spectrum Setting:  
RBW=1MHz, VBW=3MHz, Detector=Peak (If 20dB BW ≤1 MHz)  
RBW=3MHz, VBW=8MHz, Detector=Peak (If 20dB BW > 1 MHz)
- (3) The EUT was set to continuously transmitting in the max power during the test.

### 5.2.4 EUT operation condition

The EUT tested system was configured as the statements of 2.4 Unless otherwise a special operating condition is specified in the follows during the testing.

### 5.2.5 Test results

|               |                         |                     |                    |
|---------------|-------------------------|---------------------|--------------------|
| EUT :         | GT-Sense SMA Connectors | Model Name :        | CM2-1112120        |
| Temperature : | 25 °C                   | Relative Humidity : | 60%                |
| Pressure :    | 1012 hPa                | Test Voltage :      | DC 3.7V by battery |

TX BLE mode

| Test Channel | Frequency | Maximum Conducted Output Power(PK) | Limit |
|--------------|-----------|------------------------------------|-------|
|              | (MHz)     | (dBm)                              | dBm   |
| CH00         | 2402      | -1.622                             | 30    |
| CH19         | 2440      | -1.570                             | 30    |
| CH39         | 2480      | -2.267                             | 30    |

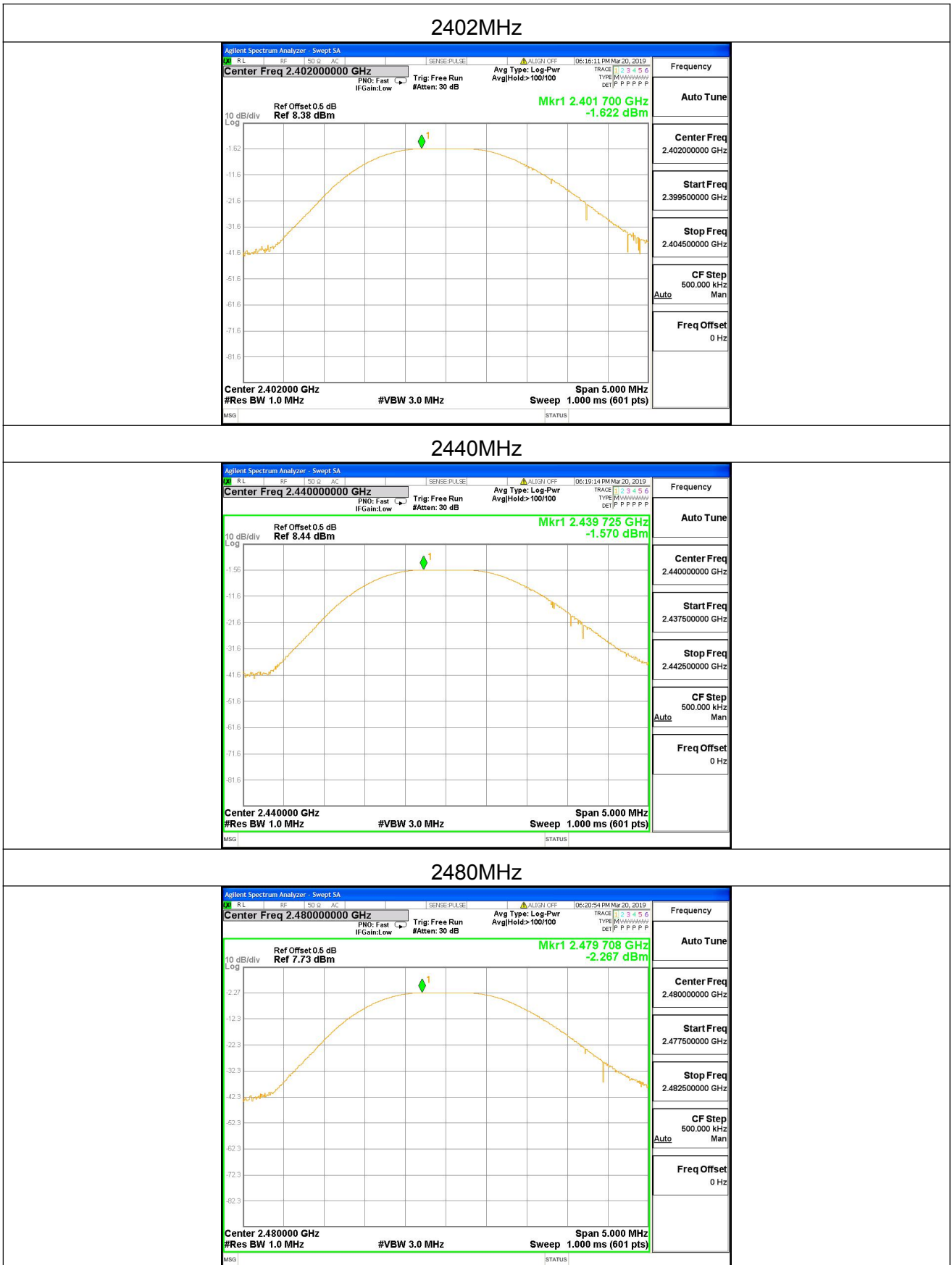

### 5.3. Conducted emission

#### 5.3.1 Limits

| FREQUENCY (MHz) | Class B (dBuV) |           |
|-----------------|----------------|-----------|
|                 | Quasi-peak     | Average   |
| 0.15 -0.5       | 66 - 56 *      | 56 - 46 * |
| 0.50 -5.0       | 56.00          | 46.00     |
| 5.0 -30.0       | 60.00          | 50.00     |

**Note**

(1)The tighter limit applies at the band edges.

(2)The limit of " \* " marked band means the limitation decreases linearly with the logarithm of the frequency in the range.

#### 5.3.2 Test setup

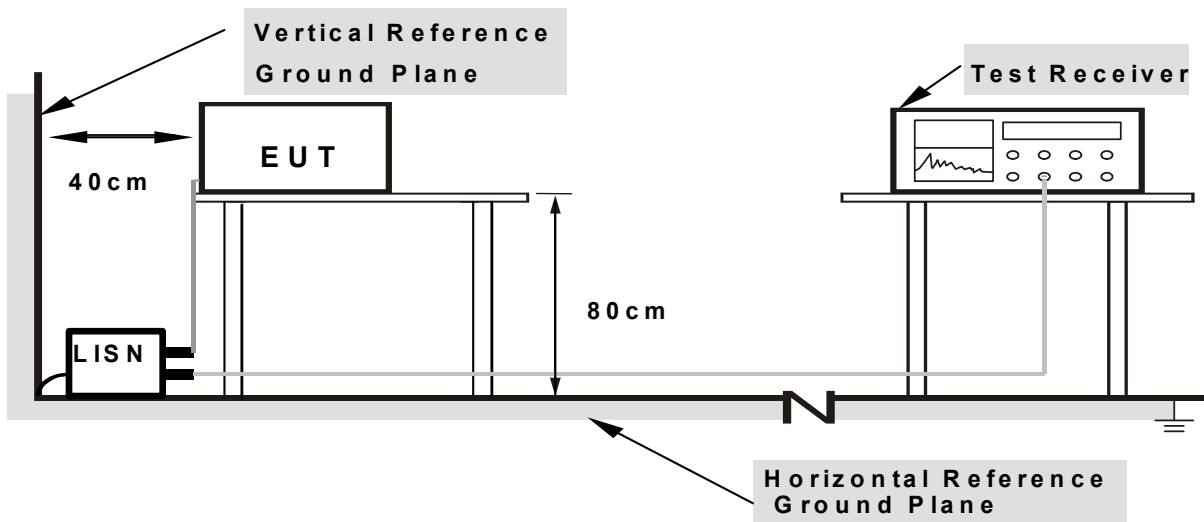

**Note: 1.Support units were connected to second LISN .**

**2.Both of LISNs (AMN) are 80 cm from EUT and at least 80 from other units and other metal planes**

### 5.3.3 Test procedure

#### a. EUT Operating Conditions

The EUT was configured for testing in a typical fashion (as a customer would normally use it). The EUT has been programmed to continuously transmit during test. This operating condition was tested and used to collect the included data.

#### b. The following table is the setting of the receiver

| Receiver Parameters | Setting  |
|---------------------|----------|
| Attenuation         | 10 dB    |
| Start Frequency     | 0.15 MHz |
| Stop Frequency      | 30 MHz   |
| IF Bandwidth        | 9 kHz    |

- c. The EUT was placed 0.8 meters from the horizontal ground plane with EUT being connected to the power mains through a line impedance stabilization network (LISN). All other support equipments powered from additional LISN(s). The LISN provide 50 Ohm/ 50uH of coupling impedance for the measuring instrument.
- d. Interconnecting cables that hang closer than 40 cm to the ground plane shall be folded back and forth in the center forming a bundle 30 to 40 cm long.
- e. I/O cables that are not connected to a peripheral shall be bundled in the center. The end of the cable may be terminated, if required, using the correct terminating impedance. The overall length shall not exceed 1 m.
- f. LISN at least 80 cm from nearest part of EUT chassis.

For the actual test configuration, please refer to the related Item –EUT Test Photos.

### 5.3.4 Test results

Test data

|                |                                  |                     |             |
|----------------|----------------------------------|---------------------|-------------|
| EUT :          | GT-Sense SMA Connectors          | Model Name. :       | CM2-1112120 |
| Temperature :  | 26 °C                            | Relative Humidity : | 54%         |
| Pressure :     | 1010hPa                          | Phase :             | L           |
| Test Voltage : | DC 36V from adapter AC 120V/60Hz | Test Mode :         | Charging+TX |

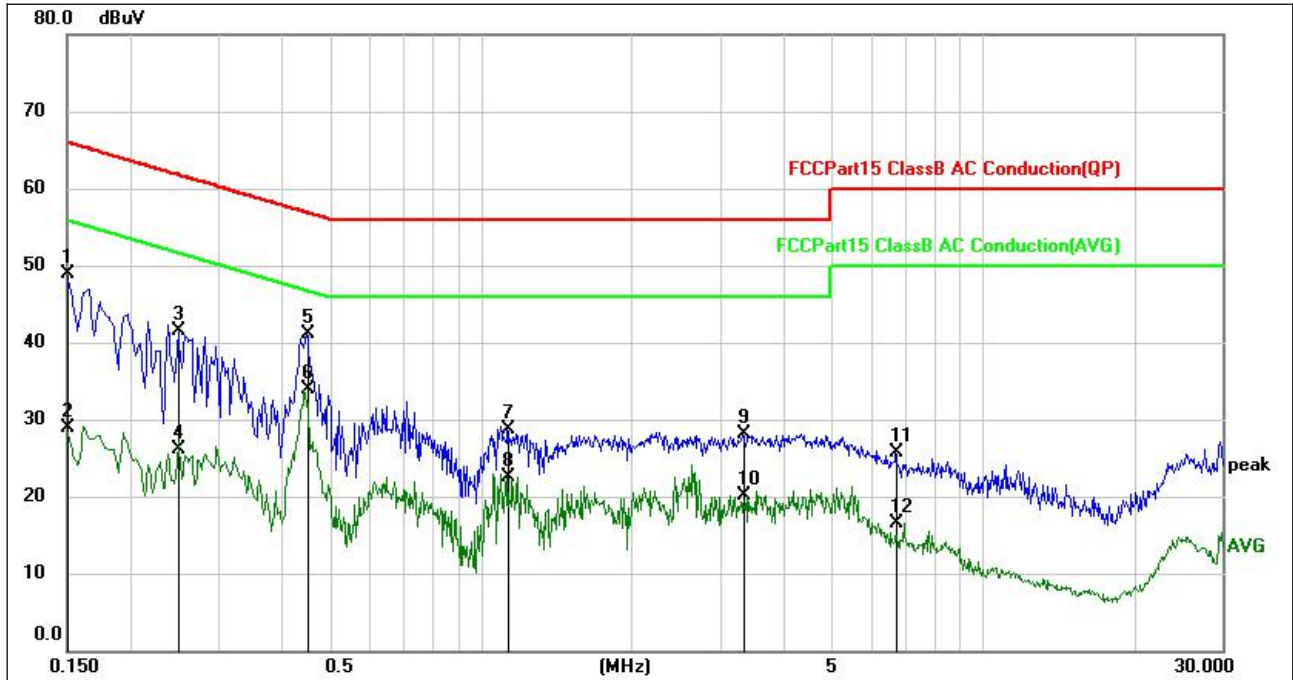

| No. | Mk. | Freq.<br>MHz | Reading<br>Level<br>dBuV | Correct<br>Factor<br>dB | Measure-<br>ment<br>dBuV | Limit<br>dBuV | Over<br>dB | Detector | Comment |
|-----|-----|--------------|--------------------------|-------------------------|--------------------------|---------------|------------|----------|---------|
| 1   |     | 0.1500       | 38.44                    | 10.51                   | 48.95                    | 66.00         | -17.05     | QP       |         |
| 2   |     | 0.1500       | 18.49                    | 10.51                   | 29.00                    | 56.00         | -27.00     | AVG      |         |
| 3   |     | 0.2500       | 30.98                    | 10.47                   | 41.45                    | 61.76         | -20.31     | QP       |         |
| 4   |     | 0.2500       | 15.60                    | 10.47                   | 26.07                    | 51.76         | -25.69     | AVG      |         |
| 5   |     | 0.4500       | 30.66                    | 10.43                   | 41.09                    | 56.88         | -15.79     | QP       |         |
| 6   | *   | 0.4500       | 23.54                    | 10.43                   | 33.97                    | 46.88         | -12.91     | AVG      |         |
| 7   |     | 1.1300       | 18.40                    | 10.36                   | 28.76                    | 56.00         | -27.24     | QP       |         |
| 8   |     | 1.1300       | 12.14                    | 10.36                   | 22.50                    | 46.00         | -23.50     | AVG      |         |
| 9   |     | 3.3300       | 17.92                    | 10.21                   | 28.13                    | 56.00         | -27.87     | QP       |         |
| 10  |     | 3.3300       | 9.82                     | 10.21                   | 20.03                    | 46.00         | -25.97     | AVG      |         |
| 11  |     | 6.7060       | 15.23                    | 10.47                   | 25.70                    | 60.00         | -34.30     | QP       |         |
| 12  |     | 6.7060       | 5.96                     | 10.47                   | 16.43                    | 50.00         | -33.57     | AVG      |         |



|                |                                  |                     |             |
|----------------|----------------------------------|---------------------|-------------|
| EUT :          | GT-Sense SMA Connectors          | Model Name. :       | CM2-1112120 |
| Temperature :  | 26 °C                            | Relative Humidity : | 54%         |
| Pressure :     | 1010hPa                          | Phase :             | N           |
| Test Voltage : | DC 36V from adapter AC 120V/60Hz | Test Mode :         | Charging+TX |

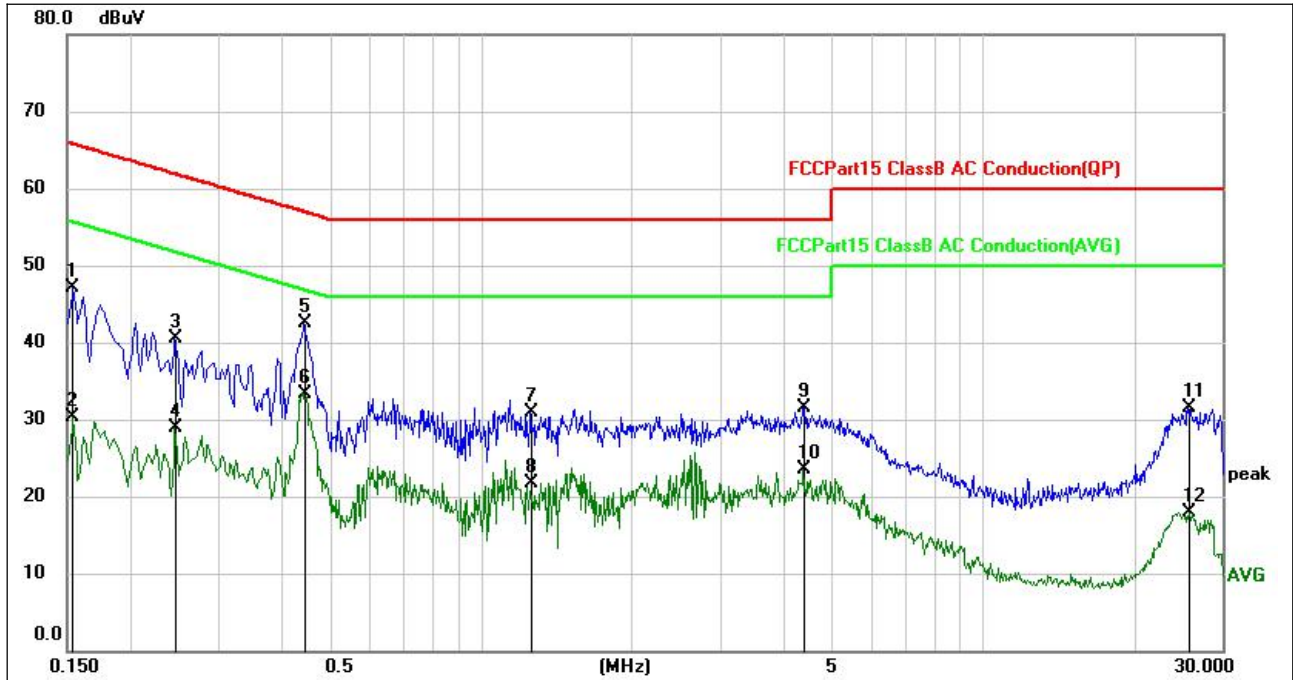

| No. | Mk. | Freq.<br>MHz | Reading<br>Level<br>dBuV | Correct<br>Factor<br>dB | Measure-<br>ment<br>dBuV | Limit<br>dBuV | Over<br>dB | Detector | Comment |
|-----|-----|--------------|--------------------------|-------------------------|--------------------------|---------------|------------|----------|---------|
| 1   |     | 0.1539       | 36.65                    | 10.51                   | 47.16                    | 65.79         | -18.63     | QP       |         |
| 2   |     | 0.1539       | 19.78                    | 10.51                   | 30.29                    | 55.79         | -25.50     | AVG      |         |
| 3   |     | 0.2460       | 30.00                    | 10.48                   | 40.48                    | 61.89         | -21.41     | QP       |         |
| 4   |     | 0.2460       | 18.38                    | 10.48                   | 28.86                    | 51.89         | -23.03     | AVG      |         |
| 5   |     | 0.4460       | 32.01                    | 10.42                   | 42.43                    | 56.95         | -14.52     | QP       |         |
| 6   | *   | 0.4460       | 22.98                    | 10.42                   | 33.40                    | 46.95         | -13.55     | AVG      |         |
| 7   |     | 1.2620       | 20.63                    | 10.35                   | 30.98                    | 56.00         | -25.02     | QP       |         |
| 8   |     | 1.2620       | 11.27                    | 10.35                   | 21.62                    | 46.00         | -24.38     | AVG      |         |
| 9   |     | 4.4060       | 21.33                    | 10.26                   | 31.59                    | 56.00         | -24.41     | QP       |         |
| 10  |     | 4.4060       | 13.28                    | 10.26                   | 23.54                    | 46.00         | -22.46     | AVG      |         |
| 11  |     | 25.6780      | 20.39                    | 11.07                   | 31.46                    | 60.00         | -28.54     | QP       |         |
| 12  |     | 25.6780      | 6.88                     | 11.07                   | 17.95                    | 50.00         | -32.05     | AVG      |         |

|                |                                  |                     |             |
|----------------|----------------------------------|---------------------|-------------|
| EUT :          | GT-Sense SMA Connectors          | Model Name. :       | CM2-1112120 |
| Temperature :  | 26 °C                            | Relative Humidity : | 54%         |
| Pressure :     | 1010hPa                          | Phase :             | L           |
| Test Voltage : | DC 36V from adapter AC 240V/60Hz | Test Mode :         | Charging+TX |

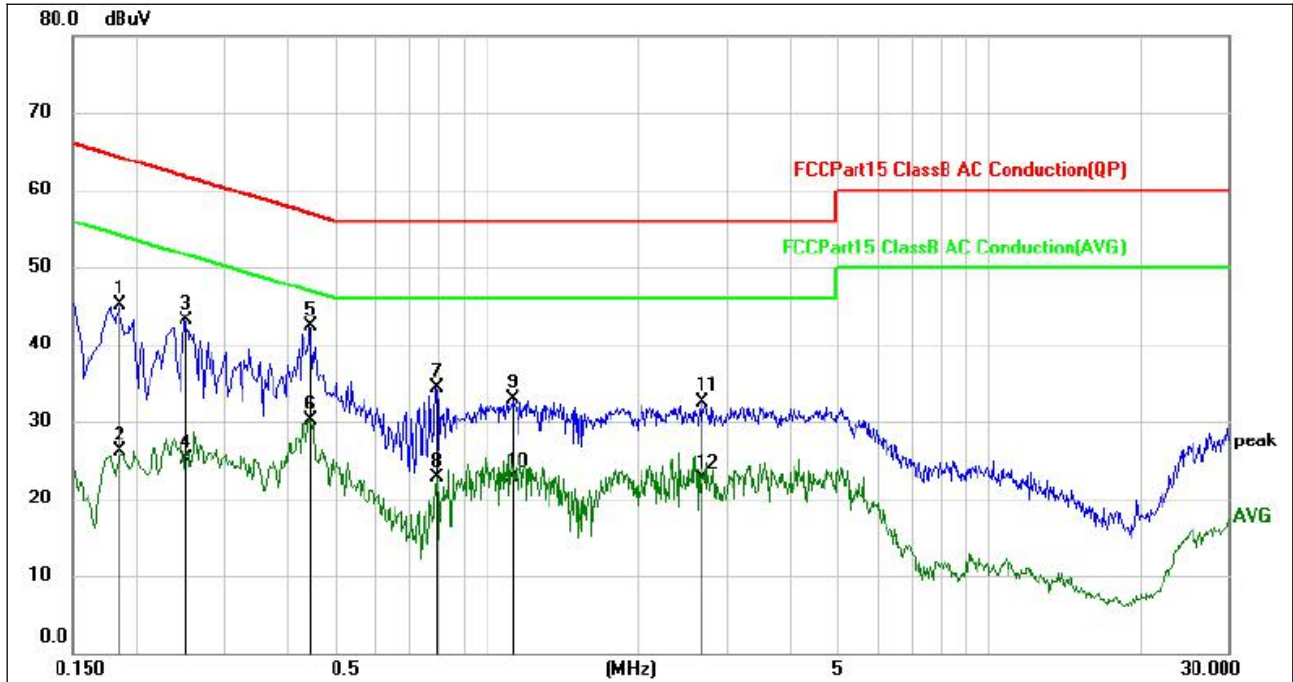

| No. | Mk. | Freq.<br>MHz | Reading<br>Level<br>dBuV | Correct<br>Factor<br>dB | Measure-<br>ment<br>dBuV | Limit<br>dBuV | Over<br>dB | Detector | Comment |
|-----|-----|--------------|--------------------------|-------------------------|--------------------------|---------------|------------|----------|---------|
| 1   |     | 0.1859       | 34.65                    | 10.50                   | 45.15                    | 64.22         | -19.07     | QP       |         |
| 2   |     | 0.1859       | 15.61                    | 10.50                   | 26.11                    | 54.22         | -28.11     | AVG      |         |
| 3   |     | 0.2508       | 32.62                    | 10.47                   | 43.09                    | 61.73         | -18.64     | QP       |         |
| 4   |     | 0.2508       | 14.67                    | 10.47                   | 25.14                    | 51.73         | -26.59     | AVG      |         |
| 5   | *   | 0.4460       | 31.88                    | 10.42                   | 42.30                    | 56.95         | -14.65     | QP       |         |
| 6   |     | 0.4460       | 19.72                    | 10.42                   | 30.14                    | 46.95         | -16.81     | AVG      |         |
| 7   |     | 0.7940       | 23.88                    | 10.39                   | 34.27                    | 56.00         | -21.73     | QP       |         |
| 8   |     | 0.7940       | 12.37                    | 10.39                   | 22.76                    | 46.00         | -23.24     | AVG      |         |
| 9   |     | 1.1258       | 22.55                    | 10.36                   | 32.91                    | 56.00         | -23.09     | QP       |         |
| 10  |     | 1.1258       | 12.25                    | 10.36                   | 22.61                    | 46.00         | -23.39     | AVG      |         |
| 11  |     | 2.6819       | 22.32                    | 10.27                   | 32.59                    | 56.00         | -23.41     | QP       |         |
| 12  |     | 2.6819       | 12.23                    | 10.27                   | 22.50                    | 46.00         | -23.50     | AVG      |         |

|                |                                  |                     |             |
|----------------|----------------------------------|---------------------|-------------|
| EUT :          | GT-Sense SMA Connectors          | Model Name. :       | CM2-1112120 |
| Temperature :  | 26 °C                            | Relative Humidity : | 54%         |
| Pressure :     | 1010hPa                          | Phase :             | N           |
| Test Voltage : | DC 36V from adapter AC 240V/60Hz | Test Mode :         | Charging+TX |

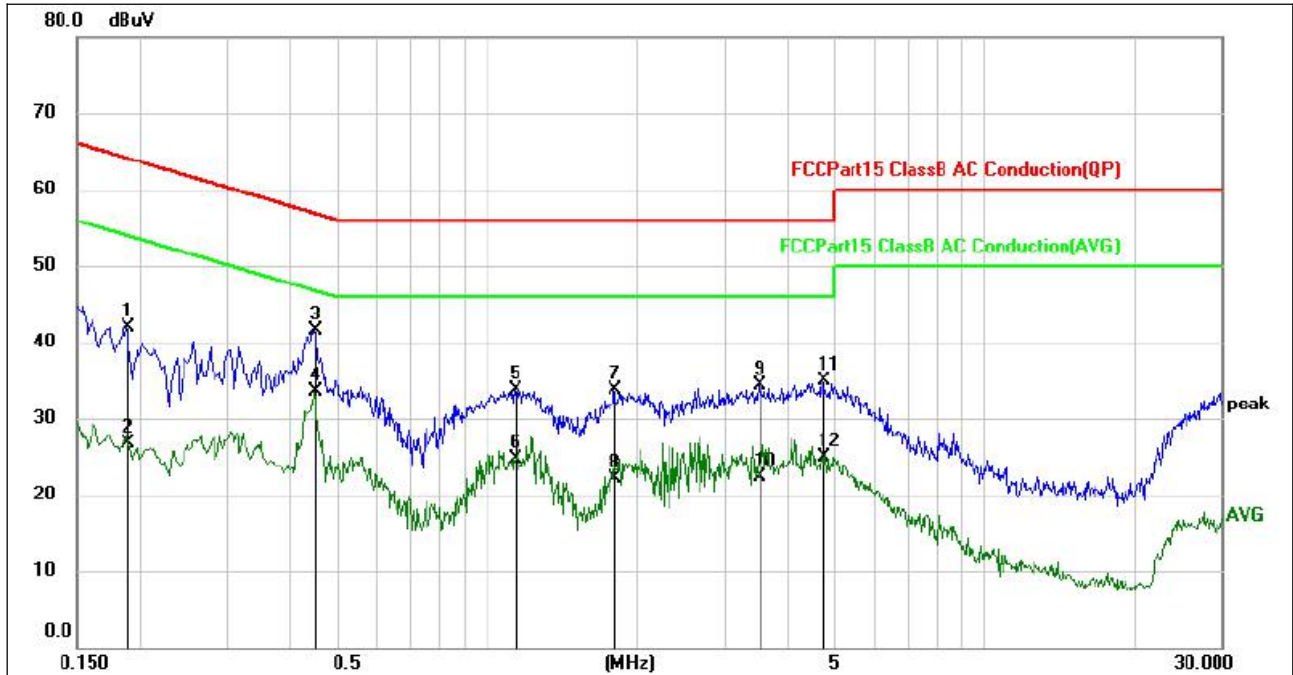

| No. | Mk. | Freq.<br>MHz | Reading<br>Level<br>dBuV | Correct<br>Factor<br>dB | Measure-<br>ment<br>dBuV | Limit<br>dBuV | Over<br>dB | Detector | Comment |
|-----|-----|--------------|--------------------------|-------------------------|--------------------------|---------------|------------|----------|---------|
| 1   |     | 0.1884       | 31.37                    | 10.50                   | 41.87                    | 64.11         | -22.24     | QP       |         |
| 2   |     | 0.1884       | 16.21                    | 10.50                   | 26.71                    | 54.11         | -27.40     | AVG      |         |
| 3   |     | 0.4500       | 31.13                    | 10.43                   | 41.56                    | 56.88         | -15.32     | QP       |         |
| 4   | *   | 0.4500       | 22.99                    | 10.43                   | 33.42                    | 46.88         | -13.46     | AVG      |         |
| 5   |     | 1.1378       | 23.26                    | 10.36                   | 33.62                    | 56.00         | -22.38     | QP       |         |
| 6   |     | 1.1378       | 14.41                    | 10.36                   | 24.77                    | 46.00         | -21.23     | AVG      |         |
| 7   |     | 1.8020       | 23.29                    | 10.33                   | 33.62                    | 56.00         | -22.38     | QP       |         |
| 8   |     | 1.8020       | 11.71                    | 10.33                   | 22.04                    | 46.00         | -23.96     | AVG      |         |
| 9   |     | 3.5100       | 24.01                    | 10.20                   | 34.21                    | 56.00         | -21.79     | QP       |         |
| 10  |     | 3.5100       | 12.05                    | 10.20                   | 22.25                    | 46.00         | -23.75     | AVG      |         |
| 11  |     | 4.7378       | 24.64                    | 10.30                   | 34.94                    | 56.00         | -21.06     | QP       |         |
| 12  |     | 4.7378       | 14.58                    | 10.30                   | 24.88                    | 46.00         | -21.12     | AVG      |         |

## 5.4 Radiated spurious emission

### 5.4.1 Limits

| Frequency (MHz) | Field Strength (micorvolts/meter) | Measurement Distance (meters) |
|-----------------|-----------------------------------|-------------------------------|
| 0.009~0.490     | 2400/F(KHz)                       | 300                           |
| 0.490~1.705     | 24000/F(KHz)                      | 30                            |
| 1.705~30.0      | 30                                | 30                            |
| 30~88           | 100                               | 3                             |
| 88~216          | 150                               | 3                             |
| 216~960         | 200                               | 3                             |
| Above 960       | 500                               | 3                             |

| Spectrum Parameter                    | Setting  |
|---------------------------------------|--|
| Attenuation                           | Auto   |
| Start Frequency                       | 1000 MHz   |
| Stop Frequency                        | 10th carrier harmonic                            |
| RB / VB (emission in restricted band) | 1 MHz / 1 MHz for Peak, 1 MHz / 10Hz for Average |

| Receiver Parameter     | Setting                          |
|------------------------|----------------------------------|
| Attenuation            | Auto                             |
| Start ~ Stop Frequency | 9kHz~150kHz / RB 200Hz for QP    |
| Start ~ Stop Frequency | 150kHz~30MHz / RB 9kHz for QP    |
| Start ~ Stop Frequency | 30MHz~1000MHz / RB 120kHz for QP |

5.4.2 Test setup

Radiated emission test-up frequency below 30MHz

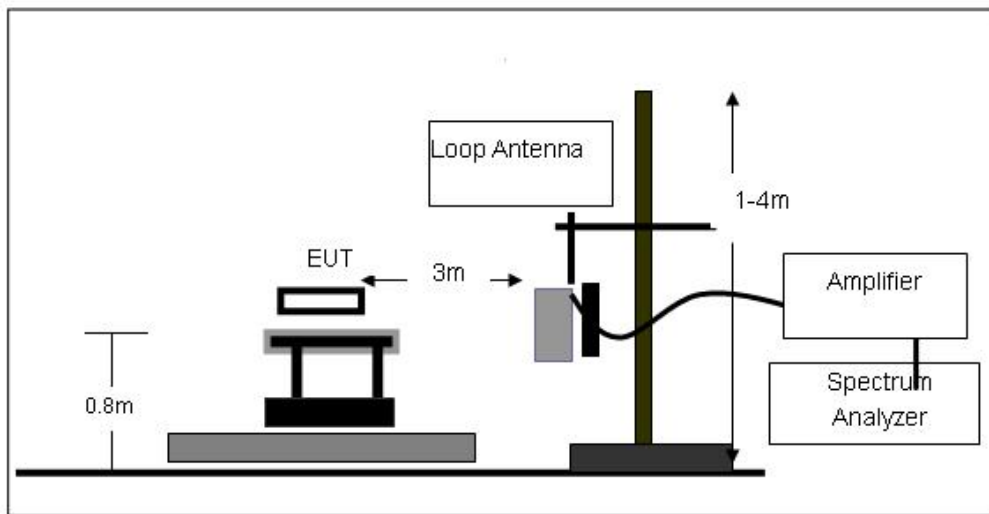

Radiated emission test-up frequency 30MHz~1GHz

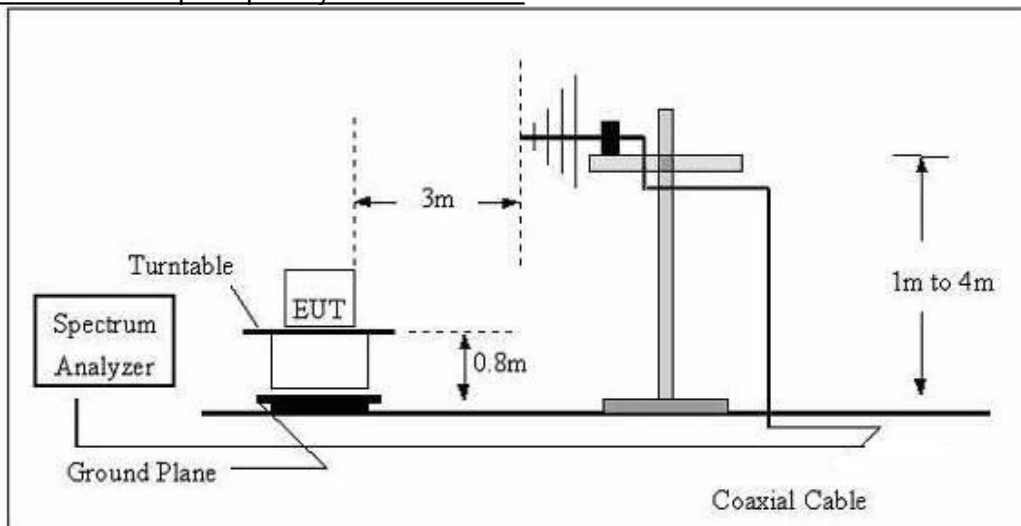

Radiated emission test-up frequency above 1GHz

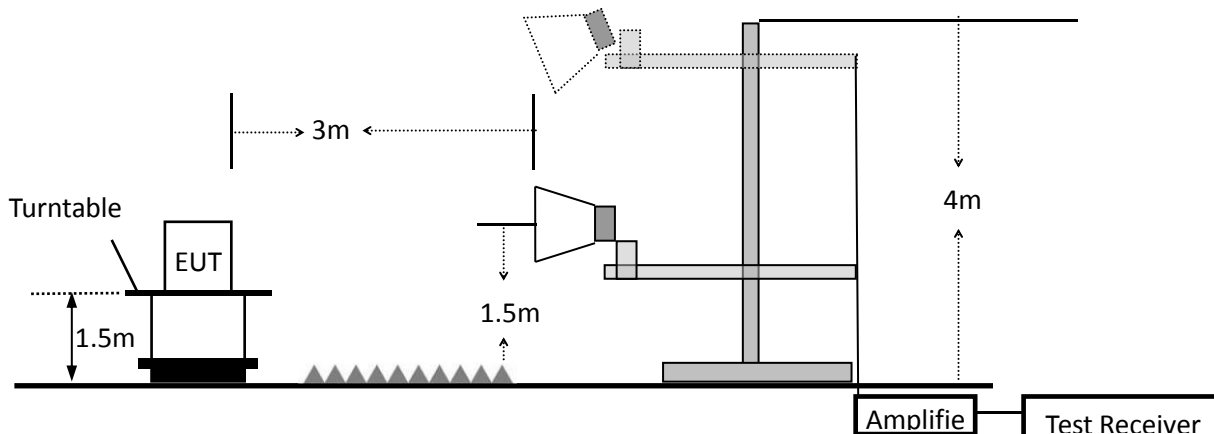

### 5.4.3 Test procedure

- a. EUT operating conditions. The EUT tested system was configured as the statements of 2.4 Unless otherwise a special operating condition is specified in the follows during the testing.
- b. The measuring distance of at 3 m shall be used for measurements at frequency up to 1GHz. For frequencies above 1GHz, any suitable measuring distance may be used.
- c. The EUT was placed on the top of a rotating table 0.8 meters above the ground at a 3 meter shield area test site. The table was rotated 360 degrees to determine the position of the highest radiation.
- d. The height of the equipment or of the substitution antenna shall be 0.8 m; the height of the test antenna shall vary between 1 m to 4 m. Both horizontal and vertical polarizations of the antenna are set to make the measurement.
- e. For emission measurements above 1 GHz, the EUT shall be placed at a height of 1.5 m above the floor on a support that is RF transparent for the frequencies of interest. Final measurements for the EUT require a measurement antenna height scan of 1 m to 4 m.
- f. The initial step in collecting conducted emission data is a spectrum analyzer peak detector mode pre-scanning the measurement frequency range. Significant peaks are then marked and then Quasi Peak detector mode re-measured.
- g. If the Peak Mode measured value compliance with and lower than Quasi Peak Mode Limit, the EUT shall be deemed to meet QP Limits and then no additional QP Mode measurement performed.
- h. For the actual test configuration, please refer to the related Item –EUT Test photos.

Note: Both horizontal and vertical antenna polarities were tested. The worst case emissions were reported.

During the radiated emission test, the Spectrum Analyzer was set with the following configurations:

| Frequency Band (MHz) | Function | Resolution bandwidth | Video Bandwidth |
|----------------------|----------|----------------------|-----------------|
| 30 to 1000           | QP       | 120 kHz              | 300 kHz         |
| Above 1000           | Peak     | 1 MHz                | 1 MHz           |
|                      | Average  | 1 MHz                | 10 Hz           |

Note: for the frequency ranges below 30 MHz, a narrower RBW is used for these ranges but the measured value should add a RBW correction factor (RBWCF) where  $RBWCF [dB] = 10 \cdot \lg(100 [kHz]/\text{narrower RBW [kHz]})$ . , the narrower RBW is 1 kHz and RBWCF is 20 dB for the frequency 9 kHz to 150 kHz, and the narrower RBW is 10 kHz and RBWCF is 10 dB for the frequency 150 kHz to 30 MHz.

5.4.4 Test results

5.4.4.1 Radiation emission

Below 30MHz

|              |                         |                    |                     |
|--------------|-------------------------|--------------------|---------------------|
| EUT:         | GT-Sense SMA Connectors | Model Name:        | CM2-1112120         |
| Temperature: | 20 °C                   | Relative Humidity: | 48%                 |
| Pressure:    | 1010 hPa                | Test Voltage:      | DC 36V from adapter |
| Test Mode:   | Charging+TX             | Polarization :     | --                  |

| Freq. | Reading  | Limit    | Margin | State |
|-------|----------|----------|--------|-------|
| (MHz) | (dBuV/m) | (dBuV/m) | (dB)   | P/F   |
| --    | --       | --       | --     | Pass  |
| --    | --       | --       | --     | Pass  |

Note:

The amplitude of spurious emissions which are attenuated by more than 20dB below the permissible value has no need to be reported.

Distance extrapolation factor =  $40 \log (\text{specific distance}/\text{test distance})$ (dB);

Limit line = specific limits(dBuV) + distance extrapolation factor.

Between 30MHz – 1GHz:

Note: The high, medium and low channels have been tested. The report only shows the worst mode. The worst mode is CH39.

|                    |                         |                |                     |
|--------------------|-------------------------|----------------|---------------------|
| EUT :              | GT-Sense SMA Connectors | Model Name :   | CM2-1112120         |
| Relative Humidity: | 52%                     | Phase:         | H                   |
| Pressure:          | 1010 hPa                | Test Voltage : | DC 36V from adapter |
| Test Mode :        | Charging+TX             |                |                     |

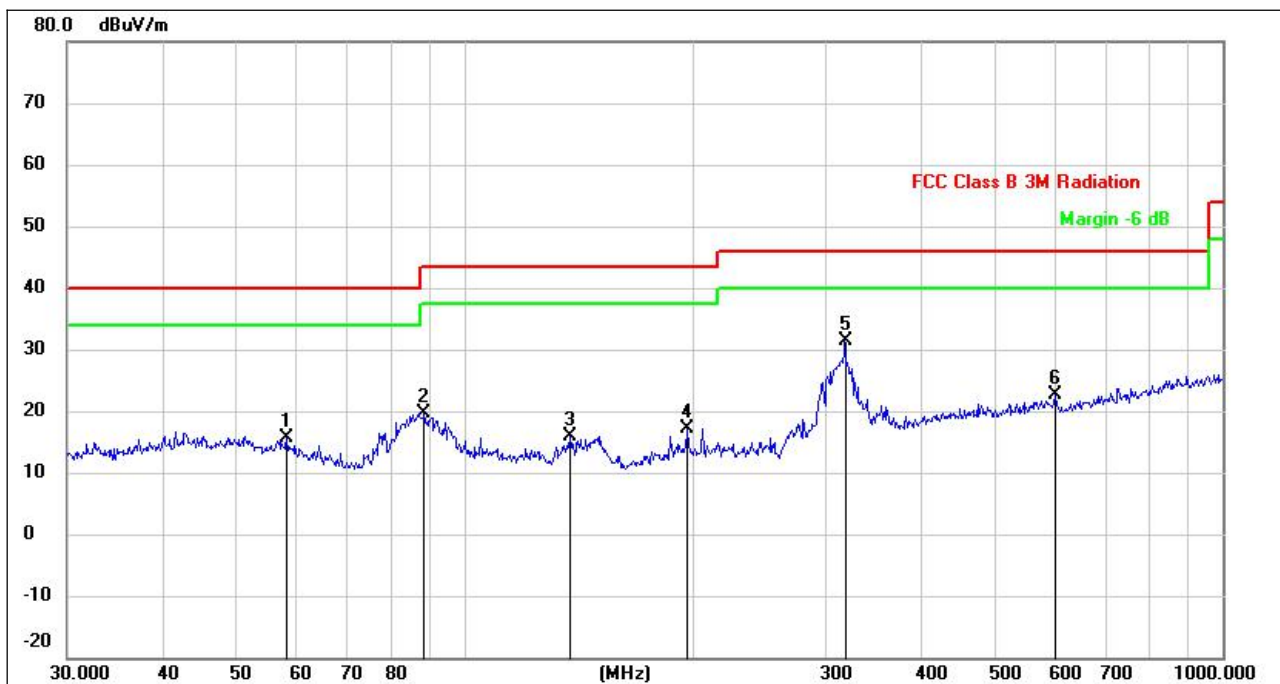

| No. | Mk. | Freq.    | Reading Level | Correct Factor | Measurement | Limit  | Over   | Detector |
|-----|-----|----------|---------------|----------------|-------------|--------|--------|----------|
|     |     | MHz      | dBuV          | dBuV/m         | dBuV/m      | dBuV/m | dB     |          |
| 1   |     | 58.4074  | 26.48         | -10.94         | 15.54       | 40.00  | -24.46 | QP       |
| 2   |     | 88.6524  | 33.12         | -13.44         | 19.68       | 43.50  | -23.82 | QP       |
| 3   |     | 137.9028 | 30.83         | -14.83         | 16.00       | 43.50  | -27.50 | QP       |
| 4   |     | 197.2001 | 29.24         | -12.16         | 17.08       | 43.50  | -26.42 | QP       |
| 5   | *   | 317.7011 | 39.68         | -8.25          | 31.43       | 46.00  | -14.57 | QP       |
| 6   |     | 601.4265 | 27.84         | -5.33          | 22.51       | 46.00  | -23.49 | QP       |



|                    |                         |                |                     |
|--------------------|-------------------------|----------------|---------------------|
| EUT :              | GT-Sense SMA Connectors | Model Name :   | CM2-1112120         |
| Relative Humidity: | 52%                     | Phase:         | V                   |
| Pressure:          | 1010 hPa                | Test Voltage : | DC 36V from adapter |
| Test Mode :        | Charging+TX             |                |                     |

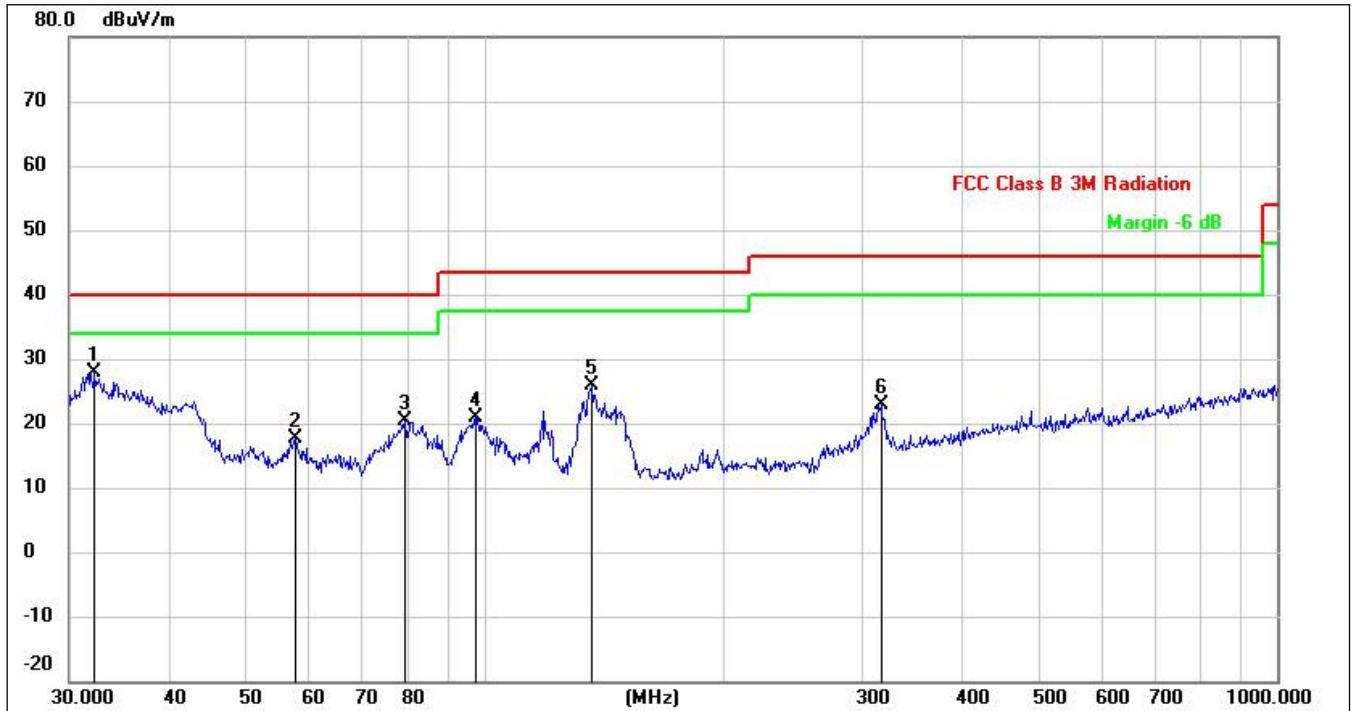

| No. | Mk. | Freq.<br>MHz | Reading<br>Level<br>dBuV | Correct<br>Factor<br>dBuV/m | Measurement<br>dBuV/m | Limit<br>dBuV/m | Over<br>dB | Detector |
|-----|-----|--------------|--------------------------|-----------------------------|-----------------------|-----------------|------------|----------|
| 1   | *   | 32.2925      | 39.25                    | -11.42                      | 27.83                 | 40.00           | -12.17     | QP       |
| 2   |     | 57.7962      | 28.48                    | -10.84                      | 17.64                 | 40.00           | -22.36     | QP       |
| 3   |     | 79.5209      | 34.74                    | -14.42                      | 20.32                 | 40.00           | -19.68     | QP       |
| 4   |     | 97.7983      | 32.58                    | -11.80                      | 20.78                 | 43.50           | -22.72     | QP       |
| 5   |     | 136.9391     | 39.56                    | -13.78                      | 25.78                 | 43.50           | -17.72     | QP       |
| 6   |     | 316.5890     | 31.07                    | -8.28                       | 22.79                 | 46.00           | -23.21     | QP       |

**1G-25GHz**

- Note: (1) All Readings are Peak Value (VBW=3MHz) and AV Value (VBW=10Hz).  
 (2) Emission Level= Antenna Factor + Cable Loss + Read Level - Preamp Factor  
 (3) All other emissions more than 20dB below the limit.

All the modulation modes have been tested, and the worst result was report as below:

| Frequency (MHz)                   | Read Level (dBμV) | Cable loss (dB) | Antenna Factor (dB/m) | Preamp Factor (dB) | Emission Level (dBμV/m) | Limits (dBμV/m) | Margin (dB) | Remark | Comment    |
|-----------------------------------|-------------------|-----------------|-----------------------|--------------------|-------------------------|-----------------|-------------|--------|------------|
| Low Channel (2402 MHz)-Above 1G   |                   |                 |                       |                    |                         |                 |             |        |            |
| 4804.34                           | 62.63             | 5.21            | 35.59                 | 44.30              | 59.13                   | 74.00           | -14.87      | Pk     | Vertical   |
| 4804.34                           | 41.54             | 5.21            | 35.59                 | 44.30              | 38.04                   | 54.00           | -15.96      | AV     | Vertical   |
| 7206.11                           | 61.89             | 6.48            | 36.27                 | 44.60              | 60.04                   | 74.00           | -13.96      | Pk     | Vertical   |
| 7206.11                           | 42.17             | 6.48            | 36.27                 | 44.60              | 40.32                   | 54.00           | -13.68      | AV     | Vertical   |
| 4804.17                           | 63.72             | 5.21            | 35.55                 | 44.30              | 60.18                   | 74.00           | -13.82      | Pk     | Horizontal |
| 4804.17                           | 42.57             | 5.21            | 35.55                 | 44.30              | 39.03                   | 54.00           | -14.97      | AV     | Horizontal |
| 7206.21                           | 60.99             | 6.48            | 36.27                 | 44.52              | 59.22                   | 74.00           | -14.78      | Pk     | Horizontal |
| 7206.21                           | 41.75             | 6.48            | 36.27                 | 44.52              | 39.98                   | 54.00           | -14.02      | AV     | Horizontal |
| Mid Channel (2440 MHz)-Above 1G   |                   |                 |                       |                    |                         |                 |             |        |            |
| 4880.47                           | 63.61             | 5.21            | 35.66                 | 44.20              | 60.28                   | 74.00           | -13.72      | Pk     | Vertical   |
| 4880.47                           | 44.36             | 5.21            | 35.66                 | 44.20              | 41.03                   | 54.00           | -12.97      | AV     | Vertical   |
| 7320.27                           | 65.18             | 7.10            | 36.50                 | 44.43              | 64.35                   | 74.00           | -9.65       | Pk     | Vertical   |
| 7320.27                           | 40.84             | 7.10            | 36.50                 | 44.43              | 40.01                   | 54.00           | -13.99      | AV     | Vertical   |
| 4880.37                           | 63.19             | 5.21            | 35.66                 | 44.20              | 59.86                   | 74.00           | -14.14      | Pk     | Horizontal |
| 4880.37                           | 41.48             | 5.21            | 35.66                 | 44.20              | 38.15                   | 54.00           | -15.85      | AV     | Horizontal |
| 7320.23                           | 59.44             | 7.10            | 36.50                 | 44.43              | 58.61                   | 74.00           | -15.39      | Pk     | Horizontal |
| 7320.23                           | 44.47             | 7.10            | 36.50                 | 44.43              | 43.64                   | 54.00           | -10.36      | AV     | Horizontal |
| High Channel (2480 MHz)- Above 1G |                   |                 |                       |                    |                         |                 |             |        |            |
| 4960.48                           | 64.52             | 5.21            | 35.52                 | 44.21              | 61.04                   | 74.00           | -12.96      | Pk     | Vertical   |
| 4960.48                           | 41.32             | 5.21            | 35.52                 | 44.21              | 37.84                   | 54.00           | -16.16      | AV     | Vertical   |
| 7440.13                           | 64.62             | 7.10            | 36.53                 | 44.60              | 63.65                   | 74.00           | -10.35      | Pk     | Vertical   |
| 7440.13                           | 48.68             | 7.10            | 36.53                 | 44.60              | 47.71                   | 54.00           | -6.29       | AV     | Vertical   |
| 4960.33                           | 64.13             | 5.21            | 35.52                 | 44.21              | 60.65                   | 74.00           | -13.35      | Pk     | Horizontal |
| 4960.33                           | 45.64             | 5.21            | 35.52                 | 44.21              | 42.16                   | 54.00           | -11.84      | AV     | Horizontal |
| 7440.2                            | 63.74             | 7.10            | 36.53                 | 44.60              | 62.77                   | 74.00           | -11.23      | Pk     | Horizontal |
| 7440.2                            | 45.70             | 7.10            | 36.53                 | 44.60              | 44.73                   | 54.00           | -9.27       | AV     | Horizontal |

5.4.4.2 Bandedge-radiated

- Note: (1) All Readings are Peak Value (VBW=3MHz) and AV Value (VBW=10Hz).  
 (2) Emission Level= Antenna Factor + Cable Loss + Read Level - Preamp Factor  
 (3) All other emissions more than 20dB below the limit.

All the modulation modes have been tested, and the worst result was report as below:

| Frequency<br>(MHz) | Meter<br>Reading<br>(dBμV) | Cable<br>Loss<br>(dB) | Antenna<br>Factor<br>dB/m | Preamp<br>Factor<br>(dB) | Emission<br>Level<br>(dBμV/m) | Limits<br>(dBμV/m) | Margin<br>(dB) | Detector<br>Type | Comment    |
|--------------------|----------------------------|-----------------------|---------------------------|--------------------------|-------------------------------|--------------------|----------------|------------------|------------|
| GFSK               |                            |                       |                           |                          |                               |                    |                |                  |            |
| 2310.00            | 62.43                      | 2.97                  | 27.80                     | 43.80                    | 49.40                         | 74                 | -24.60         | Pk               | Horizontal |
| 2310.00            | 44.13                      | 2.97                  | 27.80                     | 43.80                    | 31.10                         | 54                 | -22.90         | AV               | Horizontal |
| 2310.00            | 61.75                      | 2.97                  | 27.80                     | 43.80                    | 48.72                         | 74                 | -25.28         | Pk               | Vertical   |
| 2310.00            | 42.50                      | 2.97                  | 27.80                     | 43.80                    | 29.47                         | 54                 | -24.53         | AV               | Vertical   |
| 2390.00            | 63.80                      | 3.14                  | 27.21                     | 43.80                    | 50.35                         | 74                 | -23.65         | Pk               | Vertical   |
| 2390.00            | 42.48                      | 3.14                  | 27.21                     | 43.80                    | 29.03                         | 54                 | -24.97         | AV               | Vertical   |
| 2390.00            | 63.73                      | 3.14                  | 27.21                     | 43.80                    | 50.28                         | 74                 | -23.72         | Pk               | Horizontal |
| 2390.00            | 43.21                      | 3.14                  | 27.21                     | 43.80                    | 29.76                         | 54                 | -24.24         | AV               | Horizontal |
| 2483.50            | 62.64                      | 3.58                  | 27.70                     | 44.00                    | 49.92                         | 74                 | -24.08         | Pk               | Vertical   |
| 2483.50            | 42.80                      | 3.58                  | 27.70                     | 44.00                    | 30.08                         | 54                 | -23.92         | AV               | Vertical   |
| 2483.50            | 65.25                      | 3.58                  | 27.70                     | 44.00                    | 52.53                         | 74                 | -21.47         | Pk               | Horizontal |
| 2483.50            | 44.55                      | 3.58                  | 27.70                     | 44.00                    | 31.83                         | 54                 | -22.17         | AV               | Horizontal |

5.4.4.3 Spurious Emission in Restricted Band 3260MHz-18000MHz

All the modulation modes have been tested, and the worst result was report as below:

| Frequency<br>(MHz) | Reading Level<br>(dB $\mu$ V) | Cable Loss<br>(dB) | Antenna Factor<br>(dB/m) | Preamp Factor<br>(dB) | Emission Level<br>(dB $\mu$ V/m) | Limits<br>(dB $\mu$ V/m) | Margin<br>(dB) | Detector<br>Type | Comment    |
|--------------------|-------------------------------|--------------------|--------------------------|-----------------------|----------------------------------|--------------------------|----------------|------------------|------------|
| 3260               | 63.53                         | 4.04               | 29.57                    | 44.70                 | 52.44                            | 74                       | -21.56         | Pk               | Vertical   |
| 3260               | 56.51                         | 4.04               | 29.57                    | 44.70                 | 45.42                            | 54                       | -8.58          | AV               | Vertical   |
| 3260               | 64.55                         | 4.04               | 29.57                    | 44.70                 | 53.46                            | 74                       | -20.54         | Pk               | Horizontal |
| 3260               | 57.37                         | 4.04               | 29.57                    | 44.70                 | 46.28                            | 54                       | -7.72          | AV               | Horizontal |
| 3332               | 64.17                         | 4.26               | 29.87                    | 44.40                 | 53.90                            | 74                       | -20.10         | Pk               | Vertical   |
| 3332               | 56.24                         | 4.26               | 29.87                    | 44.40                 | 45.97                            | 54                       | -8.03          | AV               | Vertical   |
| 3332               | 65.26                         | 4.26               | 29.87                    | 44.40                 | 54.99                            | 74                       | -19.01         | Pk               | Horizontal |
| 3332               | 50.31                         | 4.26               | 29.87                    | 44.40                 | 40.04                            | 54                       | -13.96         | AV               | Horizontal |
| 17797              | 43.73                         | 10.99              | 43.95                    | 43.50                 | 55.17                            | 74                       | -18.83         | Pk               | Vertical   |
| 17797              | 34.37                         | 10.99              | 43.95                    | 43.50                 | 45.81                            | 54                       | -8.19          | AV               | Vertical   |
| 17788              | 44.18                         | 11.81              | 43.69                    | 44.60                 | 55.08                            | 74                       | -18.92         | Pk               | Horizontal |
| 17788              | 34.34                         | 11.81              | 43.69                    | 44.60                 | 45.24                            | 54                       | -8.76          | AV               | Horizontal |

## 5.5 Power spectral density test

### 5.5.1 Limit

| FCC Part15 (15.247) , Subpart C |                        |                        |                       |
|---------------------------------|------------------------|------------------------|-----------------------|
| Section                         | Test Item              | Limit                  | Frequency Range (MHz) |
| 15.247                          | Power Spectral Density | 8 dBm<br>(in any 3KHz) | 2400-2483.5           |

### 5.5.2 Test procedure

1. Set analyzer center frequency to DTS channel center frequency.
2. Set the span to 1.5 times the DTS channel bandwidth.
3. Set the RBW  $\geq$  3 kHz.
4. Set the VBW  $\geq$  3 x RBW.
5. Detector = peak.
6. Sweep time = auto couple.
7. Trace mode = max hold.
8. Allow trace to fully stabilize.
9. Use the peak marker function to determine the maximum amplitude level.
10. If measured value exceeds limit, reduce RBW (no less than 3 kHz) and repeat.

### 5.5.3 Test setup



### 5.5.4 EUT operation conditions

The EUT tested system was configured as the statements of 2.1 Unless otherwise a special operating condition is specified in the follows during the testing

5.5.5 Test results

|               |                           |                     |                    |
|---------------|---------------------------|---------------------|--------------------|
| EUT :         | GT-Sense SMA Connectors   | Model Name :        | CM2-1112120        |
| Temperature : | 25 °C                     | Relative Humidity : | 60%                |
| Pressure :    | 1015 hPa                  | Test Voltage :      | DC 3.7V by battery |
| Test Mode :   | TX Mode /CH00, CH19, CH39 |                     |                    |

| Frequency | Power Density (dBm/3KHz) | Limit (dBm/3KHz) | Result |
|-----------|--------------------------|------------------|--------|
| 2402 MHz  | -14.100                  | 8                | PASS   |
| 2440 MHz  | -14.193                  | 8                | PASS   |
| 2480 MHz  | -15.190                  | 8                | PASS   |

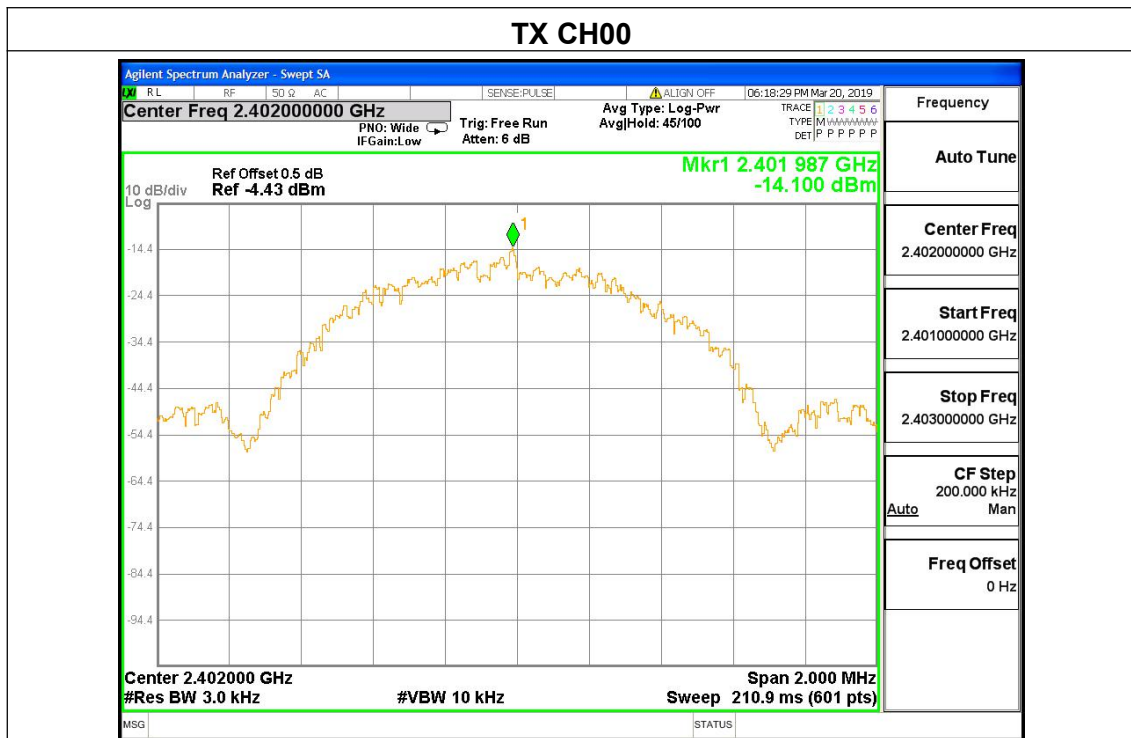

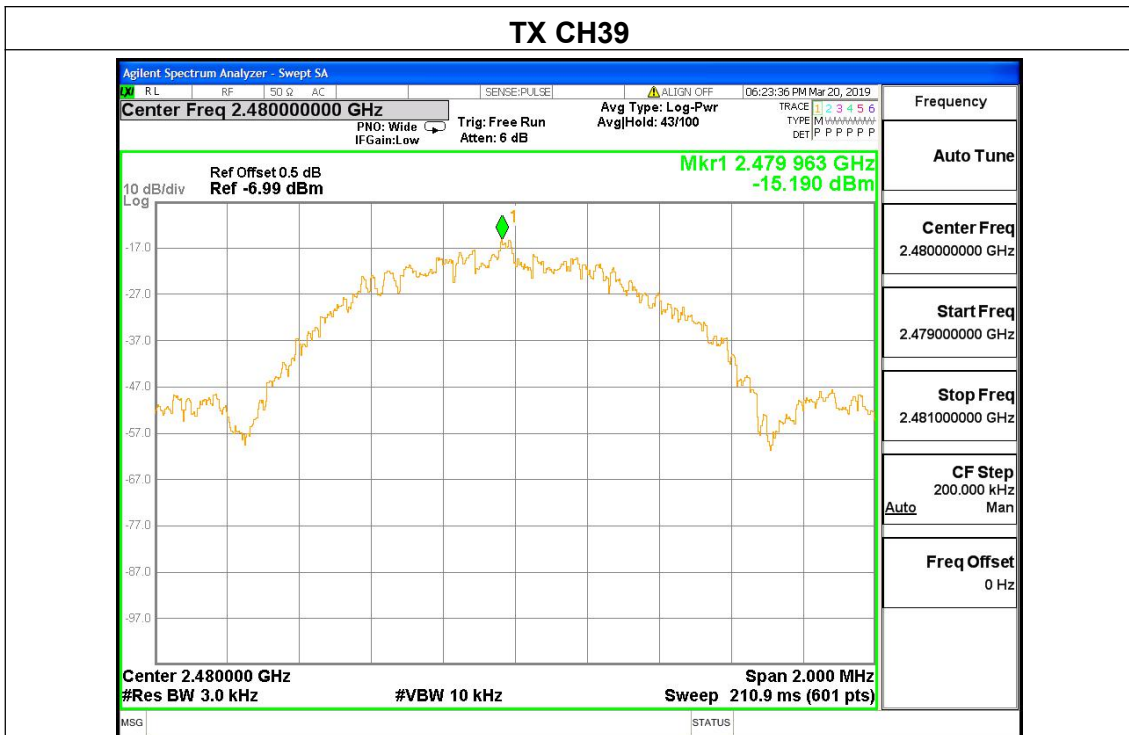
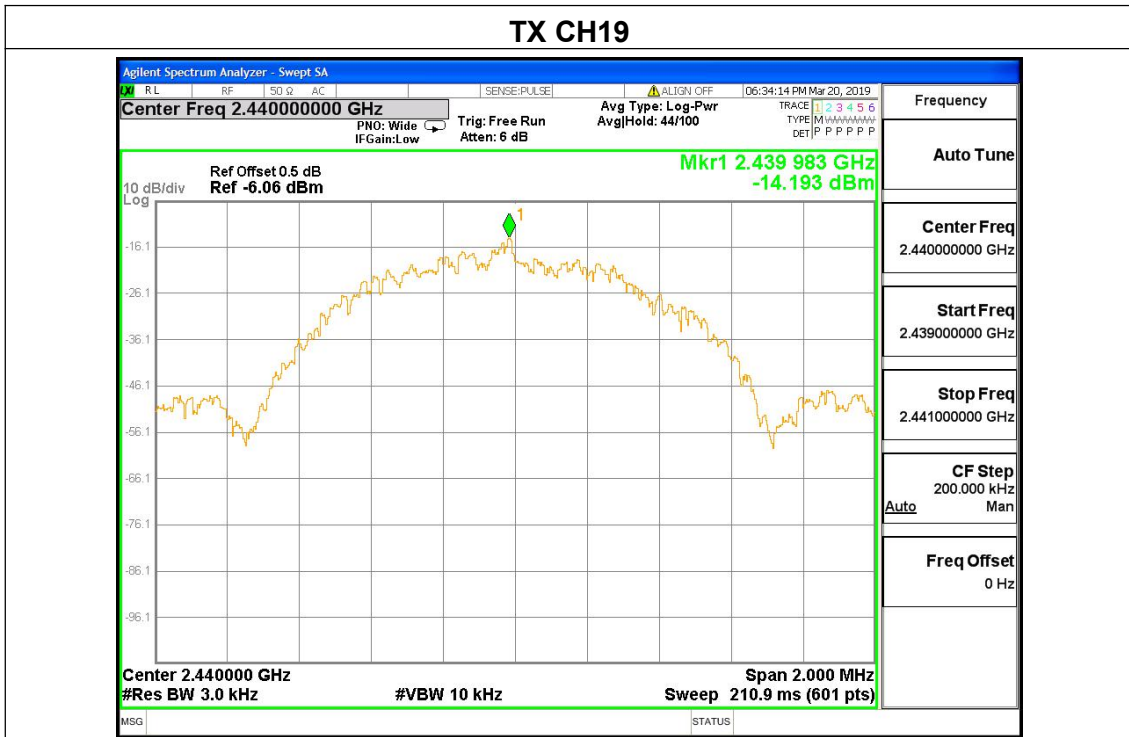

5.6 6dB bandwidth

5.6.1 Limit

| FCC Part15 (15.247) , Subpart C |           |   |                       |
|---------------------------------|-----------|---|-----------------------|
| Section                         | Test Item | Limit                                   | Frequency Range (MHz) |
| 15.247(a)(2)                    | Bandwidth | $\geq 500\text{KHz}$<br>(6dB bandwidth) | 2400-2483.5           |

5.6.2 TEST PROCEDURE

1. Set RBW= 100 kHz.
2. Set the video bandwidth (VBW)  $\geq 3 \times$  RBW.
3. Detector = Peak.
4. Trace mode = max hold.
5. Sweep = auto couple.
6. Allow the trace to stabilize.
7. Measure the maximum width of the emission that is constrained by the frequencies associated with the two outermost amplitude points (upper and lower) that are attenuated by 6 dB relative to the maximum level measured in the fundamental emission.

5.6.3 TEST SETUP



5.6.4 EUT operation conditions

The EUT tested system was configured as the statements of 2.1 Unless otherwise a special operating condition is specified in the follows during the testing

5.6.5 Test Result



|               |                           |                     |                    |
|---------------|---------------------------|---------------------|--------------------|
| EUT :         | GT-Sense SMA Connectors   | Model Name :        | CM2-1112120        |
| Temperature : | 25 °C                     | Relative Humidity : | 60%                |
| Pressure :    | 1012 hPa                  | Test Voltage :      | DC 3.7V by battery |
| Test Mode :   | TX Mode /CH00, CH19, CH39 |                     |                    |

| Channel | Frequency (MHz) | 6dB bandwidth (kHz) | Limit (kHz) | Result |
|---------|-----------------|---------------------|-------------|--------|
| Low     | 2402            | 692.1               | 500         | Pass   |
| Middle  | 2440            | 690.9               | 500         | Pass   |
| High    | 2480            | 685.5               | 500         | Pass   |

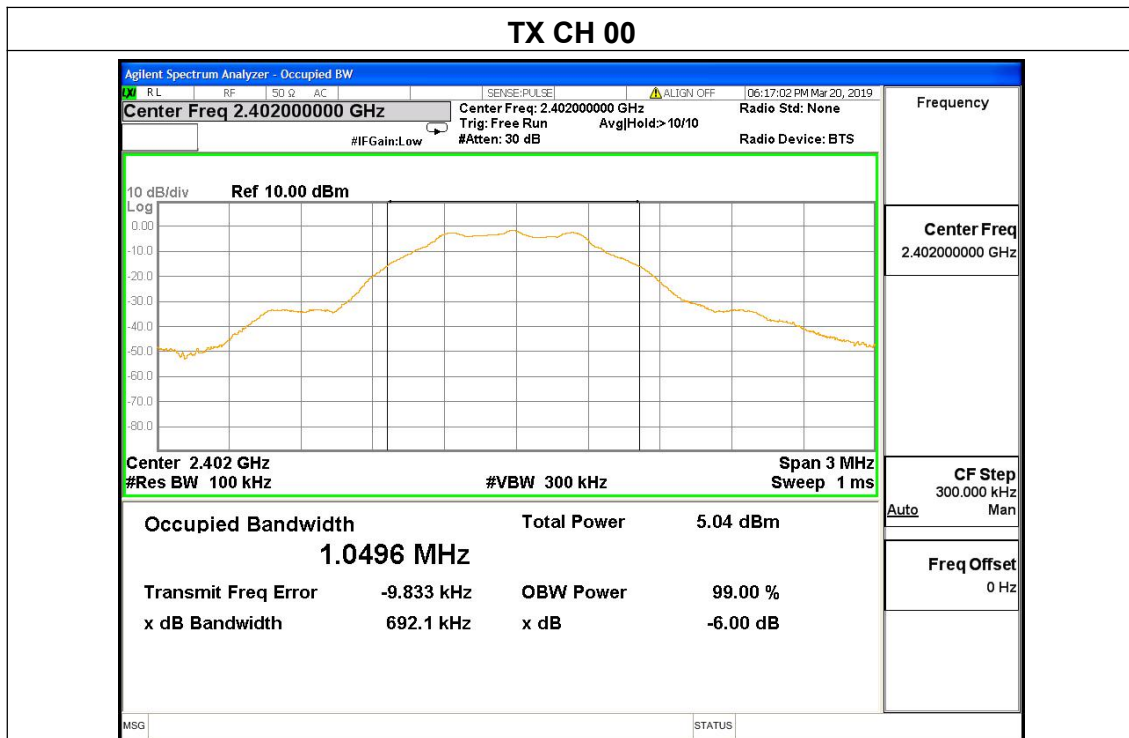



## 5.7 Conducted bandedge

### 5.7.1 Limits

In any 100 kHz bandwidth outside the frequency band in which the spread spectrum or digitally modulated intentional radiator is operating, the radio frequency power that is produced by the intentional radiator shall be at least 20 dB below that in the 100 kHz bandwidth within the band that contains the highest level of the desired power, based on either an RF conducted or a radiated measurement, provided the transmitter demonstrates compliance with the peak conducted power limits. If the transmitter complies with the conducted power limits based on the use of RMS averaging over a time interval, as permitted under paragraph (b)(3) of this section, the attenuation required under this paragraph shall be 30 dB instead of 20 dB. Attenuation below the general limits specified in §15.209(a) is not required. In addition, radiated emissions which fall in the restricted bands, as defined in §15.205(a), must also comply with the radiated emission limits specified in §15.209(a) (see §15.205(c)).

### 5.7.2 Test setup



### 5.7.3 Test procedure

- a) Check the calibration of the measuring instrument using either an internal calibrator or a known signal from an external generator.
- b) Position the EUT without connection to measurement instrument. Turn on the EUT and connect its antenna terminal to measurement instrument via a low loss cable. Then set it to any one measured frequency within its operating range, and make sure the instrument is operated in its linear range.
- c) Set RBW to 100 kHz and VBW of spectrum analyzer to 300 kHz with a convenient frequency span including 100 kHz bandwidth from band edge.
- d) Measure the highest amplitude appearing on spectral display and set it as a reference level. Plot the graph with marking the highest point and edge frequency.
- e) Repeat above procedures until all measured frequencies were complete.

### 5.7.4 EUT operation conditions

The EUT tested system was configured as the statements of 2.1 Unless otherwise a special operating condition is specified in the follows during the testing

### 5.7.5 Test Result

|               |                         |                     |                    |
|---------------|-------------------------|---------------------|--------------------|
| EUT :         | GT-Sense SMA Connectors | Model Name :        | CM2-1112120        |
| Temperature : | 25 °C                   | Relative Humidity : | 60%                |
| Pressure :    | 1012 hPa                | Test Voltage :      | DC 3.7V by battery |
| Test Mode :   | TX Mode /CH00, CH39     |                     |                    |

BLE: Band Edge, Left Side

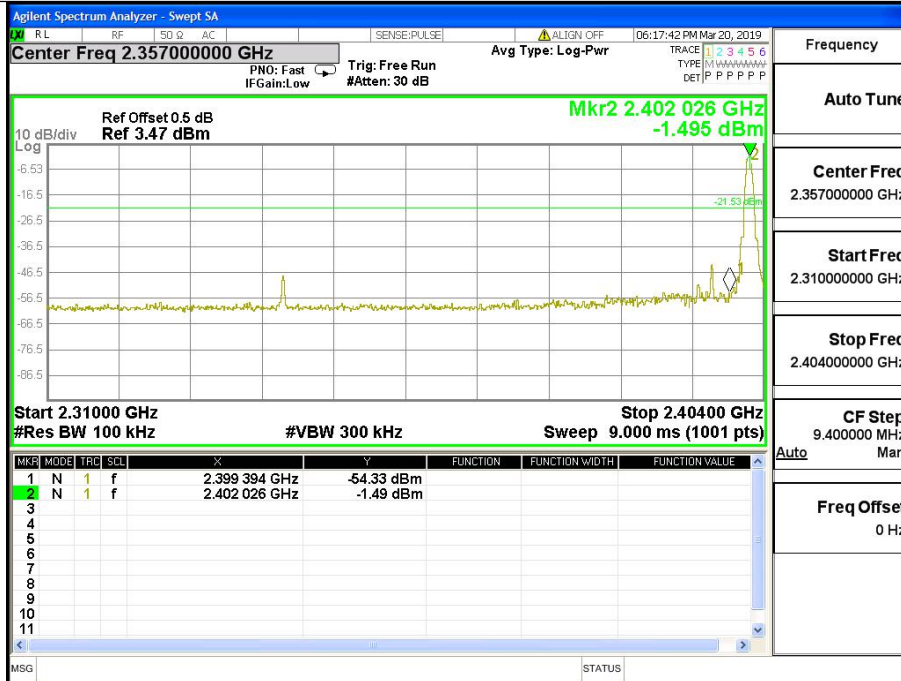

BLE: Band Edge, Right Side

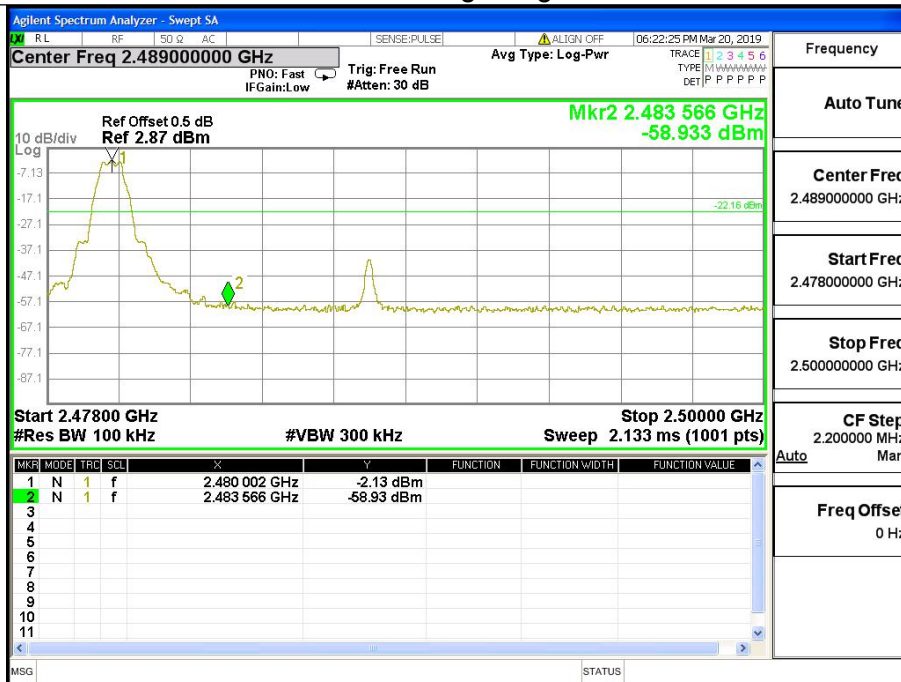

### Photographs of the Test Setup

Radiated emission

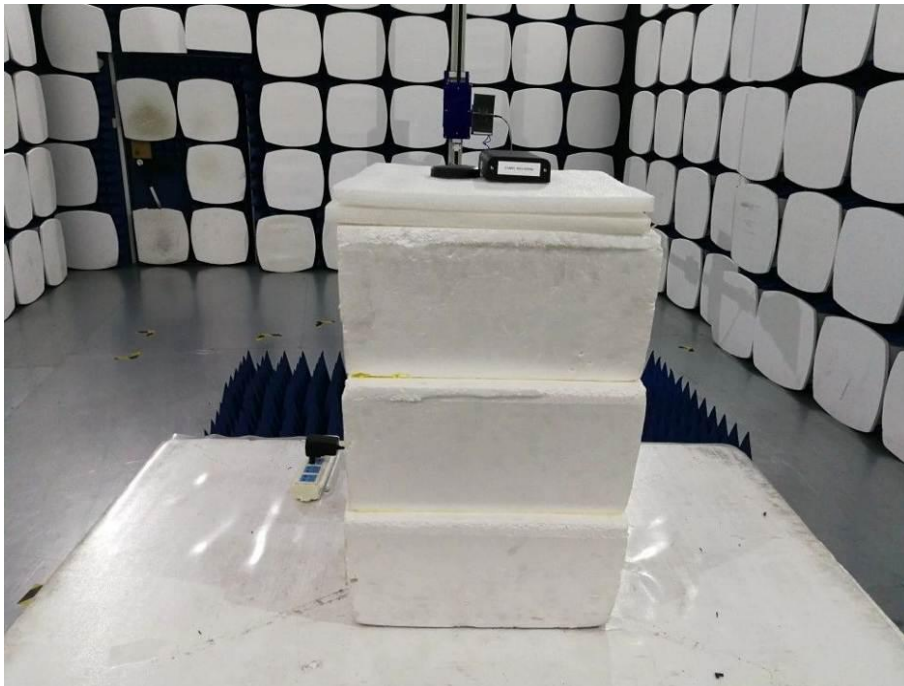

Conducted emission



## **Photographs of the EUT**

See the APPENDIX 1: EUT PHOTO in the report No.: MTi190614E097-1.

**----END OF REPORT----**