



FCC TEST REPORT

FCC ID: 2ASJ2-MC802

Product Name:	Wireless Charger
Trademark:	N/A
Model Number:	MC-802 MC-801
Prepared For :	Guangdong Foshan Micreat Intelligent Technology Co.,LTD.
Address :	No 1-13 South of East Ring Road, Beijiao Town Shunde District, Foshan 528311, China
Prepared By :	Shenzhen BCTC Testing Co., Ltd.
Address :	BCTC Building & 1-2F, East of B Building, Pengzhou Industrial, Fuyuan 1st Road, Qiaotou Community, Fuyong Street, Bao'an District, Shenzhen, China
Test Date:	Aug. 13, 2019 – Sep. 24, 2019
Date of Report :	Sep. 24, 2019
Report No.:	BCTC-FY190804943-2E



TABLE OF CONTENTS

TEST REPORT DECLARATION	3
1.GENERAL INFORMATION	4
1.1. Report information	4
1.2. Measurement Uncertainty	4
1.3. Test Facility	4
1.4. Test Uncertainty	4
2.PRODUCT DESCRIPTION	5
2.1. EUT Description	5
2.2. Test mode	5
2.3. Block Diagram of EUT Configuration	5
2.4. Test Conditions	5
2.5. Description Of Support Units (Conducted Mode)	6
3.TEST RESULTS SUMMARY	6
4.TEST EQUIPMENT USED.....	7
4.1. For Conducted Emission Test	7
4.2. For Radiated Emission Measurement	7
5.CONDUCTED EMISSION TEST.....	8
5.1. Block Diagram of Test Setup	8
5.2. Test Standard	8
5.3. Conducted Emission Limit	8
5.4. EUT Configuration on Test	8
5.5. Operating Condition of EUT	9
5.6. Test Procedure	9
5.7. Test Result	9
6.RADIATED EMISSION MEASUREMENT	12
6.1. Block Diagram of Test Setup	12
6.2. Test Standard and Limit	13
6.3. EMI Test Receiver Setup	14
6.4. Test Procedure	14
6.5. Test Result	14
7.BANDWIDTH TEST	18
8.EUT TEST PHOTOS.....	20
9.EUT PHOTOS	22



TEST REPORT DECLARATION

Applicant : Guangdong Foshan Micreat Intelligent Technology Co.,LTD.
 Address : No 1-13 South of East Ring Road, Beijiao Town Shunde District, Foshan 528311, China
 EUT Description : Wireless Charger
 Model Number : MC-802
 MC-801

Test Standards:

FCC Part 15 C

This device described above has been tested by BCTC, and the test results show that the equipment under And it is applicable only to the tested sample identified in the report.

This report shall not be reproduced except in full, without the written approval of BCTC, this document may be altered or revised by BCTC, personal only, and shall be noted in the revision of the document.

Prepared by(Engineer): Cai Fang Zhong Cai Fang Zhong

Reviewer(Supervisor): Eric Yang Eric Yang

Approved(Manager): Zero Zhou Zero Zhou





1. GENERAL INFORMATION

1.1. Report information

- 1.1.1. This report is not a certificate of quality; it only applies to the sample of the specific product/equipment given at the time of its testing. The results are not used to indicate or imply that they are application to the similar items. In addition, such results must not be used to indicate or imply that BCTC approves recommends or endorses the manufacture, supplier or use of such product/equipment, or that BCTC in any way guarantees the later performance of the product/equipment.
- 1.1.2. The sample/s mentioned in this report is/are supplied by Applicant, BCTC therefore assumes no responsibility for the accuracy of information on the brand name, model number, origin of manufacture or any information supplied.
- 1.1.3. Additional copies of the report are available to the Applicant at an additional fee. No third part can obtain a copy of this report through BCTC, unless the applicant has authorized BCTC in writing to do so.

1.2. Measurement Uncertainty

Available upon request.

1.3. Test Facility

Site Description
Name of Firm : Shenzhen BCTC Testing Co., Ltd.

Site Location : BCTC Building & 1-2F, East of B Building,
Pengzhou Industrial, Fuyuan 1st Road, Qiaotou
Community, Fuyong Street, Bao'an District,
Shenzhen, China

1.4. Test Uncertainty

Conducted Emission = $\pm 2.66\text{dB}$
Uncertainty
Radiated Emission Uncertainty = $\pm 4.15\text{dB}$



2. PRODUCT DESCRIPTION

2.1.EUT Description

Description : Wireless Charger

Applicant : **Guangdong Foshan Micreat Intelligent Technology Co.,LTD.**
No 1-13 South of East Ring Road, Beijiao Town Shunde District, Foshan 528311, China

Manufacturer : **Guangdong Foshan Micreat Intelligent Technology Co.,LTD.**
No 1-13 South of East Ring Road, Beijiao Town Shunde District, Foshan 528311, China

Model Number : MC-802

Serial Model : MC-801

Model Difference : All the model are the same circuit and RF module, except model names.

Power Supply : Input: DC 12V/1.5A,
Output: DC 5V/2A, DC9V/1.2A, DC12V/1.5A

Adapter : Model:FC67U
Input: AC 100-240V 50/60Hz 0.8A MAX
Output: DC 5V/3A, DC9V/2.66A, DC12V/2A

Work Frequency : 110-205KHz

2.2.Test mode

Test Modes	keeping TX+Charging mode
------------	--------------------------

2.3.Block Diagram of EUT Configuration

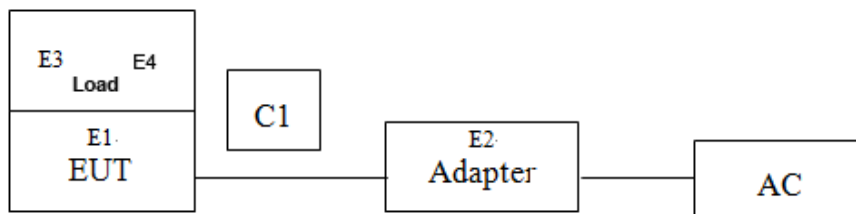

2.4.Test Conditions

Temperature: 23~26°C

Relative Humidity: 54~63 %



2.5. Description Of Support Units (Conducted Mode)

The EUT has been tested as an independent unit together with other necessary accessories or support units. The following support units or accessories were used to form a representative test configuration during the tests.

Item	Equipment	Mfr/Brand	Model/Type No.	Series No.	Note
E1	Wireless Charger	N/A	MC-802	N/A	EUT
E2	Adapter	N/A	FC67U	N/A	Auxiliary
E3	Dummyload	N/A	DL01	N/A	Auxiliary
E4	Mobile phone	N/A	iphone8	N/A	Auxiliary

Item	Shielded Type	Ferrite Core	Length	Note
C1	NO	NO	1M	USB cable unshielded

Note:

- (1) The support equipment was authorized by Declaration of Confirmation.
- (2) For detachable type I/O cable should be specified the length in cm in 『Length』 column.
- (3) “YES” is means “shielded” “with core”; “NO” is means “unshielded” “without core”.

3. TEST RESULTS SUMMARY

Table 1 Test Results Summary

Test Items	Test Results
Conducted disturbance	Pass
Radiated disturbance	Pass

Remark: “N/A” means “Not applicable.”



4. TEST EQUIPMENT USED

4.1. For Conducted Emission Test

Item	Equipment	Manufacturer	Type No.	Serial No.	Last calibration	Calibrated until
1	Test Receiver	R&S	ESR3	102075	Jun. 13, 2019	Jun. 12, 2020
2	LISN	SCHWARZBECK	NSLK8127	8127739	Jun. 13, 2019	Jun. 12, 2020
3	LISN	R&S	ENV216	101375	Jun. 13, 2019	Jun. 12, 2020
4	RF cables	Huber+Suhnar	9kHz-30MHz	B1702988-0008	Jun. 25, 2019	Jun. 24, 2020
5	Software	Frad	EZ-EMC	EMC-CON 3A1	\	\

4.2. For Radiated Emission Measurement

Item	Equipment	Manufacturer	Type No.	Serial No.	Last calibration	Calibrated until
1	Spectrum Analyzer (9kHz-26.5GHz)	Agilent	E4407B	MY45109572	Jun. 13, 2019	Jun. 12, 2020
2	Test Receiver (9kHz-7GHz)	R&S	ESR7	101154	Jun. 13, 2019	Jun. 12, 2020
3	Bilog Antenna (30MHz-3GHz)	SCHWARZBECK	VULB9163	VULB9163-942	Jun. 22, 2019	Jun. 21, 2020
4	Horn Antenna (1GHz-18GHz)	SCHWARZBECK	BBHA9120D	1541	Jun. 22, 2019	Jun. 21, 2020
5	Horn Antenna (18GHz-40GHz)	SCHWARZBECK	BBHA9170	822	Jun. 22, 2019	Jun. 21, 2020
6	Amplifier (9kHz-6GHz)	SCHWARZBECK	BBV9744	9744-0037	Jun. 25, 2019	Jun. 24, 2020
7	Amplifier (0.5GHz-18GHz)	SCHWARZBECK	BBV9718	9718-309	Jun. 25, 2019	Jun. 24, 2020
8	Amplifier (18GHz-40GHz)	MITEQ	TTA1840-35-HG	2034381	Jun. 17, 2019	Jun. 16, 2020
9	Loop Antenna (9kHz-30MHz)	SCHWARZBECK	FMZB1519B	014	Jul. 02, 2019	Jul. 01, 2020
10	RF cables1 (9kHz-30MHz)	Huber+Suhnar	9kHz-30MHz	B1702988-0008	Jun. 25, 2019	Jun. 24, 2020
11	RF cables2 (30MHz-1GHz)	Huber+Suhnar	30MHz-1GHz	1486150	Jun. 25, 2019	Jun. 24, 2020
12	RF cables3 (1GHz-40GHz)	Huber+Suhnar	1GHz-40GHz	1607106	Jun. 25, 2019	Jun. 24, 2020
13	Power Metter	Keysight	E4419	\	Jun. 17, 2019	Jun. 16, 2020
14	Power Sensor (AV)	Keysight	E9 300A	\	Jun. 17, 2019	Jun. 16, 2020
15	Signal Analyzer 20kHz-26.5GHz	KEYSIGHT	N9020A	MY49100060	Jun. 13, 2019	Jun. 12, 2020
16	Test Receiver 9kHz-40GHz	R&S	FSP40	100363	Jun. 13, 2019	Jun. 12, 2020
17	D.C. Power Supply	LongWei	TPR-6405D	\	\	\
18	Software	Frad	EZ-EMC	FA-03A2 RE	\	\

5. CONDUCTED EMISSION TEST

5.1. Block Diagram of Test Setup

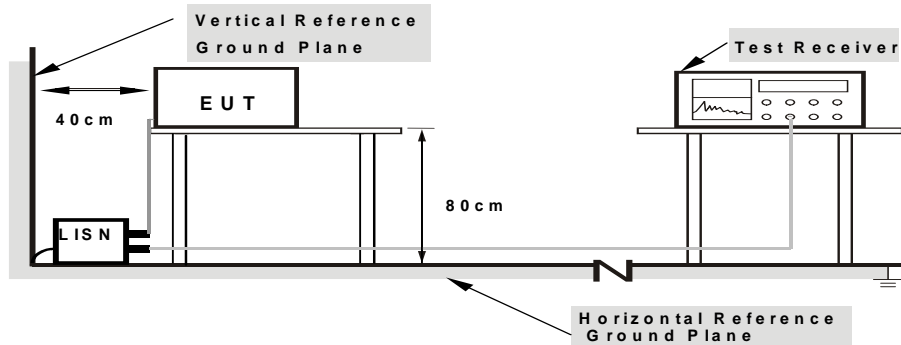

Note: 1. Support units were connected to second LISN.
2. Both of LISNs (AMN) are 80 cm from EUT and at least 80 cm from other units and other metal planes

The setup of EUT is according with per ANSI C63.10-2013 measurement procedure. The specification used was with the FCC Part 15.207 limits.

5.2. Test Standard

FCC§15.207

5.3. Conducted Emission Limit

Frequency MHz	Limits dB(μV)	
	Quasi-peak Level	Average Level
0.15 ~ 0.50	66 ~ 56*	56 ~ 46*
0.50 ~ 5.00	56	46
5.00 ~ 30.00	60	50

Notes: 1. *Decreasing linearly with logarithm of frequency.

5.4. EUT Configuration on Test

The following equipments are installed on conducted emission test to meet FCC Part 15.207 requirement and operating in a manner, which tends to maximize its emission characteristics in a normal application.



5.5. Operating Condition of EUT

- 5.5.1. Setup the EUT and simulators as shown in Section 5.1.
- 5.5.2. Turn on the power of all equipments.
- 5.5.3. Let the EUT work in test modes (EUT Working) and test it.

5.6. Test Procedure

The EUT is put on a table of non-conducting material that is 80cm high. The vertical conducting wall of shielding is located 40cm to the rear of the EUT. The power line of the EUT is connected to the AC mains through a Artificial Mains Network (A.M.N.). A EMI test receiver (R&S Test Receiver ESHS30) is used to test the emissions form both sides of AC line. The bandwidth of EMI test receiver is set at 9kHz.

The bandwidth of the test receiver (R&S Test Receiver ESHS30) is set at 10KHz.

We pretest AC 120V and AC 240V, the worst voltage was AC 120V and the data recording in the report.

5.7. Test Result

PASS

Note: Tested all the mode and recorded the worst data in the report.



EUT:	Wireless Charger	Model Name :	MC-802
Temperature:	26 °C	Relative Humidity:	54%
Pressure:	101kPa	Phase :	L
Test Voltage :	DC9V	Test Mode:	Normal

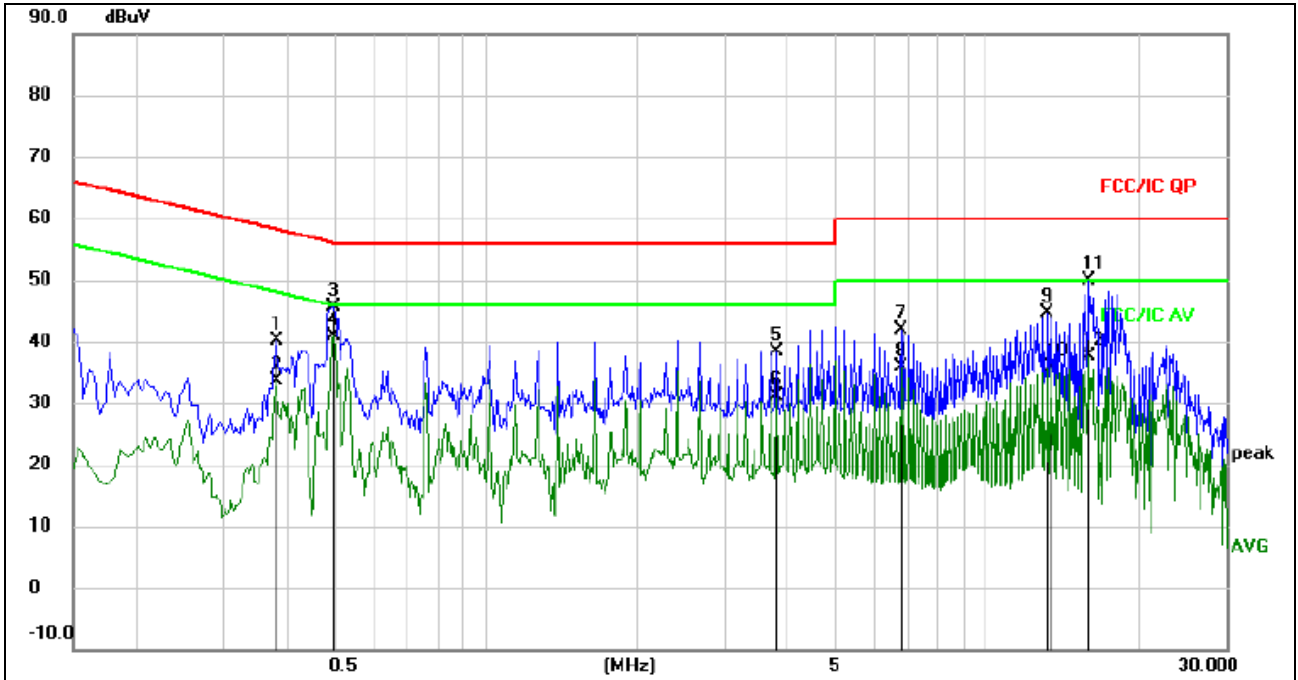

Remark:

1. All readings are Quasi-Peak and Average values.
2. Factor = Insertion Loss + Cable Loss.

No.	Mk.	Freq. MHz	Reading Level dBuV	Correct Factor	Measure- ment dBuV	Limit dBuV	Over dB	Detector	Comment
1		0.3820	30.60	9.51	40.11	58.24	-18.13	QP	
2		0.3820	24.00	9.51	33.51	48.24	-14.73	AVG	
3		0.4980	36.06	9.59	45.65	56.03	-10.38	QP	
4	*	0.4980	31.35	9.59	40.94	46.03	-5.09	AVG	
5		3.8140	28.66	9.72	38.38	56.00	-17.62	QP	
6		3.8140	21.43	9.72	31.15	46.00	-14.85	AVG	
7		6.7380	32.09	9.73	41.82	60.00	-18.18	QP	
8		6.7380	26.04	9.73	35.77	50.00	-14.23	AVG	
9		13.2220	34.99	9.70	44.69	60.00	-15.31	QP	
10		13.4740	26.10	9.70	35.80	50.00	-14.20	AVG	
11		16.0140	40.18	9.72	49.90	60.00	-10.10	QP	
12		16.0140	27.90	9.72	37.62	50.00	-12.38	AVG	



EUT:	Wireless Charger	Model Name :	MC-802
Temperature:	26 °C	Relative Humidity:	54%
Pressure:	101kPa	Phase :	N
Test Voltage :	DC 9V	Test Mode:	Normal

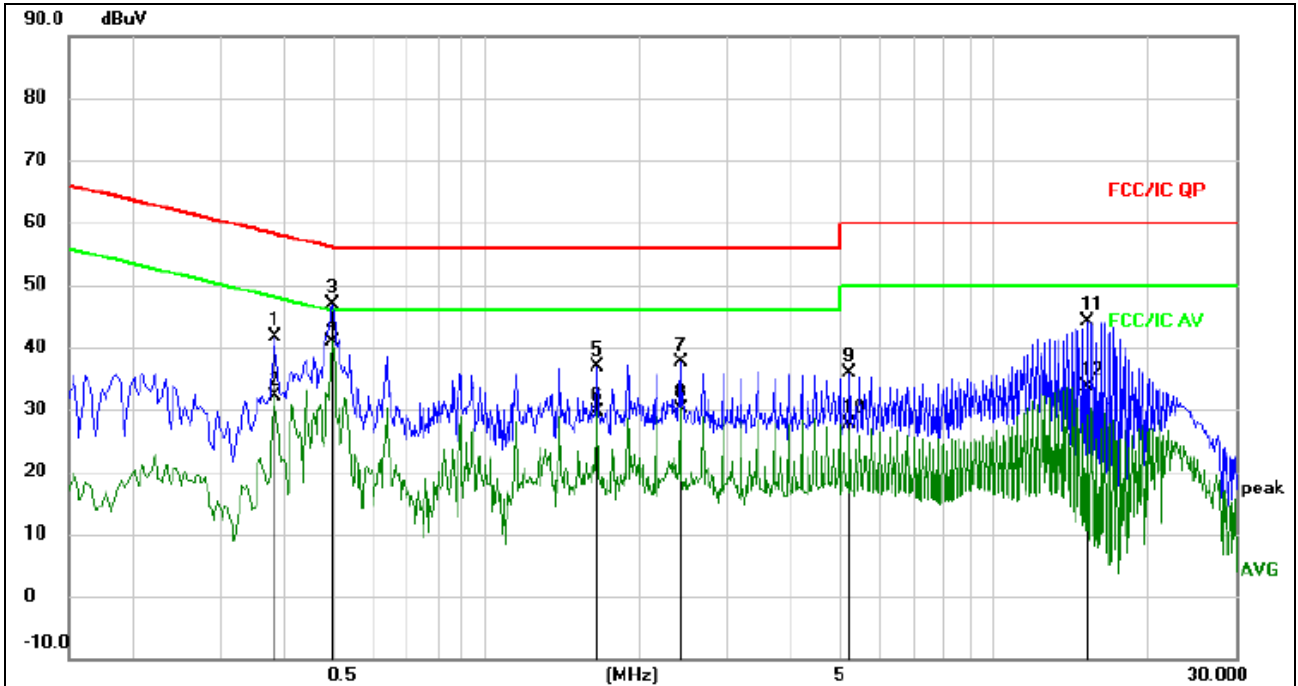

Remark:
1. All readings are Quasi-Peak and Average values.
2. Factor = Insertion Loss + Cable Loss.

No.	Mk.	Freq.	Reading Level	Correct Factor	Measurement	Limit	Over	Detector	Comment
		MHz	dBuV		dBuV	dBuV	dB		
1		0.3820	32.20	9.51	41.71	58.24	-16.53	QP	
2		0.3820	22.51	9.51	32.02	48.24	-16.22	AVG	
3		0.4980	37.27	9.59	46.86	56.03	-9.17	QP	
4	*	0.4980	31.18	9.59	40.77	46.03	-5.26	AVG	
5		1.6540	27.36	9.58	36.94	56.00	-19.06	QP	
6		1.6540	19.95	9.58	29.53	46.00	-16.47	AVG	
7		2.4140	28.01	9.62	37.63	56.00	-18.37	QP	
8		2.4140	20.41	9.62	30.03	46.00	-15.97	AVG	
9		5.2100	26.16	9.79	35.95	60.00	-24.05	QP	
10		5.2100	17.77	9.79	27.56	50.00	-22.44	AVG	
11		15.2500	34.51	9.70	44.21	60.00	-15.79	QP	
12		15.2500	23.83	9.70	33.53	50.00	-16.47	AVG	

6. RADIATED EMISSION MEASUREMENT

6.1. Block Diagram of Test Setup

6.1.1. Block Diagram of connection between the EUT and the simulators

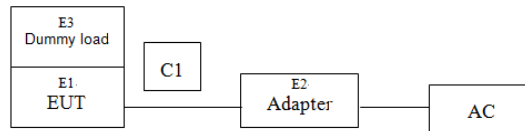

6.1.2. Anechoic Chamber Test Setup Diagram

(A) Radiated Emission Test-Up Frequency Below 30MHz

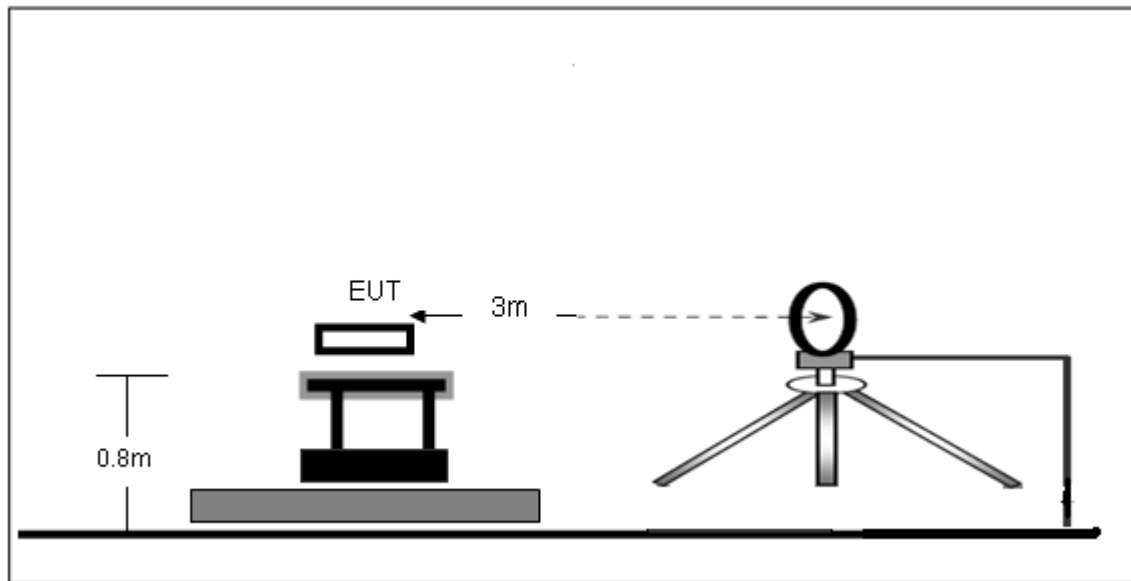

(B) Radiated Emission Test-Up Frequency 30MHz~1GHz

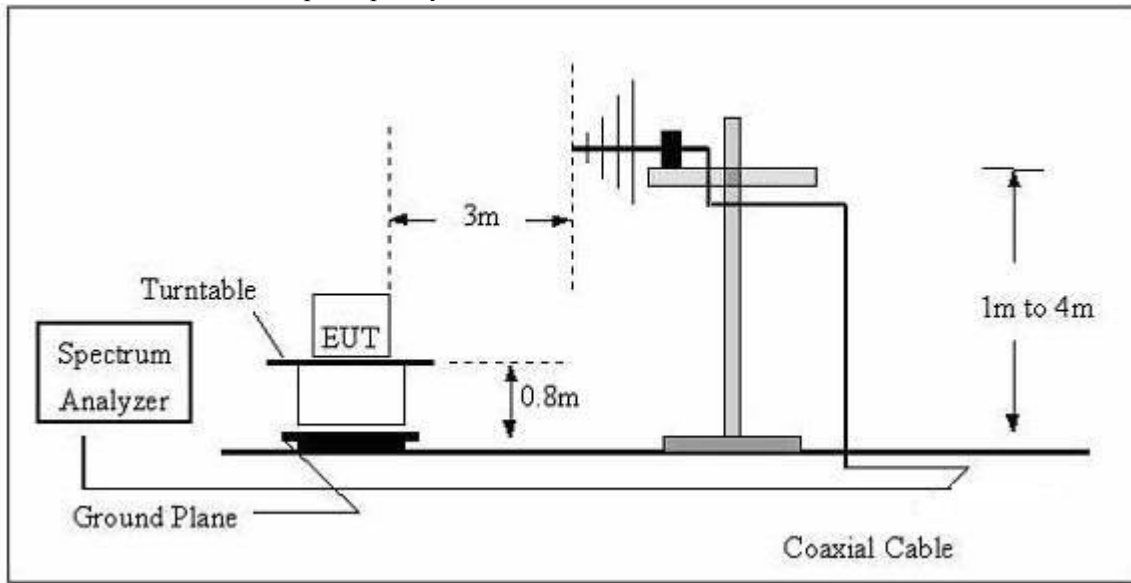

The radiated emission tests were performed in the 3 meters chamber test site, using the setup accordance with the ANSI C63.10-2013. The specification used was the FCC 15.209 and FCC 15.205 limits.

6.2. Test Standard and Limit

FCC §15.209; §15.205

Test Standard	FCC Part15 C Section 15.209 and 15.205				
	Frequency (MHz)	Field strength (microvolt/meter)	Limit (dBuV/m)	Remark	Measurement distance (m)
Test Limit	0.009MHz~0.490MHz	2400/F(kHz)	-	-	300
	0.490MHz-1.705MHz	24000/F(kHz)	-	-	30
	1.705MHz-30MHz	30	-	-	30
	30MHz~88MHz	100	40.0	Quasi-peak	3
	88MHz~216MHz	150	43.5	Quasi-peak	3
	216MHz~960MHz	200	46.0	Quasi-peak	3
	960MHz~1000MHz	500	54.0	Quasi-peak	3
	Above 1000MHz	500	54.0	Average	3
		-	74.0	Peak	3



6.3.EMI Test Receiver Setup

The system was investigated from 9kHz to1GHz.

During the radiated emission test, the EMI test receiver setup was set with the following configurations:

Frequency Range	RBW	Video B/W	Detector
9 kHz – 150 kHz	200 kHz	1 kHz	QP
150 kHz – 30MHz	9kHz	30kHz	QP
30 MHz – 1000 MHz	120 kHz	300 kHz	QP

Note: For the frequency bands 9-90 kHz and 110-490 kHz, the test was based on average detector.

6.4.Test Procedure

The EUT is placed on a turn table which is 0.8 meter above ground. The turn table can rotate 360 degrees to determine the position of the maximum emission level. The EUT is set 3 meters away from the receiving antenna which is mounted on a antenna tower. The antenna can move up and down between 1 to 4 meters to find out the maximum emission level. Broadband antenna (calibrated by dipole antenna) are used as a receiving antenna. Both horizontal and vertical polarization of the antenna are set on measurement.

6.5.Test Result

PASS

Note: Tested all the mode and recorded the worst data in the report



9kHz-30MHz

EUT:	Wireless Charger	Model Name :	MC-802
Temperature:	26 °C	Relative Humidity:	54%
Pressure:	101kPa	Polarization :	Horizontal
Test Voltage :	DC 12V		
Test Mode :	Normal		

Frequency	Meter Reading	Factor	Emission Level	Limits	Margin	Detector Type
(kHz)	(dBμV)	(dB)	(dBμV/m)	(dBμV/m)	(dB)	
25.8000	41.23	20.15	61.38	139.37	-77.99	PK
25.8000	37.64	20.15	57.79	119.37	-61.58	AV
58.7000	51.39	20.33	71.72	132.23	-60.51	PK
58.7000	45.73	20.33	66.06	112.23	-46.17	AV
125.6000	67.34	20.55	87.89	125.62	-37.73	PK
125.6000	64.25	20.55	84.80	105.62	-20.82	AV
688.5000	34.37	20.64	55.01	70.85	-15.84	QP
968.6400	34.69	21.26	55.95	67.88	-11.93	QP
1222.3300	27.05	22.32	49.37	65.86	-16.49	QP

Note:

Pre-scan in the all of mode, the worst case in of was recorded.

Factor = antenna factor + cable loss – pre-amplifier.

Margin = Emission Level- Limit.



30MHz-1GHz

EUT:	Wireless Charger	Model Name :	MC-802
Temperature:	26 °C	Relative Humidity:	54%
Pressure:	101kPa	Polarization :	Horizontal
Test Voltage :	DC 9V		
Test Mode :	Working		

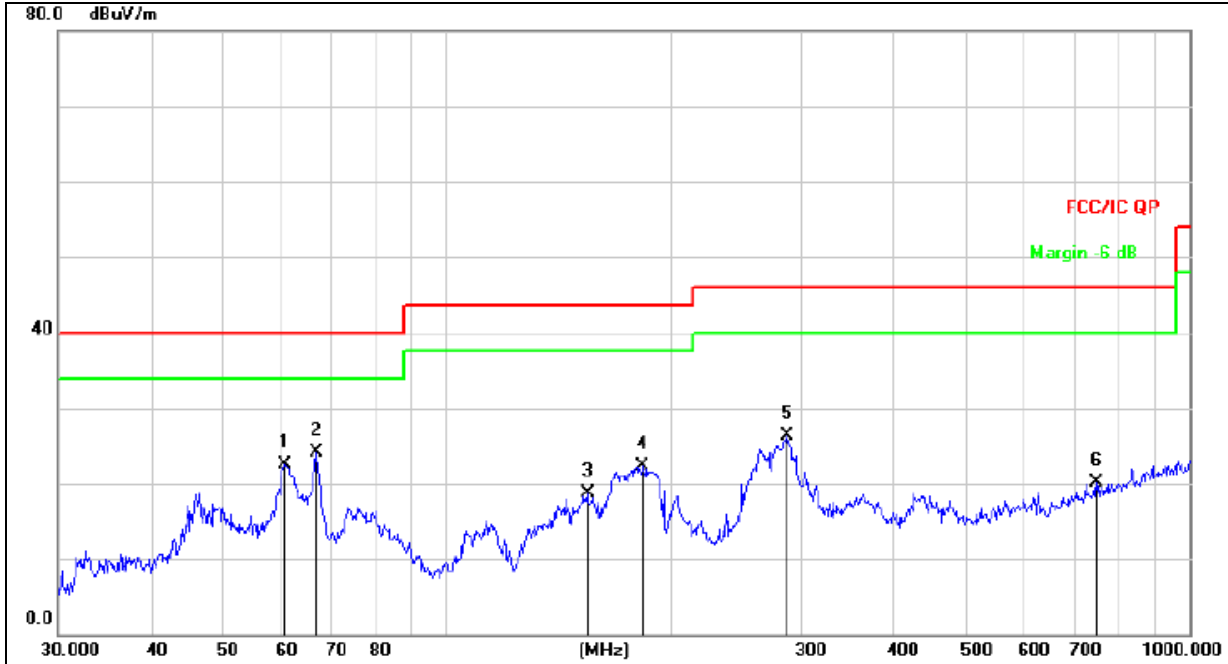

Remark:
Factor = Antenna Factor + Cable Loss – Pre-amplifier.

No.	Mk.	Freq. MHz	Reading Level dBuV	Correct Factor dB	Measure- ment dBuV/m	Limit dB/m	Over dB	Detector
1		60.7044	38.64	-16.07	22.57	40.00	-17.43	QP
2	*	66.7325	41.50	-17.45	24.05	40.00	-15.95	QP
3		154.8204	37.94	-19.19	18.75	43.50	-24.75	QP
4		183.8440	39.68	-17.33	22.35	43.50	-21.15	QP
5		287.9904	40.33	-13.97	26.36	46.00	-19.64	QP
6		750.1083	24.49	-4.34	20.15	46.00	-25.85	QP



EUT:	Wireless Charger	Model Name :	MC-802
Temperature:	26 °C	Relative Humidity:	54%
Pressure:	101kPa	Polarization :	Vertical
Test Voltage :	DC 9V		
Test Mode :	Working		

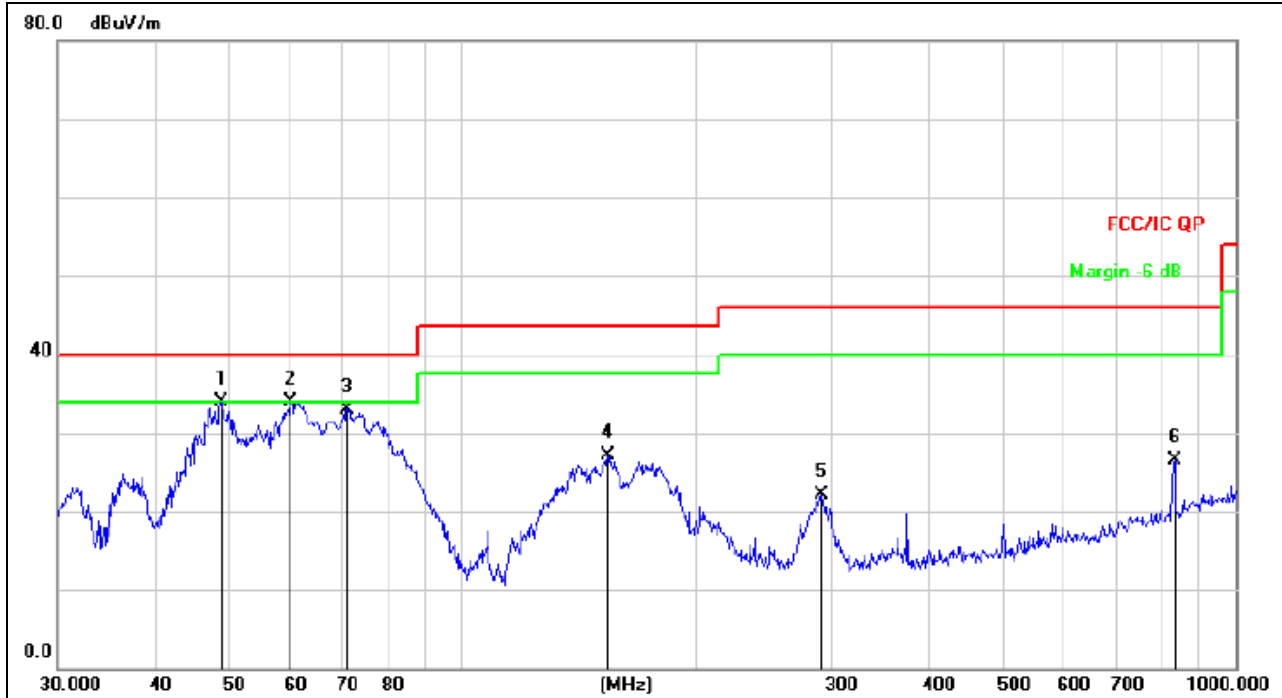

Remark:
Factor = Antenna Factor + Cable Loss – Pre-amplifier.

No.	Mk.	Freq. MHz	Reading Level dBuV	Correct Factor dB	Measure- ment dBuV/m	Limit dB/m	Over dB	Detector
1		48.8429	48.77	-14.91	33.86	40.00	-6.14	QP
2	*	60.0691	49.85	-15.93	33.92	40.00	-6.08	QP
3		71.0803	51.43	-18.43	33.00	40.00	-7.00	QP
4		154.2786	46.32	-19.23	27.09	43.50	-16.41	QP
5		291.0360	36.02	-13.88	22.14	46.00	-23.86	QP
6		833.3171	29.43	-2.89	26.54	46.00	-19.46	QP



7. BANDWIDTH TEST

1. Set RBW = 3 kHz.
2. Set the video bandwidth (VBW) $\geq 3 \times$ RBW.
3. Detector = Peak.
4. Trace mode = max hold.
5. Sweep = auto couple.
6. Allow the trace to stabilize.
7. Measure the maximum width of the emission that is constrained by the frequencies associated with the two outermost amplitude points (upper and lower frequencies) that are attenuated by 20 dB relative to the maximum level measured in the fundamental emission.

TEST SETUP





EUT:	Wireless Charger	Model Name :	MC-802
Temperature:	26 °C	Relative Humidity:	54%
Pressure:	101kPa		

Frequency (KHz)	20dB bandwidth (KHz)	99% bandwidth (KHz)	Result
128.4	15.00	13.84	Pass

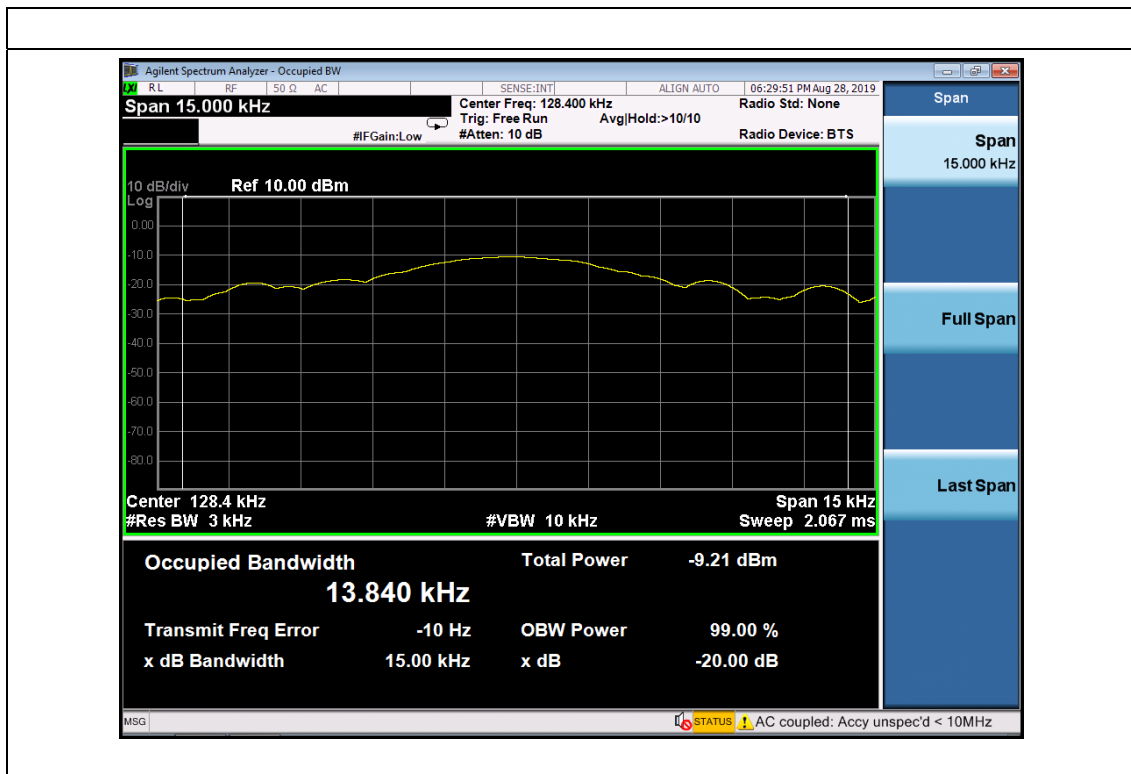



8. EUT TEST PHOTOS

Conducted Measurement Photos





Radiated Measurement Photos
9KHz-30MHz

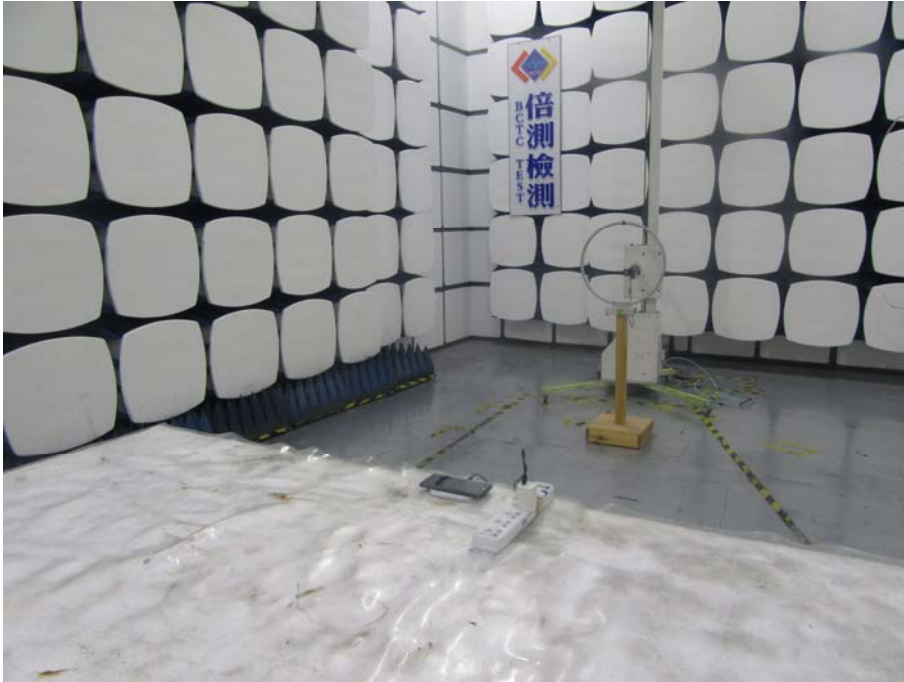

30MHz-1GHz

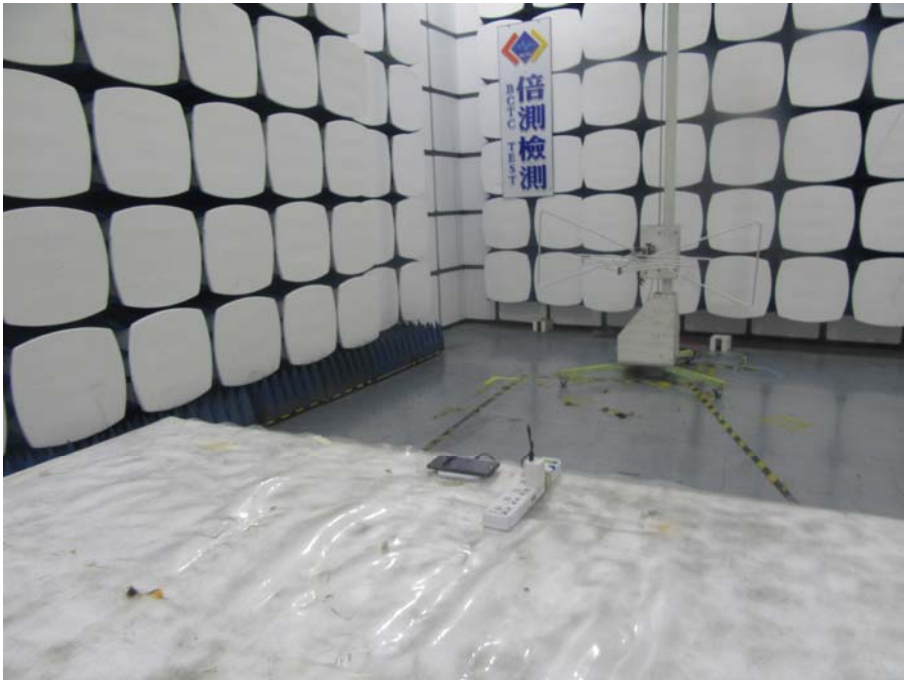

9. EUT PHOTOS





※※※※※ END OF REPORT ※※※※※