



Shen zhen Golden-Resource Electronic Co.,Ltd.

SPECIFICATION FOR APPROVAL

Date	2024/06/16
File No	24061601
Revision	1.0

CUSTOMER: SMART ELECTRONIC INDUSTRIAL CO.,LTD.

CUSTOMER NO: PGD728-V03

PART NAME: BT Antenna L=155mm MHF

SUPPLIER NO: YJ029W.300146.W01

Date:

Q"TY: PCS

CUSTOMER APPROVED BY		
APPROVAL	CHIEF	SUPERVISOR

SUPPLIER SIGNATURE		
APPROVAL	CHECK	DESIGN
ChenGuoqiang	XieLi	ChenXingcheng

YJ-RD-F04-A



Spec Item

NO	Contents	Number of Page	Page Code
1	Spec Cover	1	1
2	Spec Item	1	2
3	Drawing	1	3
4	Antenna Specification	1	4
5	S Parameter	1	5
6	Passive Test	2	6 ~ 7
7	Radiation Pattern	3	8 ~ 10
8	Antenna Profile	1	11
9	Material Certificate	34	12 ~ 45
10	RoHS Test Report	**	**
11	N/A	N/A	N/A
12	-	-	-
13	-	-	-

RoHS

Compatible

CUSTOMER	Shengshi Technology
PART NO	PGD728-V03

REV.	DESCRIPTION	DATE
△	initial issue	204-06-15

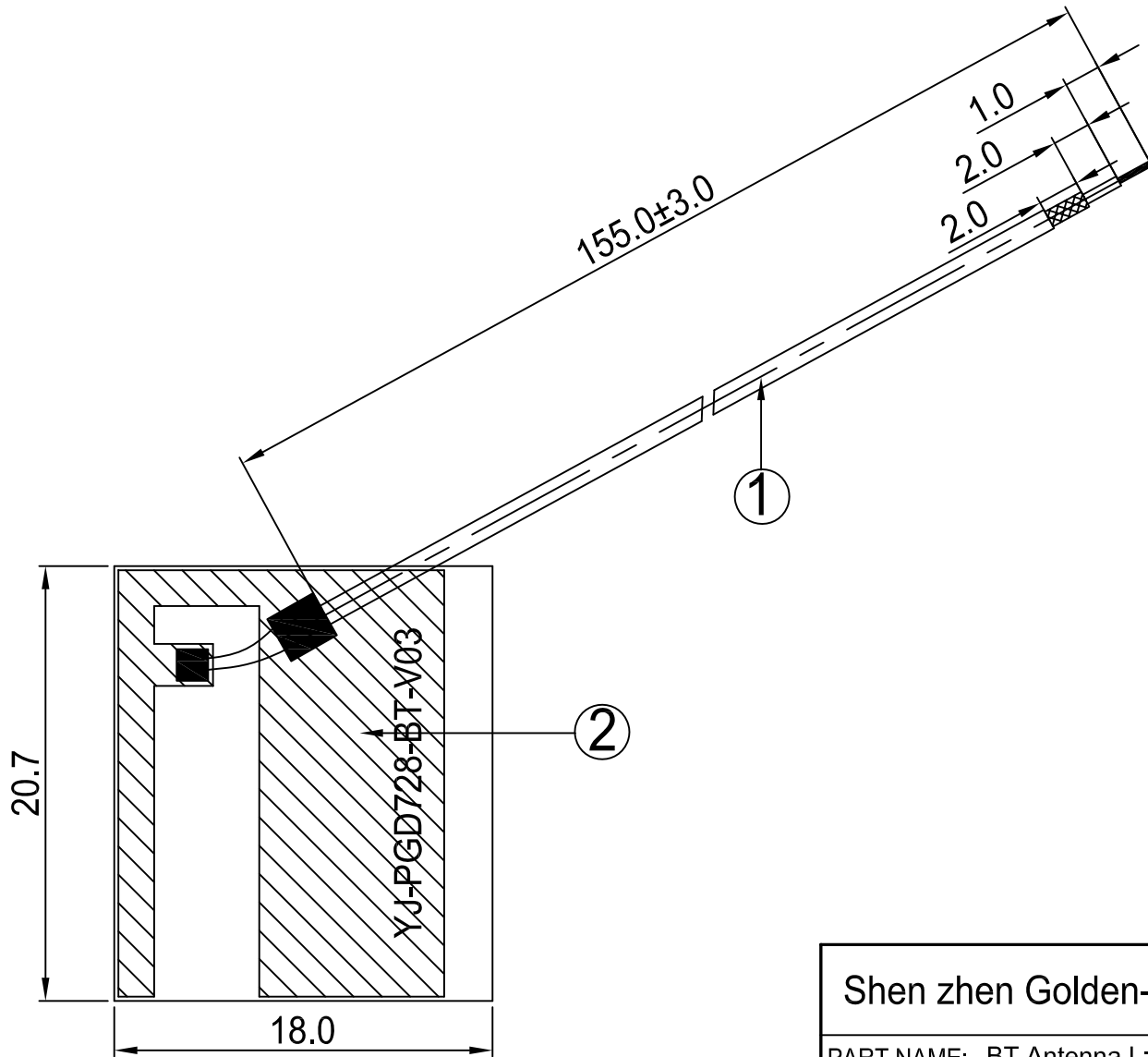

Shen zhen Golden-Resource Electronic Co.,Ltd.

PART NAME: BT Antenna L=155mm Tin

PART NO.: YJ029W.300146.W01

DATE: 204-06-15

APPROVED BY	CHECKED BY	DESIGNED BY	 UNITS: mm SCALE: 1/1 REVISION: A	Tolerance
yin tao	xie li	chen xing yi		X.X ±0.50 X.XX±0.15 X° ±3°

2	FPC	20.7*18.0mm	FPCB	FPC100XXA.P01	1
1	Coaxial Cable	O.D.1.13Gray	O.D.1.13	COA100XXA.P01	1
NO	PART NAME	DESCRIPTION	Material	Part Number	Q.TY



Antenna Specification

Electrical Properties	
Frequency	2.4-2.5GHz
Impedance	50 Ohm Nominal
V.S.W.R	2.0 Max
Gain	1.8 dBi
Radiation	Omni-directional
Polarization	Linear
Physical Properties	
Connector	None
Cable Type	O.D.1.13mm
Cable Length	155mm
Cable Color	Gray
Operating Temp.	-40 ~ +85 °C
Storage Temp / Humidity	25±5°C / <70%



Antenna Performance Test

*Agilent
E5071B*

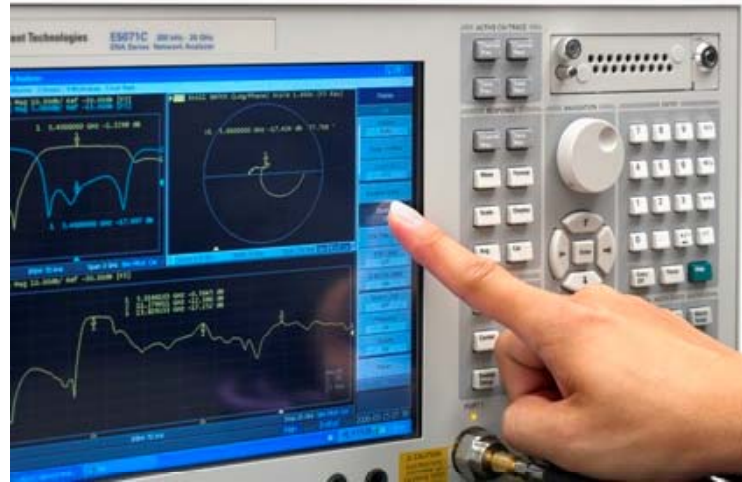

*S
Parameter
Test //
BT*

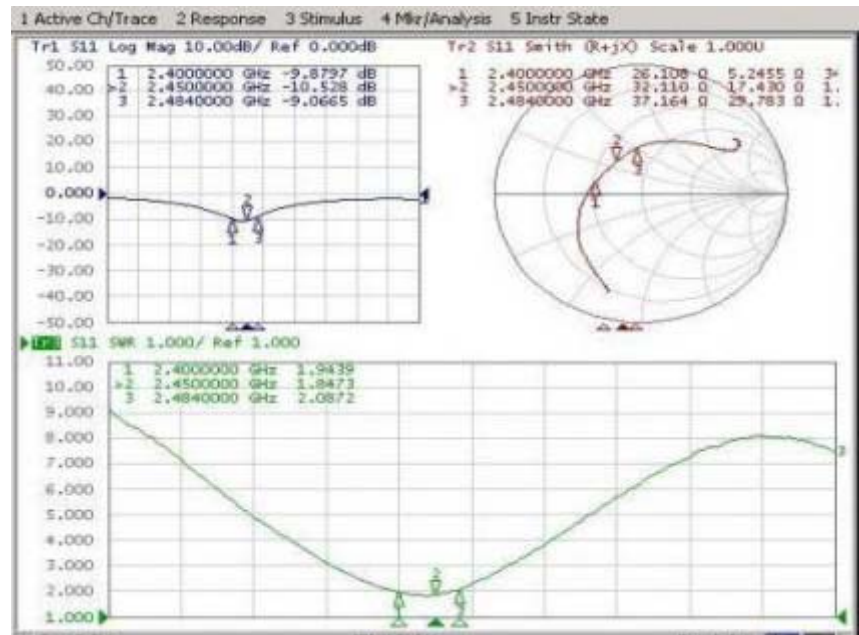



Antenna Passive Test

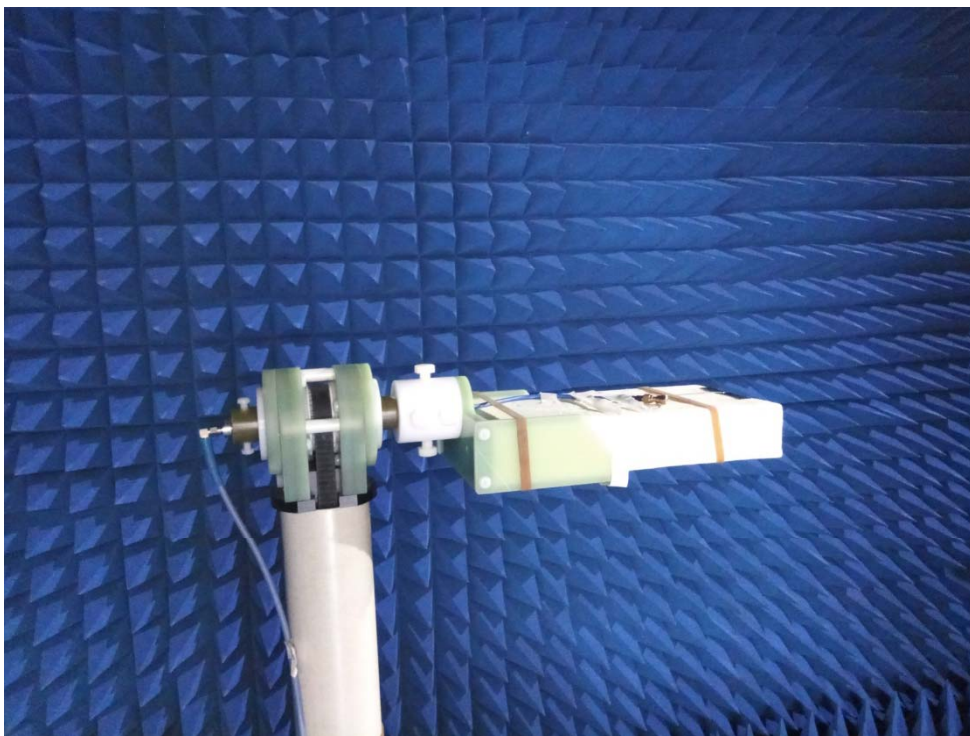
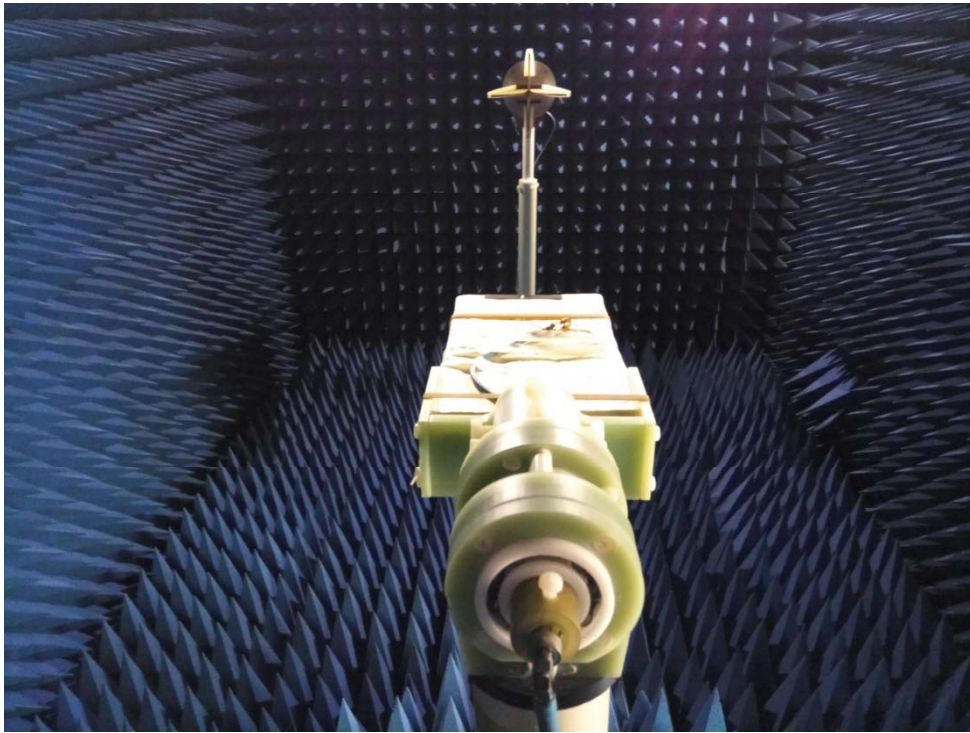



Passive Test For BT Antenna			
Freq (MHz)	Effi (%)	Effi (dB)	Gain (dBi)
2400	51.5	-2.9	1.6
2410	50.6	-3.0	1.7
2420	49.7	-3.0	1.6
2430	48.4	-3.2	1.4
2440	47.7	-3.2	1.3
2450	51.6	-2.9	1.7
2460	50.7	-3.0	1.7
2470	51.3	-2.9	1.8
2480	50.0	-3.0	1.7
2490	51.1	-2.9	1.7
2500	50.6	-3.0	1.5

add: 17A-03A, Block B, Nanxian Commercial Plaza, Meilong Road, Longhua New District, Shenzhen



Radiation Pattern For BT Antenna

2400.000MHz

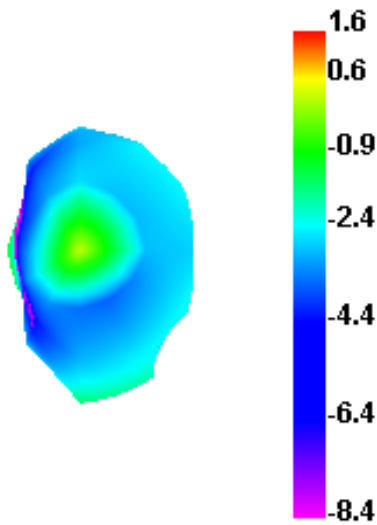

2400.000MHz H

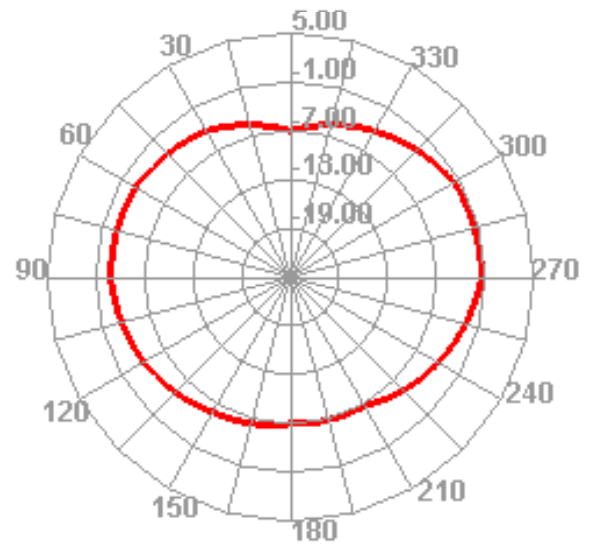

2400.000MHz E1

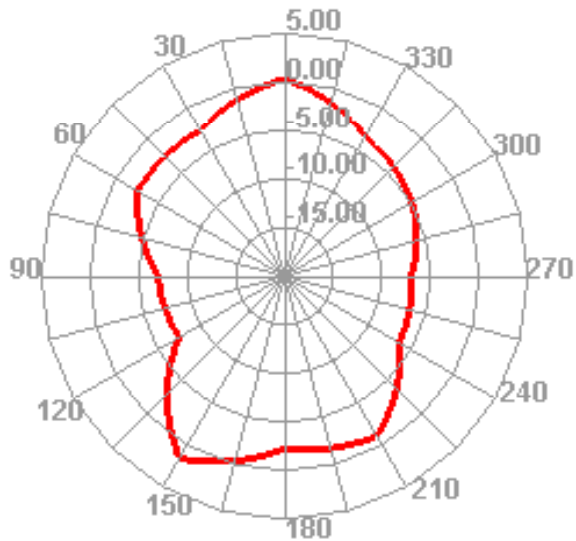

2400.000MHz E2

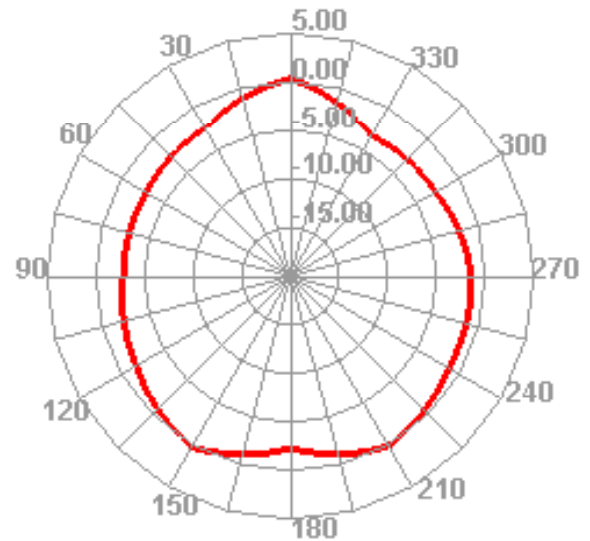



Radiation Pattern For BT Antenna

2450.000MHz

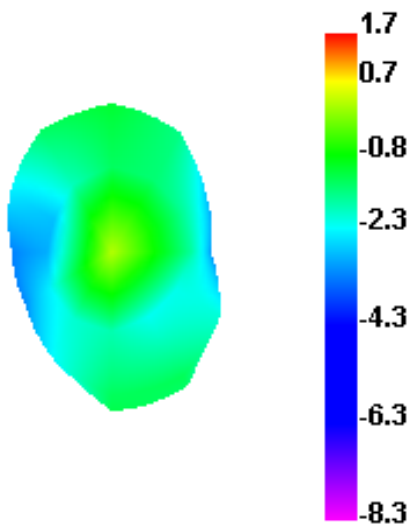

2450.000MHz H

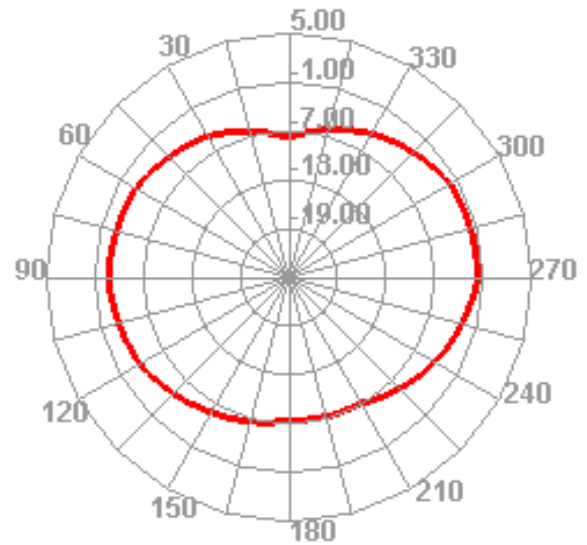

2450.000MHz E1

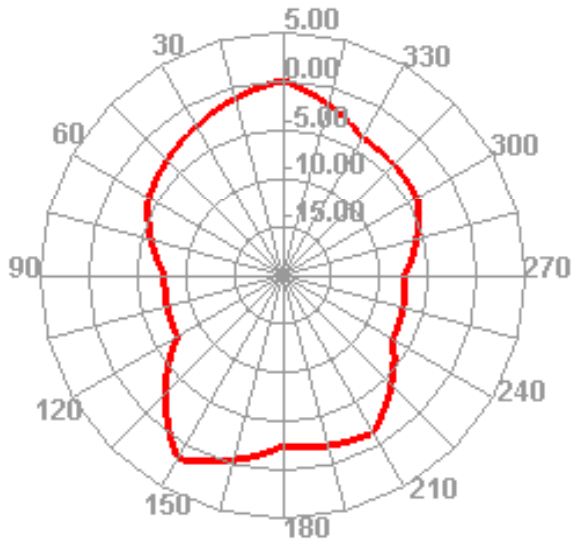

2450.000MHz E2

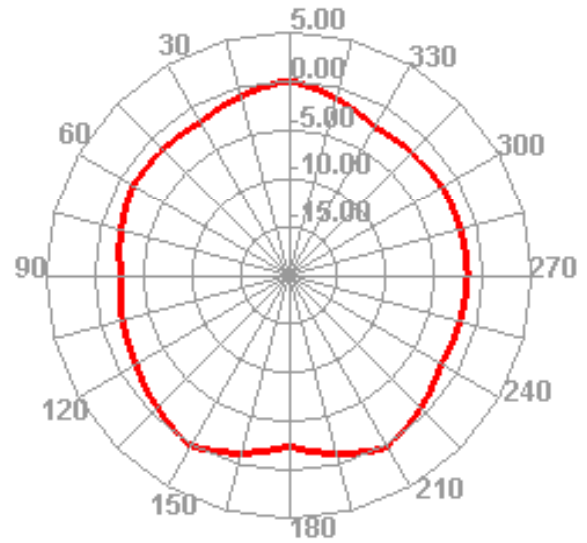



Radiation Pattern For BT Antenna

2500.000MHz

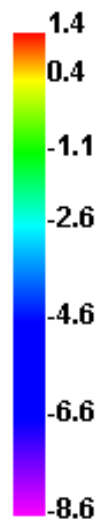
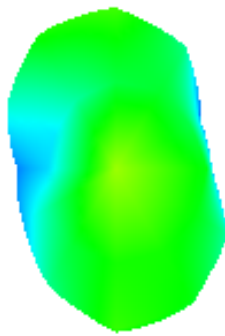

2500.000MHz H

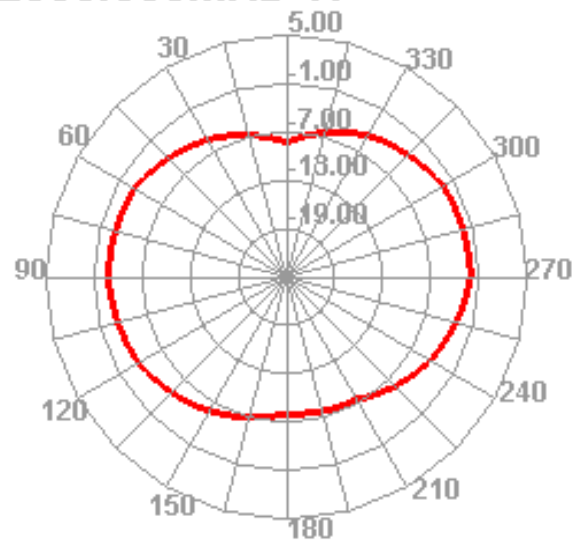

2500.000MHz E1

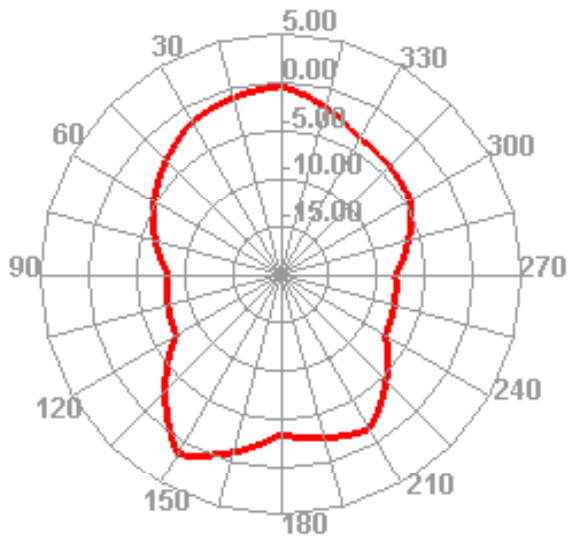

2500.000MHz E2

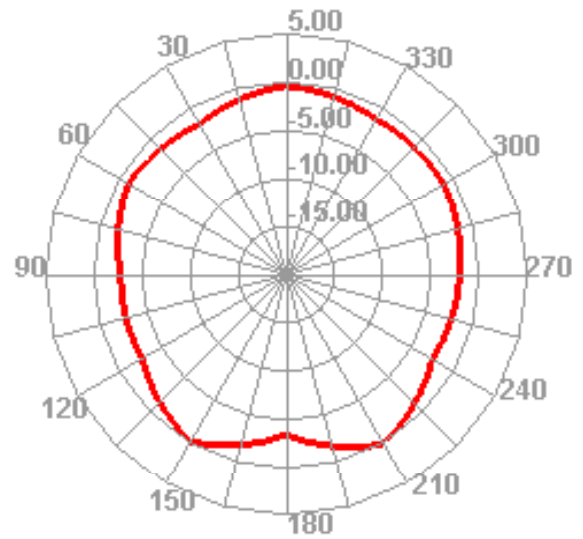



***Antenna
BT***

