

ERP 机型 : PL45H1UQ-US-SMT00030A-V1

ERP P/N:

描述 : 说明书: PL45H1UQ/PGD238, SMT000.REV.A(UMPGD23820220907),
140x190mm, 80g书纸, 双面单黑印刷, 16页32面装订本, RoHS2.0, REACH,
Prop65, POPs, PAHs

K

Die Line

Designer: Sabrina

Date:2022-09-07

LOCKLY GUARD™

WWW.LOCKLYPRO.COM

FOR COMMERCIAL USE & PROFESSIONAL INSTALLATION

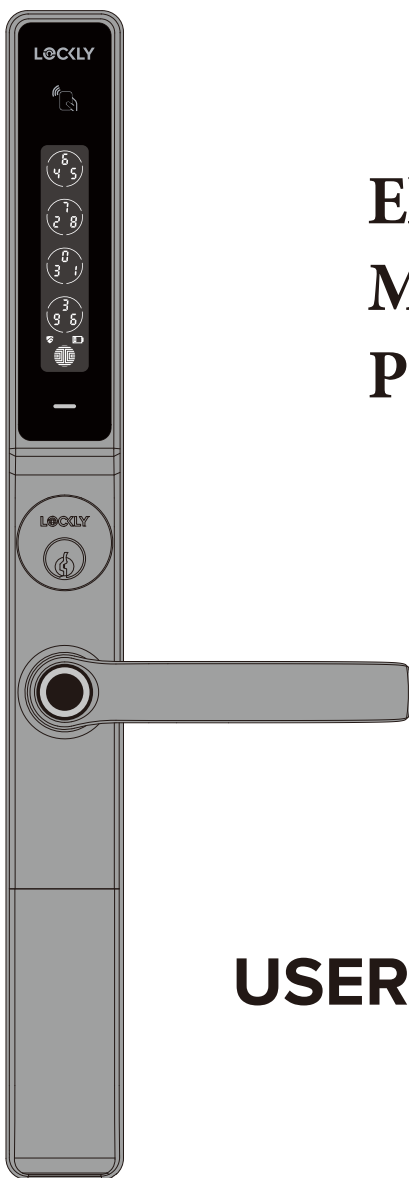

Electronic Mortise lock PGD238FC

USER MANUAL

Table of Contents

Section 1 - Product Highlights

1.1 Product Features	1
----------------------	---

Section 2 - Product Overview

2.1 Product Overview- Exterior	2
2.2 Understanding Your New Lock	3
2.3 Locking/Unlocking with App	3
2.4 Rebooting Lockly Guard	4
2.5 Low Battery	5
2.6 Changing the Battery	6

Section 3 - Using Your Smart Lock

3.1 Configuring Access	7
3.2 Entering Programming Mode	8
3.3 Pairing to a New Mobile Device	8
3.4 Adding an Access Code	10
3.5 Delete/Query an Access Code	10
3.6 Adding a Fingerprint	11
3.7 Add/Remove Fingerprints	12
3.8 Fingerprint Scanning Directions	13
3.9 Fingerprint Scanning Tips & Troubleshoot	14
3.10 Adding an RFID card	14
3.11 Delete/Query RFID Card	15

Section 4 - Locking and Unlocking

4.1 Unlocking with Access Codes	16
4.2 Unlocking/Locking with Fingerprints	17
4.3 Unlocking using RFID	18
4.4 Locking/Unlocking with Physical Key	19
4.5 Safe Mode	20
4.6 Locking from the Outdoor	22
4.7 Rain Mode	23
4.8 Shine Mode	24
4.9 Welcome Mode	24

Section 5 - Advanced Features

5.1 Offline Access Code™ (OAC)	25
--------------------------------	----

Section 6 - Important Notes

 26

Section 7 - Cleaning

 27

Section 8 - Safety Precautions

 27

For additional support, visit [http:// LocklyPro.com/support](http://LocklyPro.com/support) or email prosales@lockly.com



1.1 Product Features

Patented Hack-proof PIN Genie Keypad

Digits are randomly displayed on the keypad ensuring access codes to be undetectable to intruders after repeated use. Numbers are randomly distributed across 4 buttons, with 3 numbers in each button. Users can press any button showing their number. Location of the numbers are always different everytime someone uses the keypad, making it hard for prying eyes to guess the correct code.

Multiple Access Codes & Monitoring

Store up to 1033 Access Codes and monitor each entry and exit records.

Advanced 3D Fingerprint Recognition

Biometric Fingerprint Recognition protocol allows up to 99 registered fingerprints to be used and accepts only actual fingerprints - preventing lifted prints from being used.

RFID Card Access

Store up to 999 MIFARE RFID card

Live Monitoring

Through your smartphone, monitor door access from anywhere in the world and securely control who comes and goes.

Offline Access Code™ (OAC)

The offline access code™ can allow owners to issue access codes, set the allowed access duration, all without Lockly Guard ever connecting to the internet, so in case of power outage, you can still magically and remotely issue Access Codes without any connection to the web.

Automatic Lock

Owners no longer have to worry about forgetting to lock the door. With Auto Lock enabled, Lockly Guard will automatically re-lock the door based on your customized timing set between 5-300 seconds. (Note: Auto locking only supports latches)

Backup Keys and 9V Battery Socket

The door can be opened with physical backup keys. There is also a 9V battery connection socket for emergency power backup to access the keypad in case your smart lock runs out of battery.

2.1 Product Overview- Exterior

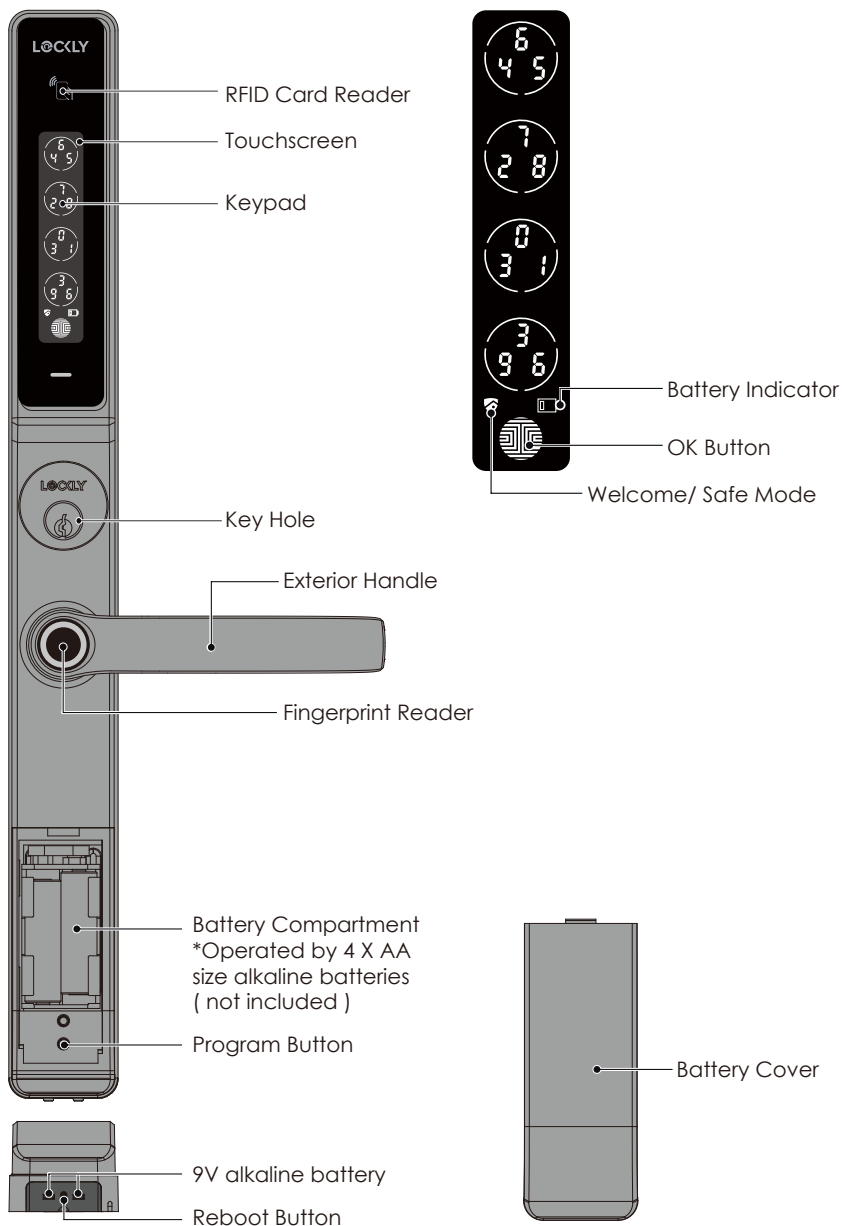

2.2 Understanding Your New Lock



NOTICE

The Default Access Code is **1 2 3 4 5 6**

After the installation of your new Lockly Guard, understanding some key functions of operating your smart lock is important. The following guides will walk you through resetting a lock, adding and deleting **Access Codes**, adding and deleting **fingerprints**, adding and deleting **RFID cards** and also how to configure your **OAC (Offline Access Code™)**

For any questions you can always visit <http://LocklyPro.com/support> for assistance.

2.3 Locking/Unlocking with App

Lockly Guard works best with our iOS and Android app. You must have the LocklyPro iOS or Android app installed in order to lock and unlock with smartphone. Download the app by visiting the link below or search "LocklyPro" from the correct app store.

Scan or visit
LocklyPro.com/app

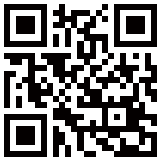

2.4 Rebooting Lockly Guard



NOTICE

Reboot Lockly Guard in case of dead battery or malfunction. No settings will be changed and all Access Codes will still be stored within Lockly Guard.

Press and release the **reboot button** when you want to reboot the lock. Your Lockly Guard will beep once after reboot. Only reboot when necessary.

To reboot, find the restart button from the **bottom** of Lockly Guard.

You will need something small such as a **paperclip**, to press the **reboot button**. Insert the paper clip and press down firmly.

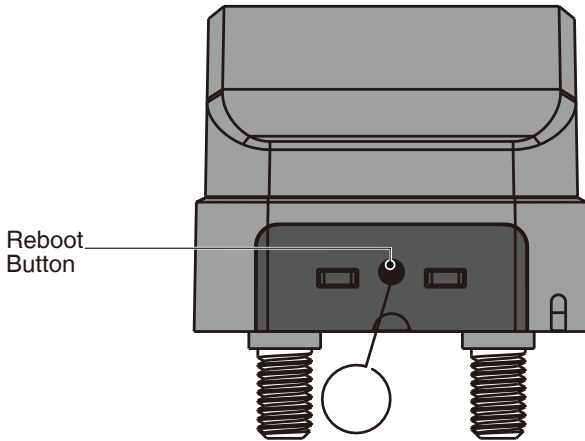

2.5 Low Battery

When the battery is in seriously low condition, Lockly Guard will make continuous beeping sounds in addition to the flashing low battery icon on the touch screen. You should replace batteries **immediately** to avoid your smart lock from **shutting down**.

When your smart lock low-battery warning alert finally dies, you will have 3 chances to unlock your smart lock either by a password, APP or fingerprint. If the unlock was successful, the low-battery warning alert will be on for 1 minute. After which, the smart lock will go to dead-battery mode and will lock auto lock in 5 seconds and the screen will display a low-battery icon.

Condition	Indicator	Solution
Low Battery	Battery Icon on the display keypad will light up to indicate low battery 	Replace batteries immediately to avoid battery failure. Lockly Guard can still operate up to 300 cycles in low battery condition.
Dead Battery	When there is no display and sounds; and screen is non-functional.	Replace batteries immediately. Supplied physical backup keys can be used to unlock the door. Alternatively, Use a 9V battery as shown below to temporarily activate the lock.

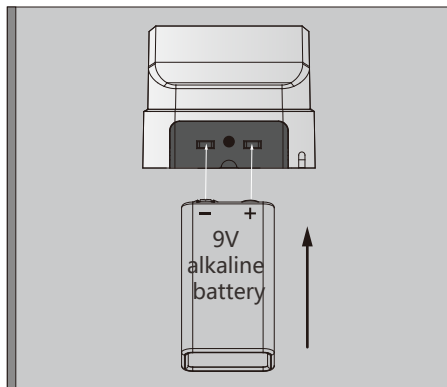

Your Lockly will automatically detect battery polarity. So hold your 9V battery lead in place against bottom of the Lockly to **temporarily** activate the screen to enter your **Access Code**. Be sure to hold the 9V battery against the contact points located at the bottom of the lock until you have successfully unlocked your door with your **Access Code**. Once unlocked, batteries should be replaced immediately.

2.6 Changing the Battery

Open the battery compartment cover and insert **4 AA alkaline battery** as shown below.

- Make sure the batteries are correctly oriented.
- Replacement of batteries does not affect programmed data.
- Replace only with new batteries. **DO NOT mix with used batteries.**

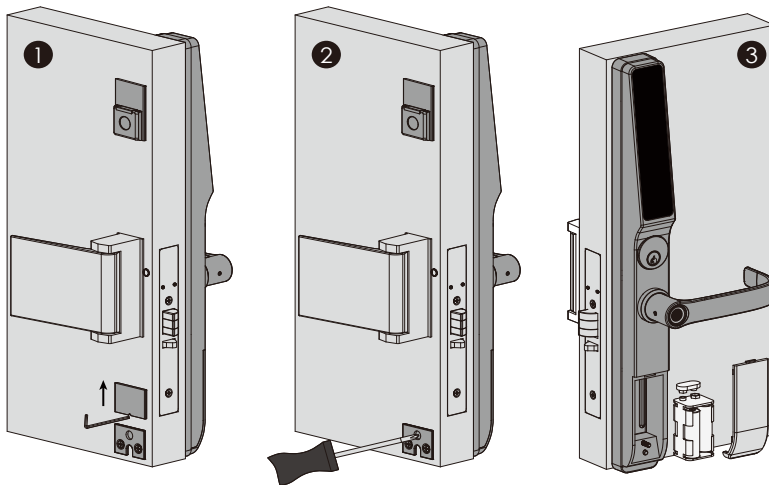

- 1 Use a screwdriver to push the back screw stopper up then loosen the screw.
- 2 Remove the battery cover.
- 3 Unplug the terminals of the battery compartment and install the battery.



NOTICE

Whenever batteries are replaced, reconnecting the smart lock to your smartphone App is required.

If you have not yet downloaded the app, visit:
LocklyPro.com/app

3.1 Configuring Access



We recommend pairing your lock to your smart phone to manage your access codes. Section 3.1 - 3.11 refers to locks NOT paired with a smart phone. Once paired with a smart phone, the Program button will be disabled.

Your new Lockly Guard **Access Code** can be any combination of **6 to 8 digits**. Once a new **Access Code** is entered, the **Default Access Code** of **123456** would be deleted.



OK Button

How to Use the Keypad

There are a total of **five (5) buttons** on the keypad as shown in the example image to the left. The numbers in each button may differ than what is shown on your device than what is displayed here.

To enter your required digit, just simply press the circle where your number is shown. You do not need to press the actual number as anywhere within the circle will suffice.

The button on the bottom is the **OK** button. You will be pressing this button when you are done entering your **Access Code**.



NOTICE

The Default Access Code is **1 2 3 4 5 6**

Lockly Guard Defender can support up to 1033 sets of Access Codes. It comes with 60 access codes for free. To add more access codes, subscription to Lockly\OS is required. To subscribe, send an email to prosales@lockly.com or visit www.locklyOS.com to learn more.

3.2 Entering Programming Mode

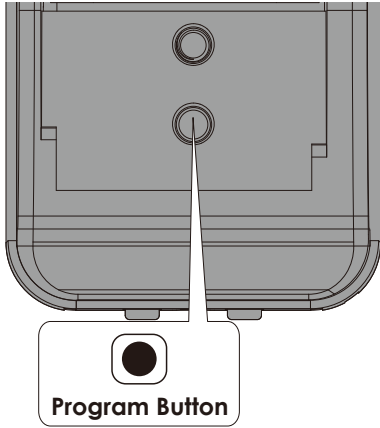

To enter **Programming Mode**, remove the battery cover on the bottom of the Lockly Guard to reveal the program buttons.

Short press the program button to enter programming mode. Enter administrator fingerprint, RFID card, activation code* or administrator access code (the initial administrator password is 123456) then tap 

To end **Programming Mode**, press the **Program** button anytime. **Programming Mode** will automatically exit if the keypad is inactive for more than thirty (30) seconds.

Number	Mode
! 8L	Bluetooth Activation

*Activation Code card is attached to this user manual page cover. Store it for future use. Once you have registered your lock on the Lockly app, you have the option to save it on the PIN Genie Vault. To access details for future use, check your account information and go to PIN Genie Vault.

3.3 Pairing to a New Mobile Device

Pair with Bluetooth

While in Programming Mode, select **"BL"** to pair a new smart phone. If you are not in Programming Mode, please see **Section 3.2** to enter Programming Mode.

After pressing **"BL"**, the BL icon will flash and you will here short beeps. You need to wait and allow the pairing of new devices.

You will hear long beep and the green light will be on if the pairing is successful. You will here 3 short beeps and the red light will be on if pairing is unsuccessful. You will need to reenter the programming mode, then Bluetooth pairing mode **"BL"** to re-pair the device.



3.3 Pairing to a New Mobile Device (Continued)

PAIR LOCKLY GUARD TO APP

To pair your smart lock to a new mobile phone, download the LocklyPro app on your new mobile phone then use the same account to login to your LocklyPro App on the new mobile device. If you're pairing your Lockly Guard to a new LocklyPro app account, follow the steps below

1. On the old LocklyPro app account, go to Settings > Reset and pairing > Perform Factory Reset.
2. Download, register and log in to the new LocklyPro app account.
3. You will need to scan the **ACTIVATION CODE*** that comes with the lock to setup to a new account.



Old LocklyPro app account

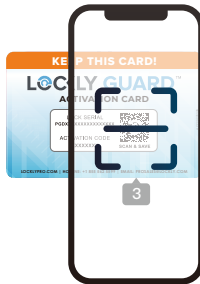

Scan to new LocklyPro account



User Manual



IMPORTANT

DO NOT INSERT ANY PINS TO RESET HOLES OF LOCKLY GUARD DEFENDER OR LINK PLUS without consulting our support team. If you cannot remove your Lockly Guard from the old account, please contact LocklyPro support (855) 562-5599 or email: prosales@lockly.com

3.4 Adding an Access Code

Enter the App Access Management settings then tap **"Add New User"**. Select the type of user you wish to add access, **"Trusted User"**, **"Guests"**, **"One-Time Access"**. For example, select **Trusted User**, enter the user's name and set the **Access Code**. Re-enter the access code, then tap **"Confirm"** to successfully add the new access code.

An access code is a combination of 6 to 8 digits. The Administrator can set up to 1033 sets of access codes and these can only be added through the App.

Default access code (123456) becomes invalid once an administrator access code is setup.

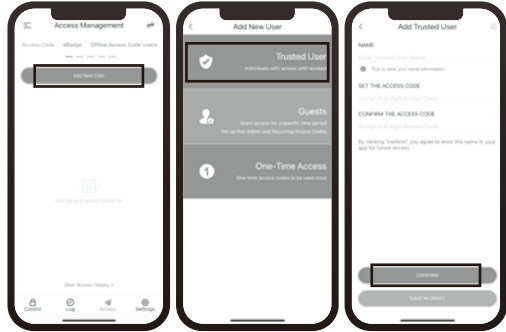

3.5 Delete/Check an Access Code

Access codes can only be deleted through the App. Enter the App Access Management and you can view all the issued access code users. Tap the user access code user you wish to be deleted. Check access code and user name is correct, then tap **"Delete User"** to complete deleting the user access code.



The default access code 123456 can not be deleted until a new access code has been setup. Immediately setup a new access code and delete the default access code for your security.

3.6 Adding a Fingerprint

We are using an advanced biometric sensor, providing the most secure fingerprint authentication. For security reasons, Lockly Guard will only accept fingerprint patterns that consist of cross intersection points. Patterns with no cross intersection points will not be acceptable.

Please check your fingers before registration to make sure the finger you want to register will be acceptable by our system. Otherwise, use an alternative finger to ensure successful registration.

The following examples show which types of fingerprint patterns will be acceptable. It is highly recommended to enroll at least one finger from each hand in case the hand you are using is unavailable, such as, in instances like if you are holding items in that hand or have sustained an injury.

Fingerprint Pattern with Cross Intersection Lines

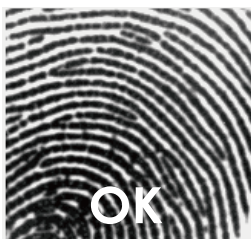

Concentric or Parallel Pattern with no Cross Intersection Lines

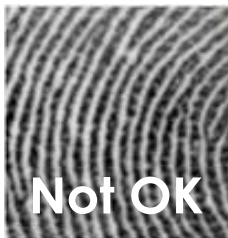

Fingerprint with Scars or Worn Out Ridges

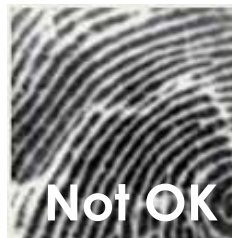

Your Lockly Guard can register up to **ninety-nine (99) fingerprints**. Please read the following sections if you want to add or delete fingerprints. We recommend using your app to add fingerprints, however, the following section can show you without using the app.

3.7 Add/Delete Fingerprints

Fingerprints can only be added or deleted through the App. On the App Access Management, select Fingerprint, then tap **"Add New Fingerprint"**.

Scan your finger by lightly placing your designated finger on the sensor until you hear a beep. Lift your finger and repeat the process until the digit "6" shown on the screen becomes "1". If you have successfully scanned and registered your fingerprint, you will hear a beep and PASS will be displayed on the keypad. Press  to exit. If you did not successfully register your fingerprint, FAIL will show on the keypad. If FAIL is displayed, return to the previous App menu and rescan your finger.

For fingerprint scanning directions, please refer to **Section 3.8**.



 **IMPORTANT**

Please make sure your fingers are clean from dirt and oils before scanning your fingerprint. Make sure the sensor is also clean by taking a soft cloth and wiping the surface.

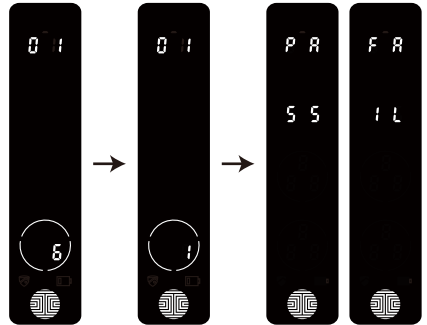

To **delete fingerprint access**, on the App Access Management, select Fingerprint. All registered fingerprint profiles will be shown. Scroll down, select the tap the profile you wish to delete. Check and then tap **"Delete User"** to confirm and complete deleting the fingerprint.

3.8 Fingerprint Scanning Directions

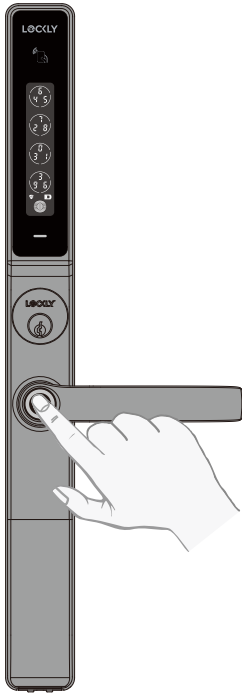

The **fingerprint sensor** equipped in Lockly Guard is loaded with powerful fingerprint algorithms to extract quality features from fingers, even in poor conditions. Placing your finger on the sensor correctly helps consistency in fingerprint recognition.

The following directions and tips will guide you on how to scan an optimal fingerprint image.

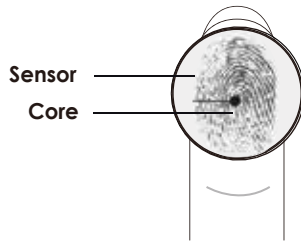

Position your finger on the **center** of the sensor

Top View

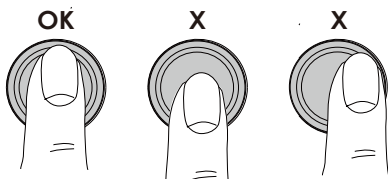

o Correct

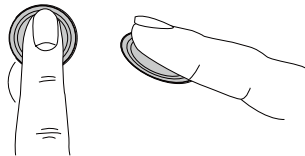

Side View

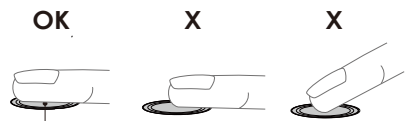

o Incorrect

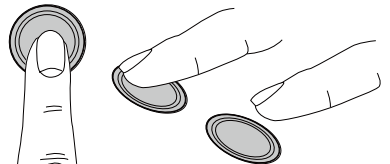

3.9 Fingerprint Scanning Tips & Troubleshoot

Tips for Fingerprint Enrollment and Recognition

- Place your finger to completely cover the sensor with maximum contact surface.
- Position the center of your finger (core) to the center of the sensor.
- Hold your finger still for more than a second until you hear a beep.
- Scan a finger that is clean and free from dirt.
- Children ages 12 and under are not recommended to use fingerprint access due to the constant changes of their fingers during growth.
- Elderly with fading fingerprints may have difficulty in recognition.
- If your finger has a cut, scar, or cracked skin due to dryness, try another finger.

Troubleshooting Fingerprints

In case of poor fingerprint conditions

- If wet - wipe excess moisture from finger before scanning
- If dirty - wipe stains and dirt off from finger before scanning
- Make sure the sensor is clean from dirt or smudges - wipe sensor with soft cloth regularly

For more troubleshooting help, visit [http:// LocklyPro.com/support](http://LocklyPro.com/support)

3.10 Adding an RFID card

RFID cards can only be added through the APP, and a maximum of **999** RFID cards can be added.

On the App Access Management, select RFID card then tap **"Add New RFID Card"**

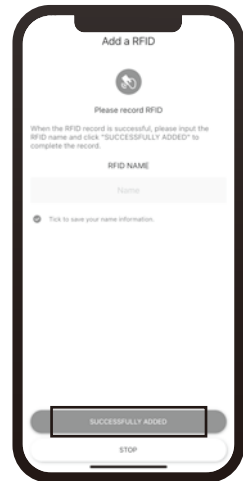
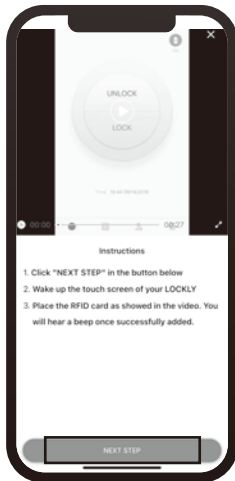

3.10 Adding an RFID card(Continued)

The Lockly Guard keypad will lit up and show the number sequence of the RFIDs to be added. Place the card into RFID card reading area.

- When RFID card is successfully added, keypad will display PASS followed by a beep. The display screen will exit automatically and lit up with PIN Genie screen.
- If RFID card is not successfully added, keypad will display FAIL followed by short beeps then screen will be off. If FAIL is displayed, return to the previous App menu and try to "Add New RFID Card" again.

NOTE: When adding an RFID card, make sure the screen lit up and the card is close to the RFID reading area, within 1 cm.

If an RFID card is damaged or the card has not been encrypted properly, it cannot be added and used normally.



Place the **RFID card** to the screen where the **RFID card** sensor is embedded.



PASS will show on the keypad once card is registered successfully.

3.11 Delete/Check RFID Card

The RFID card can only be deleted/-checked through the APP.

On the App Access Management, select RFID Card. All registered RFID cards will be shown. Scroll down, select the tap the profile you wish to delete. Check and then tap **"Delete User"** to confirm and complete deleting the RFID card.



4.1 Unlocking with Access Codes

Lockly Guard Smart Lock can be unlocked using multiple ways - via your stored **Access Code**, registered fingerprint, RFID Card, smartphone with Bluetooth, or the physical key supplied with your lock.

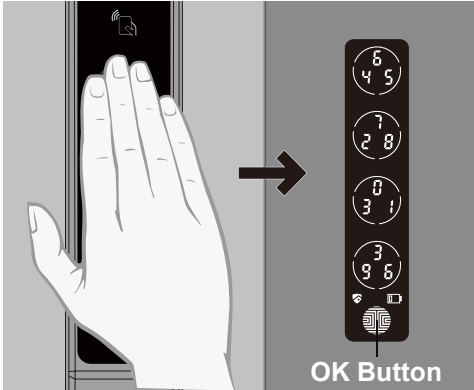

Slide your hand across the screen to activate the keypad.

Enter your **6 to 8 digit Access Code** followed by the . Press **OK** anytime to reset if you entered the wrong digit.

If the **Access Code** entered is correct, the door will unlock. If the **Access Code** entered is incorrect, Lockly Guard will beep twice.



Ten consecutive wrong attempts will put Lockly Guard in "Safe Mode". (See Section 4.5)

Lock your Lockly Guard by pressing the **OK Button** anytime when the door is closed. Lockly Guard will also auto-lock after five (5) seconds after unlocking and opening.

Automatic locking is only applicable to Latch Lock Body. DeadBolt Lock Body, Hook Bolt Lock Body and Exit Device Push Bar do not support auto lock. You need to manually turn the handle to lock.

You may toggle between two types of keypad displays to enter your **Access Code**. The **fixed digit** version and the **PIN Genie** version (Recommended). Press and hold the **OK Button** for 3 seconds to toggle back and forth between the two keypads.

PIN Genie



Fixed Digit



Hold OK Button (3 sec)

4.2 Unlocking/Locking with Fingerprints

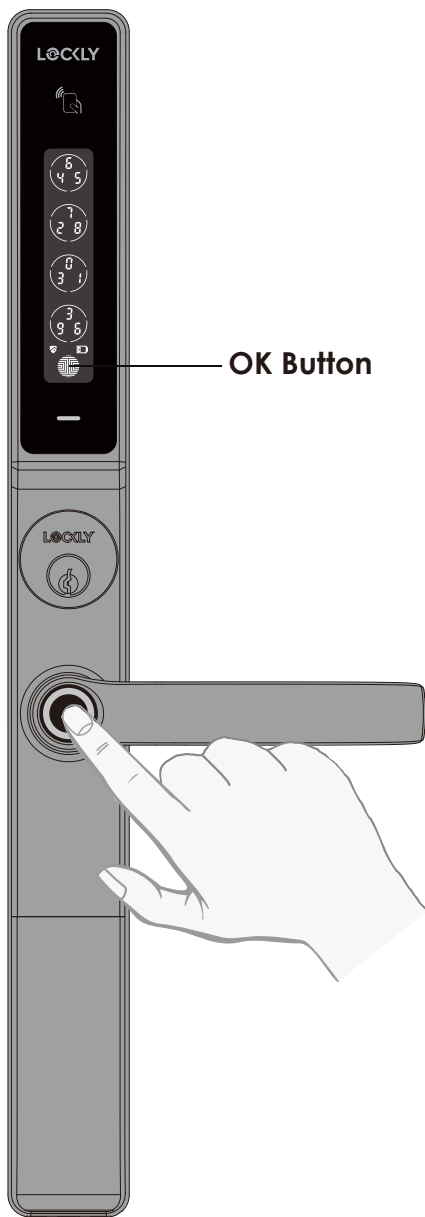

Unlocking

Place a registered finger to the **fingerprint scanner** located on the **exterior** handle of the lock.

To register a **fingerprint**, please see **Section 3.7**.

If your fingerprint is **registered** and acknowledged, you will hear a "beep" sound and a **Green LED** will light up on the **fingerprint scanner**. You can then push down the handle and open the door.

If you see a **Red LED**, it means your fingerprint is not recognized. Try again or use another registered fingerprint.

For best fingerprint scanning practices, see **Section 3.8**.

Locking

To lock the Lockly Guard, for the Latch Lock Body version press the **OK Button** anytime when the door is opened. For the DeadBolt Lock Body, Hook Bolt Lock Body and Exit Device Push Bar you need to manually lift the handle to lock.

4.3 Unlocking using RFID

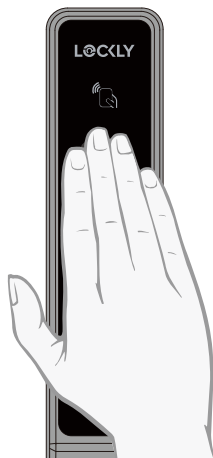

Light up the screen by touching the keypad.



Place your **RFID card** closer to the panel.

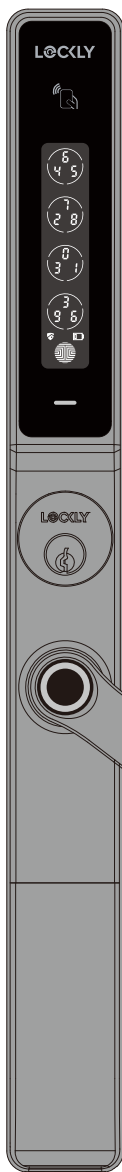

Push down the handle and open the door after it chimed.

4.4 Locking/Unlocking with Physical Key

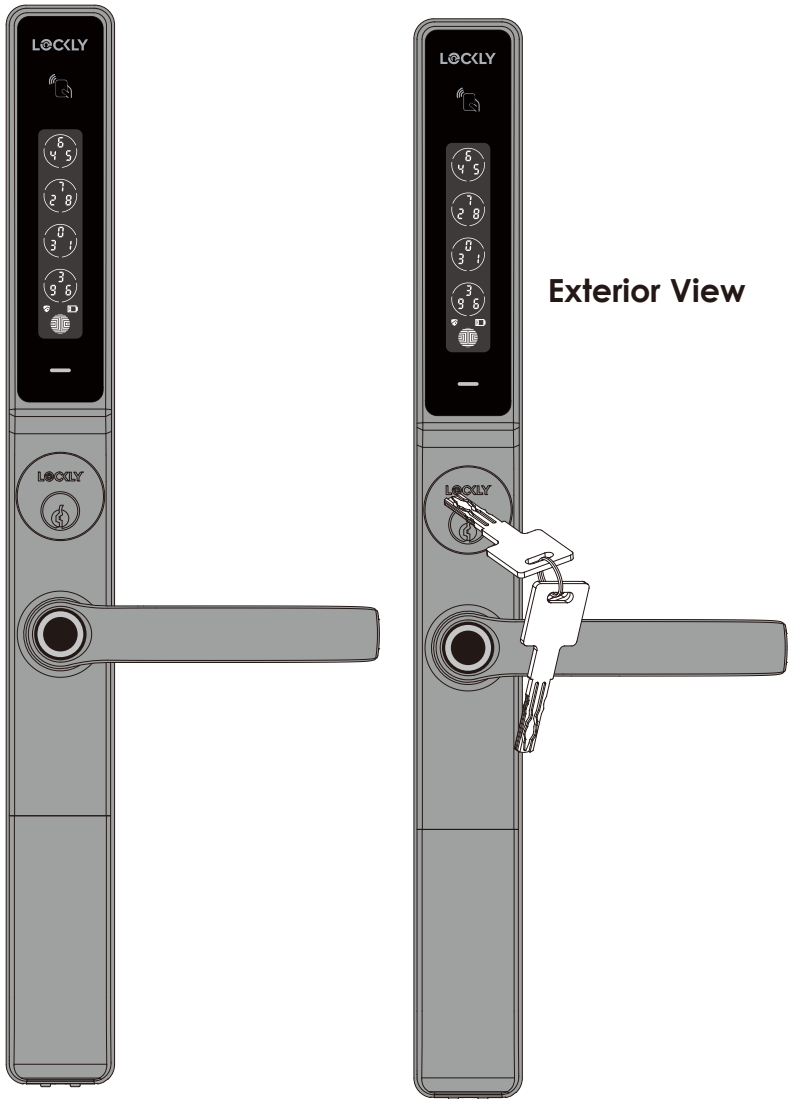

To unlock your Lockly Guard using the **physical key** (supplied. **Insert** your key and turn clockwise or counter clockwise to lock or unlock the door.

4.5 Safe Mode

Lockly Guard will enter **Safe Mode** when ten (10) consecutive wrong **Access Codes** are entered within 5 minutes. When in **Safe Mode**, the lock status icon  will start to flash.

To disable **Safe Mode**, you must unlock the door using the correct fingerprint or enter the correct **Access Code** twice in a row. Activate the keypad by pressing and holding  for 3 seconds.

Once the screen is activated, enter the correct **Access Code** carefully twice, pressing  after every time.

If you enter the wrong code, the keypad will then be disabled for **10 minutes**.

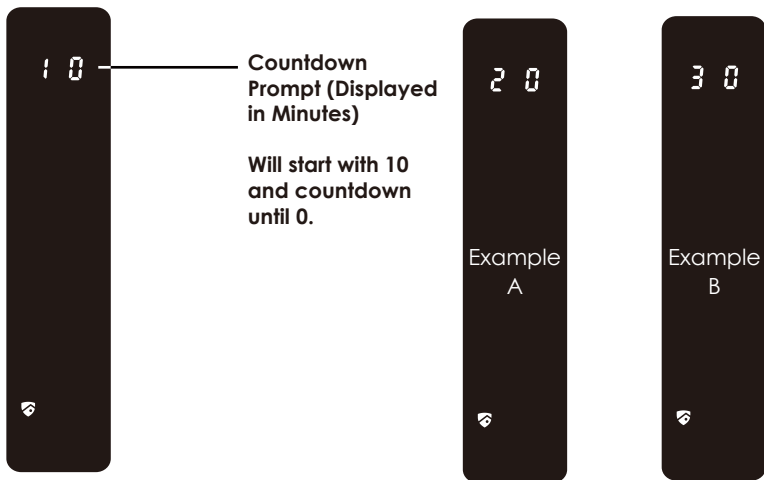

You will see a “10” on the screen, notifying the number of minutes that the keypad is disabled for. After **10 minutes**, you may attempt to enter the correct **Access Code** to unlock the door. After the second incorrect attempt to unlock the lock with the wrong **Access Code**, Lockly Guard will disable the keypad for **20 minutes**, displaying a “20” on the screen. After the third wrong attempt to unlock the door with the correct **Access Code**, the screen will be disabled for **30 minutes**. (Example A and Example B above).

Note: In order to conserve power, the countdown prompt will only be displayed for 3 seconds. You can reactivate the screen by sliding your hand across the screen.

4.5 Safe Mode (Continued)

There are four (4) ways to disable **Safe Mode**.

Option 1 - Lockly Guard Bluetooth App

Use the app that is synced to your Lockly Guard to disable **Safe Mode** by unlocking the door. If you have not downloaded the app to use with your smart lock, you won't be able to use this option to disable **Safe Mode**.

Option 2 - Physical Key

There is a pair of keys included with your new lock. You may use the keys to manually unlock the door. To learn how to use your physical keys, see Section 4.4.

Option 3 - Registered Fingerprint

Use any registered fingerprint or RFID to reactivate the keypad. The door will unlock and reactivate the keypad once a registered fingerprint or RFID is used.

Method 4: Register RFID Card

Put the RFID card into the RFID card reading area. Once the correct RFID card is identified, press the handle to unlock and safe mode will be disabled.

4.6 Locking from the Outdoor

Lockly Guard smart lock will automatically lock once your door is closed. You can set the Auto Lock timer or you may opt to disable this feature through the APP.

When Auto-lock is disabled, you can quickly lock your door with One-Touch anywhere on the keypad or simply press the . The latchbolt will lock. To lock the deadbolt, lift the handle to fully lock door.

One-Touch feature can be activated or deactivated through the App. Go to Settings, then select Touchscreen Locking.

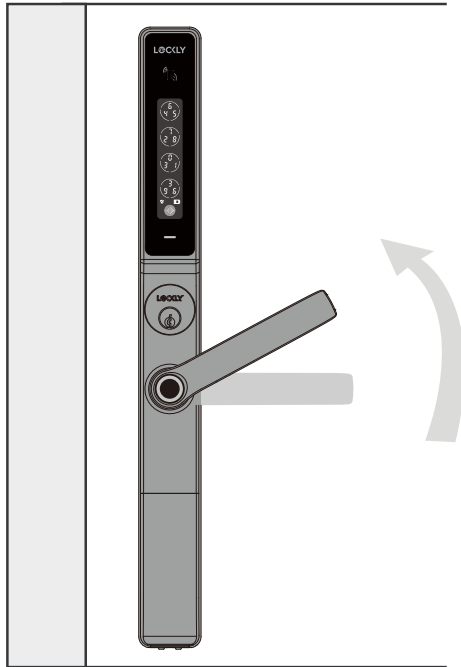

When you are outside the door, lift handle up to lock the door.



ONE- TOUCH locking feature is not available for Hook Bolt Mortise Lockset. You need to lift the handle to lock from the outdoor.

4.7 Rain Mode

Like other digital electronic products water can trigger to activate the touchscreen and fingerprint sensor which may cause the batteries to drain. To protect the lock and extend battery life, you can setup your Lockly Guard to enter Rain Mode to shut off keypad and fingerprint reader whenever rain or water is detected.

Activate this feature on the LocklyPro app. While you are within the Bluetooth range or remotely connected thru Wi-Fi hub (Secure Link), go to **Settings > Rain Mode** and toggle the button  to turn ON.



IMPORTANT

When RAIN MODE is ON, the keypad, fingerprint sensor and RFID reader cannot be used. Unlock via LocklyPro App, or physical key. Rain Mode auto exits every 30-mins and re-enters if water or rain is still present.

If you are using the LocklyPro app, you will be notified when Lockly Guard entered rain mode and it will be recorded in your access history.

If you have not yet connected your device to LocklyPro App, follow below steps to activate the rain mode feature:

RAIN MODE ON

1. Long press  to enter fixed digit keypad.
2. Enter **access code +234+** .

example: 135790 + 234 + 

3. You will hear a short beep and Bluetooth indicator flashes green once Rain Mode is ON.

RAIN MODE OFF

1. Long press  to enter fixed digit keypad.
2. Enter **access code +890+** .

example: 135790 + 890 + 

3. You will hear a long beep and Bluetooth indicator flashes green once Rain Mode is OFF.

4.8 Shine Mode

Lockly Guard touchscreen keypad brightness was designed for optimum battery life. However, some users may need to adjust the brightness to their convenience to enter access codes.

Swipe your fingers across the keypad to light up to its normal brightness. To adjust brightness, **long press the top button for 3 seconds**.



The touchscreen keypad will automatically return to normal brightness after the screen dimmed.



4.9 Welcome Mode

Welcome Mode temporarily disables auto locking, keeping the door open for a specified period of time eliminating the need to enter access codes, fingerprint or using Mobile App.

Enable this feature through the LocklyPro App. Go to > **Settings > Enable Welcome Mode**, then slide button to enable and set the specific time you require your door unlocked. The Welcome Mode icon will remain displayed while in effect.

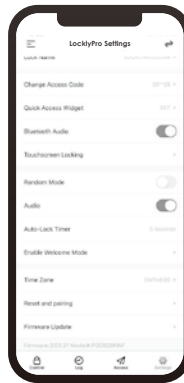

To ensure Welcome Mode works normally after replacing the battery, reconnect the lock to the LocklyPro app to synchronize the time.

5.1 Offline Access Code™ (OAC)

The **Offline Access Code™ (OAC)** is a unique feature of our smart lock. It allows you to grant access to guests remotely without guests needing to download the app.

To use the **OAC** feature, make sure you download the LocklyPro app for iOS or Android first, and sync your smart lock to your mobile device. OAC can only be issued by the administrative owner of the lock.

From there, you can then issue an **Offline Access Code™** within the app.

Go to “**Access**” and choose “**Add a New User**,” then select **Offline Access Code™ (OAC)**” and follow on screen instructions to generate your **Offline Access Code™**.

Understanding Offline Access Code™ (OAC)

OAC are issued to the guest by asking them to enter 4-12 digit number after a double - click on the . Your Lockly Guard randomly generates the **Offline Access Code™** which can be shared to your guests together with the instructions generated using the LocklyPro app.

After a double-click on the , touchscreen will display numbers on **Fixed Digit** mode, then guest can enter the **Offline Access Code™**.

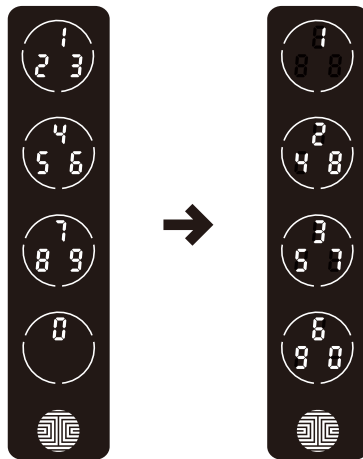

6.1 Important Notes

Auto Lock Feature

Your lock can be programmed to auto-lock between **5-300 seconds** after the door opening. You can select the timing through the LocklyPro App. If auto-lock is not activated and door is still open, the touchscreen will remain lighted, simply press  on the keypad to lock (Only for Latch Lock Body).

One-Touch Locking

You can always manually do a quick lock by touching anywhere on the touchscreen. Lockly Guard smart lock is shipped with this feature already activated. You may deactivate this feature through the **LocklyPro App**.

9V backup power

When your Lockly smart lock is out of power, you can temporarily use a 9V battery to touch the bottom contacts of the outer lock to activate the on-screen buttons. For more information, please refer to **Section 2.5**.

Physical Keys

Even though you have your fingerprints registered, RFID cards and Access Codes stored, it's always best practice to carry your **physical keys** with you at all times in case for any reason, Lockly Guard falls into Safe Mode.

Activation Code

You may find an **Activation Code** Card with an **Activation Code** included in your package. It is very crucial that you do not lose this card. Please store this card safely as you will need the default **Activation Code** on that card to **master reset** your lock in case, for any reason, you have lost the phone paired to Lockly Guard and also forgot your **Access Code**.

Troubleshooting

Please visit <http://LocklyPro.com/support> for troubleshooting and the most frequently asked questions and answers.

7.1 Cleaning

Making sure your Lockly Guard is clean is best practice to ensure optimal product use. Follow the DOs and DON'Ts below.

DO

- Rinse the touchscreen with warm water prior to cleaning.
- Use the application of soap with a damp, lukewarm cloth.
- Airdry or wipe dry with a soft microfiber cloth to avoid scratches.

DON'T

- Don't use abrasives, high alkaline cleaners, or gasoline to clean your lock.
- Don't apply cleaning detergent directly in sunlight or at high temperatures.
- Don't leave cleaning detergent on the display keypad for long periods of time - wash immediately.
- Don't use scrapers, squeegees, or razors.

8.1 Safety Precautions

Please read all instructions carefully. Remind all Lockly Guard users of the safety precautions.

Read the following instructions for your own safety

Do not attempt to disassemble the smart lock by yourself. It can cause product damage, void warranty, and cause injuries.

Do not use any inappropriate tools that can cause damages or malfunction to your lock.

Always make sure your door is securely closed and locked when you leave your house to prevent unwanted entry.

Please keep your Access Codes safe. Restrict access to the back panel of your smart lock and check your settings regularly to ensure Access Codes have not been changed without your knowledge.



Unauthorized changes and modifications may void your product warranty. If you have questions or any problems while using your Lockly Guard Smart Lock, contact our customer service department at prosales@lockly.com or visit <http://LocklyPro.com/support> for technical assistance.

FCC Warning:

This device complies with Part 15 of the FCC Rules. Operation is subject to the following two conditions: (1) This device may not cause harmful interference, and (2) this device must accept any interference received, including interference that may cause undesired operation.

NOTE 1: This equipment has been tested and found to comply with the limits for a Class B digital device, pursuant to part 15 of the FCC Rules. These limits are designed to provide reasonable protection against harmful interference in a residential installation. This equipment generates, uses and can radiate radio frequency energy and, if not installed and used in accordance with the instructions, may cause harmful interference to radio communications. However, there is no guarantee that interference will not occur in a particular installation. If this equipment does cause harmful interference to radio or television reception, which can be determined by turning the equipment off and on, the user is encouraged to try to correct the interference by one or more of the following measures:

- Reorient or relocate the receiving antenna.
- Increase the separation between the equipment and receiver.
- Connect the equipment into an outlet on a circuit different from that to which the receiver is connected.
- Consult the dealer or an experienced radio/TV technician for help.

NOTE 2: Any changes or modifications to this unit not expressly approved by the party responsible for compliance could void the user's authority to operate the equipment.

FCC Radiation Exposure Statement

This equipment complies with FCC radiation exposure limits set forth for an uncontrolled environment. It should be installed and operated with minimum distance 20cm between the radiator & your body.

IC WARNING

This device contains licence-exempt transmitter(s) that comply with Innovation, Science and Economic Development Canada's licence-exempt RSS(s). Operation is subject to the following two conditions:

- (1) This device may not cause interference.
- (2) This device must accept any interference, including interference that may cause undesired operation of the device.

L'émetteur/récepteur exempt de licence contenu dans le présent appareil est conforme aux CNR d'Innovation, Sciences et Développement économique Canada

applicables aux appareils radio exempts de licence. L'exploitation est autorisée aux deux conditions suivantes:

1. L'appareil ne doit pas produire de brouillage;
2. L'appareil doit accepter tout brouillage radioélectrique subi, même si le brouillage est susceptible d'en compromettre le fonctionnement.

IC Radiation Exposure Statement

This equipment meets the exemption from the routine evaluation limits in section 2.5 of RSS-102. It should be installed and operated with a minimum distance of 20cm between the radiator and any part of your body.

Cet équipement est conforme à l'exemption des limites d'évaluation habituelle de la section 2.5 de la norme RSS-102. Il doit être installé et utilisé à une distance minimale de 20 cm entre le radiateur et toute partie de votre corps.



WARNING: This product can expose you to chemicals including Lead, which is known to the State of California to cause cancer. For more information go to www.P65Warnings.ca.gov.

LOCKLY GUARD™

FOR COMMERCIAL USE & PROFESSIONAL INSTALLATION

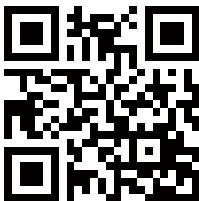

For additional support,
visit [http:// LocklyPro.com/support](http://LocklyPro.com/support)
or email prosales@lockly.com

For digital versions and instructional videos, please visit the following link
LocklyPro.com/support

© Copyright 2022 Lockly Guard All rights reserved

USA Patent NO. US 9,881,146 B2 | USA Patent NO. US 9,853,815 B2 | USA Patent NO.
US 9,875,350 B2 | USA Patent NO. US 9,665,706 B2 | USA Patent NO. US 11,010,463 B2
AU Patent NO. 2013403169 | AU Patent NO. 2014391959 | AU Patent NO.
2016412123 | UK Patent NO.EP3059689B1 | UK Patent NO. EP3176722B1

The Bluetooth® word mark and logos are registered trademarks owned by the
Bluetooth SIG, Inc. and any use of such marks by Lockly is under license.