



# Shen zhen Golden-Resource Electronic Co.,Ltd.

## SPECIFICATION FOR APPROVAL

Date	2023/01/04
File No	23010401
Revision	1.0

CUSTOMER: SMART ELECTRONIC INDUSTRIAL CO.,LTD.

CUSTOMER NO: PGI303FC

PART NAME: 2.4G AntennaAntenna LL=90mm90mm MMHFHF

SUPPLIER NO: YJW01.029.085.301A

Date:

Q"TY: PCS

CUSTOMER APPROVED BY		
APPROVAL	CHIEF	SUPERVISOR

SUPPLIER SIGNATURE		
APPROVAL	CHECK	DESIGN
ChenGuoqiang	XieLi	ChenXingcheng

YJ-RD-F04-A



# Spec Item

NO	Contents	Number of Page	Page Code
1	Spec Cover	1	1
2	Spec Item	1	2
3	Drawing	1	3
4	Antenna Specification	1	4
5	S Parameter	1	5
6	Passive Test	1	6
7	Radiation Pattern	12	7 ~ 18
8	Antenna Profile	1	19
9	N/A	N/A	N/A
10	N/A	N/A	N/A
11	N/A	N/A	N/A
12	-	-	-
13	-	-	-

**RoHS**  
Compatible

CUSTOMER	
PART NO	

REV.	DESCRIPTION	DATE
△	Initial Issue	2021-11-24

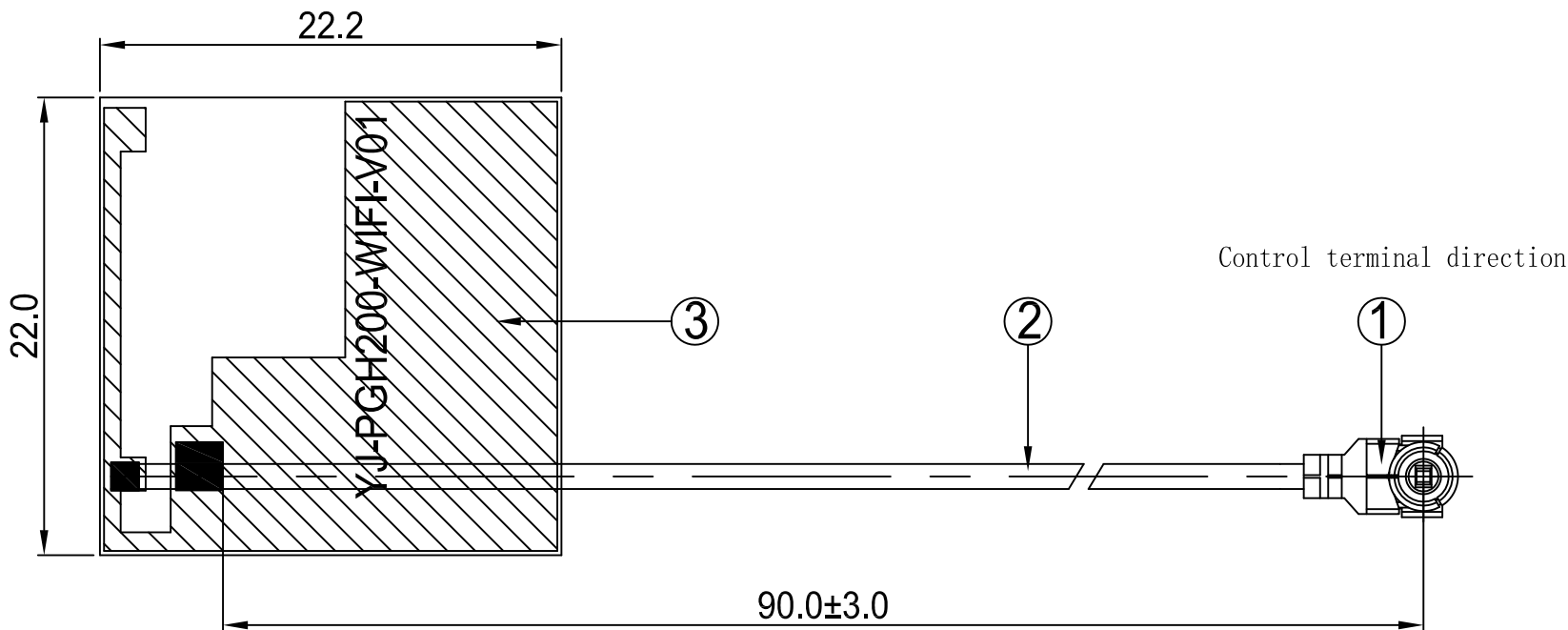

**Shen zhen Golden-Resource Electronic Co.,Ltd.**

PART NAME: Antenna L=90mm MHF			
PART NO.: YJW01.029.085.301A		DATE: 2021-11-24	
APPROVED BY	CHECKED BY	DESIGNED BY	 Tolerance X.X ±0.50 X.XX±0.15 X° ±3°
ChenGuoqiang	XieLi	LvSenHua	
UNITS: mm SCALE: 1/1 REVISION: A			

3	FPC	22.0*22.2MM	FPC	FPC11255A,P01	1
2	Coaxial Cable	O.D. 0.81 Black	O.D. 0.81	COA100XXA,P01	1
1	Mini Connector	Au Plated Generation 1	Cu	TER10001A,P01	1
NO	PART NAME	DESCRIPTION	Material	Part Number	Q.TY



# Antenna Specification

<b>Electrical Properties</b>	
Frequency	2.4-2.5GHz
Impedance	50 Ohm Nominal
V.S.W.R	2.5 Max
Gain	2.3 dBi
Radiation	Omni-directional
Polarization	Linear
<b>Physical Properties</b>	
Connector	IPEX
Cable Type	O.D.0.81mm
Cable Length	90mm
Cable Color	Black
Operating Temp.	-40 ~ +85 °C
Storage Temp / Humidity	25±5°C / <70%



# Antenna Performance Test

**Agilent  
E5071B**

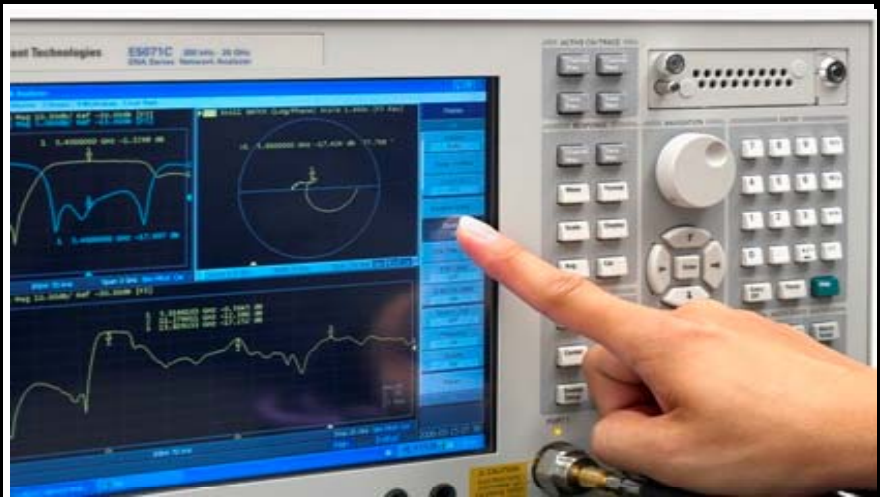

**S  
Parameter  
Test //  
2.4G  
Antenna**

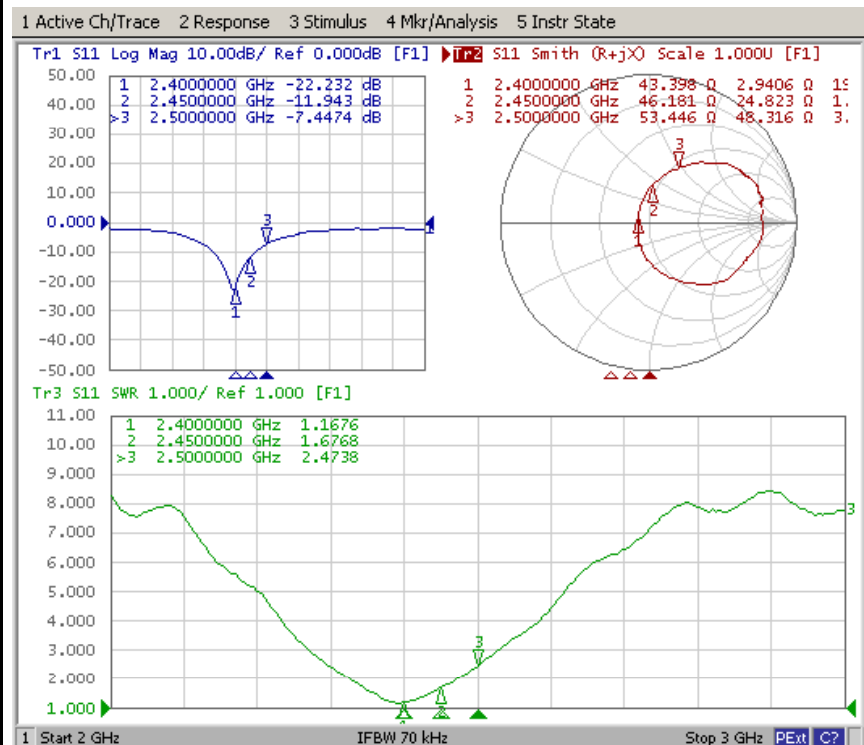



Passive Test For 2.4G Antenna			
Freq (MHz)	Effi (%)	Effi (dB)	Gain (dBi)
2400	46.0	-3.4	2.3
2410	47.0	-3.3	2.3
2420	47.4	-3.2	2.2
2430	49.2	-3.1	1.9
2440	49.3	-3.1	1.7
2450	49.6	-3.0	1.8
2460	49.6	-3.0	1.7
2470	47.9	-3.2	1.6
2480	47.5	-3.2	1.5
2490	47.0	-3.3	1.3
2500	46.6	-3.3	0.9

add: 17A-03A, Block B, Nanxian Commercial Plaza, Meilong Road, Longhua New District, Shenzhen



## Radiation Pattern For 2.4G Antenna

# 2400.000MHz

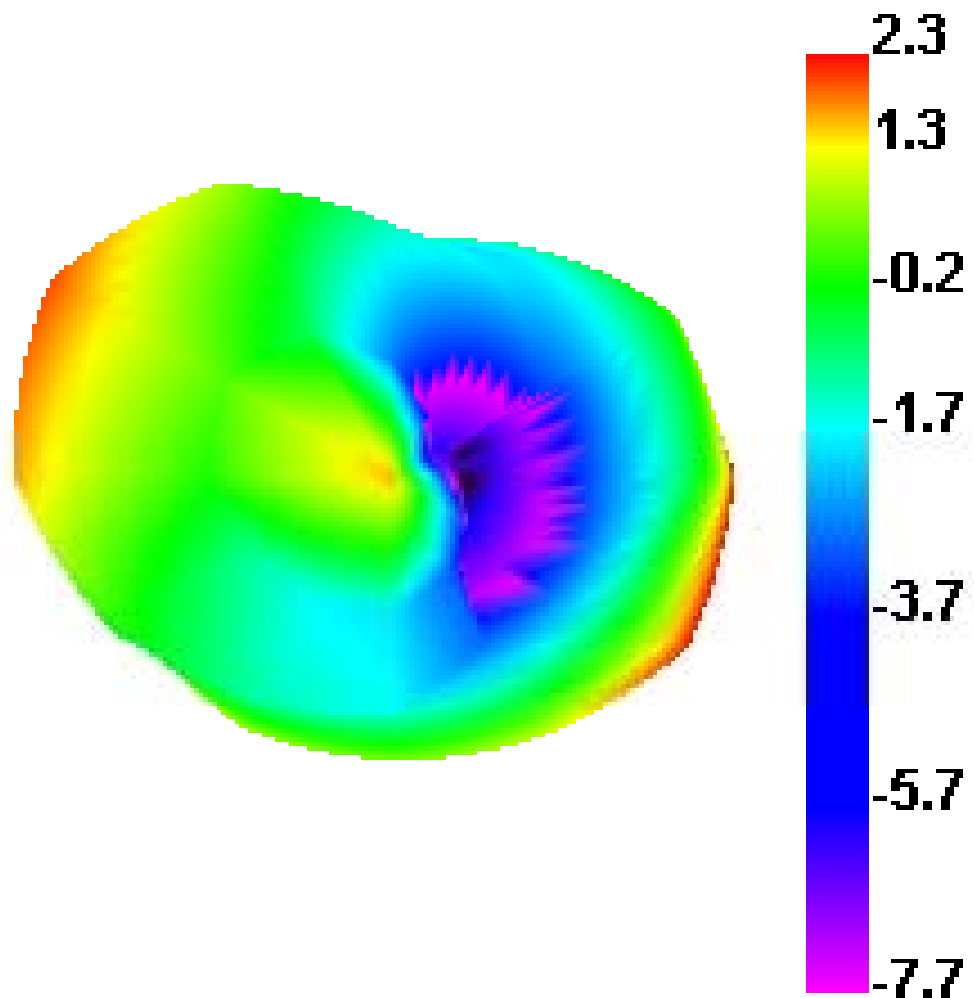



## Radiation Pattern For 2.4G Antenna

# 2400.000MHz H

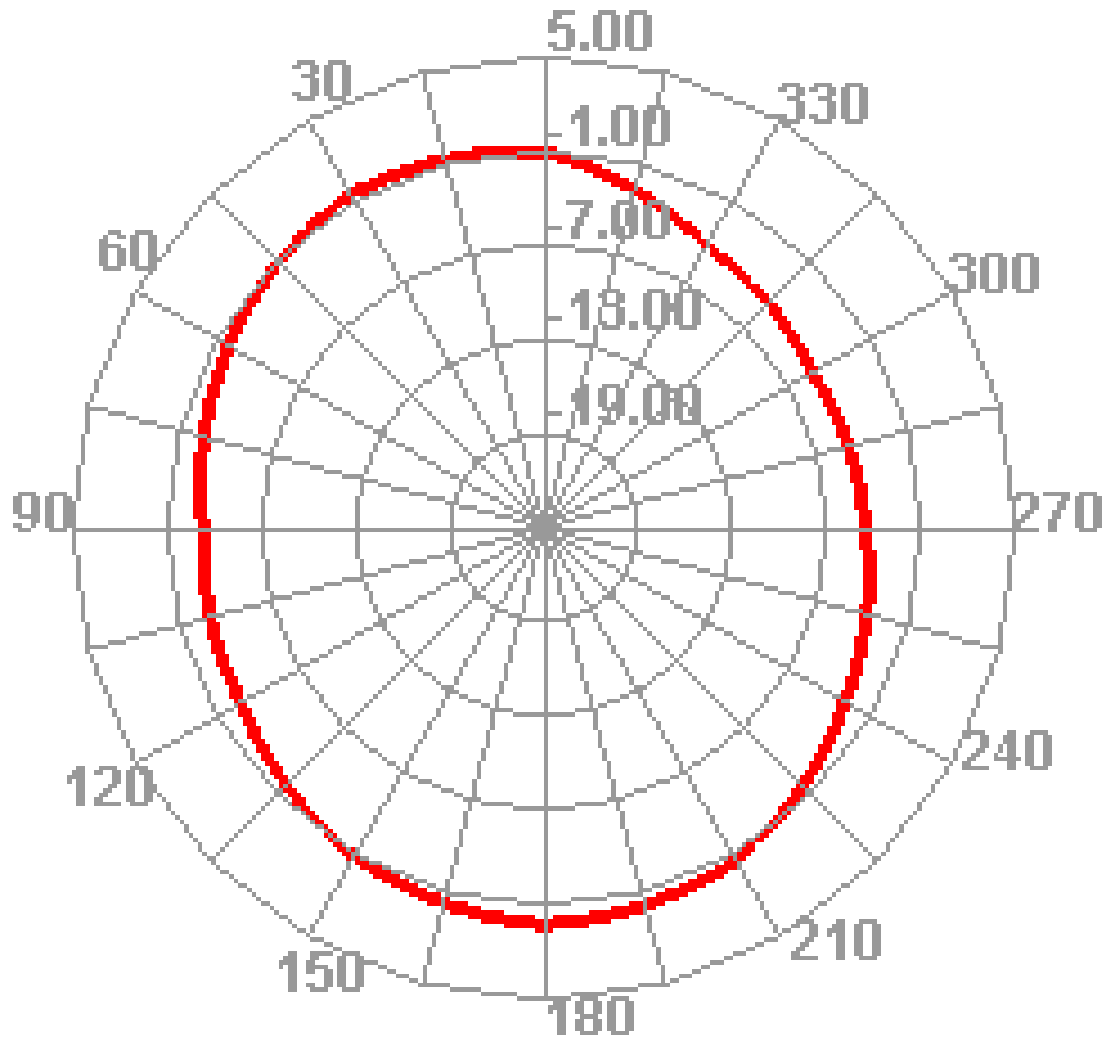





## Radiation Pattern For 2.4G Antenna

# 2400.000MHz E1

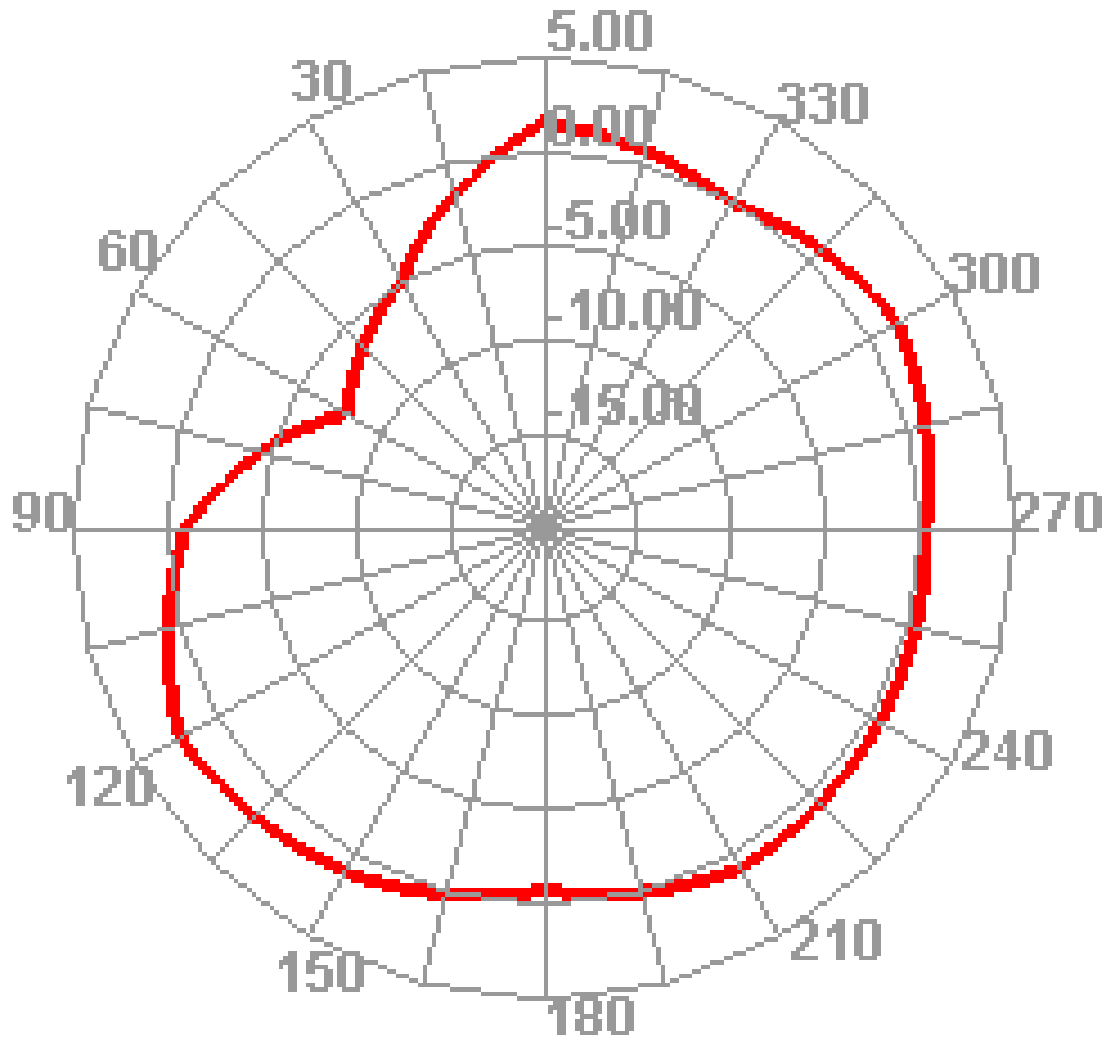



## Radiation Pattern For 2.4G Antenna

# 2400.000MHz E2

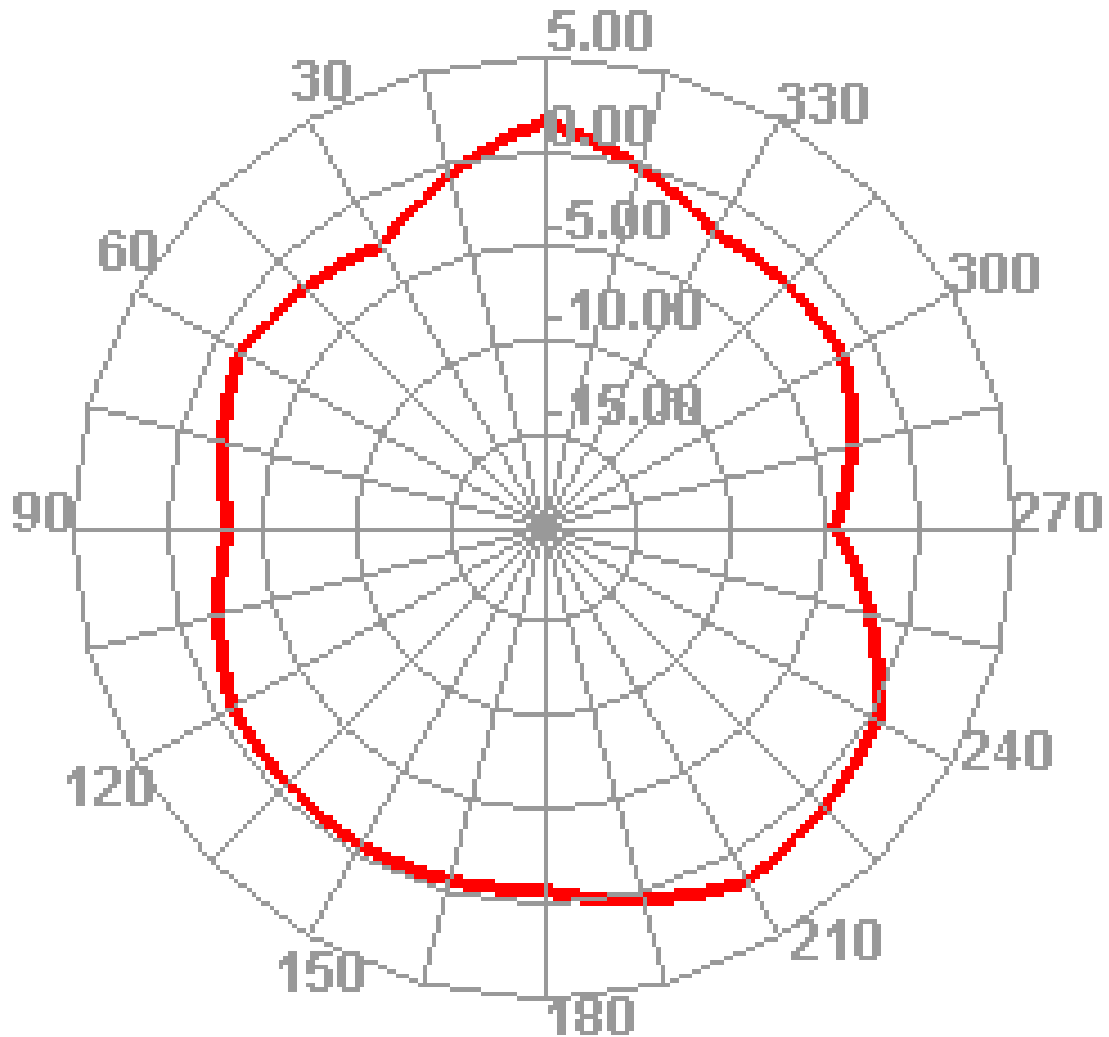



## Radiation Pattern For 2.4G Antenna

**2450.000MHz**

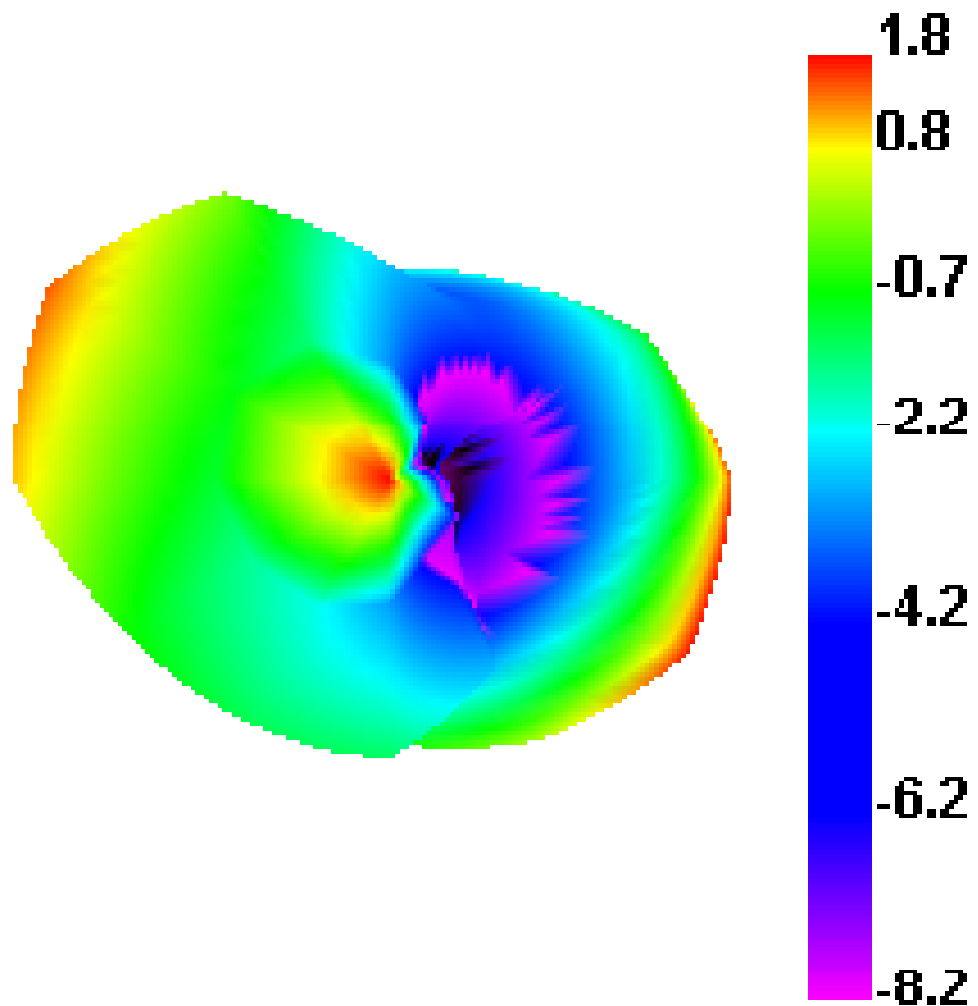



## Radiation Pattern For 2.4G Antenna

# 2450.000MHz H

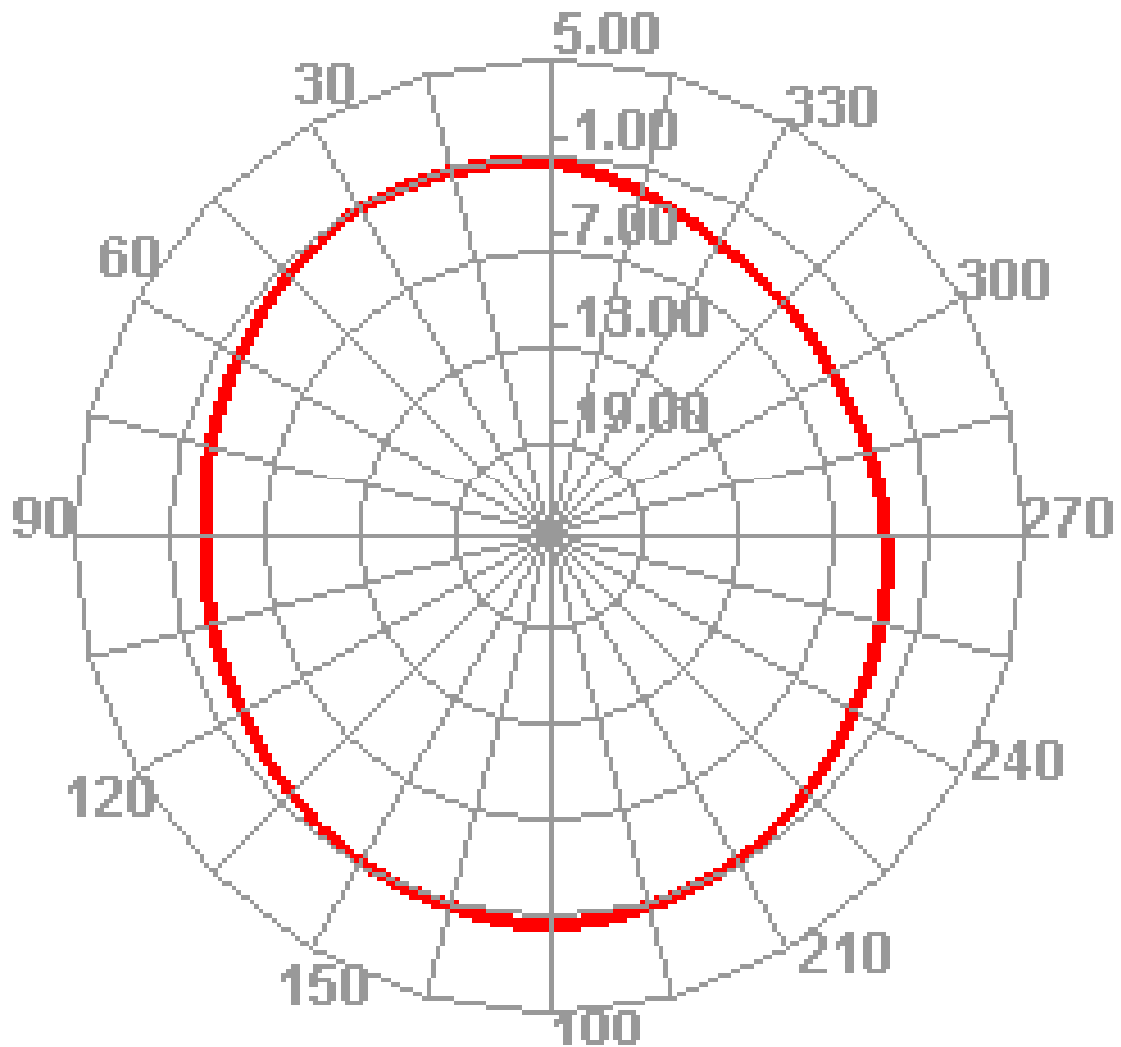



## Radiation Pattern For 2.4G Antenna

# 2450.000MHz E1

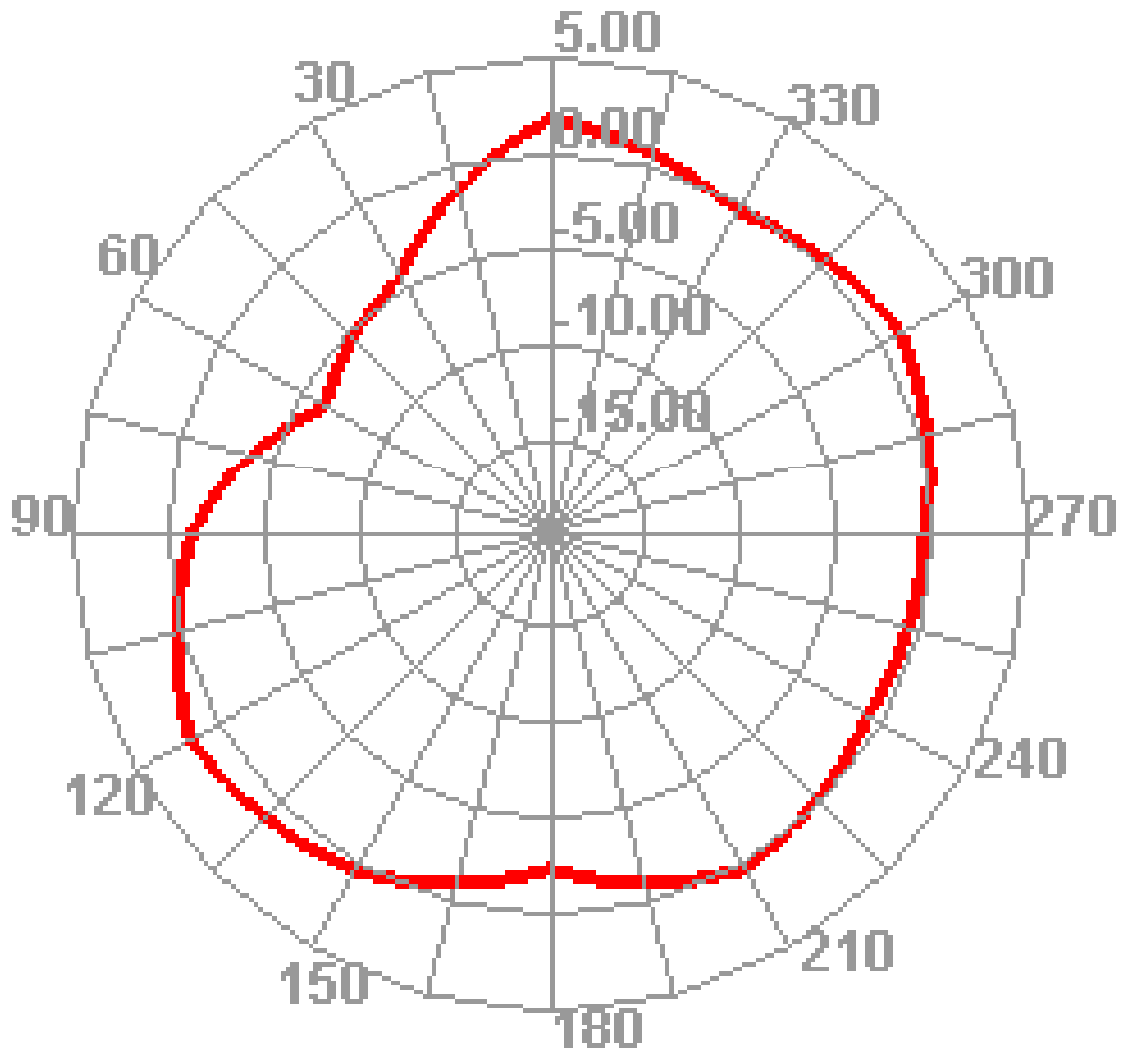



## Radiation Pattern For 2.4G Antenna

# 2450.000MHz E2

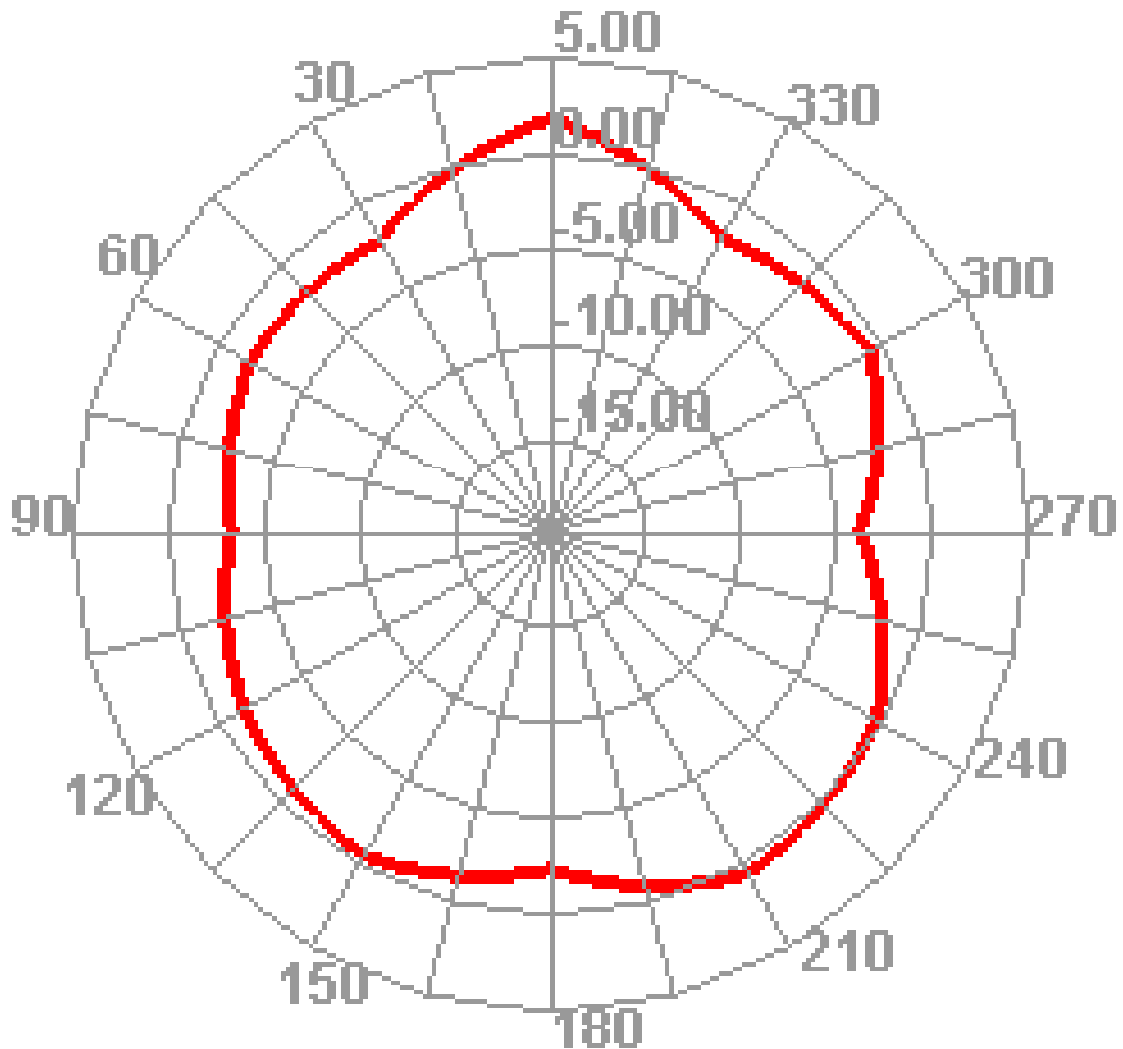



## Radiation Pattern For 2.4G Antenna

**2500.000MHz**

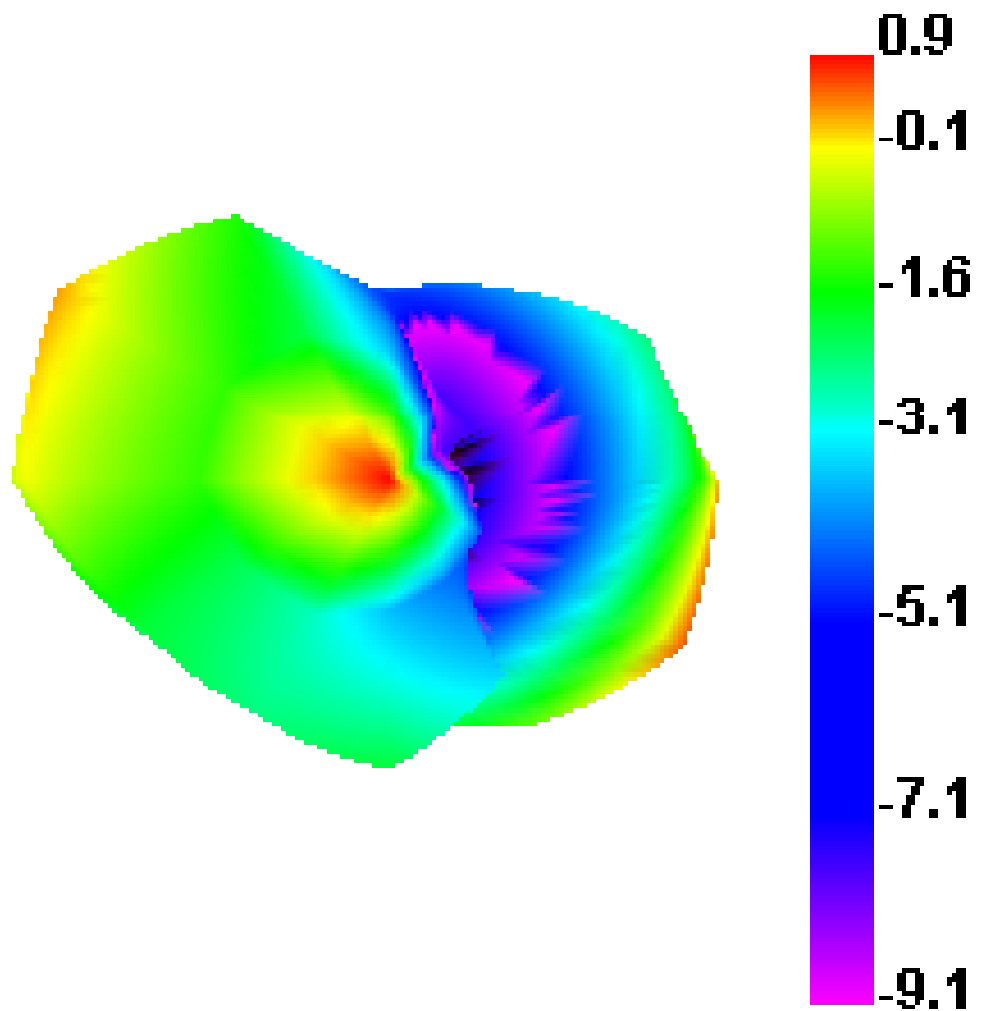



## Radiation Pattern For 2.4G Antenna

# 2500.000MHz H

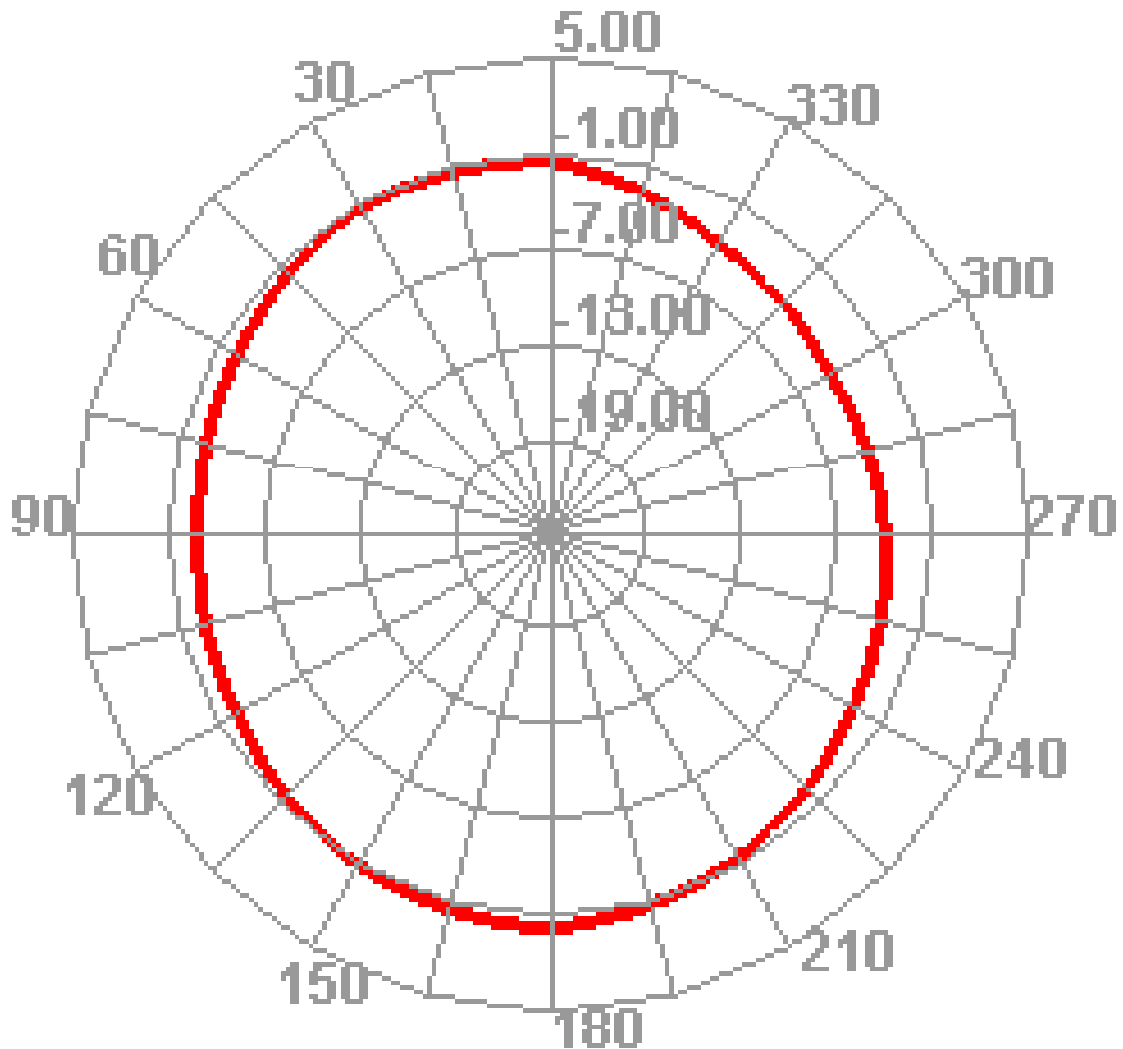





## Radiation Pattern For 2.4G Antenna

# 2500.000MHz E1

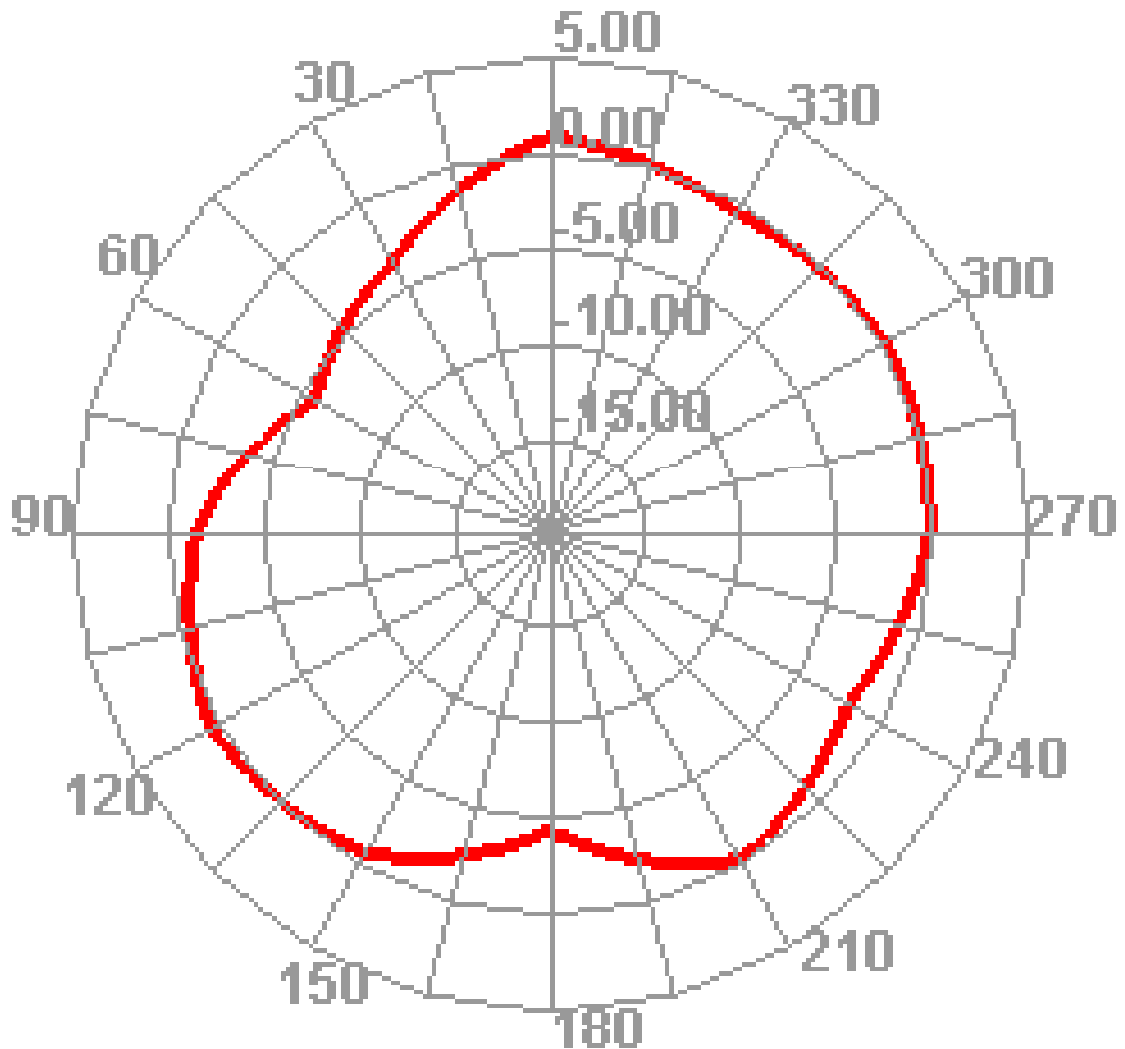



## Radiation Pattern For 2.4G Antenna

# 2500.000MHz E2

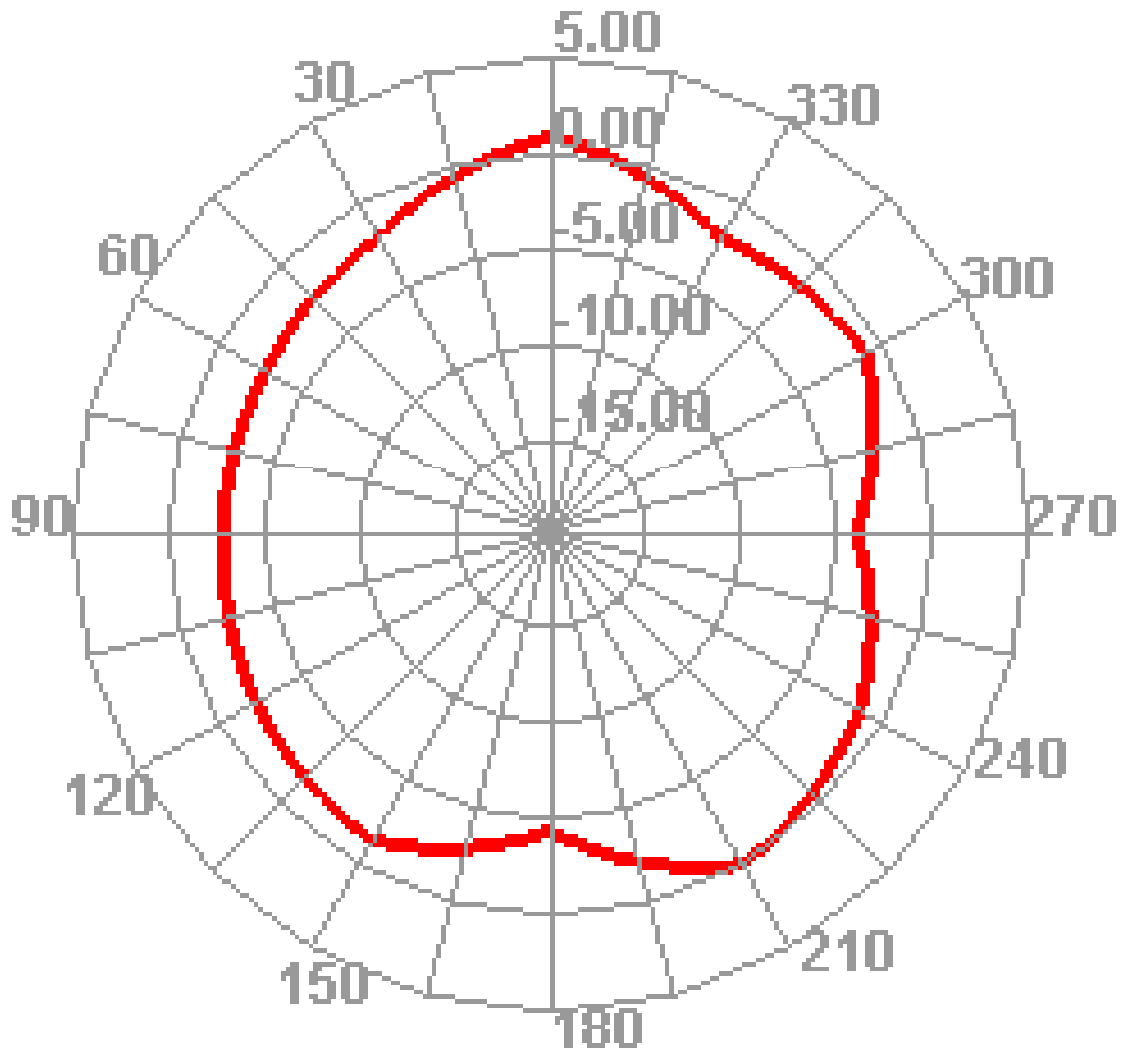



***Antenna***  
***2.4G***

