

FCC 47 CFR PART 15 SUBPART C
CERTIFICATION TEST REPORT

For

Bluetooth speaker

MODEL No.: XTSK004

FCC ID: 2ASHX-XTSK004

Trade Mark:N/A

REPORT NO:ES190109054W

ISSUE DATE:March 20, 2019

Prepared for

BEL USA,LLC.

12610 NW 115 Avenue, Bldg. 200 Medley, FL 33178, USA

Prepared by

EMTEK(SHENZHEN) CO., LTD.
Bldg 69, Majialong Industry Zone, NanshanDistrict,Shenzhen,
Guangdong, China
TEL: 86-755-26954280
FAX: 86-755-26954282

Table of Contents

1 TEST RESULT CERTIFICATION3

2 EUT TECHNICAL DESCRIPTION4

3 SUMMARY OF TEST RESULT.....6

4 TEST METHODOLOGY7

 4.1 GENERAL DESCRIPTION OF APPLIED STANDARDS7

 4.2 MEASUREMENT EQUIPMENT USED7

 4.3 DESCRIPTION OF TEST MODES8

5 FACILITIES AND ACCREDITATIONS9

 5.1 FACILITIES9

 5.2 LABORATORY ACCREDITATIONS AND LISTINGS9

6 TEST SYSTEM UNCERTAINTY10

7 SETUP OF EQUIPMENT UNDER TEST11

 7.1 RADIO FREQUENCY TEST SETUP 111

 7.2 RADIO FREQUENCY TEST SETUP 211

 7.3 CONDUCTED EMISSION TEST SETUP12

 7.4 SUPPORT EQUIPMENT13

8 FREQUENCY HOPPING SYSTEM REQUIREMENTS14

 8.1 STANDARD APPLICABLE14

 8.2 EUT PSEUDORANDOM FREQUENCY HOPPING SEQUENCE14

 8.3 EQUAL HOPPING FREQUENCY USE15

 8.4 FREQUENCY HOPPING SYSTEM.....15

9 TEST REQUIREMENTS.....16

 9.1 20DB BANDWIDTH16

 9.2 CARRIER FREQUENCY SEPARATION.....20

 9.3 NUMBER OF HOPPING FREQUENCIES24

 9.4 AVERAGE TIME OF OCCUPANCY (DWELL TIME)26

 9.5 MAXIMUM PEAK CONDUCTED OUTPUT POWER30

 9.6 CONDUCTED SUPRIOUS EMISSION34

 9.7 RADIATED SPURIOUS EMISSION.....41

 9.8 CONDUCTED EMISSION TEST.....54

 9.9 ANTENNA APPLICATION.....59

1 TEST RESULT CERTIFICATION

Applicant:	BEL USA,LLC. 12610 NW 115 Avenue, Bldg. 200 Medley, FL 33178, USA
Manufacture:	Shenzhen Kingstar Industrial Co., Ltd. #1 Floor, Building A, ZaiFeng Industrial Park, Shajing Town, Bao'an, Shenzhen, China
Product Description:	Bluetooth speaker
Model Number:	XTSK004
Trade Mark:	N/A
File Number:	ES190109054W
Date of Test:	January 9, 2019 to March 19, 2019

Measurement Procedure Used:

APPLICABLE STANDARDS	
STANDARD	TEST RESULT
FCC 47 CFR Part 2 2017, Subpart J FCC 47 CFR Part 15 2017, Subpart C	PASS

The above equipment was tested by EMTEK(SHENZHEN) CO., LTD.The test data, data evaluation, test procedures, and equipment configurations shown in this report were made in accordance with the procedures given in ANSI C63.10 (2013) and the energy emitted by the sample EUT tested as described in this report is in compliance with the requirements of FCC Rules Part 2 2017 and Part 15.247 2017

The test results of this report relate only to the tested sample identified in this report.

Date of Test : January 9, 2019 to March 19, 2019

Prepared by: 
YihuXiong/Editor

Reviewer: 
Joe Xia/Supervisor



Approve & Authorized Signer : 
Lisa Wang/Manager

2 MODIFIED INFORMATION

Version	Report No.	Revision Data	Summary
Ver.1.0	ES190109054W	/	Original Version

3 GENERAL INFORMATION

3.1 EUT TECHNICAL DESCRIPTION

Characteristics	Description
Product Name	Bluetooth speaker
Model number	XTSK004
Device Type	4.2 BT Signal mode
Data Rate	1Mbps for GFSK modulation 2Mbps for pi/4-DQPSK modulation
Modulation	GFSK modulation (1Mbps) pi/4-DQPSK modulation (2Mbps)
Operating Frequency Range	2402-2480MHz
Number of Channels	79 channels
Max Transmit Power	1.73dBm
Antenna Type	PCB Antenna
Gain	0.94 dBi
Power supply	<input checked="" type="checkbox"/> DC supply: DC 3.7V
Temperature Range	-20°C ~ +70°C

3.2 INPUT / OUTPUT PORTS

Port #	Name	Type*	Cable Max. >3m	Cable Shielded	Comments
1	Enclosure	N/E	--	--	None
2	Type-C port	I/O	No	Shielded(1.2m)	1 ports

* Note: For the purposes of the present document, the following symbols apply:

AC	AC Power Port
DC	DC Power Port
N/E	Non-Electrical
I/O	Signal Input or Output Port (Not Involved in Process Control)
TP	Telecommunication Ports

4 SUMMARY OF TEST RESULT

FCC PartClause	Test Parameter	Verdict	Remark
15.247(a)(1)	20 dB Bandwidth	PASS	
15.247(a)(1)	Carrier Frequency Separation	PASS	
15.247(a)(iii)	Number of Hopping Frequencies	PASS	
15.247(a)(iii)	Average Time of Occupancy (Dwell Time)	PASS	
15.247(b)(1)	Maximum Peak Conducted Output Power	PASS	
15.247(d)	Conducted Spurious Emissions	PASS	
15.205 15.209	Radiated Spurious Emissions	PASS	
15.207	Conducted Emission	PASS	
15.203	Antenna Application	PASS	
NOTE 1:N/A (Not Applicable)			

RELATED SUBMITTAL(S) / GRANT(S):

This submittal(s) (test report) is intended for FCC ID: 2ASHX-XTSK004 filing to comply with Section 15.247 of the FCC Part 15, Subpart C.

5 TEST METHODOLOGY

5.1 GENERAL DESCRIPTION OF APPLIED STANDARDS

According to its specifications, the EUT must comply with the requirements of the following standards:

FCC 47 CFR Part 2, Subpart J

FCC 47 CFR Part 15, Subpart C

558074 D01 15.247 Meas Guidance V05r01

5.2 MEASUREMENT EQUIPMENT USED

5.2.1 Radiated Emission Test Equipment

EQUIPMENT TYPE	MFR	MODEL NUMBER	SERIAL NUMBER	LAST CAL.	DUE CAL.
EMI Test Receiver	Rohde & Schwarz	ESU	1302.6005.26	May 20, 2018	May 20, 2019
Pre-Amplifier	HP	8447F	2944A07999	May 19, 2018	May 18, 2019
Bilog Antenna	Schwarzbeck	VULB9163	142	May 19, 2018	May 18, 2019
Loop Antenna	ARA	PLA-1030/B	1029	May 19, 2018	May 18, 2019
Horn Antenna	Schwarzbeck	BBHA 9170	BBHA9170399	May 20, 2018	May 19, 2019
Horn Antenna	Schwarzbeck	BBHA 9120	D143	May 19, 2018	May 18, 2019
Cable	Schwarzbeck	AK9513	ACRX1	May 20, 2018	May 19, 2019
Cable	Rosenberger	N/A	FP2RX2	May 20, 2018	May 19, 2019
Cable	Schwarzbeck	AK9513	CRPX1	May 20, 2018	May 19, 2019
Cable	Schwarzbeck	AK9513	CRRX2	May 20, 2018	May 19, 2019

5.2.2 Radio Frequency Test Equipment

EQUIPMENT TYPE	MFR	MODEL NUMBER	SERIAL NUMBER	LASTCAL.	DUE CAL.
EMI Test Receiver	Rohde & Schwarz	ESU	1302.6005.26	May 20, 2018	May 19, 2019
Spectrum Analyzer	Agilent	E4407B	88156318	May 20, 2018	May 19, 2019
Signal Analyzer	Agilent	N9010A	My53470879	May 20, 2018	May 19, 2019
Power meter	Anritsu	ML2495A	0824006	May 20, 2018	May 19, 2019
Power sensor	Anritsu	MA2411B	0738172	May 20, 2018	May 19, 2019

5.2.3 Conducted Emission Test Equipment

EQUIPMENT TYPE	MFR	MODEL NUMBER	SERIAL NUMBER	LAST CAL.	DUE CAL.
Test Receiver	Rohde & Schwarz	ESCS30	828985/018	May 20, 2018	May 19, 2019
L.I.S.N.	Schwarzbeck	NNLK8129	8129-203	May 20, 2018	May 19, 2019
50Ω Coaxial Switch	Anritsu	MP59B	M20531	May 20, 2018	May 19, 2019

Remark: Each piece of equipment is scheduled for calibration once a year.

5.3 DESCRIPTION OF TEST MODES

The EUT has been tested under its typical operating condition.

The EUT configuration for testing is installed on RF field strength measurement to meet the Commissions requirement and operating in a manner which intends to maximize its emission characteristics in a continuous normal application.

The Transmitter was operated in the normal operating mode. The TX frequency was fixed which was for the purpose of the measurements.

Test of channel included the lowest and middle and highest frequency to perform the test, then record on this report.

Those data rates (1Mbps for Bluetooth GFSK modulation; 2Mbps for Bluetooth pi/4-DQPSK modulation) were used for all test.

Pre-defined engineering program for regulatory testing used to control the EUT for staying in continuous transmitting and receiving mode is programmed.

Frequency and Channel list for Bluetooth V4.2 Signal mode

Channel	Frequency (MHz)	Channel	Frequency (MHz)	Channel	Frequency (MHz)
0	2402	39	2441
1	2403	40	2442	76	2478
2	2404	41	2443	77	2479
...	78	2480

Note: $f_c = 2402\text{MHz} + (k-1) \times 1\text{MHz}$ k=1 to 79

Test Frequency and channel for Bluetooth V4.2 Signal mode

Lowest Frequency		Middle Frequency		Highest Frequency	
Channel	Frequency (MHz)	Channel	Frequency (MHz)	Channel	Frequency (MHz)
0	2402	39	2441	78	2480

6 FACILITIES AND ACCREDITATIONS

6.1 FACILITIES

All measurement facilities used to collect the measurement data are located at

Bldg 69, Majialong Industry Zone District, Nanshan District, Shenzhen, China

The sites are constructed in conformance with the requirements of ANSI C63.7, ANSI C63.10 and CISPR Publication 22.

6.2 LABORATORY ACCREDITATIONS AND LISTINGS

Site Description

EMC Lab. : Accredited by CNAS, 2018.11.30
The certificate is valid until 2022.10.28
The Laboratory has been assessed and proved to be in compliance with
CNAS-CL01:2018 (identical to ISO/IEC 17025:2017)
The Certificate Registration Number is L2291.

Accredited by TUV Rheinland Shenzhen 2016.5.19
The Laboratory has been assessed according to the requirements
ISO/IEC 17025.

Accredited by FCC, August 06, 2018
The certificate is valid until August 07, 2020
Designation Number: CN1204
Test Firm Registration Number: 882943

Accredited by A2LA, August 08, 2018
The certificate is valid until August 31, 2020
The Certificate Number is 4321.01.

Name of Firm : EMTEK (SHENZHEN) CO., LTD.
Site Location : Bldg 69, Majialong Industry Zone, Nanshan District, Shenzhen,
Guangdong, China

6.3 TEST SOFTWARE

Item	Software
Conducted Emission	: EMTEK(Ver.CON-03A1)-Shenzhen
Radiated Emission	: EMTEK(Ver.RA-03A1)-Shenzhen

7 TEST SYSTEM UNCERTAINTY

The following measurement uncertainty levels have been estimated for tests performed on the apparatus:

Parameter	Uncertainty
Radio Frequency	$\pm 1 \times 10^{-5}$
Maximum Peak Output Power Test	$\pm 1.0\text{dB}$
Conducted Emissions Test	$\pm 2.0\text{dB}$
Radiated Emission Test	$\pm 2.0\text{dB}$
Occupied Bandwidth Test	$\pm 1.0\text{dB}$
Band Edge Test	$\pm 3\text{dB}$
All emission, radiated	$\pm 3\text{dB}$
Antenna Port Emission	$\pm 3\text{dB}$
Temperature	$\pm 0.5^\circ\text{C}$
Humidity	$\pm 3\%$

Measurement Uncertainty for a level of Confidence of 95%

8 SETUP OF EQUIPMENT UNDER TEST

8.1 RADIO FREQUENCY TEST SETUP 1

The Bluetooth component's antenna ports(s) of the EUT are connected to the measurement instrument per an appropriate attenuator. The EUT is controlled by PC/software to emit the specified signals for the purpose of measurements.

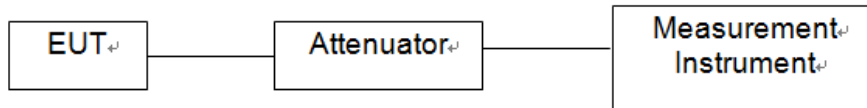

8.2 RADIO FREQUENCY TEST SETUP 2

The test site semi-anechoic chamber has met the requirement of NSA tolerance 4 dB according to the standards: ANSI C63.10. The test distance is 3m. The setup is according to the requirements in Section 13.1.4.1 of ANSI C63.10-2013 and CAN/CSA-CEI/IEC CISPR 22.

Below 30MHz:

The EUT is placed on a turntable 0.8 meters above the ground in the chamber, 3 meter away from the antenna (loop antenna). The Antenna should be positioned with its plane vertical at the specified distance from the EUT and rotated about its vertical axis for maximum response at each azimuth about the EUT. The center of the loop shall be 1 m above the ground. For certain applications, the loop antenna plane may also need to be positioned horizontally at the specified distance from the EUT.

30MHz-1GHz:

The EUT is placed on a turntable 0.8 meters above the ground in the chamber, 3 meter away from the antenna. The maximal emission value is acquired by adjusting the antenna height, polarisation and turntable azimuth. Normally, the height range of antenna is 1 m to 4 m, the azimuth range of turntable is 0° to 360°, and the receive antenna has two polarizations Vertical (V) and Horizontal (H).

Above 1GHz:

The EUT is placed on a turntable 1.5 meters above the ground in the chamber, 3 meter away from the antenna. The maximal emission value is acquired by adjusting the antenna height, polarisation and turntable azimuth. Normally, the height range of antenna is 1 m to 4 m, the azimuth range of turntable is 0° to 360°, and the receive antenna has two polarizations Vertical (V) and Horizontal (H).

(a) Radiated Emission Test Set-Up, Frequency Below 30MHz

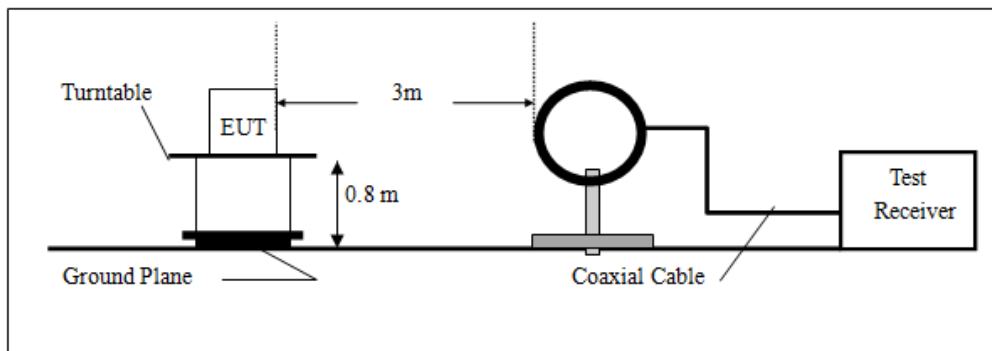

(b) Radiated Emission Test Set-Up, Frequency Below 1000MHz

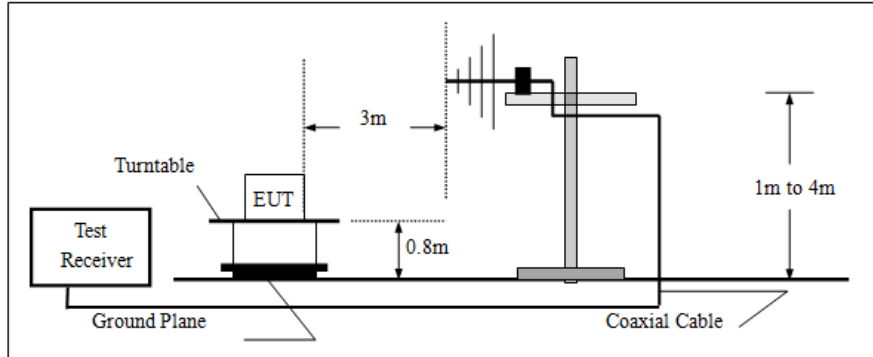

(c) Radiated Emission Test Set-Up, Frequency above 1000MHz

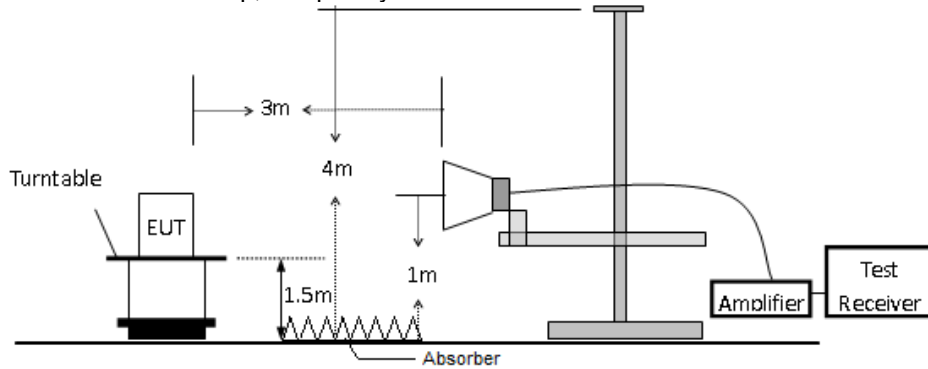

8.3 CONDUCTED EMISSION TEST SETUP

The mains cable of the EUT (Game fitness board) must be connected to LISN. The LISN shall be placed 0.8 m from the boundary of EUT and bonded to a ground reference plane for LISN mounted on top of the ground reference plane. This distance is between the closest points of the LISN and the EUT. All other units of the EUT and associated equipment shall be at least 0.8m from the LISN.

Ground connections, where required for safety purposes, shall be connected to the reference ground point of the LISN and, where not otherwise provided or specified by the manufacturer, shall be of same length as the mains cable and run parallel to the mains connection at a separation distance of not more than 0.1 m.

According to the requirements in Section 13.1.4.1 of ANSI C63.10-2013 Conducted emissions from the EUT measured in the frequency range between 0.15 MHz and 30 MHz using CISPR Quasi-Peak and average detector mode.

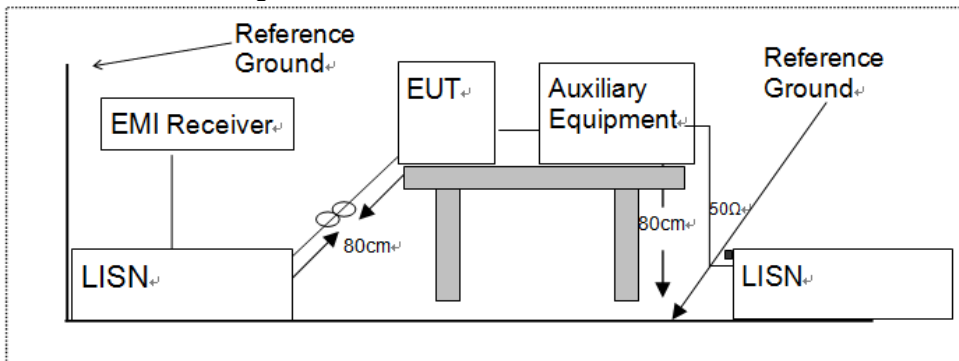

8.4 SUPPORT EQUIPMENT

EUT Cable List and Details			
Cable Description	Length (m)	Shielded/Unshielded	With / Without Ferrite
/	/	/	/

Auxiliary Cable List and Details			
Cable Description	Length (m)	Shielded/Unshielded	With / Without Ferrite
/	/	/	/

Auxiliary Equipment List and Details			
Description	Manufacturer	Model	Serial Number
iPhone	Apple	iPhone 5C/A1526	N/A
Adapter	huawei	HW-059200CHQ	N/A

Notes:

1. All the equipment/cables were placed in the worst-case configuration to maximize the emission during the test.
2. Grounding was established in accordance with the manufacturer's requirements and conditions for the intended use.

9 FREQUENCY HOPPING SYSTEM REQUIREMENTS

9.1 Standard Applicable

According to FCC Part 15.247(a)(1), The system shall hop to channel frequencies that are selected at the system hopping rate from a pseudo randomly ordered list of hopping frequencies. Each frequency must be used equally on the average by each transmitter. The system receivers shall have input bandwidths that match the hopping channel bandwidths of their corresponding transmitters and shall shift frequencies in synchronization with the transmitted signals.

(g) Frequency hopping spread spectrum systems are not required to employ all available hopping channels during each transmission. However, the system, consisting of both the transmitter and the receiver, must be designed to comply with all of the regulations in this section should the transmitter be presented with a continuous data (or information) stream. In addition, a system employing short transmission bursts must comply with the definition of a frequency hopping system and must distribute its transmissions over the minimum number of hopping channels specified in this section.

(h) The incorporation of intelligence within a frequency hopping spread spectrum system that permits the system to recognize other users within the spectrum band so that it individually and independently chooses and adapts its hopsets to avoid hopping on occupied channels is permitted. The coordination of frequency hopping systems in any other manner for the express purpose of avoiding the simultaneous occupancy of individual hopping frequencies by multiple transmitters is not permitted.

9.2 EUT Pseudorandom Frequency Hopping Sequence

The channel is represented by a pseudo-random hopping sequence hopping through the 79 RF channels. The hopping sequence is unique for the piconet and is determined by the Bluetooth device address of the master; the phase in the hopping sequence is determined by the Bluetooth clock of the master. The channel is divided into time slots where each slot corresponds to an RF hop frequency. Consecutive hops correspond to different RF hop frequencies. The normal hop is 1 600 hops/s.

The pseudorandom sequence may be generated in a nine-stage shift register whose 5th and 9th stage outputs are added in a modulo-two addition stage, and the result is fed back to the input of the first stage. The sequence begins with the first ONE of 9 consecutive ONES; i.e. the shift register is initialized with nine ones. Number of shift register stages: 9
Length of pseudo-random sequence: $2^9 - 1 = 511$ bits
Longest sequence of zeros: 8 (non-inverted signal)

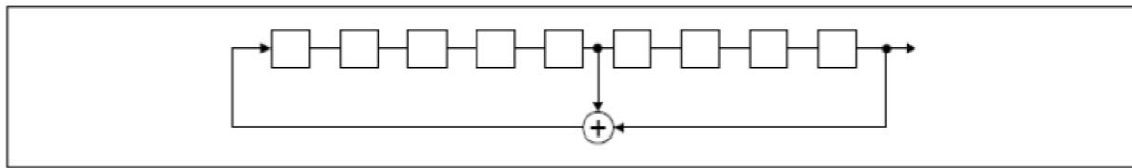

Linear Feedback Shift Register for Generation of the PRBS sequence

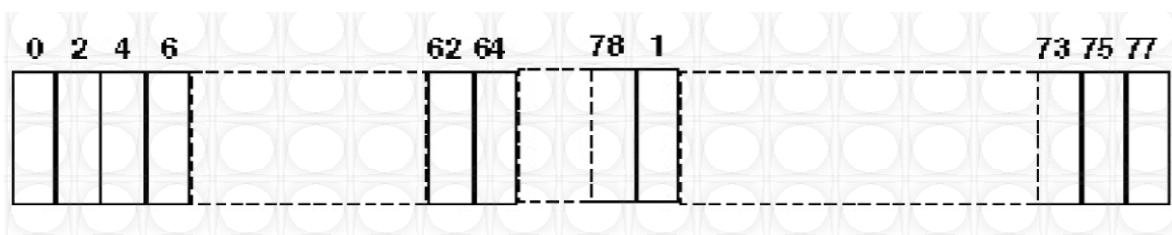

Each frequency used equally on the average by each transmitter.

The system receiver have input bandwidths that match the hopping channel bandwidths of their corresponding transmitters and shift frequencies in synchronization with the transmitted signals.

9.3 Equal Hopping Frequency Use

All Bluetooth units participating in the piconet are time and hop-synchronized to the channel.

Example of a 79 hopping sequence in data mode:

35, 27, 6, 44, 14, 61, 74, 32, 1, 11, 23, 2, 55, 65, 29, 3, 9, 52, 78, 58, 40, 25, 0, 7, 18, 26, 76, 60, 47, 50, 2, 5, 16, 37, 70, 63, 66, 54, 20, 13, 4, 8, 15, 21, 26, 10, 73, 77, 67, 69, 43, 24, 57, 39, 46, 72, 48, 33, 17, 31, 75, 19, 41, 62, 68, 28, 51, 66, 30, 56, 34, 59, 71, 22, 49, 64, 38, 45, 36, 42, 53

Each Frequency used equally on the average by each transmitter

9.4 Frequency Hopping System

This transmitter device is frequency hopping device, and complies with FCC part 15.247 rule.

This device uses Bluetooth radio which operates in 2400-2483.5 MHz band. Bluetooth uses a radio technology called frequency-hopping spread spectrum, which chops up the data being sent and transmits chunks of it on up to 79 bands (1 MHz each; centred from 2402 to 2480 MHz) in the range 2,400-2,483.5 MHz. The transmitter switches hop frequencies 1,600 times per second to assure a high degree of data security. All Bluetooth devices participating in a given piconet are synchronized to the frequency-hopping channel for the piconet. The frequency hopping sequence is determined by the master's device address and the phase of the hopping sequence (the frequency to hop at a specific time) is determined by the master's internal clock. Therefore, all slaves in a piconet must know the master's device address and must synchronize their clocks with the master's clock.

Adaptive Frequency Hopping (AFH) was introduced in the Bluetooth specification to provide an effective way for a Bluetooth radio to counteract normal interference. AFH identifies "bad" channels, where either other wireless devices are interfering with the Bluetooth signal or the Bluetooth signal is interfering with another device. The AFH-enabled Bluetooth device will then communicate with other devices within its piconet to share details of any identified bad channels. The devices will then switch to alternative available "good" channels, away from the areas of interference, thus having no impact on the bandwidth used.

Test Model	20dB Bandwidth	
	Channel 0: 2402MHz	GFSKModulation

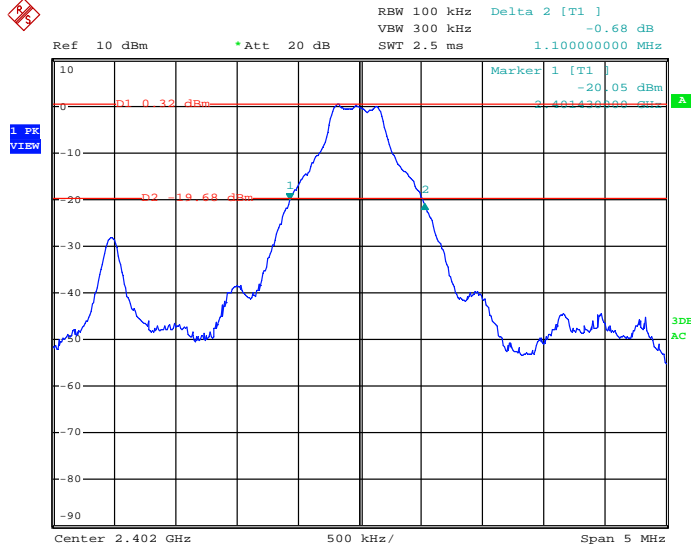

Date: 13.MAR.2019 10:44:46

Test Model	20dB Bandwidth	
	Channel 39: 2441MHz	GFSKModulation

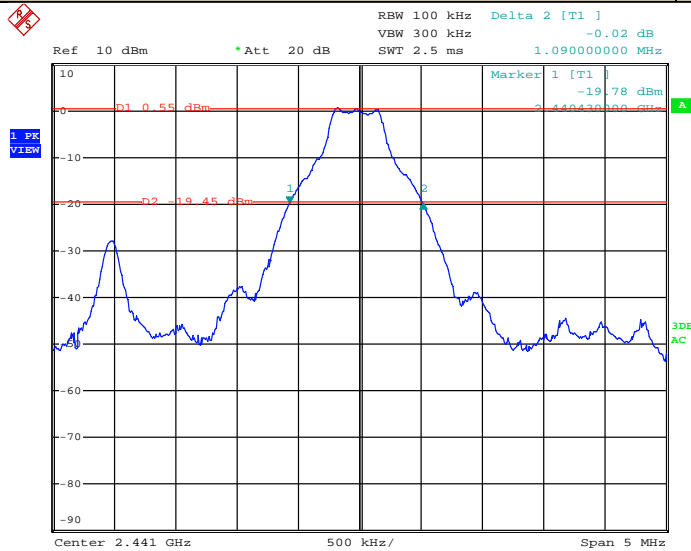

Date: 13.MAR.2019 10:46:11

Test Model	20dB Bandwidth	
	Channel 78: 2480MHz	GFSKModulation

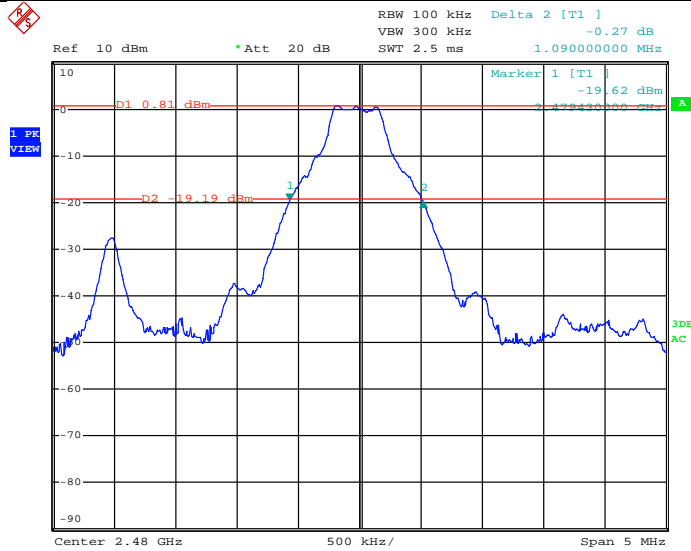

Date: 13.MAR.2019 10:47:35

Test Model	20dB Bandwidth	
	Channel 0: 2402MHz	pi/4-DQPSKModulation

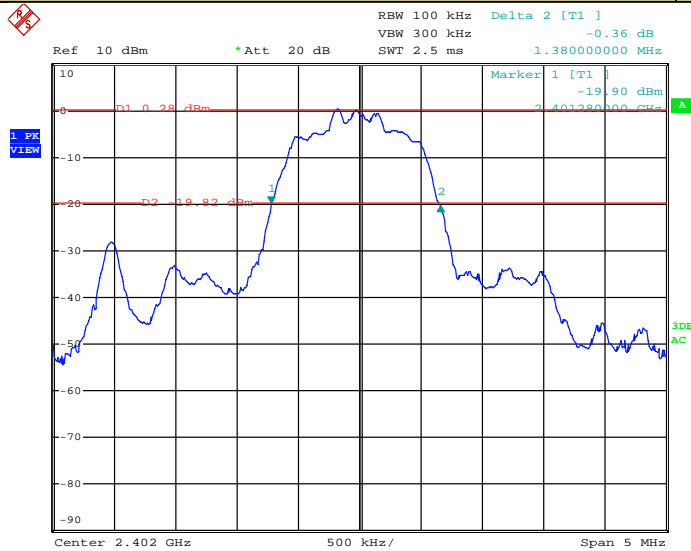

Date: 13.MAR.2019 10:41:29

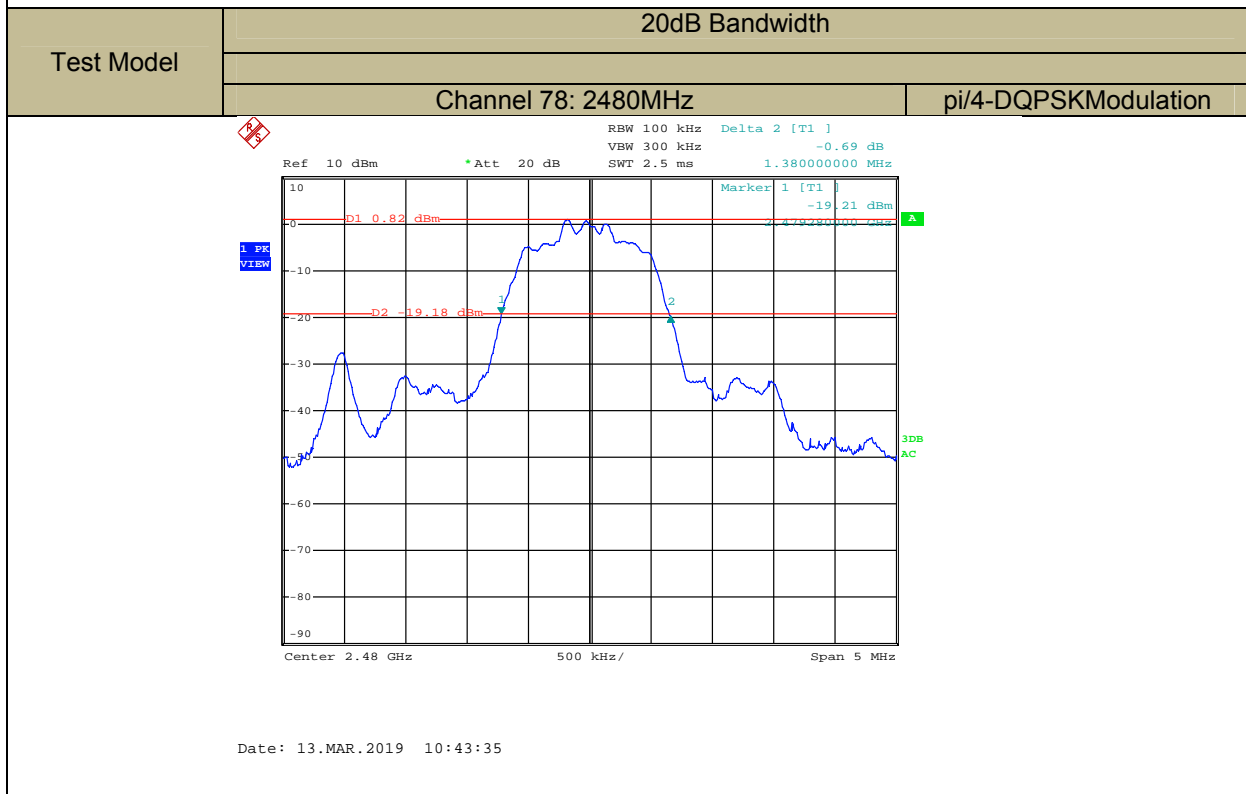
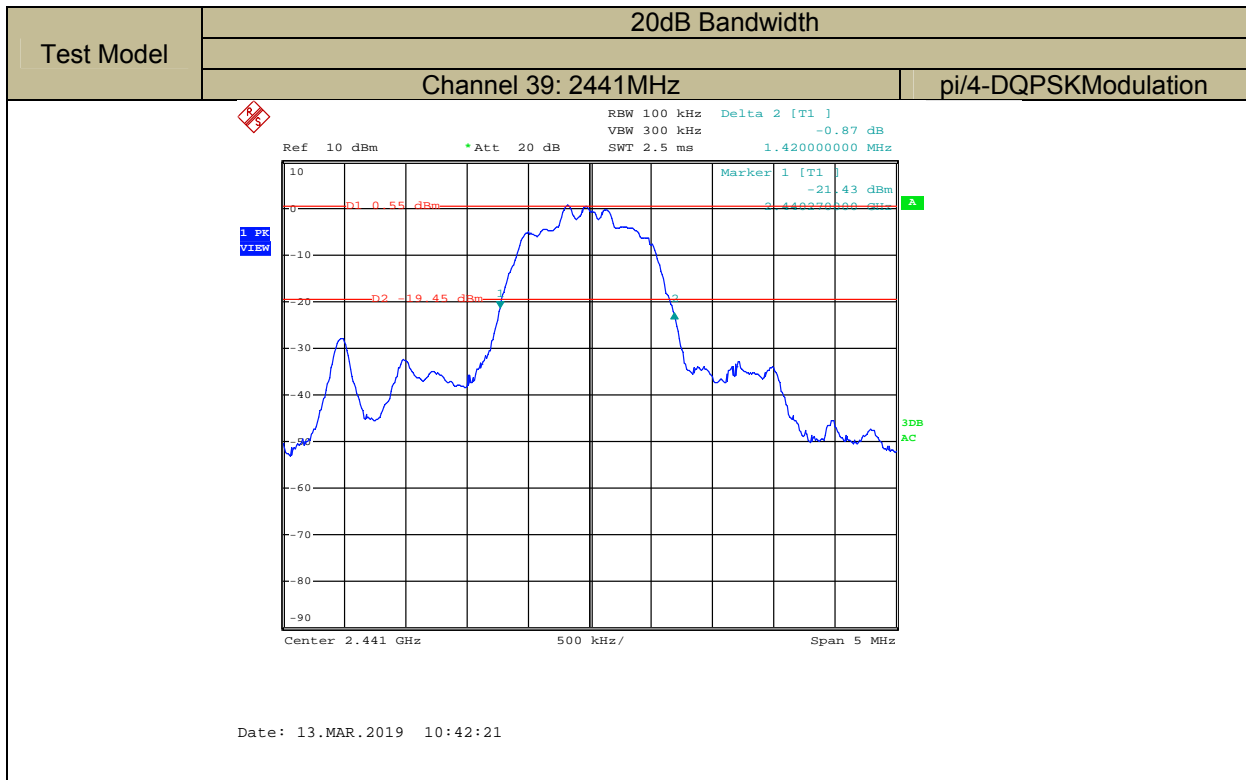

Test Model	Carrier Frequency Separation	
	Channel 0: 2402MHz	GFSKModulation

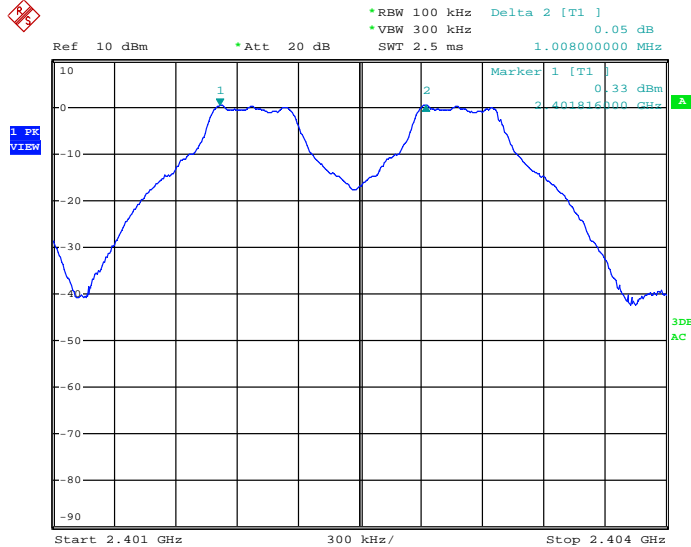

Date: 13.MAR.2019 11:04:06

Test Model	Carrier Frequency Separation	
	Channel 39: 2441MHz	GFSKModulation

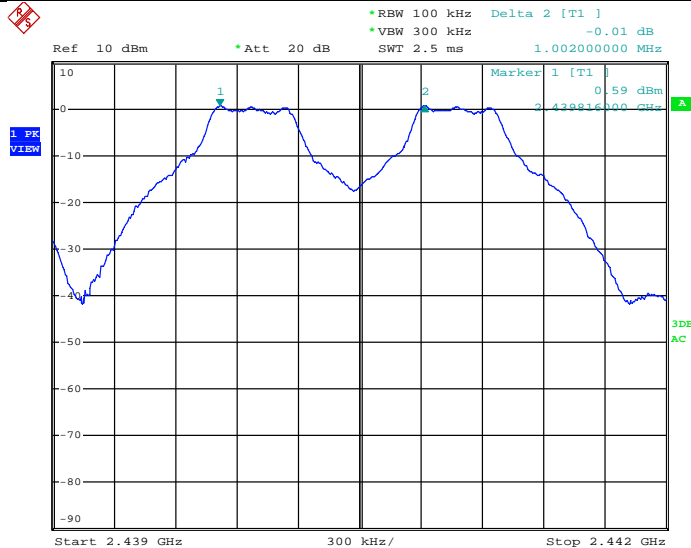

Date: 13.MAR.2019 11:04:50

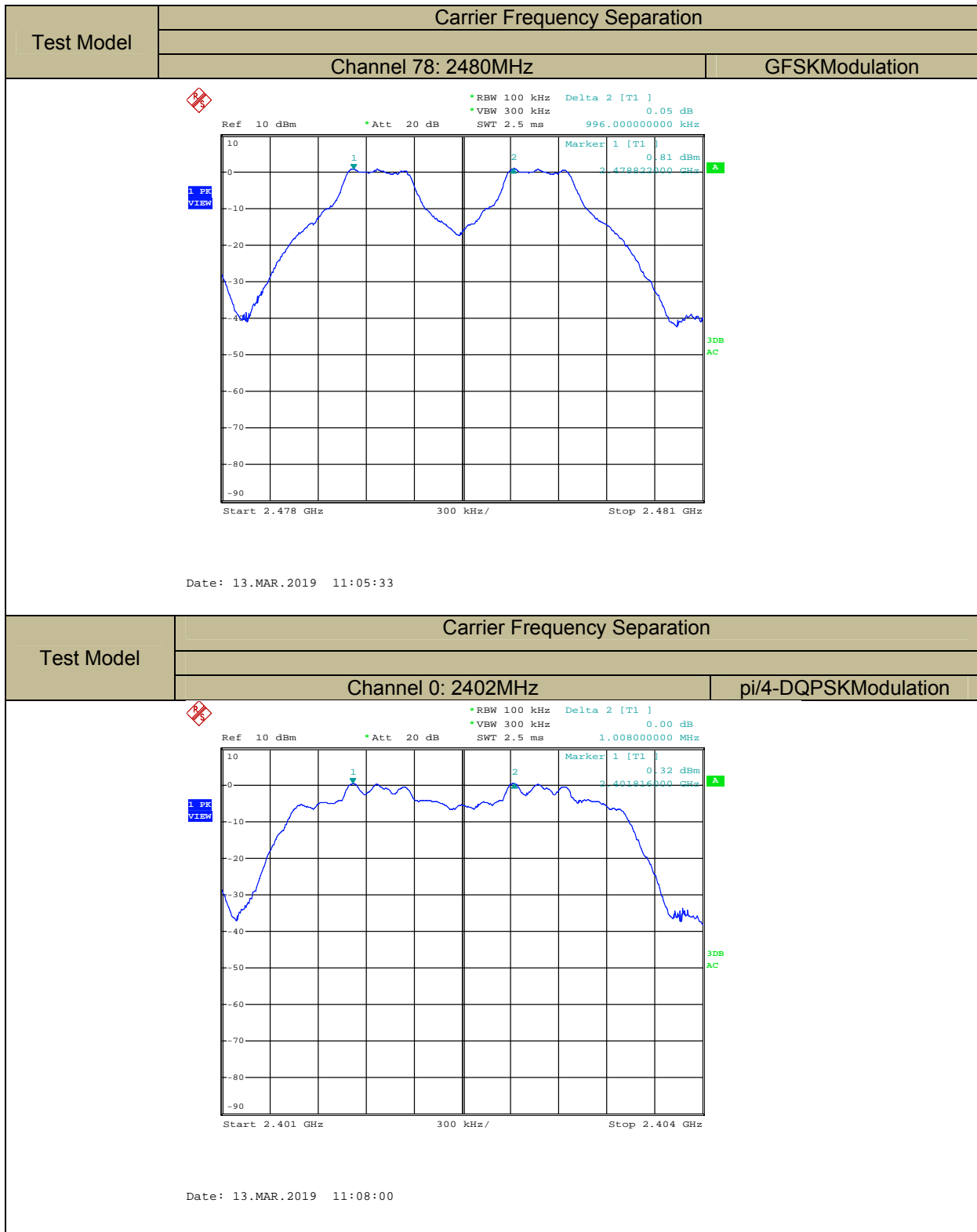

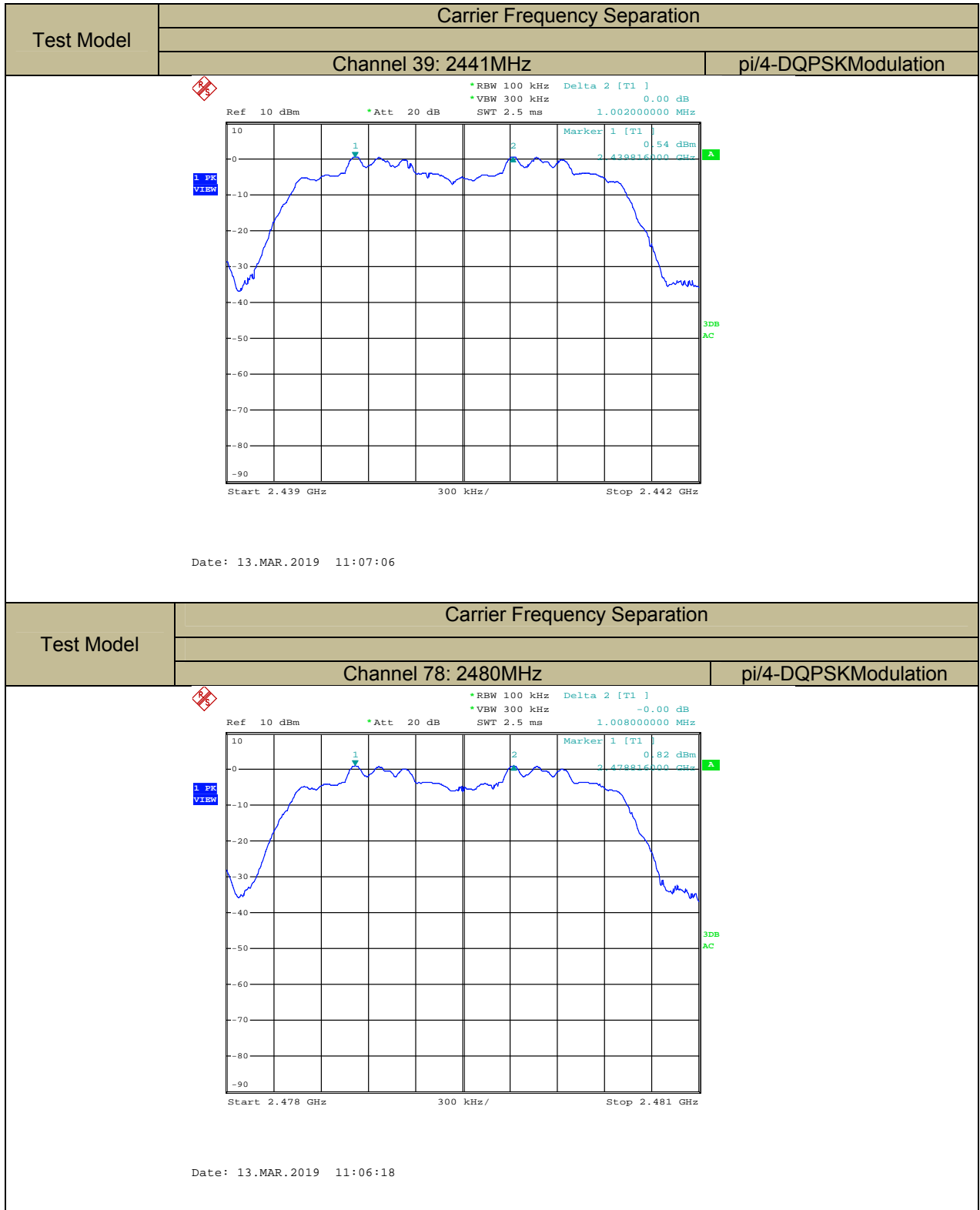

10.3 NUMBER OF HOPPING FREQUENCIES

10.3.1 Applicable Standard

According to FCC Part 15.247(a)(1) (iii)and 558074 D01 15.247 Meas Guidance V05r01

10.3.2 Conformance Limit

Frequency hopping systems operating in the 2400-2483.5MHz band shall use at least15 channels.

10.3.3 Test Configuration

Test according to clause 7.1 radio frequency test setup 1

10.3.4 Test Procedure

- According to FCC Part15.247(a)(1)(iii)

The EUT must have its hopping function enabled. Use the following spectrum analyzer settings:

Span = the frequency band of operation

RBW = 100kHz

VBW ≥ RBW

Sweep = auto

Detector function = peak

Trace = max hold

Allow the trace to stabilize. It may prove necessary to break the span up to sections, inorder to clearly show all of the hopping frequencies.

Test Results

Temperature:	20°C	Test Date:	March 13, 20199
Humidity:	39 %	Test By:	KK

Hopping Channel Frequency Range	Quantity of Hopping Channel	Quantity of Hopping Channel limit
2402-2480 (GFSK)	79	> 15
Note: Note: Both BR & EDR mode has same result .		

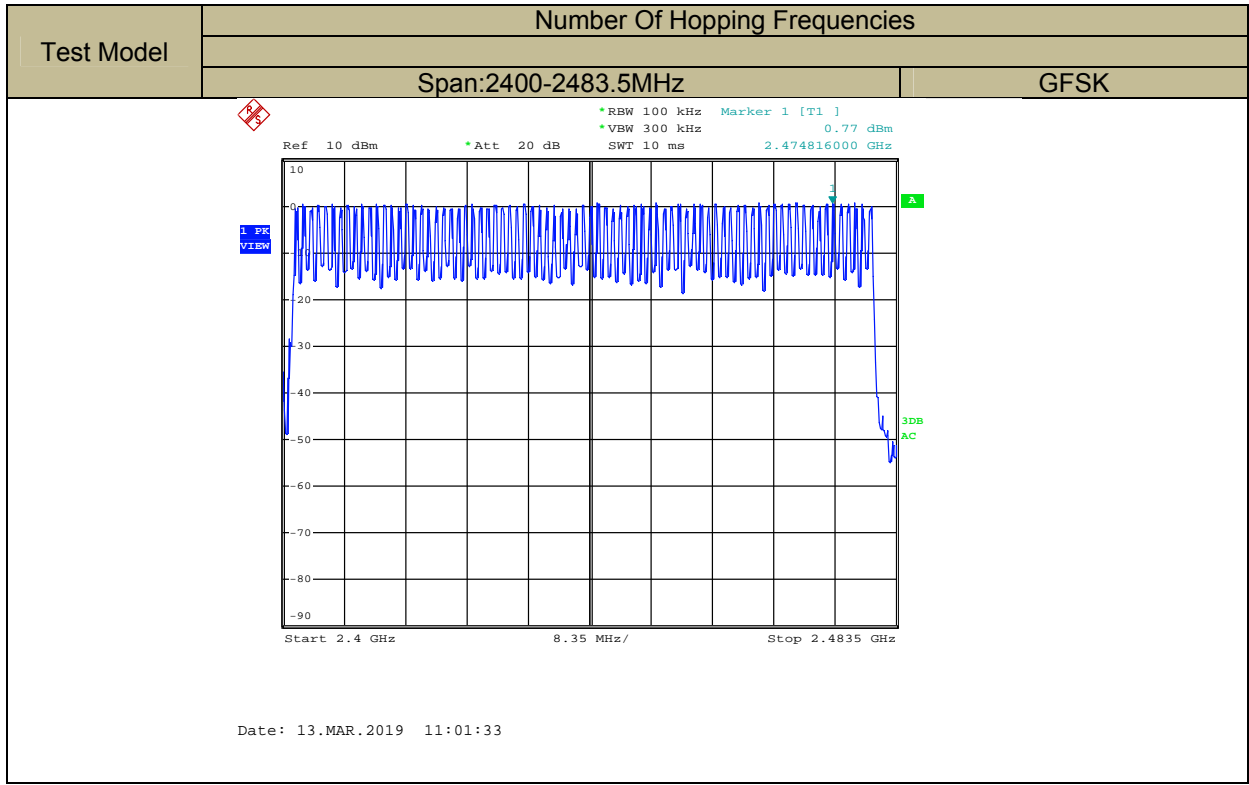

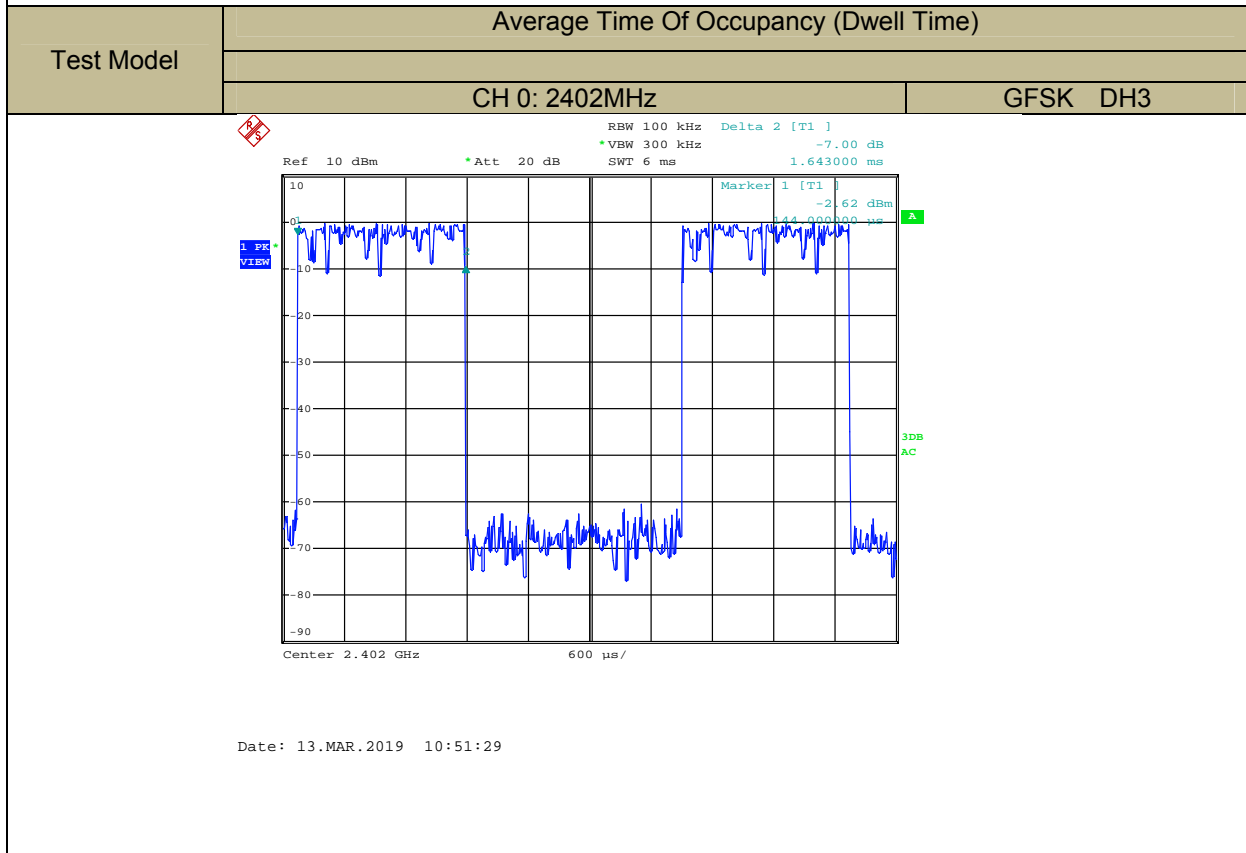
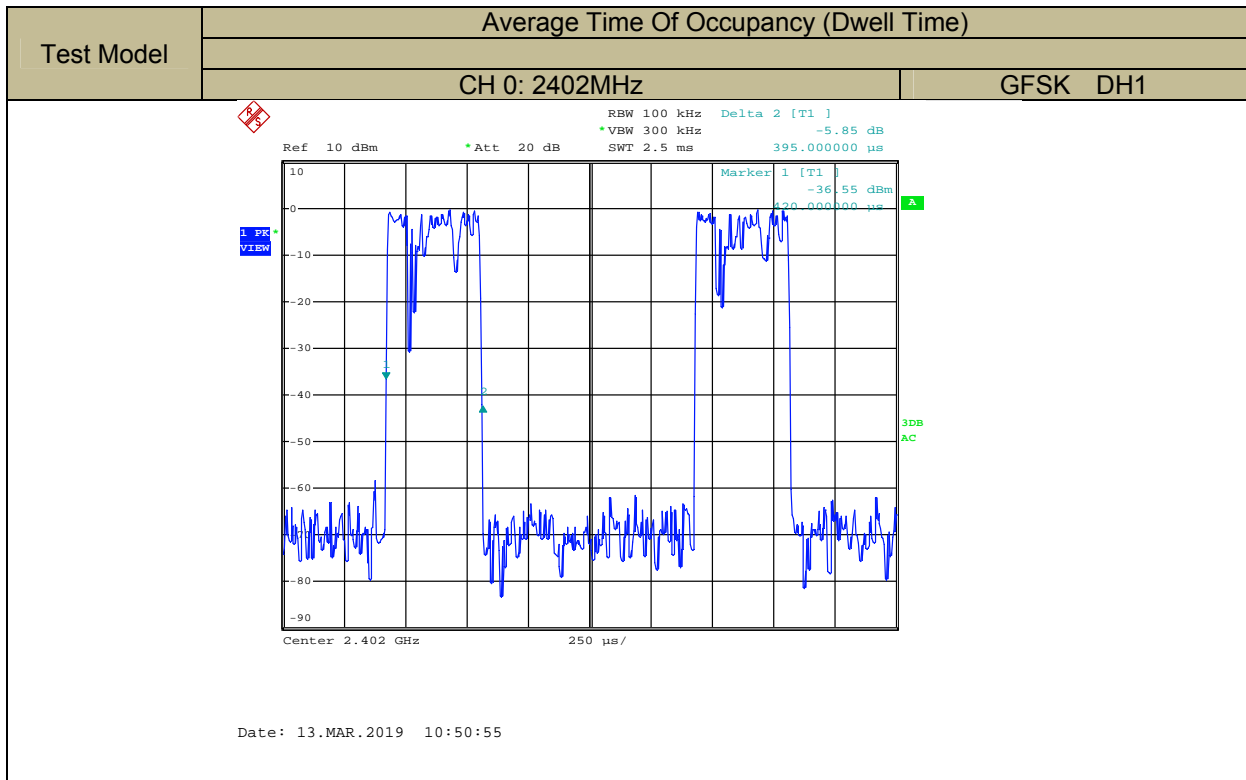

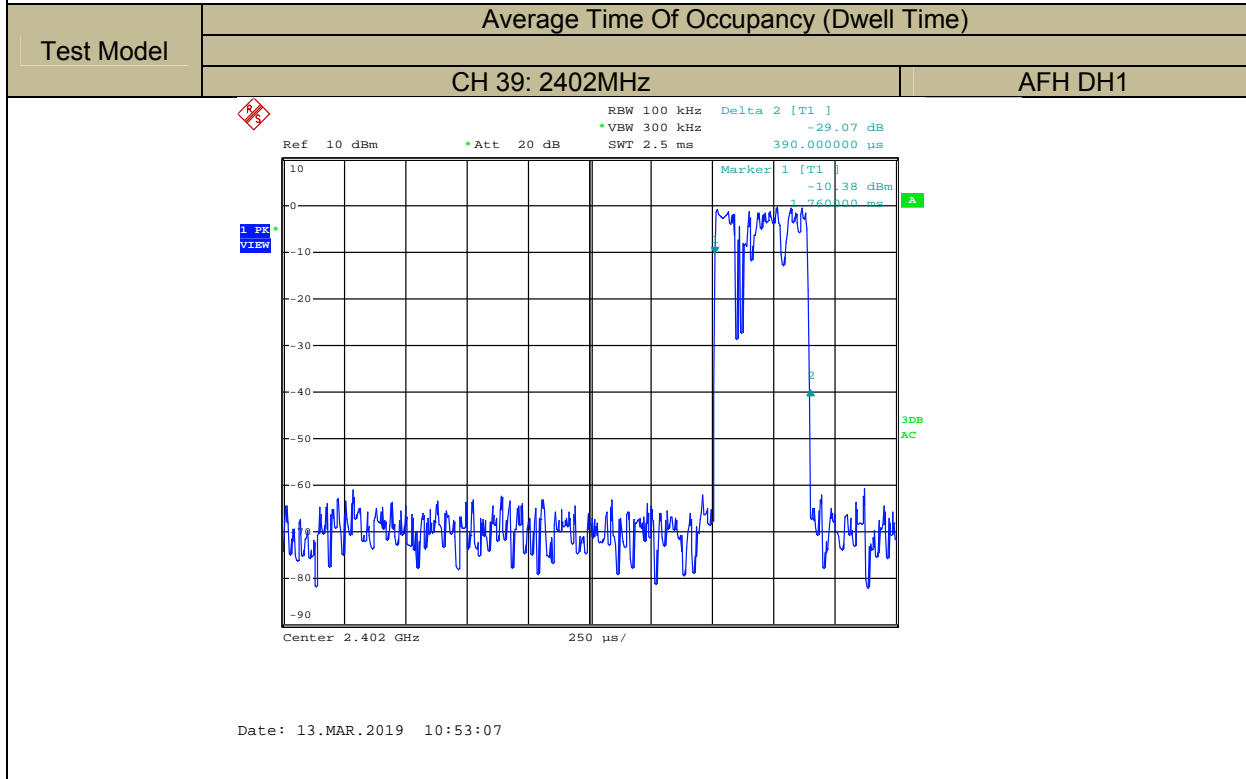
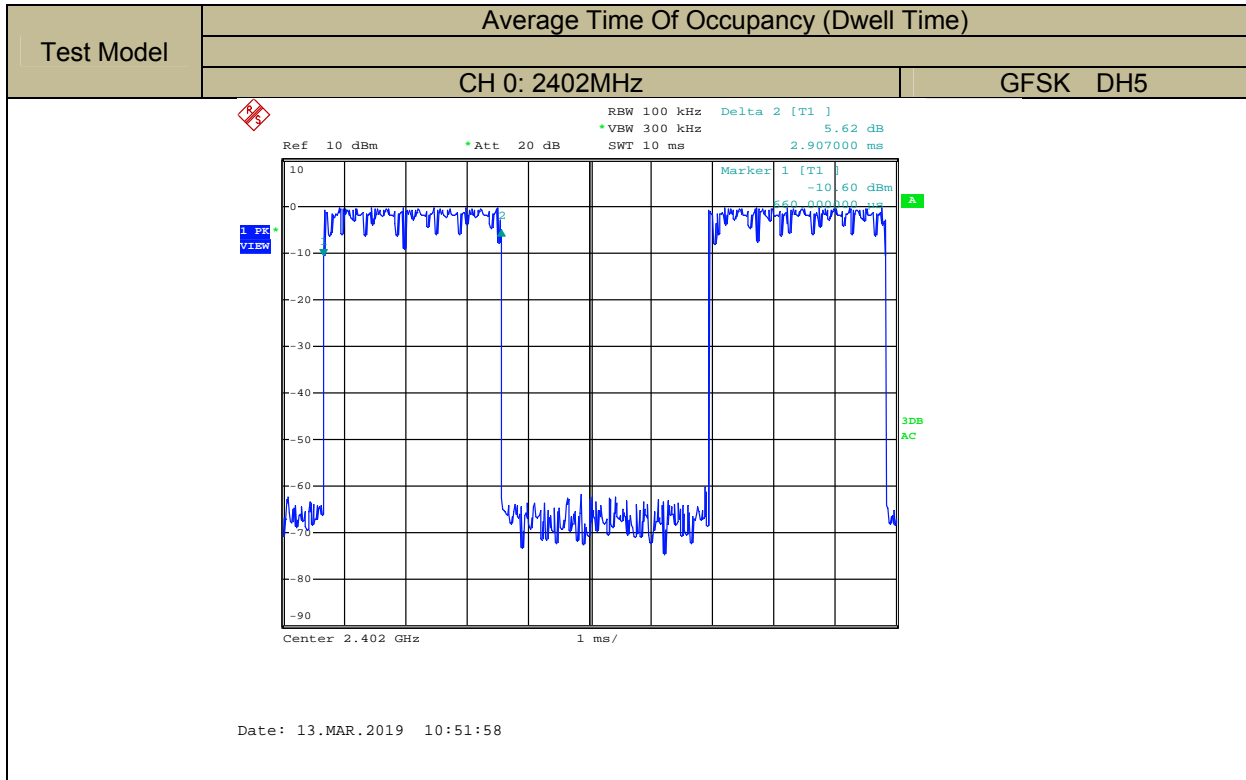

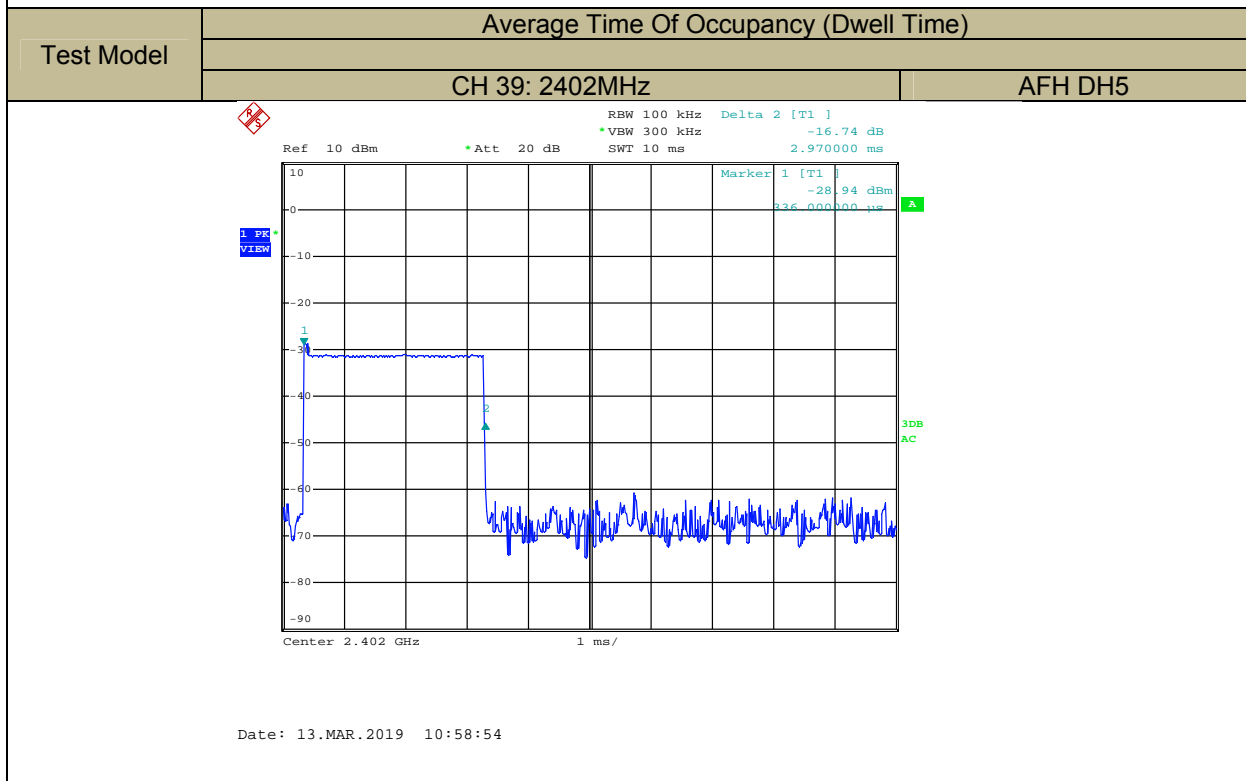
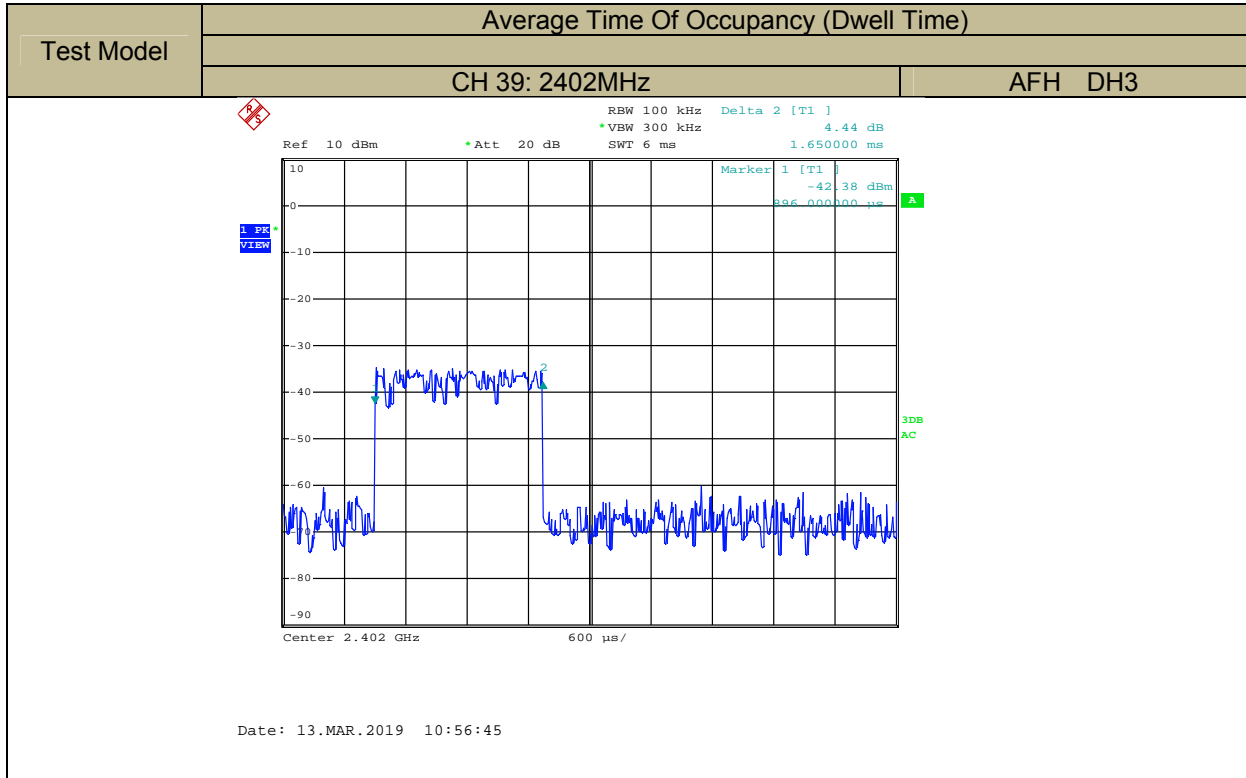

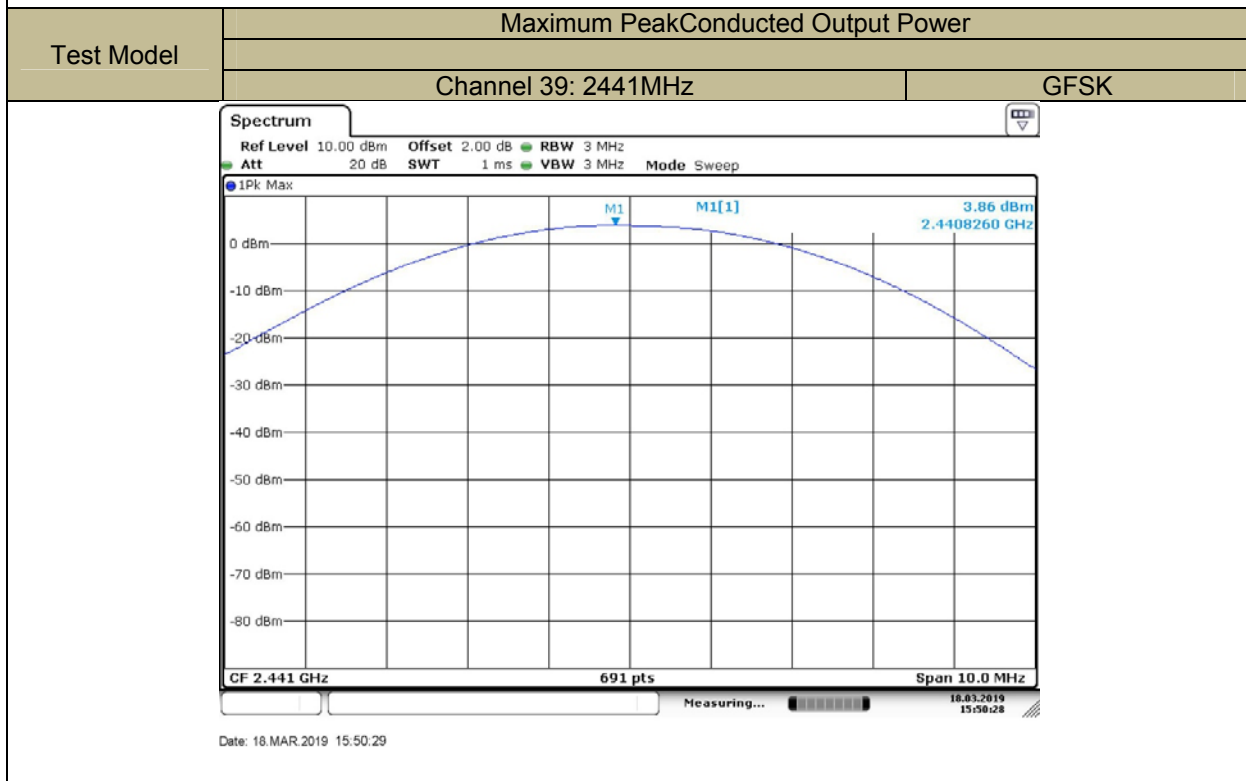
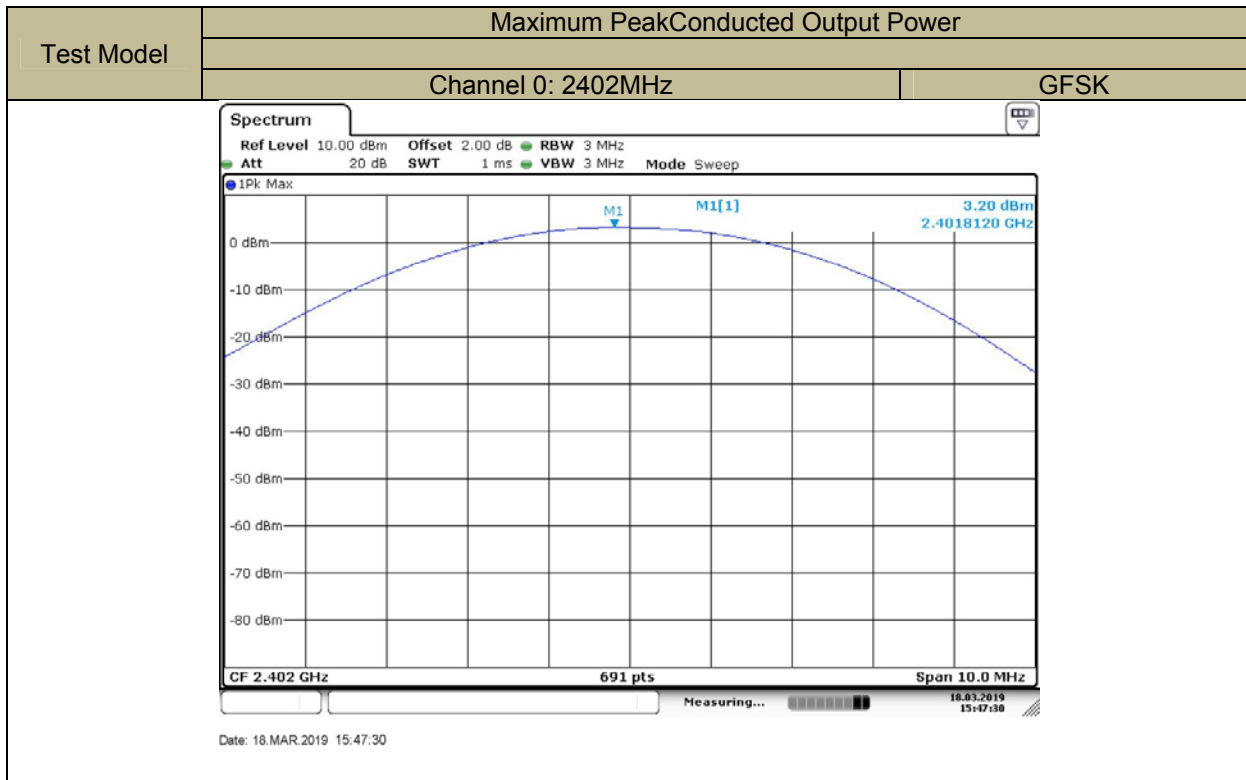

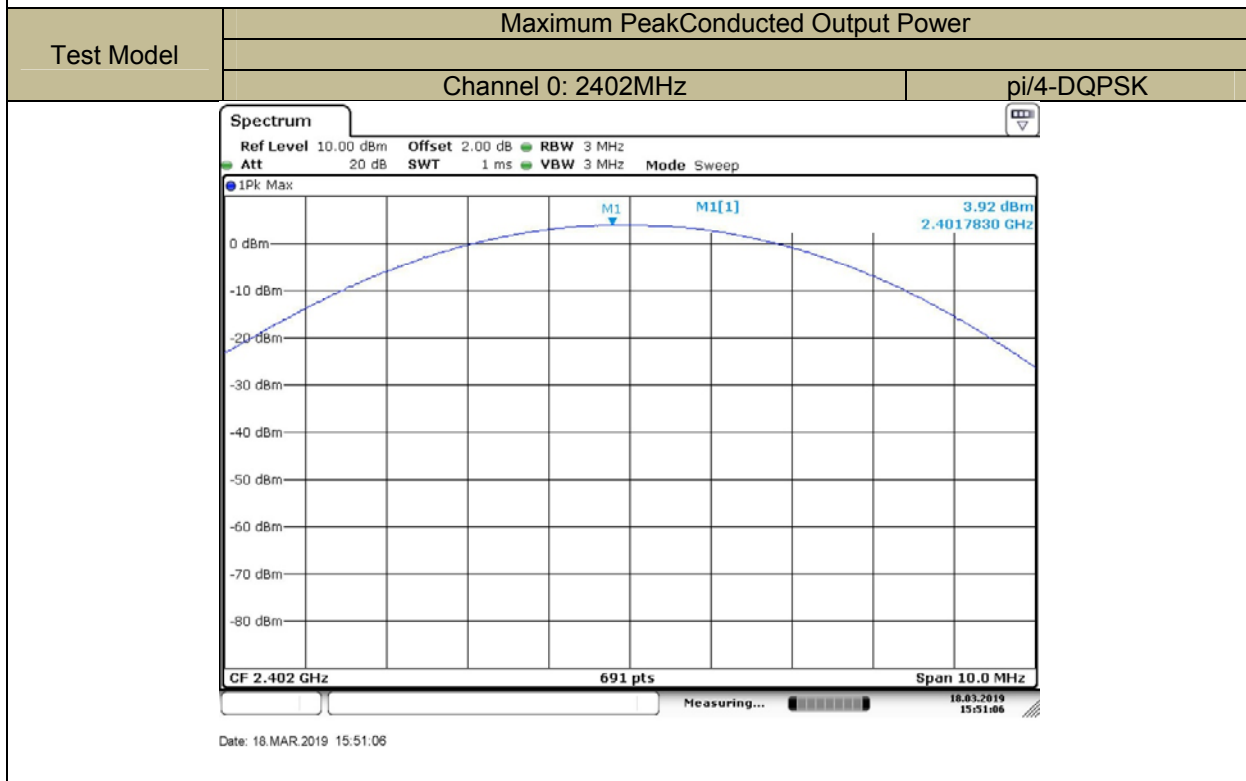
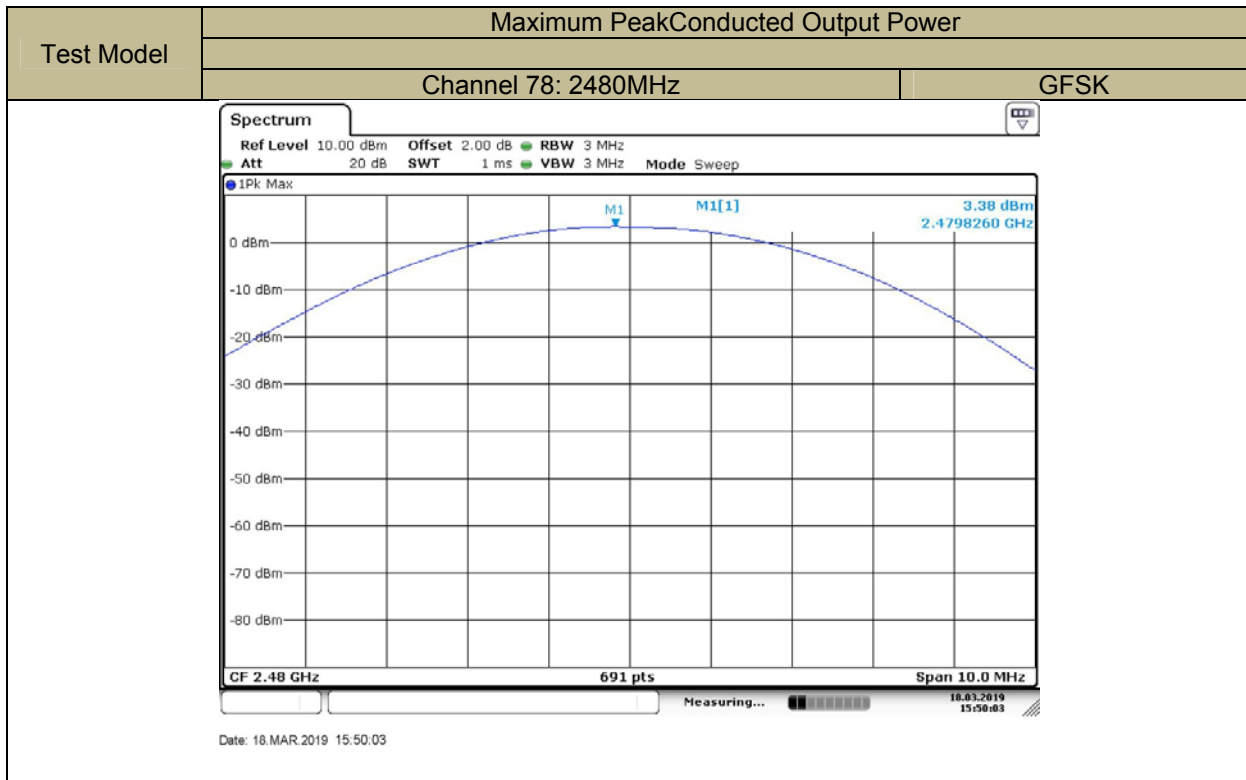

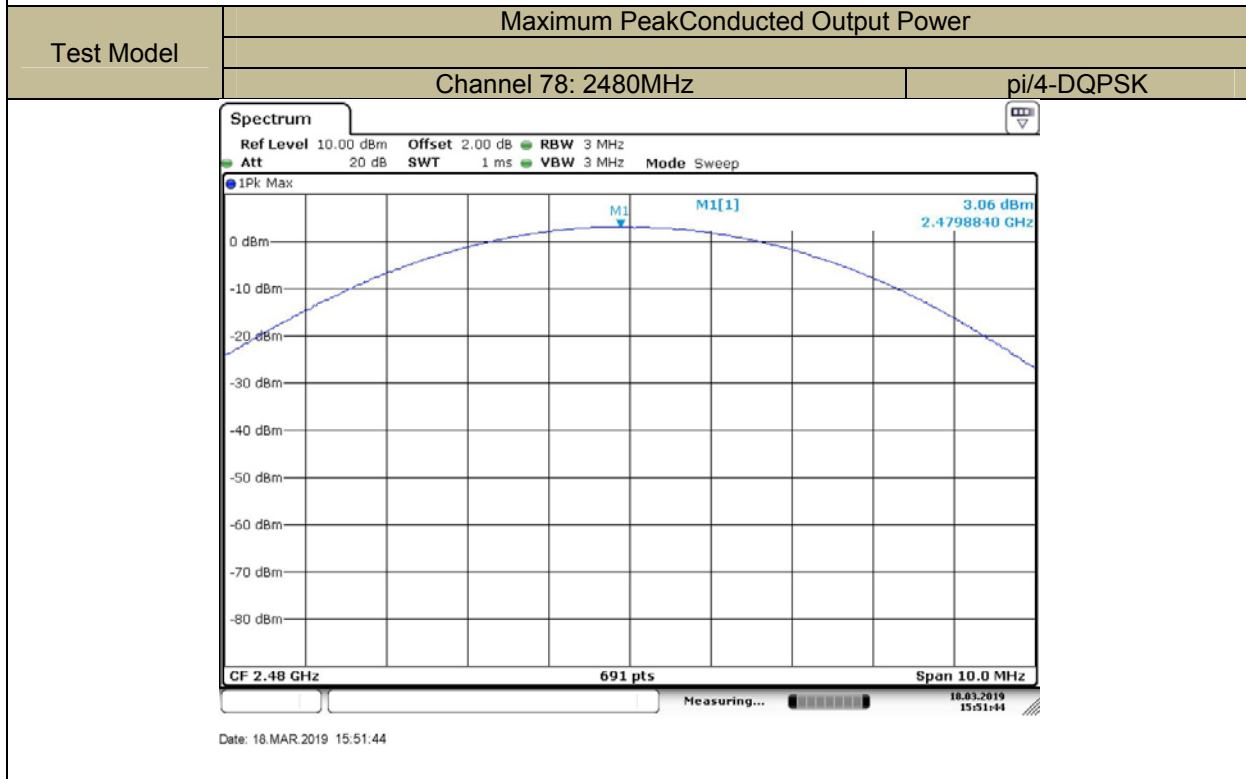
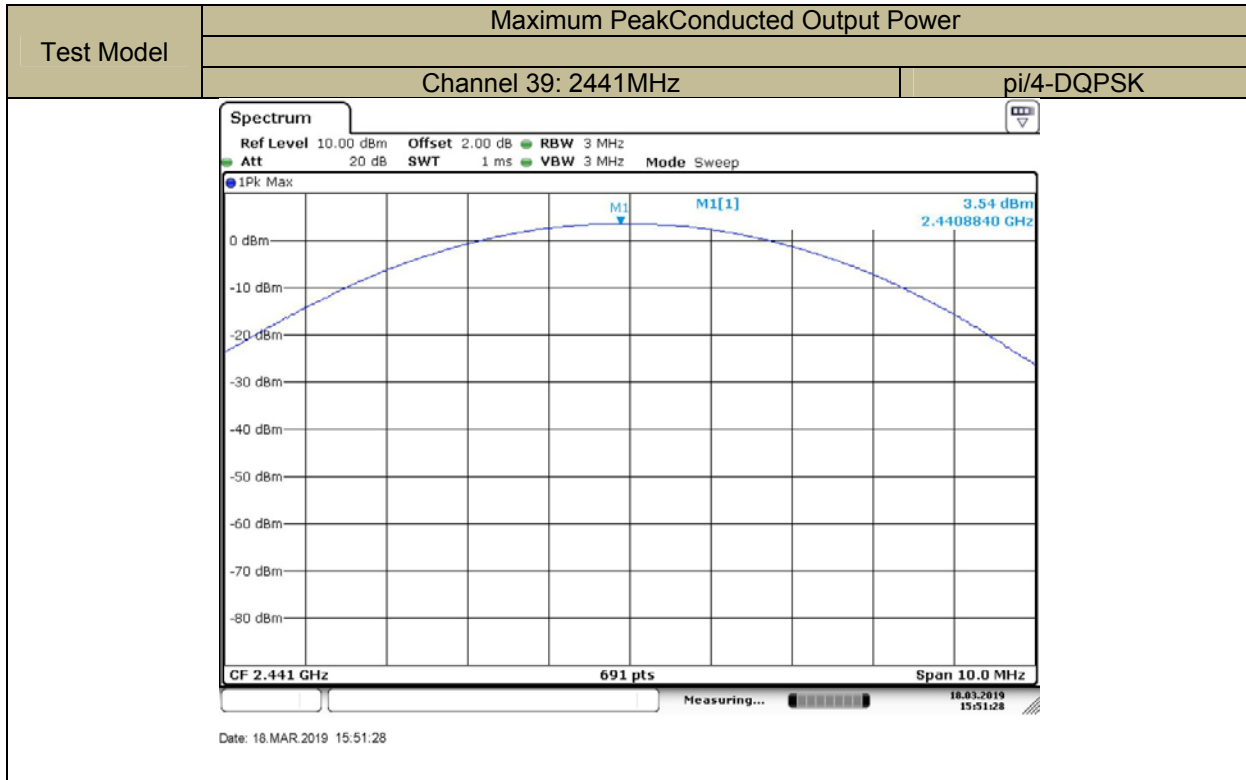

10.6 CONDUCTED SUPRIIOUS EMISSION

10.6.1 Applicable Standard

According to FCC Part 15.247(d) and 558074 D01 15.247 Meas Guidance V05r01

10.6.2 Conformance Limit

According to FCC Part 15.247(d):

In any 100 kHz bandwidth outside the frequency band in which the spread spectrum intentional radiator is operating, the radio frequency power that is produced by the intentional radiator shall be at least 20 dB below that in the 100 kHz bandwidth within the band that contains the highest level of the desired power, based on either an RF conducted, provided the transmitter demonstrates compliance with the peak conducted power limits.

10.6.3 Test Configuration

Test according to clause 7.1 radio frequency test setup 1

10.6.4 Test Procedure

The transmitter output (antenna port) was connected to the spectrum analyzer

■ Reference level measurement

Establish a reference level by using the following procedure:

Set instrument center frequency to DSS channel center frequency.

Set Span = approximately 5 times the 20 dB bandwidth, centered on a hopping channel.

Set the RBW = 100 kHz. Set the VBW $\geq 3 \times$ RBW.

Set Detector = peak. Set Sweep time = auto couple.

Set Trace mode = max hold. Allow trace to fully stabilize.

Use the peak marker function to determine the maximum Maximumconducedlevel.

Note that the channel found to contain the maximum conduced level can be used to establish the reference level.

■ Band-edge Compliance of RF Conducted Emissions

Use the following spectrum analyzer settings:

Span = wide enough to capture the peak level of the emission operating on the channel closest to the band-edge, as well as any modulation products which fall outside of the authorized band of operation

Set RBW $\geq 1\%$ of the span=100kHzSet VBW \geq RBW

Set Sweep = autoSetDetector function = peakSetTrace = max hold

Allow the trace to stabilize. Set the marker on the emission at the bandedge, or on the highest modulation product outside of the band, if this level is greater than that at the bandedge. Enable the marker-delta function, then use the marker-to-peak function to move the marker to the peak of the in-band emission.

The marker-delta value now displayed must comply with the limit specified in this Section.

Now, using the same instrument settings, enable the hopping function of the EUT. Allow the trace to stabilize. Follow the same procedure listed above to determine if any spurious emissions caused by the hopping function also comply with the specified limit.

■ ConducedSpurious RF Conducted Emission

Use the following spectrum analyzer settings:

Span = wide enough to capture the peak level of the in-band emission and all spurious emissions (e.g., harmonics) from the lowest frequency generated in the EUT up through the 10th harmonic.(30MHz to 25GHz).Set RBW = 100 kHzSetVBW \geq RBW

Set Sweep = autoSetDetector function = peakSetTrace = max hold

Allow the trace to stabilize. Set the marker on the peak of any spurious emission recorded. The level displayed must comply with the limit specified in this Section.

10.6.5 Test Results

Bluetooth (GFSK, pi/4-DQPSK) mode have been tested, and the worst result(GFSK)was report as below:

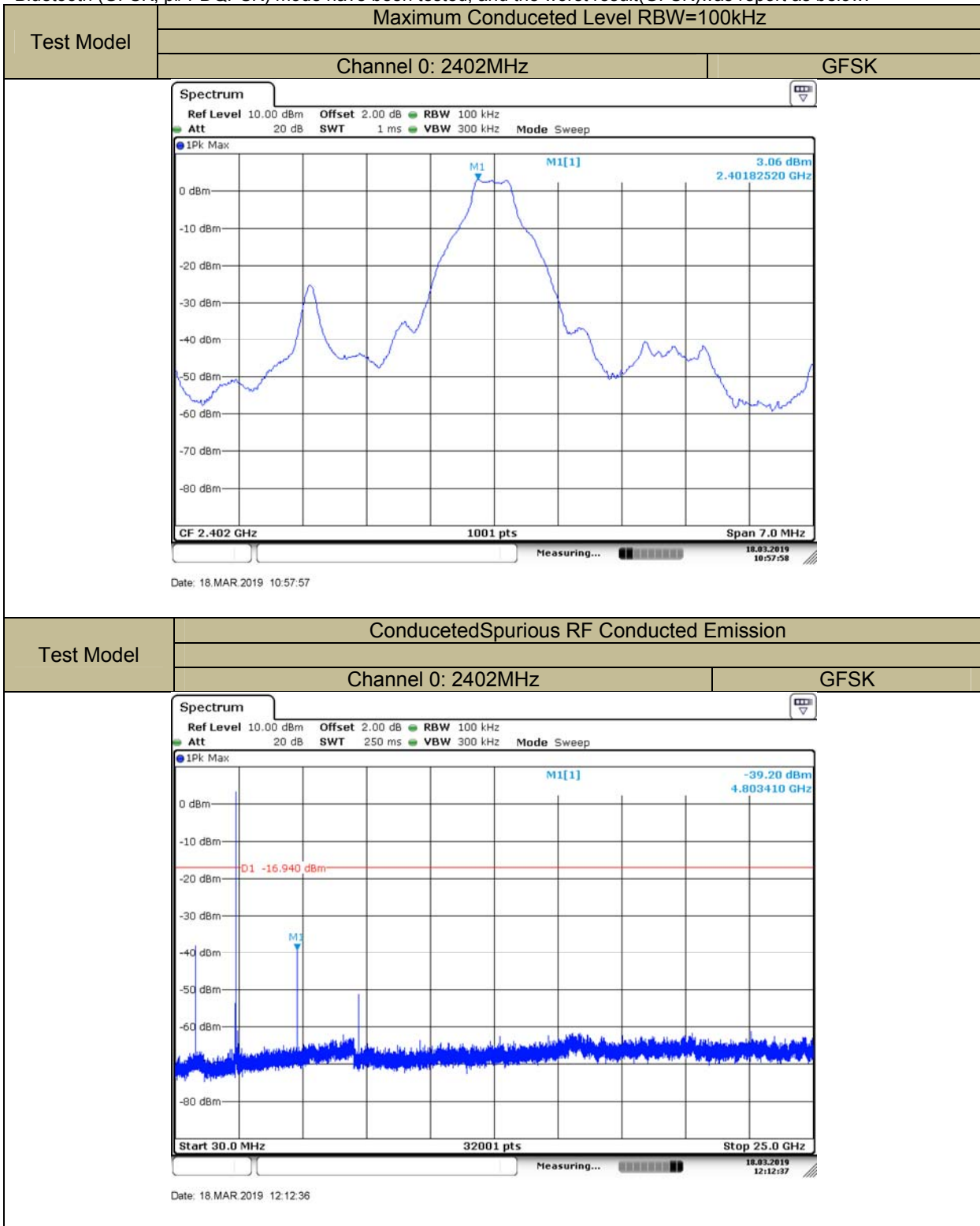

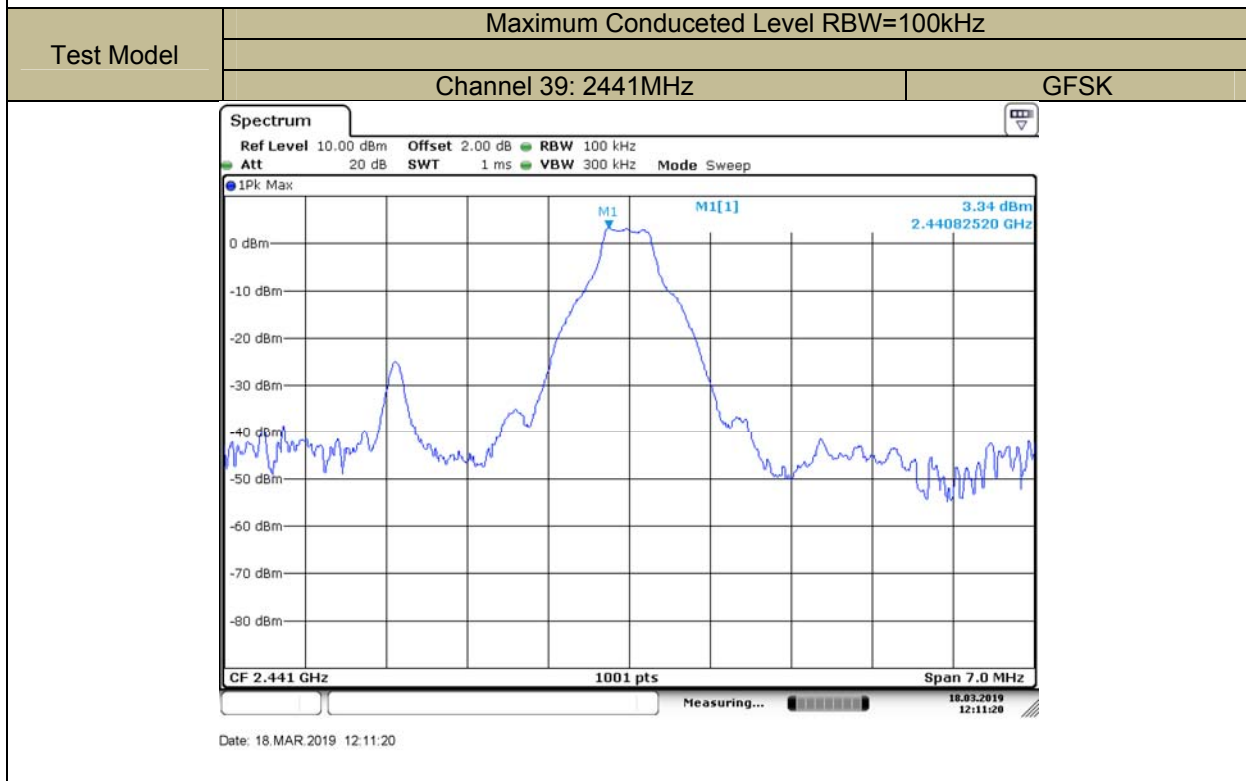
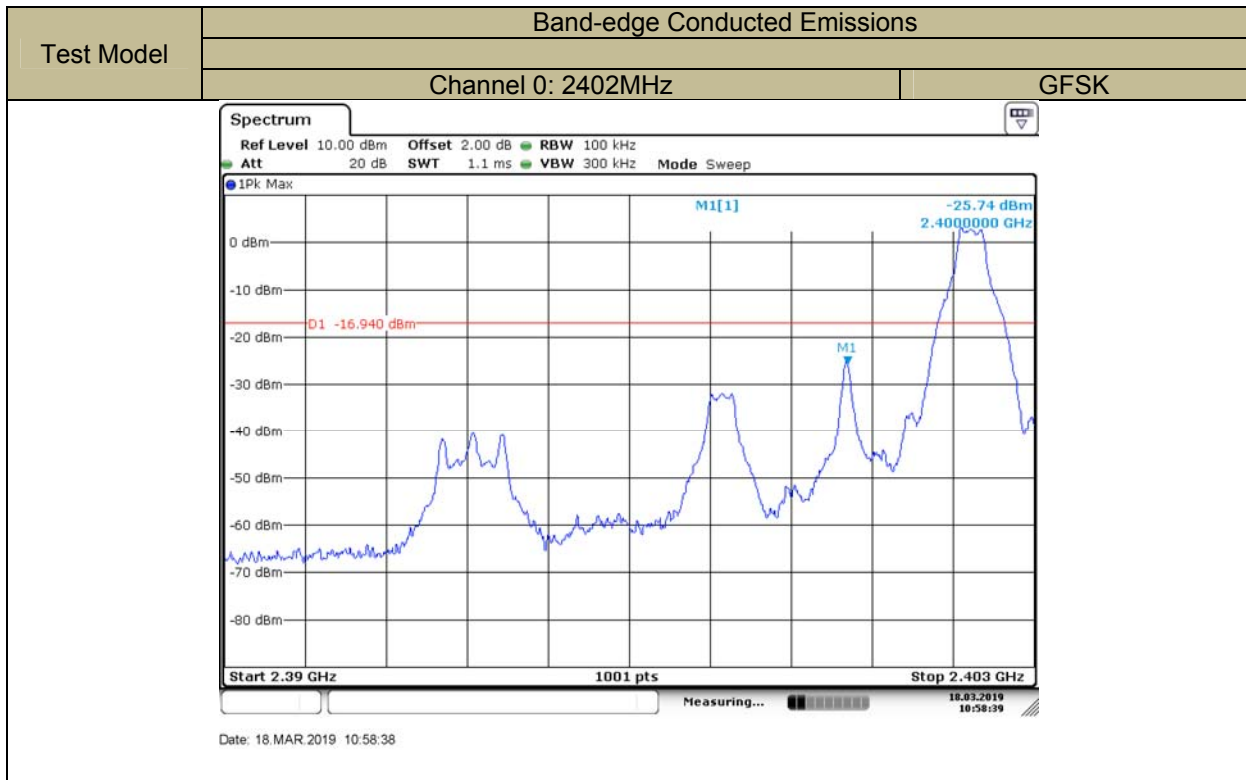

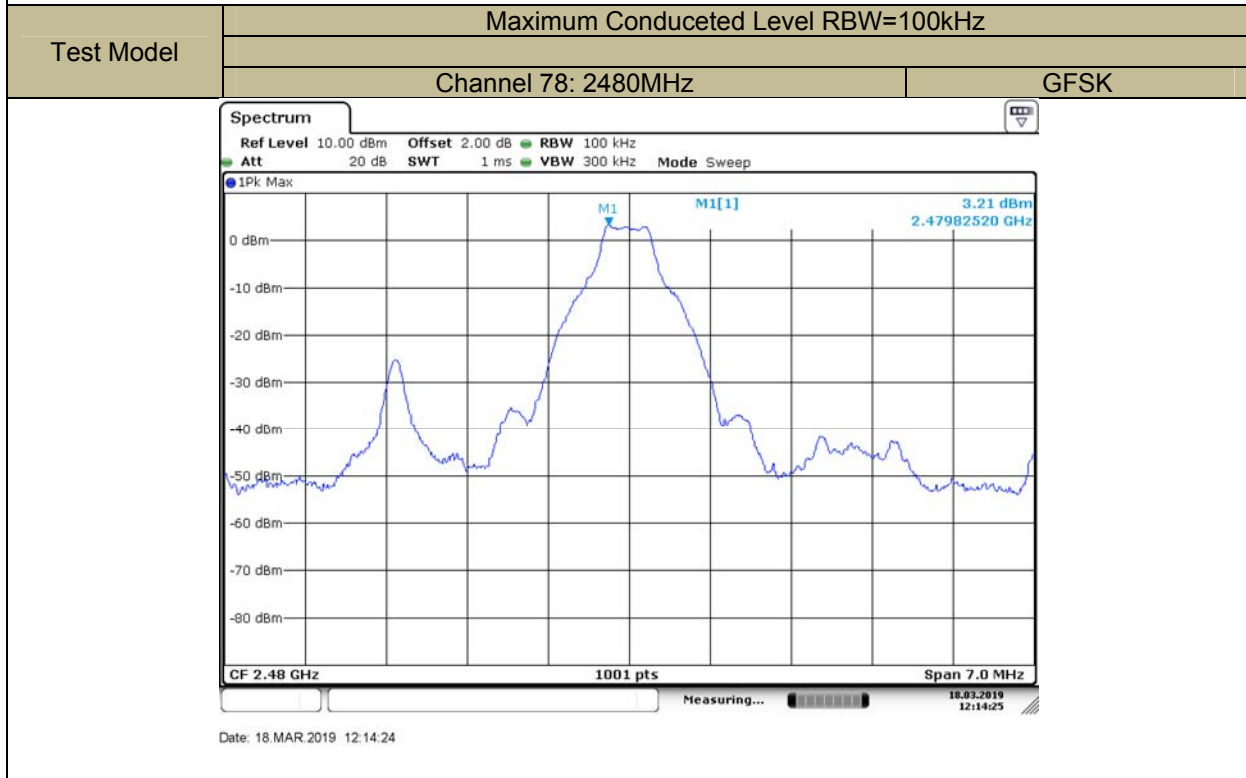
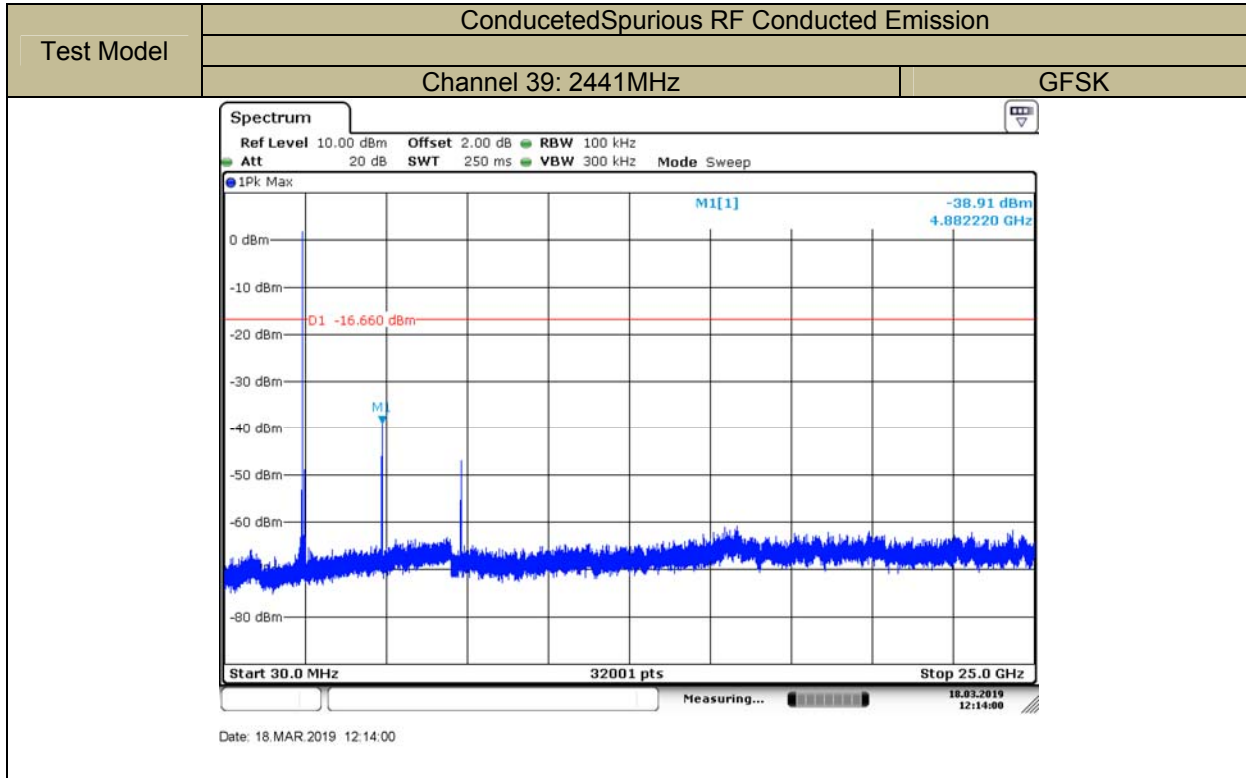

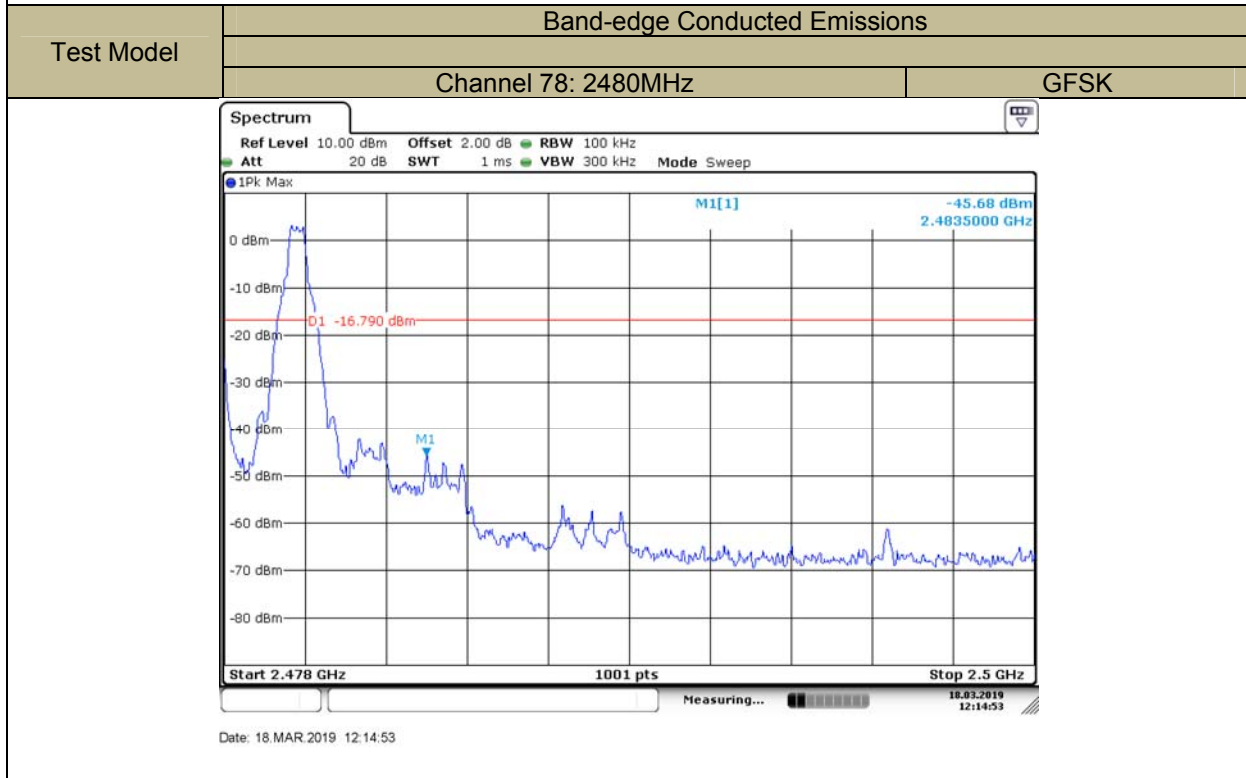
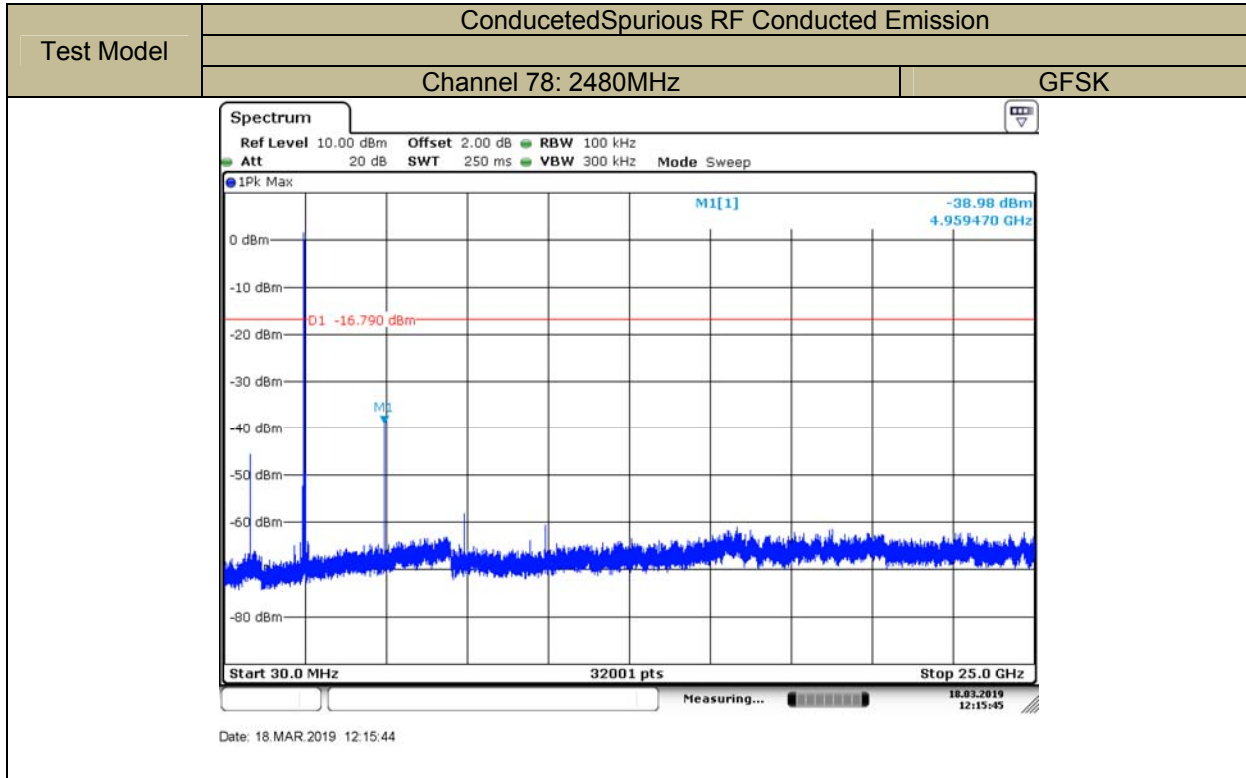

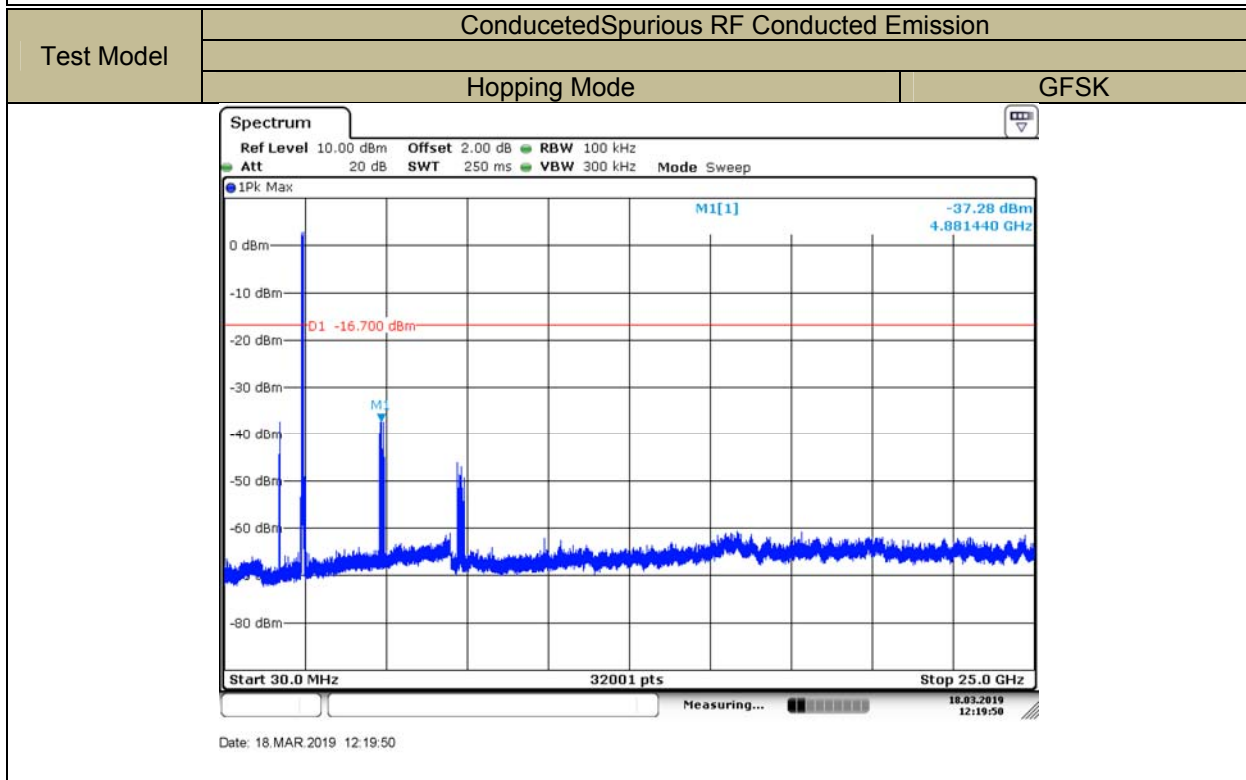
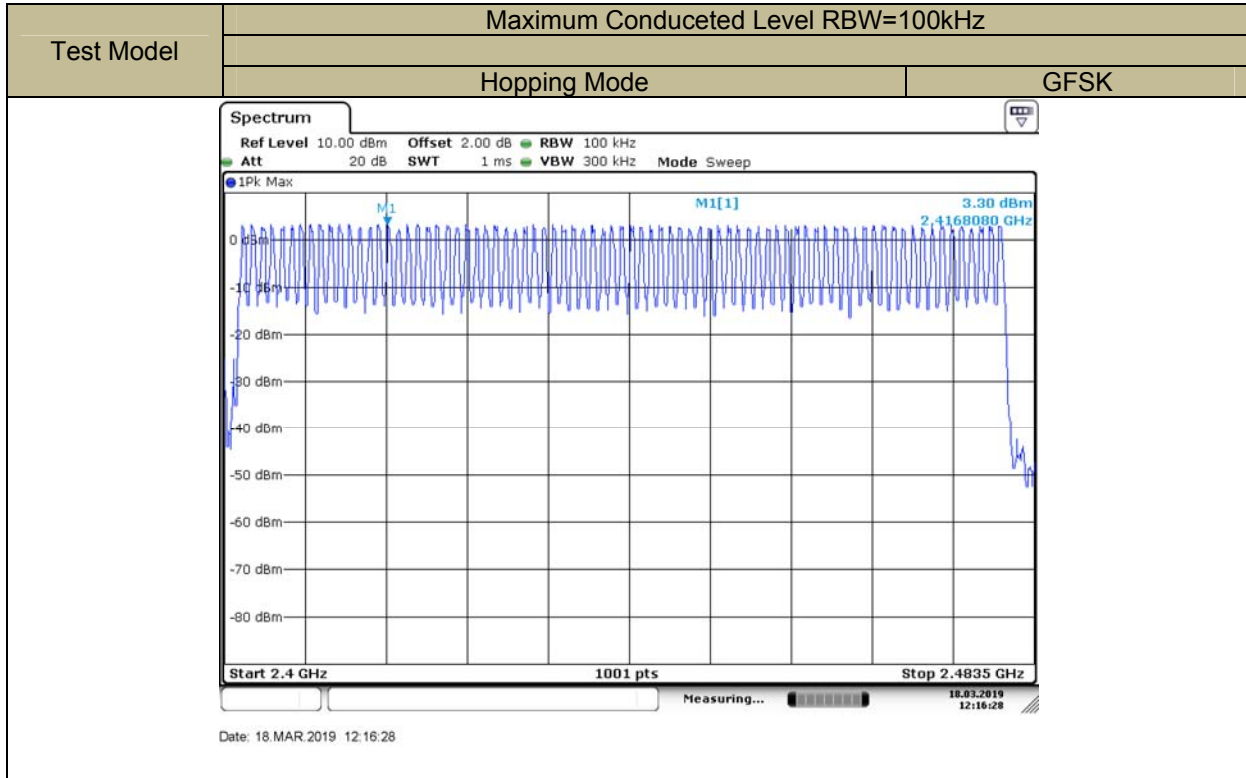

Test Model	Band-edge Conducted Emissions	
	Hopping Mode	GFSK

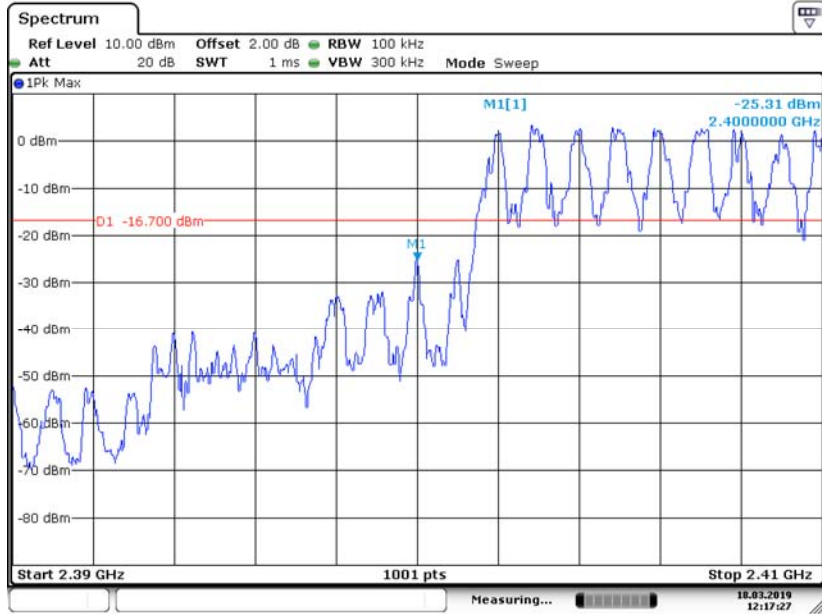

Date: 18.MAR.2019 12:17:26

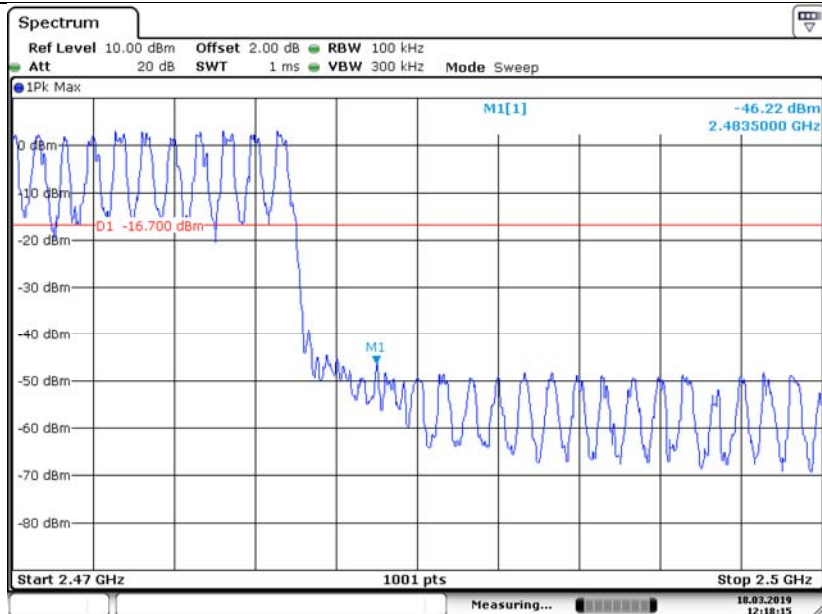

Date: 18.MAR.2019 12:18:14

10.7 RADIATED SPURIOUS EMISSION

10.7.1 Applicable Standard

According to FCC Part 15.247(d) and 15.209 and 558074 D01 15.247 Meas Guidance V05r01

10.7.2 Conformance Limit

According to FCC Part 15.247(d): radiated emissions which fall in the restricted bands, as defined in §15.205(a), must also comply with the radiated emission limits specified in §15.209(a) (see §15.205(c)).
According to FCC Part 15.205, Restricted bands

MHz	MHz	MHz	GHz
0.090-0.110	16.42-16.423	399.9-410	4.5-5.15
10.495-0.505	16.69475-16.69525	608-614	5.35-5.46
2.1735-2.1905	16.80425-16.80475	960-1240	7.25-7.75
4.125-4.128	25.5-25.67	1300-1427	8.025-8.5
4.17725-4.17775	37.5-38.25	1435-1626.5	9.0-9.2
4.20725-4.20775	73-74.6	1645.5-1646.5	9.3-9.5
6.215-6.218	74.8-75.2	1660-1710	10.6-12.7
6.26775-6.26825	123-138	2200-2300	14.47-14.5
8.291-8.294	149.9-150.05	2310-2390	15.35-16.2
8.362-8.366	156.52475-156.52525	2483.5-2500	17.7-21.4
8.37625-8.38675	156.7-156.9	2690-2900	22.01-23.12
8.41425-8.41475	162.0125-167.17	3260-3267	23.6-24.0
12.29-12.293	167.72-173.2	3332-3339	31.2-31.8
12.51975-12.52025	240-285	3345.8-3358	36.43-36.5
12.57675-12.57725	322-335.4	3600-4400	(2)
13.36-13.41			

According to FCC Part 15.205, the level of any transmitter spurious emission in Restricted bands shall not exceed the level of the emission specified in the following table

Restricted Frequency(MHz)	Field Strength ($\mu\text{V}/\text{m}$)	Field Strength ($\text{dB}\mu\text{V}/\text{m}$)	Measurement Distance
0.009-0.490	2400/F(KHz)	20 log ($\mu\text{V}/\text{m}$)	300
0.490-1.705	2400/F(KHz)	20 log ($\mu\text{V}/\text{m}$)	30
1.705-30	30	29.5	30
30-88	100	40	3
88-216	150	43.5	3
216-960	200	46	3
Above 960	500	54	3

10.7.3 Test Configuration

Test according to clause 7.2 radio frequency test setup 2

10.7.4 Test Procedure

This test is required for any spurious emission that falls in a Restricted Band, as defined in Section 15.205. It must be performed with the highest gain of each type of antenna proposed for use with the EUT. Use the following spectrum analyzer settings:

The EUT was placed on a turn table which is 0.8m above ground plane.

Maximum procedure was performed on the highest emissions to ensure EUT compliance.

Span = wide enough to fully capture the emission being measured

RBW = 1 MHz for $f \geq 1$ GHz (1GHz to 25GHz), 100 kHz for $f < 1$ GHz (30MHz to 1GHz)

VBW \geq RBW

Sweep = auto

Temperature: 18°C
 Humidity: 42 %
 Test mode: GFSK

Test Date: March 13, 2019
 Test By: KK
 Frequency: Channel 39: 2441MHz

Freq. (MHz)	Ant.Pol. H/V	Emission Level(dBuV/m)		Limit 3m(dBuV/m)		Over(dB)	
		PK	AV	PK	AV	PK	AV
10911.00	V	53.72	39.64	74.00	54.00	-20.28	-14.36
12815.00	V	56.37	42.21	74.00	54.00	-17.63	-11.79
13733.00	V	55.83	41.75	74.00	54.00	-18.17	-12.25
15909.00	V	57.35	43.31	74.00	54.00	-16.65	-10.69
17031.00	V	58.79	44.65	74.00	54.00	-15.21	-9.35
17949.00	V	58.82	44.78	74.00	54.00	-15.18	-9.22
10639.00	H	52.25	38.12	74.00	54.00	-21.75	-15.88
11489.00	H	52.73	38.65	74.00	54.00	-21.27	-15.35
12169.00	H	53.72	39.46	74.00	54.00	-20.28	-14.54
13682.00	H	55.06	41.05	74.00	54.00	-18.94	-12.95
16402.00	H	57.63	43.56	74.00	54.00	-16.37	-10.44
17184.00	H	59.59	45.51	74.00	54.00	-14.41	-8.49

Temperature: 18°C
 Humidity: 42 %
 Test mode: GFSK

Test Date: March 13, 2019
 Test By: KK
 Frequency: Channel 78: 2480MHz

Freq. (MHz)	Ant.Pol. H/V	Emission Level(dBuV/m)		Limit 3m(dBuV/m)		Over(dB)	
		PK	AV	PK	AV	PK	AV
10826.00	V	53.59	39.46	74.00	54.00	-20.41	-14.54
12271.00	V	55.85	41.78	74.00	54.00	-18.15	-12.22
13410.00	V	56.61	41.56	74.00	54.00	-17.39	-12.44
14651.00	V	58.44	44.32	74.00	54.00	-15.56	-9.68
15994.00	V	58.67	44.56	74.00	54.00	-15.33	-9.44
17830.00	V	58.29	44.15	74.00	54.00	-15.71	-9.85
10350.00	H	51.90	37.85	74.00	54.00	-22.10	-16.15
12152.00	H	54.07	40.04	74.00	54.00	-19.93	-13.96
13410.00	H	55.42	41.23	74.00	54.00	-18.58	-12.77
14566.00	H	56.31	42.18	74.00	54.00	-17.69	-11.82
15926.00	H	57.43	43.35	74.00	54.00	-16.57	-10.65
17065.00	H	57.91	43.68	74.00	54.00	-16.09	-10.32

- Note:**
- (1) All Readings are Peak Value (VBW=3MHz) and Average Value (VBW=10Hz).
 - (2) Emission Level= Reading Level+Probe Factor +Cable Loss.
 - (3) Data of measurement within this frequency range shown "--" in the table above means the reading of emissions are attenuated more than 20dB below the permissible limits or the field strength is too small to be measured.

Test Model	Spurious Emission in Restricted Band 2310-2390MHz		
	Channel 0: 2402MHz	GFSK	H

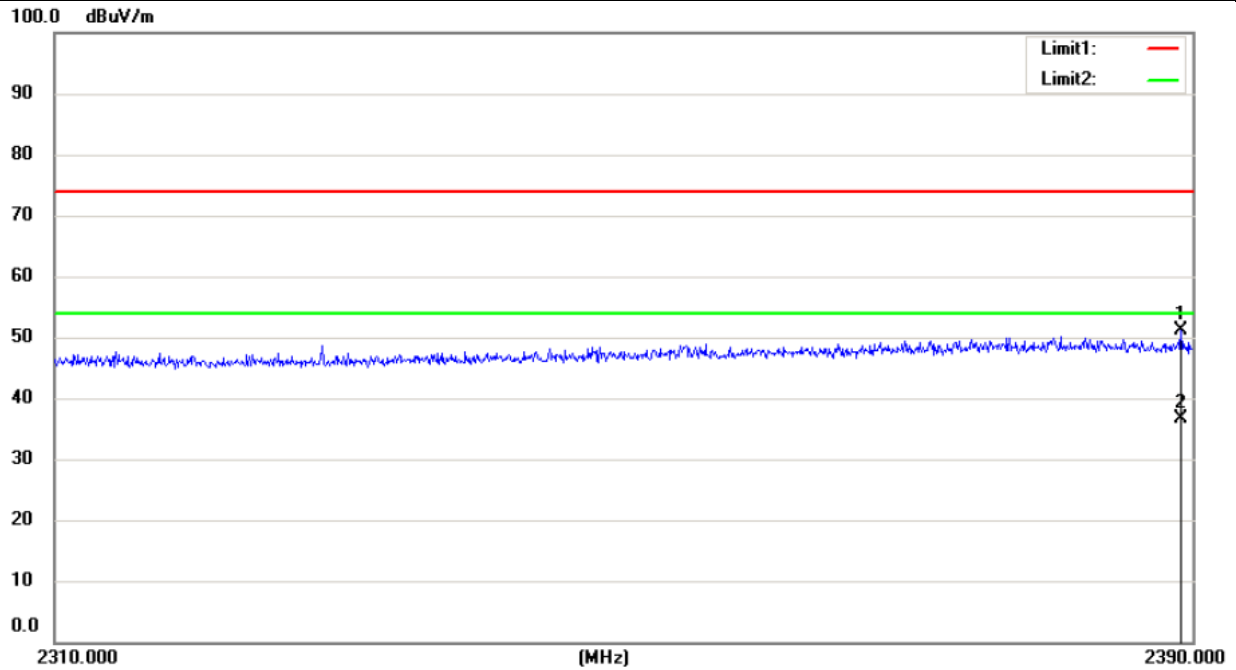

Test Model	Spurious Emission in Restricted Band 2310-2390MHz		
	Channel 0: 2402MHz	GFSK	V

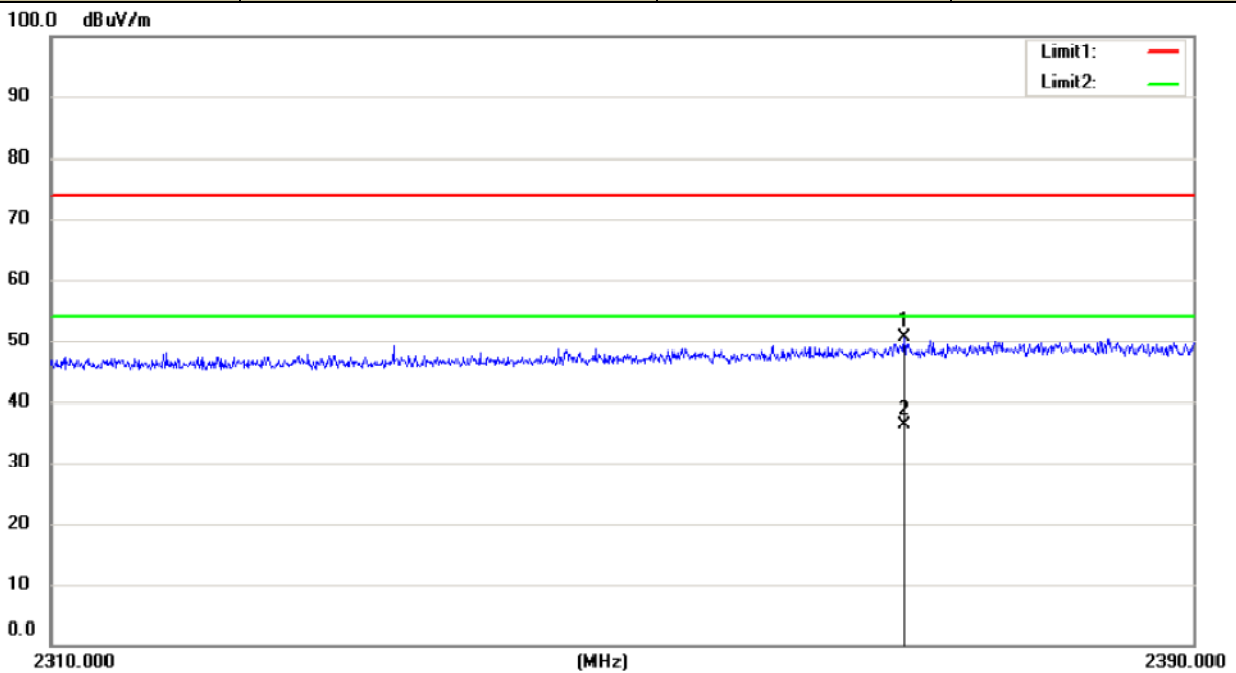

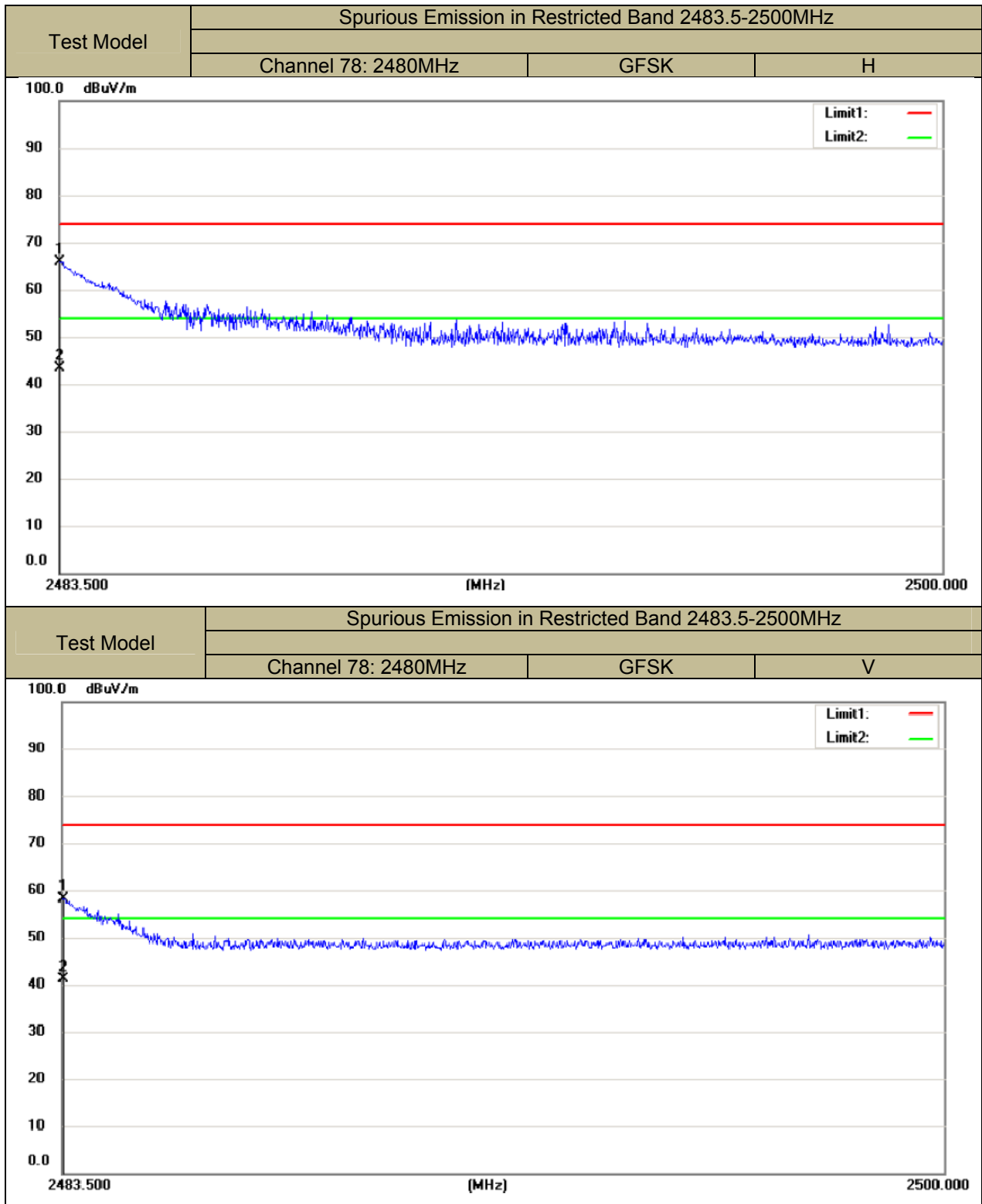

Test Model	Spurious Emission in Restricted Band 2310-2390&2483.5-2500MHz		
	Hopping	GFSK	H

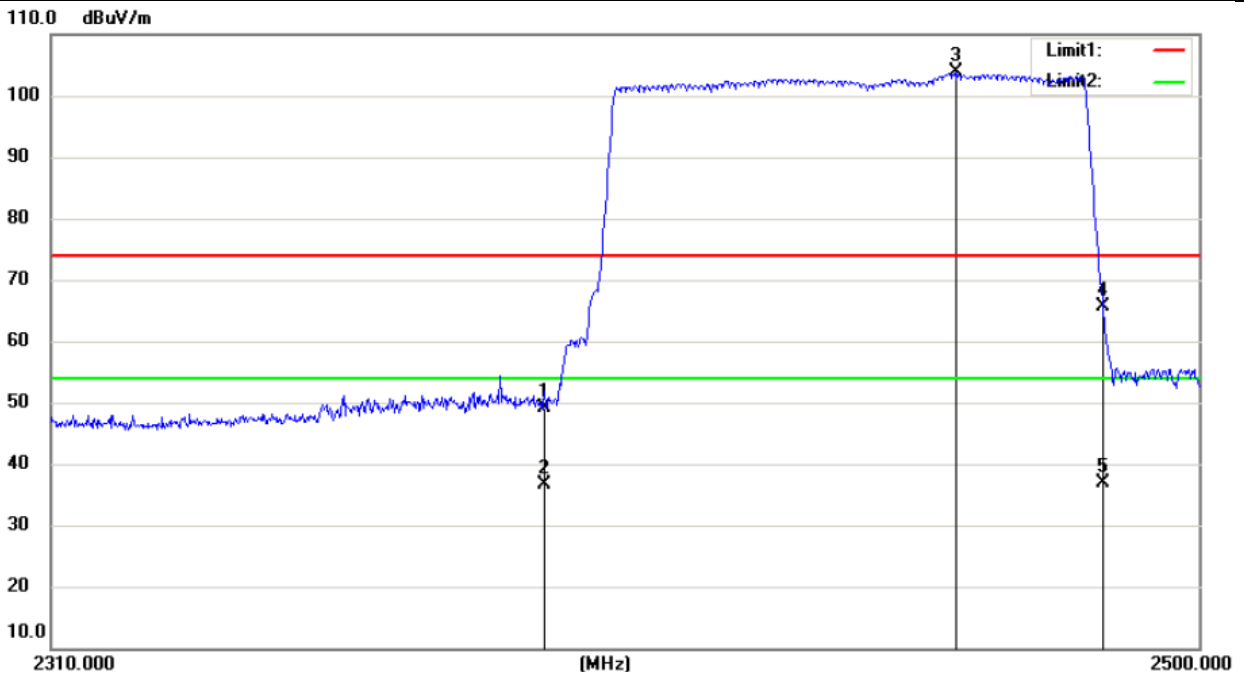

Test Model	Spurious Emission in Restricted Band 2310-2390&2483.5-2500MHz		
	Hopping	GFSK	V

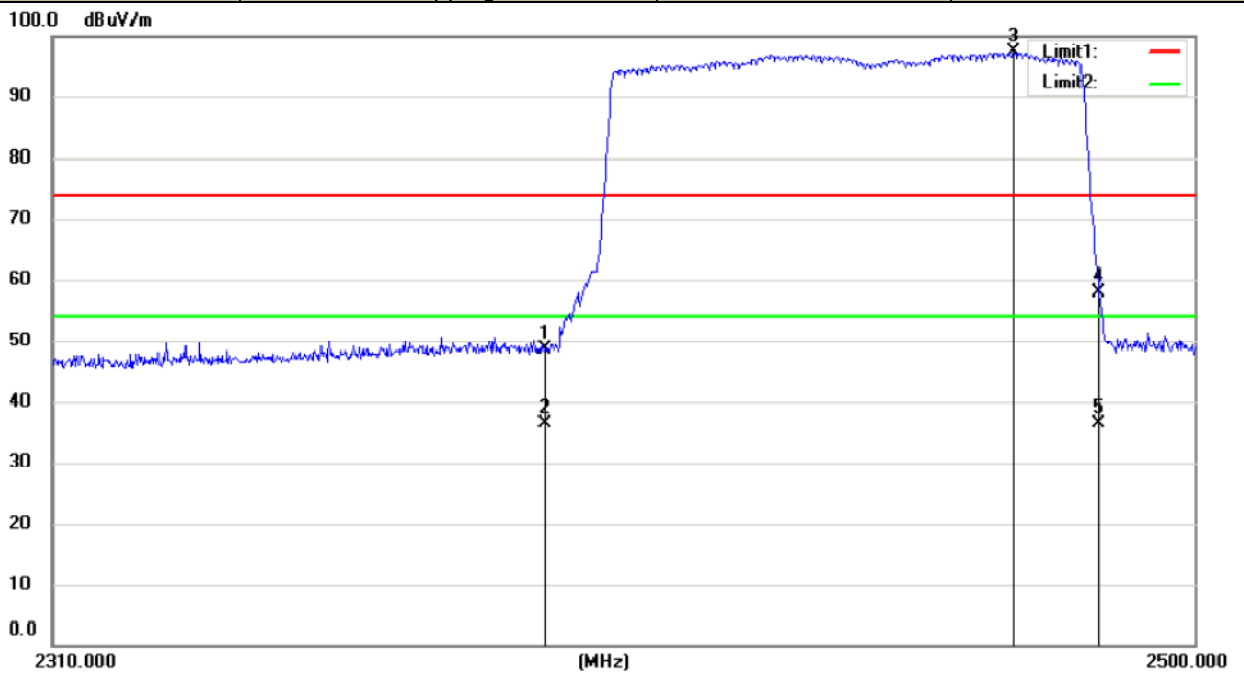

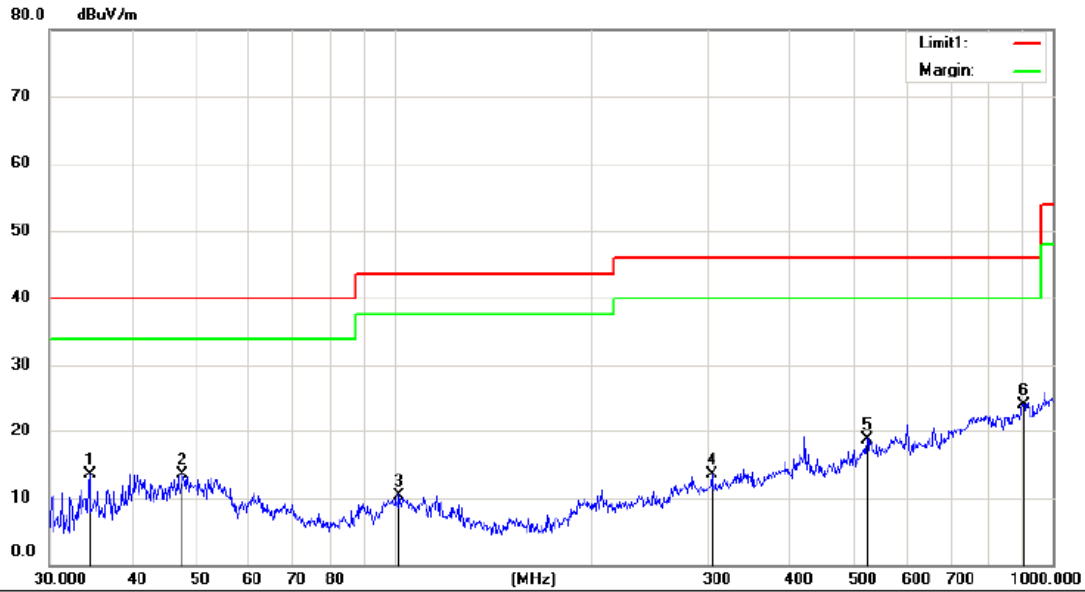

Site: site #1 Polarization: **Vertical** Temperature: 18 C
 Limit: FCC Part15 Class B 3M Radiation Power: DC 3.7V Humidity: 42 %
 Mode:TX (GFSK, 2402MHz)
 Note:

No.	Mk.	Freq. MHz	Reading level dBuV	Correct Factor dB	Measure- ment dBuV/m	Limit dBuV/m	Over dB	Antenna Height cm	Table Degree	Comment
1		34.5172	35.92	-22.42	13.50	40.00	-26.50	QP		
2		47.8260	33.46	-19.86	13.60	40.00	-26.40	QP		
3		102.0013	31.44	-21.04	10.40	43.50	-33.10	QP		
4		303.5437	32.39	-18.89	13.50	46.00	-32.50	QP		
5		522.7180	32.12	-13.32	18.80	46.00	-27.20	QP		
6	*	903.3093	30.56	-6.36	24.20	46.00	-21.80	QP		

*:Maximum data x:Over limit !:over margin

Operator: KK

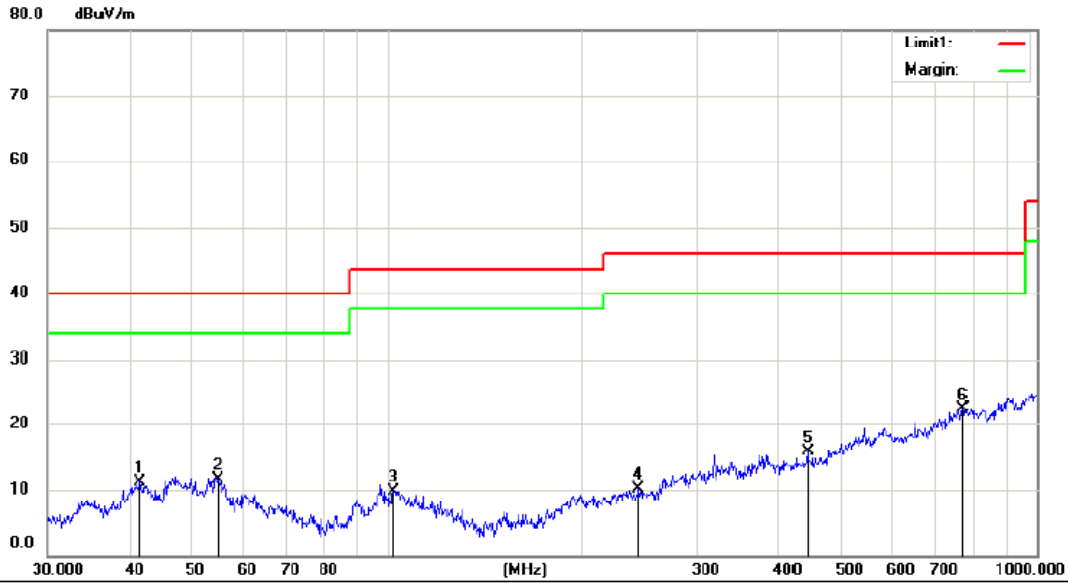

Site site #1 Polarization: *Horizontal* Temperature: 18 C
 Limit: FCC Part15 Class B 3M Radiation Power: DC 3.7V Humidity: 42 %
 Mode:TX (GFSK, 2441MHz)
 Note:

No.	Mk.	Freq.	Reading Level	Correct Factor	Measurement	Limit	Over	Antenna Height	Table Degree	
		MHz	dBuV	dB	dBuV/m	dBuV/m	dB	cm	degree	Comment
1		41.5670	31.55	-20.35	11.20	40.00	-28.80			QP
2		54.8348	31.26	-19.76	11.50	40.00	-28.50			QP
3		102.3596	30.87	-21.07	9.80	43.50	-33.70			QP
4		243.3771	31.50	-21.30	10.20	46.00	-35.80			QP
5		443.2942	32.57	-16.77	15.80	46.00	-30.20			QP
6	*	771.4485	30.79	-8.19	22.60	46.00	-23.40			QP

*:Maximum data x:Over limit !:over margin

Operator: KK

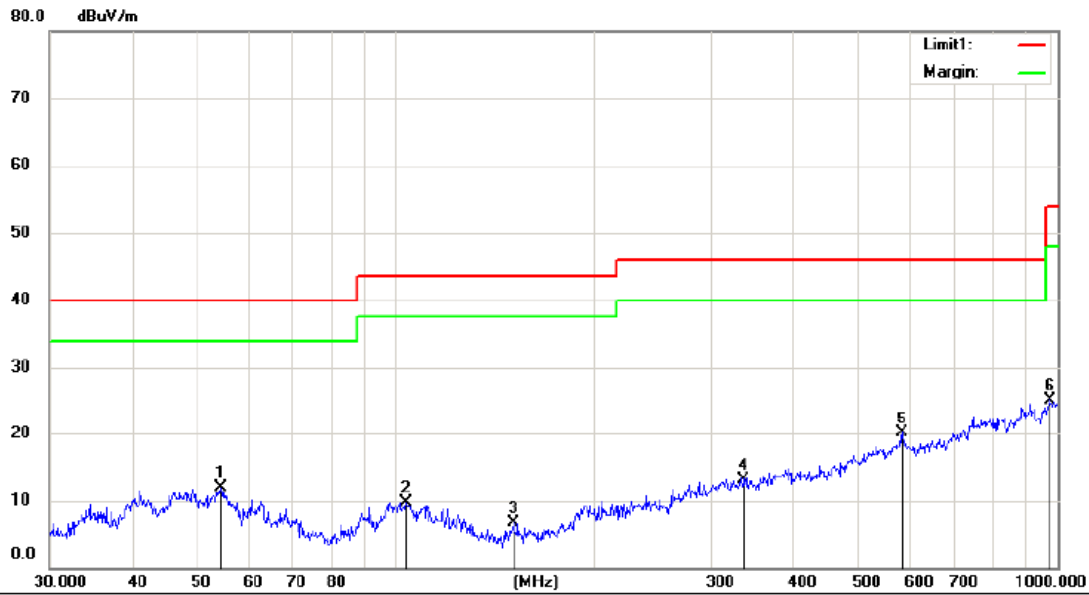

Site site #1 Polarization: *Horizontal* Temperature: 18 C
 Limit: FCC Part15 Class B 3M Radiation Power: DC 3.7V Humidity: 42 %
 Mode:TX (GFSK, 2480MHz)
 Note:

No.	Mk.	Freq.	Reading Level	Correct Factor	Measurement	Limit	Over	Antenna Height	Table Degree	
		MHz	dBuV	dB	dBuV/m	dBuV/m	dB	cm	degree	Comment
1		54.4515	31.56	-19.66	11.90	40.00	-28.10	QP		
2		103.8054	30.87	-21.17	9.70	43.50	-33.80	QP		
3		150.5377	31.56	-24.86	6.70	43.50	-36.80	QP		
4		336.0351	30.97	-17.77	13.20	46.00	-32.80	QP		
5	*	582.7424	31.81	-11.61	20.20	46.00	-25.80	QP		
6		972.3373	30.46	-5.26	25.20	54.00	-28.80	QP		

*:Maximum data x:Over limit !:over margin

Operator: KK

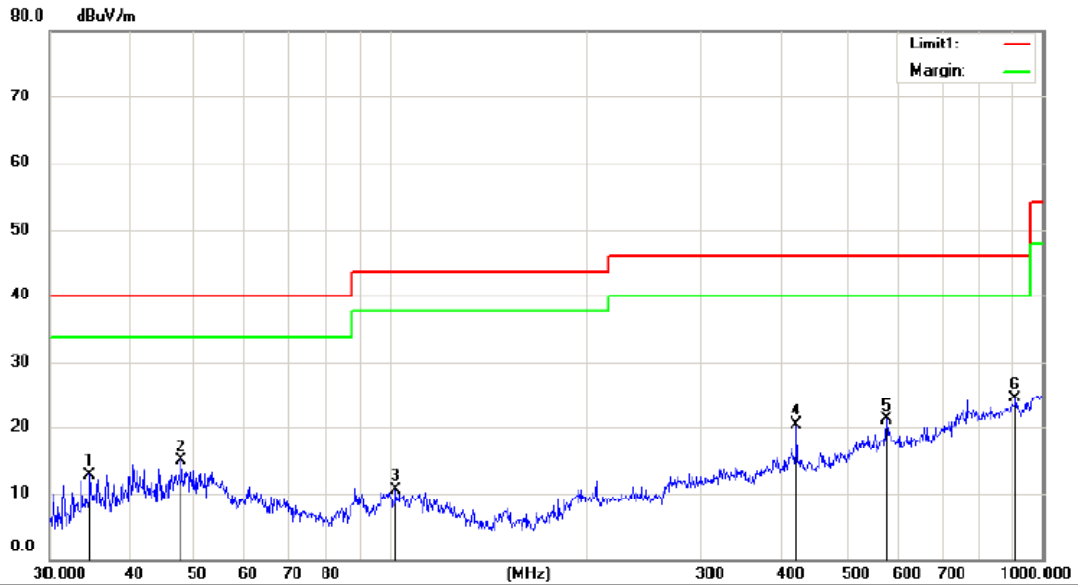

Site site #1 Polarization: *Vertical* Temperature: 18 C
 Limit: FCC Part15 Class B 3M Radiation Power: DC 3.7V Humidity: 42 %
 Mode:TX (GFSK, 2480MHz)

Note:

No.	Mk.	Freq.	Reading Level	Correct Factor	Measurement	Limit	Over	Antenna Height	Table Degree	
		MHz	dBuV	dB	dBuV/m	dBuV/m	dB	cm	degree	Comment
1		34.6385	35.24	-22.44	12.80	40.00	-27.20	QP		
2		47.8260	34.86	-19.86	15.00	40.00	-25.00	QP		
3		102.0014	31.54	-21.04	10.50	43.50	-33.00	QP		
4		420.5803	36.95	-16.65	20.30	46.00	-25.70	QP		
5		576.6443	32.78	-11.68	21.10	46.00	-24.90	QP		
6	*	909.6667	30.56	-6.06	24.50	46.00	-21.50	QP		

*:Maximum data x:Over limit !:over margin

Operator: KK

10.8 CONDUCTED EMISSION TEST

10.8.1 Applicable Standard

According to FCC Part 15.207(a)

10.8.2 Conformance Limit

Frequency(MHz)	Conducted Emission Limit	
	Quasi-peak	Average
0.15-0.5	66-56	56-46
0.5-5.0	56	46
5.0-30.0	60	50

Note: 1. The lower limit shall apply at the transition frequencies
2. The limit decreases in line with the logarithm of the frequency in the range of 0.15 to 0.50MHz.

10.8.3 Test Configuration

Test according to clause 7.3 conducted emission test setup

10.8.4 Test Procedure

The EUT was placed on a table which is 0.8m above ground plane.
Maximum procedure was performed on the highest emissions to ensure EUT compliance.
Repeat above procedures until all frequency measured were complete.

10.8.5 Test Results

PASS

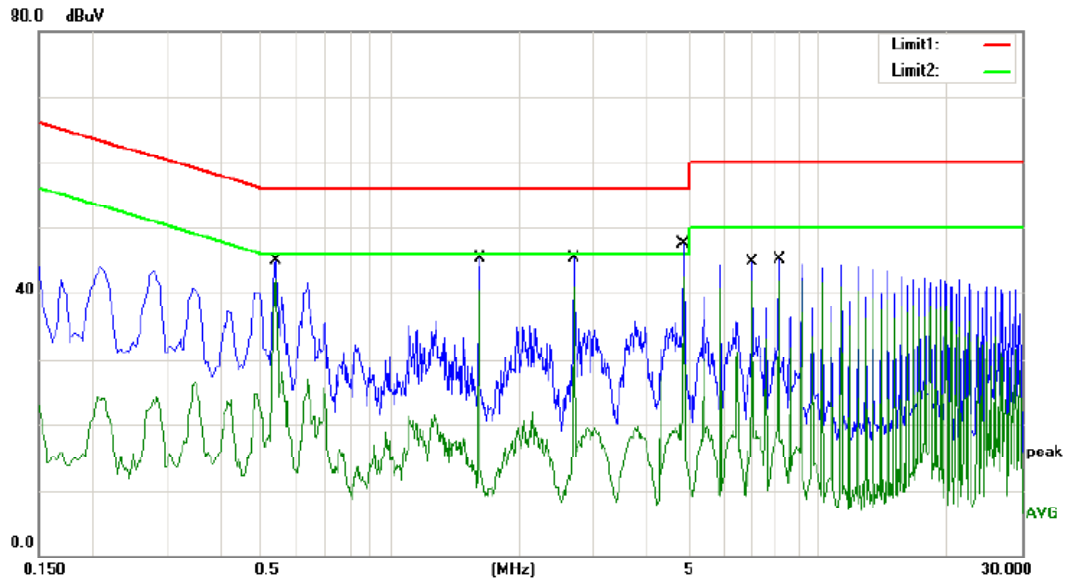

Site site #1 Phase: **N** Temperature: 18
 Limit: (CE)FCC PART 15 class B_QP Power: AC120V/60Hz Humidity: 43 %
 Mode: charging+Bluetooth working
 Note:

No.	Mk.	Freq.	Reading Level	Correct Factor	Measurement	Limit	Over	Detector	Comment
		MHz	dBuV	dB	dBuV	cBuV	dB		
1		0.5420	34.80	10.09	44.89	56.00	-11.11	QP	
2		0.5420	31.80	10.09	41.89	46.00	-4.11	AVG	
3		1.6140	35.50	9.90	45.40	56.00	-10.60	QP	
4		1.6140	30.60	9.90	40.50	46.00	-5.50	AVG	
5		2.6900	35.20	10.01	45.21	56.00	-10.79	QP	
6		2.6900	30.80	10.01	40.81	46.00	-5.19	AVG	
7		4.8300	37.20	10.28	47.48	56.00	-8.52	QP	
8	*	4.8300	32.10	10.28	42.38	46.00	-3.62	AVG	
9		6.9920	34.30	10.40	44.70	60.00	-15.30	QP	
10		6.9920	31.20	10.40	41.60	50.00	-8.40	AVG	
11		8.0720	34.70	10.46	45.16	60.00	-14.84	QP	
12		8.0720	31.30	10.46	41.76	50.00	-8.24	AVG	

*:Maximum data x:Over limit !:over margin Comment: Factor build in receiver. Operator: YYF

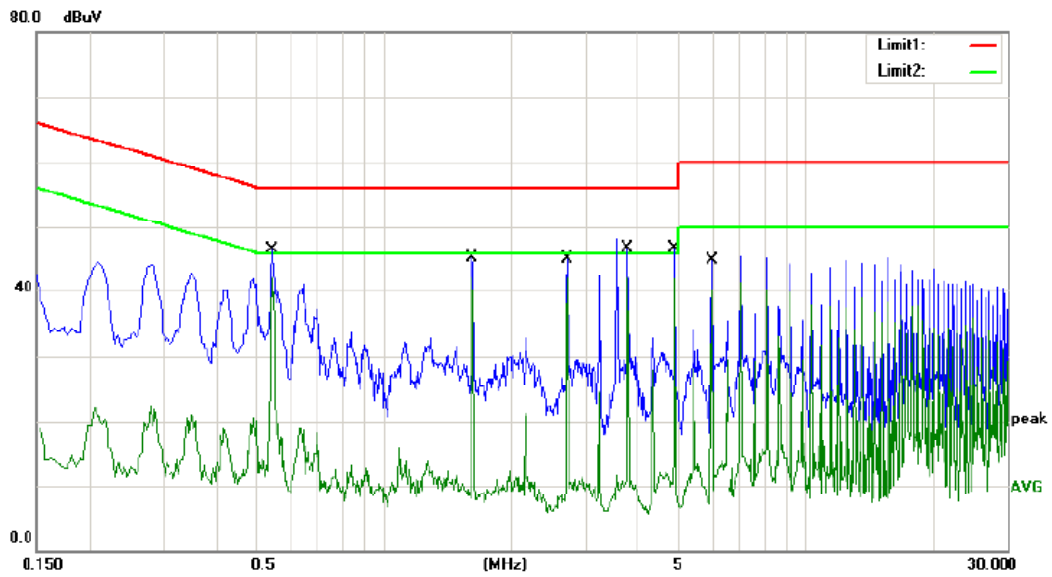

Site: site #1 Phase: **L1** Temperature: 18
 Limit: (CE)FCC PART 15 class B_QP Power: AC120V/60Hz Humidity: 43 %
 Mode: charging+Bluetooth working
 Note:

No.	Mk.	Frcq.	Reading Level	Correct Factor	Measurement	Limit	Over	Detector	Comment
		MHz	dBuV	dB	dBuV	dBuV	dB		
1		0.5420	36.40	10.06	46.46	56.00	-9.54	QP	
2		0.5420	32.00	10.06	42.06	46.00	-3.94	AVG	
3		1.6260	35.10	10.07	45.17	56.00	-10.83	QP	
4	*	1.6260	32.00	10.07	42.07	46.00	-3.93	AVG	
5		2.7100	34.90	10.17	45.07	56.00	-10.93	QP	
6		2.7100	31.90	10.17	42.07	46.00	-3.93	AVG	
7		3.7940	36.30	10.25	46.55	56.00	-9.45	QP	
8		3.7940	31.80	10.25	42.05	46.00	-3.95	AVG	
9		4.8780	36.30	10.34	46.64	56.00	-9.36	QP	
10		4.8780	31.60	10.34	41.94	46.00	-4.06	AVG	
11		5.9680	34.40	10.38	44.78	60.00	-15.22	QP	
12		5.9680	29.70	10.38	40.08	50.00	-9.92	AVG	

*:Maximum data x:Over limit !:over margin Comment: Factor build in receiver. Operator: YYF

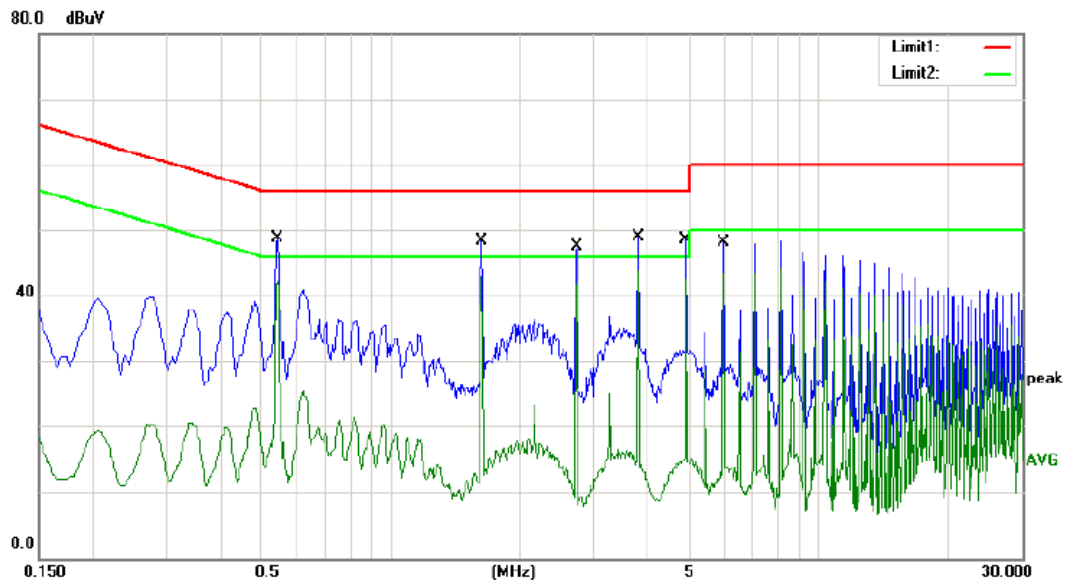

Site site #1 Phase: **L1** Temperature: 18
 Limit: (CE)FCC PART 15 class B_QP Power: AC 240V/60Hz Humidity: 43 %
 Mode: charging+Bluetooth working
 Note:

No.	Mk.	Freq.	Reading Level	Correct Factor	Measurement	Limit	Over	Detector	Comment
		MHz	dBuV	dB	dBuV	dBuV	dB		
1		0.5460	38.60	10.06	48.66	56.00	-7.34	QP	
2		0.5460	32.00	10.06	42.06	46.00	-3.94	AVG	
3		1.6300	38.20	10.07	48.27	56.00	-7.73	QP	
4		1.6300	32.80	10.07	42.87	46.00	-3.13	AVG	
5		2.7220	37.30	10.17	47.47	56.00	-8.53	QP	
6		2.7220	32.10	10.17	42.27	46.00	-3.73	AVG	
7		3.8100	38.60	10.25	48.85	56.00	-7.15	QP	
8	*	3.8100	33.30	10.25	43.55	46.00	-2.45	AVG	
9		4.8860	38.20	10.34	48.54	56.00	-7.46	QP	
10		4.8860	32.20	10.34	42.54	46.00	-3.46	AVG	
11		5.9840	37.70	10.38	48.08	60.00	-11.92	QP	
12		5.9840	32.80	10.38	43.18	50.00	-6.82	AVG	

*:Maximum data x:Over limit !:over margin Comment: Factor build in receiver. Operator: YYF

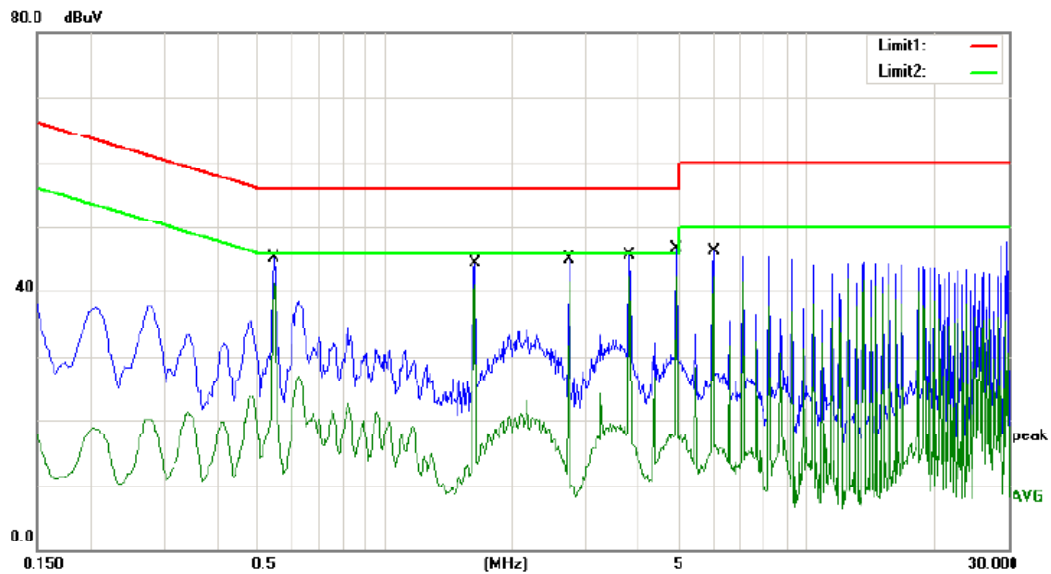

Site site #1 Phase: **N** Temperature: 18
 Limit: (CE)FCC PART 15 class B_QP Power: AC 240V/60Hz Humidity: 43 %
 Mode: charging | Bluetooth working
 Note:

No.	Mk.	Freq.	Reading	Correct	Measure-	Limit	Over		
		MHz	Level	Factor	ment			Detector	Comment
			dBuV	dB	dBuV	dBuV	dB		
1		0.5460	35.10	10.09	45.19	56.00	-10.81	QP	
2		0.5460	31.10	10.09	41.19	46.00	-4.81	AVG	
3		1.6380	34.50	9.90	44.40	56.00	-11.60	QP	
4		1.6380	30.90	9.90	40.80	46.00	-5.20	AVG	
5		2.7260	34.90	10.01	44.91	56.00	-11.09	QP	
6		2.7260	31.20	10.01	41.21	46.00	-4.79	AVG	
7		3.8180	35.50	10.15	45.65	56.00	-10.35	QP	
8		3.8180	31.80	10.15	41.95	46.00	-4.05	AVG	
9		4.9060	36.40	10.29	46.69	56.00	-9.31	QP	
10	*	4.9060	31.70	10.29	41.99	46.00	-4.01	AVG	
11		5.9960	35.90	10.35	46.25	60.00	-13.75	QP	
12		5.9960	31.80	10.35	42.15	50.00	-7.85	AVG	

*:Maximum data x:Over limit !:over margin Comment: Factor build in receiver. Operator: YYF

10.9 ANTENNA APPLICATION

10.9.1 Antenna Requirement

Standard	Requirement
FCC CRF Part15.203	An intentional radiator shall be designed to ensure that no antenna other than that furnished by the responsible party shall be used with the device. The use of a permanently attached antenna or of an antenna that uses a unique coupling to the intentional radiator shall be considered sufficient to comply with the provisions of this section. The manufacturer may design the unit so that a broken antenna can be replaced by the user, but the use of a standard antenna jack or electrical connector is prohibited. This requirement does not apply to carrier current devices or to devices operated under the provisions of §15.211, §15.213, §15.217, §15.219, or §15.221. Further, this requirement does not apply to intentional radiators that must be professionally installed, such as perimeter protection systems and some field disturbance sensors, or to other intentional radiators which, in accordance with §15.31(d), must be measured at the installation site. However, the installer shall be responsible for ensuring that the proper antenna is employed so that the limits in this part are not exceeded.

For intentional device, according to FCC 47 CFR Section 15.203, an intentional radiator shall be designed to ensure that no antenna other than that furnished by the responsible party shall be used with the device. And according to FCC 47 CFR Section 15.247 (b), if transmitting antennas of directional gain greater than 6dBi are used, the power shall be reduced by the amount in dB that the directional gain of the antenna exceeds 6dBi.

10.9.2 Result

The EUT'S antenna is PCB antenna. The antenna's gain is 0.94 dBi, and the antenna can't be replaced by the user which in accordance to section 15.203, please refer to the photos.

-----The end-----