

 TECKIN

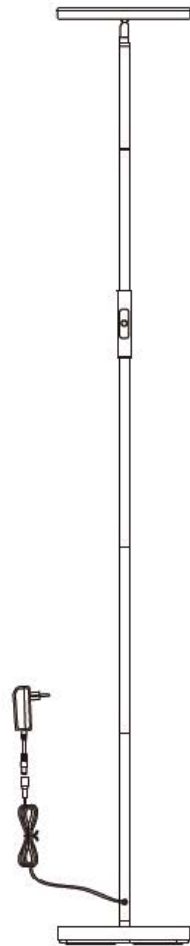

User Manual
LED Floor Lamp

Introduction

Thank you for choosing TECKIN FL41 Dimmable LED Floor Lamp. Please read the user manual carefully and keep it for future reference. If you need further assistance, please contact TECKIN customer support by email at support.eu@teckin.co | support.us@teckin.co

Package Contents

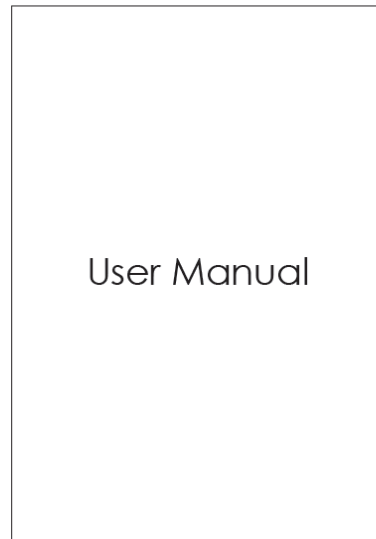
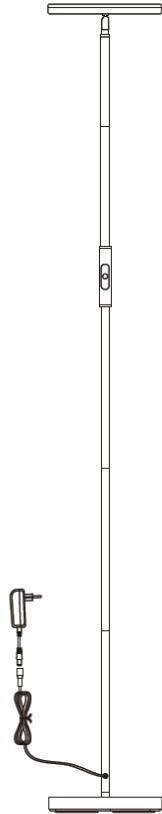

- 1 x TECKIN FL41 Dimmable LED Floor Lamp
- 1 x User Manual

Specifications

Model	MF18228
Rated Power	20W
Input Voltage	100-240V AC 50Hz/60Hz
Adapter Output	DC24V,1A
Type of Light	LED
CCT	3000K
CRI	>80Ra
Lumen	2000LM
Material	Iron+ PC
finish	Matt Black
Dimension of light	D250*H1750mm
Safety class	Class II
Light source life	50000H

Product Overview

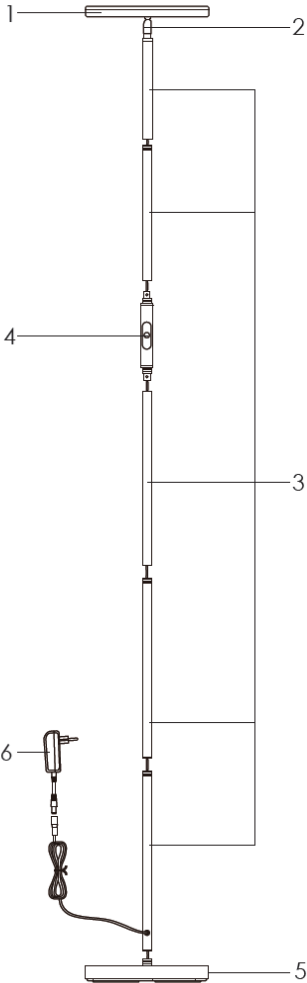

- 1. Light Guide Panel
- 2. Flexible Neck
- 3. Lamp Pole
- 4. CCT Control And Brightness Button
- 5. Lamp Base
- 6. Adapter

Before Assembly

1. Inspect lamp before beginning assembly. Wire connections have been made at the factory and the lamp is ready for assembly.
2. Remove all packing materials from the lamp.
3. To prevent bad connections, avoid pulling wiring connections when removing contents from package or during installation.
4. Lay out all the parts on a flat surface.
5. The floor lamp consists of seven parts: 1 x Lamp Head, 5 x Pole, 1 x Lamp Base, 1 x Electric Wire with Adapter (Refer to Illustration).

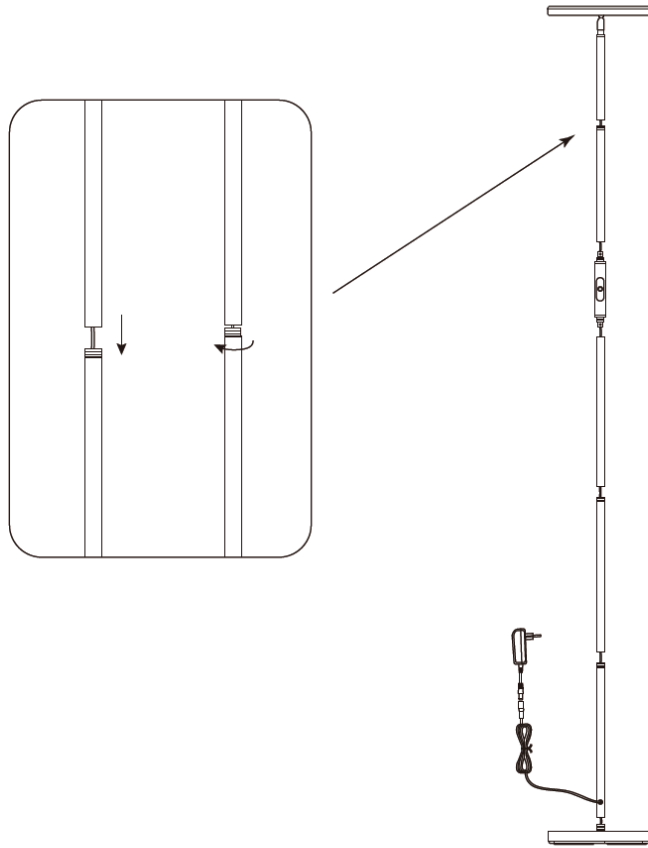

Assembly Instruction

1. Place the lamp base on flat surface, then screw each two parts clockwise in order.

Note:

- 1) Please take care not to pinch or damage the wires.
- 2) For better installation, please tighten the bottom pole and lamp base firstly.
- 3) Make sure each section of tubes are tightened.

2. Plug adapter into outlet and now the lamp is ready for use.

Adjustment

For best performance, please adjust the lamp position to directly above your area of reading/ working.

Note:

1. Please hold the lamp pole when adjusting the angle of the floor lamp.
2. Do not excessively adjust the angle of lamp head to avoid failure.

Operation Instruction

1. Product Features / Functions

- 1) The product is embedded in an smart control module that can be connected to a WIFI network and controlled by Amazon Echo, Google Home, Tmall Elf third-party software.
- 2) The product can be controlled by mobile APP.
- 3) The button body keeps a one-touch switch, and stepless dimming with the brightness of 5%-100%. It also has the memory function. When the light is turned on again, it will return to the brightness when the light was turned off last time. It does not need to dim repeatedly.
- 4) The lamp will light when it is powered on (100% brightness), and multiple switches can be turned on/off by the main switch.
- 5) The lampshade has PMMA high-transmittance, and the lumen can reach to 1500LM.
- 6) LED uses Epistar chip, and it has a stable light color. The lamp life can reach 30,000 hours. No blue light hazard.
- 7) The surface of the lamp body is dull polished and the metal texture is enhanced.

1. Manual operation steps

A. Button switch operation

The floor lamp has one touch-sensitive button: Brightness Control Button.

Brightness Control Button

Touch the brightness control button and then lamp will cycle through three options in the following orders:

Tap Once: Light turns on with low brightness.

Tap and hold: Keep getting brighter light.

Tap Once Again: Light turns off.

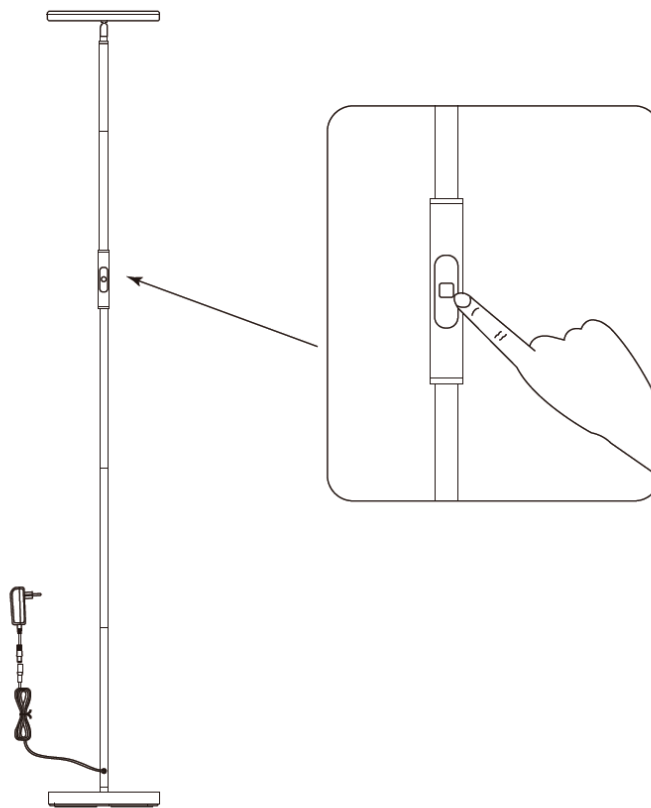

B. Rotatable angle of the Light Guide Panel

Only turn the lighting table manually, and the lighting table can be rotated 90 degrees up and down. The two extreme positions are parallel to the lamp hole and perpendicular to the lamp hole respectively.

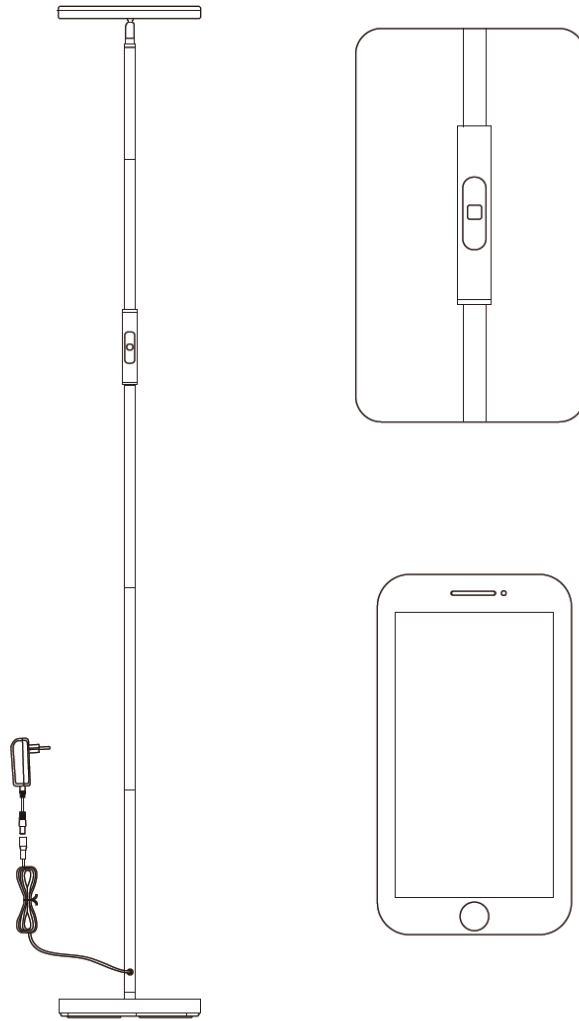

2. Smart Control Operation Steps

1) Download TuyaSmart App

Please scan the QR code below to download the TuyaSmart App.



You can also download the TuyaSmart App by App Store or searching "TuyaSmart" in Android Application.

2) Create a TuyaSmart Account and Sign in.

Open TuyaSmart App, then create a TuyaSmart Account and Sign in in this page.

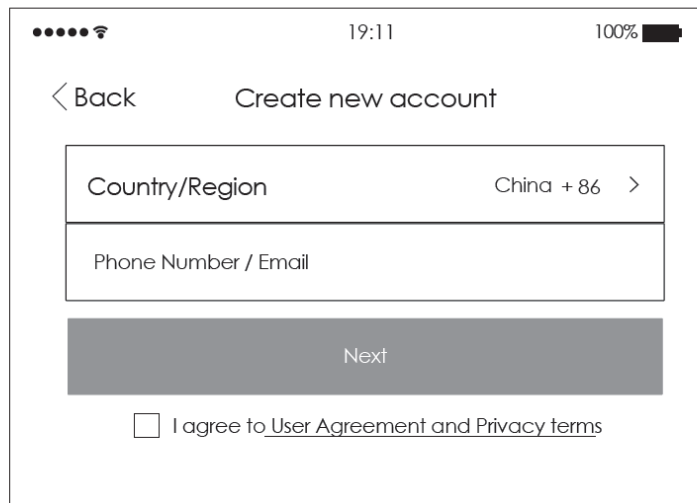
A screenshot of a mobile application interface for creating a new account. At the top, there is a status bar with signal strength, time (19:11), and battery (100%). Below the status bar, there is a navigation bar with a back arrow and the text "Create new account". The main content area contains three input fields: "Country/Region" with a dropdown menu showing "China + 86" and a right arrow; "Phone Number / Email"; and a "Next" button. At the bottom, there is a checkbox labeled "I agree to [User Agreement and Privacy terms](#)".

3) Add families. You need to fill in Home Name, and choose Family Location. Then choose a room that are equipped with smart devices.

The screenshot shows a mobile application interface for adding families. At the top, there is a status bar with signal strength, time (19:12), and battery level (95%). Below the status bar are three buttons: "Cancel", "Add families", and "Done". The main form has two input fields: "Home Name" with the placeholder text "Enter Home Name" and "Family Location" with the placeholder text "Set location" and a right-pointing chevron. Below these fields is a section titled "Which rooms are equipped with smart devices?". This section contains a list of rooms, each with a red checkmark in a circle to its right: Living Room, Master Room, Second Bedroom, Dining Room, Kitchen, and Study Room. Below the list is a red link labeled "Add other rooms". At the bottom, there is a light gray box containing the text "Later, room settings can be modified at any time."

4) Choose "All devices"

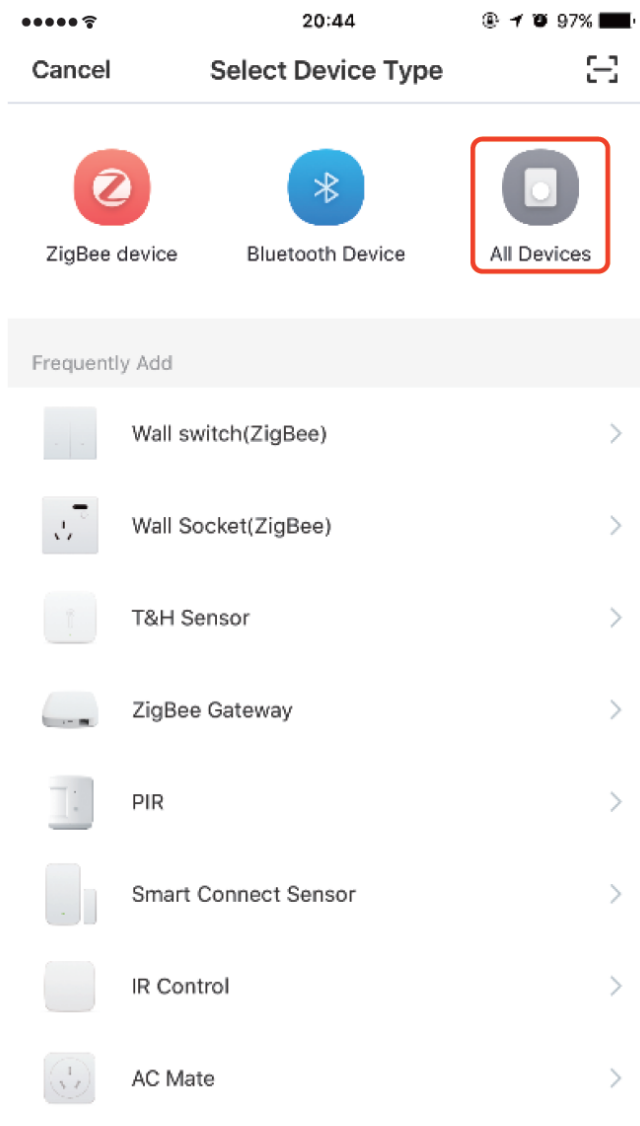

5) Choose "Lighting devices".

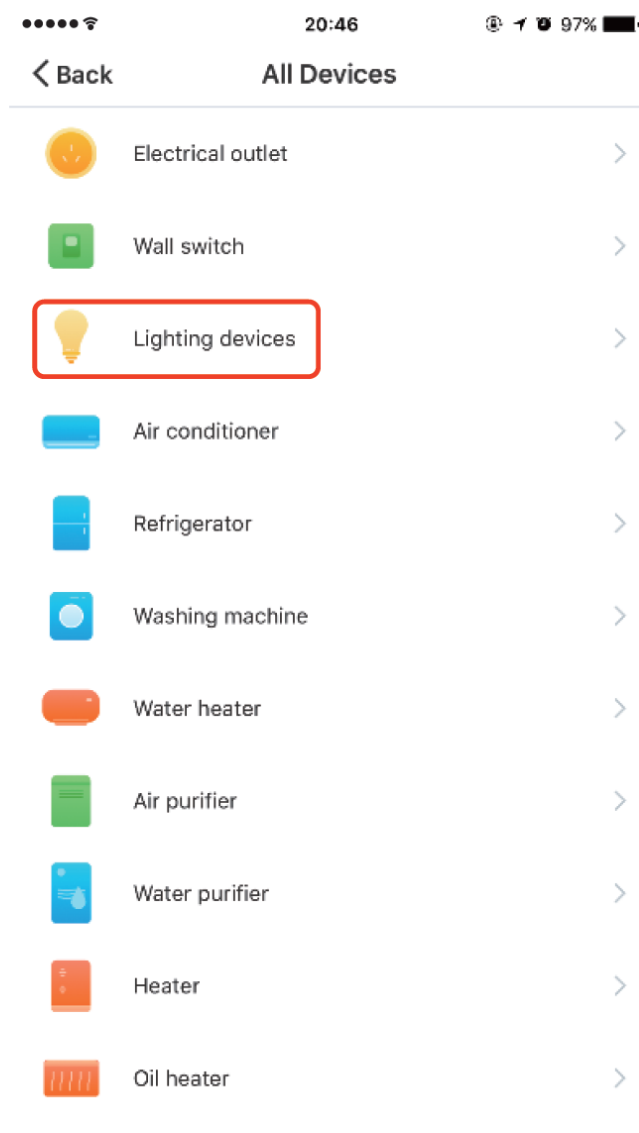

6) After entering this page, first the lamp is powered off more than 10 seconds, then the lamp will be powered on-off-on-off-on-off-on three times.

(**Note:** Powering on and off mean you need to plug and unplug the lamp, instead of touch the switch in the lamp.)

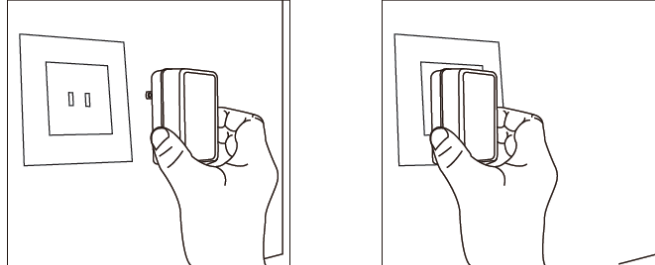

At this time, the lamp will enter the flash mode. Finally click the “Confirm light blinks rapidly” in this page.

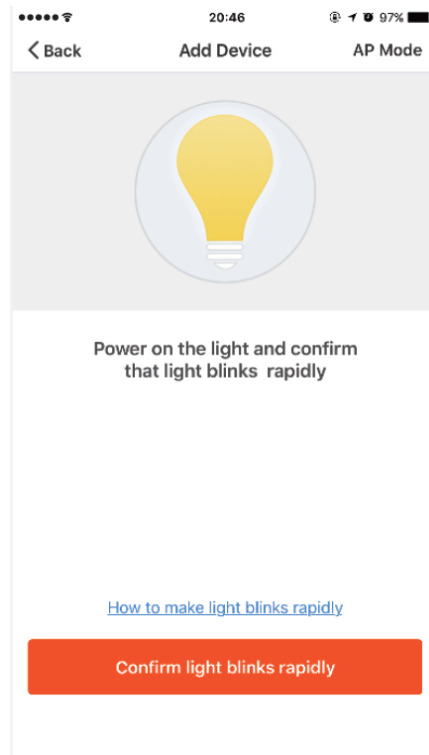

7) Enter WIFI password and click the "Confirm". (Note: Only 2.4GHz Wi-Fi are supported)

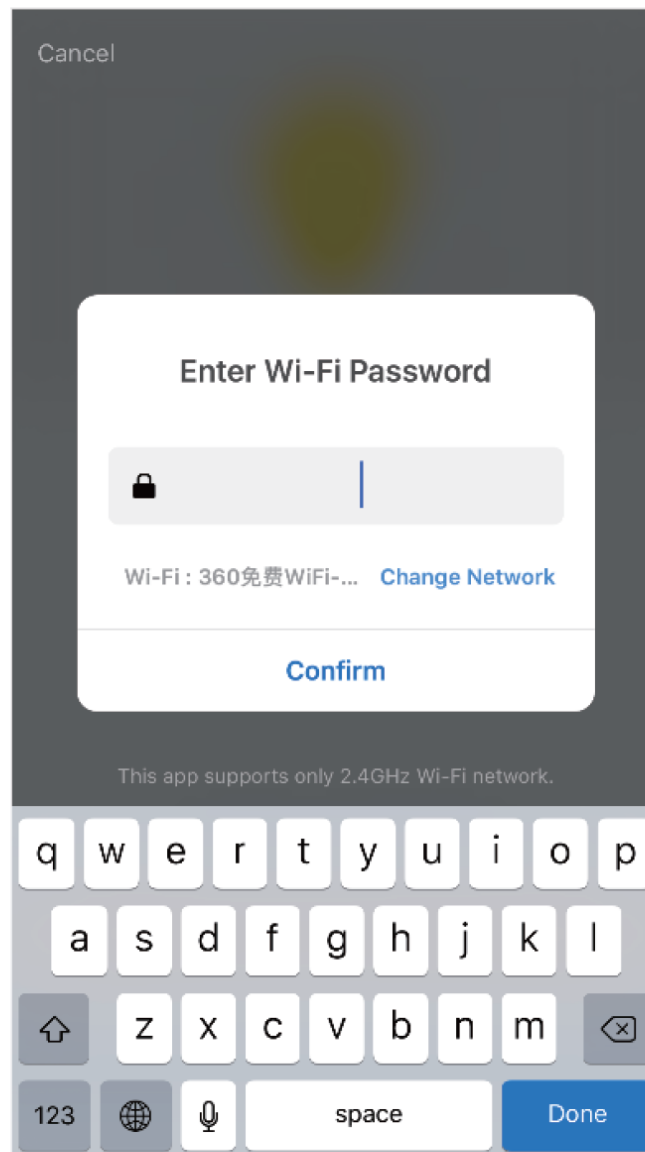

8) Then mobile App matches with the lamp. (The connection time depends on the network speed, usually 10-30 seconds)

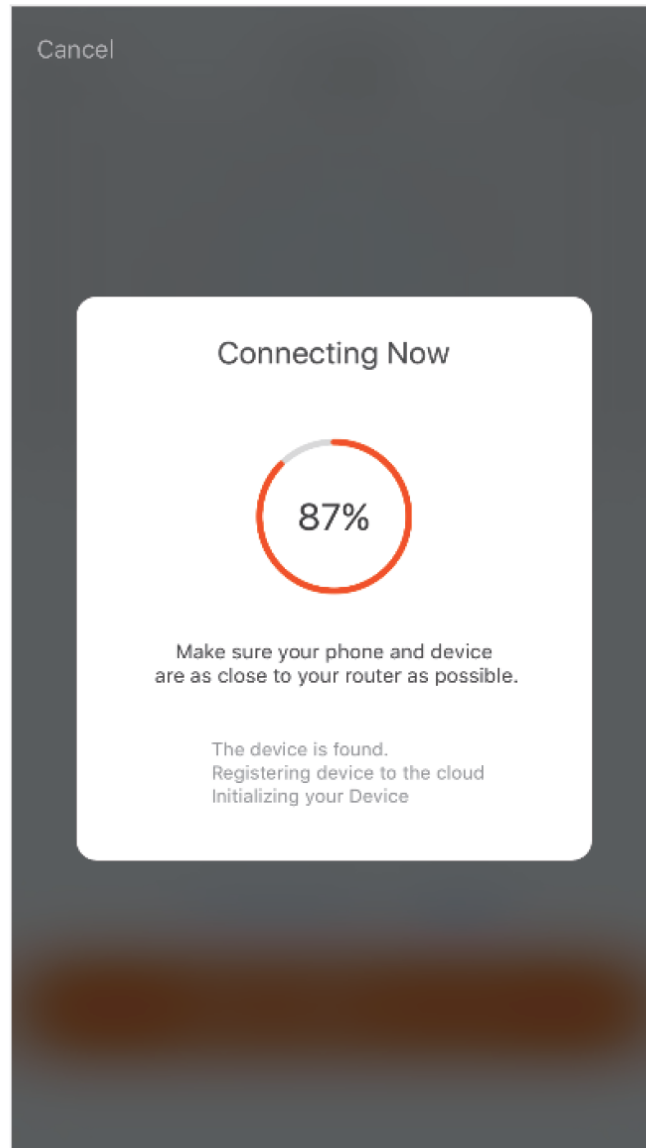

9) After adding the device successfully, you can rename the fixture according to your personal preference. After saving, click the "Done".

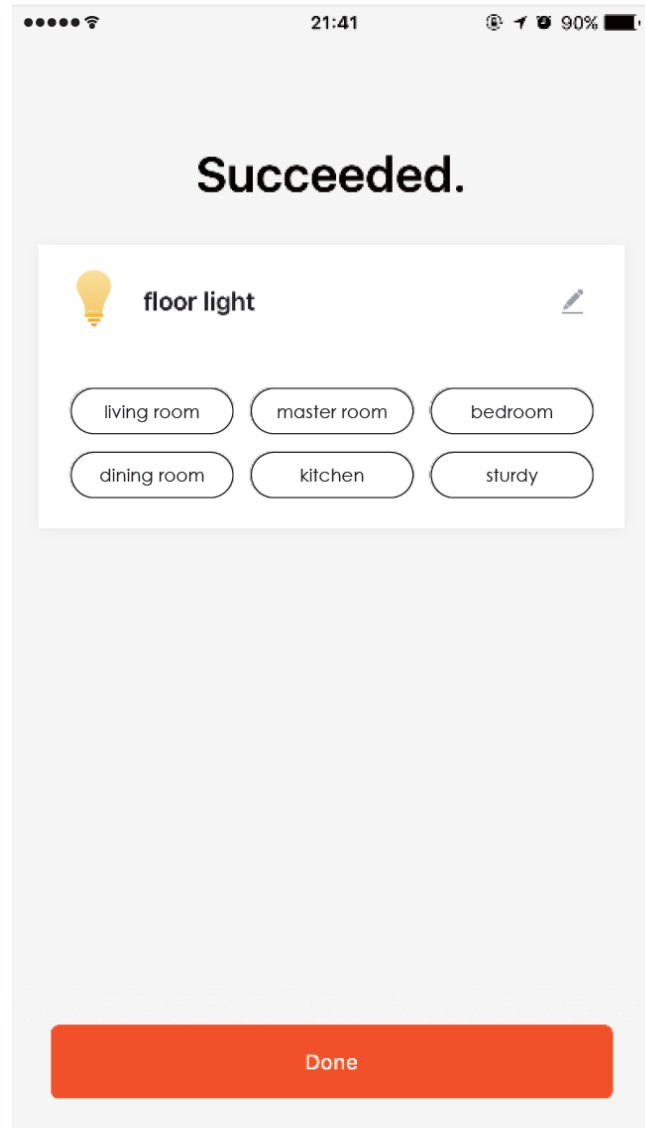

10) Click the lamp you want to control and enter the operation page to control the lamp.



How To Connect Your Devices To Amazon Alexa, Google Assistant, IFTTT, Etc.

1. Open your Tuya Smart APP, find your "profile", and click "settings" and "Integration".

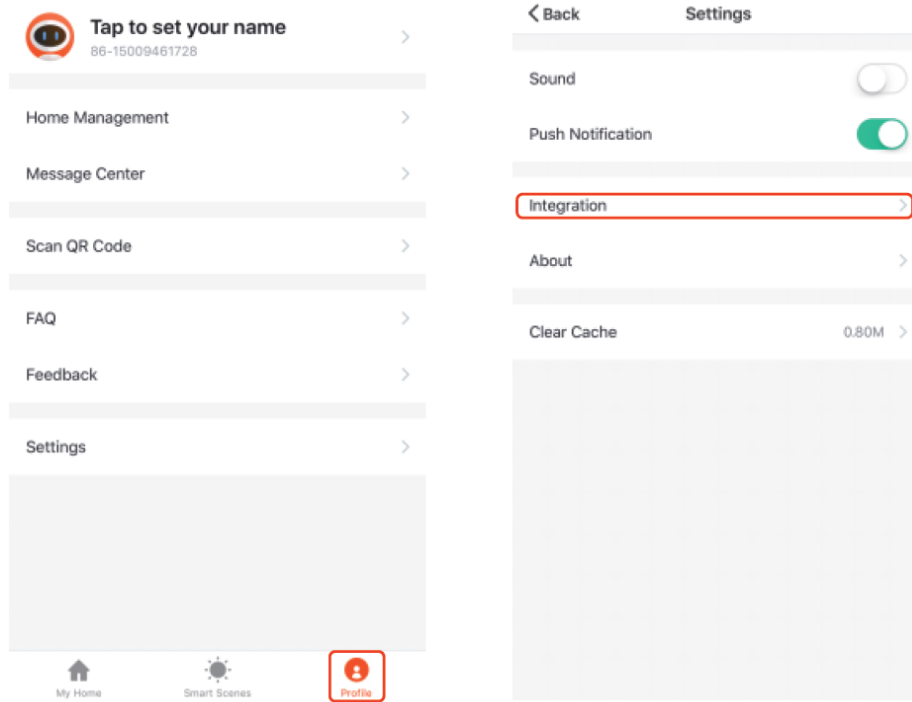

2. Then choose the one you want to connect. There are guiding steps respectively as below.

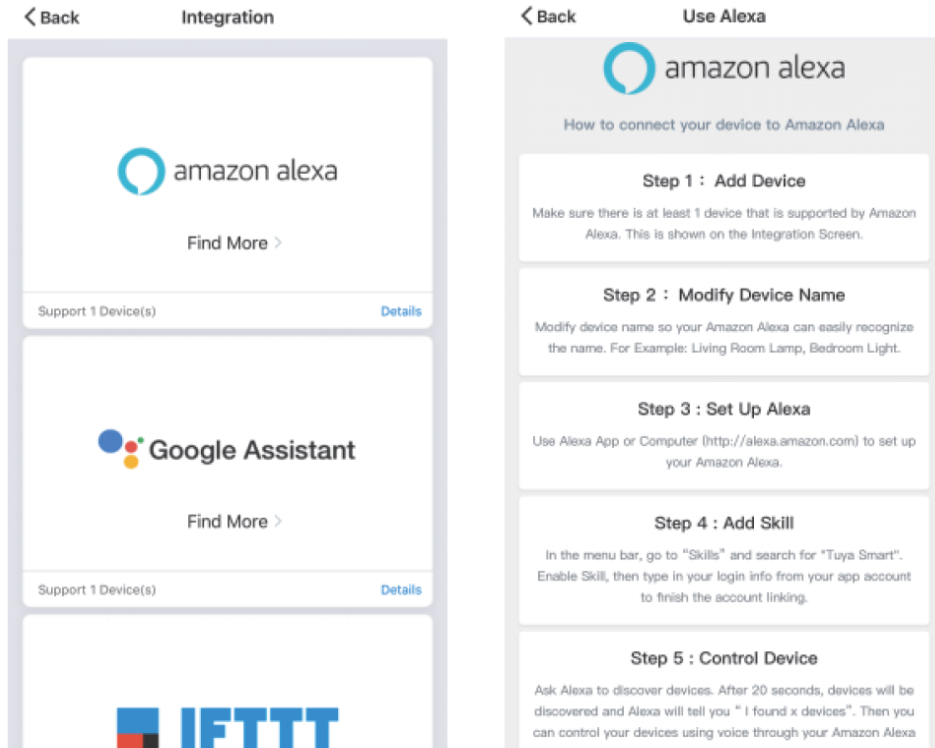

Taking Alexa As a Example

Step 1 : Set up Alexa

(Note: The following setting steps may be simple. If you want to know more details about setting steps, you can read the Amazon Alexa instruction.)

1. Use Alexa App to set up your Amazon Alexa. (If you had an Amazon account, just sign in. If you don't, you need to create an Amazon account.)
2. Click "Alexa devices", choose Echo Dot and begin Echo dot setup.

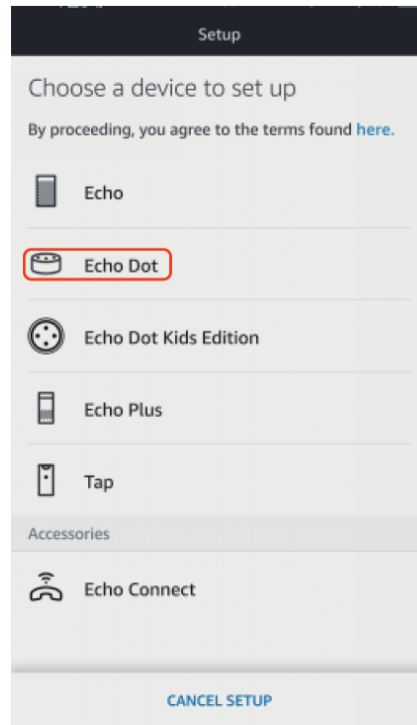
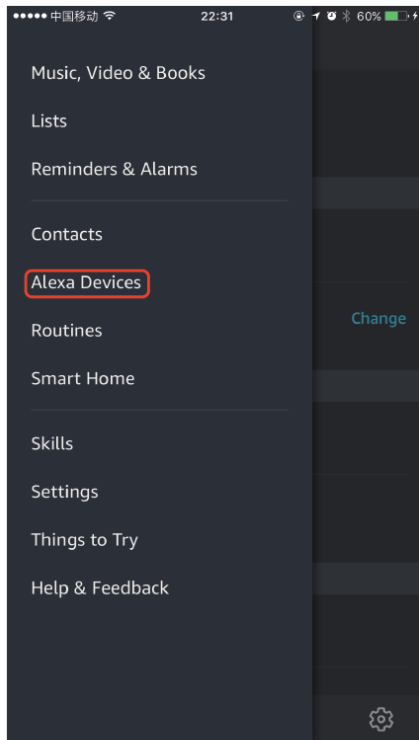

3. Find the Echo Dot Wi-Fi, and wait for your iPhone to connect to Echo dot.

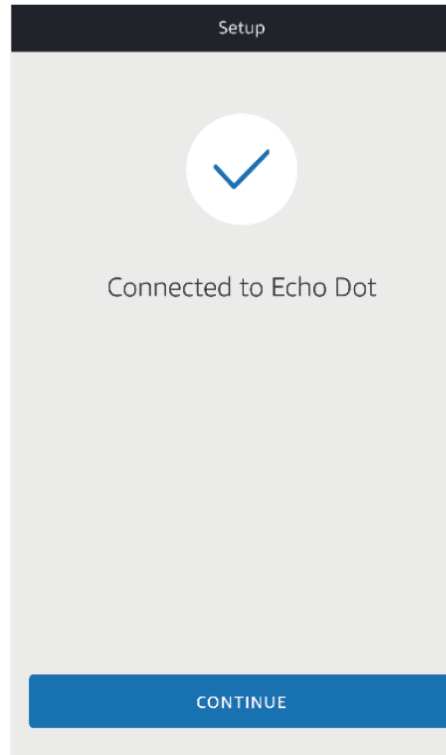
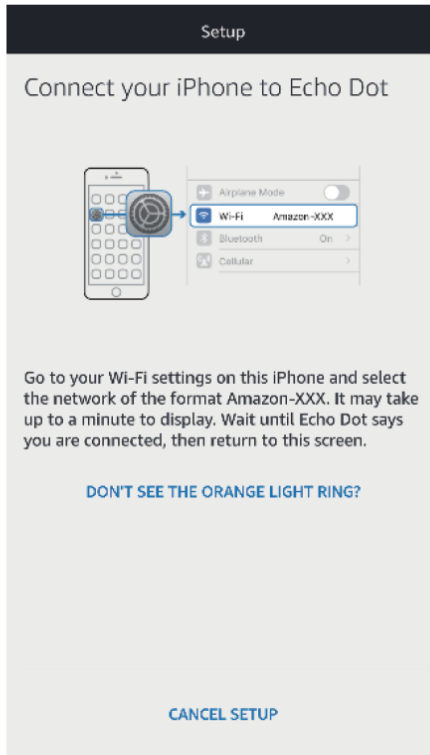

4. After connecting to the Echo Dot, select your Wi-Fi network.

(Note: The Wi-Fi network must be consistent with the Echo Dot's Wi-Fi, and you need to choose 2.4HGz Wi-Fi.)

After completing the setup, you can use "Alexa" to wake up your device.

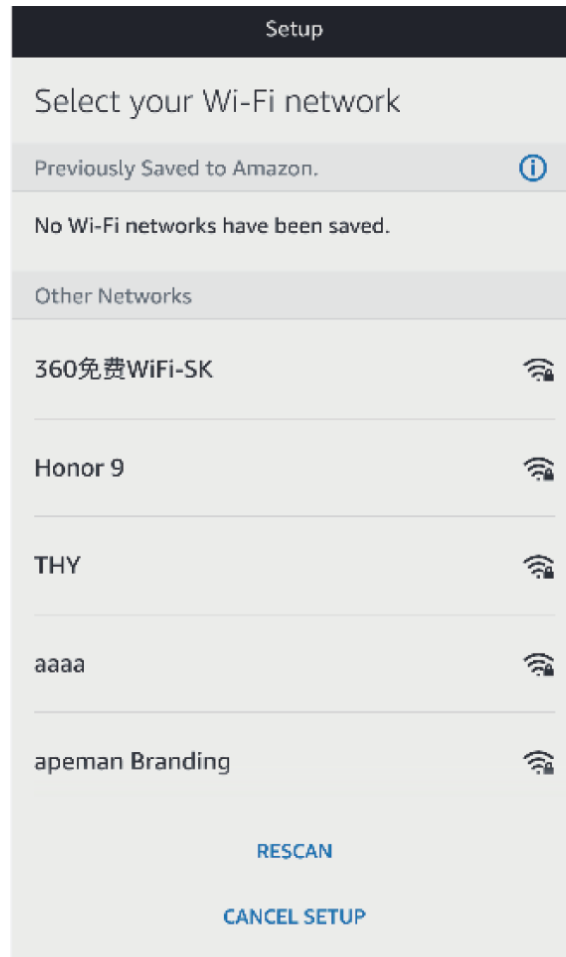

Step 2 : Add Skill

1. In the menu bar, go to "Skill" and search for "Tuya Smart" .

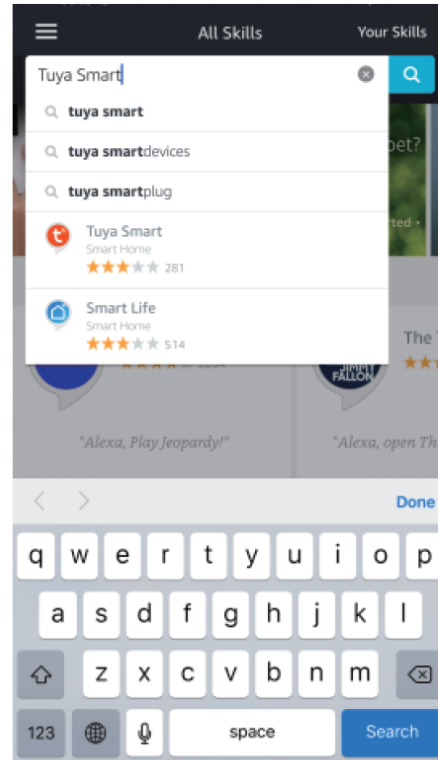
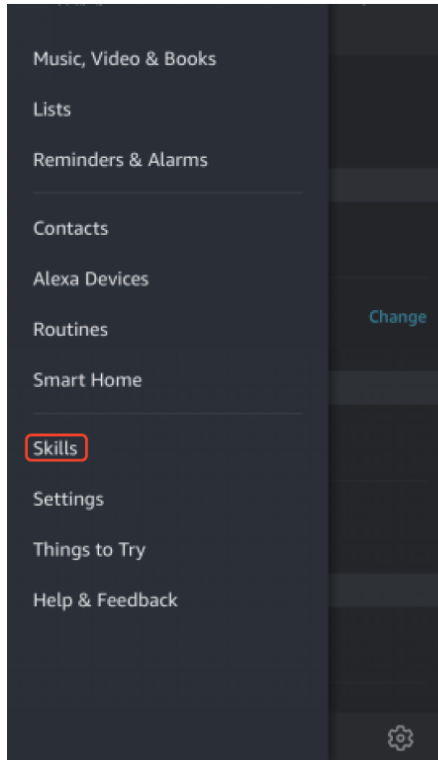

2. Enable Skill, and type in your login from app account to finish the account linking.

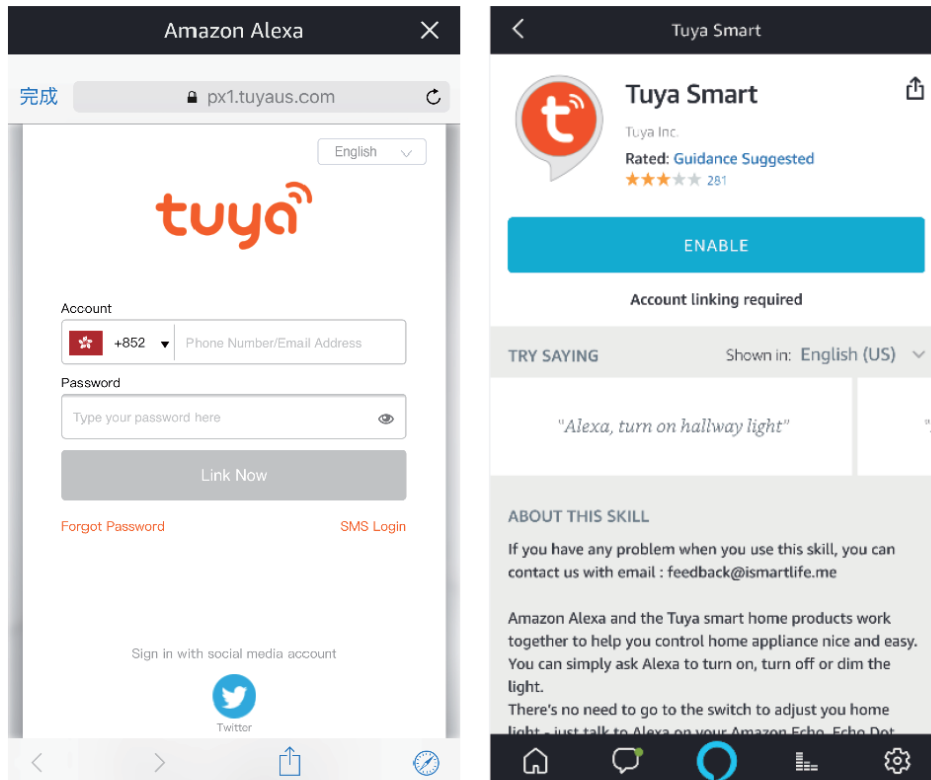

3. You need to click "Authorize" to complete the link.

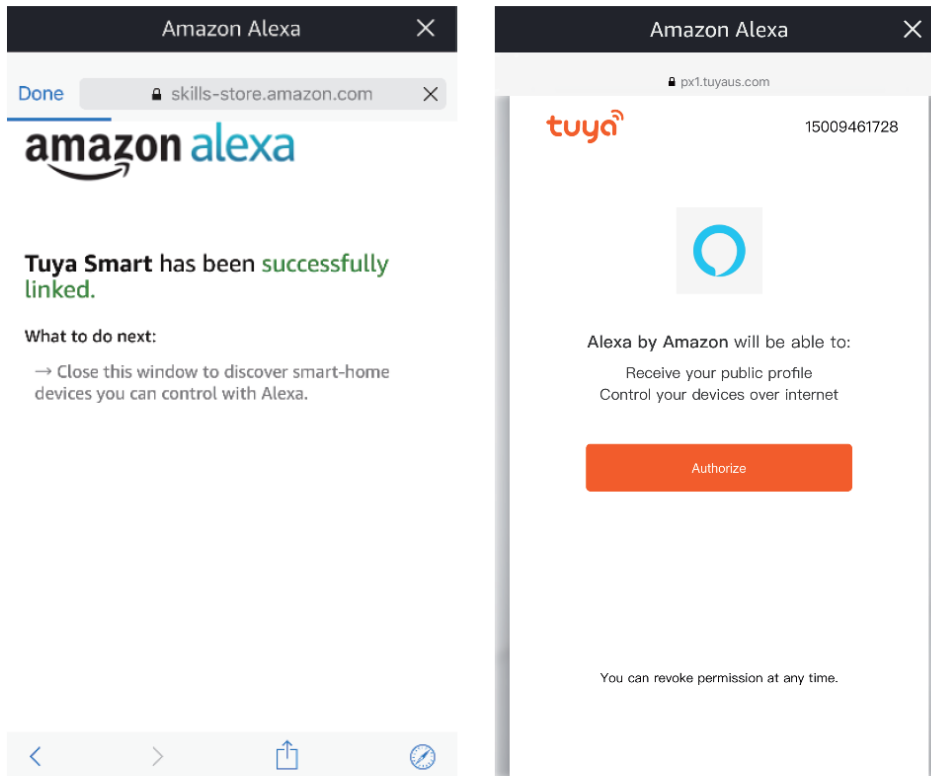

Step 3 : Control Device

1. After 20 seconds, devices will be discovered and Alex will tell you " I find a device". Then you can control your devices using voice through Amazon Alexa product.

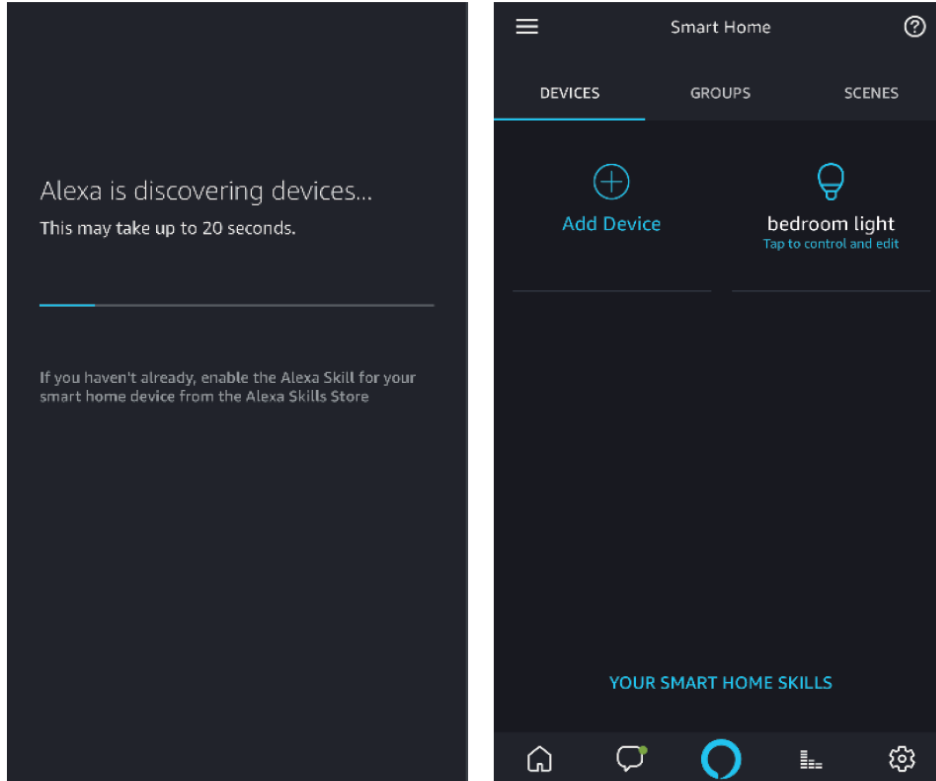

The following voice commands are supported:

- Alexa, turn on the bedroom light.
- Alexa, set bedroom light to 0-100%.
- Alexa, brighten bedroom light.

(Note: You need to choose **2.4HGz** Wi-Fi in the whole process.)

Cautions

- Do not put the lamp close to TV or other radio devices to avoid noise.
- Do not repair, disassemble, or modify under any circumstances.
- Do not place near any heat source or in direct sunlight.
- Do not place on uneven, unsecure floor.
- Do not use appliance when the electrical cord is frayed or damaged.
- Do not touch electrical appliance with wet hands or when liquids are present.
- Please keep the lamp dry and clean.
- Unplug the adapter when the lamp is not used.
- Power off before cleaning.
- Clean the lamp only with soft dry cloth.
- Never overload electrical circuits as it may cause electrical shock or fire.

Warranty

We warrant TECKIN products for **36 MONTHS** from date of the original purchase. If the product fails due to any manufacturing defect, please contact TECKIN support by emailing to support.eu@teckin.co | support.us@teckin.co with your purchase order number and details of the problem.

We only provide after-sales support for products purchased from TECKIN or TECKIN authorized distributors. If you have purchased the product from a seller other than TECKIN, please contact your seller for warranty cover.

Warning:

This device complies with Part 15 of the FCC Rules. Operation is subject to the following two conditions: (1) this device may not cause harmful interference, and (2) this device must accept any interference received, including interference that may cause undesired operation.

changes or modifications not expressly approved by the party responsible for compliance could void the user's authority to operate the equipment.

NOTE: This equipment has been tested and found to comply with the limits for a Class B digital device, pursuant to Part 15 of the FCC Rules. These limits are designed to provide reasonable protection against harmful interference in a residential installation. This equipment generates, uses and can radiate radio frequency energy and, if not installed and used in accordance with the instructions, may cause harmful interference to radio communications. However, there is no guarantee that interference will not occur in a particular installation. If this equipment does cause harmful interference to radio or television reception, which can be determined by turning the equipment off and on, the user is encouraged to try to correct the interference by one or more of the following measures:

- Reorient or relocate the receiving antenna.
- Increase the separation between the equipment and receiver.
- Connect the equipment into an outlet on a circuit different from that to which the receiver is connected.
- Consult the dealer or an experienced radio/TV technician for help.

NOTE: This device and its antenna(s) must not be co-located or operation in conjunction with any other antenna or transmitter

RF Exposure Statement

To maintain compliance with FCC's RF Exposure guidelines, This equipment should be installed and operated with minimum distance of 20cm the radiator your body. This device and its antenna(s) must not be co-located or operation in conjunction with any other antenna or transmitter