

## OPERATING INSTRUCTIONS

Carefully remove items from package.

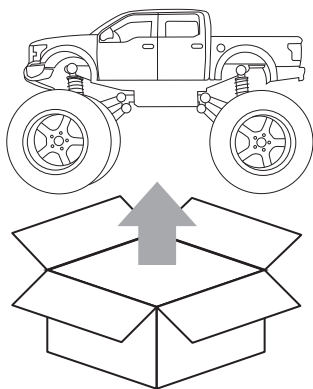

The truck requires 3 "AA" 1.5V batteries (not included). When changing batteries, adult supervision is required. Use alkaline batteries for the best performance.

Locate the battery compartment on the bottom of the truck and the side of the remote controller and remove the battery cover doors. Insert "AA" 1.5V batteries in truck, and 9V batteries into controller and replace the battery compartment doors and screws.

Use tool to press the fastener and release the battery door for the remote controller.

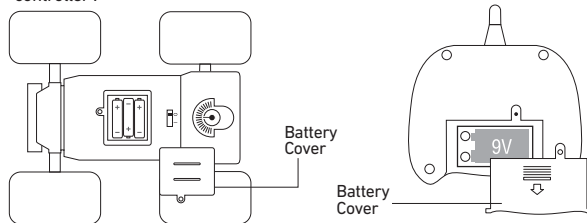

Switch both car and remote buttons to "I" position. For best result use the car on hard surfaces such as wood or tile.

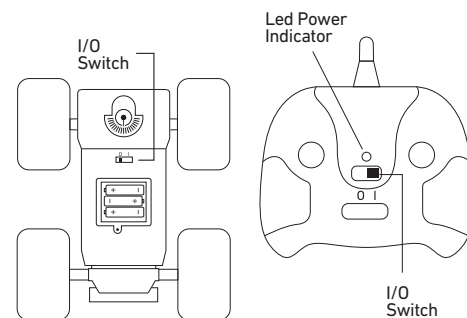

### Reverse

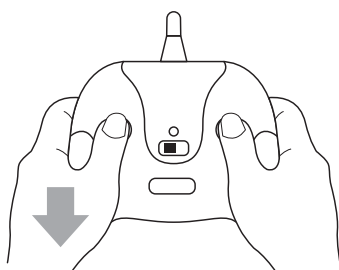
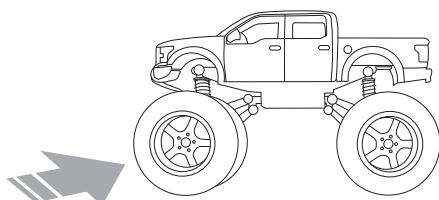

### Forward

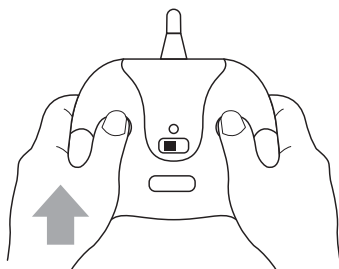
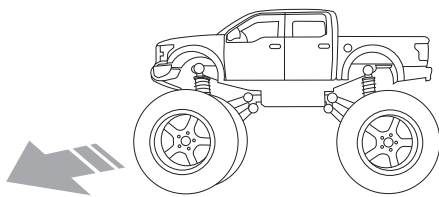

### Left Turn

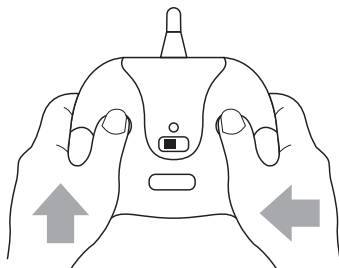
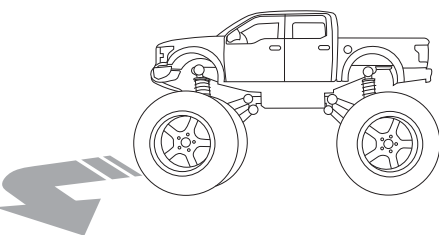

### Right Turn

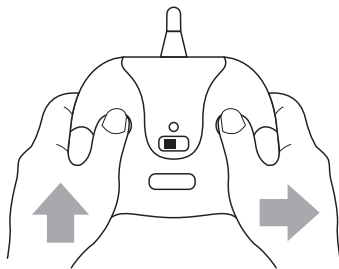
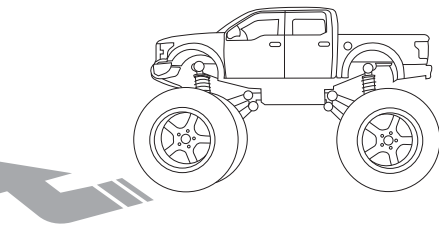

### Wheel Alignment

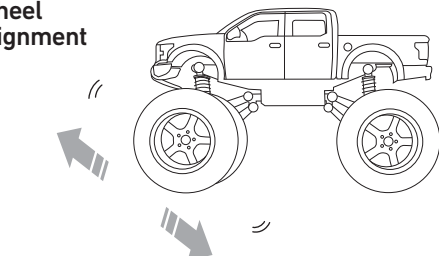

If the car does not drive straight, use the Wheel Alignment dial

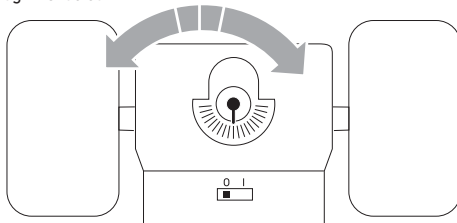

## SAFETY PRECAUTIONS

- Do not operate during thunderstorms or rain.
- Avoid water, sand and snow when operating car.
- Do not submerge car or controller in water.
- Never operate your car on the street or highway.
- Never operate your car in a confined or crowded area, and do not use people or animals as obstacles.
- Do not run your car into furniture, objects or hard surface, as this will cause damage to both the objects and your car.
- Keep fingers, hair and loose clothing away from the tires, gears and motor while the car is switched to "ON".
- Do not leave car or transmitter near source of heat or under direct sunlight for long periods of time.
- Do not leave car or transmitter outside overnight. Dampness is harmful to interior components.
- Remove all batteries when not in use to avoid accidental operation.
- Adult supervision is recommended when operating this car.

### BATTERY WARNING:

- Do not mix old and new batteries.
- Do not mix alkaline, standard (carbon-zinc), or rechargeable batteries.
- Insert batteries using the correct polarity. Do not short-circuit the supply terminal.
- Remove batteries when not in use. Recycle or dispose of exhausted batteries according to federal, state, and local laws. Do not dispose of batteries in a fire - they may leak or explode.
- Only use manufacture specified battery(ies), charger(s) and/or adapter, if applicable, specified by the manufacturer.
- Always use, replace, and recharge (if applicable) batteries under adult supervision.
- Keep these instructions for future reference.

NOTE: This equipment has been tested and found to comply with the limits for a Class B digital device, pursuant to Part 15 of the FCC Rules. These limits are designed to provide reasonable protection against harmful interference in a residential installation. This equipment generates, uses and can radiate radio frequency energy and, if not installed and used in accordance with the instructions, may cause harmful interference to radio communications. However, there is no guarantee that interference will not occur in a particular installation. If this equipment does cause harmful interference to radio or television reception, which can be determined by turning the equipment off and on, the user is encouraged to try to correct the interference by one or more of the following measures:

- Reorient or relocate the receiving antenna.
- Increase the separation between the equipment and receiver.
- Connect the equipment into an outlet on a circuit different from that to which the receiver is connected.
- Consult the dealer or an experienced radio/TV technician for help.

**Warning:** Changes or modifications to this unit not expressly approved by the party responsible for compliance could void the user's authority to operate the equipment.

This device complies with Part 15 of the FCC Rules. Operation is subject to the following two conditions: (1) this device may not cause harmful interference, and (2) this device must accept any interference received, including interference that may cause undesired operation.

### KEEP THIS INSTRUCTION MANUAL AS IT CONTAINS IMPORTANT INFORMATION FOR FUTURE REFERENCE.

Due to continuous product improvements, the pictures on this manual may differ slightly from the actual product.

The artwork and design of this manual are protected by US copyright law and may not be reproduced, distributed, displaced, published or used for any purpose without prior written permission. Altering, removing or reproducing any of the trademark or copyright notices on this package is not permitted.

©2019 MerchSource, LLC. Irvine, CA 92618. All rights reserved.

Distributed by MerchSource, LLC, Irvine, CA 92618.

Ford Trademarks and Trade Dress used under license to Merchsource, LLC

**FOR TECHNICAL SUPPORT,  
PLEASE CALL**

**1-800-374-2744**