

## Carestream Dental, LLC

# RF TEST REPORT

**Report Type:**

FCC Part 15.407 & ISED RSS-247 RF report

**Model:**

CS 3800 Wireless, Trophy 3800 Wireless

**REPORT NUMBER:**

200902830SHA-001

**ISSUE DATE:**

April 29, 2021

**DOCUMENT CONTROL NUMBER:**

TTRF15.407\_V1 © 2018 Intertek



**Applicant:** Carestream Dental, LLC  
3625 Cumberland Boulevard, Suite 700, Atlanta, GA USA 30339

**Manufacturer:** Carestream Dental, LLC  
3625 Cumberland Boulevard, Suite 700, Atlanta, GA USA 30339

**Product Name:** Intraoral Scanner

**Type/Model/PMN/HVIN:** CS 3800 Wireless, Trophy 3800 Wireless

**FCC ID:** 2ASFG-CS3800

**IC:** 24914-CS3800

### SUMMARY:

The equipment complies with the requirements according to the following standard(s) or Specification:

**47CFR Part 15 (2019):** Radio Frequency Devices (Subpart C)

**ANSI C63.10 (2013):** American National Standard of Procedures for Compliance Testing of Unlicensed Wireless Devices

**RSS-247 Issue 2 (February 2017):** Digital Transmission Systems (DTSs), Frequency Hopping Systems (FHSs) and Licence-Exempt Local Area Network (LE-LAN) Devices

**RSS-Gen Issue 5 (March 2019) Amendment 1:** General Requirements for Compliance of Radio Apparatus

**PREPARED BY:**

**REVIEWED BY:**



Project Engineer  
Wade Zhang



Reviewer  
Daniel Zhao

This report is for the exclusive use of Intertek's Client and is provided pursuant to the agreement between Intertek and its Client. Intertek's responsibility and liability are limited to the terms and conditions of the agreement. Intertek assumes no liability to any party, other than to the Client in accordance with the agreement, for any loss, expense or damage occasioned by the use of this report. Only the Client is authorized to permit copying or distribution of this report and then only in its entirety. Any use of the Intertek name or one of its marks for the sale or advertisement of the tested material, product or service must first be approved in writing by Intertek. The observations and test results in this report are relevant only to the sample tested. This report by itself does not imply that the material, product, or service is or has ever been under an Intertek certification program.

**TEST REPORT**

## Content

<b>REVISION HISTORY.....</b>	<b>5</b>
<b>MEASUREMENT RESULT SUMMARY .....</b>	<b>6</b>
<b>1 GENERAL INFORMATION .....</b>	<b>7</b>
1.1 DESCRIPTION OF EQUIPMENT UNDER TEST (EUT) .....	7
1.2 TECHNICAL SPECIFICATION .....	7
1.3 ANTENNA INFORMATION.....	8
1.4 DESCRIPTION OF TEST FACILITY .....	8
<b>2 TEST SPECIFICATIONS.....</b>	<b>9</b>
2.1 STANDARDS OR SPECIFICATION .....	9
2.2 MODE OF OPERATION DURING THE TEST.....	9
2.3 TEST SOFTWARE LIST .....	10
2.4 TEST PERIPHERALS LIST .....	10
2.5 TEST ENVIRONMENT CONDITION:.....	10
2.6 INSTRUMENT LIST .....	11
2.7 MEASUREMENT UNCERTAINTY .....	12
<b>3 26 DB BANDWIDTH &amp; 99% OCCUPIED BANDWIDTH .....</b>	<b>13</b>
3.1 LIMIT .....	13
3.2 MEASUREMENT PROCEDURE .....	13
3.3 TEST CONFIGURATION .....	14
3.4 THE RESULTS OF 26 DB BANDWIDTH & 99% OCCUPIED BANDWIDTH .....	14
<b>4 MAXIMUM CONDUCTED OUTPUT POWER AND E.I.R.P.....</b>	<b>15</b>
4.1 LIMIT .....	15
4.2 MEASUREMENT PROCEDURE .....	16
4.3 TEST CONFIGURATION .....	16
4.4 TEST RESULTS OF MAXIMUM CONDUCTED OUTPUT POWER AND E.I.R.P.....	17
<b>5 POWER SPECTRUM DENSITY .....</b>	<b>19</b>
5.1 LIMIT .....	19
5.2 MEASUREMENT PROCEDURE .....	20
5.3 TEST CONFIGURATION .....	21
5.4 TEST RESULTS OF POWER SPECTRUM DENSITY .....	21
<b>6 RADIATED EMISSIONS .....</b>	<b>22</b>
6.1 LIMIT .....	22
6.2 MEASUREMENT PROCEDURE .....	23
6.3 TEST CONFIGURATION .....	24
6.4 TEST RESULTS OF RADIATED EMISSIONS .....	26
<b>7 POWER LINE CONDUCTED EMISSION.....</b>	<b>29</b>
7.1 LIMIT .....	29
7.2 TEST CONFIGURATION .....	29
7.3 MEASUREMENT PROCEDURE .....	30
7.4 TEST RESULTS OF POWER LINE CONDUCTED EMISSION.....	31
<b>8 FREQUENCY STABILITY.....</b>	<b>33</b>
8.1 LIMIT .....	33
8.2 TEST RESULT.....	33

9 ANTENNA REQUIREMENT..... 34

## Revision History

Report No.	Version	Description	Issued Date
200902830SHA-001	Rev. 01	Initial issue of report	April 29, 2021

## Measurement result summary

TEST ITEM	FCC REFERANCE	IC REFERANCE	RESULT
26 dB Bandwidth & 99% Occupied Bandwidth	15.407(a)	RSS-247 Issue 2 Clause 6	Pass
Minimum 6dB Bandwidth	15.407(e)	RSS-247 Issue 2 Clause 6	Pass
Maximum Conducted Output Power	15.407(a)	RSS-247 Issue 2 Clause 6	Pass
Power spectral density	15.407(a)	RSS-247 Issue 2 Clause 6	Pass
Radiated emission	15.407(b) 15.205 15.209	RSS-247 Issue 2 Clause 6 RSS-Gen Issue 5 Clause 8.9&8.10	Pass
Power line conducted emission	15.407(b) 15.207	RSS-Gen Issue 5 Clause 8.8	Pass
Frequency Stability	15.407(g)	RSS-Gen Issue 5 Clause 8.11	Pass
Antenna requirement	15.203	-	Pass

Notes: 1: NA =Not Applicable

2. Determination of the test conclusion is based on IEC Guide 115 in consideration of measurement uncertainty.

3: Additions, Deviations and Exclusions from Standards: None.

## 1 GENERAL INFORMATION

### 1.1 Description of Equipment Under Test (EUT)

Product name:	Intraoral Scanner
Type/Model/PMN/HVIN:	CS 3800 Wireless, Trophy 3800 Wireless
Description of EUT:	The EUT is a WIFI Intraoral Scanner which supports 802.11ac mode. There have two models, the model "Trophy 3800 Wireless" is the same as the model "CS 3800 Wireless" except for the model name.
Rating:	For AC/DC adapter: Input: 100-240V~, 50/60Hz, 0.8A; Output: 12Vdc, 2.5A; For handpiece: 12Vdc, 2.5A or powered by a 3.6Vdc Li-ion battery
EUT type:	<input checked="" type="checkbox"/> Table top <input type="checkbox"/> Floor standing
Software Version:	/
Hardware Version:	/
Sample ID:	0200729-21-001 for Radiated test 0200729-21-002 for Conducted test
Sample received date:	July 29, 2020
Date of test:	July 29, 2020 ~ October 22, 2020

### 1.2 Technical Specification

Frequency Range:	5150 ~ 5250MHz
Support Standards:	802.11ac(VHT80)
Type of Modulation:	OFDM
Channel Number:	1 channel at 5210MHz

**TEST REPORT**

**1.3 Antenna information**

Antenna information:			
No.	Antenna Type	Gain	Note
1	PIFA Antenna	3dBi	

**1.4 Description of Test Facility**

Name:	Intertek Testing Services Shanghai
Address:	Building 86, No. 1198 Qinzhou Road(North), Shanghai 200233, P.R. China
Telephone:	86 21 61278200
Telefax:	86 21 54262353

The test facility is recognized, certified, or accredited by these organizations:	CNAS Accreditation Lab Registration No. CNAS L0139
	FCC Accredited Lab Designation Number: CN1175
	IC Registration Lab CAB identifier.: CN0051
	VCCI Registration Lab Registration No.: R-14243, G-10845, C-14723, T-12252
	A2LA Accreditation Lab Certificate Number: 3309.02



## 2 TEST SPECIFICATIONS

### 2.1 Standards or specification

47CFR Part 15 (2019)  
 ANSI C63.10 (2013)  
 RSS-247 Issue 2 (February 2017)  
 RSS-Gen Issue 5 (March 2019) Amendment 1  
 KDB 789033 D02 v02r01

### 2.2 Mode of operation during the test

While testing transmitting mode of EUT, the continuously transmission was applied by following software.

Software name	Manufacturer	Version	Supplied by
Command	-	-	Client

The lowest, middle and highest channel for the following modes were tested as representatives.

Frequency Band (MHz)	Mode	Lowest (MHz)	Middle (MHz)	Highest (MHz)
5150 - 5250	802.11ac(VHT80)	5210	/	/

#### Data rate and Power setting:

The pre-scan for the conducted power with all data rates in each modulation and band was used, and the worst case was found and used in all test cases. After this pre-scan, we choose the following table of the data rate as the worst case.

Frequency Band (MHz)	Mode	Worst case data rate
5150 - 5250	802.11ac(VHT80)	MCS8

#### Duty cycle:

Duty cycle	Duty cycle (%)	Duty cycle factor
802.11ac(VHT80)	96.18	0.17

**TEST REPORT**

**2.3 Test software list**

Test Items	Software	Manufacturer	Version
Conducted emission	ESxS-K1	R&S	V2.1.0
Radiated emission	ES-K1	R&S	V1.71

**2.4 Test peripherals list**

Item No.	Name	Band and Model	Description
1	Laptop computer	DELL 5480	-
2	RF cable	/	0.2m length; 0.5dB loss

**2.5 Test environment condition:**

Test items	Temperature	Humidity
26 dB Bandwidth & 99% Occupied Bandwidth	19°C	53% RH
Minimum 6dB Bandwidth		
Maximum Conducted Output Power		
Power spectral density		
Radiated Emissions in restricted frequency bands	20°C	53% RH
Power line conducted emission	20°C	53% RH

**TEST REPORT**

**2.6 Instrument list**

Conducted Emission					
Used	Equipment	Manufacturer	Type	Internal no.	Due date
<input checked="" type="checkbox"/>	Test Receiver	R&S	ESCS 30	EC 2107	2021-07-14
<input checked="" type="checkbox"/>	A.M.N.	R&S	ESH2-Z5	EC 3119	2020-11-10
Radiated Emission					
Used	Equipment	Manufacturer	Type	Internal no.	Due date
<input checked="" type="checkbox"/>	Test Receiver	R&S	ESIB 26	EC 3045	2021-09-16
<input checked="" type="checkbox"/>	Bilog Antenna	TESEQ	CBL 6112D	EC 4206	2021-09-25
<input checked="" type="checkbox"/>	Horn antenna	R&S	HF 906	EC 3049	2021-01-17
<input checked="" type="checkbox"/>	Horn antenna	ETS	3117	EC 4792-1	2021-03-15
<input checked="" type="checkbox"/>	Horn antenna	TOYO	HAP18-26W	EC 4792-3	2021-07-09
<input checked="" type="checkbox"/>	Pre-amplifier	R&S	Pre-amp 18	EC5262	2021-06-11
<input checked="" type="checkbox"/>	Semi-anechoic chamber	Albatross project	-	EC 3048	2021-07-14
RF test					
Used	Equipment	Manufacturer	Type	Internal no.	Due date
<input checked="" type="checkbox"/>	PXA Signal Analyzer	Keysight	N9030A	EC 5338	2021-03-16
<input checked="" type="checkbox"/>	PXA Signal Analyzer	Keysight	N9030B	EC 6078	2021-06-10
<input checked="" type="checkbox"/>	Power sensor	Agilent	U2021XA	EC 5338-1	2021-03-16
<input checked="" type="checkbox"/>	Vector Signal Generator	Agilent	N5182B	EC 5175	2021-03-16
<input checked="" type="checkbox"/>	MXG Analog Signal Generator	Agilent	N5181A	EC 5338-2	2021-03-16
<input checked="" type="checkbox"/>	Test Receiver	R&S	ESCI 7	EC 4501	2021-09-16
<input type="checkbox"/>	Universal Radio Communication Tester	R&S	CMW500	EC5944	2021-12-09
<input type="checkbox"/>	Universal Radio Communication Tester	R&S	CMW500	Ec6209	2021-12-30
<input checked="" type="checkbox"/>	Signal generator	Agilent	N5182A	Ec6172	2021-08-21
<input checked="" type="checkbox"/>	Signal generator	Agilent	N5181A	Ec6171	2021-08-21
<input checked="" type="checkbox"/>	Climate chamber	GWS	MT3065	EC 6021	2021-03-05
Additional instrument					
Used	Equipment	Manufacturer	Type	Internal no.	Due date
<input checked="" type="checkbox"/>	Therom-Hygrograph	ZJ1-2A	S.M.I.F.	EC 3783	2021-03-03
<input checked="" type="checkbox"/>	Pressure meter	YM3	Shanghai Mengde	EC 4620	2021-09-09

## 2.7 Measurement uncertainty

The measurement uncertainty represents an expanded uncertainty expressed at approximately the 95% confidence level using a coverage factor of k=2.

Test item	Measurement uncertainty
Maximum peak output power	± 0.74dB
Radiated Emissions in restricted frequency bands below 1GHz	± 4.90dB
Radiated Emissions in restricted frequency bands above 1GHz	± 5.02dB
Emission outside the frequency band	± 2.89dB
Power line conducted emission	± 3.19dB
Occupied Channel Bandwidth	± 0.88 %
Power Spectral Density, conducted	± 2.99 dB
Radio frequency	± 0.84 × 10 <sup>-7</sup>
Time	± 1.15 %
Temperature	± 1 °C
Humidity	± 5 %
DC and low frequency voltages	± 1.3 %

**TEST REPORT****3 26 dB Bandwidth & 99% Occupied Bandwidth****Test result: Pass****3.1 Limit**

None

**3.2 Measurement Procedure**

The EUT was tested according to test procedure of "KDB789033 D02 General UNII Test Procedures New Rules"

**26 dB Bandwidth**

- a) Set RBW = approximately 1% of the emission bandwidth.
- b) Set the VBW > RBW.
- c) Detector = Peak.
- d) Trace mode = max hold.
- e) Measure the maximum width of the emission that is 26 dB down from the maximum of the emission. Compare this with the RBW setting of the analyzer. Readjust RBW and repeat measurement as needed until the RBW/EBW ratio is approximately 1%.

**99% Occupied Bandwidth**

The following procedure shall be used for measuring (99 %) power bandwidth:

1. Set center frequency to the nominal EUT channel center frequency.
2. Set span = 1.5 times to 5.0 times the OBW.
3. Set RBW = 1 % to 5 % of the OBW
4. Set VBW  $\geq 3 \cdot$  RBW
5. Video averaging is not permitted. Where practical, a sample detection and single sweep mode shall be used. Otherwise, peak detection and max hold mode (until the trace stabilizes) shall be used.
6. Use the 99 % power bandwidth function of the instrument (if available).
7. If the instrument does not have a 99 % power bandwidth function, the trace data points are recovered and directly summed in power units. The recovered amplitude data points, beginning at the lowest frequency, are placed in a running sum until 0.5 % of the total is reached; that frequency is recorded as the lower frequency. The process is repeated until 99.5 % of the total is reached; that frequency is recorded as the upper frequency. The 99% occupied bandwidth is the difference between these two frequencies.

## TEST REPORT

### 3.3 Test Configuration

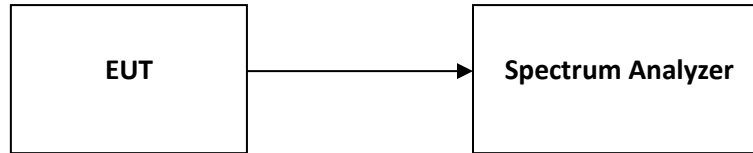

### 3.4 The results of 26 dB Bandwidth & 99% Occupied Bandwidth

U-NII-1 99% Occupied Bandwidth					
Mode	Test Frequency (MHz)	Ant	26 dB Bandwidth (MHz)	99% Occupied Bandwidth (MHz)	Result
802.11ac (VHT80)	5210	Ant0	81.760	75.568	Pass

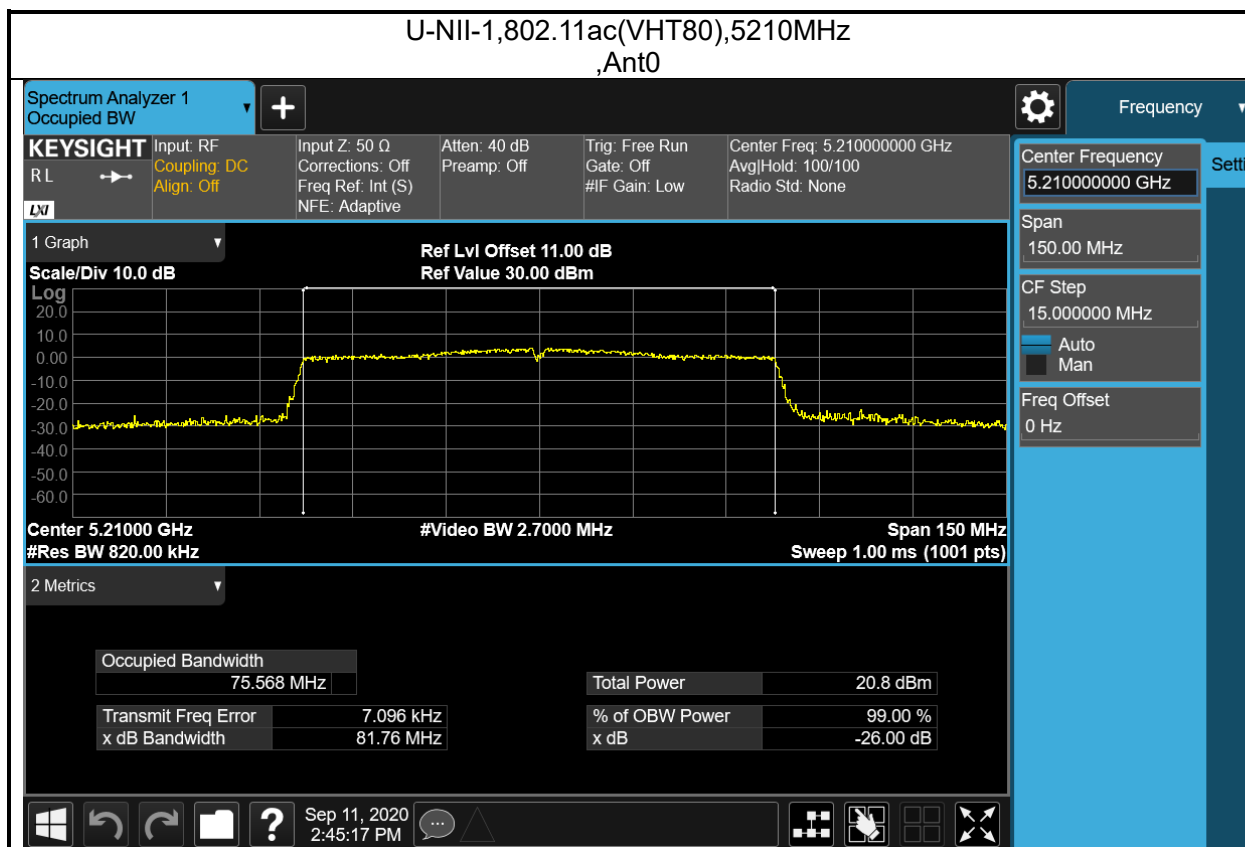

## 4 Maximum conducted output power and e.i.r.p.

Test result: Pass

### 4.1 Limit

For an outdoor access point operating in the band 5.15-5.25GHz, the maximum conducted output power over the frequency band of operation shall not exceed 1W provided the maximum antenna gain does not exceed 6dBi.

The maximum e.i.r.p. at any elevation angle above 30 degrees from the horizon must not exceed 125mW (21 dBm).

For an indoor access point operating in the band 5.15-5.25GHz, the maximum conducted output power over the frequency band of operation shall not exceed 1 W provided the maximum antenna gain does not exceed 6dBi.

For fixed point-to-point access points operating in the band 5.15-5.25GHz, the maximum conducted output power over the frequency band of operation shall not exceed 1W.

For client devices in the 5.15-5.25GHz band, the maximum conducted output power over the frequency band of operation shall not exceed 250mW provided the maximum antenna gain does not exceed 6dBi. (FCC Limit)

For the 5.25-5.35GHz and 5.47-5.725GHz bands, the maximum conducted output power over the frequency bands of operation shall not exceed the lesser of 250mW or 11dBm + 10logB, where B is the 26dB emission bandwidth in megahertz. (FCC limit)

For the band 5.725-5.85GHz, the maximum conducted output power over the frequency band of operation shall not exceed 1W. (FCC limit)

For Frequency Band 5150-5250 MHz, the maximum e.i.r.p. shall not exceed 200 mW or 10 + 10 log10B, dBm, whichever power is less. B is the 99% emission bandwidth in megahertz. (IC limit)

For the 5.25-5.35 GHz and 5.47-5.725 GHz bands, the maximum conducted output power over the frequency bands of operation shall not exceed the lesser of 250 mW or 11 dBm + 10 log B, where B is the 99% emission bandwidth in megahertz. (IC limit)

For the 5.25-5.35 GHz and 5.47-5.725 GHz bands, the maximum e.i.r.p. shall not exceed 1.0 W or 17 + 10 log10B, dBm, whichever is less. B is the 99% emission bandwidth in megahertz. (IC limit)

For the band 5.725-5.85 GHz, the maximum conducted output power over the frequency band of operation shall not exceed 1 W. (IC limit)

If transmitting antennas of directional gain greater than 6dBi are used, the maximum conducted output power shall be reduced by the amount in dB that the directional gain of the antenna exceeds 6dBi.

**TEST REPORT****4.2 Measurement Procedure**

The EUT was tested according to test procedure of “KDB789033 D02 General UNII Test Procedures New Rules”

(i) Set span to encompass the entire emission bandwidth (EBW) (or, alternatively, the entire 99% occupied bandwidth) of the signal.

(ii) Set RBW = 1 MHz.

(iii) Set VBW  $\geq$  3 MHz.

(iv) Number of points in sweep  $\geq 2 \times \text{span} / \text{RBW}$ . (This ensures that bin-to-bin spacing is  $\leq \text{RBW}/2$ , so that narrowband signals are not lost between frequency bins.)

(v) Sweep time = auto.

(vi) Detector = power averaging (rms), if available. Otherwise, use sample detector mode.

(vii) If transmit duty cycle  $< 98\%$ , use a video trigger with the trigger level set to enable triggering only on full power pulses. Transmitter must operate at maximum power control level for the entire duration of every sweep. If the EUT transmits continuously (i.e., with no off intervals) or at duty cycle  $\geq 98\%$ , and if each transmission is entirely at the maximum power control level, then the trigger shall be set to “free run.”

(viii) Trace average at least 100 traces in power averaging (rms) mode.

(ix) Compute power by integrating the spectrum across the EBW (or, alternatively, the entire 99% occupied bandwidth) of the signal using the instrument’s band power measurement function with band limits set equal to the EBW (or occupied bandwidth) band edges. If the instrument does not have a band power function, sum the spectrum levels (in power units) at 1 MHz intervals extending across the EBW (or, alternatively, the entire 99% occupied bandwidth) of the spectrum.

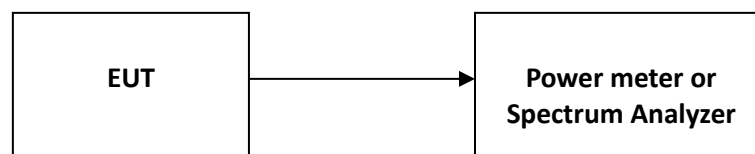
**4.3 Test Configuration**



## 4.4 Test Results of Maximum conducted output power and e.i.r.p.

U-NII-1 Duty Cycle				
Mode	Test Frequency (MHz)	Ant	Duty Cycle (%)	Duty Cycle Factor (dB)
802.11ac (VHT80)	5210	Ant0	96.18	0.17

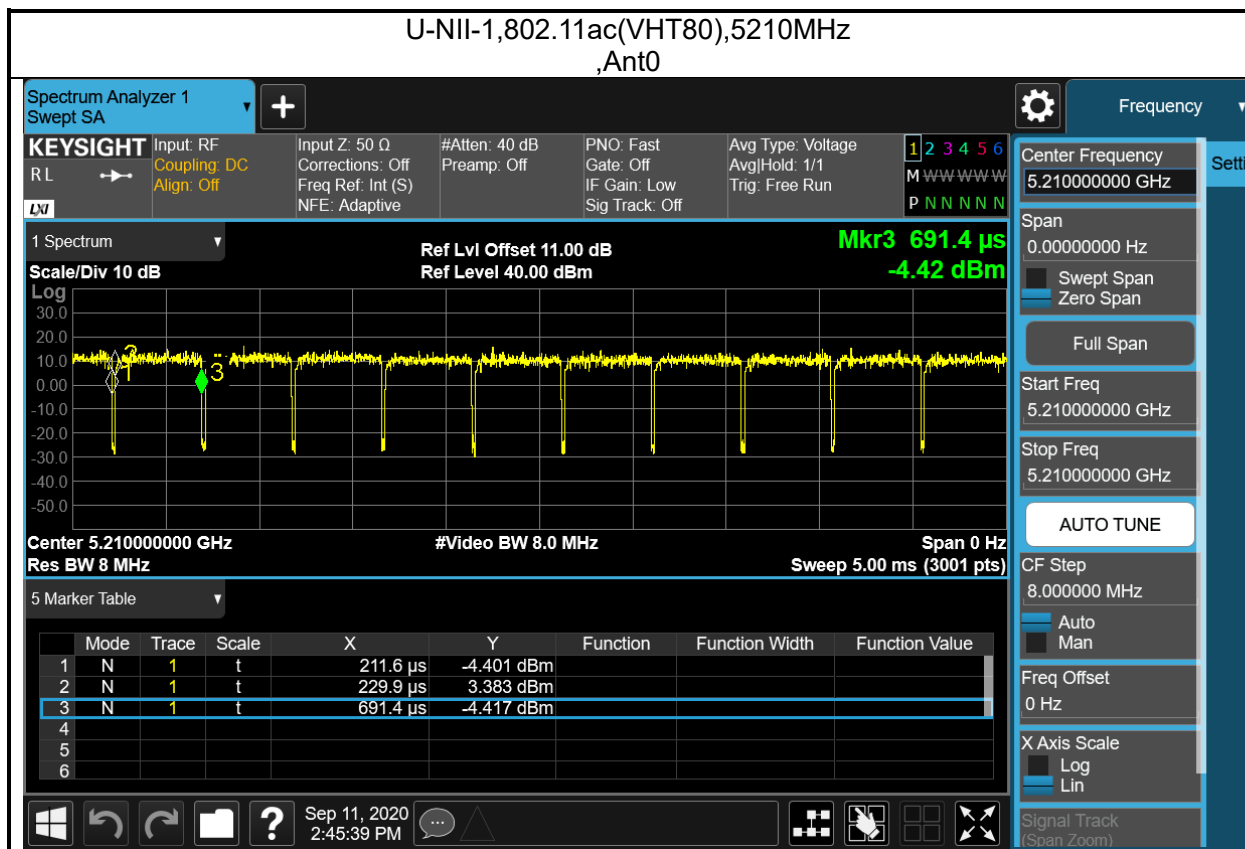

U-NII-1 AVGSA Output Power								
Mode	Test Frequency (MHz)	Ant	Duty Cycle Factor (dB)	Max Power (dBm)	FCC Power Limit (dBm)	EIRP (dBm)	IC EIRP Limit (dBm)	Result
802.11ac (VHT80)	5210	Ant0	0.17	18.48	30	21.48	23	Pass

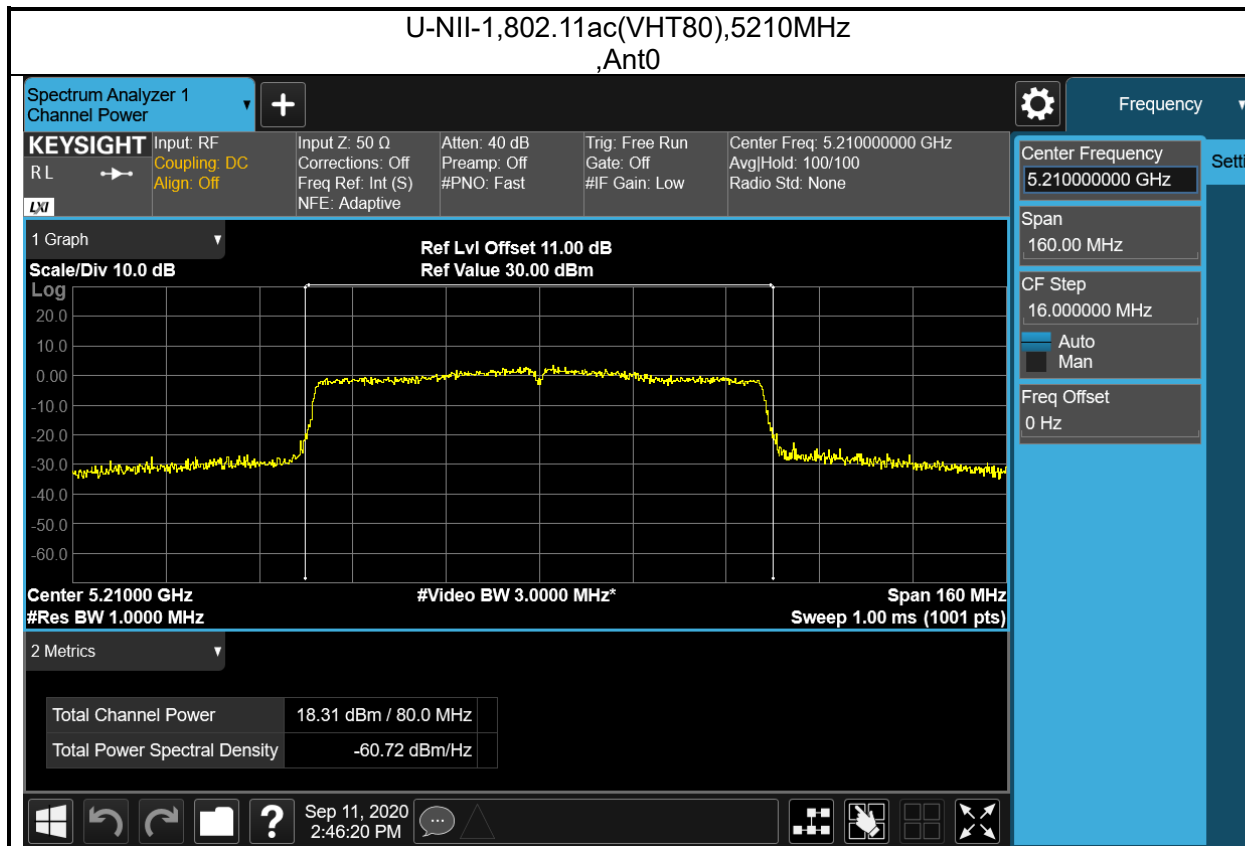

## 5 Power spectrum density

Test result: Pass

### 5.1 Limit

For an outdoor access point operating in the band 5.15-5.25GHz, the maximum power spectral density shall not exceed 17dBm in any 1 megahertz band.

For an indoor access point operating in the band 5.15-5.25GHz, the maximum power spectral density shall not exceed 17 dBm in any 1 megahertz band.

For client devices in the 5.15-5.25GHz band, the maximum power spectral density shall not exceed 11 dBm in any 1 megahertz band. (FCC limit)

For the 5.25-5.35 GHz and 5.47-5.725GHz bands, the maximum power spectral density shall not exceed 11 dBm in any 1 megahertz band. (FCC limit)

For the band 5.725-5.85GHz, the maximum power spectral density shall not exceed 30dBm in any 500kHz band. (FCC limit)

For the 5.15-5.25GHz band, the e.i.r.p. spectral density shall not exceed 10 dBm in any 1.0 MHz band. (IC limit)

For the 5.25-5.35 GHz and 5.47-5.725 GHz bands, the maximum power spectral density shall not exceed 11 dBm in any 1 megahertz band. (IC limit)

For the 5.725-5.85GHz band, the maximum power spectral density shall not exceed 30 dBm in any 500-kHz band. (IC limit)

If the transmitting antenna of directional gain greater than 6dBi is used, the power shall be reduced by the amount in dB that the directional gain of the antenna exceeds 6dBi. If there have a beam forming type, the limit should be the less of original and original + (6 - antenna gain - beamforming gain).

## 5.2 Measurement Procedure

The EUT was tested according to test procedure of “KDB789033 D02 General UNII Test Procedures New Rules”

1. Create an average power spectrum for the EUT operating mode being tested by following the instructions in II.E.2. for measuring maximum conducted output power using a spectrum analyzer or EMI receiver: select the appropriate test method (SA-1, SA-2, SA-3, or alternatives to each) and apply it up to, but not including, the step labeled, “Compute power....” (This procedure is required even if the maximum conducted output power measurement was performed using a power meter, method PM.)
2. Use the peak search function on the instrument to find the peak of the spectrum and record its value.
3. Make the following adjustments to the peak value of the spectrum, if applicable:
  - a) If Method SA-2 or SA-2 Alternative was used, add  $10 \log(1/x)$ , where  $x$  is the duty cycle, to the peak of the spectrum.
  - b) If Method SA-3 Alternative was used and the linear mode was used in step II.E.2.g)(viii), add 1 dB to the final result to compensate for the difference between linear averaging and power averaging.
4. The result is the Maximum PSD over 1 MHz reference bandwidth.
5. For devices operating in the bands 5.15 5.25 GHz, 5.25 5.35 GHz, and 5.47 5.725 GHz, the above procedures make use of 1 MHz RBW to satisfy directly the 1 MHz reference bandwidth specified in Section 15.407(a)(5). For devices operating in the band 5.725 5.85 GHz, the rules specify a measurement bandwidth of 500 kHz. Many spectrum analyzers do not have 500 kHz RBW, thus a narrower RBW may need to be used. The rules permit the use of a RBWs less than 1 MHz, or 500 kHz, “provided that the measured power is integrated over the full reference bandwidth” to show the total power over the specified measurement bandwidth (i.e., 1 MHz, or 500 kHz). If measurements are performed using a reduced resolution bandwidth (< 1 MHz, or < 500 kHz) and integrated over 1 MHz, or 500 kHz bandwidth, the following adjustments to the procedures apply:
  - a) Set  $RBW \geq 1/T$ , where  $T$  is defined in II.B.I.a).
  - b) Set  $VBW \geq 3 RBW$ .
  - c) If measurement bandwidth of Maximum PSD is specified in 500 kHz, add  $10 \log(500 \text{ kHz}/RBW)$  to the measured result, whereas  $RBW (< 500 \text{ kHz})$  is the reduced resolution bandwidth of the spectrum analyzer set during measurement.
  - d) If measurement bandwidth of Maximum PSD is specified in 1 MHz, add  $10 \log(1\text{MHz}/RBW)$  to the measured result, whereas  $RBW (< 1 \text{ MHz})$  is the reduced resolution bandwidth of spectrum analyzer set during measurement.
  - e) Care must be taken to ensure that the measurements are performed during a period of continuous transmission or are corrected upward for duty cycle.

Note: As a practical matter, it is recommended to use reduced RBW of 100 kHz for steps 5.c) and 5.d) above, since  $RBW=100 \text{ KHZ}$  is available on nearly all spectrum analyzers.

**TEST REPORT**

**5.3 Test Configuration**

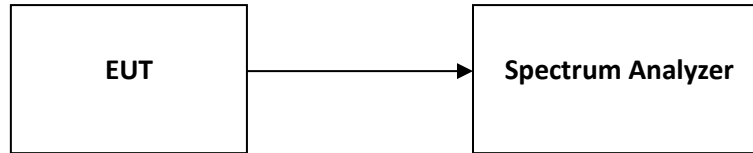

**5.4 Test Results of Power spectrum density**

U-NII-1 AVGSA Power Spectral Density								
Mode	Test Frequency (MHz)	Ant	Duty Cycle Factor (dB)	PSD (dBm)	FCC Limit (dBm)	EIRP PSD (dBm)	IC Limit (dBm)	Result
802.11ac (VHT80)	5210	Ant0	0.17	-2.755	17	0.245	10	Pass

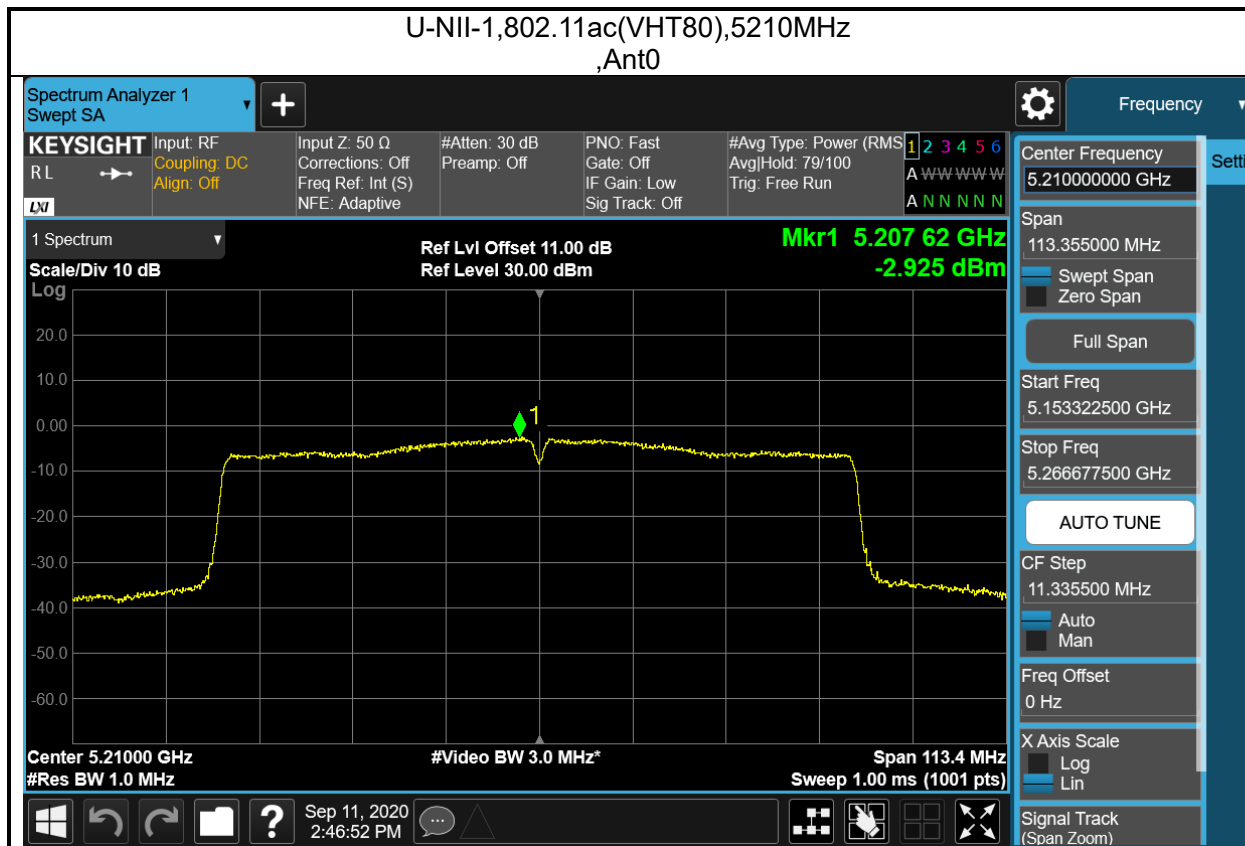

## 6 Radiated Emissions

Test result: Pass

### 6.1 Limit

The radiated emissions which fall in the restricted bands, and the radiated emissions below 1GHz, must comply with the radiated emission limits specified showed as below:

Frequencies (MHz)	Field Strength (microvolts/meter)	Measurement Distance (meters)
0.009 ~ 0.490	2400/F(kHz)	300
0.490 ~ 1.705	24000/F(kHz)	30
1.705 ~ 30.0	30	30
30 ~ 88	100	3
88 ~ 216	150	3
216 ~ 960	200	3
Above 960	500	3

The radiated emissions which fall outside the restrict bands, should comply with the EIRP limit as below:

For transmitters operating in the 5.15 - 5.25 / 5.25 - 5.35 / 5.47 - 5.725GHz band:

Frequency (MHz)	EIRP Limit (dBm)	Equivalent Field Strength (3m) (dBμV/m)
<5150	-27	68.20
>5350		
<5470		
>5725		

For transmitters operating in the 5.725 - 5.85GHz band:

Frequency (MHz)	EIRP Limit (dBm/MHz)	Equivalent Field Strength (3m) (dBμV/m)
<5650	-27	68.20
5650 ~ 5700	-27 ~ 10	68.20 ~ 105.20
5700 ~ 5720	10 ~ 15.6	105.20 ~ 110.80
5720 ~ 5725	15.6 ~ 27	110.80 ~ 122.20
5850 ~ 5855	27 ~ 15.6	122.20 ~ 110.80
5855 ~ 5875	15.6 ~ 10	110.80 ~ 105.20
5875 ~ 5925	10 ~ -27	105.20 ~ 68.20
>5925	-27	68.20

**TEST REPORT****6.2 Measurement Procedure****For Radiated emission below 30MHz:**

- a) The EUT was placed on the top of a rotating table 0.8 meters above the ground at a 3 meters chamber room. The table was rotated 360 degrees to determine the position of the highest radiation.
- b) The EUT was set 3 meters away from the interference-receiving antenna, which was mounted on the top of a variable-height antenna tower.
- c) Both X and Y axes of the antenna are set to make the measurement.
- d) For each suspected emission, the EUT was arranged to its worst case and the rotatable table was turned from 0 degrees to 360 degrees to find the maximum reading.
- e) The test-receiver system was set to peak or quasi-peak detect function and specified bandwidth with maximum hold mode.

**NOTE:**

1. The resolution bandwidth and video bandwidth of test receiver/spectrum analyzer is 9kHz at frequency below 30MHz.

**For Radiated emission above 30MHz:**

- a) The EUT was placed on the top of a rotating table 0.8 meters (for 30MHz ~ 1GHz) / 1.5 meters (for above 1GHz) above the ground at 3 meters chamber room for test. The table was rotated 360 degrees to determine the position of the highest radiation.
- b) The EUT was set 3 meters away from the interference-receiving antenna, which was mounted on the top of a variable-height antenna tower.
- c) The height of antenna is varied from one meter to four meters above the ground to determine the maximum value of the field strength. Both horizontal and vertical polarizations of the antenna are set to make the measurement.
- d) For each suspected emission, the EUT was arranged to its worst case and then the antenna was tuned to heights from 1 meter to 4 meters and the rotatable table was turned from 0 degrees to 360 degrees to find the maximum reading.
- e) The test-receiver system was set to peak or quasi-peak detect function and specified bandwidth with maximum hold mode when the test frequency is below 1 GHz.
- f) The test-receiver system was set to peak and average detect function and specified bandwidth with maximum hold mode when the test frequency is above 1 GHz. If the peak reading value also meets average limit, measurement with the average detector is unnecessary.

**Note:**

1. The resolution bandwidth of test receiver/spectrum analyzer is 120kHz for peak or quasi-peak detection at frequency below 1GHz.
2. The resolution bandwidth of test receiver/spectrum analyzer is 1 MHz at frequency above 1GHz for peak detection above 1GHz.
3. The resolution bandwidth of test receiver/spectrum analyzer is 1 MHz and the video bandwidth is  $\geq 1/T$  (Duty cycle < 98%) or 3 x RBW (Duty cycle  $\geq 98\%$ ) for average detection (AV) at frequency above 1GHz.
4. All modes of operation were investigated and the worst-case emissions are reported.

**TEST REPORT**

**6.3 Test Configuration**

**For Radiated emission below 30MHz:**

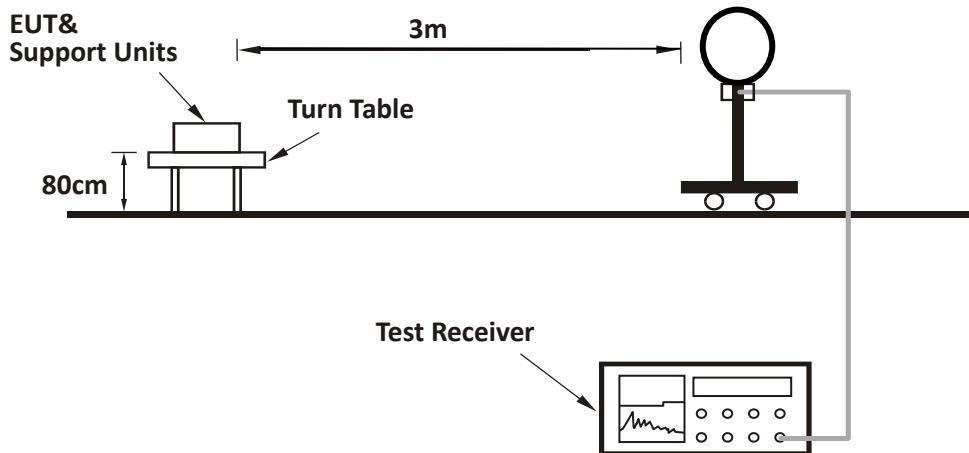

**For Radiated emission 30MHz to 1GHz:**

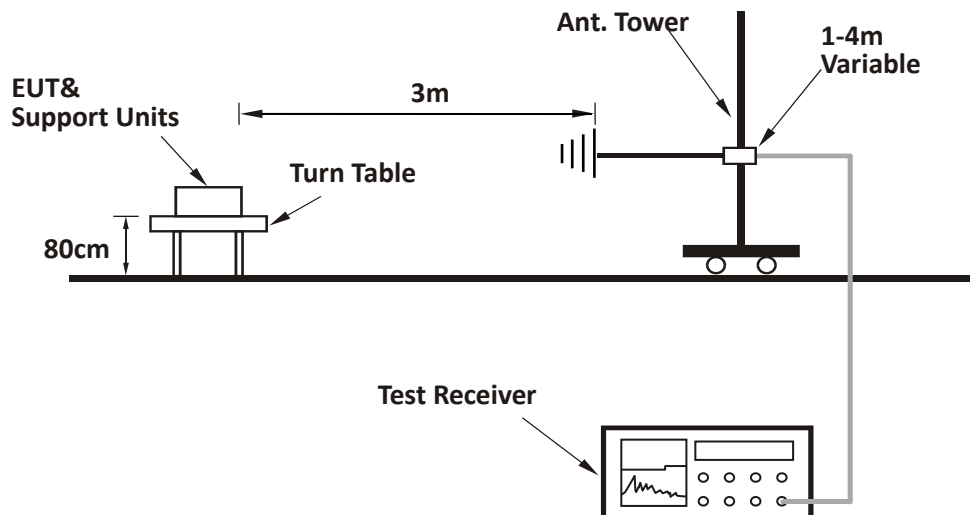



**TEST REPORT**

**For Radiated emission above 1GHz:**

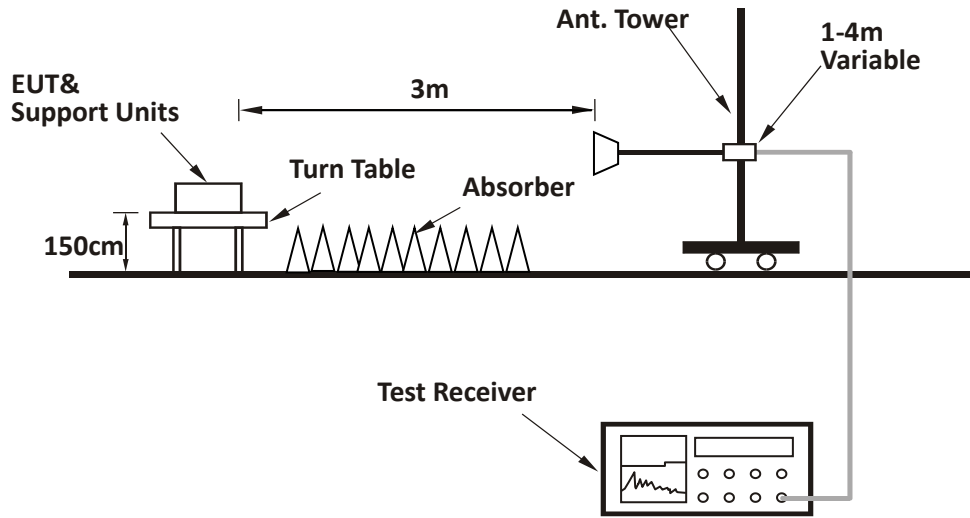

## TEST REPORT

### 6.4 Test Results of Radiated Emissions

The low frequency, which started from 9 kHz to 30MHz, was pre-scanned and the result which was 20dB lower than the limit line per 15.31(o) was not reported.

Horizontal

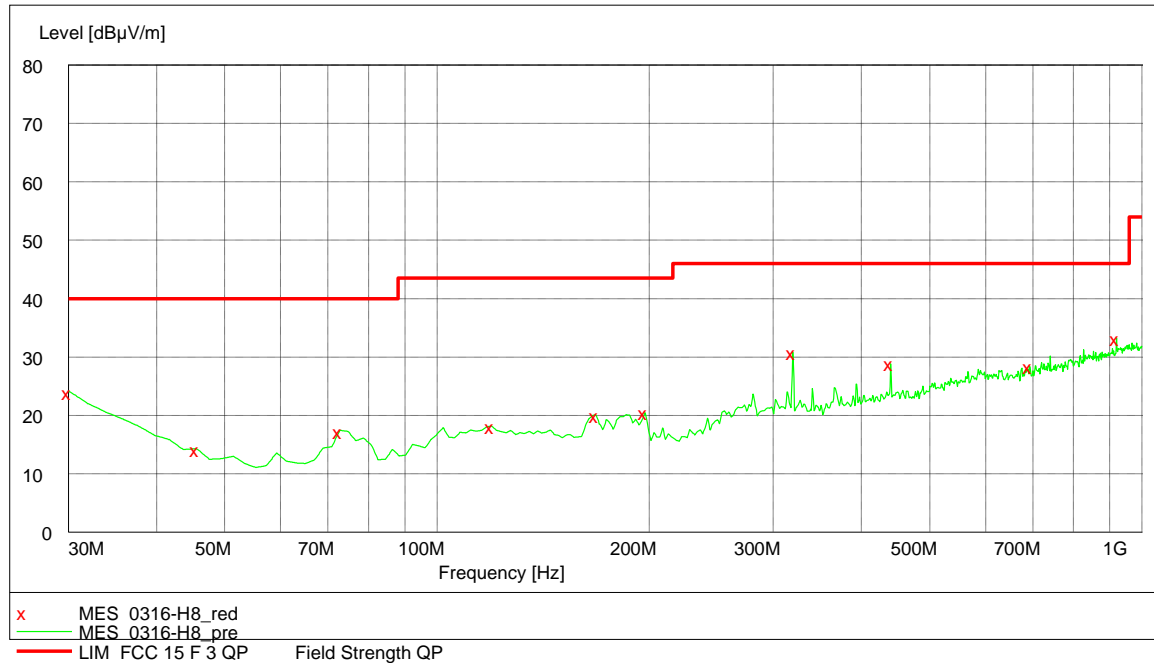

Vertical

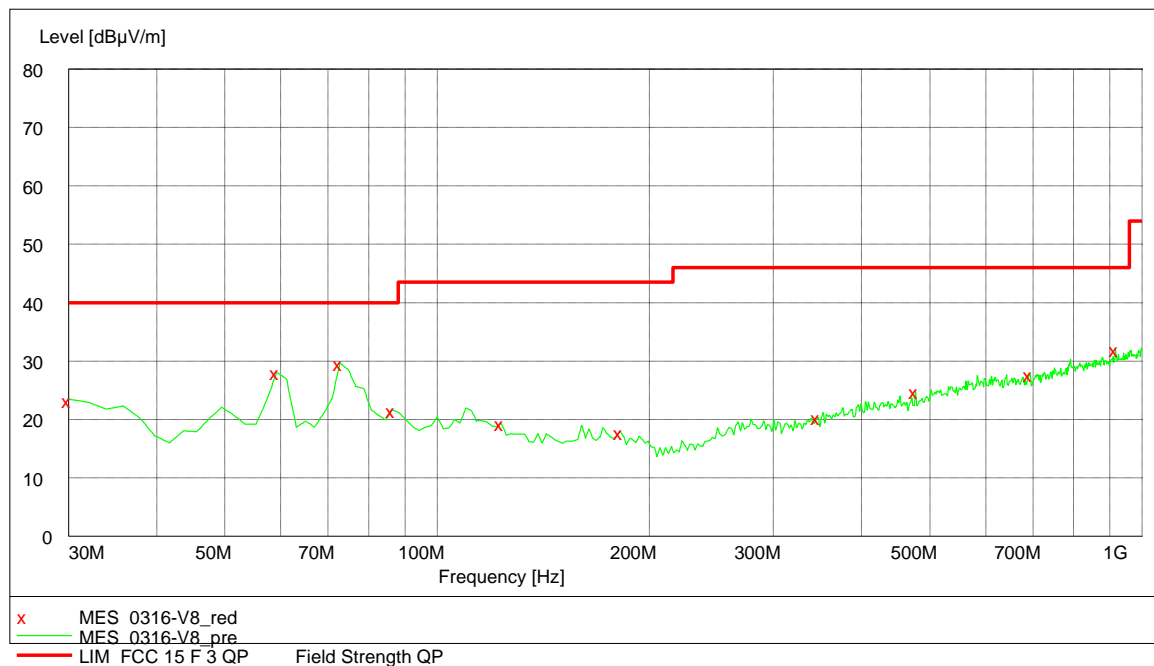

**TEST REPORT**

**Test data below 1GHz**

Antenna	Frequency (MHz)	Corrected Reading (dBuV/m)	Correct Factor (dB/m)	Limit (dBuV/m)	Margin (dB)	Detector
H	30.00	24.10	21.00	40.00	15.90	PK
H	45.55	14.30	11.30	40.00	25.70	PK
H	72.77	17.40	8.50	40.00	22.60	PK
H	119.42	18.20	14.00	43.50	25.30	PK
H	168.02	20.10	11.70	43.50	23.40	PK
H	197.17	20.50	12.10	43.50	23.00	PK
H	319.64	30.80	16.10	46.00	15.20	PK
H	440.16	28.90	19.30	46.00	17.10	PK
H	692.87	28.40	22.40	46.00	17.60	PK
H	920.30	33.20	25.10	46.00	12.80	PK
V	30.00	23.40	21.00	40.00	16.60	PK
V	59.16	28.10	7.50	40.00	11.90	PK
V	72.77	29.60	8.50	40.00	10.40	PK
V	86.37	21.60	9.60	40.00	18.40	PK
V	123.31	19.30	13.90	43.50	24.20	PK
V	181.62	17.90	11.50	43.50	25.60	PK
V	346.85	20.30	17.00	46.00	25.70	PK
V	477.09	24.90	19.90	46.00	21.10	PK
V	692.87	27.80	22.40	46.00	18.20	PK
V	916.41	32.00	25.00	46.00	14.00	PK

**TEST REPORT**

**Test result above 1GHz:**

The emission was conducted from 1GHz to 40GHz

Channel	Polarity	Frequency (MHz)	Correct Factor (dB/m)	Corrected Reading (dBuV/m)	Limit (dBuV/m)	Margin (dB)	Detector
5210MHz	H	5210.00	40.90	106.70	Fundamental	/	PK
	H	5150.00	40.70	68.30	74.00	5.70	PK
	H	5150.00	40.70	49.30	54.00	4.70	AV
	V	5150.00	40.70	65.80	74.00	8.20	PK
	V	5150.00	40.70	47.50	54.00	6.50	AV
	H	10420.00	14.50	45.80	54.00	8.20	AV
	V	10420.00	14.50	46.60	54.00	7.40	AV

- Remark: 1. Correct Factor = Antenna Factor + Cable Loss (- Amplifier, for higher than 1GHz), the value was added to Original Receiver Reading by the software automatically.  
 2. Corrected Reading = Original Receiver Reading + Correct Factor  
 3. Margin = Limit - Corrected Reading  
 4. If the PK Corrected Reading is lower than AV limit, the AV test can be elided.

Example: Assuming Antenna Factor = 30.20dB/m, Cable Loss = 2.00dB,  
 Gain of Preamplifier = 32.00dB, Original Receiver Reading = 10.00dBuV,  
 Limit = 40.00dBuV/m.  
 Then Correct Factor = 30.20 + 2.00 – 32.00 = 0.20dB/m;  
 Corrected Reading = 10dBuV + 0.20dB/m = 10.20dBuV/m;  
 Margin = 40.00dBuV/m - 10.20dBuV/m = 29.80dB.

## 7 Power line conducted emission

**Test result:** Pass

### 7.1 Limit

Frequency of Emission (MHz)	Conducted Limit (dBuV)	
	QP	AV
0.15-0.5	66 to 56*	56 to 46 *
0.5-5	56	46
5-30	60	50

\* Decreases with the logarithm of the frequency.

### 7.2 Test Configuration

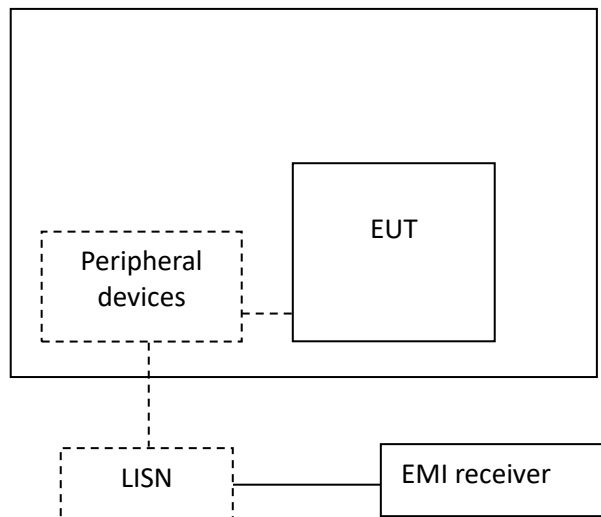

**TEST REPORT****7.3 Measurement Procedure**

Measured levels of ac power-line conducted emission shall be the emission voltages from the voltage probe, where permitted, or across the 50  $\Omega$  LISN port (to which the EUT is connected), where permitted, terminated into a 50  $\Omega$  measuring instrument. All emission voltage and current measurements shall be made on each current-carrying conductor at the plug end of the EUT power cord by the use of mating plugs and receptacles on the LISN, if used. Equipment shall be tested with power cords that are normally supplied or recommended by the manufacturer and that have electrical and shielding characteristics that are the same as those cords normally supplied or recommended by the manufacturer. For those measurements using a LISN, the 50  $\Omega$  measuring port is terminated by a measuring instrument having 50  $\Omega$  input impedance. All other ports are terminated in 50  $\Omega$  loads.

Tabletop devices shall be placed on a platform of nominal size 1 m by 1.5 m, raised 80 cm above the reference ground plane. The vertical conducting plane or wall of an RF-shielded (screened) room shall be located 40 cm to the rear of the EUT. Floor-standing devices shall be placed either directly on the reference ground-plane or on insulating material as described in ANSI C63.4. All other surfaces of tabletop or floor-standing EUTs shall be at least 80 cm from any other grounded conducting surface, including the case or cases of one or more LISNs.

The bandwidth of the test receiver is set at 9 kHz.

TEST REPORT

7.4 Test Results of Power line conducted emission

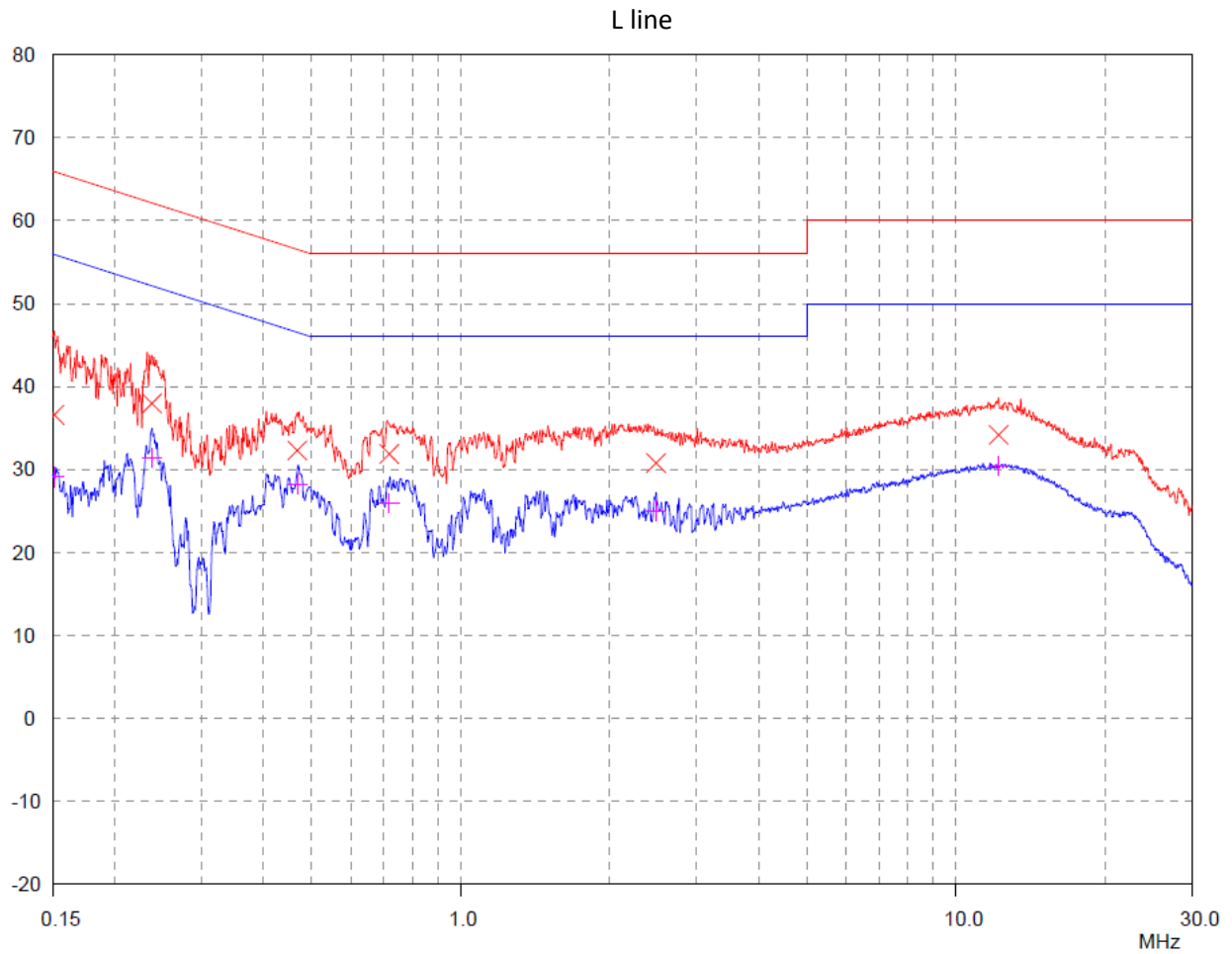

Test Data:

Frequency (MHz)	Quasi-peak			Average		
	level dB(μV)	Limit dB(μV)	Margin (dB)	level dB(μV)	limit dB(μV)	Margin (dB)
0.151	36.60	65.93	29.33	29.10	55.93	26.83
0.238	37.98	62.15	24.17	31.44	52.15	20.71
0.468	32.31	56.55	24.24	28.26	46.55	18.29
0.717	31.88	56.00	24.12	25.96	46.00	20.04
2.483	30.79	56.00	25.21	25.04	46.00	20.96
12.208	34.18	60.00	25.82	30.42	50.00	19.58

## TEST REPORT

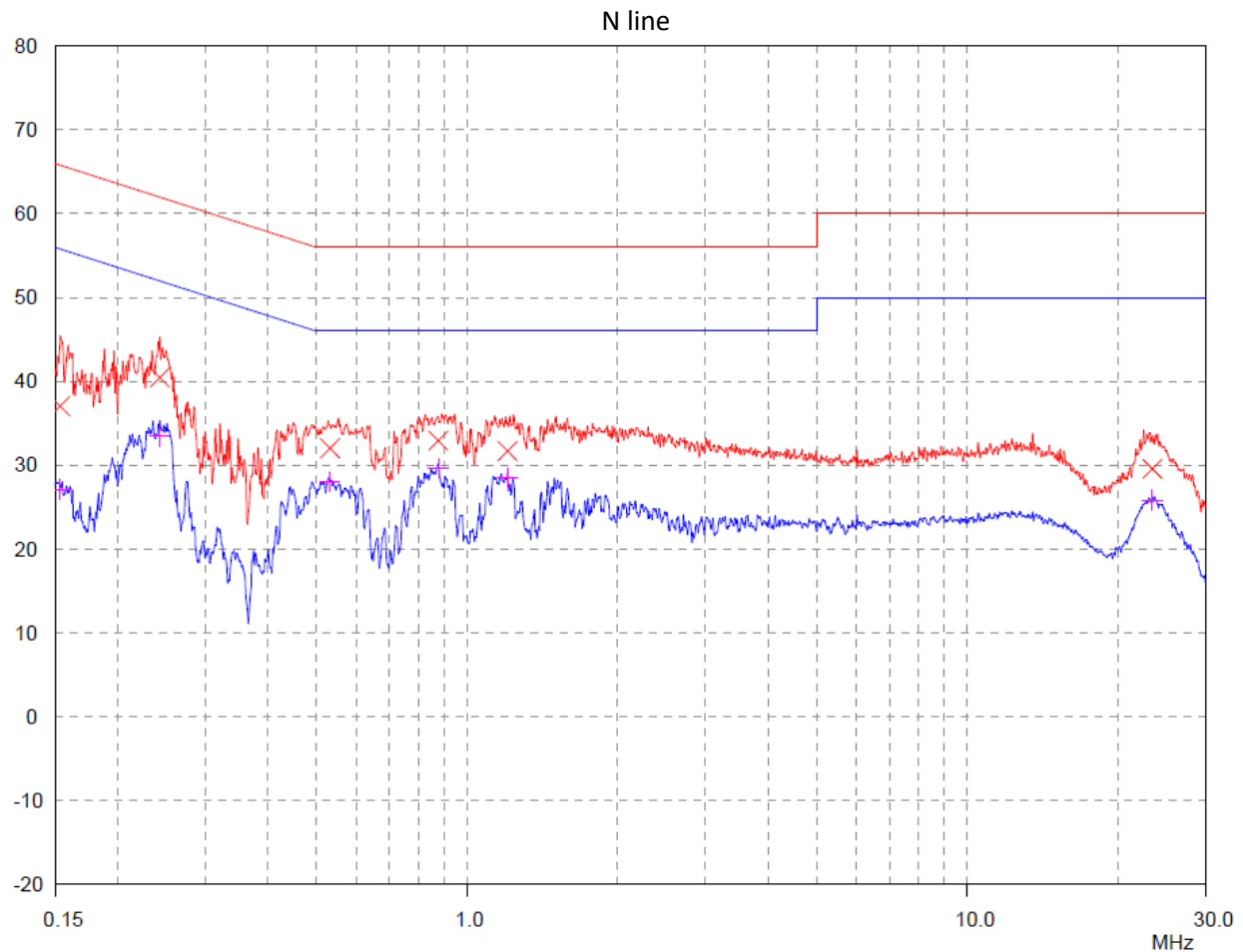

### Test Data:

Frequency (MHz)	Quasi-peak			Average		
	level dB(μV)	Limit dB(μV)	Margin (dB)	level dB(μV)	limit dB(μV)	Margin (dB)
0.154	37.06	65.80	28.74	27.14	55.80	28.66
0.243	40.46	61.99	21.53	33.46	51.99	18.53
0.532	32.02	56.00	23.98	27.99	46.00	18.01
0.876	32.93	56.00	23.07	29.69	46.00	16.31
1.205	31.69	56.00	24.31	28.59	46.00	17.41
23.495	29.56	60.00	30.44	25.86	50.00	24.14

Remark: 1. Correct Factor = LISN Factor + Cable Loss, the value was added to Original Receiver Reading by the software automatically.

2. Corrected Reading = Original Receiver Reading + Correct Factor

3. Margin = Limit - Corrected Reading

4. If the PK Corrected Reading is lower than AV limit, the AV test can be elided.



## 8 Frequency Stability

Test result: Pass

### 8.1 Limit

The frequency stability shall be sufficient to ensure that an emission is maintained within the band of operation under all conditions of normal operation as specified in the user's manual.

### 8.2 Test Result

Frequency Error - Temperature Variation

Supply Voltage DC (V)	Temperature (°C)	Frequency Deviation (ppm)
		Channel (5210MHz)
12.0	-20	-12
	-10	-9
	0	-5
	10	-7
	20	0
	30	-4
	40	-5
	50	-6

Frequency Error - Voltage Variation

Supply Voltage DC (V)	Temperature (°C)	Frequency Deviation (ppm)
		Channel (5210MHz)
10.8	20	-6
12.0		-5
13.2		-7

**TEST REPORT**

**9 Antenna requirement**

**Requirement:**

An intentional radiator shall be designed to ensure that no antenna other than that furnished by the responsible party shall be used with the device. The use of a permanently attached antenna or of an antenna that uses a unique coupling to the intentional radiator shall be considered sufficient to comply with the provisions of this section.

**Result:**

EUT uses internal antenna, so it can comply with the provisions of this section.

\*\*\*\*\* END \*\*\*\*\*