



深圳汉阳天线设计有限公司

SHENZHEN HANYANG ANTENNA DESIGN CO. LTD.

## BT Antenna Test Report

Project Name: L3

Date : 2023-06-25

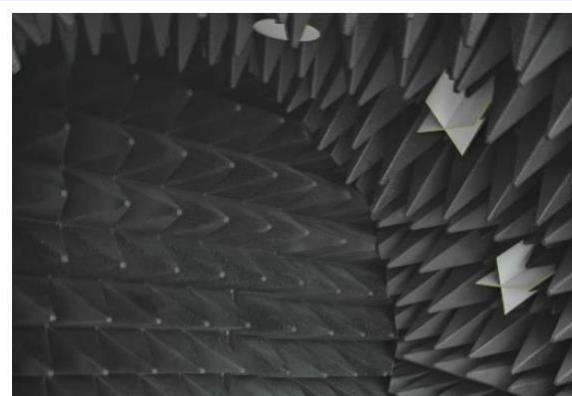
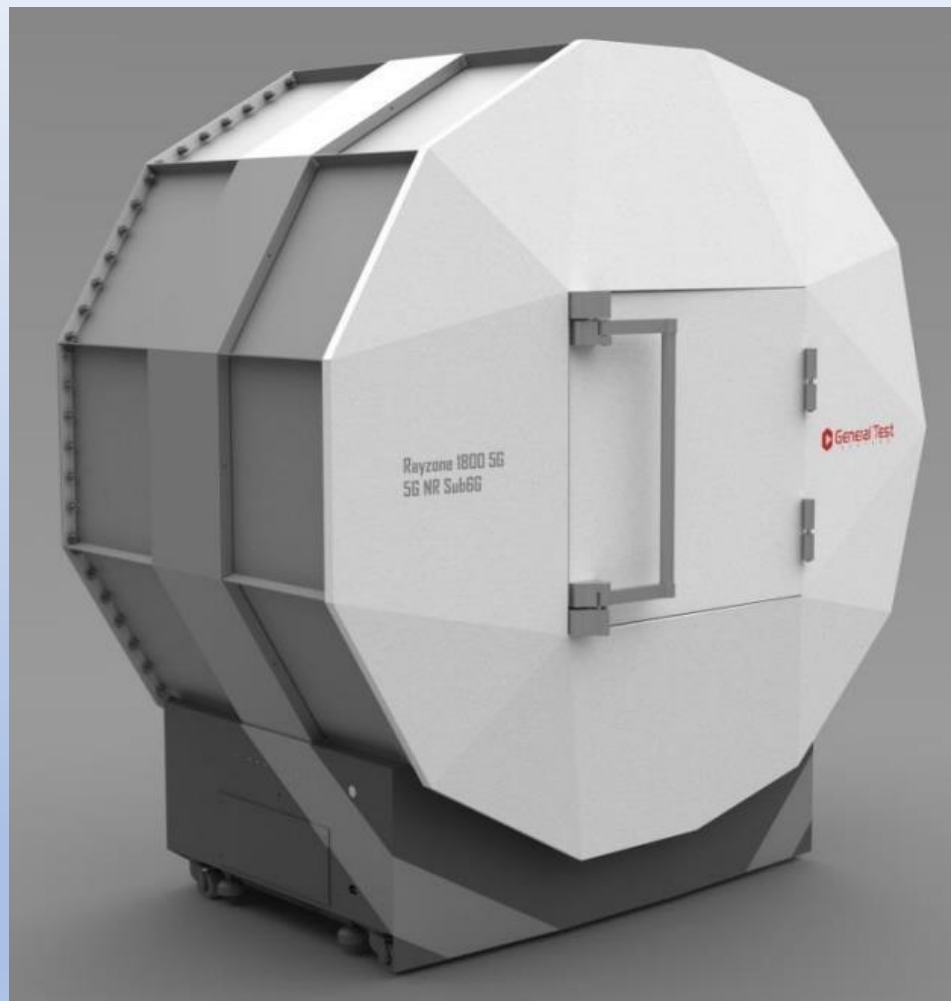

- 无线通信标准: 2G/3G/4G/5G(FR1)/GNSS/A-GNSS/Wi-Fi/Bluetooth
- 物联网通信标准: LTE Cat NB1(NB-IoT)/Cat-M1(e-MTC)
- SISO测试TRP/TIS/EIRP/EIS, 2x2 MIMO吞吐率测试;
- 无源天线测试、Desense测试、ICS
- 支持600MHz-7.5GHz频段
- GTS MaxSign 100 测试软件支持天线/OTA测试, 提供可视化数据分析
- 新型EPP硬质环保吸波材料、低RCS高增益测量天线组、透波转台和夹具
- 快速MIMO测试; 认证级测试精度
- 一体化设计, 即插即用, 维护简单



## RayZone1800 Test Setup

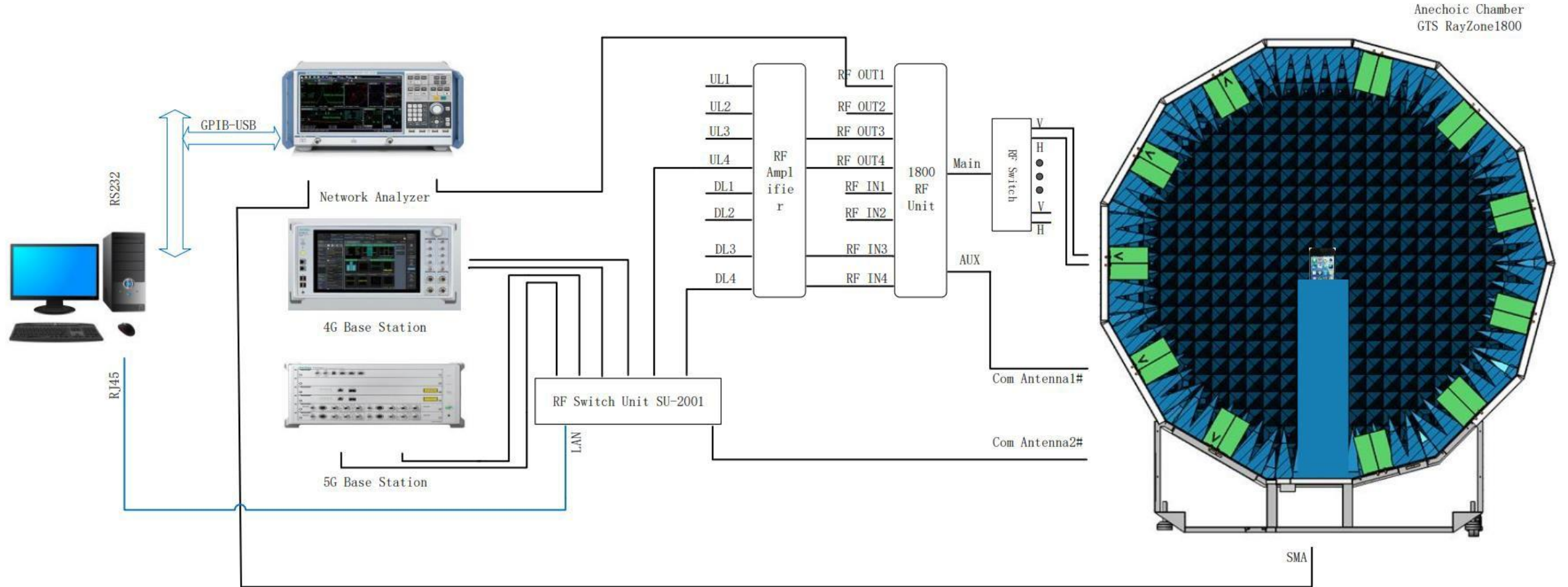

# Placement direction



L=120mm





## 2450MHZZ

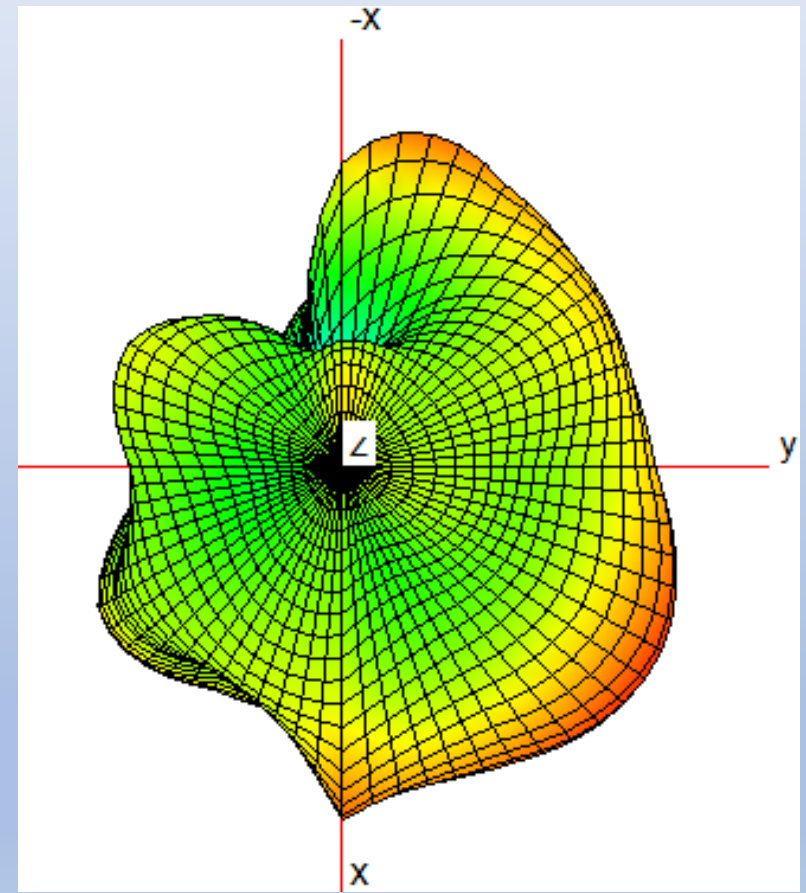
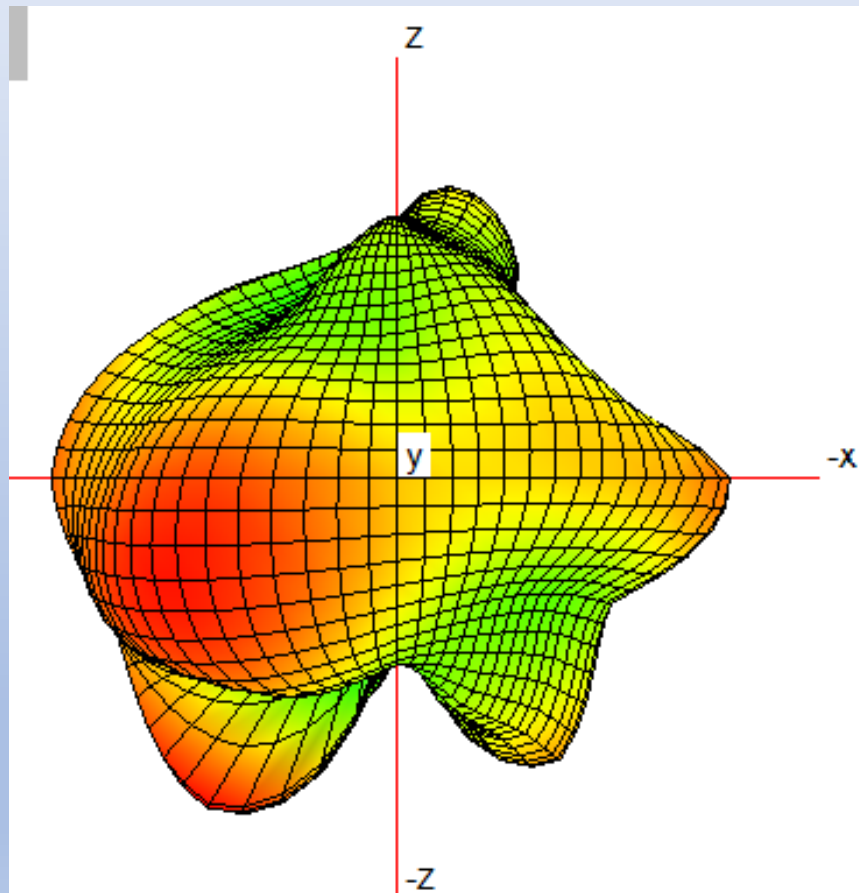
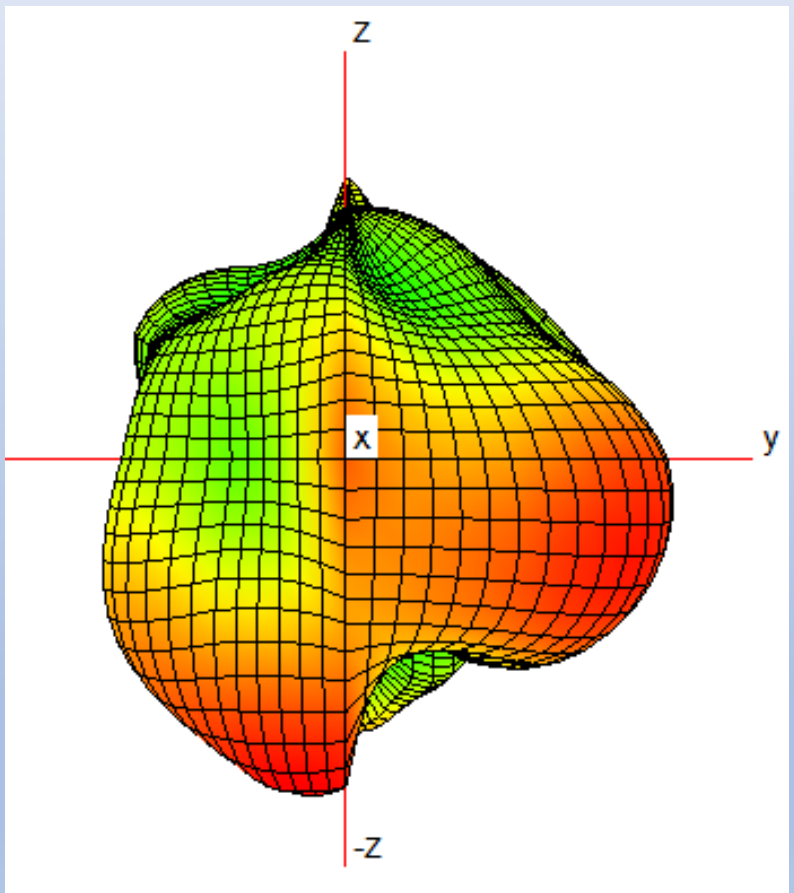



Freq	Efficiency_dB	Efficiency_Pcent_%	Gain_dBi
2400	-7.45	18	-1.69
2410	-7.32	18.55	-1.61
2420	-7.25	18.82	-1.57
2430	-7.35	18.42	-1.7
2440	-7.27	18.73	-1.44
2450	-7.25	18.83	-1.34
2460	-7.35	18.43	-1.36
2470	-7.41	18.14	-1.37
2480	-7.59	17.43	-1.54
2490	-7.67	17.12	-1.64
2500	-7.64	17.22	-1.72

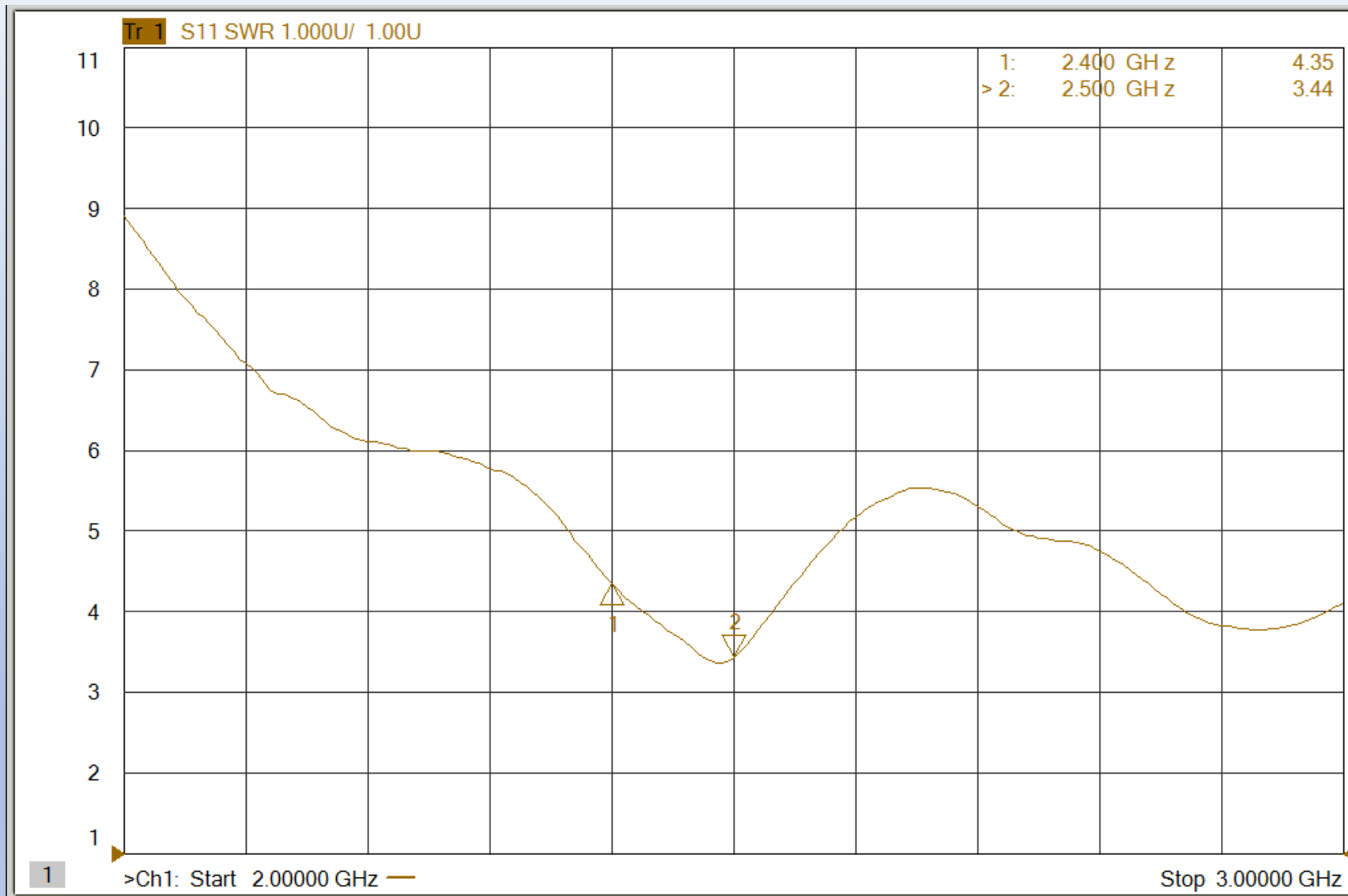

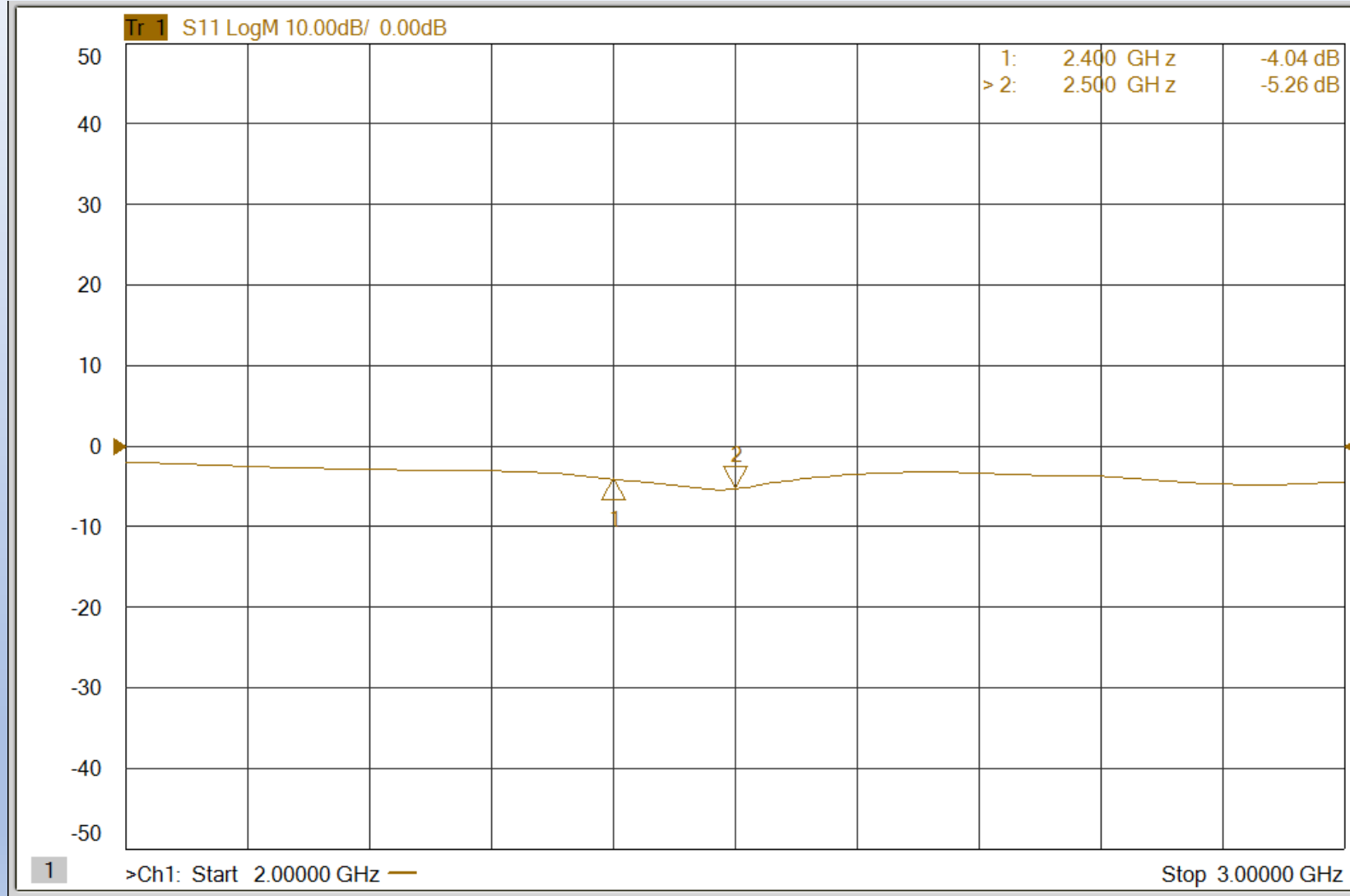



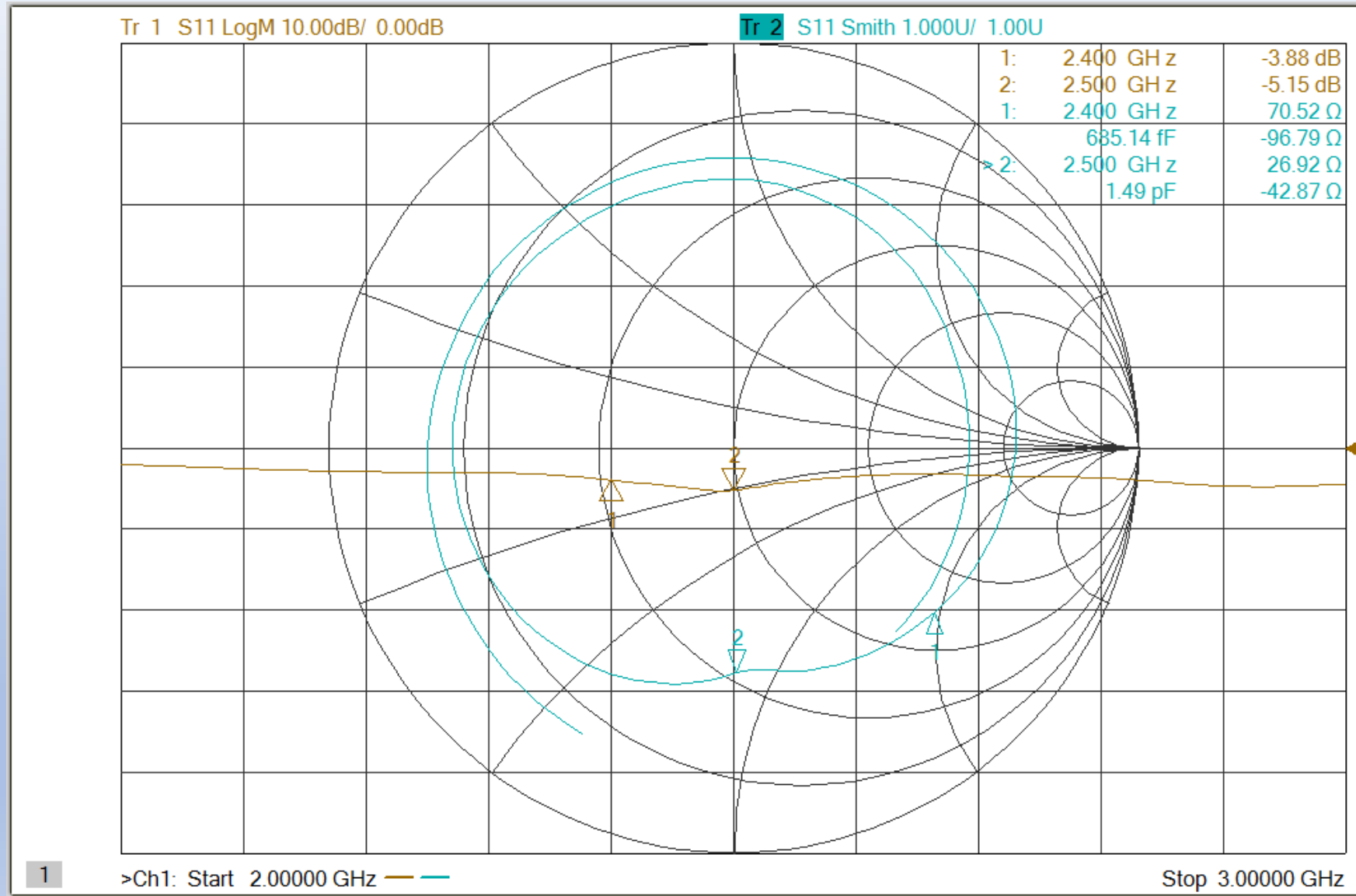



深圳汉阳天线设计有限公司

SHENZHEN HANYANG ANTENNA DESIGN CO. LTD.

# 5G

Welcome calls consultations, negotiations and guidance come!

# Thank you

地址：深圳市宝安区前进路宝运达物 流信息大厦**12A**层。

电话：**0755-23069700**

汉阳天线 版权所有 Copyright ©2014-2024 Shenzhen Hanyang Antenna Design Co., Ltd. All rights reserved.