



Report No.: EA21040116F03001

1 of 31

**ELECTROMAGNETIC EMISSIONS COMPLIANCE REPORT
INTENTIONAL RADIATOR CERTIFICATION TO
FCC PART 15 SUBPART C REQUIREMENT**

OF

Lite Wallet Plus

Model No.: Lite Wallet Plus

Trademark:  **LEDLENSER**

FCC ID: 2ASEU-LWPLUS

Report No.: EA21040116F03001

Issue Date: July 29, 2021

Prepared for

Ledlenser Corporation Ltd.

**No.25, Yudong 1 Road, Dongcheng Town, Yangdong District, Yangjiang
City, GD, 529931, China**

Prepared by

Dong Guan Anci Electronic Technology Co., Ltd.

**1-2 Floor, Building A, No.11, Headquarters 2 Road, Songshan, Lake
Hi-tech Industrial Development Zone, Dongguan City, Guangdong Pr.,
China.**

**This report shall not be reproduced, except in full, without the written approval of
Dong Guan Anci Electronic Technology Co., Ltd.**



VERIFICATION OF COMPLIANC

Applicant:	Ledlenser Corporation Ltd. No.25, Yudong 1 Road, Dongcheng Town, Yangdong District, Yangjiang City, GD, 529931, China
Manufacturer:	Ledlenser Corporation Ltd. No.25, Yudong 1 Road, Dongcheng Town, Yangdong District, Yangjiang City, GD, 529931, China
Product Description:	Lite Wallet Plus
Trade Mark:	
Model Number:	Lite Wallet Plus

We hereby certify that:

The above equipment was tested by Dong Guan Anci Electronic Technology Co., Ltd. The test data, data evaluation, test procedures, and equipment configurations shown in this report were made in accordance with the procedures given in ANSI C63.10-2013 and the energy emitted by the sample EUT tested as described in this report is in compliance with conducted and radiated emission limits of FCC Rules Part 15.209(2020).

Date of Test : July 01, 2021 to July 29, 2021

Prepared by : 
Tomas Yang/Supervisor

Reviewer & Authorized Signer : 
Alan He/Manager





Modified Information

Version	Summary	Revision Date	Report No.
Ver.1.0	Original Report	/	EA21040116F03001



Table of Contents

1 GENERAL INFORMATION	5
1.1 PRODUCT DESCRIPTION	5
1.2 RELATED SUBMITTAL(S) / GRANT(S)	6
1.3 TEST METHODOLOGY	6
1.4 SPECIAL ACCESSORIES	6
1.5 EQUIPMENT MODIFICATIONS	6
1.6 TEST FACILITY	6
2 SYSTEM TEST CONFIGURATION.....	7
2.1 EUT CONFIGURATION	7
2.2 EUT EXERCISE	7
2.3 TEST PROCEDURE	7
2.4 CONFIGURATION OF TESTED SYSTEM.....	8
3 SUMMARY OF TEST RESULTS.....	8
4 TEST SYSTEM UNCERTAINTY.....	9
5 CONDUCTED EMISSIONS TEST	10
5.1 MEASUREMENT PROCEDURE	10
5.2 TEST SET-UP (BLOCK DIAGRAM OF CONFIGURATION)	10
5.3 MEASUREMENT EQUIPMENT USED.....	10
5.4 CONDUCTED EMISSION LIMIT	10
5.5 MEASUREMENT RESULT	11
5.6 CONDUCTED MEASUREMENT PHOTO.....	14
6 RADIATED EMISSION TEST.....	15
6.1 MEASUREMENT PROCEDURE	15
6.2 TEST SET-UP (BLOCK DIAGRAM OF CONFIGURATION)	15
6.3 MEASUREMENT EQUIPMENT USED.....	16
6.4 RADIATED EMISSION LIMIT	16
6.5 MEASUREMENT RESULT	18
6.6 RADIATED MEASUREMENT PHOTOS.....	22
7 20DB BANDWIDTH	23
7.1 20dB BANDWIDTH LIMIT	23
7.2 TEST INSTRUMENTS.....	23
7.3 TEST PROCEDURE	23
7.4 TEST SETUP.....	23
7.5 TEST RESULT.....	23
8 ANTENNA APPLICATION	25
8.1 ANTENNA REQUIREMENT	25
8.2 RESULT	25



1 General Information

1.1 Product Description

Characteristics	Description
Product Name	Lite Wallet Plus
Model number	Lite Wallet Plus
Operation Mode	Wireless Charging
Input Rating	Type C/Wireless: 5V = 1A
Power Supply	AC120V/60Hz for adapter
Operating Frequency	110-205KHz
Wireless Charging Power	5W
Modulation Technique	ASK
Antenna Type	Induction coil



1.2 Related Submittal(s) / Grant(s)

This submittal(s) (test report) is intended for FCC ID: 2ASEU-LWPLUS filing to comply with the FCC Part 15, Subpart C Rules.

1.3 Test Methodology

Both conducted and radiated testing was performed according to the procedures in ANSI C63.10 (2013). Radiated testing was performed at an antenna to EUT distance 3 meters.

1.4 Special Accessories

Not available for this EUT intended for grant.

1.5 Equipment Modifications

Not available for this EUT intended for grant.

1.6 Test Facility

Site Description
EMC Lab. : Accredited by CNAS, 2017.06.26
The certificate is valid until 2022.10.28
The Laboratory has been assessed and proved to be in compliance with
CNAS-CL01:2006 (identical to ISO/IEC 17025:2005)
The Certificate Registration Number is L6214.

Accredited by A2LA, 2018.03.15
The Certificate Number is 4422.01.

Name of Firm : Dong Guan Anci Electronic Technology Co., Ltd.
Site Location : 1-2 Floor, Building A, No.11, Headquarters 2 Road, Songshan, Lake
Hi-tech Industrial Development Zone, Dongguan City, development Zone,
Dongguan City, Guangdong Pr., China.



2 System Test Configuration

2.1 EUT Configuration

The EUT configuration for testing is installed on RF field strength measurement to meet the Commissions requirement and operating in a manner which intends to maximize its emission characteristics in a continuous normal application.

2.2 EUT Exercise

The Transmitter was operated in the normal operating mode. The TX frequency was fixed which was for the purpose of the measurements.

2.3 Test Procedure

2.3.1 Conducted Emissions

The EUT is a placed on as turn table which is 0.8 m above ground plane. According to the requirements in Section 13.1.4.1 of ANSI C63.10-2013 Conducted emissions from the EUT measured in the frequency range between 0.15 MHz and 30 MHz using CISPR Quasi-Peak and average detector mode.

2.3.2 Radiated Emissions

The EUT is a placed on as turn table which is 0.8 m above ground plane. The turn table shall rotate 360 degrees to determine the position of maximum emission level. EUT is set 3m away from the receiving antenna which varied from 1m to 4m to find out the highest emission. And also, each emission was to be maximized by changing the polarization of receiving antenna both horizontal and vertical. In order to find out the max. emission, the fixed in a particular direction according to the requirements in Section 13.1.4.1 of ANSI C63.10-2013.

2.4 Configuration of Tested System

Fig. 2-1 Configuration of Tested System

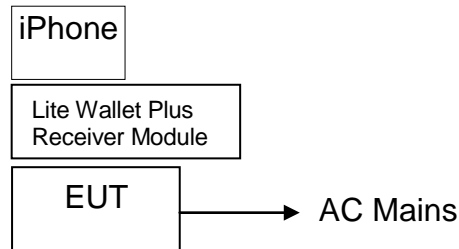

Table 2-1 Equipment Used in Tested System

Item	Equipment	Trade Mark	Model No.	FCC ID	Note
1.	Lite Wallet Plus	N/A	Lite Wallet Plus	2ASEU-LWPLUS	EUT
2.	Adapter	UGREEN	Model:CD217 Input: AC 100-240V, 50/60Hz Output: DC 5V/3A, DC 9V/3A, DC 12V/2.5A	N/A	Support EUT
3.	SAMSUNG S9	SAMSUNG	Samsung Galaxy S9	N/A	Support Equipment
4.	Xiaomi 9	MI	Xiaomi 9	N/A	Support Equipment
5.	Wireless Charging Receiver Module	Universal	N/A	N/A	Support Equipment

Note:

- (1) Unless otherwise denoted as EUT in 『Remark』 column, device(s) used in tested system is a support equipment.

3 Summary of Test Results

FCC Rules	Description Of Test	Result
§15.207	AC Power Conducted Emission	Compliant
§15.209	Radiated Emission	Compliant
§2.1049	20dB Bandwidth	Compliant
§15.203	Antenna Requirement	Compliant



4 TEST SYSTEM UNCERTAINTY

The following measurement uncertainty levels have been estimated for tests performed on the apparatus:

Parameter	Uncertainty
Conducted Emissions Test	$\pm 2.0\text{dB}$
Radiated Emission Test	$\pm 2.0\text{dB}$
Temperature	$\pm 0.5^\circ\text{C}$
Humidity	$\pm 3\%$

Remark: The coverage Factor ($k=2$), and measurement Uncertainty for a level of Confidence of 95%

5 Conducted Emissions Test

5.1 Measurement Procedure

1. The EUT was placed on a table which is 0.8m above ground plane.
2. Maximum procedure was performed on the six highest emissions to ensure EUT compliance.
3. Repeat above procedures until all frequency measured was complete.

5.2 Test SET-UP (Block Diagram of Configuration)

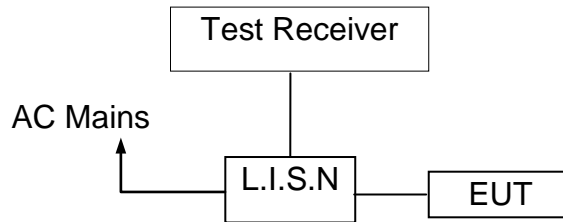

5.3 Measurement Equipment Used

EQUIPMENT TYPE	MFR	MODEL NUMBER	SERIAL NUMBER	Calibrated until
L.I.S.N	SCHWARZBECK	NSLK 8127	8127-669	2022-05-20
10 db attenuator	JFW	50FP-010-H4	4360846-427-1	2022-05-20
RF Cable	N/A	N/A	2#	2022-05-20
EMI Test Receiver	ROHDE&SCHWARZ	ESCI	101358	2022-05-20

5.4 Conducted Emission Limit

Conducted Emission Frequency(MHz)	Quasi-peak	Average
0.15-0.5	66-56	56-46
0.5-5.0	56	46
5.0-30.0	60	50

- Note:** 1. The lower limit shall apply at the transition frequencies
 2. The limit decreases in line with the logarithm of the frequency in the range of 0.15 to 0.50MHz.



5.5 Measurement Result

Operation Mode:	TX	Test Date :	2021/07/20
Frequency Range:	0.15MHz~30MHz	Temperature :	28°C
Test Result:	PASS	Humidity :	65 %
Test By:	Best		

Pass

We pretested modes (Wireless Charging(5W)) for EUT. The worst test data see follow the table.



Test mode: Wireless Charging 5W use Xiaomi 9

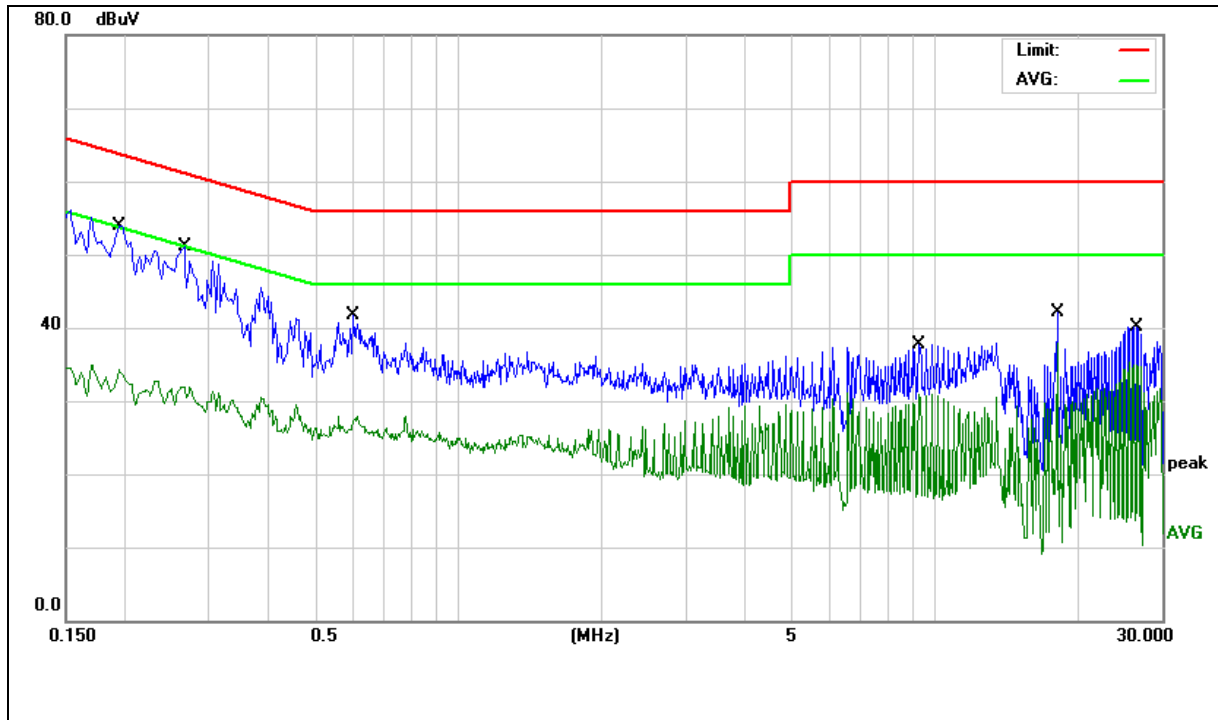

Site:	843	Phase:	L1	Temperature(C):	26(C)
Limit:	FCC Part 18 C Conduction(QP)			Humidity(%):	60%
EUT:	Lite Wallet Plus	Test Time:	2021/07/20		
M/N.:	Lite Wallet Plus	Power Rating:	AC 120V/60Hz		
Mode:	Wireless Charging 5W	Test Engineer:	Jack		
Note:					

No.	Frequency (MHz)	Reading Level(dBuV)	Factor (dB)	Measurement(dBuV)	Limit (dBuV)	Over (dB)	Detector	Comment
1	0.1940	38.49	9.66	48.15	63.86	-15.71	QP	
2	0.1940	22.28	9.66	31.94	53.86	-21.92	AVG	
3	0.2660	35.39	9.66	45.05	61.24	-16.19	QP	
4	0.2660	21.12	9.66	30.78	51.24	-20.46	AVG	
5	0.6020	25.89	9.75	35.64	56.00	-20.36	QP	
6	0.6020	17.54	9.75	27.29	46.00	-18.71	AVG	
7	9.2940	15.28	10.08	25.36	60.00	-34.64	QP	
8	9.2940	6.06	10.08	16.14	50.00	-33.86	AVG	
9	18.1020	7.71	10.14	17.85	60.00	-42.15	QP	
10	18.1020	0.70	10.14	10.84	50.00	-39.16	AVG	
11	26.5060	8.15	10.21	18.36	60.00	-41.64	QP	
12	26.5060	1.74	10.21	11.95	50.00	-38.05	AVG	

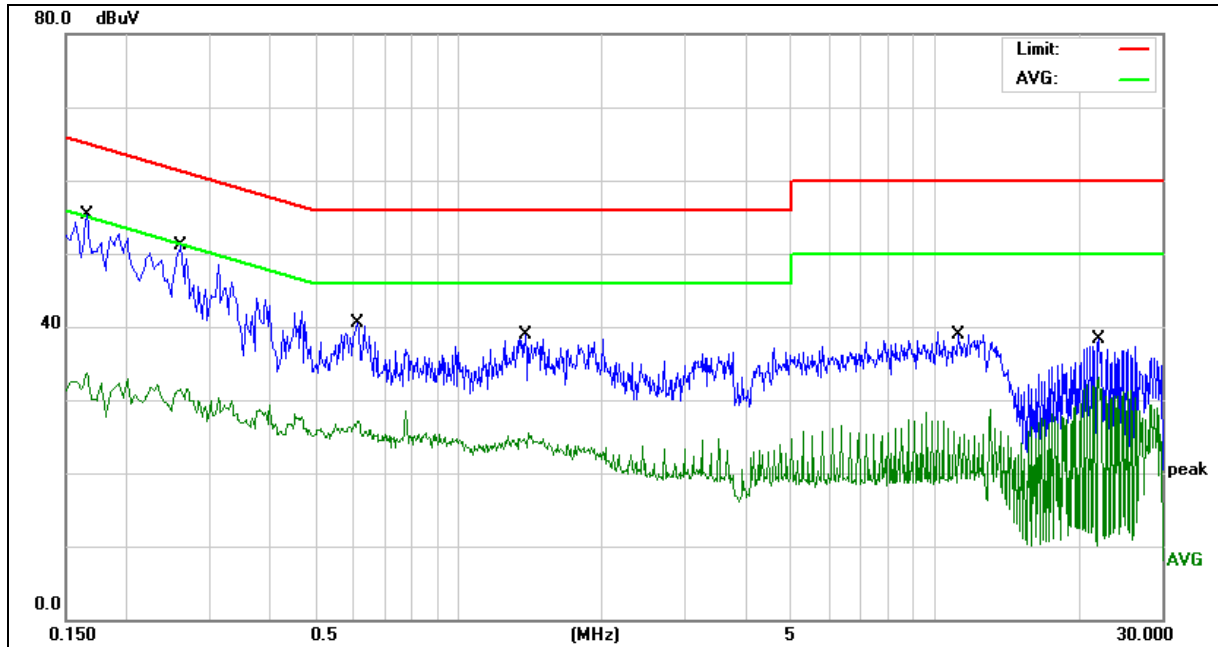

Site:	843	Phase:	N	Temperature(C):	26(C)
Limit:	FCC Part 18 C Conduction(QP)			Humidity(%):	60%
EUT:	Lite Wallet Plus	Test Time:	2021/07/20		
M/N.:	Lite Wallet Plus	Power Rating:	AC 120V/60Hz		
Mode:	Wireless Charging 5W	Test Engineer:	Jack		
Note:					

No.	Frequency (MHz)	Reading Level(dBuV)	Factor (dB)	Measurement(dBuV)	Limit (dBuV)	Over (dB)	Detector	Comment
1	0.1660	37.43	9.65	47.08	65.15	-18.07	QP	
2	0.1660	21.49	9.65	31.14	55.15	-24.01	AVG	
3	0.2620	35.03	9.66	44.69	61.36	-16.67	QP	
4	0.2620	20.53	9.66	30.19	51.36	-21.17	AVG	
5	0.6140	24.03	9.75	33.78	56.00	-22.22	QP	
6	0.6140	16.43	9.75	26.18	46.00	-19.82	AVG	
7	1.3860	22.33	9.88	32.21	56.00	-23.79	QP	
8	1.3860	14.89	9.88	24.77	46.00	-21.23	AVG	
9	11.2540	20.59	10.11	30.70	60.00	-29.30	QP	
10	11.2540	9.13	10.11	19.24	50.00	-30.76	AVG	
11	22.0740	10.94	10.16	21.10	60.00	-38.90	QP	
12	22.0740	0.61	10.16	10.77	50.00	-39.23	AVG	

5.6 Conducted Measurement Photo



6 Radiated Emission Test

6.1 Measurement Procedure

1. The EUT was placed on a turn table which is 0.8m above ground plane.
2. Maximum procedure was performed on the six highest emissions to ensure EUT compliance.
3. And also, each emission was to be maximized by changing the polarization of receiving antenna both horizontal and vertical.
4. Repeat above procedures until all frequency measured were complete.

6.2 Test SET-UP (Block Diagram of Configuration)

(A) Radiated Emission Test Set-Up, Frequency Below 30MHz

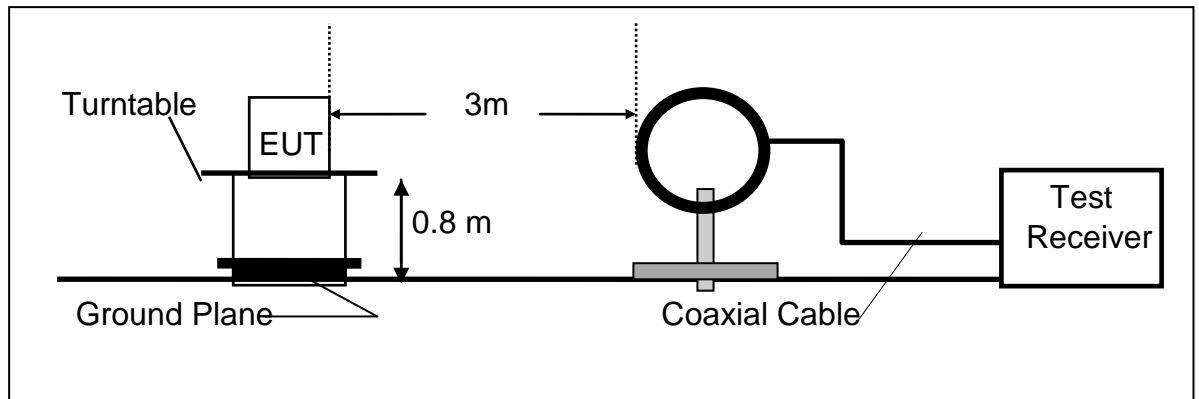

(B) Radiated Emission Test Set-Up, Frequency Below 1000MHz

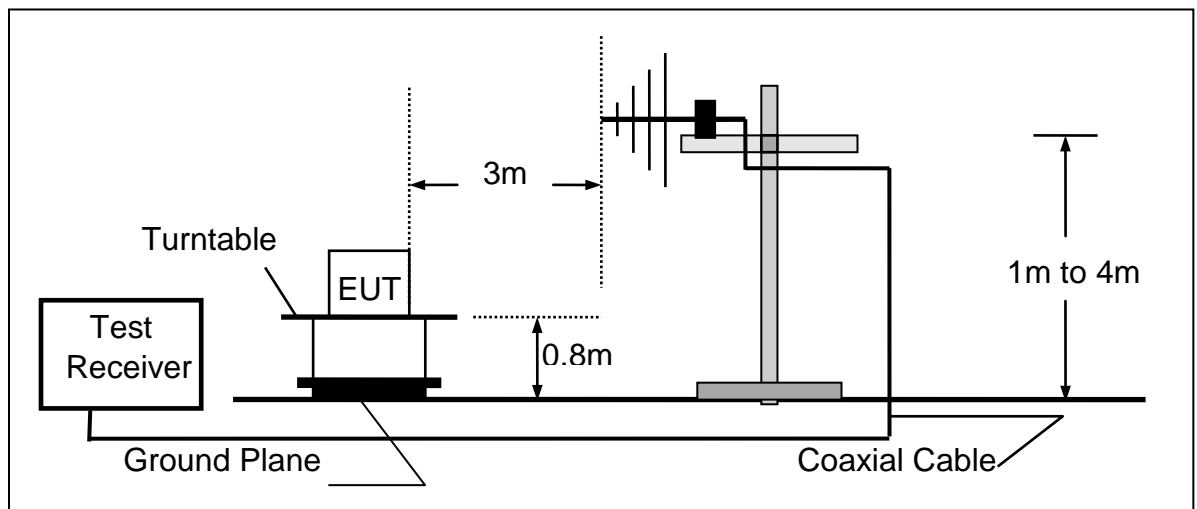



6.3 Measurement Equipment Used

Item	Equipment	Manufacturer	Model No.	Serial No.	Calibrated until
1.	EMI Test Receiver	Rohde & Schwarz	ESPI	100502	2021/11/19
2.	Pre-Amplifier	HP	8447D	2727A06172	2022-05-23
3.	Bilog Antenna	Schwarzbeck	VULB9163	VULB9163-588	2022-05-23
4.	Loop Antenna	Schwarzbeck	FMZB 1516	1516-141	2021/11/19
5.	RF Cable	Gigalink Microwave	ZT40-2.92J-2.92 J-2m	N/A	2021/11/19
6.	RF Cable	Gigalink Microwave	ZT40-2.92J-2.92 J-0.3m	N/A	2021/11/19
7.	RF Cable	N/A	N/A	6#	2022-05-23
8.	3m Semi-anechoic Chamber	chengyu	9m*6m*6m	N/A	2022-05-23
9.	Test Software	Farad	EZ-EMC Ver:ANCI-3A1	N/A	N/A

6.4 Radiated Emission Limit

The emissions from an intentional radiator shall not exceed the field strength levels specified in the following table 15.209(a):

FCC Part 15.209				
Frequency (MHz)	Field Strength Limitation		Field Strength Limitation Frequency tion at 3m Measurement Dist	
	(uV/m)	Dist	(uV/m)	(dBuV/m)
0.009 – 0.490	2400 / F(KHz)	300m	10000 * 2400/F(KHz)	20log 2400/F(KHz) + 80
0.490 – 1.705	24000 / F(KHz)	30m	100 * 24000/F(KHz)	20log 24000/F(KHz) + 40
1.705 – 30.00	30	30m	100* 30	20log 30 + 40
30.0 – 88.0	100	3m	100	20log 100
88.0 – 216.0	150	3m	150	20log 150
216.0 – 960.0	200	3m	200	20log 200
Above 960.0	500	3m	500	20log 500



15.205 Restricted bands of operation

MHz	MHz	MHz	GHz
0.090 - 0.110	16.42 - 16.423	399.9 - 410	4.5 - 5.15
¹ 0.495 - 0.505	16.69475 - 16.69525	608 - 614	5.35 - 5.46
2.1735 - 2.1905	16.80425 - 16.80475	960 - 1240	7.25 - 7.75
4.125 - 4.128	25.5 - 25.67	1300 - 1427	8.025 - 8.5
4.17725 - 4.17775	37.5 - 38.25	1435 - 1626.5	9.0 - 9.2
4.20725 - 4.20775	73 - 74.6	1645.5 - 1646.5	9.3 - 9.5
6.215 - 6.218	74.8 - 75.2	1660 - 1710	10.6 - 12.7
6.26775 - 6.26825	108 - 121.94	1718.8 - 1722.2	13.25 - 13.4
6.31175 - 6.31225	123 - 138	2200 - 2300	14.47 - 14.5
8.291 - 8.294	149.9 - 150.05	2310 - 2390	15.35 - 16.2
8.362 - 8.366	156.52475 - 156.52525	2483.5 - 2500	17.7 - 21.4
8.37625 - 8.38675	156.7 - 156.9	2690 - 2900	22.01 - 23.12
8.41425 - 8.41475	162.0125 - 167.17	3260 - 3267	23.6 - 24.0
12.29 - 12.293	167.72 - 173.2	3332 - 3339	31.2 - 31.8
12.51975 - 12.52025	240 - 285	3345.8 - 3358	36.43 - 36.5
12.57675 - 12.57725	322 - 335.4	3600 - 4400	(²)

- Remark:
1. Emission level in dBuV/m=20 log (uV/m)
 2. Measurement was performed at an antenna to the closed point of EUT distance of meters.
 3. Only spurious frequency is permitted to locate within the Restricted Bands specified in provision of ξ 15.205, and the emissions located in restricted bands also comply with 15.209 limit.



6.5 Measurement Result

We pretested modes (Wireless Charging(5W)) for EUT. The worst mode (Wireless Charging(5W))test data see follow the table.

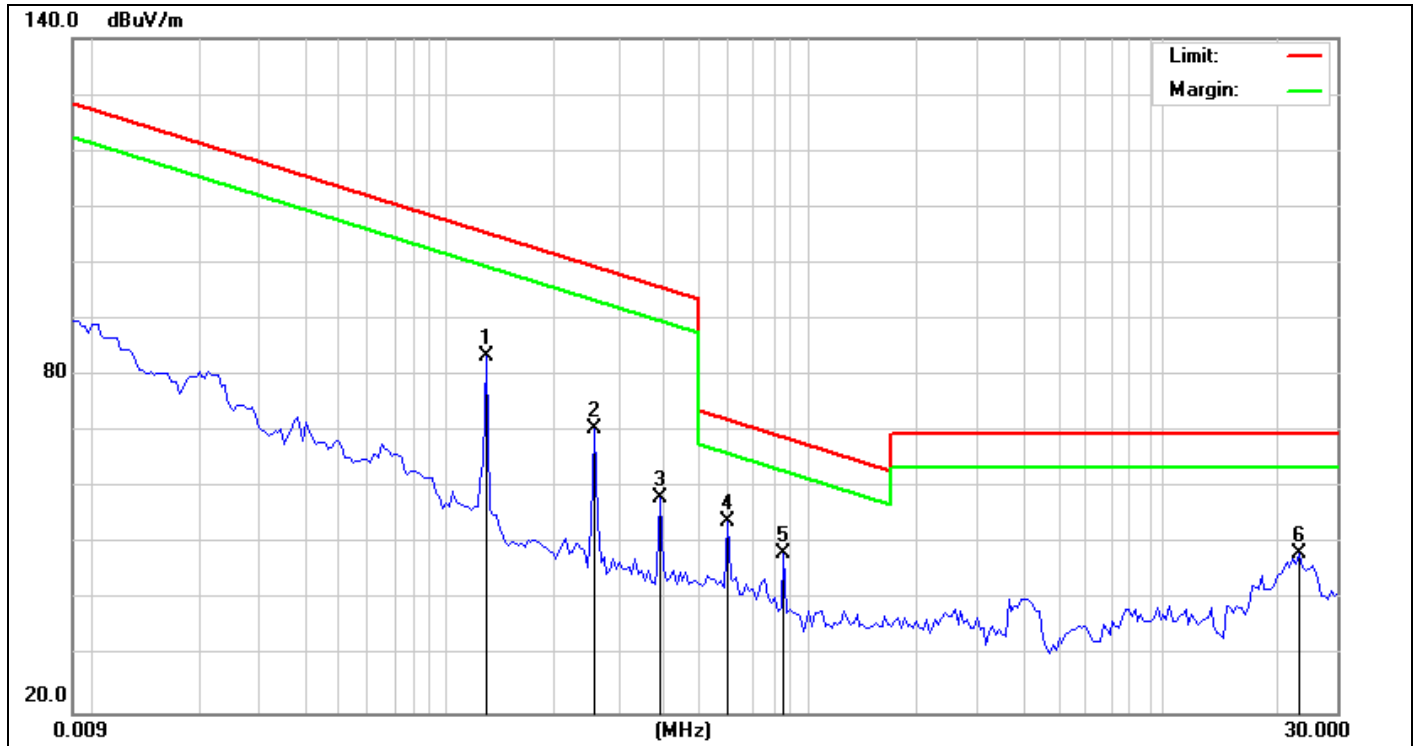

Site:	LAB	Antenna: Vertical	Temperature(C): 23.4(C)
Limit:	FCC Part 15 Class B 3m Radiation(QP)	Test Time:	Humidity(%): 56.7%
EUT:	Lite Wallet Plus	Power Rating:	AC 120V/60Hz
M/N.:	Lite Wallet Plus	Test Engineer:	sunshine
Mode:	Wireless Charging 5W		
Note:			

No.	Frequency (MHz)	Reading (dBuV)	Factor (dB/m)	Level (dBuV/m)	Limit (dBuV/m)	Margin (dB)	Det.	Height (cm)	Azimuth (deg)	Remark
1	0.1282	77.33	6.20	83.53	105.37	-21.84	QP	100	125	
2	0.2555	65.03	5.60	70.63	99.42	-28.79	QP	100	125	
3	0.3911	52.40	5.99	58.39	95.74	-37.35	QP	100	48	
4 *	0.5988	47.75	6.40	54.15	72.06	-17.91	QP	100	48	
5	0.8627	42.09	6.30	48.39	68.90	-20.51	QP	100	236	
6	23.5198	41.90	6.35	48.25	69.50	-21.25	QP	100	236	

*:Maximum data x:Over limit !:over margin

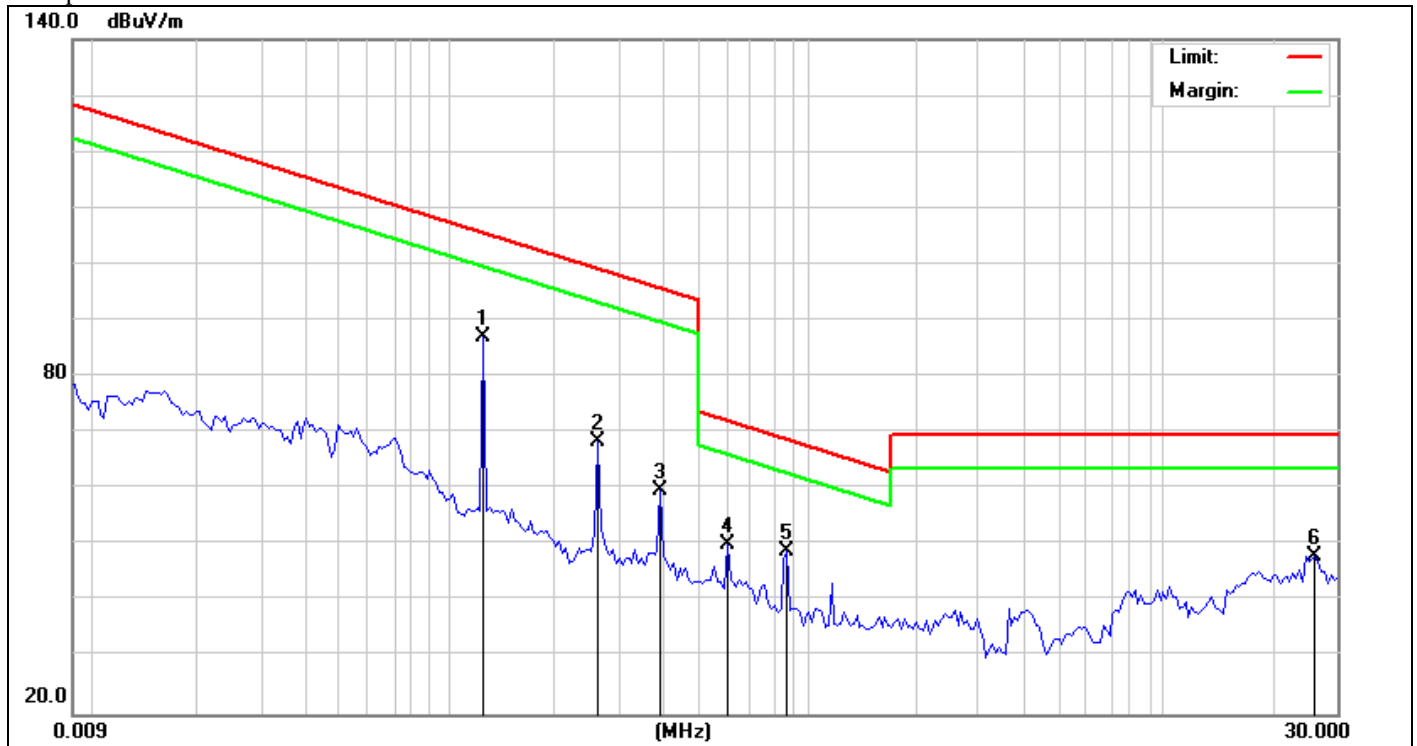

Site:	LAB	Antenna::	Horizontal	Temperature(C):	23.4(C)
Limit:	FCC Part 15 Class B 3m Radiation(QP)			Humidity(%):	56.7%
EUT:	Lite Wallet Plus	Test Time:			2021/07/20
M/N.:	Lite Wallet Plus	Power Rating:			AC 120V/60Hz
Mode:	Wireless Charging 5W	Test Engineer:			sunshine
Note:					

No.	Frequency (MHz)	Reading (dBuV)	Factor (dB/m)	Level (dBuV/m)	Limit (dBuV/m)	Margin (dB)	Det.	Height (cm)	Azimuth (deg)	Remark
1 *	0.1257	80.93	6.22	87.15	105.54	-18.39	QP	100	125	
2	0.2607	62.81	5.61	68.42	99.25	-30.83	QP	100	125	
3	0.3911	53.90	5.99	59.89	95.74	-35.85	QP	100	48	
4	0.5988	43.75	6.40	50.15	72.06	-21.91	QP	100	48	
5	0.8803	42.56	6.27	48.83	68.72	-19.89	QP	100	236	
6	26.0298	42.16	5.89	48.05	69.50	-21.45	QP	100	236	

- Note:**
- (1) All Readings are Peak Value.
 - (2) Emission Level= Reading Level+Probe Factor +Cable Loss.
 - (3) The average measurement was not performed when the peak measured data under the limit of average detection.
 - (4) EUT lying on the table position is the worst case result in the report.



We pretested modes (Wireless Charging (5W)) for EUT. The worst test data see follow the table.

Test mode: Wireless Charging 5W use Xiaomi 9

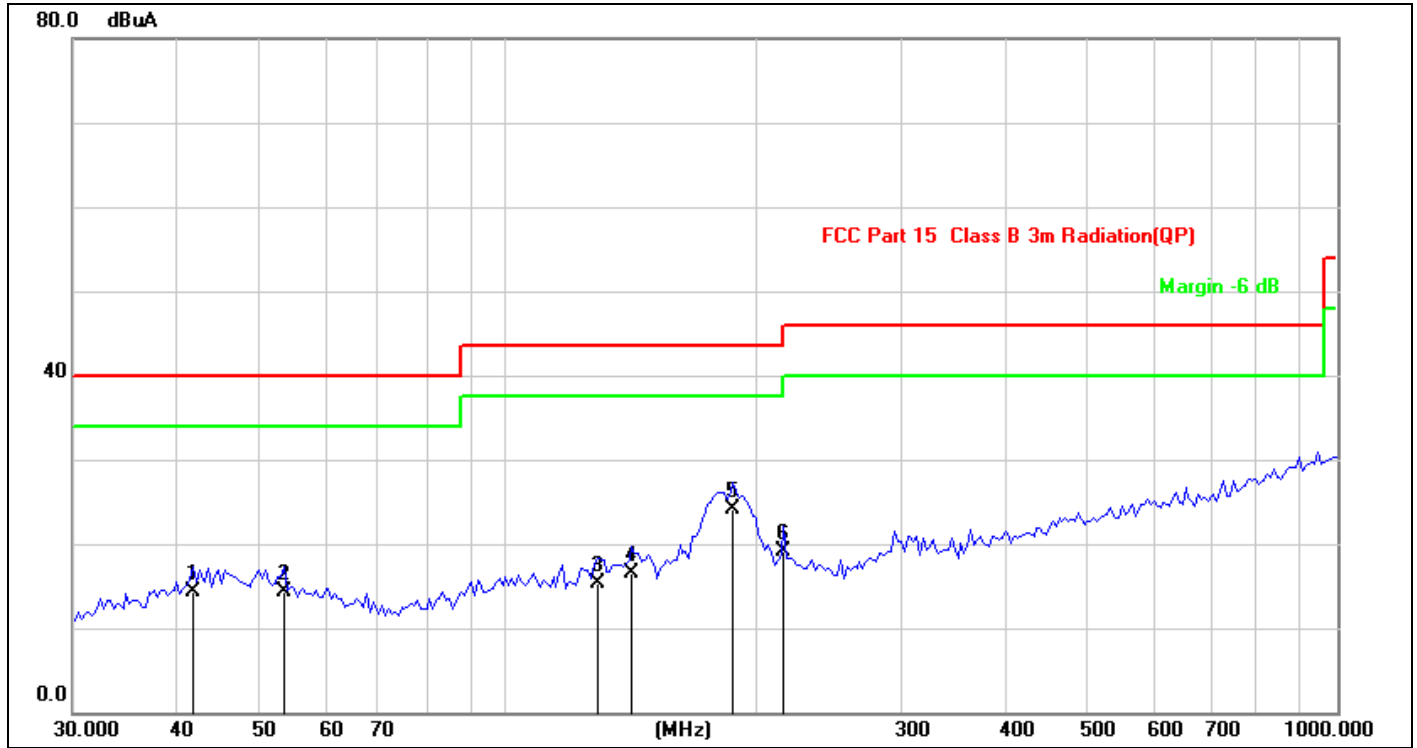

Site:	LAB	Antenna::	Vertical	Temperature(C):	23.4(C)
Limit:	FCC Part 15 Class B 3m Radiation(QP)	Test Time:	2021/07/20	Humidity(%):	56.7%
EUT:	Lite Wallet Plus	Power Rating:	AC 120V/60Hz		
M/N.:	Lite Wallet Plus	Test Engineer:	sunshine		
Mode:	Wireless Charging 5W				
Note:					

No.	Frequency (MHz)	Reading (dBuV)	Factor (dB/m)	Level (dBuV/m)	Limit (dBuV/m)	Margin (dB)	Det.	Height (cm)	Azimuth (deg)	Remark
1	41.8596	27.10	-12.86	14.24	40.00	-25.76	QP	100	45	
2	53.9763	26.60	-12.24	14.36	40.00	-25.64	QP	100	45	
3	128.5630	29.40	-14.17	15.23	43.50	-28.27	QP	100	27	
4	141.5777	31.27	-14.67	16.60	43.50	-26.90	QP	100	27	
5	187.4241	35.83	-11.64	24.19	43.50	-19.31	QP	100	96	
6	215.6456	29.82	-10.71	19.11	43.50	-24.39	QP	100	96	

*:Maximum data x:Over limit !:over margin

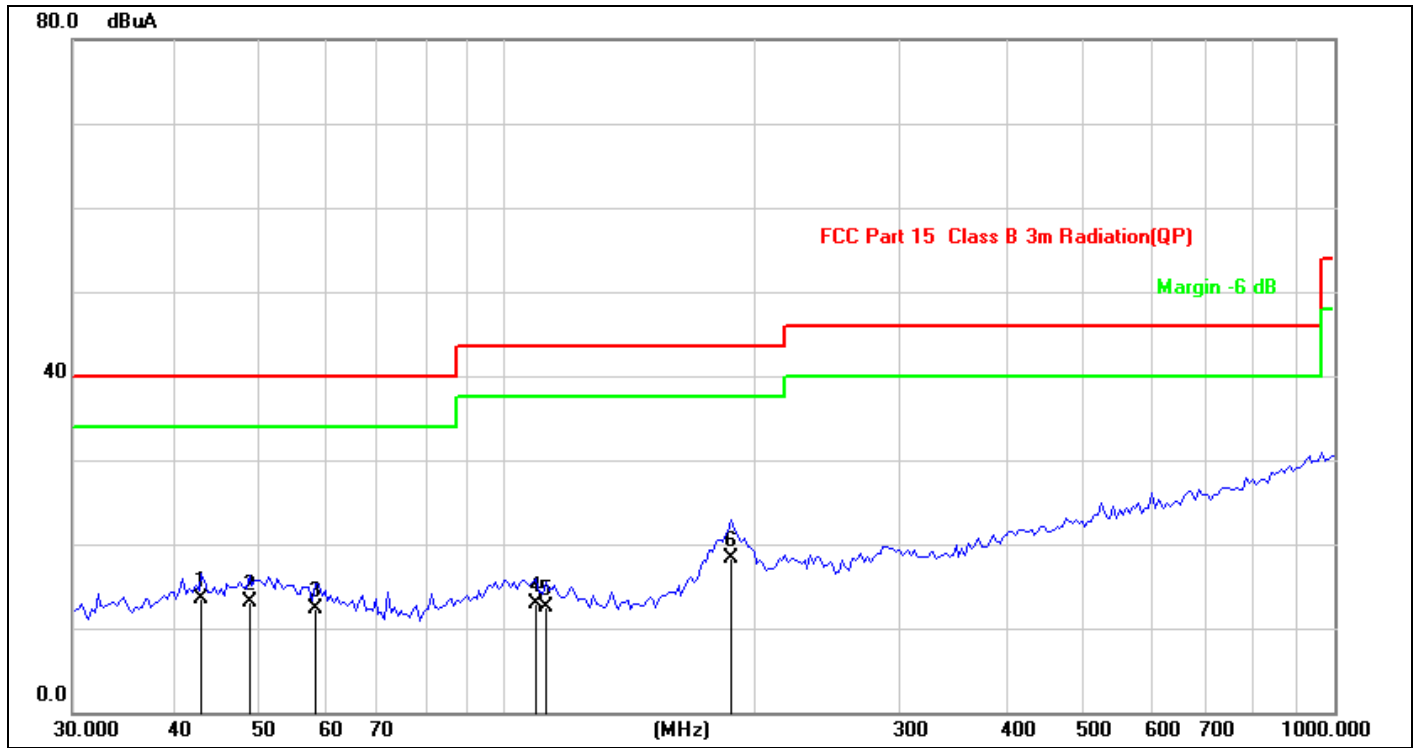

Site:	LAB	Antenna::	Horizontal	Temperature(C):	23.4(C)
Limit:	FCC Part 15 Class B 3m Radiation(QP)			Humidity(%):	56.7%
EUT:	Lite Wallet Plus	Test Time:			2021/07/20
M/N.:	Lite Wallet Plus	Power Rating:			AC 120V/60Hz
Mode:	Wireless Charging 5W	Test Engineer:			sunshine
Note:					

No.	Frequency (MHz)	Reading (dBuV)	Factor (dB/m)	Level (dBuV/m)	Limit (dBuV/m)	Margin (dB)	Det.	Height (cm)	Azimuth (deg)	Remark
1	42.9750	26.24	-12.69	13.55	40.00	-26.45	QP	100	45	
2	49.0144	25.00	-11.80	13.20	40.00	-26.80	QP	100	45	
3	58.9217	25.32	-12.96	12.36	40.00	-27.64	QP	100	27	
4	108.8375	24.65	-11.74	12.91	43.50	-30.59	QP	100	27	
5	111.7378	24.55	-12.04	12.51	43.50	-30.99	QP	100	96	
6	187.4241	29.98	-11.64	18.34	43.50	-25.16	QP	100	96	

6.6 Radiated Measurement Photos

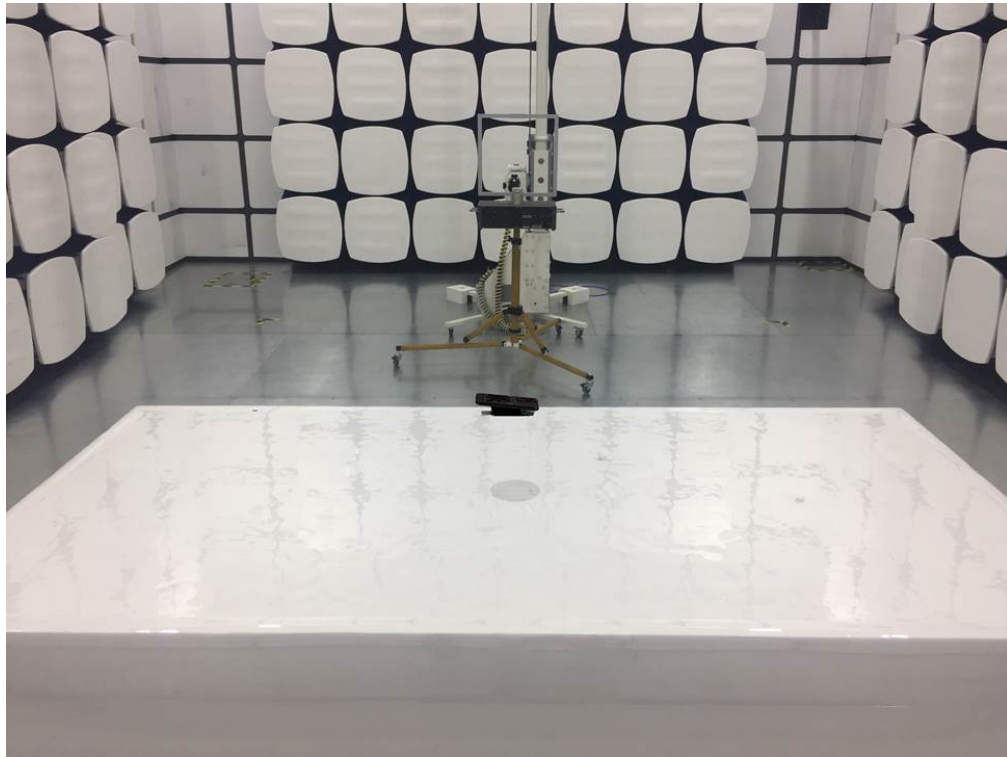

7 20db Bandwidth

7.1 20dB Bandwidth Limit

None: for reporting purposed only.

7.2 Test Instruments

Refer a test equipment and calibration data table in this test report.

7.3 Test Procedure

The bandwidth of the fundamental frequency was measured by spectrum analyzer with 10kHz RBW and 30kHz VBW. The 20dB bandwidth is defined as the total spectrum the power of which is higher than peak power minus 20dB.

7.4 Test Setup

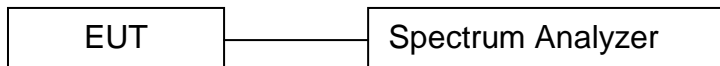

7.5 Test Result

Frequency (KHz)	20dB Bandwidth (kHz)	Results
120.97	2.663	PASS



20 dB Bandwidth Test plot

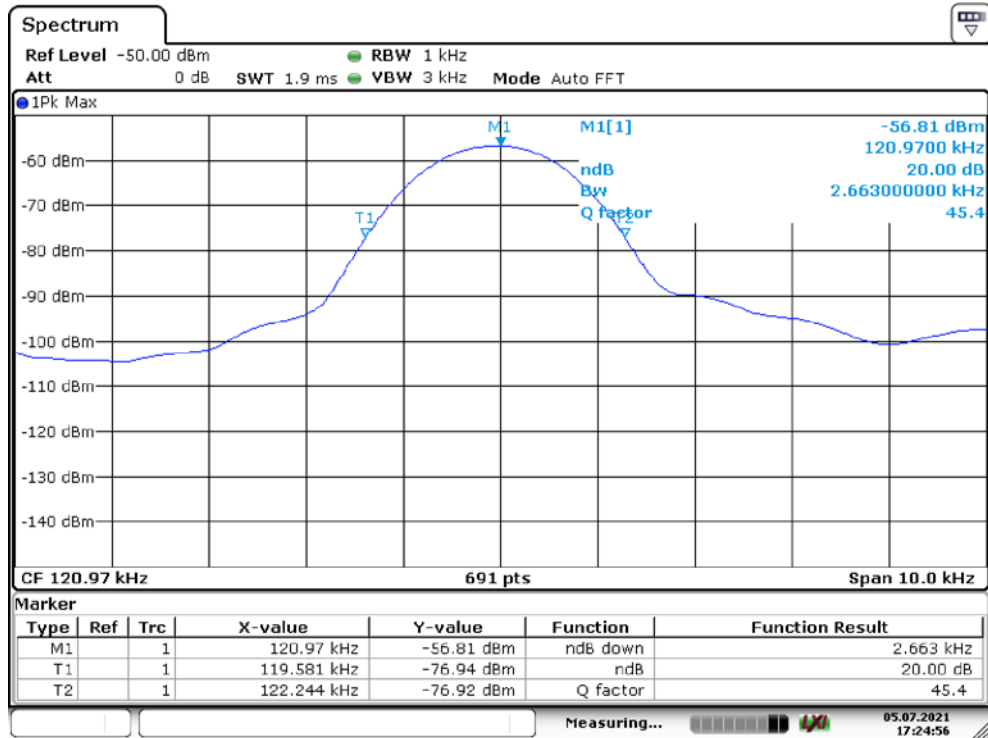

Date: 5.JUL.2021 17:24:56



8 Antenna Application

8.1 Antenna requirement

For intentional device, according to FCC 47 CFR Section 15.203, an intentional radiator shall be designed to ensure that no antenna other than that furnished by the responsible party shall be used with the device.

8.2 Result

The EUT's antenna, permanent attached antenna, used an Induction coil and integrated on PCB, The antenna's gain meets the requirement.



APPENDIX (Photos of EUT)







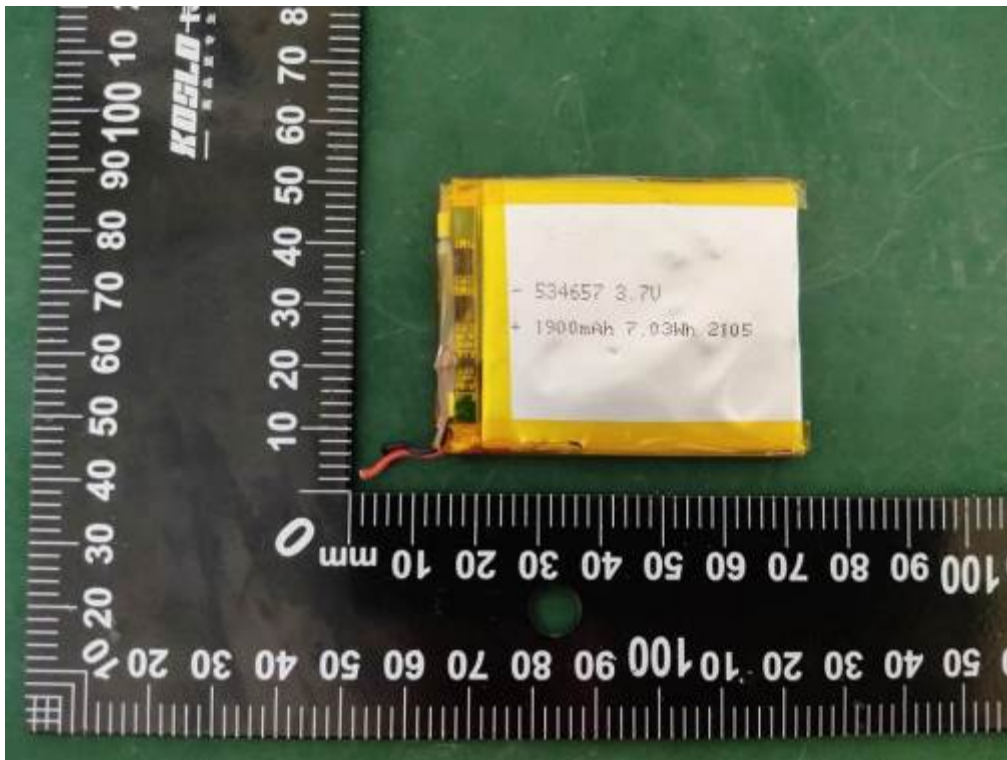



-----The end-----