

FCC Test Report

Applicant : **Ledlenser Corporation Ltd.**

Address : **No.25, Yudong 1 Road, Dongcheng Town
Yangdong District, Yangjiang, GuangDong,
529931,China**

Product Name : **Controller**

Report Date : **Oct. 18, 2023**

Shenzhen Anbotek Compliance Laboratory Limited



Shenzhen Anbotek Compliance Laboratory Limited

Address: 1/F., Building D, Sogood Science and Technology Park, Sanwei Community, Hangcheng Street, Bao'an District, Shenzhen, Guangdong, China.
Tel: (86)0755-26066440 Fax: (86)0755-26014772 Email: service@anbotek.com



Hotline
400-003-0500
www.anbotek.com.cn



Contents

1. General Information	6
1.1. Client Information	6
1.2. Description of Device (EUT)	6
1.3. Auxiliary Equipment Used During Test	7
1.4. Operation channel list	8
1.5. Description of Test Modes	8
1.6. Measurement Uncertainty	8
1.7. Test Summary	9
1.8. Description of Test Facility	10
1.9. Disclaimer	10
1.10. Test Equipment List	11
2. Antenna requirement	13
2.1. Conclusion	13
3. Conducted Emission at AC power line	14
3.1. EUT Operation	14
3.2. Test Setup	14
3.3. Test Data	15
4. Occupied Bandwidth	17
4.1. EUT Operation	17
4.2. Test Setup	17
4.3. Test Data	17
5. Maximum Conducted Output Power	19
5.1. EUT Operation	19
5.2. Test Setup	19
5.3. Test Data	19
6. Power Spectral Density	20
6.1. EUT Operation	20
6.2. Test Setup	20
6.3. Test Data	20
7. Emissions in non-restricted frequency bands	21
7.1. EUT Operation	21
7.2. Test Setup	21
7.3. Test Data	21
8. Band edge emissions (Radiated)	22
8.1. EUT Operation	22
8.2. Test Setup	22
8.3. Test Data	23
9. Emissions in frequency bands (below 1GHz)	25
9.1. EUT Operation	25
9.2. Test Setup	26
9.3. Test Data	27

Shenzhen Anbotek Compliance Laboratory Limited

Address: 1/F., Building D, Sogood Science and Technology Park, Sanwei Community, Hangcheng Street, Bao'an District, Shenzhen, Guangdong, China.
Tel: (86)0755-26066440 Fax: (86)0755-26014772 Email: service@anbotek.com



Hotline
400-003-0500
www.anbotek.com.cn



10. Emissions in frequency bands (above 1GHz).....	29
10.1. EUT Operation.....	29
10.2. Test Setup.....	29
10.3. Test Data.....	30
APPENDIX I -- TEST SETUP PHOTOGRAPH.....	33
APPENDIX II -- EXTERNAL PHOTOGRAPH.....	33
APPENDIX III -- INTERNAL PHOTOGRAPH.....	33

Shenzhen Anbotek Compliance Laboratory Limited

Address: 1/F., Building D, Sogood Science and Technology Park, Sanwei Community, Hangcheng Street, Bao'an District, Shenzhen, Guangdong, China.
Tel: (86)0755-26066440 Fax: (86)0755-26014772 Email: service@anbotek.com

 Hotline
400-003-0500
www.anbotek.com.cn



TEST REPORT

Applicant : Ledlenser Corporation Ltd.
Manufacturer : Ledlenser GmbH & Co.KG
Product Name : Controller
Test Model No. : Controller
Reference Model No. : N/A
Trade Mark : 
Rating(s) : Input: 12V~30VDC 3.33A max
Test Standard(s) : **47 CFR Part 15.247**

The device described above is tested by Shenzhen Anbotek Compliance Laboratory Limited to determine the maximum emission levels emanating from the device and the severe levels of the device can endure and its performance criterion. The measurement results are contained in this test report and Shenzhen Anbotek Compliance Laboratory Limited is assumed full of responsibility for the accuracy and completeness of these measurements. Also, this report shows that the EUT (Equipment Under Test) is technically compliant with above listed standard(s) requirements. This report applies to above tested sample only and shall not be reproduced in part without written approval of Shenzhen Anbotek Compliance Laboratory Limited.

Date of Receipt:

Sept. 12, 2023

Date of Test:

Sept. 12, 2023 to Sept. 22, 2023

Prepared By:

Nian xiu Chen

(Nianxiu Chen)

Approved & Authorized Signer:

Edward Pan

(Edward Pan)

Shenzhen Anbotek Compliance Laboratory Limited

Address: 1/F., Building D, Sogood Science and Technology Park, Sanwei Community, Hangcheng Street, Bao'an District, Shenzhen, Guangdong, China.
Tel: (86)0755-26066440 Fax: (86)0755-26014772 Email: service@anbotek.com



Hotline

400-003-0500

www.anbotek.com.cn



Revision History

Report Version	Description	Issued Date
R00	Original Issue.	Oct. 18, 2023

Shenzhen Anbotek Compliance Laboratory Limited

Address: 1/F., Building D, Sogood Science and Technology Park, Sanwei Community, Hangcheng Street, Bao'an District, Shenzhen, Guangdong, China.
Tel: (86)0755-26066440 Fax: (86)0755-26014772 Email: service@anbotek.com



Hotline
400-003-0500
www.anbotek.com.cn



1. General Information

1.1. Client Information

Applicant	:	Ledlenser Corporation Ltd.
Address	:	No.25, Yudong 1 Road, Dongcheng Town Yangdong District, Yangjiang, Guangdong, 529931, China
Manufacturer	:	Ledlenser GmbH & Co.KG
Address	:	Kronenstr.5-7,42699 Solingen,Germany
Factory	:	Ledlenser Corporation Ltd.
Address	:	No.25, Yudong 1 Road, Dongcheng Town Yangdong District, Yangjiang, Guangdong, 529931, China

1.2. Description of Device (EUT)

Product Name	:	Controller
Test Model No.	:	Controller
Reference Model No.	:	N/A
Trade Mark	:	
Test Power Supply	:	AC 120V/60Hz for adapter
Test Sample No.	:	1-2-1(Normal Sample), 1-2-2(Engineering Sample)
Adapter	:	N/A
RF Specification		
Operation Frequency	:	2402MHz to 2480MHz
Number of Channel	:	40
Modulation Type	:	GFSK
Antenna Type	:	Ceramics Antenna
Antenna Gain(Peak)	:	2.7 dBi
Remark:		
(1) All of the RF specification are provided by customer.		
(2) For a more detailed features description, please refer to the manufacturer's specifications or the User's Manual.		

Shenzhen Anbotek Compliance Laboratory Limited

Address: 1/F., Building D, Sogood Science and Technology Park, Sanwei Community, Hangcheng Street, Bao'an District, Shenzhen, Guangdong, China.
Tel: (86)0755-26066440 Fax: (86)0755-26014772 Email: service@anbotek.com



Hotline
400-003-0500
www.anbotek.com.cn



1.3. Auxiliary Equipment Used During Test

Title	Manufacturer	Model No.	Serial No.
Adapter	Ledlenser GmbH & Co.KG	GQ72-300166-E3	/

Shenzhen Anbotek Compliance Laboratory Limited

Address: 1/F., Building D, Sogood Science and Technology Park, Sanwei Community, Hangcheng Street, Bao'an District, Shenzhen, Guangdong, China.
Tel: (86)0755-26066440 Fax: (86)0755-26014772 Email: service@anbotek.com



Hotline
400-003-0500
www.anbotek.com.cn



1.4. Operation channel list

Channel	Frequency (MHz)	Channel	Frequency (MHz)	Channel	Frequency (MHz)	Channel	Frequency (MHz)
0	2402	10	2422	20	2442	30	2462
1	2404	11	2424	21	2444	31	2464
2	2406	12	2426	22	2446	32	2466
3	2408	13	2428	23	2448	33	2468
4	2410	14	2430	24	2450	34	2470
5	2412	15	2432	25	2452	35	2472
6	2414	16	2434	26	2454	36	2474
7	2416	17	2436	27	2456	37	2476
8	2418	18	2438	28	2458	38	2478
9	2420	19	2440	29	2460	39	2480

1.5. Description of Test Modes

Pretest Modes	Descriptions
TM1	Keep the EUT connect to AC power line and works in continuously transmitting mode with GFSK modulation.

1.6. Measurement Uncertainty

Parameter	Uncertainty
Conducted emissions (AMN 150kHz~30MHz)	3.4dB
Occupied Bandwidth	925Hz
Conducted Output Power	0.76dB
Conducted Spurious Emission	1.24dB
Radiated spurious emissions (above 1GHz)	1G-6GHz: 4.78dB; 6G-18GHz: 4.88dB 18G-40GHz: 5.68dB
Radiated emissions (Below 30MHz)	3.53dB
Radiated spurious emissions (30MHz~1GHz)	Horizontal: 3.92dB; Vertical: 4.52dB
The measurement uncertainty and decision risk evaluated according to AB/WI-RF-F-032. This uncertainty represents an expanded uncertainty expressed at approximately the 95% confidence level using a coverage factor of k=2.	

Shenzhen Anbotek Compliance Laboratory Limited

Address: 1/F., Building D, Sogood Science and Technology Park, Sanwei Community, Hangcheng Street, Bao'an District, Shenzhen, Guangdong, China.
Tel: (86)0755-26066440 Fax: (86)0755-26014772 Email: service@anbotek.com



Hotline
400-003-0500
www.anbotek.com.cn



1.7. Test Summary

Test Items	Test Modes	Status
Antenna requirement	/	P
Conducted Emission at AC power line	Mode1	P
Occupied Bandwidth	Mode1	P
Maximum Conducted Output Power	Mode1	P
Power Spectral Density	Mode1	P
Emissions in non-restricted frequency bands	Mode1	P
Band edge emissions (Radiated)	Mode1	P
Emissions in frequency bands (below 1GHz)	Mode1	P
Emissions in frequency bands (above 1GHz)	Mode1	P
Note: P: Pass N: N/A, not applicable		

Shenzhen Anbotek Compliance Laboratory Limited

Address: 1/F., Building D, Sogood Science and Technology Park, Sanwei Community, Hangcheng Street, Bao'an District, Shenzhen, Guangdong, China.
 Tel: (86)0755-26066440 Fax: (86)0755-26014772 Email: service@anbotek.com



Hotline
 400-003-0500
www.anbotek.com.cn



1.8. Description of Test Facility

The test facility is recognized, certified, or accredited by the following organizations:

FCC-Registration No.:184111

Shenzhen Anbotek Compliance Laboratory Limited, EMC Laboratory has been registered and fully described in a report filed with the (FCC) Federal Communications Commission. The acceptance letter from the FCC is maintained in our files. Registration No. 184111.

ISED-Registration No.: 8058A

Shenzhen Anbotek Compliance Laboratory Limited, EMC Laboratory has been registered and fully described in a report filed with the (ISED) Innovation, Science and Economic Development Canada. The acceptance letter from the ISED is maintained in our files. Registration 8058A.

Test Location

Shenzhen Anbotek Compliance Laboratory Limited.

1/F, Building D, Sogood Science and Technology Park, Sanwei community, Hangcheng Street, Bao'an District, Shenzhen, Guangdong, China.518128

1.9. Disclaimer

1. The test report is invalid if not marked with the signatures of the persons responsible for preparing and approving the test report.
2. The test report is invalid if there is any evidence and/or falsification.
3. The results documented in this report apply only to the tested sample, under the conditions and modes of operation as described herein.
4. This document may not be altered or revised in any way unless done so by Anbotek and all revisions are duly noted in the revisions section.
5. Content of the test report, in part or in full, cannot be used for publicity and/or promotional purposes without prior written approval from the laboratory.
6. The authenticity of the information provided by the customer is the responsibility of the customer and the laboratory is not responsible for its authenticity.

The laboratory is only responsible for the data released by the laboratory, except for the part provided by the applicant.

Shenzhen Anbotek Compliance Laboratory Limited

Address:1/F.,Building D,Sogood Science and Technology Park, Sanwei Community,
Hangcheng Street, Bao'an District, Shenzhen, Guangdong, China.
Tel:(86)0755-26066440 Fax:(86)0755-26014772 Email:service@anbotek.com



Hotline
400-003-0500
www.anbotek.com.cn



1.10. Test Equipment List

Conducted Emission at AC power line						
Item	Equipment	Manufacturer	Model No.	Serial No.	Last Cal.	Cal.Due Date
1	L.I.S.N. Artificial Mains Network	Rohde & Schwarz	ENV216	100055	2022-10-23	2023-10-22
2	Three Phase V-type Artificial Power Network	CYBERTEK	EM5040DT	E215040D T001	2023-07-05	2024-07-04
3	EMI Test Receiver	Rohde & Schwarz	ESCI	100627	2022-10-13	2023-10-12
4	Software Name EZ-EMC	Farad Technology	ANB-03A	N/A	/	/

Occupied Bandwidth Maximum Conducted Output Power Power Spectral Density Emissions in non-restricted frequency bands						
Item	Equipment	Manufacturer	Model No.	Serial No.	Last Cal.	Cal.Due Date
1	MXG RF Vector Signal Generator	Agilent	N5182A	MY481806 56	2022-10-13	2023-10-12
2	Power Meter	Agilent	N1914A	MY500011 02	2022-10-26	2023-10-25
3	DC Power Supply	IVYTECH	IV3605	1804D360 510	2022-10-22	2023-10-21
4	MXA Spectrum Analysis	KEYSIGHT	N9020A	MY505318 23	2023-02-23	2024-02-22
5	Oscilloscope	Tektronix	MDO3012	C020298	2022-10-19	2023-10-18

Band edge emissions (Radiated) Emissions in frequency bands (above 1GHz)						
Item	Equipment	Manufacturer	Model No.	Serial No.	Last Cal.	Cal.Due Date
1	EMI Test Receiver	Rohde & Schwarz	ESR26	101481	2022-10-23	2023-10-22
2	EMI Preamplifier	SKET Electronic	LNPA-0118G-45	SKET-PA-002	2022-10-13	2023-10-12
3	Double Ridged Horn Antenna	SCHWARZBECK	BBHA 9120D	02555	2022-10-16	2025-10-15
4	EMI Test Software EZ-EMC	SHURPLE	N/A	N/A	/	/
5	Horn Antenna	A-INFO	LB-180400-KF	J21106062 8	2022-10-23	2023-10-22
6	Spectrum Analyzer	Rohde & Schwarz	FSV40-N	101792	2023-05-26	2024-05-25
7	Amplifier	Talent Microwave	TLLA18G40 G-50-30	23022802	2023-05-25	2024-05-24

Shenzhen Anbotek Compliance Laboratory Limited

Address: 1/F., Building D, Sogood Science and Technology Park, Sanwei Community, Hangcheng Street, Bao'an District, Shenzhen, Guangdong, China.
Tel: (86)0755-26066440 Fax: (86)0755-26014772 Email: service@anbotek.com



Hotline
400-003-0500
www.anbotek.com.cn



Emissions in frequency bands (below 1GHz)						
Item	Equipment	Manufacturer	Model No.	Serial No.	Last Cal.	Cal.Due Date
1	EMI Test Receiver	Rohde & Schwarz	ESR26	101481	2022-10-23	2023-10-22
2	Pre-amplifier	SONOMA	310N	186860	2022-10-23	2023-10-22
3	Bilog Broadband Antenna	Schwarzbeck	VULB9163	345	2022-10-23	2025-10-22
4	EMI Test Software EZ-EMC	SHURPLE	N/A	N/A	/	/

Shenzhen Anbotek Compliance Laboratory Limited

Address: 1/F., Building D, Sogood Science and Technology Park, Sanwei Community, Hangcheng Street, Bao'an District, Shenzhen, Guangdong, China.
Tel: (86)0755-26066440 Fax: (86)0755-26014772 Email: service@anbotek.com



Hotline
400-003-0500
www.anbotek.com.cn



2. Antenna requirement

Test Requirement:

Refer to 47 CFR Part 15.203, an intentional radiator shall be designed to ensure that no antenna other than that furnished by the responsible party shall be used with the device. The use of a permanently attached antenna or of an antenna that uses a unique coupling to the intentional radiator shall be considered sufficient to comply with the provisions of this section.

2.1. Conclusion

The antenna is a Ceramics Antenna which permanently attached, and the best case gain of the antenna is **2.7 dBi** . It complies with the standard requirement.



3. Conducted Emission at AC power line

Test Requirement:	Refer to 47 CFR 15.207(a), Except as shown in paragraphs (b) and (c) of this section, for an intentional radiator that is designed to be connected to the public utility (AC) power line, the radio frequency voltage that is conducted back onto the AC power line on any frequency or frequencies, within the band 150 kHz to 30 MHz, shall not exceed the limits in the following table, as measured using a 50 μ H/50 ohms line impedance stabilization network (LISN).		
Test Limit:	Frequency of emission (MHz)	Conducted limit (dB μ V)	
		Quasi-peak	Average
	0.15-0.5	66 to 56*	56 to 46*
	0.5-5	56	46
	5-30	60	50
	*Decreases with the logarithm of the frequency.		
Test Method:	ANSI C63.10-2020 section 6.2		
Procedure:	Refer to ANSI C63.10-2020 section 6.2, standard test method for ac power-line conducted emissions from unlicensed wireless devices		

3.1. EUT Operation

Operating Environment:	
Test mode:	1: TX mode: Keep the EUT connect to AC power line and works in continuously transmitting mode with GFSK modulation.

3.2. Test Setup

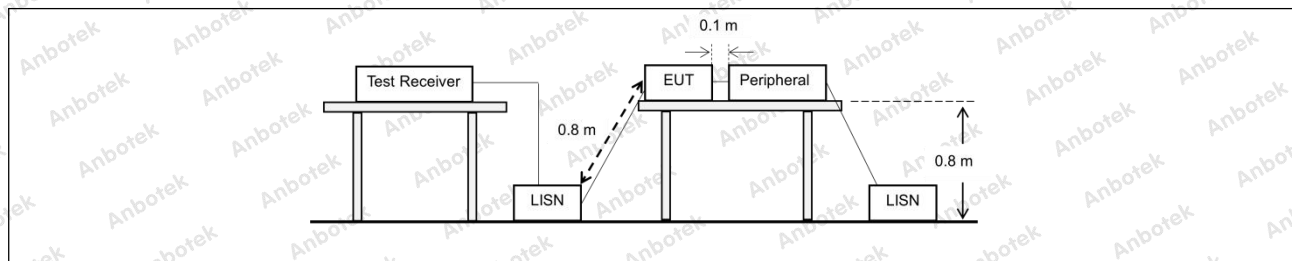

3.3. Test Data

Temperature:	24.1 °C	Humidity:	51.2 %	Atmospheric Pressure:	96 kPa
--------------	---------	-----------	--------	-----------------------	--------

TM1 / Line: Line / Band: 2400-2483.5 MHz / BW: 1 / CH: L

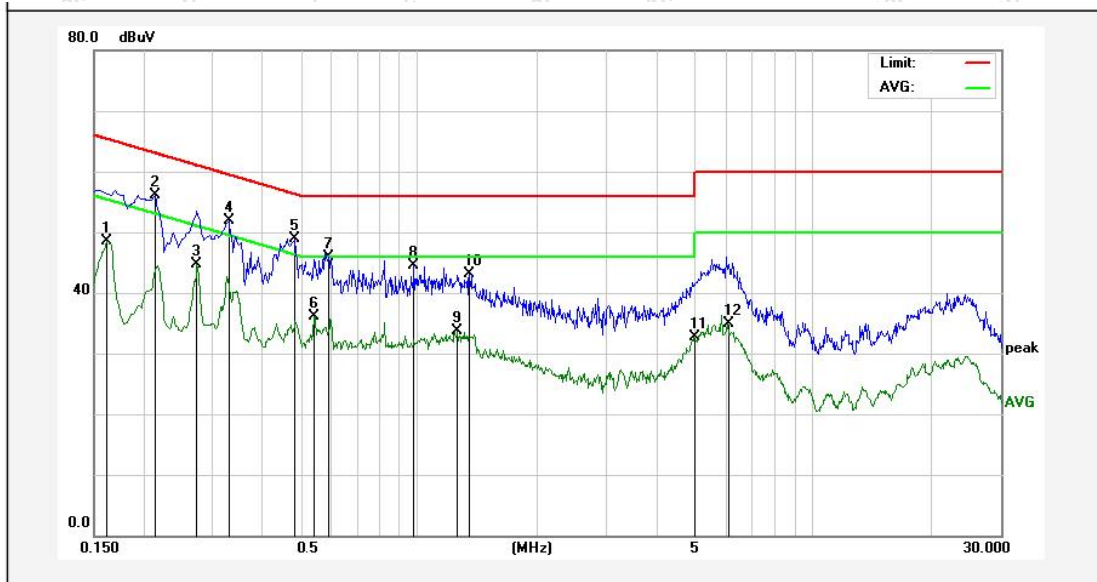

No.	Freq. (MHz)	Reading (dBuV)	Factor (dB)	Result (dBuV)	Limit (dBuV)	Over Limit (dB)	Detector	Remark
1	0.1620	28.73	19.83	48.56	55.36	-6.80	AVG	
2	0.2140	36.21	19.82	56.03	63.04	-7.01	QP	
3	0.2740	24.83	19.84	44.67	50.99	-6.32	AVG	
4	0.3300	32.08	19.83	51.91	59.45	-7.54	QP	
5	0.4860	29.00	19.85	48.85	56.24	-7.39	QP	
6	0.5460	16.30	19.86	36.16	46.00	-9.84	AVG	
7	0.5940	26.05	19.86	45.91	56.00	-10.09	QP	
8	0.9740	24.67	19.86	44.53	56.00	-11.47	QP	
9	1.2579	13.78	19.86	33.64	46.00	-12.36	AVG	
10	1.3460	23.27	19.86	43.13	56.00	-12.87	QP	
11	4.9980	12.87	19.86	32.73	46.00	-13.27	AVG	
12	6.0820	15.00	19.88	34.88	50.00	-15.12	AVG	

Shenzhen Anbotek Compliance Laboratory Limited

Address: 1/F., Building D, Sogood Science and Technology Park, Sanwei Community, Hangcheng Street, Bao'an District, Shenzhen, Guangdong, China.
 Tel: (86)0755-26066440 Fax: (86)0755-26014772 Email: service@anbotek.com

Hotline: 400-003-0500
 www.anbotek.com.cn



Temperature:	24.1 °C	Humidity:	51.2 %	Atmospheric Pressure:	96 kPa
--------------	---------	-----------	--------	-----------------------	--------

TM1 / Line: Neutral / Band: 2400-2483.5 MHz / BW: 1 / CH: L

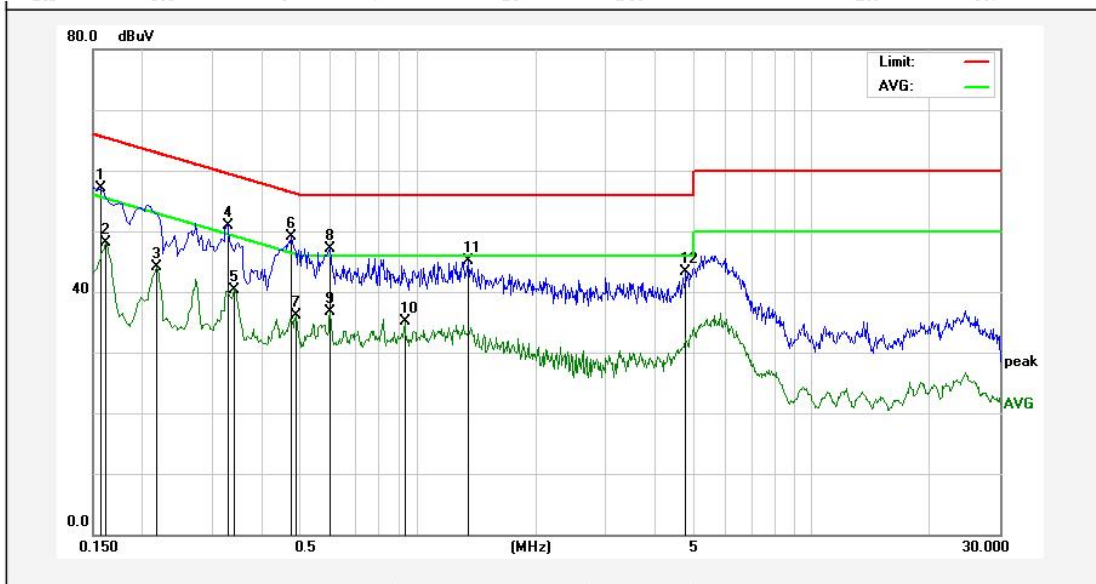

No.	Freq. (MHz)	Reading (dBuV)	Factor (dB)	Result (dBuV)	Limit (dBuV)	Over Limit (dB)	Detector	Remark
1	0.1580	37.19	19.83	57.02	65.56	-8.54	QP	
2	0.1620	28.27	19.83	48.10	55.36	-7.26	AVG	
3	0.2180	24.32	19.82	44.14	52.89	-8.75	AVG	
4	0.3300	31.16	19.83	50.99	59.45	-8.46	QP	
5	0.3420	20.57	19.83	40.40	49.15	-8.75	AVG	
6	0.4780	29.29	19.85	49.14	56.37	-7.23	QP	
7	0.4900	16.23	19.86	36.09	46.17	-10.08	AVG	
8	0.6020	27.24	19.87	47.11	56.00	-8.89	QP	
9	0.6020	16.84	19.87	36.71	46.00	-9.29	AVG	
10	0.9300	15.25	19.86	35.11	46.00	-10.89	AVG	
11	1.3500	25.30	19.86	45.16	56.00	-10.84	QP	
12	4.7940	23.50	19.86	43.36	56.00	-12.64	QP	

Shenzhen Anbotek Compliance Laboratory Limited

Address: 1/F., Building D, Sogood Science and Technology Park, Sanwei Community, Hangcheng Street, Bao'an District, Shenzhen, Guangdong, China.
 Tel: (86)0755-26066440 Fax: (86)0755-26014772 Email: service@anbotek.com

Hotline 400-003-0500
 www.anbotek.com.cn



4. Occupied Bandwidth

Test Requirement:	47 CFR 15.247(a)(2)
Test Limit:	Refer to 47 CFR 15.247(a)(2), Systems using digital modulation techniques may operate in the 902-928 MHz, and 2400-2483.5 MHz bands. The minimum 6 dB bandwidth shall be at least 500 kHz.
Test Method:	ANSI C63.10-2020, section 11.8 KDB 558074 D01 15.247 Meas Guidance v05r02
Procedure:	<p>11.8.1 Option 1</p> <p>The steps for the first option are as follows:</p> <ul style="list-style-type: none"> a) Set RBW = shall be in the range of 1% to 5% of the OBW but not less than 100 kHz. b) Set the VBW $\geq [3 \times \text{RBW}]$. c) Detector = peak. d) Trace mode = max-hold. e) Sweep = No faster than coupled (auto) time. f) Allow the trace to stabilize. g) Measure the maximum width of the emission by placing two markers, one at the lowest frequency and the other at the highest frequency of the envelope of the spectral display, such that each marker is at or slightly below the “-6 dB down amplitude”. If a marker is below this “-6 dB down amplitude” value, then it shall be as close as possible to this value. <p>11.8.2 Option 2</p> <p>The automatic bandwidth measurement capability of an instrument may be employed using the X dB bandwidth mode with X set to 6 dB, if the functionality described in 11.8.1 (i.e., RBW = 100 kHz, VBW $\geq 3 \times \text{RBW}$, and peak detector with maximum hold) is implemented by the instrumentation function.</p> <p>When using this capability, care shall be taken so that the bandwidth measurement is not influenced by any intermediate power nulls in the fundamental emission that might be ≥ 6 dB.</p>

4.1. EUT Operation

Operating Environment:	
Test mode:	1: TX mode: Keep the EUT connect to AC power line and works in continuously transmitting mode with GFSK modulation.

4.2. Test Setup

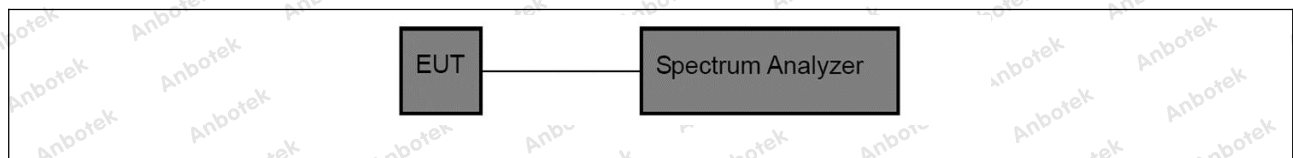

4.3. Test Data

Temperature:	25.3 °C	Humidity:	48 %	Atmospheric Pressure:	102 kPa
--------------	---------	-----------	------	-----------------------	---------



Please Refer to Appendix for Details.

Shenzhen Anbotek Compliance Laboratory Limited

Address: 1/F., Building D, Sogood Science and Technology Park, Sanwei Community, Hangcheng Street, Bao'an District, Shenzhen, Guangdong, China.
Tel: (86)0755-26066440 Fax: (86)0755-26014772 Email: service@anbotek.com



Hotline
400-003-0500
www.anbotek.com.cn



5. Maximum Conducted Output Power

Test Requirement:	47 CFR 15.247(b)(3)
Test Limit:	Refer to 47 CFR 15.247(b)(3), For systems using digital modulation in the 902-928 MHz, 2400-2483.5 MHz, and 5725-5850 MHz bands: 1 Watt. As an alternative to a peak power measurement, compliance with the one Watt limit can be based on a measurement of the maximum conducted output power. Maximum Conducted Output Power is defined as the total transmit power delivered to all antennas and antenna elements averaged across all symbols in the signaling alphabet when the transmitter is operating at its maximum power control level. Power must be summed across all antennas and antenna elements. The average must not include any time intervals during which the transmitter is off or is transmitting at a reduced power level. If multiple modes of operation are possible (e.g., alternative modulation methods), the maximum conducted output power is the highest total transmit power occurring in any mode.
Test Method:	ANSI C63.10-2020 section 11.9.1 KDB 558074 D01 15.247 Meas Guidance v05r02
Procedure:	ANSI C63.10-2020, section 11.9.1 Maximum peak conducted output power

5.1. EUT Operation

Operating Environment:	
Test mode:	1: TX mode: Keep the EUT connect to AC power line and works in continuously transmitting mode with GFSK modulation.

5.2. Test Setup

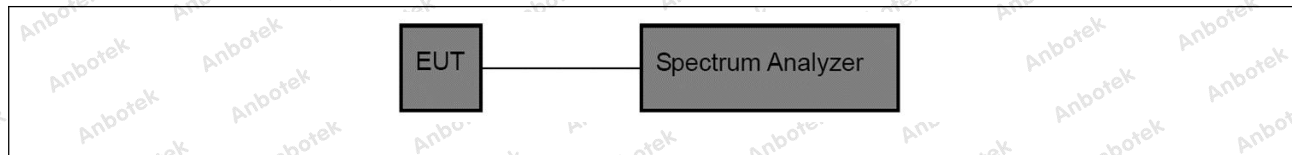

5.3. Test Data

Temperature:	25.3 °C	Humidity:	48 %	Atmospheric Pressure:	102 kPa
--------------	---------	-----------	------	-----------------------	---------

Please Refer to Appendix for Details.



6. Power Spectral Density

Test Requirement:	47 CFR 15.247(e)
Test Limit:	Refer to 47 CFR 15.247(e), For digitally modulated systems, the power spectral density conducted from the intentional radiator to the antenna shall not be greater than 8 dBm in any 3 kHz band during any time interval of continuous transmission. This power spectral density shall be determined in accordance with the provisions of paragraph (b) of this section. The same method of determining the conducted output power shall be used to determine the power spectral density.
Test Method:	ANSI C63.10-2020, section 11.10 KDB 558074 D01 15.247 Meas Guidance v05r02
Procedure:	ANSI C63.10-2020, section 11.10, Maximum power spectral density level in the fundamental emission

6.1. EUT Operation

Operating Environment:	
Test mode:	1: TX mode: Keep the EUT connect to AC power line and works in continuously transmitting mode with GFSK modulation.

6.2. Test Setup

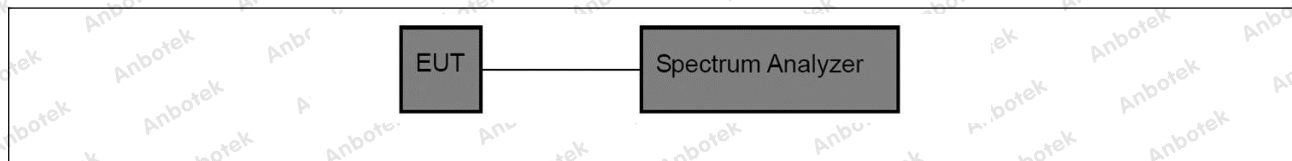

6.3. Test Data

Temperature:	25.3 °C	Humidity:	48 %	Atmospheric Pressure:	102 kPa
--------------	---------	-----------	------	-----------------------	---------

Please Refer to Appendix for Details.



7. Emissions in non-restricted frequency bands

Test Requirement:	47 CFR 15.247(d), 15.209, 15.205
Test Limit:	Refer to 47 CFR 15.247(d), In any 100 kHz bandwidth outside the frequency band in which the spread spectrum or digitally modulated intentional radiator is operating, the radio frequency power that is produced by the intentional radiator shall be at least 20 dB below that in the 100 kHz bandwidth within the band that contains the highest level of the desired power, based on either an RF conducted or a radiated measurement, provided the transmitter demonstrates compliance with the peak conducted power limits. If the transmitter complies with the conducted power limits based on the use of RMS averaging over a time interval, as permitted under paragraph (b)(3) of this section, the attenuation required under this paragraph shall be 30 dB instead of 20 dB. Attenuation below the general limits specified in § 15.209(a) is not required.
Test Method:	ANSI C63.10-2020 section 11.11 KDB 558074 D01 15.247 Meas Guidance v05r02
Procedure:	ANSI C63.10-2020 Section 11.11.1, Section 11.11.2, Section 11.11.3

7.1. EUT Operation

Operating Environment:	
Test mode:	1: TX mode: Keep the EUT connect to AC power line and works in continuously transmitting mode with GFSK modulation.

7.2. Test Setup

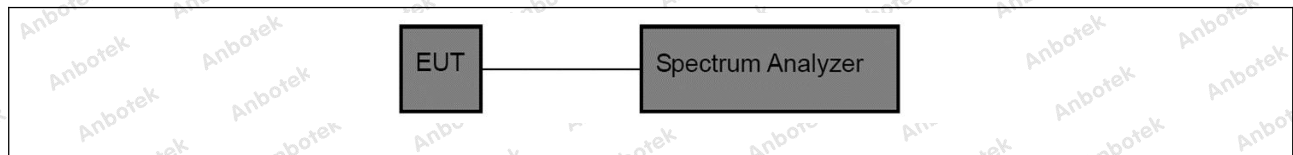

7.3. Test Data

Temperature:	25.3 °C	Humidity:	48 %	Atmospheric Pressure:	102 kPa
--------------	---------	-----------	------	-----------------------	---------

Please Refer to Appendix for Details.



8. Band edge emissions (Radiated)

Test Requirement:	Refer to 47 CFR 15.247(d), In addition, radiated emissions which fall in the restricted bands, as defined in § 15.205(a), must also comply with the radiated emission limits specified in § 15.209(a)(see § 15.205(c)).		
Test Limit:	Frequency (MHz)	Field strength (microvolts/meter)	Measurement distance (meters)
	0.009-0.490	2400/F(kHz)	300
	0.490-1.705	24000/F(kHz)	30
	1.705-30.0	30	30
	30-88	100 **	3
	88-216	150 **	3
	216-960	200 **	3
	Above 960	500	3
	** Except as provided in paragraph (g), fundamental emissions from intentional radiators operating under this section shall not be located in the frequency bands 54-72 MHz, 76-88 MHz, 174-216 MHz or 470-806 MHz. However, operation within these frequency bands is permitted under other sections of this part, e.g., §§ 15.231 and 15.241.		
Test Method:	ANSI C63.10-2020 section 6.10 KDB 558074 D01 15.247 Meas Guidance v05r02		
Procedure:	ANSI C63.10-2020 section 6.10.5.2		

8.1. EUT Operation

Operating Environment:	
Test mode:	1: TX mode: Keep the EUT connect to AC power line and works in continuously transmitting mode with GFSK modulation.

8.2. Test Setup

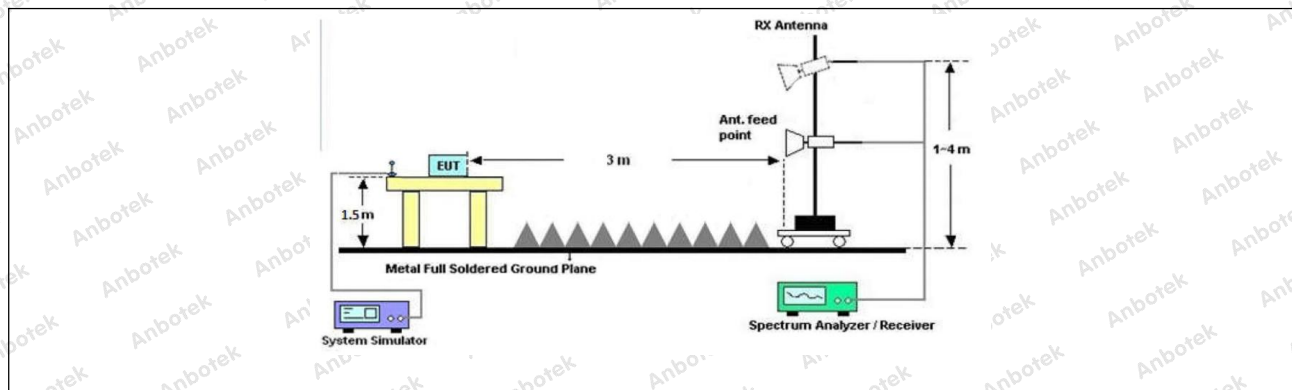

8.3. Test Data

Temperature:	25.3 °C	Humidity:	48 %	Atmospheric Pressure:	102 kPa
--------------	---------	-----------	------	-----------------------	---------

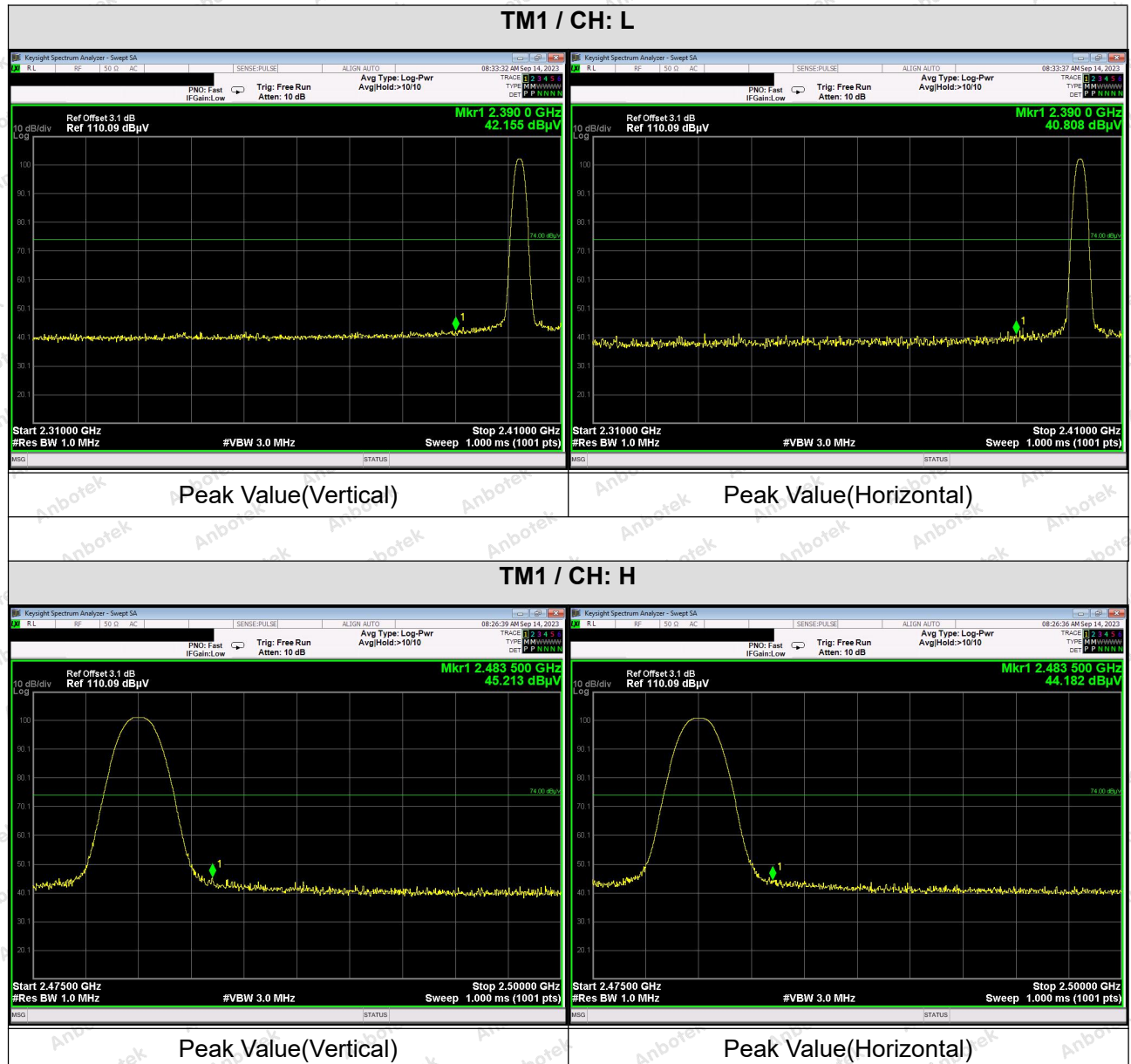

Shenzhen Anbotek Compliance Laboratory Limited

Address: 1/F., Building D, Sogood Science and Technology Park, Sanwei Community, Hangcheng Street, Bao'an District, Shenzhen, Guangdong, China.
 Tel: (86)0755-26066440 Fax: (86)0755-26014772 Email: service@anbotek.com

Hotline
 400-003-0500
www.anbotek.com.cn



Average:

Test Mode	Peak Value (dBuV/m)	DCCF	Average Value (dBuV/m)	Limit (dBuV/m)	Polarization	Verdict
TM1 / CH: L	42.155	-3.95	38.209	54.00	Vertical	Pass
	40.808	-3.95	36.862	54.00	Horizontal	Pass
TM1 / CH: H	45.213	-3.95	41.267	54.00	Vertical	Pass
	44.182	-3.95	40.236	54.00	Horizontal	Pass

Remark:

1. During the test, pre-scan all modes, the report only record the worse case mode.

1. $DCCF=20\log(\text{Duty Cycle})$

2. $\text{Average Value}=\text{Peak Value}+DCCF$



9. Emissions in frequency bands (below 1GHz)

Test Requirement:	Refer to 47 CFR 15.247(d), In addition, radiated emissions which fall in the restricted bands, as defined in § 15.205(a), must also comply with the radiated emission limits specified in § 15.209(a)(see § 15.205(c)).`		
Test Limit:	Frequency (MHz)	Field strength (microvolts/meter)	Measurement distance (meters)
	0.009-0.490	2400/F(kHz)	300
	0.490-1.705	24000/F(kHz)	30
	1.705-30.0	30	30
	30-88	100 **	3
	88-216	150 **	3
	216-960	200 **	3
	Above 960	500	3
** Except as provided in paragraph (g), fundamental emissions from intentional radiators operating under this section shall not be located in the frequency bands 54-72 MHz, 76-88 MHz, 174-216 MHz or 470-806 MHz. However, operation within these frequency bands is permitted under other sections of this part, e.g., §§ 15.231 and 15.241.			
Test Method:	ANSI C63.10-2020 section 6.6.4 KDB 558074 D01 15.247 Meas Guidance v05r02		
Procedure:	ANSI C63.10-2020 section 6.6.4		

9.1. EUT Operation

Operating Environment:	
Test mode:	1: TX mode: Keep the EUT connect to AC power line and works in continuously transmitting mode with GFSK modulation.



9.2. Test Setup

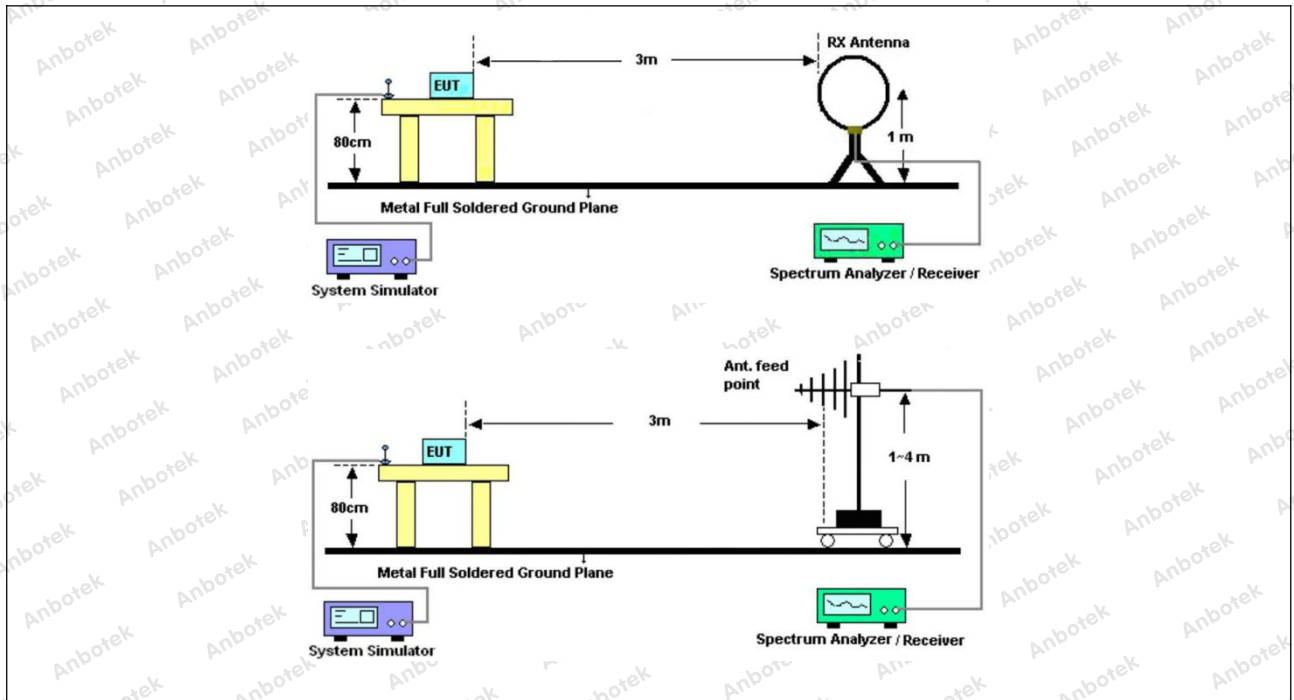

9.3. Test Data

Temperature:	23.3 °C	Humidity:	54.5 %	Atmospheric Pressure:	102 kPa
--------------	---------	-----------	--------	-----------------------	---------

TM1 / Polarization: Horizontal / Band: 2400-2483.5 MHz / BW: 1 / CH: L

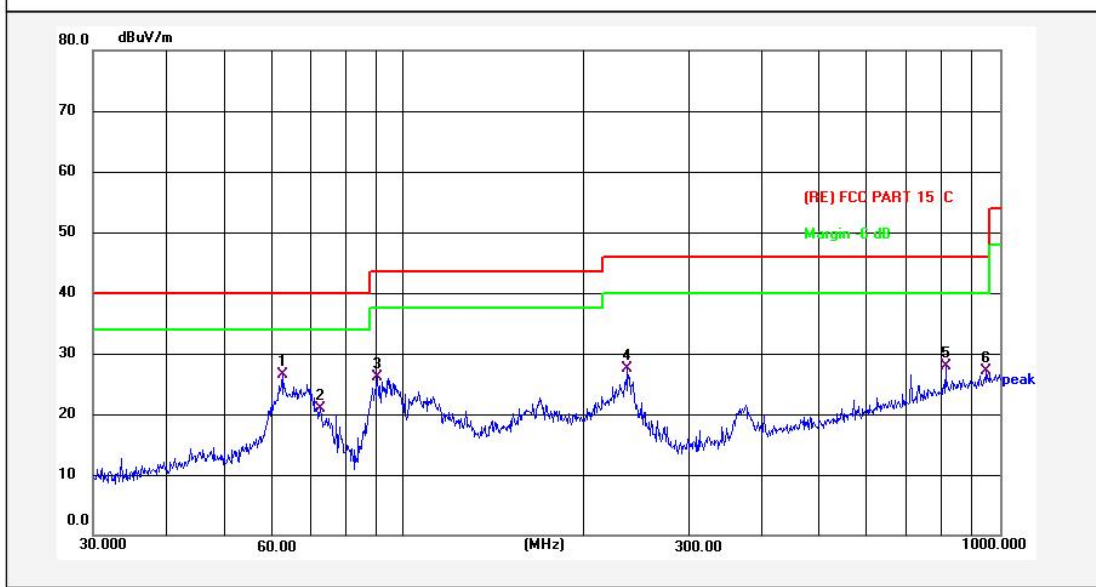

No.	Freq. (MHz)	Reading (dBuV)	Factor (dB/m)	Result (dBuV/m)	Limit (dBuV/m)	Over Limit (dB)	Detector	Height (cm)	degree (deg)	Remark
1	62.3493	49.63	-23.14	26.49	40.00	-13.51	QP			
2	72.4010	46.24	-25.24	21.00	40.00	-19.00	QP			
3	90.3788	49.85	-23.77	26.08	43.50	-17.42	QP			
4	236.8523	48.88	-21.39	27.49	46.00	-18.51	QP			
5	812.7553	37.89	-10.00	27.89	46.00	-18.11	QP			
6	951.2594	35.41	-8.39	27.02	46.00	-18.98	QP			

Shenzhen Anbotek Compliance Laboratory Limited

Address: 1/F., Building D, Sogood Science and Technology Park, Sanwei Community, Hangcheng Street, Bao'an District, Shenzhen, Guangdong, China.
 Tel: (86)0755-26066440 Fax: (86)0755-26014772 Email: service@anbotek.com



Hotline
 400-003-0500
 www.anbotek.com.cn



Temperature:	23.3 °C	Humidity:	54.5 %	Atmospheric Pressure:	102 kPa
--------------	---------	-----------	--------	-----------------------	---------

TM1 / Polarization: Vertical / Band: 2400-2483.5 MHz / BW: 1 / CH: L

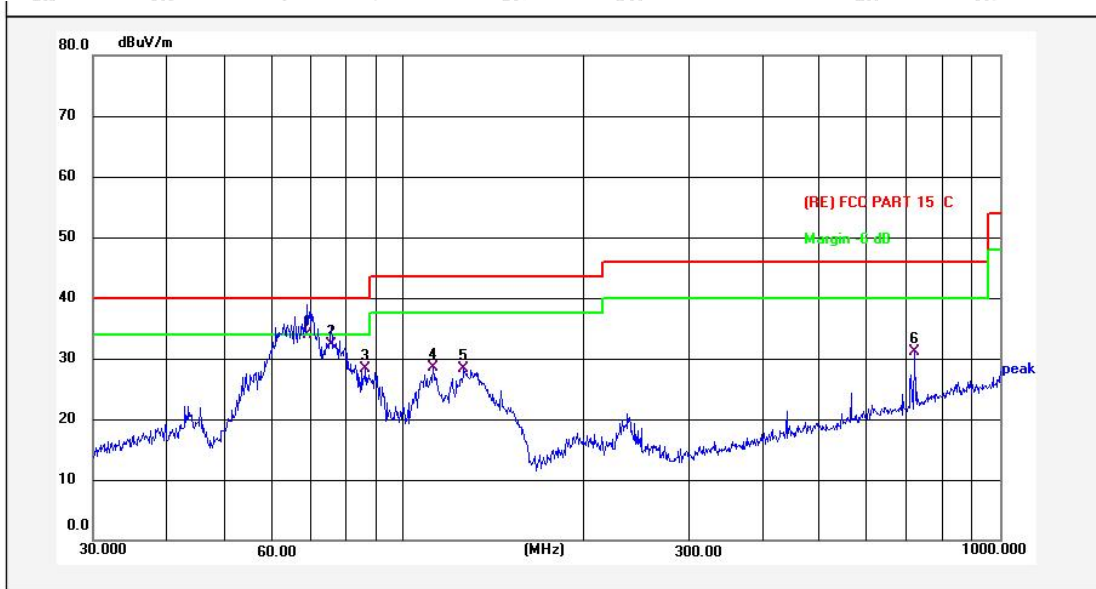

No.	Freq. (MHz)	Reading (dBUV)	Factor (dB/m)	Result (dBUV/m)	Limit (dBUV/m)	Over Limit (dB)	Detector	Height (cm)	degree (deg)	Remark
1	69.0838	58.65	-24.68	33.97	40.00	-6.03	QP			
2	75.5456	58.02	-25.70	32.32	40.00	-7.68	QP			
3	86.2001	53.14	-24.79	28.35	40.00	-11.65	QP			
4	111.8360	50.73	-22.26	28.47	43.50	-15.03	QP			
5	126.3286	52.65	-24.44	28.21	43.50	-15.29	QP			
6	719.5148	42.84	-11.78	31.06	46.00	-14.94	QP			

Shenzhen Anbotek Compliance Laboratory Limited

Address: 1/F., Building D, Sogood Science and Technology Park, Sanwei Community, Hangcheng Street, Bao'an District, Shenzhen, Guangdong, China.
 Tel: (86)0755-26066440 Fax: (86)0755-26014772 Email: service@anbotek.com



Hotline
 400-003-0500
 www.anbotek.com.cn



10. Emissions in frequency bands (above 1GHz)

Test Requirement:	In addition, radiated emissions which fall in the restricted bands, as defined in § 15.205(a), must also comply with the radiated emission limits specified in § 15.209(a)(see § 15.205(c)).		
Test Limit:	Frequency (MHz)	Field strength (microvolts/meter)	Measurement distance (meters)
	0.009-0.490	2400/F(kHz)	300
	0.490-1.705	24000/F(kHz)	30
	1.705-30.0	30	30
	30-88	100 **	3
	88-216	150 **	3
	216-960	200 **	3
	Above 960	500	3
	** Except as provided in paragraph (g), fundamental emissions from intentional radiators operating under this section shall not be located in the frequency bands 54-72 MHz, 76-88 MHz, 174-216 MHz or 470-806 MHz. However, operation within these frequency bands is permitted under other sections of this part, e.g., §§ 15.231 and 15.241.		
Test Method:	ANSI C63.10-2020 section 6.6.4 KDB 558074 D01 15.247 Meas Guidance v05r02		
Procedure:	ANSI C63.10-2020 section 6.6.4		

10.1. EUT Operation

Operating Environment:	
Test mode:	1: TX mode: Keep the EUT connect to AC power line and works in continuously transmitting mode with GFSK modulation.

10.2. Test Setup

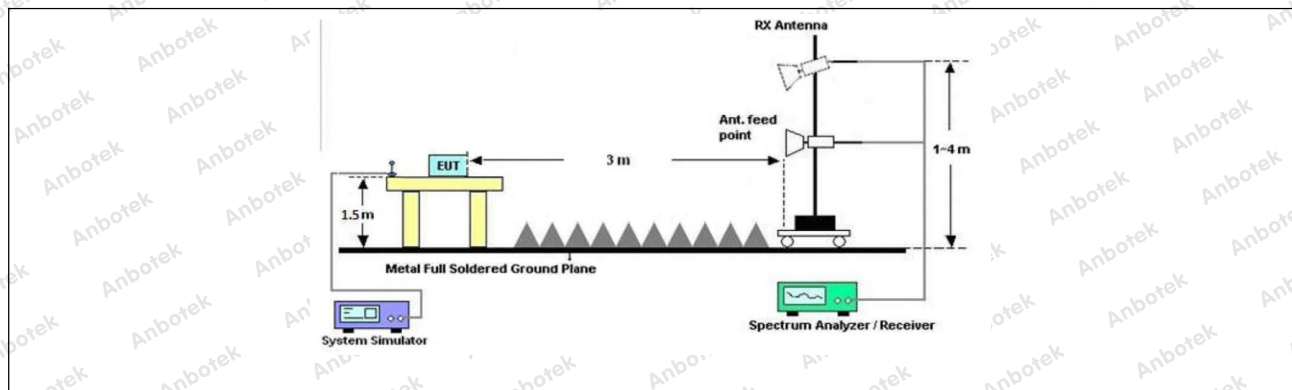

10.3. Test Data

Temperature:	24.2 °C	Humidity:	49.5 %	Atmospheric Pressure:	102 kPa
--------------	---------	-----------	--------	-----------------------	---------

TM1 / CH: L						
Peak value:						
Frequency (MHz)	Reading (dBuV)	Factor (dB/m)	Result (dBuV/m)	Limit Line (dBuV/m)	Over Limit (dB)	polarization
4804.00	27.25	15.27	42.52	74.00	-31.48	Vertical
7206.00	27.52	18.09	45.61	74.00	-28.39	Vertical
9608.00	27.96	23.76	51.72	74.00	-22.28	Vertical
12010.00	*			74.00		Vertical
14412.00	*			74.00		Vertical
4804.00	27.02	15.27	42.29	74.00	-31.71	Horizontal
7206.00	27.60	18.09	45.69	74.00	-28.31	Horizontal
9608.00	27.60	23.76	51.36	74.00	-22.64	Horizontal
12010.00	*			74.00		Horizontal
14412.00	*			74.00		Horizontal
Average value:						
Frequency (MHz)	Reading (dBuV)	Factor (dB/m)	Result (dBuV/m)	Limit (dBuV/m)	Over Limit (dB)	polarization
4804.00	15.52	15.27	30.79	54.00	-23.21	Vertical
7206.00	16.57	18.09	34.66	54.00	-19.34	Vertical
9608.00	17.43	23.76	41.19	54.00	-12.81	Vertical
12010.00	*			54.00		Vertical
14412.00	*			54.00		Vertical
4804.00	15.35	15.27	30.62	54.00	-23.38	Horizontal
7206.00	16.63	18.09	34.72	54.00	-19.28	Horizontal
9608.00	17.11	23.76	40.87	54.00	-13.13	Horizontal
12010.00	*			54.00		Horizontal
14412.00	*			54.00		Horizontal

Shenzhen Anbotek Compliance Laboratory Limited

Address: 1/F., Building D, Sogood Science and Technology Park, Sanwei Community, Hangcheng Street, Bao'an District, Shenzhen, Guangdong, China.
 Tel: (86)0755-26066440 Fax: (86)0755-26014772 Email: service@anbotek.com



Hotline
 400-003-0500
www.anbotek.com.cn



TM1 / CH: M						
Peak value:						
Frequency (MHz)	Reading (dBuV)	Factor (dB/m)	Result (dBuV/m)	Limit Line (dBuV/m)	Over Limit (dB)	polarization
4880.00	26.80	15.42	42.22	74.00	-31.78	Vertical
7320.00	27.49	18.02	45.51	74.00	-28.49	Vertical
9760.00	27.46	23.80	51.26	74.00	-22.74	Vertical
12200.00	*			74.00		Vertical
14640.00	*			74.00		Vertical
4880.00	26.83	15.42	42.25	74.00	-31.75	Horizontal
7320.00	27.47	18.02	45.49	74.00	-28.51	Horizontal
9760.00	27.32	23.80	51.12	74.00	-22.88	Horizontal
12200.00	*			74.00		Horizontal
14640.00	*			74.00		Horizontal
Average value:						
Frequency (MHz)	Reading (dBuV)	Factor (dB/m)	Result (dBuV/m)	Limit (dBuV/m)	Over Limit (dB)	polarization
4880.00	15.61	15.42	31.03	54.00	-22.97	Vertical
7320.00	16.43	18.02	34.45	54.00	-19.55	Vertical
9760.00	17.28	23.80	41.08	54.00	-12.92	Vertical
12200.00	*			54.00		Vertical
14640.00	*			54.00		Vertical
4880.00	15.46	15.42	30.88	54.00	-23.12	Horizontal
7320.00	16.98	18.02	35.00	54.00	-19.00	Horizontal
9760.00	17.41	23.80	41.21	54.00	-12.79	Horizontal
12200.00	*			54.00		Horizontal
14640.00	*			54.00		Horizontal

Shenzhen Anbotek Compliance Laboratory Limited

Address: 1/F., Building D, Sogood Science and Technology Park, Sanwei Community, Hangcheng Street, Bao'an District, Shenzhen, Guangdong, China.
 Tel: (86)0755-26066440 Fax: (86)0755-26014772 Email: service@anbotek.com

Hotline 400-003-0500
 www.anbotek.com.cn



TM1 / CH: H						
Peak value:						
Frequency (MHz)	Reading (dBuV)	Factor (dB/m)	Result (dBuV/m)	Limit Line (dBuV/m)	Over Limit (dB)	polarization
4960.00	26.93	15.58	42.51	74.00	-31.49	Vertical
7440.00	27.65	17.93	45.58	74.00	-28.42	Vertical
9920.00	28.16	23.83	51.99	74.00	-22.01	Vertical
12400.00	*			74.00		Vertical
14880.00	*			74.00		Vertical
4960.00	26.97	15.58	42.55	74.00	-31.45	Horizontal
7440.00	27.68	17.93	45.61	74.00	-28.39	Horizontal
9920.00	27.70	23.83	51.53	74.00	-22.47	Horizontal
12400.00	*			74.00		Horizontal
14880.00	*			74.00		Horizontal
Average value:						
Frequency (MHz)	Reading (dBuV)	Factor (dB/m)	Result (dBuV/m)	Limit (dBuV/m)	Over Limit (dB)	polarization
4960.00	16.73	15.58	32.31	54.00	-21.69	Vertical
7440.00	17.70	17.93	35.63	54.00	-18.37	Vertical
9920.00	17.93	23.83	41.76	54.00	-12.24	Vertical
12400.00	*			54.00		Vertical
14880.00	*			54.00		Vertical
4960.00	16.64	15.58	32.22	54.00	-21.78	Horizontal
7440.00	17.78	17.93	35.71	54.00	-18.29	Horizontal
9920.00	17.56	23.83	41.39	54.00	-12.61	Horizontal
12400.00	*			54.00		Horizontal
14880.00	*			54.00		Horizontal

Remark:

1. Result = Reading + Factor
2. “*” means the test results were attenuated more than 20dB below the permissible limits, so the results don't record in the report.
3. Only the worst case is recorded in the report.

Shenzhen Anbotek Compliance Laboratory Limited

Address: 1/F., Building D, Sogood Science and Technology Park, Sanwei Community, Hangcheng Street, Bao'an District, Shenzhen, Guangdong, China.
 Tel: (86)0755-26066440 Fax: (86)0755-26014772 Email: service@anbotek.com

Hotline 400-003-0500
 www.anbotek.com.cn



APPENDIX I -- TEST SETUP PHOTOGRAPH

Please refer to separated files Appendix I -- Test Setup Photograph_RF

APPENDIX II -- EXTERNAL PHOTOGRAPH

Please refer to separated files Appendix II -- External Photograph

APPENDIX III -- INTERNAL PHOTOGRAPH

Please refer to separated files Appendix III -- Internal Photograph

----- End of Report -----

