

FCC CERTIFICATION TEST REPORT

FOR

Applicant	:	Sublue Underwater AI Co.,Ltd.
Address	:	NO1,QUANZHOU ROAD,ZHONGGUANCUN SCIENCE AND TECH.PARK , BINHAI TIANJIN CHN
Equipment under Test	:	Sublue Smart Waterproof Phone Case
Model No.	:	H1+
Trade Mark	:	N/A
FCC ID	:	2ASEE-CE3001
Manufacturer	:	Sublue Underwater AI Co.,Ltd.
Address	:	NO1,QUANZHOU ROAD,ZHONGGUANCUN SCIENCE AND TECH.PARK , BINHAI TIANJIN CHN

Issued By: Dongguan Dongdian Testing Service Co., Ltd.

Add.: No. 17, Zongbu Road 2, Songshan Lake Sci&Tech, Industry Park,
Dongguan City, Guangdong Province, China, 523808

Tel.: +86-0769-38826678, **E-mail:** ddt@dgddt.com, <http://www.dgddt.com>

Table of Contents

	Test report declares.....	4
1.	Summary of Test Results.....	6
2.	General Test Information	6
2.1.	Description of EUT	6
2.2.	Accessories of EUT	7
2.3.	Assistant equipment used for test.....	7
2.4.	Block diagram of EUT configuration for test.....	7
2.5.	Test environment conditions.....	8
2.6.	Deviations of test standard	8
2.7.	Test laboratory	8
2.8.	Measurement uncertainty	8
3.	Equipment Used During Test.....	10
4.	6 dB Bandwidth and 99% Bandwidth	12
4.1.	Block diagram of test setup	12
4.2.	Limits	12
4.3.	Test procedure	12
4.4.	Test result.....	13
4.5.	Original test data	13
5.	Maximum Peak Output Power	20
5.1.	Block diagram of test setup	20
5.2.	Limits	20
5.3.	Test procedure	20
5.4.	Test result.....	20
5.5.	Original test data	21
6.	Power Spectral Density.....	24
6.1.	Block diagram of test setup	24
6.2.	Limits	24
6.3.	Test procedure	24
6.4.	Test result.....	24
6.5.	Original test data	25
7.	Band Edge Compliance (Conducted Method).....	28
7.1.	Block diagram of test setup	28
7.2.	Limits	28
7.3.	Test procedure	28
7.4.	Test result.....	29
7.5.	Original test data	29

8.	Radiated Emission	34
8.1.	Block diagram of test setup	34
8.2.	Limit	35
8.3.	Test Procedure	36
8.4.	Test result	38
9.	RF Conducted Spurious Emissions	42
9.1.	Block diagram of test setup	42
9.2.	Limits	42
9.3.	Test procedure	42
9.4.	Test result	43
9.5.	Original test data	43
10.	Emissions in Restricted Frequency Bands	50
10.1.	Block diagram of test setup	50
10.2.	Limit	50
10.3.	Test Procedure	50
10.4.	Test result	50
11.	Power Line Conducted Emission	59
11.1.	Block diagram of test setup	59
11.2.	Power line conducted emission limits	59
11.3.	Test procedure	59
11.4.	Test result	60
12.	Antenna Requirements	63
12.1.	Limit	63
12.2.	Result	63
13.	Test Setup Photograph	64
14.	Photos of the EUT	66

Test Report Declare

Applicant	:	Sublue Underwater AI Co.,Ltd.
Address	:	NO1,QUANZHOU ROAD,ZHONGGUANCUN SCIENCE AND TECH.PARK , BINHAI TIANJIN CHN
Equipment under Test	:	Sublue Smart Waterproof Phone Case
Model No.	:	H1+
Trade Mark	:	N/A
Manufacturer	:	Sublue Underwater AI Co.,Ltd.
Address	:	NO1,QUANZHOU ROAD,ZHONGGUANCUN SCIENCE AND TECH.PARK , BINHAI TIANJIN CHN

Test Standard Used:

FCC Rules and Regulations Part 15 Subpart C

Test Procedure Used:

ANSI C63.10:2013

We Declare:

The equipment described above is tested by Dongguan Dongdian Testing Service Co., Ltd. and in the configuration tested the equipment complied with the standards specified above. The test results are contained in this test report and Dongguan Dongdian Testing Service Co., Ltd. is assumed of full responsibility for the accuracy and completeness of these tests.

After test and evaluation, our opinion is that the equipment provided for test compliance with the requirement of the above FCC standards.

Report No:	DDT-R21032523-1E6		
Date of Receipt:	Mar. 25, 2021	Date of Test:	Mar. 25, 2021 ~ Apr. 12, 2021

Prepared By:

Sam Li

Sam Li/Engineer

Approved By:

Damon Hu

Damon Hu/EMC Manager



Note: This report applies to above tested sample only. This report shall not be reproduced in parts without written approval of Dongguan Dongdian Testing Service Co., Ltd.

Revision History

Rev.	Revisions	Issue Date	Revised By
---	Initial issue	Apr. 12, 2021	

1. Summary of Test Results

The EUT have been tested according to the applicable standards as referenced below.		
Description of Test Item	Standard	Verdict
6 dB Bandwidth and 99% Bandwidth	FCC Part 15: 15.247 ANSI C63.10:2013	Pass
Peak Output Power	FCC Part 15: 15.247 ANSI C63.10:2013	Pass
Power Spectral Density	FCC Part 15:15.247 ANSI C63.10:2013	Pass
Band Edge Compliance (conducted method)	FCC Part 15: 15.209 FCC Part 15: 15.247 ANSI C63.10: 2013	Pass
Radiation Emission	FCC Part 15: 15.247 ANSI C63.10:2013	Pass
RF Conducted Spurious Emissions	FCC Part 15: 15.209 FCC Part 15: 15.247 ANSI C63.10: 2013	Pass
Emission in Restricted Frequency Bands	FCC Part 15: 15.209 FCC Part 15: 15.247 ANSI C63.10: 2013	Pass
Power Line Conducted Emission	FCC Part 15: 15.207 ANSI C63.10: 2013	Pass
Antenna Requirement	FCC Part 15: 15.203	Pass

2. General Test Information

2.1. Description of EUT

Eut* Name	: Subblue Smart Waterproof Phone Case
Model Number	: H1+
EUT Function Description	: Please reference user manual of this device
Power Supply	: DC 5V from USB : DC 3.7V by Polymer Li-ion built-in battery
Radio Specification	: Bluetooth V4.2
Operation Frequency	: 2402 MHz - 2480 MHz
Modulation	: GFSK
Data Rate	: 1Mbps, 2Mbps
Antenna Type	: PCB antenna, maximum PK gain:-1.40 dBi
Sample Number	: N/A

Note: EUT is the ab. of equipment under test.

Channel information					
Channel	Frequency (MHz)	Channel	Frequency (MHz)	Channel	Frequency (MHz)
0	2402	14	2430	28	2458
1	2404	15	2432	29	2460
2	2406	16	2434	30	2462
3	2408	17	2436	31	2464
4	2410	18	2438	32	2466
5	2412	19	2440	33	2468
6	2414	20	2442	34	2470
7	2416	21	2444	35	2472
8	2418	22	2446	36	2474
9	2420	23	2448	37	2476
10	2422	24	2450	38	2478
11	2424	25	2452	39	2480
12	2426	26	2454		
13	2428	27	2456		

2.2. Accessories of EUT

Description of Accessories	Manufacturer	Model number	Description	Remark
USB Cable	N/A	N/A	Length 0.5m, Unshielded	N/A

2.3. Assistant equipment used for test

Assistant equipment	Manufacturer	Model number	EMC Compliance	SN
Notebook	Lenovo Beijing Co. Ltd.	ThinkPad	FCC/CE	TP00015A
AC adapter	N/A	EP-TA200	Input 100-240V~50/60Hz, Output 9V, 1.67A or 5V, 2A	SAMSUNG

2.4. Block diagram of EUT configuration for test

EUT

Test software: HciHelper_V2.0.EXE and UartAssist.EXE

The test software was used to control EUT work in Continuous Tx mode, and select test channel, wireless mode as below table:

Tested mode, channel, information			
Mode	Setting Tx Power	Channel	Frequency (MHz)
GFSK (1M)	/	CH0	2402
	/	CH19	2440
	/	CH39	2480
GFSK (2M)	/	CH0	2402
	/	CH19	2440
	/	CH39	2480

2.5. Test environment conditions

During the measurement the environmental conditions were within the listed ranges:

Temperature range:	21-25 °C
Humidity range:	40-75%
Pressure range:	86-106 kPa

2.6. Deviations of test standard

No deviation.

2.7. Test laboratory

Dongguan Dongdian Testing Service Co., Ltd.

Add.: No. 17, Zongbu Road 2, Songshan Lake Sci&Tech, Industry Park, Dongguan City, Guangdong Province, China, 523808

Tel.: +86-0769-38826678, <http://www.dgddt.com>, Email: ddt@dgddt.com

CNAS Registration No. CNAS L6451; A2LA Certificate Number: 3870.01;

FCC Designation Number: CN1182; FCC Test Firm Registration Number: 540522

Industry Canada Site Registration Number: 10288A-1

2.8. Measurement uncertainty

Test Item	Uncertainty
Bandwidth	1.1%
Peak Output Power (Conducted) (Spectrum analyzer)	0.86 dB (10 MHz ≤ f < 3.6 GHz);
	1.38 dB (3.6 GHz ≤ f < 8 GHz)
Peak Output Power (Conducted) (Power Sensor)	0.74 dB
Power Spectral Density	0.74 dB (10 MHz ≤ f < 3.6 GHz);
	1.38 dB (3.6 GHz ≤ f < 8 GHz)
Frequencies Stability	6.7 x 10 ⁻⁸ (Antenna couple method)
	5.5 x 10 ⁻⁸ (Conducted method)
Conducted spurious emissions	0.86 dB (10 MHz ≤ f < 3.6 GHz);
	1.40 dB (3.6 GHz ≤ f < 8 GHz)
	1.66 dB (8 GHz ≤ f < 22 GHz)
Uncertainty for radio frequency (RBW < 20 kHz)	3x10 ⁻⁸
Temperature	0.4 °C

Humidity	2 %
Uncertainty for Radiation Emission test (30 MHz - 1 GHz)	4.70 dB (Antenna Polarize: V)
	4.84 dB (Antenna Polarize: H)
Uncertainty for Radiation Emission test (1 GHz - 40 GHz)	4.10 dB (1 - 6 GHz)
	4.40 dB (6 GHz - 18 GHz)
	3.54 dB (18 GHz - 26 GHz)
	4.30 dB (26 GHz - 40 GHz)
Uncertainty for Power line conduction emission test	3.32 dB (150 kHz - 30 MHz)
Note: This uncertainty represents an expanded uncertainty expressed at approximately the 95% confidence level using a coverage factor of k=2.	

3. Equipment Used During Test

Equipment	Manufacturer	Model No.	Serial No.	Last Cal.	Cal. Interval
RF Connected Test (Tonscend RF Measurement System)					
Spectrum analyzer	R&S	FSU26	200071	Sep. 25, 2020	1 Year
Spectrum analyzer	Agilent	N9020D	MY49100362	Sep. 28, 2020	1 Year
Wideband Radio Communication tester	R&S	CMW500	117491	Jul. 01, 2020	1 Year
Vector Signal Generator	Agilent	E8267D	US49060192	Sep. 24, 2020	1 Year
Vector Signal Generator	Agilent	N5182A	MY48180737	Jul. 01, 2020	1 Year
Power Sensor	Agilent	U2021XA	MY55150010	Jul. 01, 2020	1 Year
Power Sensor	Agilent	U2021XA	MY55150011	Jul. 01, 2020	1 Year
DC Power Source	MATRIS	MPS-3005L-3	D813058W	Jul. 01, 2020	1 Year
RF Cable	Micable	C10-01-01-1	100309	Sep. 28, 2020	1 Year
Temp&Humi Programmable	ZHIXIANG	ZXGDJS-150L	ZX170110-A	Jul. 01, 2020	1 Year
Test Software	JS Tonscend	JS1120-3	Ver.2.7	N/A	N/A
Radiation 1#chamber					
EMI Test Receiver	R&S	ESU8	100316	Sep. 24, 2020	1 Year
Spectrum analyzer	Agilent	E4447A	MY50180031	Jul. 01, 2020	1 Year
Trilog Broadband Antenna	Schwarzbeck	VULB9163	9163-462	Nov. 13, 2020	1 Year
Active Loop antenna	Schwarzbeck	FMZB-1519	1519-038	Nov. 13, 2020	1 Year
Double Ridged Horn Antenna	R&S	HF907	100276	Nov. 18, 2020	1 Year
Broad Band Horn Antenna	Schwarzbeck	BBHA 9170	790	Apr. 11, 2021	1 Year
Pre-amplifier	A.H.	PAM-0118	360	Sep. 28, 2020	1 Year
RF Cable	HUBSER	CP-X2+ CP-X1	W11.03+ W12.02	Sep. 24, 2020	1 Year
RF Cable	N/A	5m+6m+1m	06270619	Sep. 30, 2020	1 Year
MI Cable	HUBSER	C10-01-01-1 M	1091629	Sep. 30, 2020	1 Year
Test software	Audix	E3	V 6.11111b	N/A	N/A
Radiation 2#chamber					
EMI Test Receiver	R&S	ESCI	101364	Sep. 28, 2020	1 Year
Spectrum analyzer	Agilent	E4447A	MY50180031	Jul. 01, 2020	1 Year
Trilog Broadband Antenna	Schwarzbeck	VULB 9163	9163-994	Nov. 13, 2020	1 Year
Active Loop antenna	Schwarzbeck	FMZB-1519	1519-038	Nov. 13, 2020	1 Year
Double Ridged Horn Antenna	Schwarzbeck	BBHA9120	02108	Jul. 11, 2020	1 Year
Broad Band Horn Antenna	Schwarzbeck	BBHA 9170	790	Apr. 11, 2020	1 Year
Pre-amplifier	TERA-MW	TRLA-0040 G35	101303	Sep. 28, 2020	1 Year

RF Cable	N/A	14+1.5m	06270619	Sep. 28, 2020	1 Year
Test software	Audix	E3	V 6.11111b	N/A	N/A
Test software	TOYO	EP5/RE	Ver. 5.7.10	N/A	N/A
Power Line Conducted Emissions Test 1#					
EMI Test Receiver	R&S	ESU8	100316	Sep. 24, 2020	1 Year
LISN 1	R&S	ENV216	101109	Sep. 28, 2020	1 Year
LISN 2	R&S	ESH2-Z5	100309	Sep. 28, 2020	1 Year
Pulse Limiter	R&S	ESH3-Z2	101242	Sep. 24, 2020	1 Year
CE Cable 1	HUBSER	N/A	W10.01	Sep. 24, 2020	1 Year
Test software	Audix	E3	V 6.11111b	N/A	N/A
Power Line Conducted Emissions Test 2#					
Test Receiver	R&S	ESPI	101761	Sep. 24, 2020	1 Year
LISN 1	R&S	ENV216	101170	Sep. 28, 2020	1 Year
LISN 2	R&S	ESH2-Z5	100309	Sep. 28, 2020	1 Year
Pulse Limiter	R&S	KH43101	43101180156 8-12#	Jul. 01, 2020	1 Year
CE Cable 2	HUBSER	N/A	W11.02	Sep. 24, 2020	1 Year
Test software	Audix	E3	V 6.11111b	N/A	N/A

4. 6 dB Bandwidth and 99% Bandwidth

4.1. Block diagram of test setup

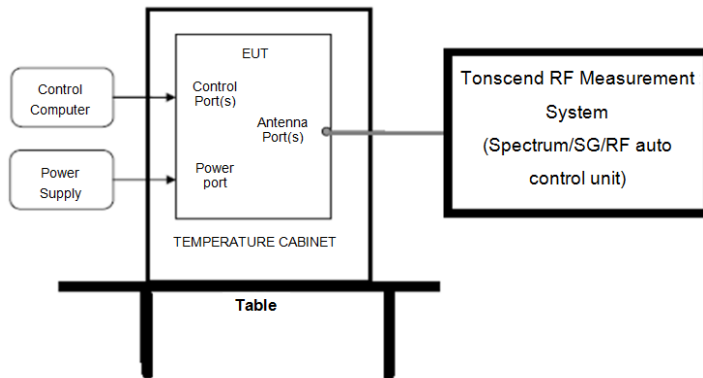

4.2. Limits

For direct sequence systems, the minimum 6 dB bandwidth shall be at least 500 kHz

4.3. Test procedure

(1) Connect EUT's antenna output to spectrum analyzer by RF cable.

(2) 99% Bandwidth set the spectrum analyzer as follows:

RBW:	30 kHz
VBW:	100 kHz
Detector Mode:	Peak
Sweep time:	auto
Trace mode	Max hold

(3) 6 dB Bandwidth set the spectrum analyzer as follows:

RBW:	100 kHz
VBW:	300 kHz
Detector Mode:	Peak
Sweep time:	auto
Trace mode	Max hold

(4) Allow the trace to stabilize, measure the 6 dB and 99% bandwidth of signal.

4.4. Test result

Mode	Channel	99% bandwidth Result (MHz)	6 dB bandwidth Result (MHz)	6 dB width Limit (MHz)	Verdict
GFSK (1M)	CH0	1.051	0.732	>0.5	Pass
	CH19	1.051	0.733	>0.5	Pass
	CH39	1.052	0.734	>0.5	Pass
GFSK (2M)	CH0	2.107	1.254	>0.5	Pass
	CH19	2.103	1.254	>0.5	Pass
	CH39	2.105	1.253	>0.5	Pass

4.5. Original test data

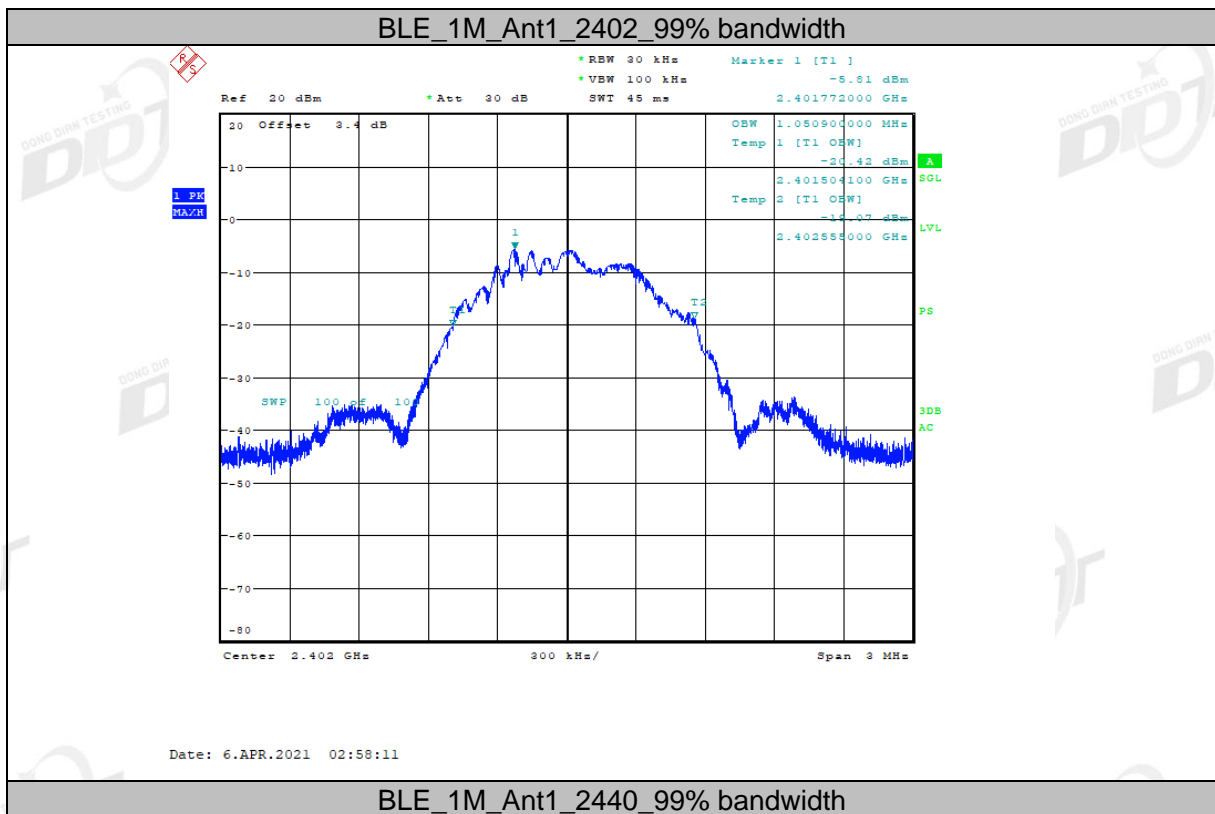

BLE_1M_Ant1_2440_99% bandwidth

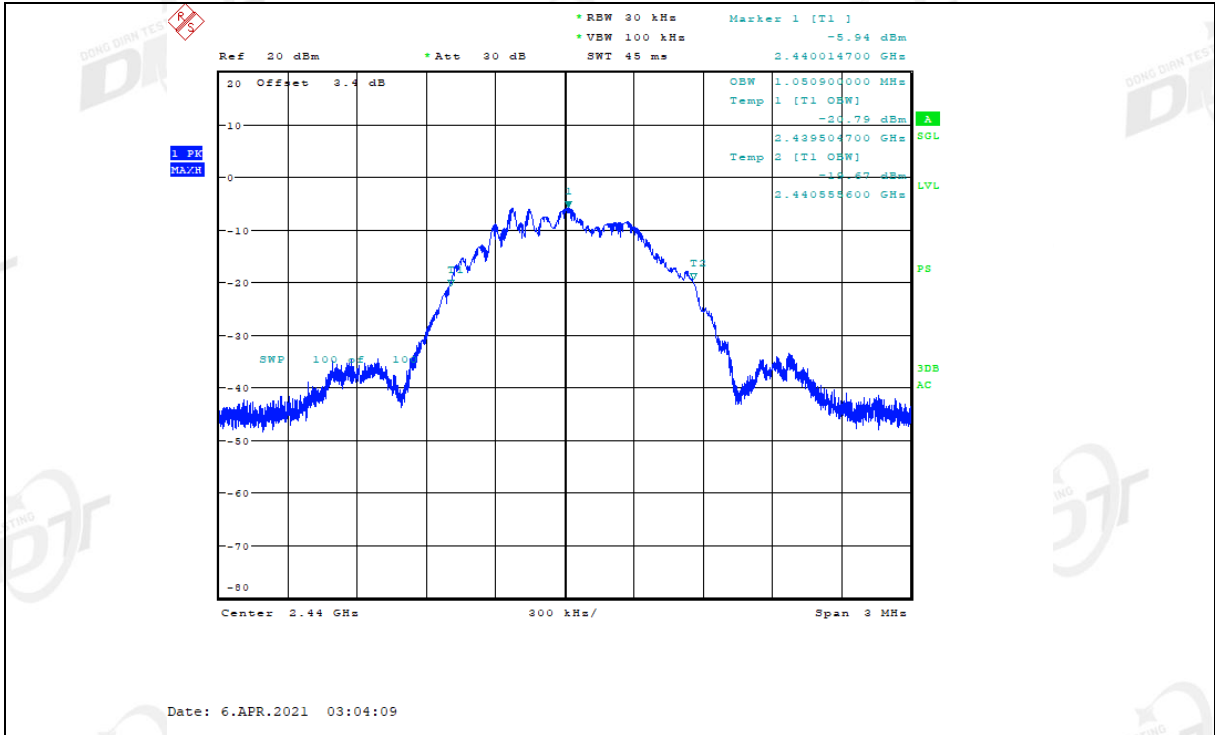

BLE_1M_Ant1_2480_99% bandwidth

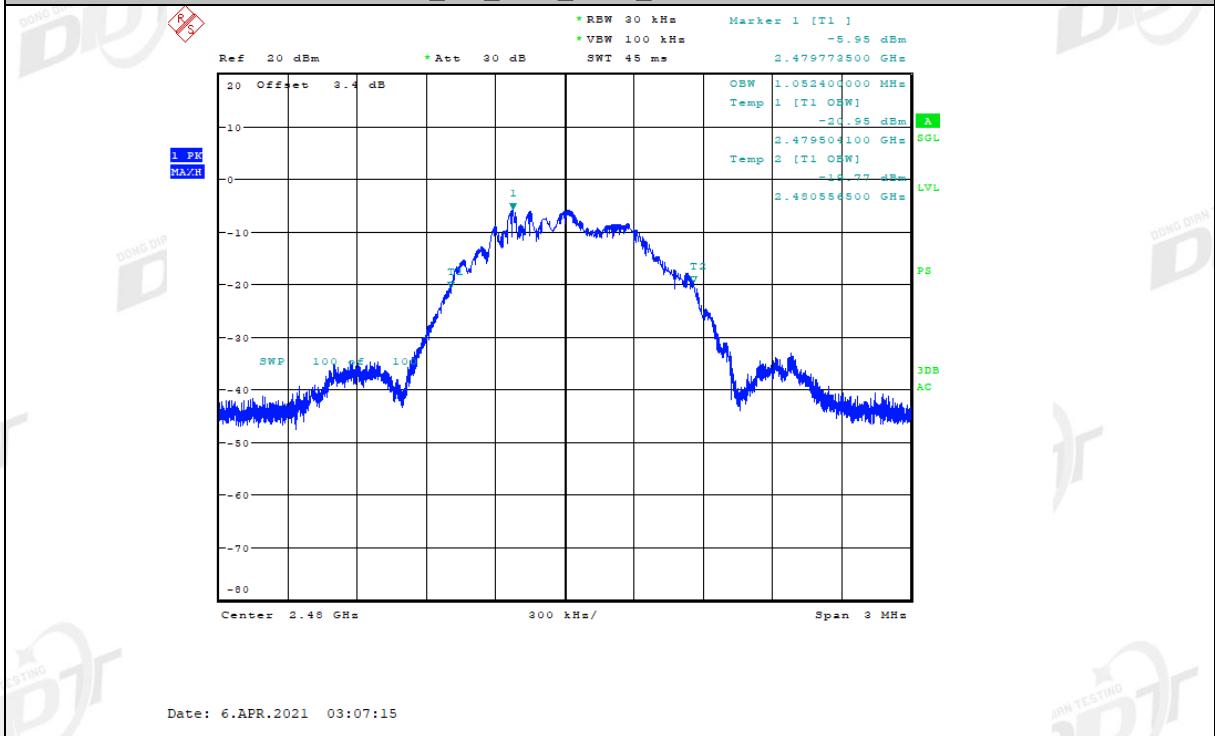

BLE_1M_Ant1_2402_6 dB bandwidth

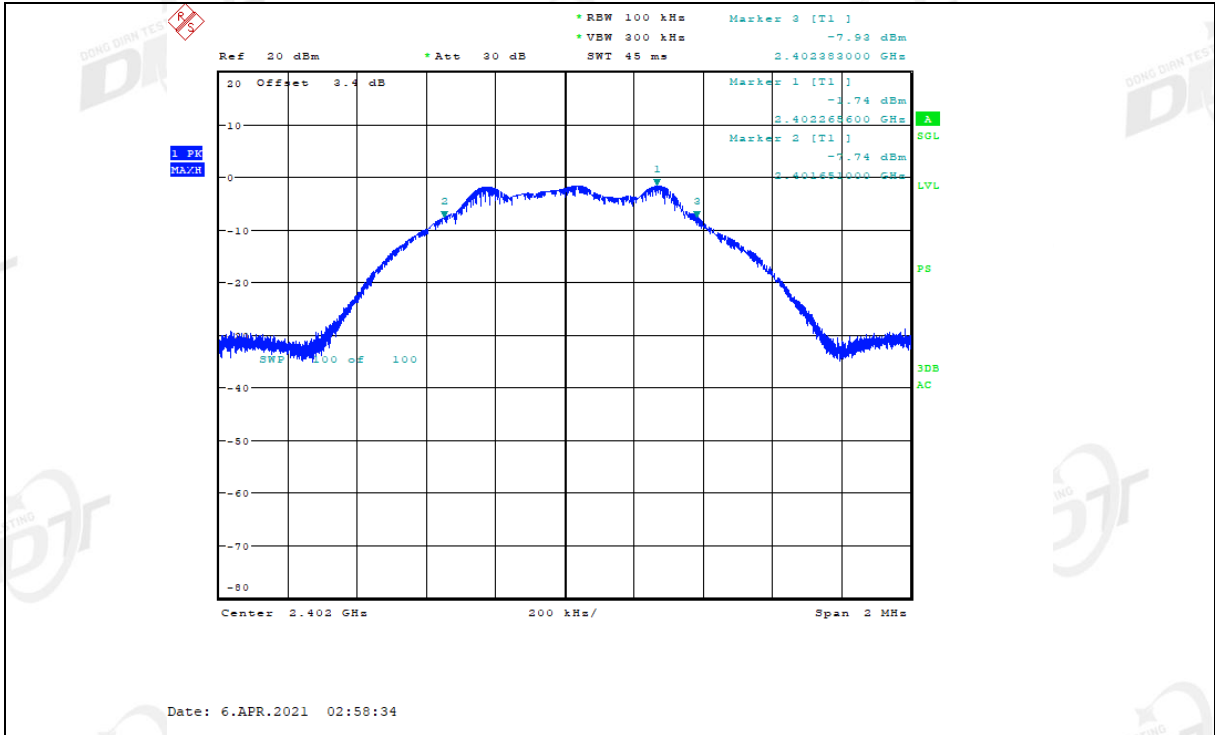

BLE_1M_Ant1_2440_6 dB bandwidth

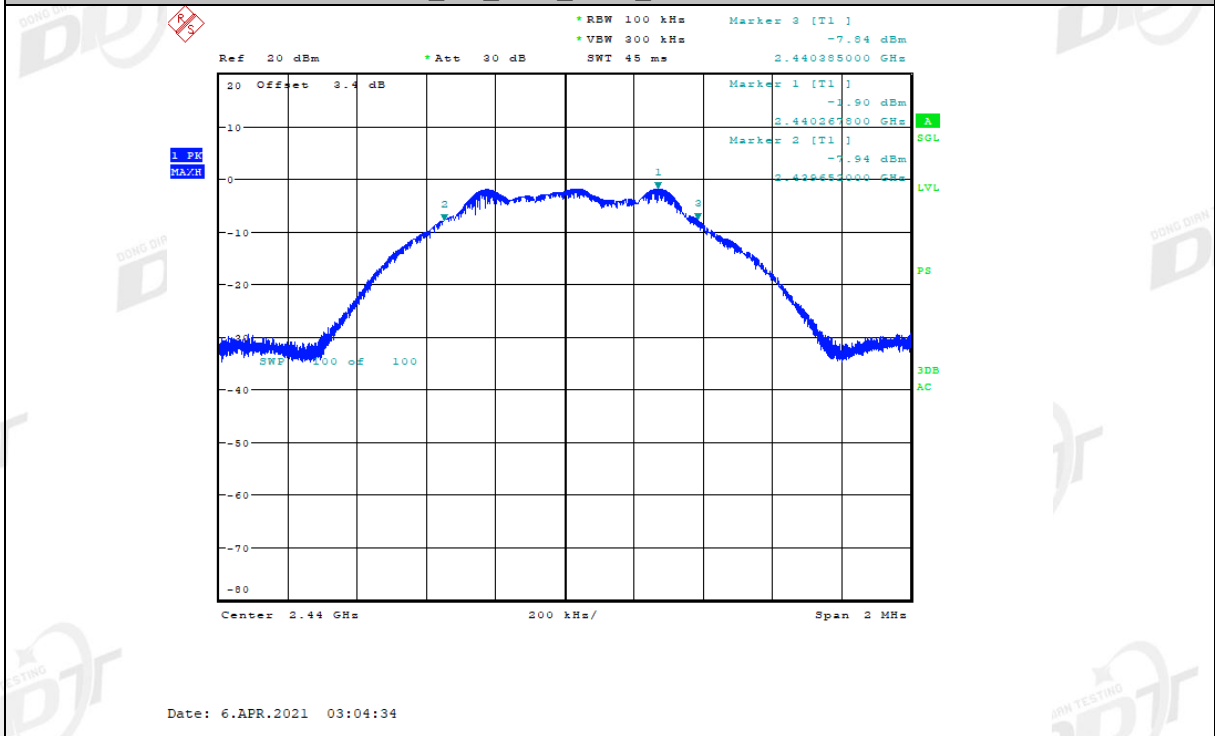

BLE_1M_Ant1_2480_6 dB bandwidth

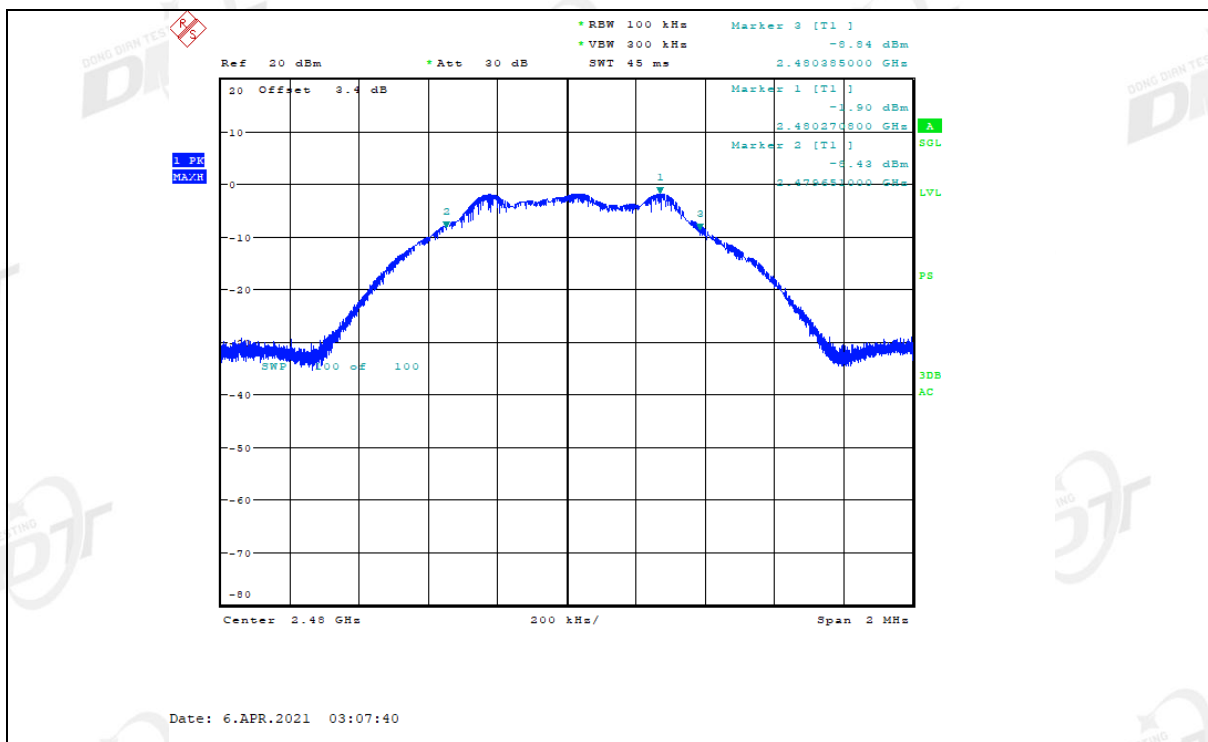

BLE_2M_Ant1_2402_99% bandwidth

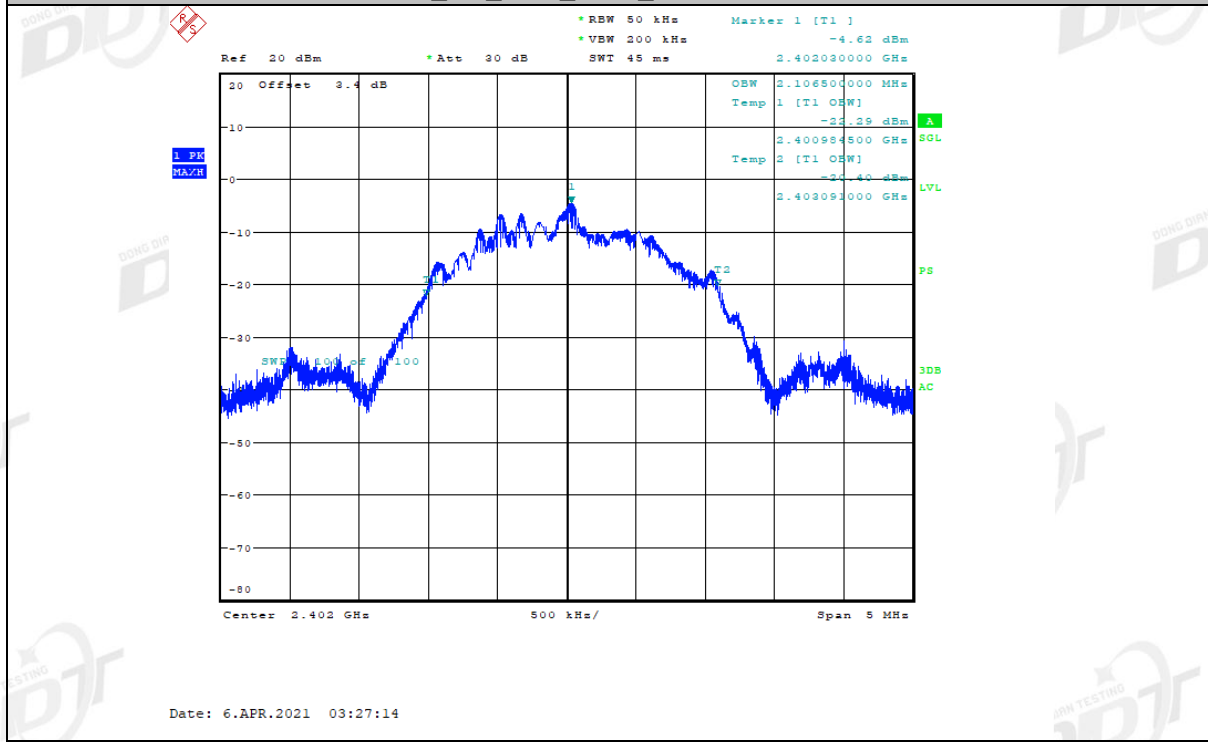

BLE_2M_Ant1_2440_99% bandwidth

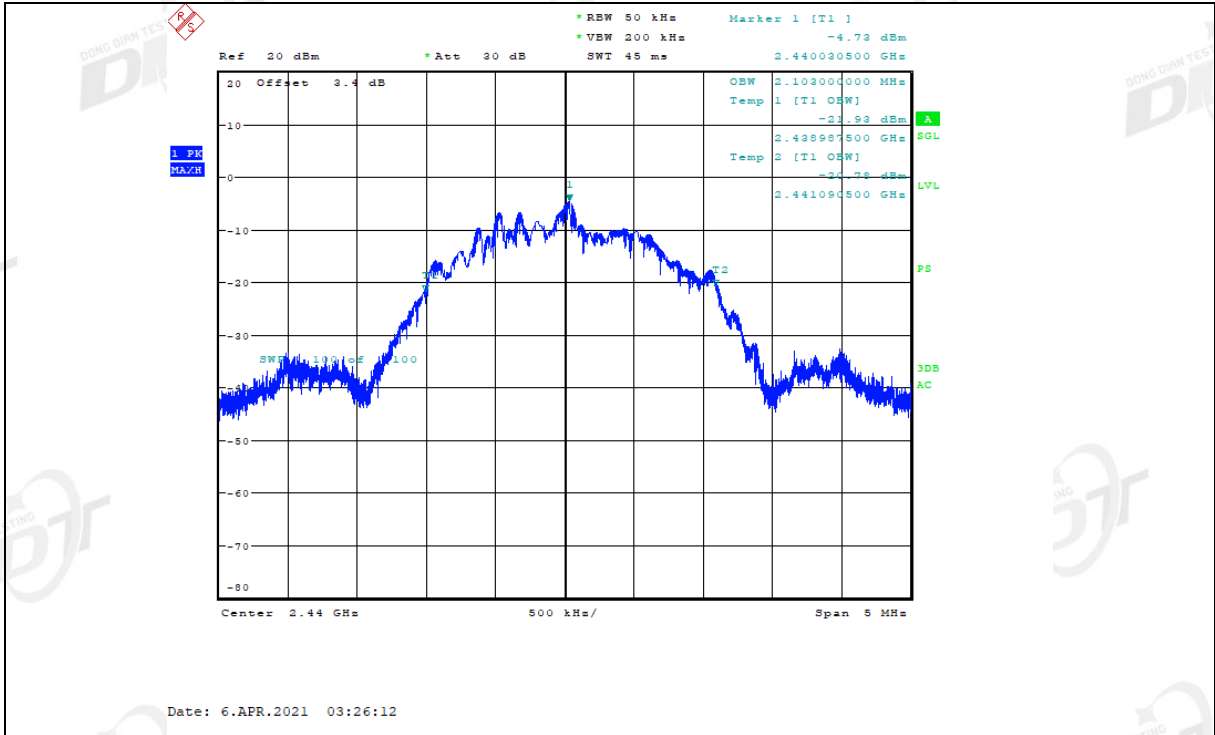

BLE_2M_Ant1_2480_99% bandwidth

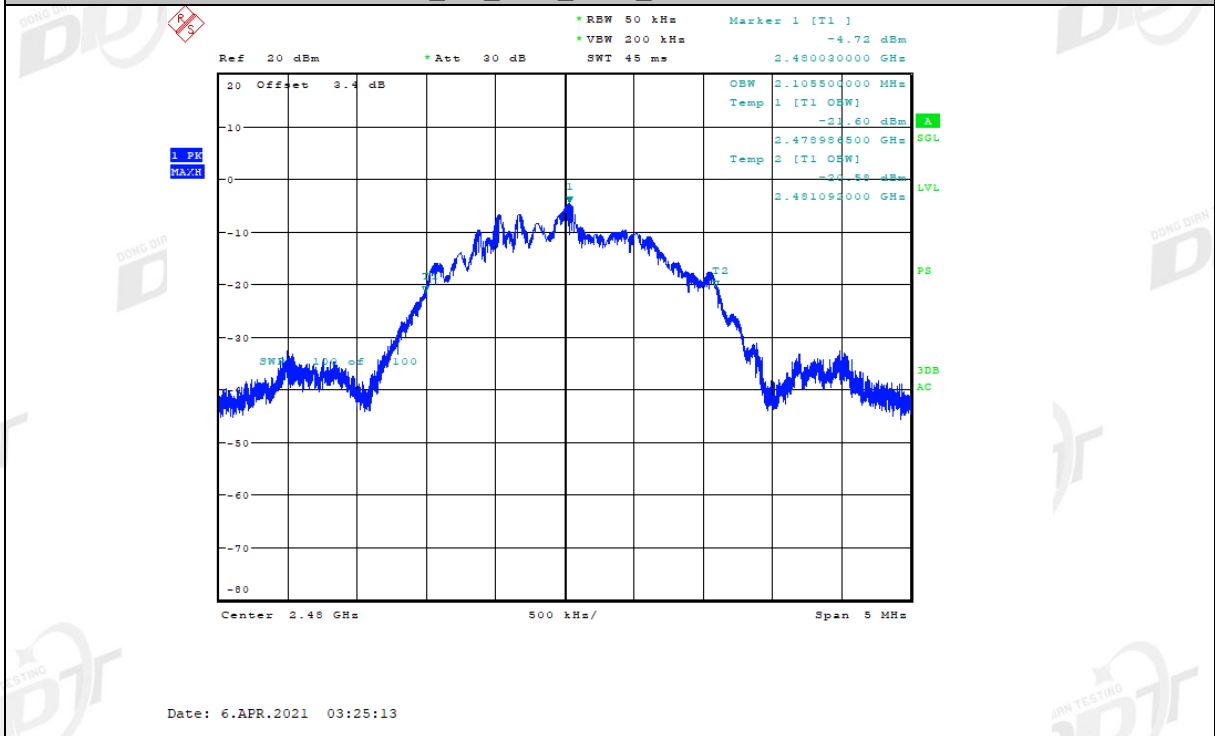

BLE_2M_Ant1_2402_6 dB bandwidth

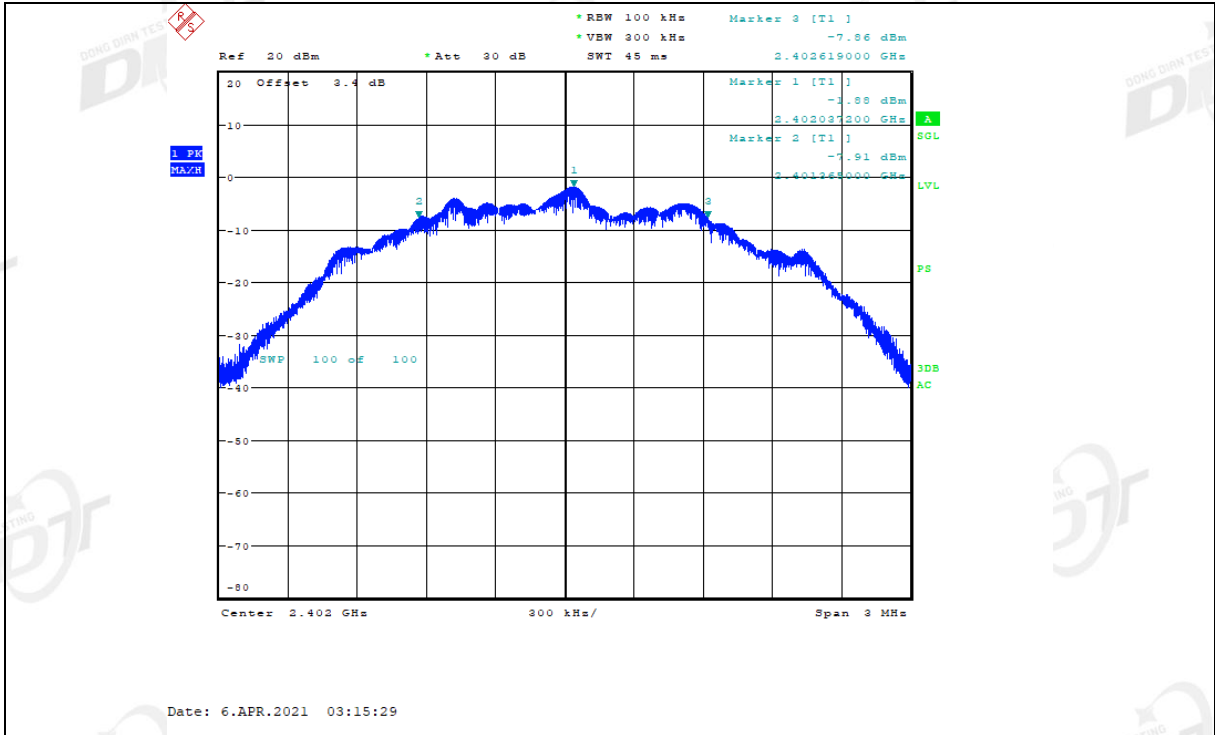

BLE_2M_Ant1_2440_6 dB bandwidth

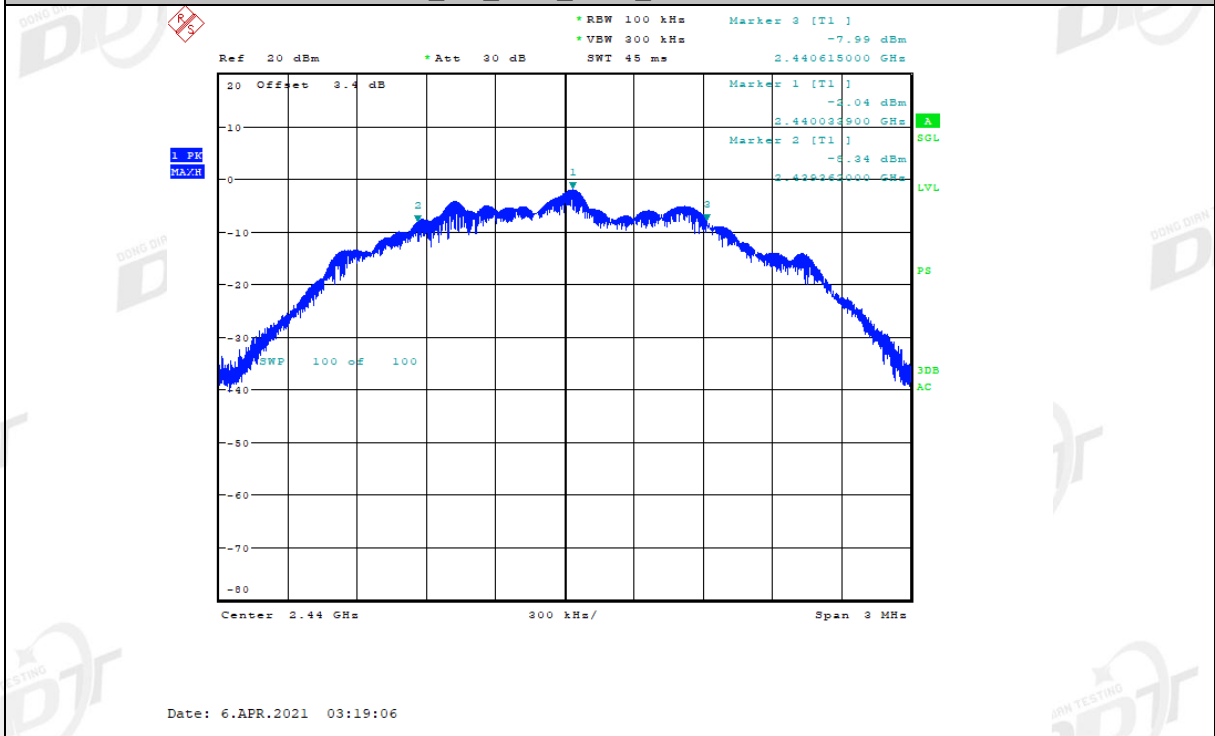

BLE_2M_Ant1_2480_6 dB bandwidth

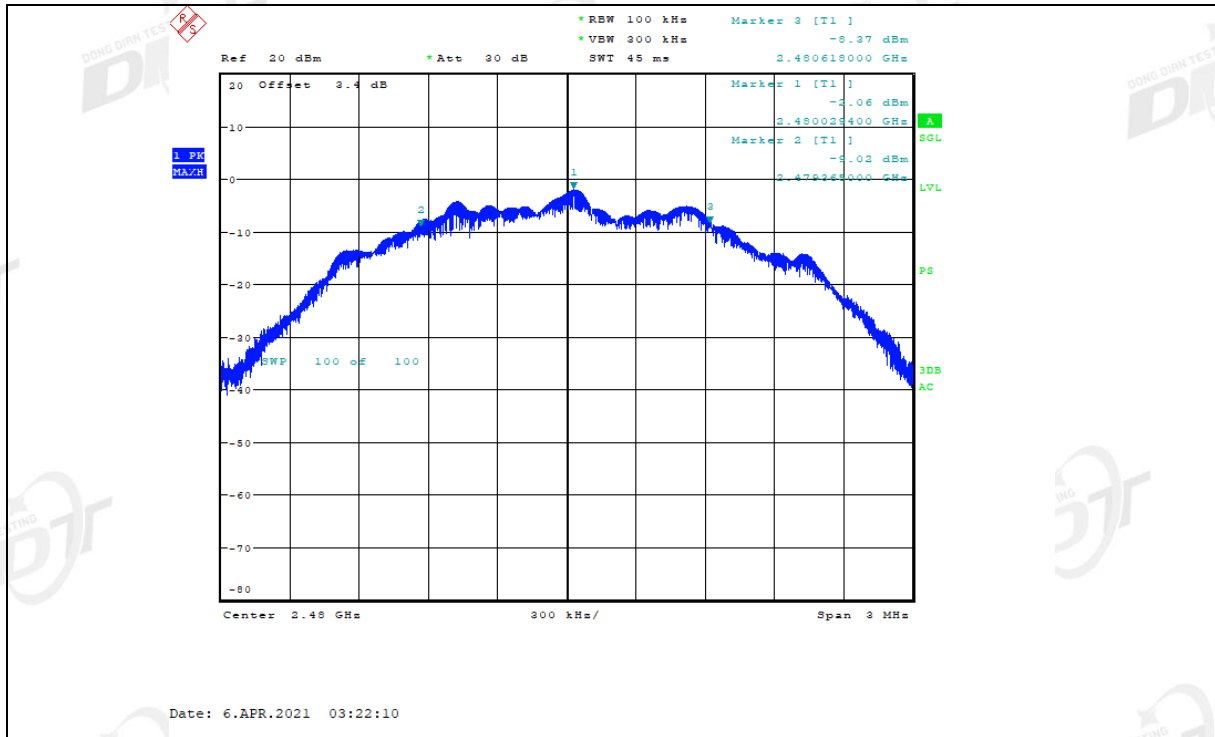

5. Maximum Peak Output Power

5.1. Block diagram of test setup

Same with 4.1

5.2. Limits

For systems using digital modulation in the 902-928 MHz, 2400-2483.5 MHz, and 5725-5850 MHz bands: 1 Watt. If transmitting antennas of directional gain greater than 6dBi are used, the conducted output power from the intentional radiator shall be reduced below the stated values as appropriate, by the amount in dB that the directional gain of the antenna exceeds 6 dBi.

5.3. Test procedure

(1) Connect EUT's antenna output to spectrum analyzer by RF cable.

(2) Set the spectrum analyzer as follows:

RBW:	≥DTS bandwidth
VBW:	≥3 x RBW
Span	≥3 x RBW
Detector Mode:	Peak
Sweep time:	auto
Trace mode	Max hold

(3) Allow the trace to stabilize, Use the instrument's band/channel power measurement function with the band limits set equal to the DTS bandwidth edges measure out the PK output power.

5.4. Test result

Mode	Freq. (MHz)	Peak Output Power (dBm)	Limit (dBm)	Verdict
GFSK (1M)	2402	-0.50	30	Pass
	2440	-0.68	30	Pass
	2480	-0.67	30	Pass
GFSK (2M)	2402	-0.49	30	Pass
	2440	-0.70	30	Pass
	2480	-0.65	30	Pass

5.5. Original test data

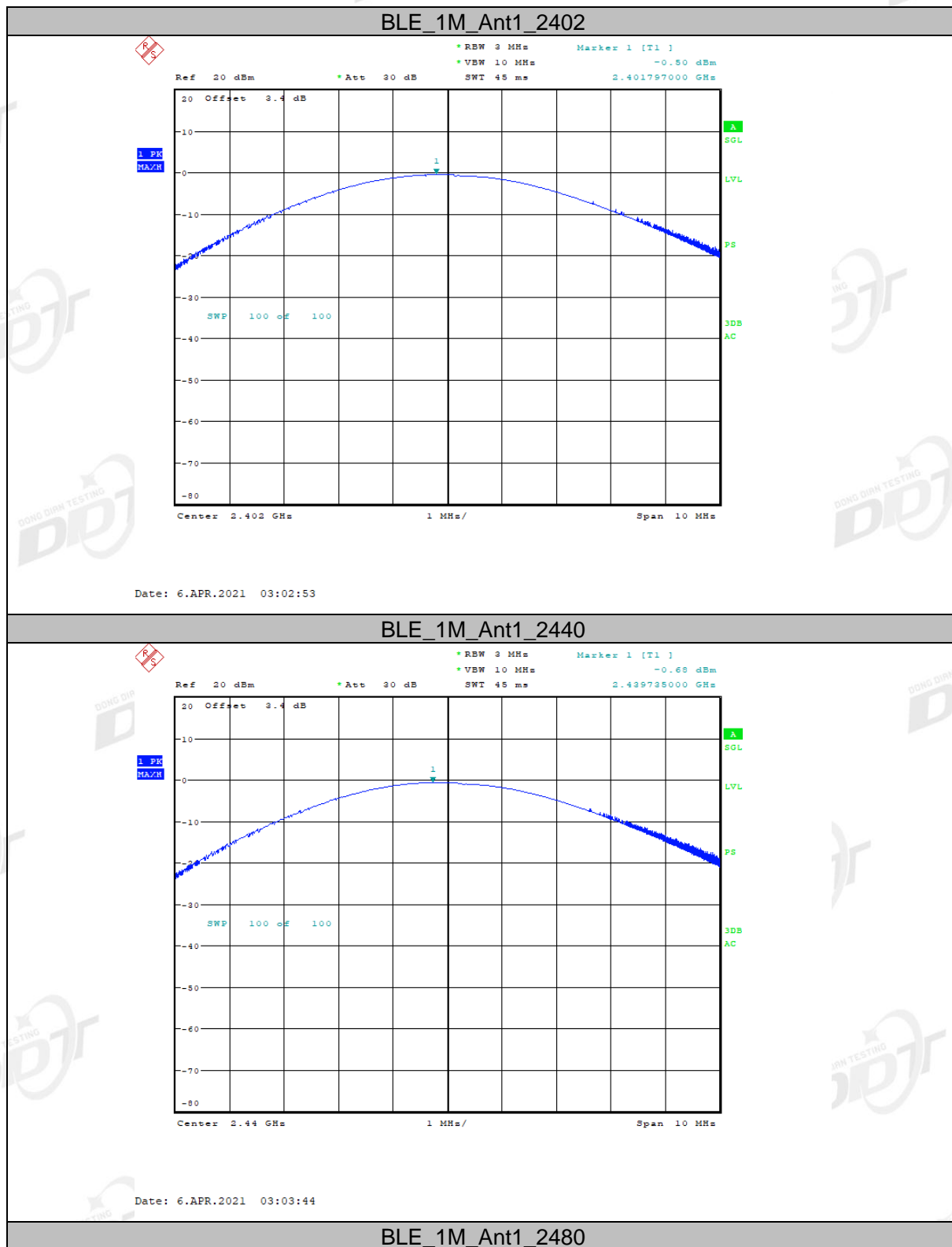

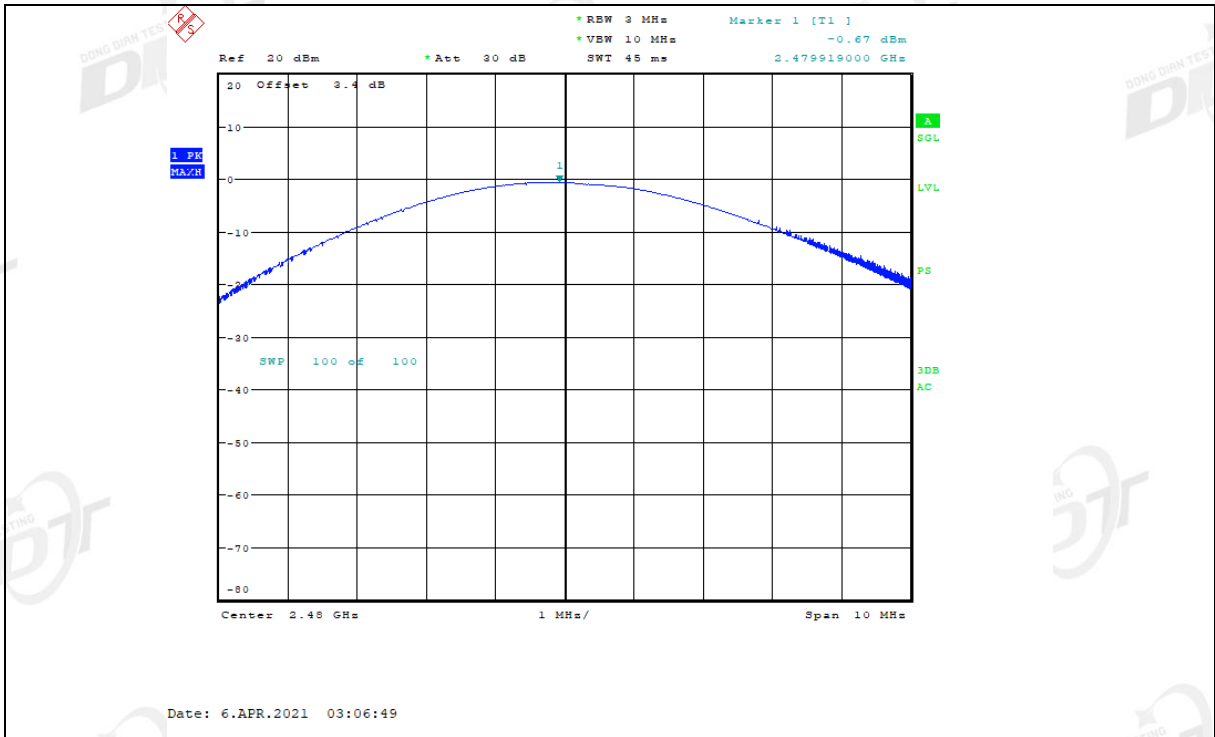

BLE_2M_Ant1_2402

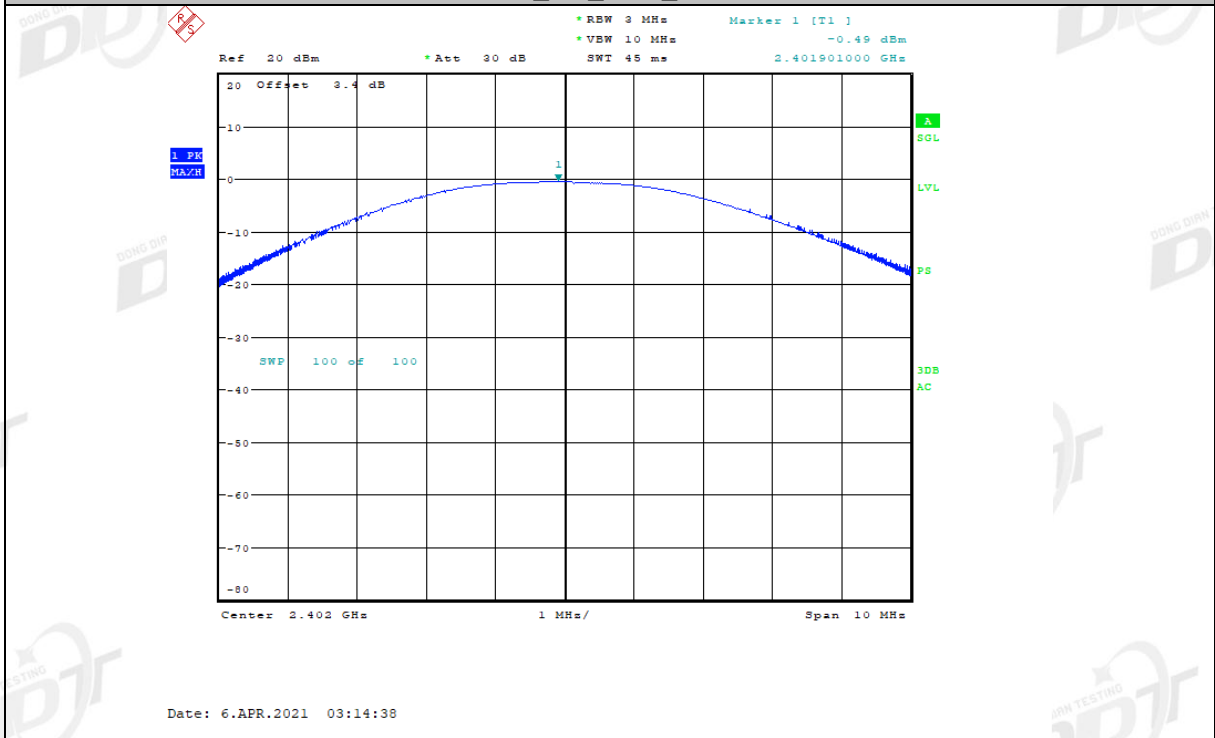

BLE_2M_Ant1_2440

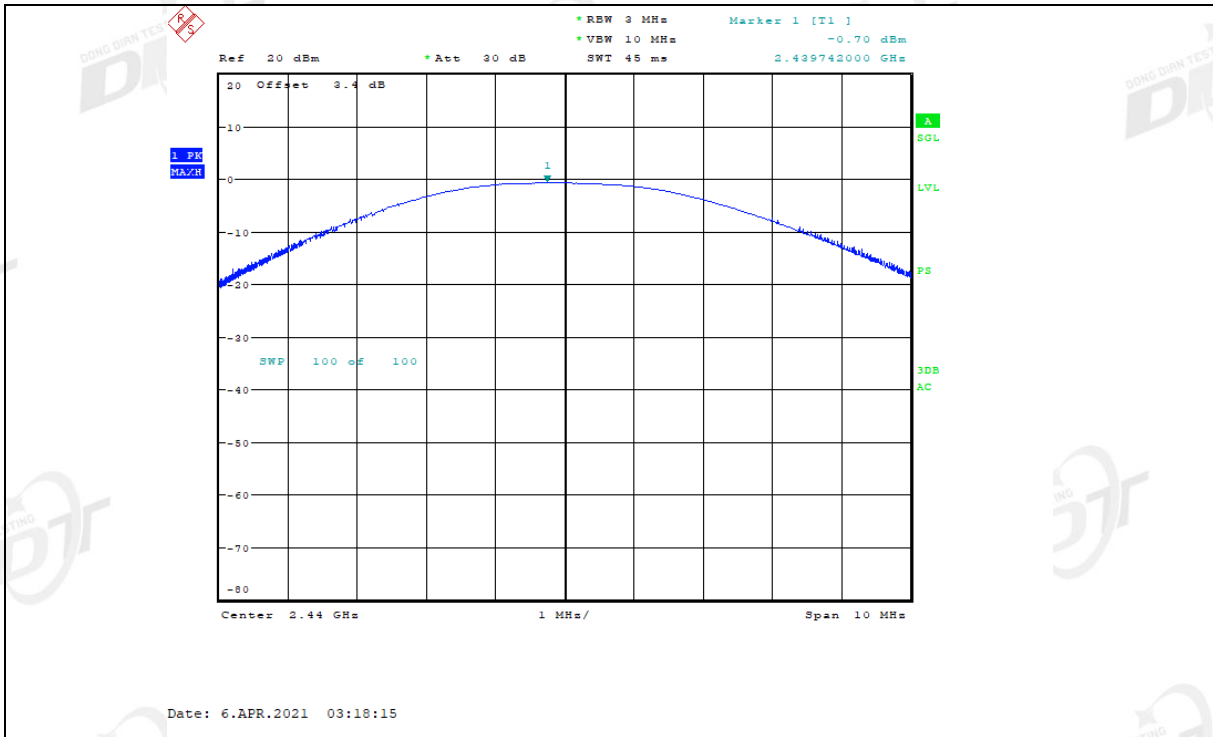

BLE_2M_Ant1_2480

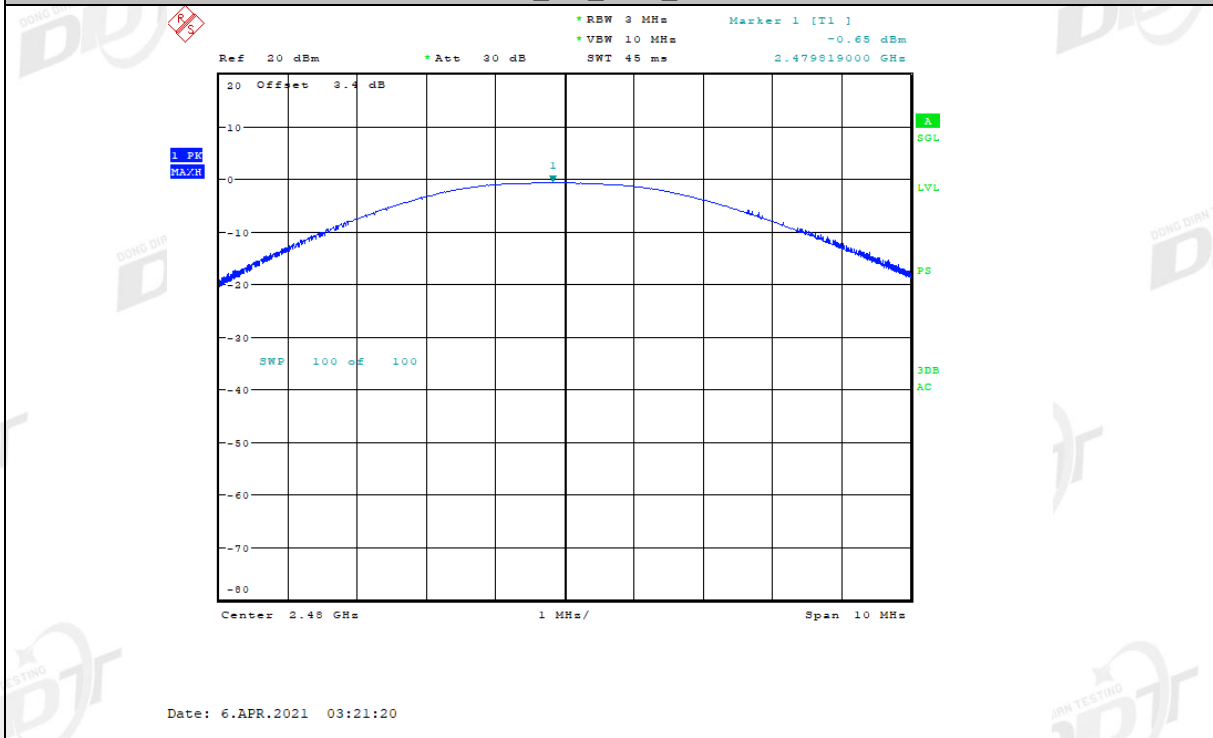

6. Power Spectral Density

6.1. Block diagram of test setup

Same with 4.1

6.2. Limits

For digitally modulated systems, the power spectral density conducted from the intentional radiator to the antenna shall not be greater than 8 dBm in any 3 kHz band during any time interval of continuous transmission.

6.3. Test procedure

- (1) Connect EUT's antenna output to spectrum analyzer by RF cable.
- (2) Set the spectrum analyzer as follows:

Center frequency	DTS Channel center frequency
RBW:	$3 \text{ kHz} \leq \text{RBW} \leq 100 \text{ kHz}$
VBW:	$\geq 3\text{RBW}$
Span	1.5 times the DTS bandwidth
Detector Mode:	Peak
Sweep time:	auto
Trace mode	Max hold

- (3) Allow the trace to stabilize, use the peak marker function to determine the maximum amplitude level within the RBW.
- (4) If measured value exceeds limit, reduce RBW (no less than 3 kHz) and repeat.

6.4. Test result

Left side:

EUT Set Mode	Antenna	Channel	Result (dBm/10 kHz)
GFSK (1M)	ANT1	CH0	-16.32
	ANT1	CH19	-16.34
	ANT1	CH39	-16.51
GFSK (2M)	ANT1	CH0	-19.02
	ANT1	CH19	-19.12
	ANT1	CH39	-16.32
Limit: <8 dBm/3 kHz			Verdict: Pass

6.5. Original test data

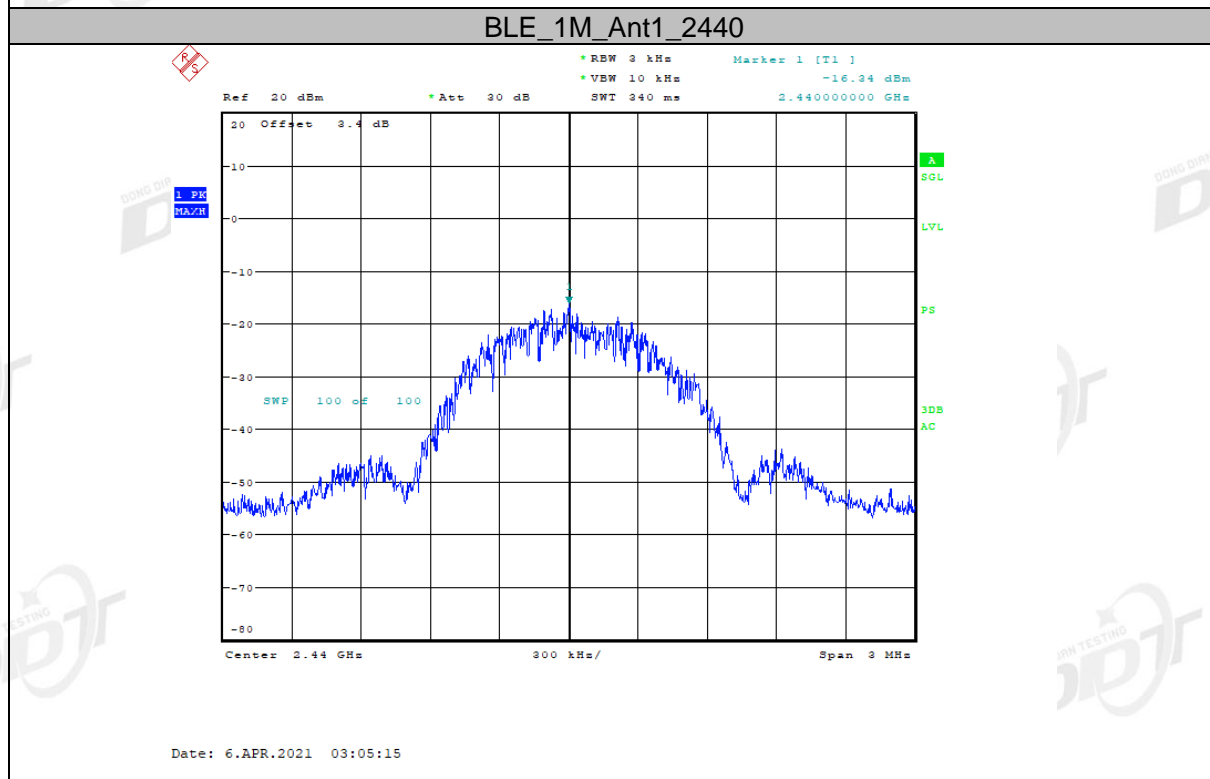
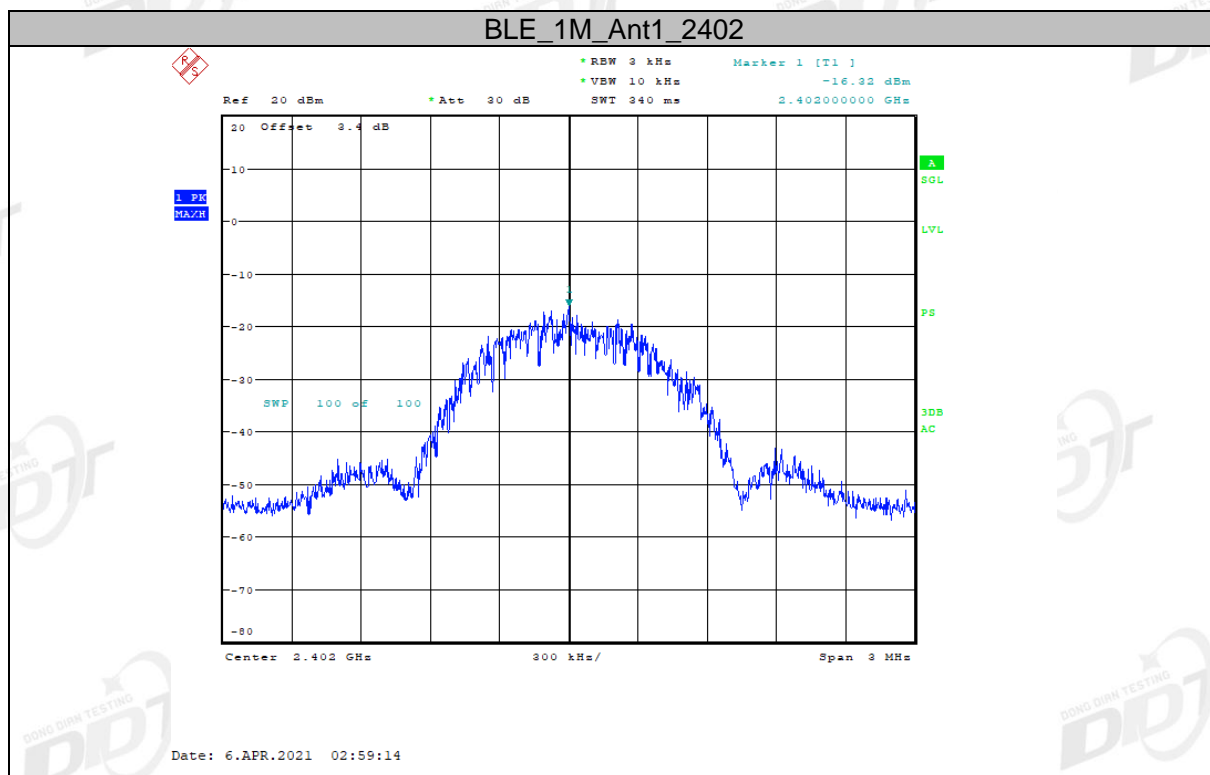

BLE_1M_Ant1_2480

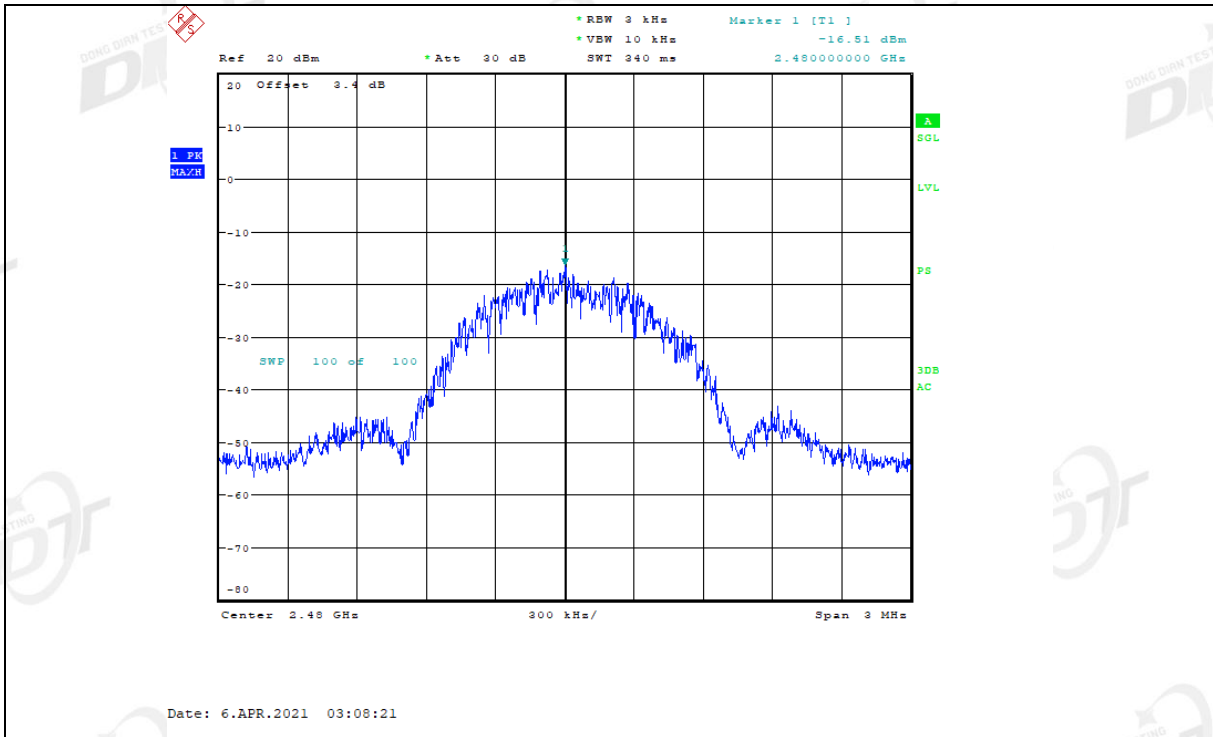

BLE_2M_Ant1_2402

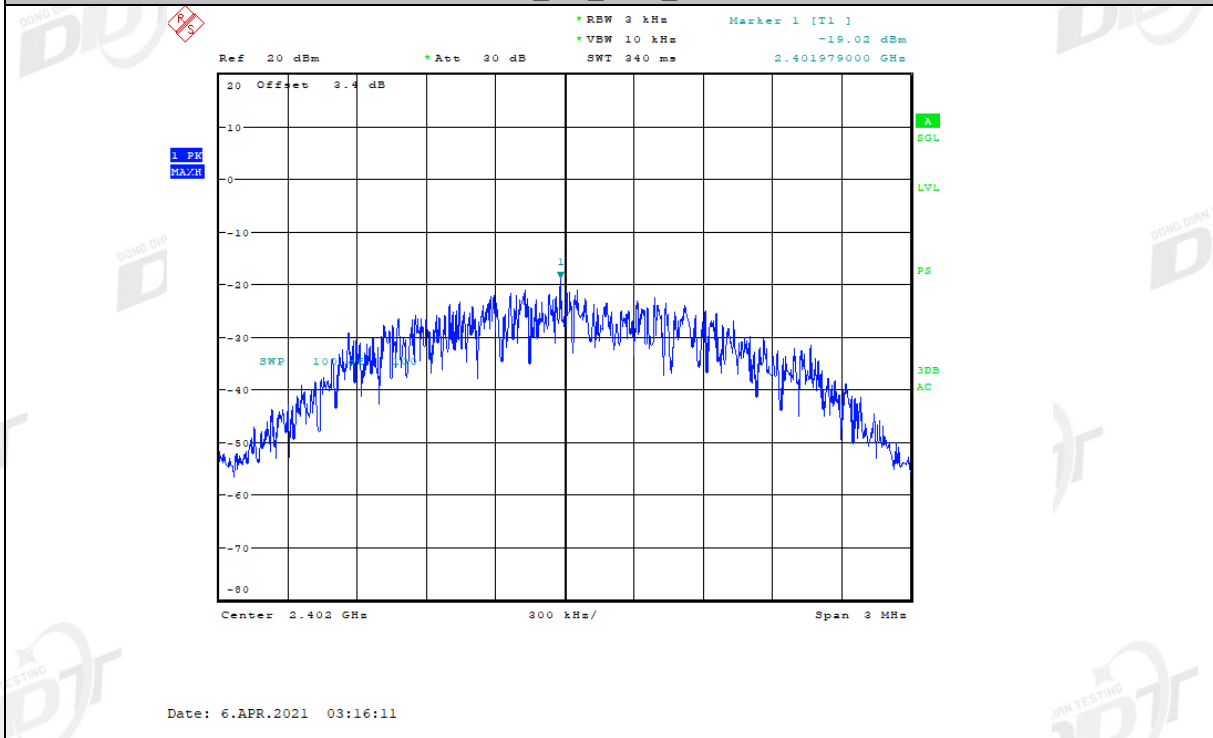

BLE_2M_Ant1_2440

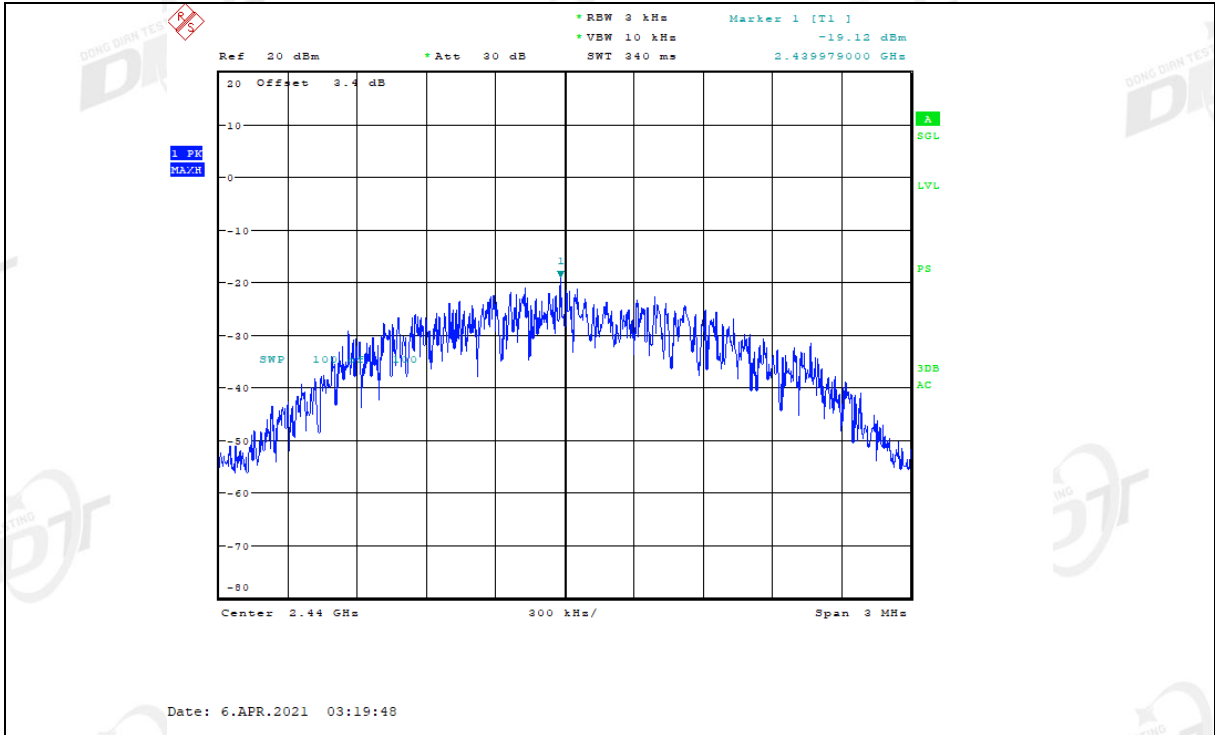

BLE_2M_Ant1_2480

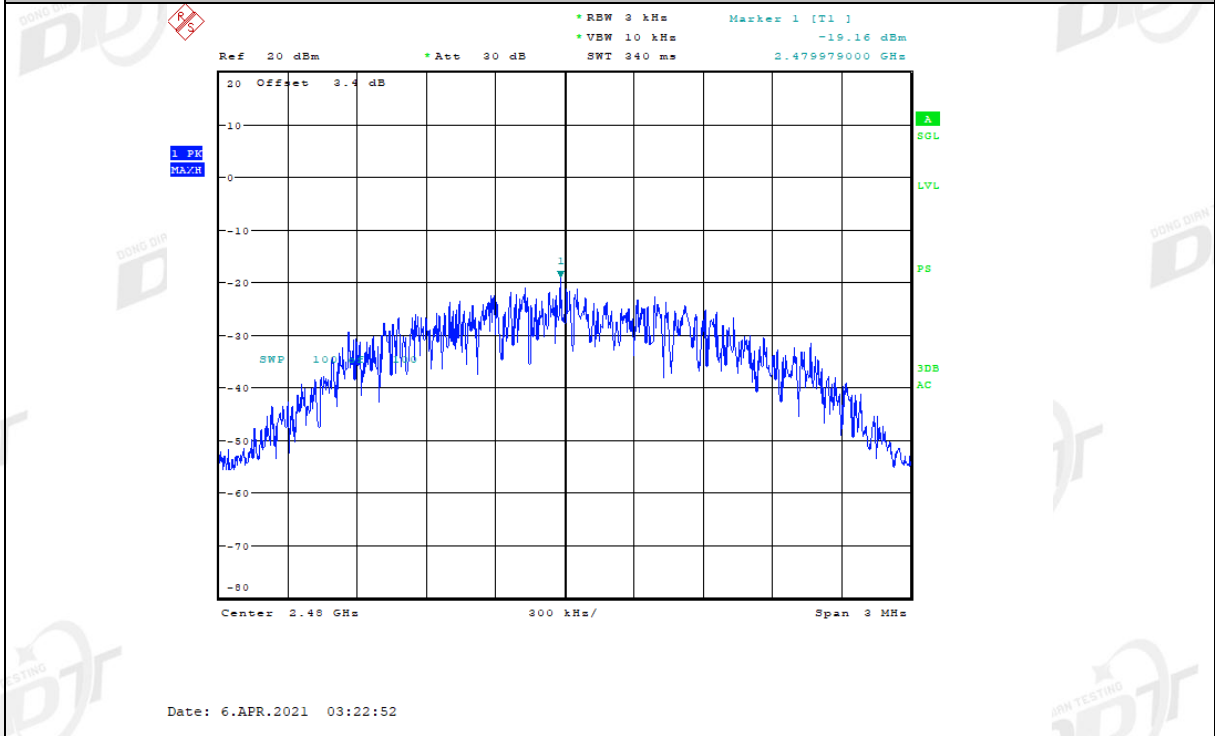

7. Band Edge Compliance (Conducted Method)

7.1. Block diagram of test setup

Same with 4.1

7.2. Limits

In any 100 kHz bandwidth outside the frequency bands in which the spread spectrum intentional radiator is operating, the radio frequency power that is produced by the intentional radiator shall be at least 20 dB below that in the 100 kHz bandwidth within the band that contains the highest level of the desired power.

7.3. Test procedure

(1) Connect EUT's antenna output to spectrum analyzer by RF cable.

(2) Establish a reference level by using the following procedure:

Center frequency	DTS Channel center frequency
RBW:	100 kHz
VBW:	300 kHz
Span	1.5 times the DTS bandwidth
Detector Mode:	Peak
Sweep time:	auto
Trace mode	Max hold

(3) Allow the trace to stabilize, use the peak marker function to determine the maximum peak power level to establish the reference level.

(4) Set the spectrum analyzer as follows:

RBW:	100 kHz
VBW:	300 kHz
Span	Encompass frequency range to be measured
Number of measurement points	$\geq \text{span}/\text{RBW}$
Detector Mode:	Peak
Sweep time:	auto
Trace mode	Max hold

(5) Allow the trace to stabilize, use the peak marker function to determine the maximum amplitude of all unwanted emissions outside of the authorized frequency band

7.4. Test result

EUT Set Mode	CH or Frequency	Measured Range	Verdict
GFSK (1M)	CH0	2.306 GHz - 2.406 GHz	Pass
	CH39	2.476 GHz - 2.576 GHz	Pass
GFSK (2M)	CH0	2.306 GHz - 2.406 GHz	Pass
	CH39	2.476 GHz - 2.576 GHz	Pass

7.5. Original test data

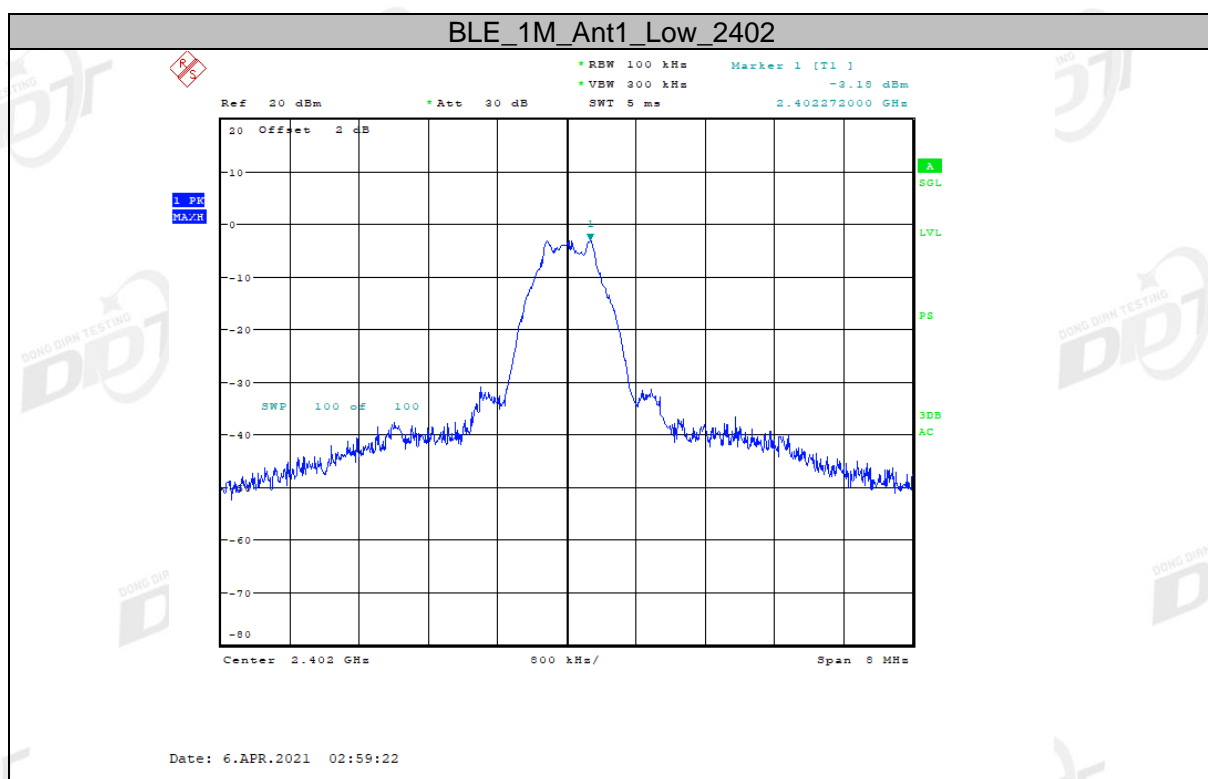

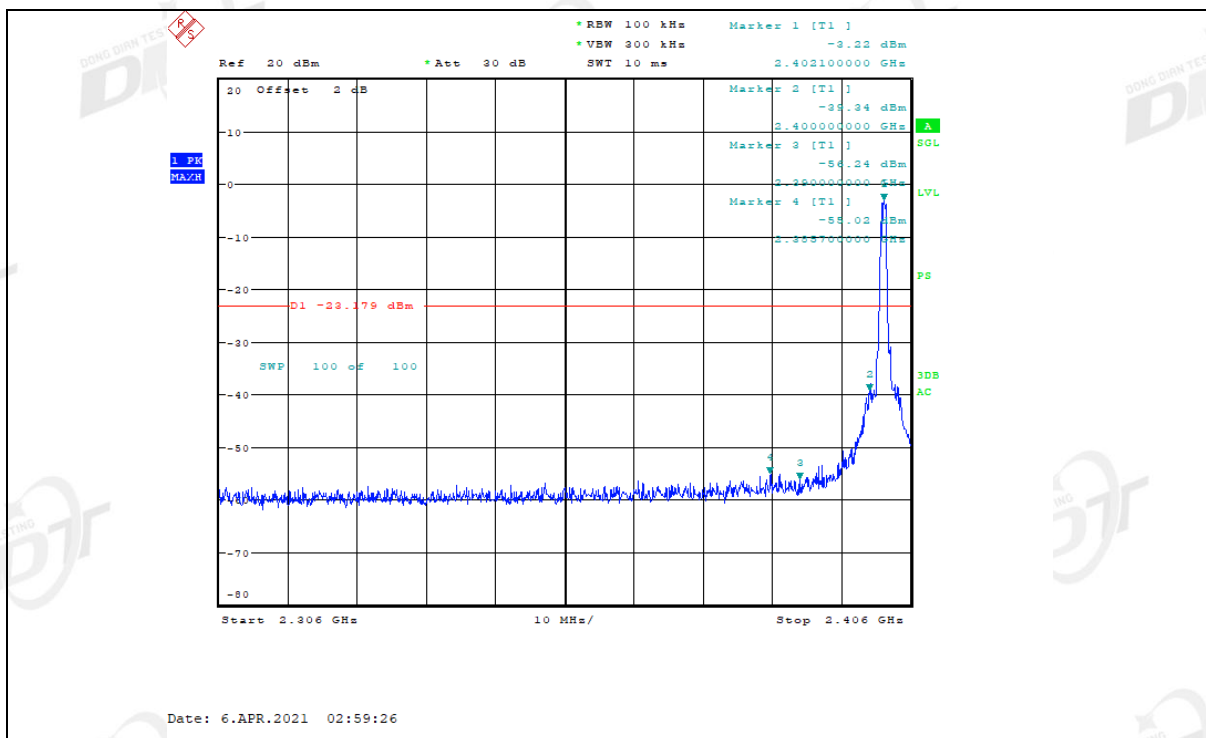

BLE_1M_Ant1_High_2480

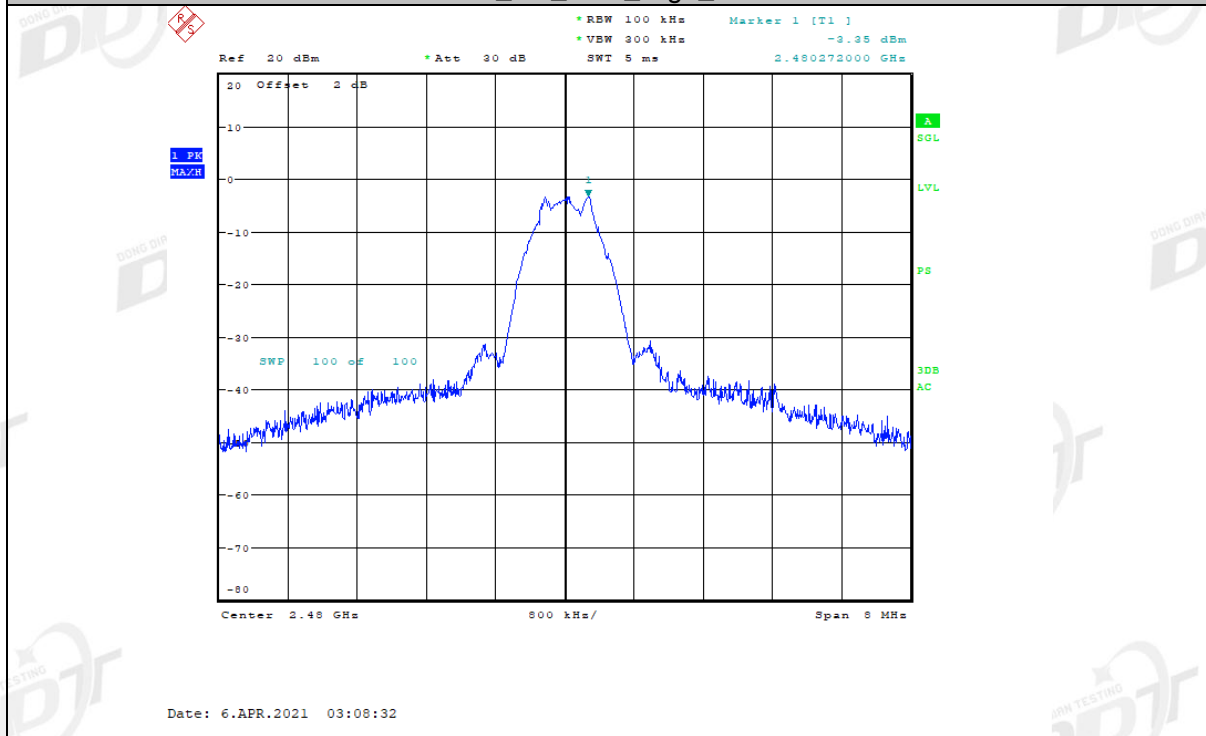

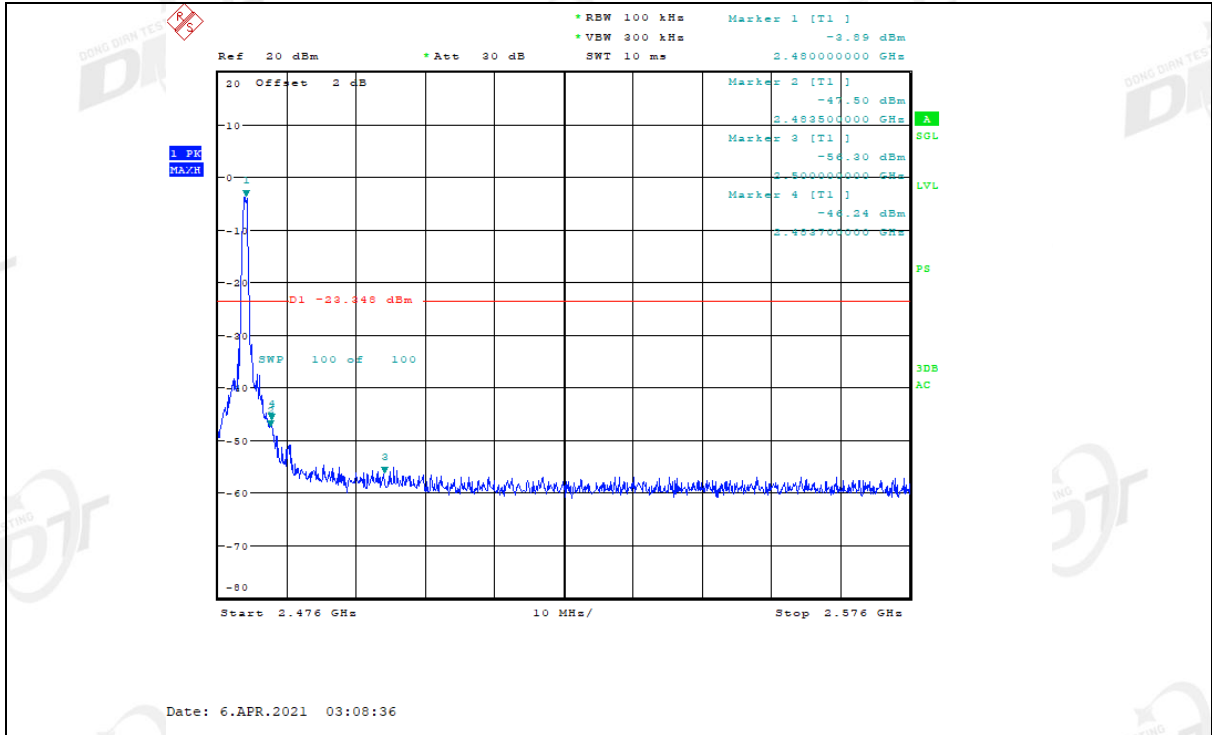

BLE_2M_Ant1_Low_2402

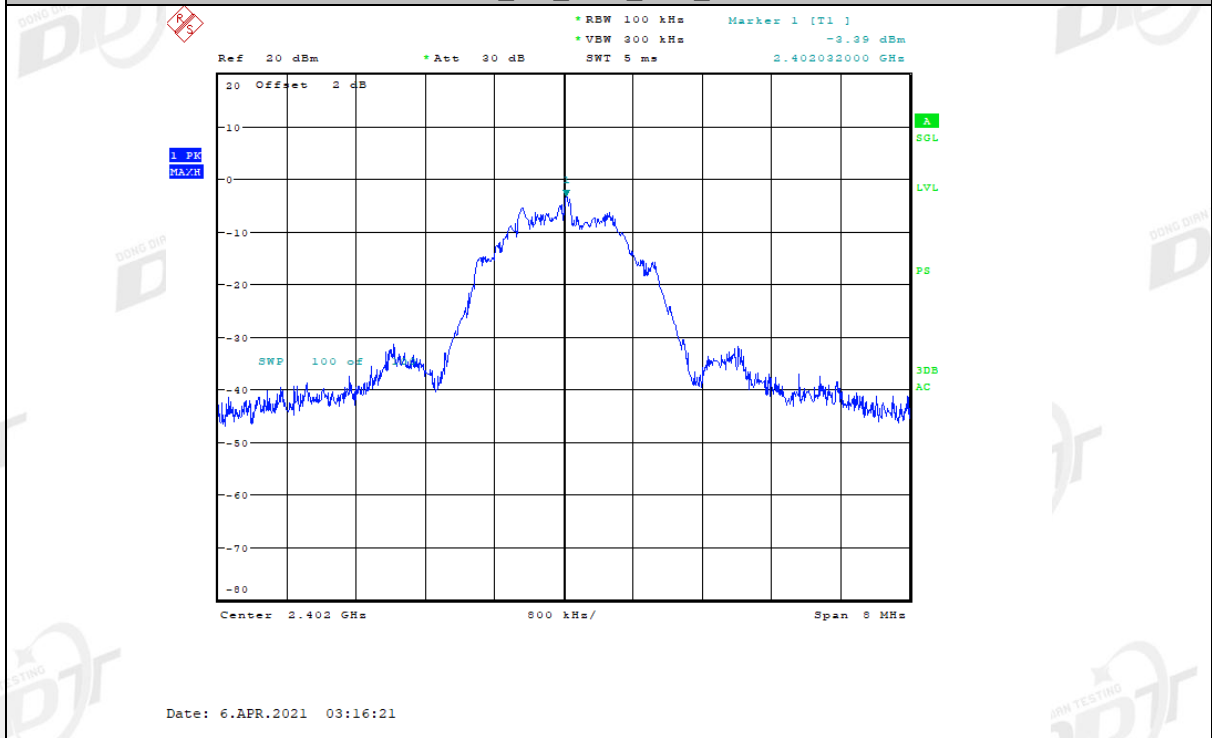

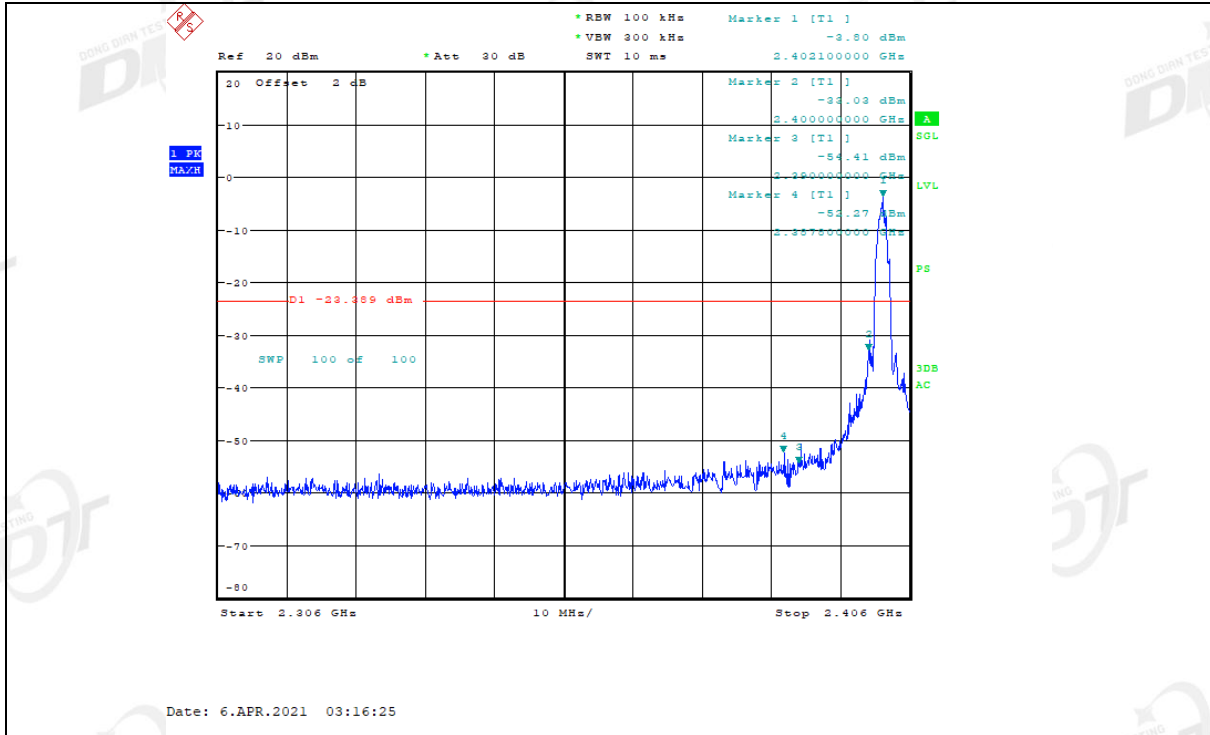

BLE_2M_Ant1_High_2480

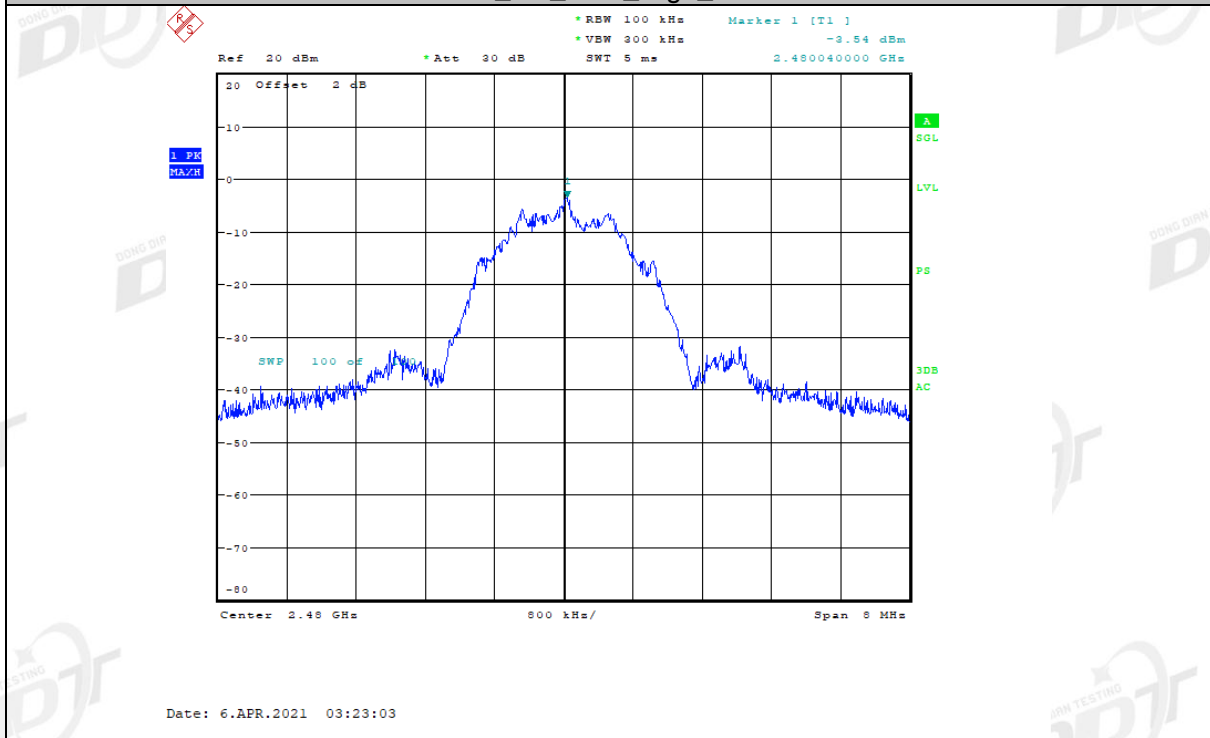

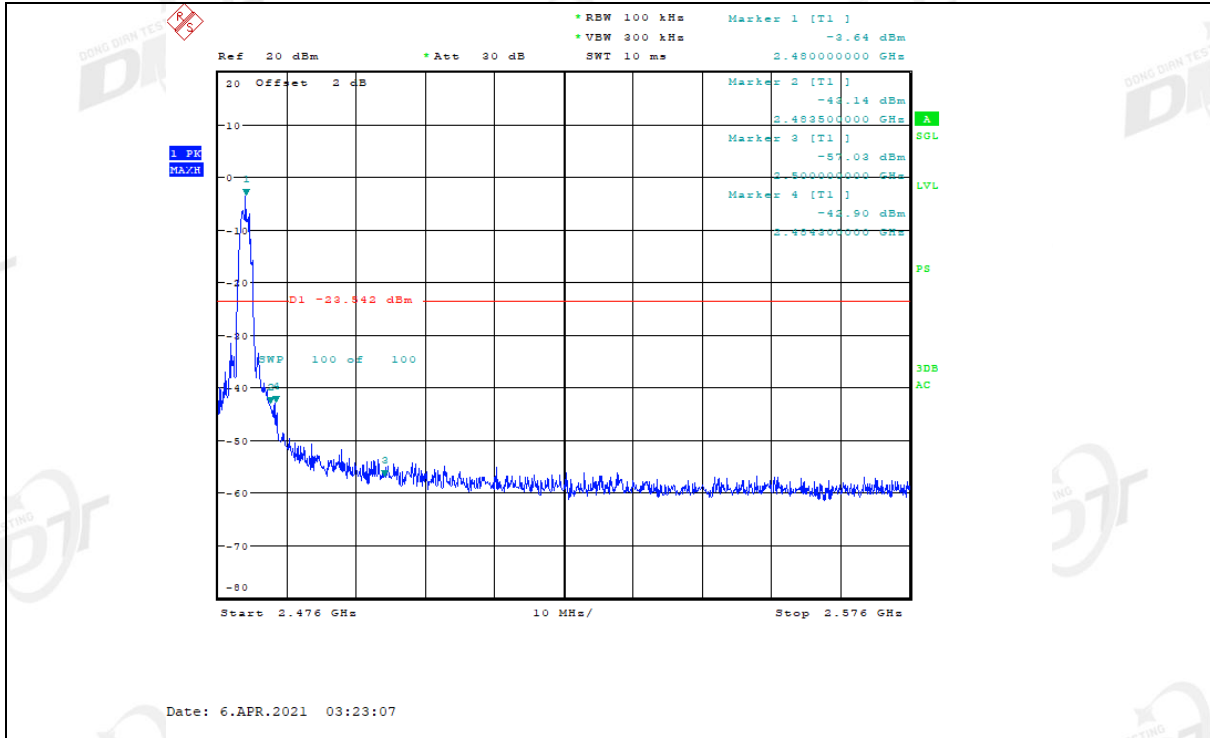

8. Radiated Emission

8.1. Block diagram of test setup

In 3 m Anechoic Chamber, test setup diagram for 9 kHz - 30 MHz:

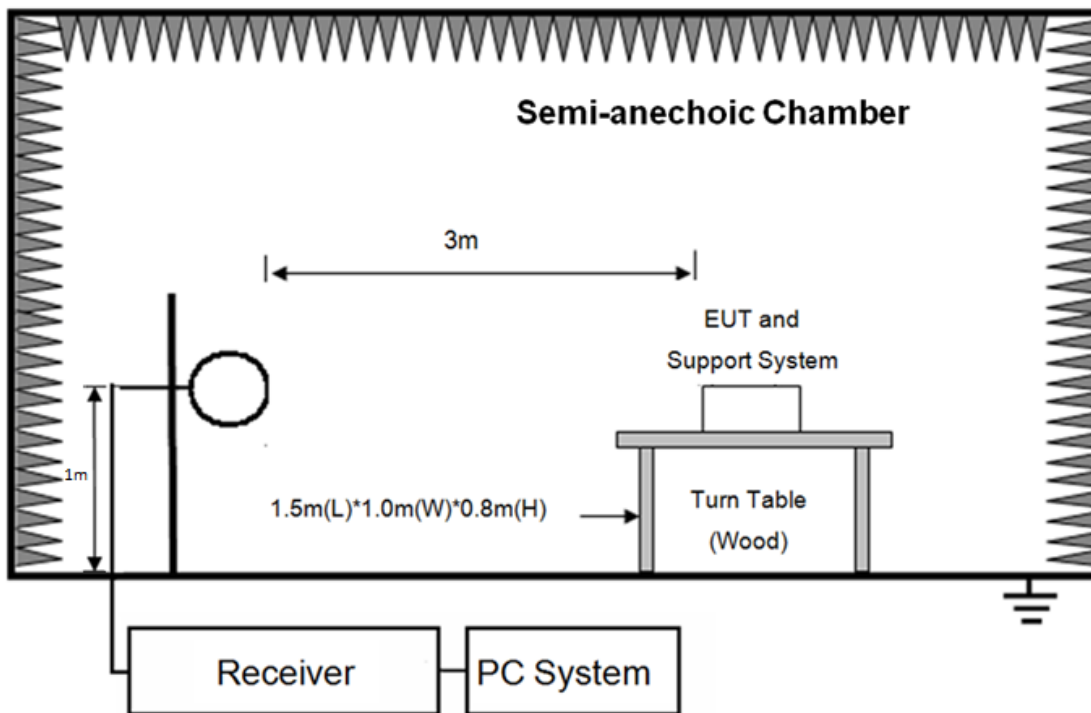

In 3 m Anechoic Chamber, test setup diagram for 30 MHz - 1 GHz:

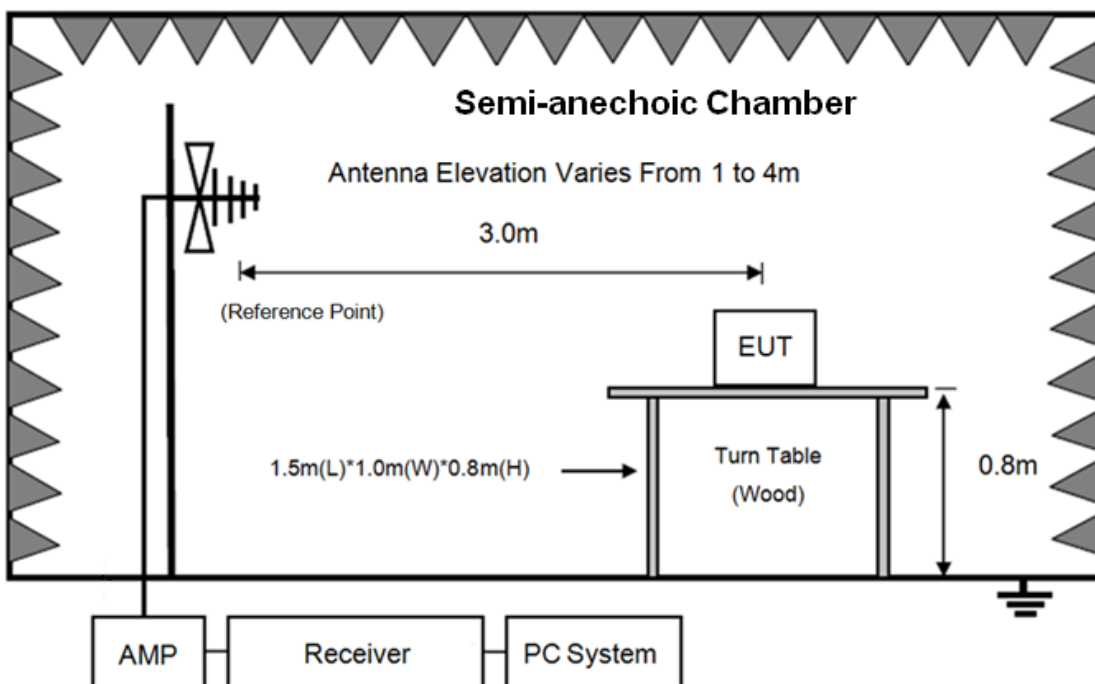

In 3 m Anechoic Chamber, test setup diagram for frequency above 1 GHz:

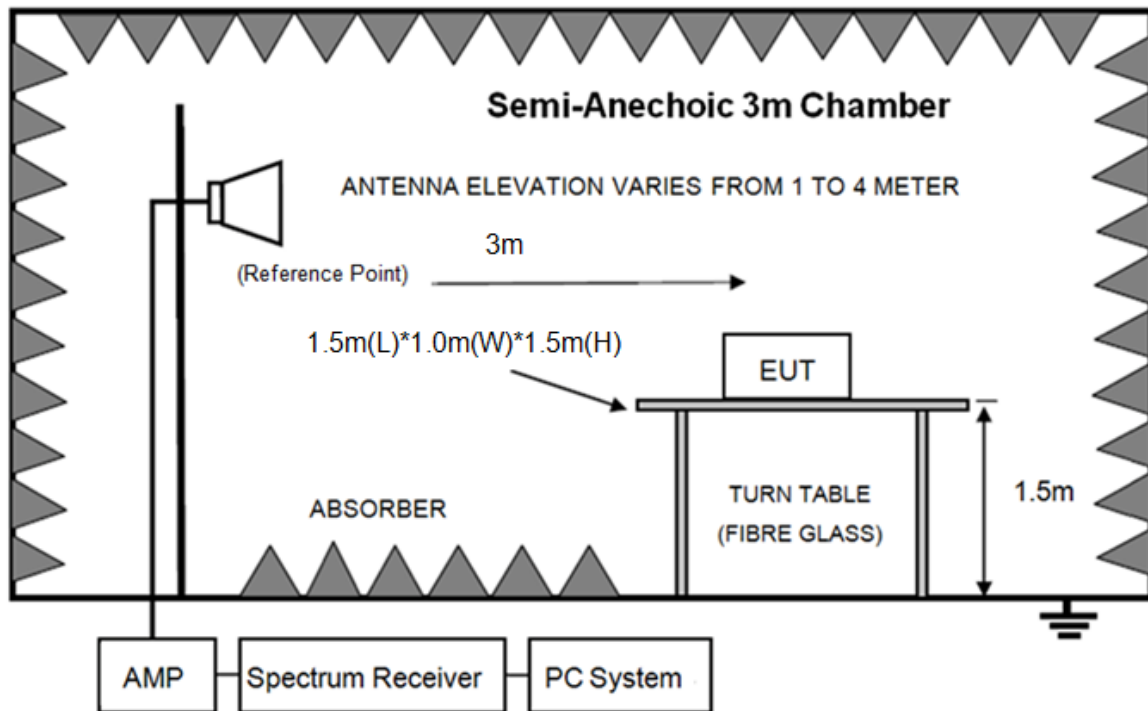

Note: For harmonic emissions test an appropriate high pass filter was inserted in the input port of AMP.

8.2. Limit

8.2.1 FCC 15.205 Restricted frequency band

MHz	MHz	MHz	GHz
0.090-0.110	16.42-16.423	399.9-410	4.5-5.15
¹ 0.495-0.505	16.69475-16.69525	608-614	5.35-5.46
2.1735-2.1905	16.80425-16.80475	960-1240	7.25-7.75
4.125-4.128	25.5-25.67	1300-1427	8.025-8.5
4.1772&4.1775	37.5-38.25	1435-1626.5	9.0-9.2
4.2072&4.2075	73-74.6	1645.5-1646.5	9.3-9.5
6.215-6.218	74.8-75.2	1660-1710	10.6-12.7
6.2675-6.26825	108-121.94	1718.8-1722.2	13.25-13.4
6.31175-6.31225	123-138	2200-2300	14.47-14.5
8.291-8.294	149.9-150.05	2310-2390	15.35-16.2
8.362-8.366	156.52475-156.52525	2483.5-2500	17.7-21.4
8.37625-8.38675	156.7-156.9	2690-2900	22.01-23.12
8.41425-8.41475	162.0125-167.17	3260-3267	23.6-24.0
12.29-12.293	167.72-173.2	3332-3339	31.2-31.8
12.51975-12.52025	240-285	3345.8-3358	36.43-36.5
12.57675-12.57725	322-335.4	3600-4400	(²)
13.36-13.41			

¹Until February 1, 1999, this restricted band shall be 0.490-0.510 MHz.

²Above 38.6

8.2.2 FCC 15.209 Limit.

FREQUENCY MHz	DISTANCE Meters	FIELD STRENGTHS LIMIT	
		$\mu\text{V}/\text{m}$	$\text{dB}(\mu\text{V})/\text{m}$
0.009 ~ 0.490	300	2400/F(kHz)	67.6-20log(F)
0.490 ~ 1.705	30	24000/F(kHz)	87.6-20log(F)
1.705 ~ 30.0	30	30	29.54
30 ~ 88	3	100	40.0
88 ~ 216	3	150	43.5
216 ~ 960	3	200	46.0
960 ~ 1000	3	500	54.0
Above 1000	3	74.0 $\text{dB}(\mu\text{V})/\text{m}$ (Peak) 54.0 $\text{dB}(\mu\text{V})/\text{m}$ (Average)	

Note: (1) The emission limits shown in the above table are based on measurements employing a CISPR QP detector except for the frequency bands 9 - 90 kHz, 110 - 490 kHz and above 1000 MHz. Radiated emissions limits in these three bands are based on measurements employing an average detector.

(2) At frequencies below 30 MHz, measurement may be performed at a distance closer than that specified, and the limit at closer measurement distance can be extrapolated by below formula:

$$\text{Limit}_{3\text{m}}(\text{dB}\mu\text{V}/\text{m}) = \text{Limit}_{30\text{m}}(\text{dB}\mu\text{V}/\text{m}) + 40\text{Log}(30\text{m}/3\text{m})$$

8.2.3 Limit for this EUT

All the emissions appearing within 15.205 restricted frequency bands shall not exceed the limits shown in 15.209, all the other emissions shall be at least 20 dB below the fundamental emissions or comply with 15.209 limits.

8.3. Test Procedure

(1) EUT was placed on a non-metallic table, 80 cm above the ground plane inside a semi-anechoic chamber for below 1 G and 150 cm above the ground plane inside a semi-anechoic chamber for above 1 G.

(2) Test antenna was located 3 m from the EUT on an adjustable mast, and the antenna used as below table.

Test frequency range	Test antenna used	Test antenna distance
9 kHz - 30 MHz	Active Loop antenna	3 m
30 MHz - 1 GHz	Trilog Broadband Antenna	3 m
1 GHz - 18 GHz	Double Ridged Horn Antenna (1 GHz - 18 GHz)	3 m
18 GHz - 40 GHz	Horn Antenna (18 GHz - 40 GHz)	1 m

According ANSI C63.10:2013 clause 6.4.4.2 and 6.5.3, for measurements below 30 MHz, the loop antenna was positioned with its plane vertical from the EUT and rotated about its vertical axis for maximum response at each azimuth position around the EUT. And the loop antenna also is positioned with its plane horizontal at the specified distance from the EUT. The center of the

loop is 1 m above the ground. For measurement above 30 MHz, the Trilog Broadband Antenna or Horn Antenna was located 3 m from EUT, Measurements were made with the antenna positioned in both the horizontal and vertical planes of Polarization, and the measurement antenna was varied from 1 m to 4 m. in height above the reference ground plane to obtain the maximum signal strength.

(3) Below pre-scan procedure was first performed in order to find prominent frequency spectrum radiated emissions from 9 kHz to 25 GHz:

(a) Scanning the peak frequency spectrum with the antenna specified in step (3), and the EUT was rotated 360 degree, the antenna height was varied from 1 m to 4 m (Except loop antenna, it's fixed 1 m above ground.)

(b) Change work frequency or channel of device if practicable.

(c) Change modulation type of device if practicable.

(d) Change power supply range from 85% to 115% of the rated supply voltage

(e) Rotated EUT though three orthogonal axes to determine the attitude of EUT arrangement produces highest emissions.

Spectrum frequency from 9 kHz to 25 GHz (tenth harmonic of fundamental frequency) was investigated, and no any obvious emission were detected from 9 kHz to 30 MHz and 18 GHz to 25 GHz, so below final test was performed with frequency range from 30 MHz to 18 GHz.

(4) For final emissions measurements at each frequency of interest, the EUT was rotated and the antenna height was varied between 1 m and 4 m in order to maximize the emission. Measurements in both horizontal and vertical polarities were made and the data was recorded. In order to find the maximum emission, the relative positions of equipments and all of the interface cables were changed according to ANSI C63.10:2013 on Radiated Emission test.

(5) The emissions from 9 kHz to 1 GHz were measured based on CISPR QP detector except for the frequency bands 9 - 90 kHz, 110 - 490 kHz, for emissions from 9 kHz - 90 kHz, 110 kHz - 490 kHz and above 1 GHz were measured based on average detector, for emissions above 1 GHz, peak emissions also be measured and need comply with Peak limit.

(6) The emissions from 9 kHz to 1 GHz, QP or average values were measured with EMI receiver with below RBW

Frequency band	RBW
9 kHz - 150 kHz	200 Hz
150 kHz - 30 MHz	9 kHz
30 MHz - 1 GHz	120 kHz

(7) For emissions above 1 GHz, both Peak and Average level were measured with Spectrum Analyzer, and the RBW is set at 1 MHz, VBW is set at 3 MHz for Peak measure; According ANSI C63.10:2013 clause 4.1.4.2.2 procedure for average measure.

(8) X axis, Y axis, Z axis are tested, and worse setup X axis is reported.

8.4. Test result

Pass. (See below detailed test result)

All the emissions except fundamental emission from 9 kHz to 25 GHz were comply with 15.209 limit.

Note1: According exploratory test, the emission levels are 20 dB below the limit detected from 9 kHz to 30 MHz and 18 GHz to 25 GHz, so the final test was performed with frequency range from 30 MHz to 18 GHz and recorded in below.

Note2: For emissions below 1 GHz, according exploratory explorer test, when change Tx channel, have no distinct influence on emissions level, so for emissions below 1 GHz, the final test was only performed with EUT working in GFSK 2M Tx 2402 MHz .

Note3: For emissions above 1 GHz. If peak results comply with AV limit, AV Result is deemed to comply with AV limit.

Radiated Emission test (below 1 GHz) TR-4-E-009 Radiated Emission Test Result

Test Site : DDT 3m Chamber 1#

Test Date : 2021-04-02

Tested By : Sunny

EUT : Sublue Smart Waterproof Phone Case

Model Number : H1+

Power Supply : Battery

Test Mode : Tx mode

Condition : Temp:24.5°C,Humi:55%,Press:100.1kPa

Memo : BLE 2M 2402MHz

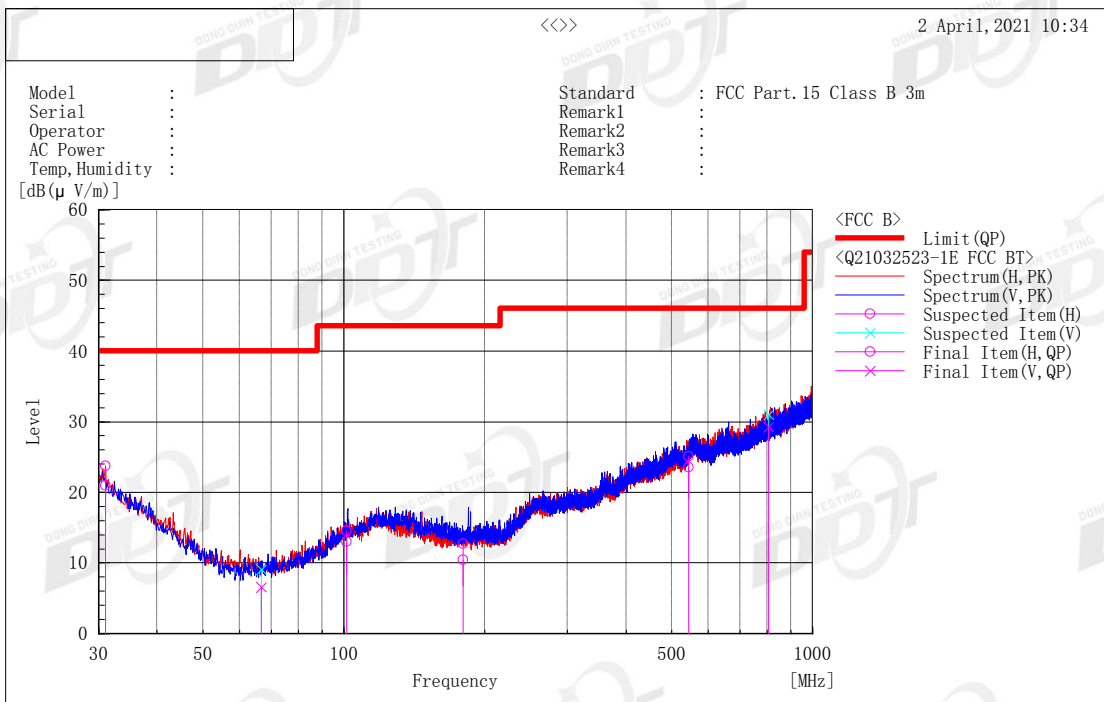

Final Result

No.	Frequency [MHz]	(P)	Reading QP [dB(μV)]	c. f [dB(1/m)]	Result QP [dB(μV/m)]	Limit QP [dB(μV/m)]	Margin QP [dB]	Height [cm]	Angle [°]	System	Remark
1	30.970	H	26.1	-5.1	21.0	40.0	19.0	201.0	137.9	1	
2	66.618	V	23.4	-16.8	6.6	40.0	33.4	400.0	278.2	2	
3	101.538	H	24.6	-11.6	13.0	43.5	30.5	100.0	354.1	1	
4	179.623	H	22.5	-12.1	10.4	43.5	33.1	100.0	17.9	1	
5	544.343	H	22.7	0.8	23.5	46.0	22.5	299.0	187.0	1	
6	804.424	V	24.8	4.5	29.3	46.0	16.7	400.0	332.5	2	

Note: 1. Result Level = Read Level + Antenna Factor + Cable loss.

2. If Peak Result complies with QP limit, QP Result is deemed to comply with QP limit.

3. Test setup: RBW: 120 kHz, VBW: 300 kHz, Sweep time: auto.

Radiated Emission test (above 1 GHz)

Freq. (MHz)	Read level (dB μ V)	Antenna Factor (dB/m)	PRM Factor (dB)	Cable Loss (dB)	Result Level (dB μ V/m)	Limit (dB μ V/m)	Margin (dB)	Detector type	Polarization
BLE 1M Tx mode 2402 MHz									
4804.00	48.63	32.51	0.00	-32.26	48.88	54.00	-5.12	Average	HORIZONTAL
4804.00	55.28	32.51	0.00	-32.26	55.53	74.00	-18.47	Peak	HORIZONTAL
7766.00	40.67	37.19	0.00	-31.87	45.99	74.00	-28.01	Peak	HORIZONTAL
10639.00	38.29	38.56	0.00	-30.33	46.52	74.00	-27.48	Peak	HORIZONTAL
13716.00	39.40	40.83	0.00	-29.55	50.68	74.00	-23.32	Peak	HORIZONTAL
17014.00	37.06	42.22	0.00	-27.56	51.72	74.00	-22.28	Peak	HORIZONTAL
4804.00	45.05	32.51	0.00	-32.26	45.30	74.00	-28.70	Peak	VERTICAL
8990.00	43.62	37.69	0.00	-31.51	49.80	74.00	-24.20	Peak	VERTICAL
11659.00	39.29	38.67	0.00	-29.40	48.56	74.00	-25.44	Peak	VERTICAL
13801.00	39.70	41.00	0.00	-29.65	51.05	74.00	-22.95	Peak	VERTICAL
15195.00	37.12	38.69	0.00	-28.56	47.25	74.00	-26.75	Peak	VERTICAL
17286.00	38.42	42.60	0.00	-28.10	52.92	74.00	-21.08	Peak	VERTICAL
BLE 1M Tx mode 2440 MHz									
4880.00	48.32	32.66	0.00	-32.48	48.50	54.00	-5.50	Average	HORIZONTAL
4880.00	54.87	32.66	0.00	-32.48	55.05	74.00	-18.95	Peak	HORIZONTAL
7460.00	40.62	37.34	0.00	-31.78	46.18	74.00	-27.82	Peak	HORIZONTAL
11625.00	38.93	38.67	0.00	-29.29	48.31	74.00	-25.69	Peak	HORIZONTAL
13920.00	39.42	41.24	0.00	-29.38	51.28	74.00	-22.72	Peak	HORIZONTAL
17031.00	36.67	42.24	0.00	-27.70	51.21	74.00	-22.79	Peak	HORIZONTAL
4876.00	41.18	32.65	0.00	-32.47	41.36	74.00	-32.64	Peak	VERTICAL
5981.00	43.45	35.24	0.00	-32.58	46.11	74.00	-27.89	Peak	VERTICAL
8990.00	44.99	37.69	0.00	-31.51	51.17	74.00	-22.83	Peak	VERTICAL
11744.00	38.73	38.65	0.00	-29.64	47.74	74.00	-26.26	Peak	VERTICAL
13614.00	40.14	40.63	0.00	-29.81	50.96	74.00	-23.04	Peak	VERTICAL
17150.00	36.96	42.41	0.00	-28.17	51.20	74.00	-22.80	Peak	VERTICAL
BLE 1M Tx mode 2480 MHz									
4960.00	49.25	32.82	0.00	-32.18	49.89	54.00	-4.11	Average	HORIZONTAL
4960.00	55.44	32.82	0.00	-32.18	56.08	74.00	-17.92	Peak	HORIZONTAL
6780.00	41.65	36.25	0.00	-31.98	45.92	74.00	-28.08	Peak	HORIZONTAL
8990.00	40.78	37.69	0.00	-31.51	46.96	74.00	-27.04	Peak	HORIZONTAL
14124.00	38.93	41.23	0.00	-29.12	51.04	74.00	-22.96	Peak	HORIZONTAL
16929.00	36.92	41.86	0.00	-27.72	51.06	74.00	-22.94	Peak	HORIZONTAL
4960.00	41.85	32.82	0.00	-32.18	42.49	74.00	-31.51	Peak	VERTICAL
8990.00	44.86	37.69	0.00	-31.51	51.04	74.00	-22.96	Peak	VERTICAL
12186.00	38.74	38.60	0.00	-29.76	47.58	74.00	-26.42	Peak	VERTICAL
13869.00	39.37	41.14	0.00	-29.49	51.02	74.00	-22.98	Peak	VERTICAL
15756.00	38.07	38.35	0.00	-28.33	48.09	74.00	-25.91	Peak	VERTICAL
17439.00	37.41	42.81	0.00	-28.46	51.76	74.00	-22.24	Peak	VERTICAL
BLE 2M Tx mode 2402 MHz									
4804.00	53.87	32.51	0.00	-32.26	54.12	74.00	-19.88	Peak	HORIZONTAL
7239.00	40.14	36.98	0.00	-31.90	45.22	74.00	-28.78	Peak	HORIZONTAL
8990.00	41.21	37.69	0.00	-31.51	47.39	74.00	-26.61	Peak	HORIZONTAL

11761.00	38.58	38.65	0.00	-29.67	47.56	74.00	-26.44	Peak	HORIZONTAL
14005.00	38.19	41.39	0.00	-29.23	50.35	74.00	-23.65	Peak	HORIZONTAL
16946.00	37.10	41.94	0.00	-27.66	51.38	74.00	-22.62	Peak	HORIZONTAL
4804.00	42.64	32.51	0.00	-32.26	42.89	74.00	-31.11	Peak	VERTICAL
7749.00	41.00	37.20	0.00	-31.81	46.39	74.00	-27.61	Peak	VERTICAL
8990.00	44.17	37.69	0.00	-31.51	50.35	74.00	-23.65	Peak	VERTICAL
10996.00	39.74	38.70	0.00	-30.06	48.38	74.00	-25.62	Peak	VERTICAL
14090.00	38.34	41.27	0.00	-29.20	50.41	74.00	-23.59	Peak	VERTICAL
17065.00	36.77	42.29	0.00	-27.99	51.07	74.00	-22.93	Peak	VERTICAL
BLE 2M Tx mode 2440 MHz									
4880.00	47.54	32.66	0.00	-32.48	47.72	54.00	-6.28	Peak	HORIZONTAL
4880.00	53.33	32.66	0.00	-32.48	53.51	74.00	-20.49	Peak	HORIZONTAL
7341.00	39.66	37.15	0.00	-31.53	45.28	74.00	-28.72	Peak	HORIZONTAL
8990.00	41.22	37.69	0.00	-31.51	47.40	74.00	-26.60	Peak	HORIZONTAL
11999.00	38.69	38.60	0.00	-29.66	47.63	74.00	-26.37	Peak	HORIZONTAL
14039.00	38.59	41.35	0.00	-29.22	50.72	74.00	-23.28	Peak	HORIZONTAL
4880.00	41.46	32.66	0.00	-32.48	41.64	74.00	-32.36	Peak	VERTICAL
5981.00	42.80	35.24	0.00	-32.58	45.46	74.00	-28.54	Peak	VERTICAL
7749.00	41.59	37.20	0.00	-31.81	46.98	74.00	-27.02	Peak	VERTICAL
8990.00	43.34	37.69	0.00	-31.51	49.52	74.00	-24.48	Peak	VERTICAL
11676.00	39.18	38.66	0.00	-29.46	48.38	74.00	-25.62	Peak	VERTICAL
13716.00	38.86	40.83	0.00	-29.55	50.14	74.00	-23.86	Peak	VERTICAL
BLE 2M Tx mode 2480 MHz									
4960.00	46.52	32.82	0.00	-32.18	47.16	54.00	-6.84	Average	HORIZONTAL
4960.00	55.22	32.82	0.00	-32.18	55.86	74.00	-18.14	Peak	HORIZONTAL
7596.00	40.04	37.32	0.00	-31.96	45.40	74.00	-28.60	Peak	HORIZONTAL
7596.00	40.04	37.32	0.00	-31.96	45.40	74.00	-28.60	Peak	HORIZONTAL
9534.00	40.42	38.02	0.00	-31.10	47.34	74.00	-26.66	Peak	HORIZONTAL
12594.00	38.84	38.77	0.00	-30.26	47.35	74.00	-26.65	Peak	HORIZONTAL
4960.00	41.51	32.82	0.00	-32.18	42.15	74.00	-31.85	Peak	VERTICAL
5981.00	43.55	35.24	0.00	-32.58	46.21	74.00	-27.79	Peak	VERTICAL
8990.00	45.19	37.69	0.00	-31.51	51.37	74.00	-22.63	Peak	VERTICAL
11591.00	38.76	38.68	0.00	-29.25	48.19	74.00	-25.81	Peak	VERTICAL
14056.00	39.45	41.32	0.00	-29.21	51.56	74.00	-22.44	Peak	VERTICAL
17439.00	38.12	42.81	0.00	-28.46	52.47	74.00	-21.53	Peak	VERTICAL
Verdict: Pass									

Note: 1. Result Level = Read Level + Antenna Factor + Cable loss - PRM Factor.

2. For emissions above 1 GHz. If peak results comply with AV limit, AV Result is deemed to comply with AV limit.

9. RF Conducted Spurious Emissions

9.1. Block diagram of test setup

Same as section 4.1

9.2. Limits

In any 100 kHz bandwidth outside the frequency bands in which the spread spectrum intentional radiator is operating, the radio frequency power that is produced by the intentional radiator shall be at least 20 dB below that in the 100 kHz bandwidth within the band that contains the highest level of the desired power.

9.3. Test procedure

(1) Connect EUT's antenna output to spectrum analyzer by RF cable.

(2) Establish a reference level by using the following procedure:

Center frequency	Test frequency
RBW:	100 kHz
VBW:	300 kHz
Span	Wide enough to capture the peak level of the in-band emission
Detector Mode:	Peak
Sweep time:	auto
Trace mode	Max hold

(3) Allow the trace to stabilize, use the peak marker function to determine the maximum peak power level to establish the reference level.

(4) Set the spectrum analyzer as follows:

RBW:	100 kHz
VBW:	300 kHz
Span	Encompass frequency range to be measured
Number of measurement points	$\geq \text{span}/\text{RBW}$
Detector Mode:	Peak
Sweep time:	auto
Trace mode	Max hold

(5) Allow the trace to stabilize, use the peak marker function to determine the maximum amplitude of all unwanted emissions outside of the authorized frequency band

9.4. Test result

Mode	Freq. (MHz)	Verdict
GFSK (1M)	2402	Pass
	2440	Pass
	2480	Pass
GFSK (2M)	2402	Pass
	2440	Pass
	2480	Pass

9.5. Original test data

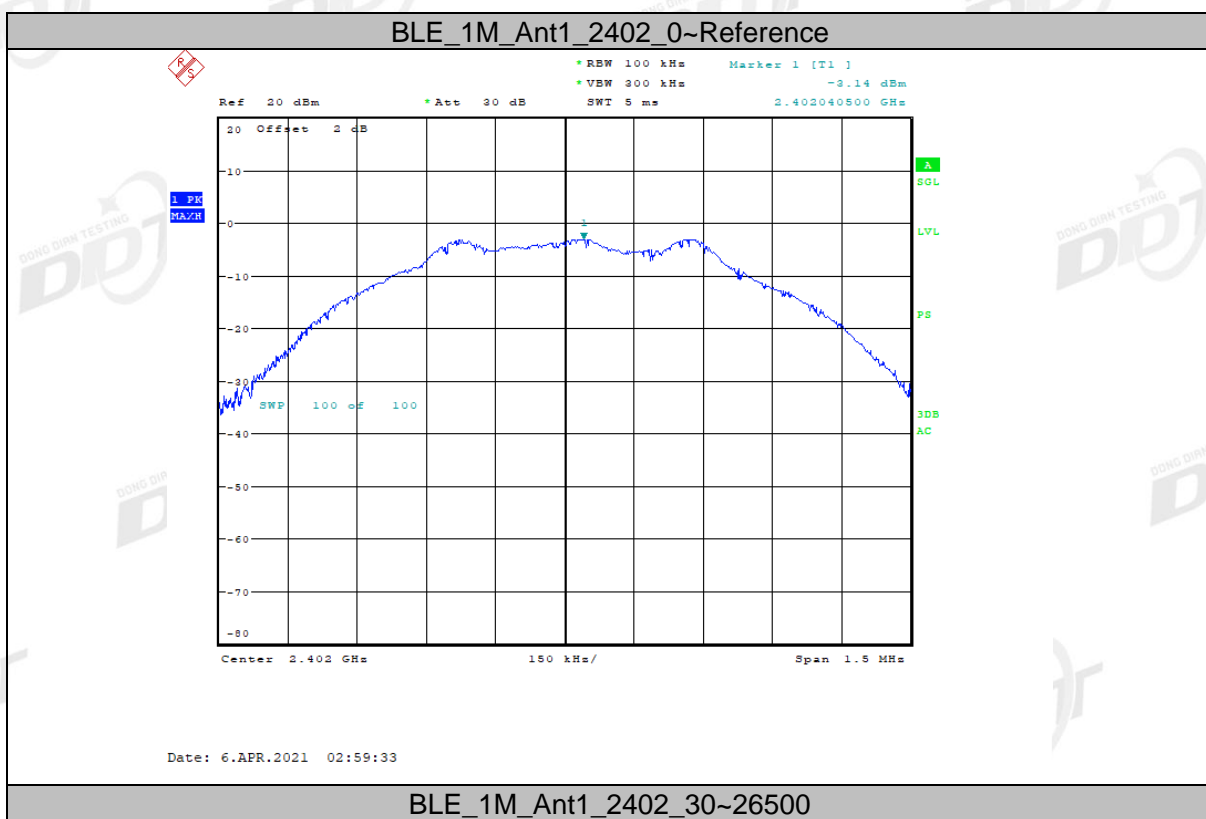

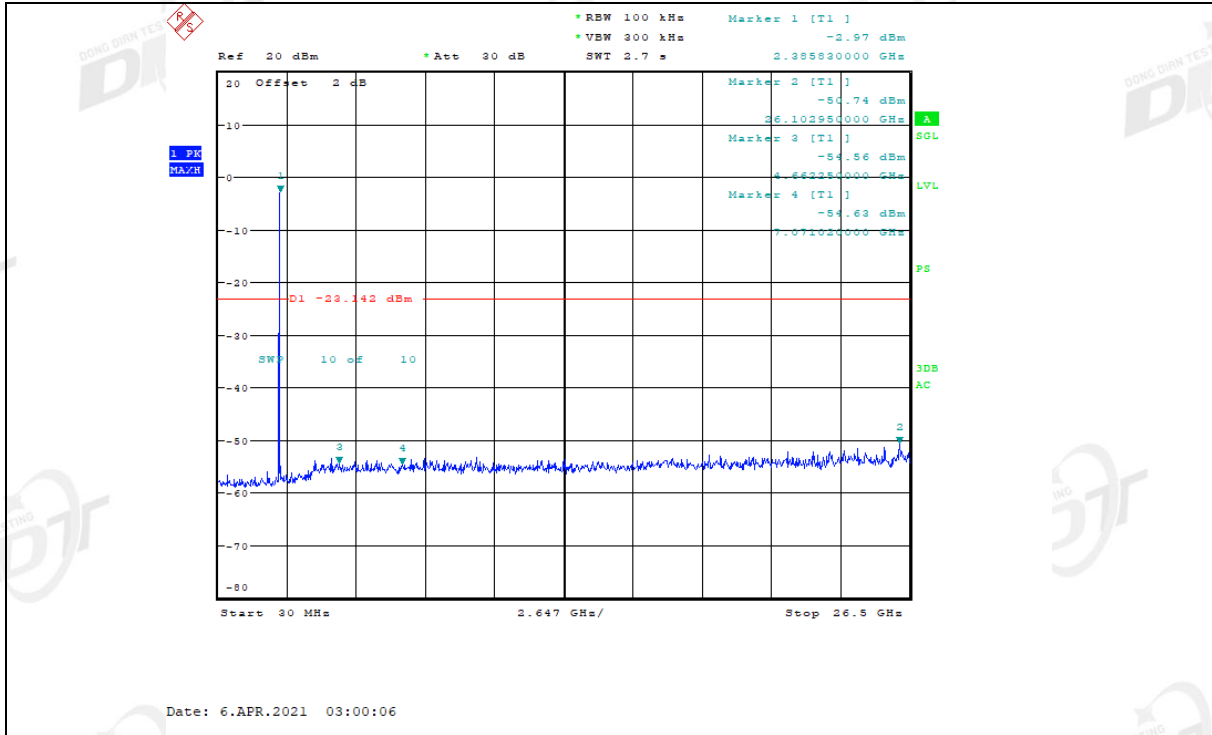

BLE_1M_Ant1_2440_0-Reference

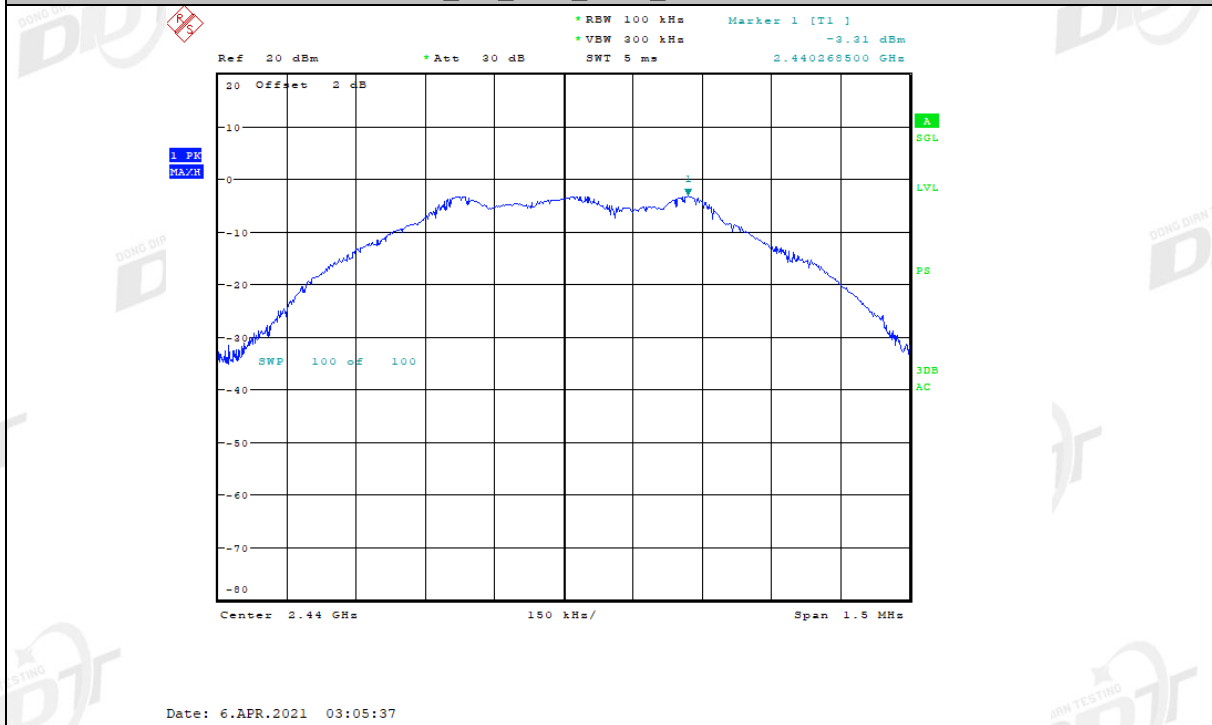

BLE_1M_Ant1_2440_30~26500

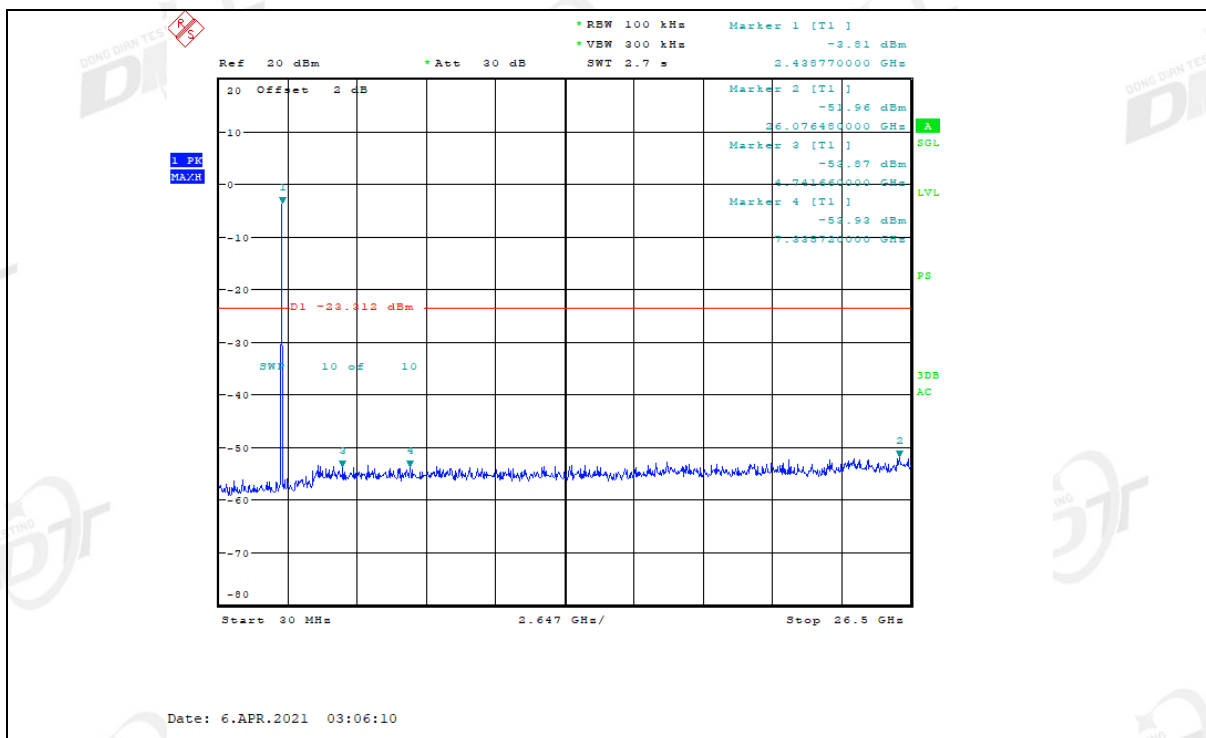

BLE_1M_Ant1_2480_0-Reference

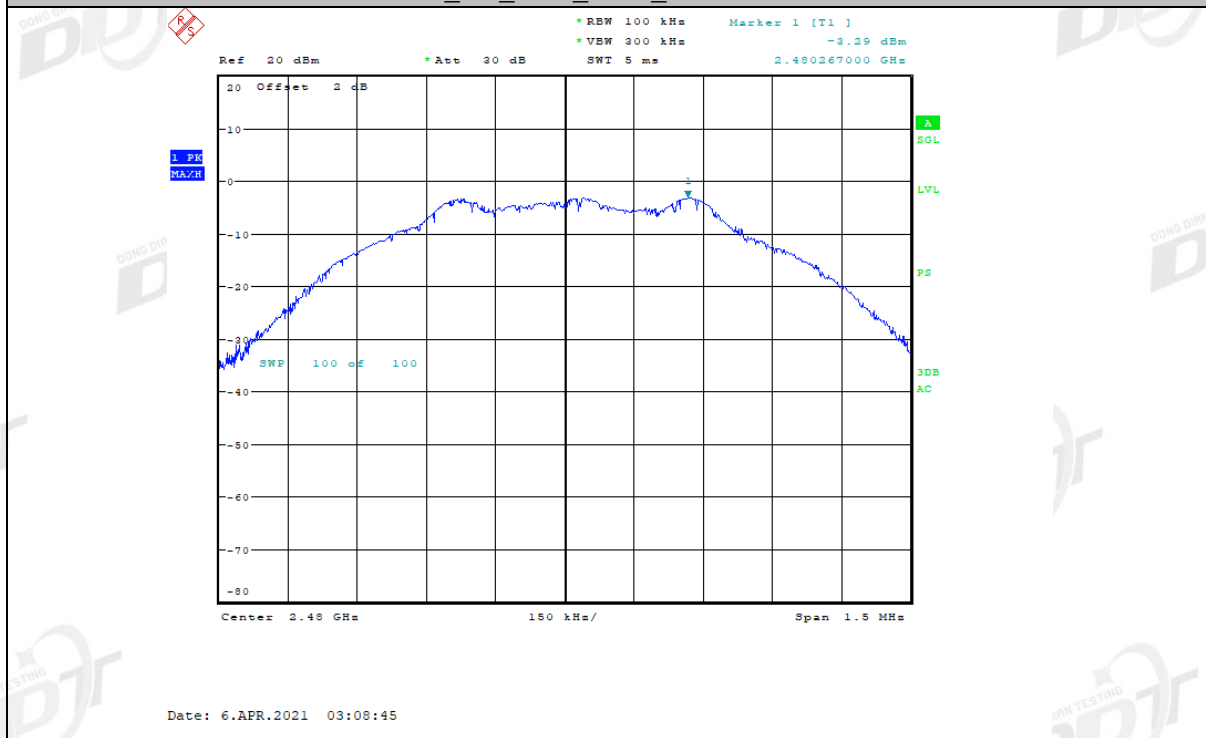

BLE_1M_Ant1_2480_30~26500

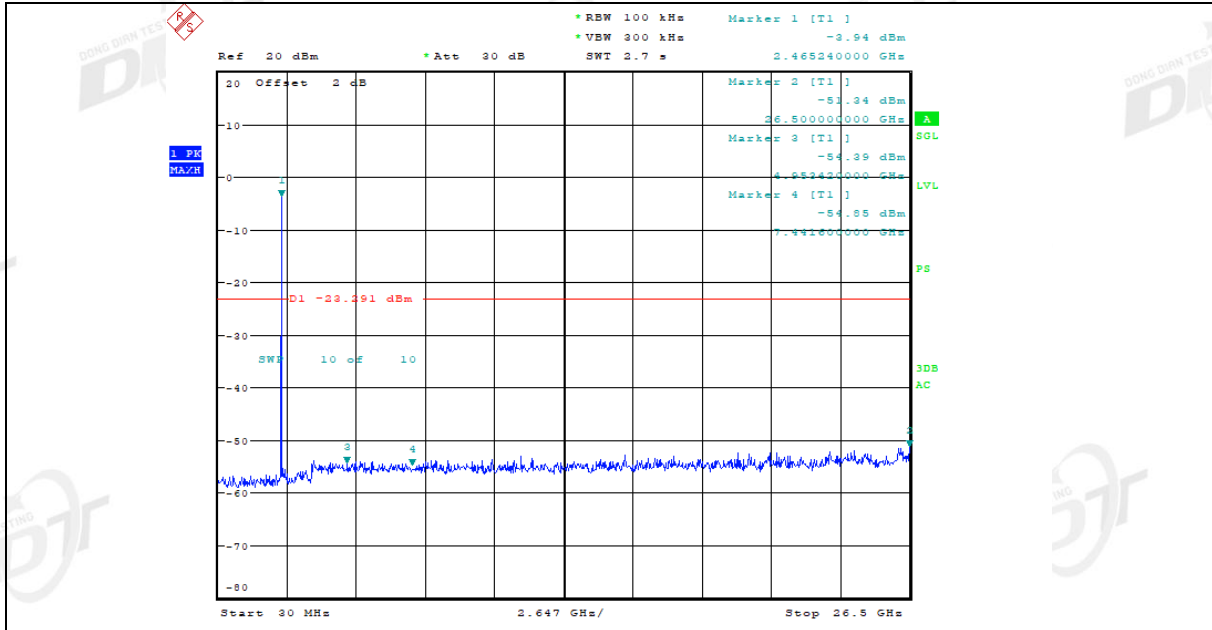

Date: 6.APR.2021 03:09:18

BLE_2M_Ant1_2402_0-Reference

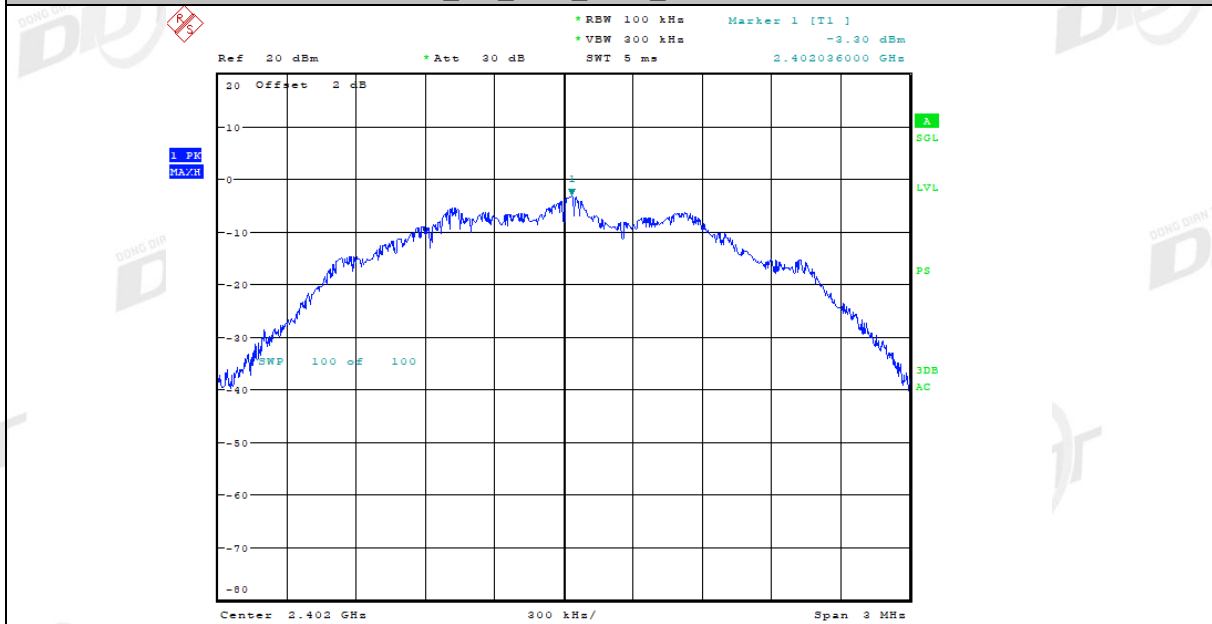

Date: 6.APR.2021 03:16:34

BLE_2M_Ant1_2402_30~26500

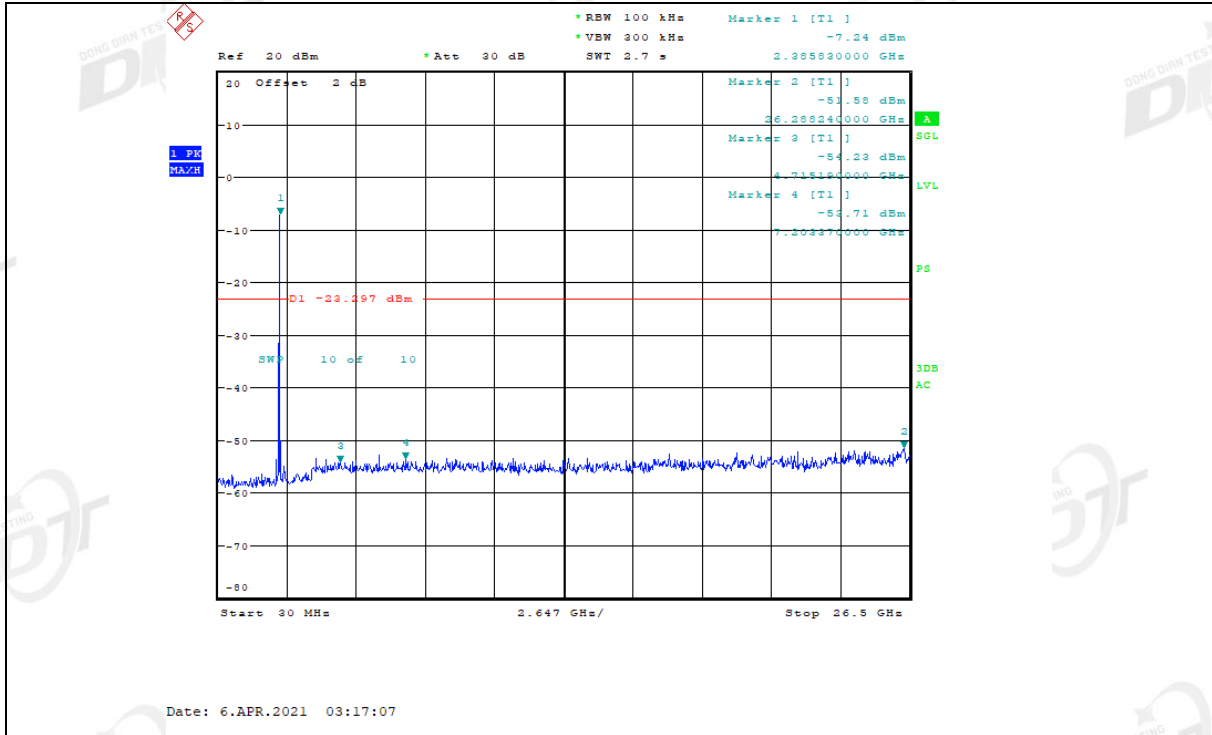

BLE_2M_Ant1_2440_0-Reference

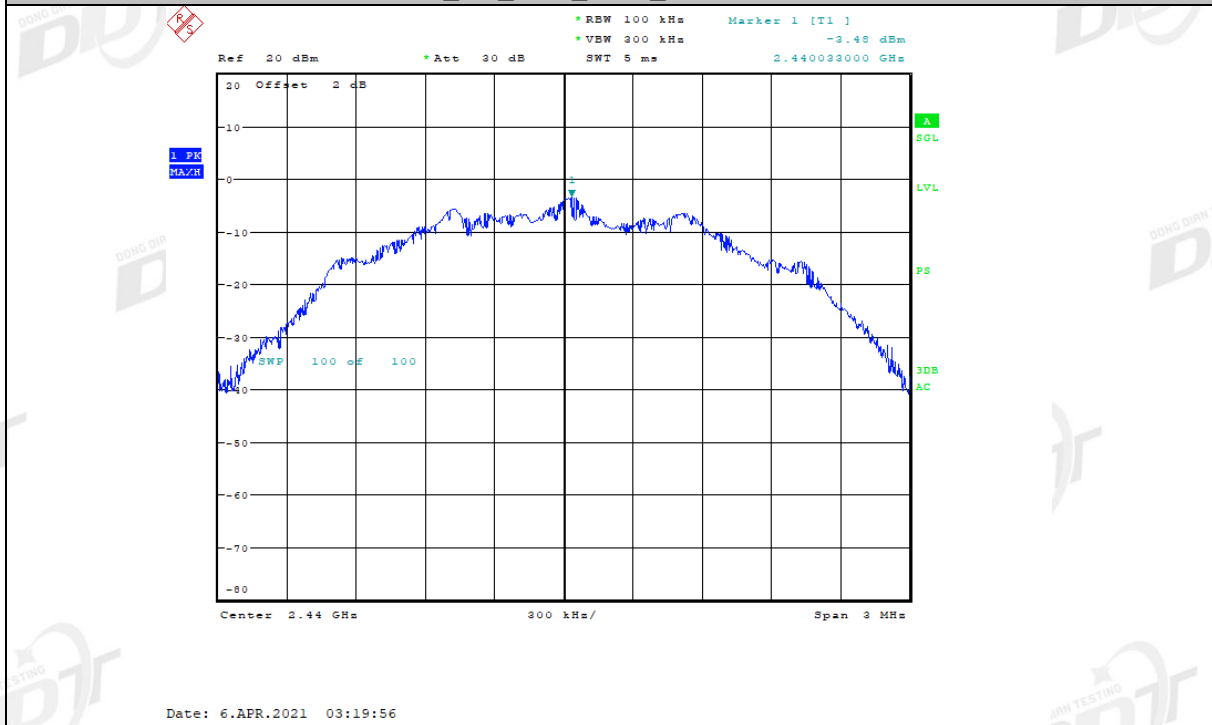

BLE_2M_Ant1_2440_30~26500

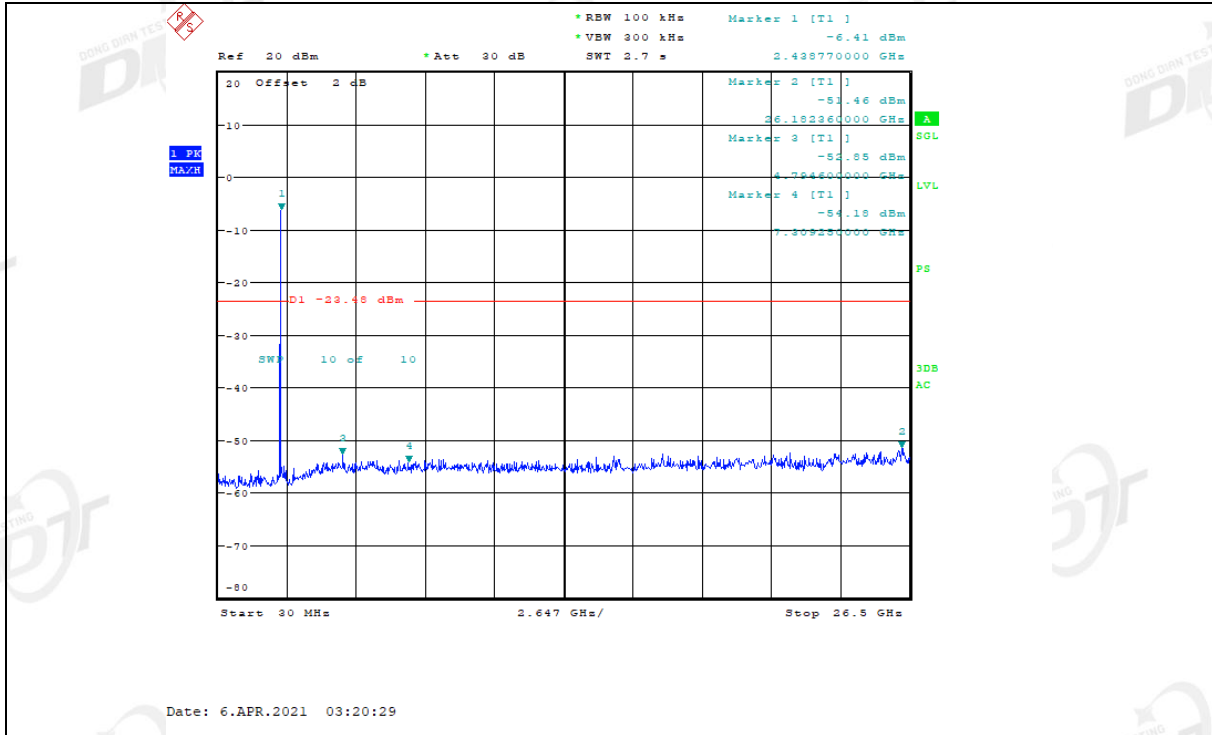

BLE_2M_Ant1_2480_0-Reference

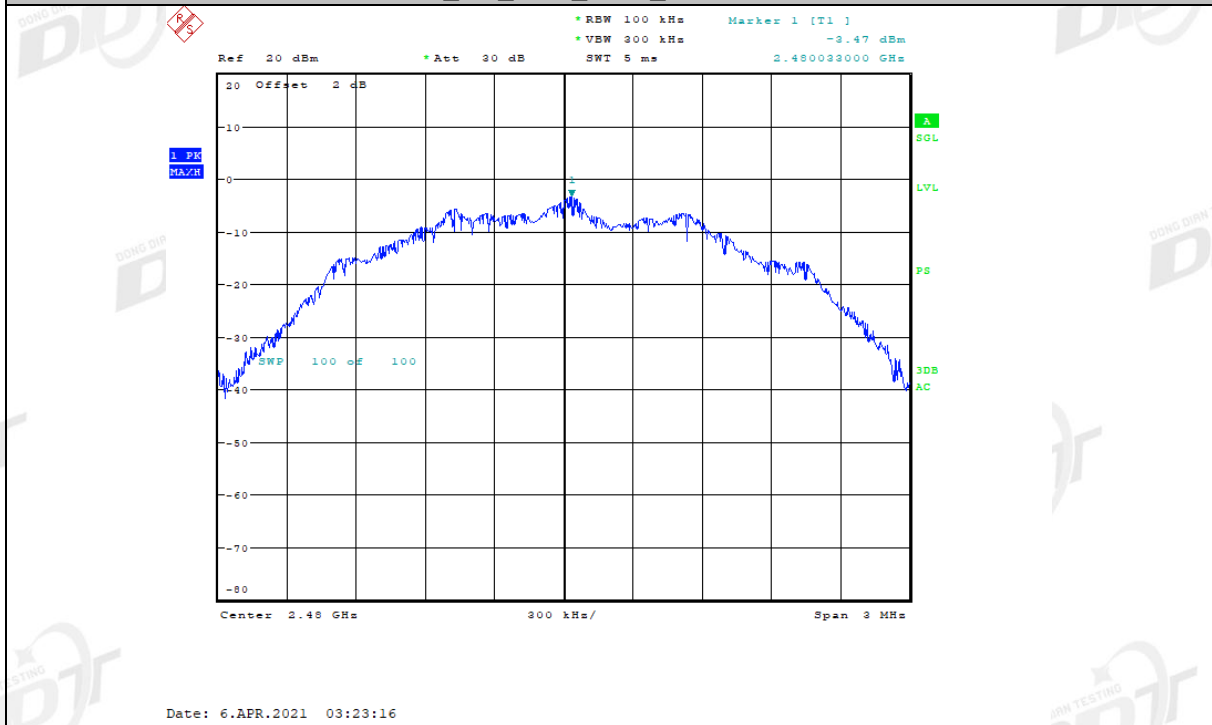

BLE_2M_Ant1_2480_30~26500

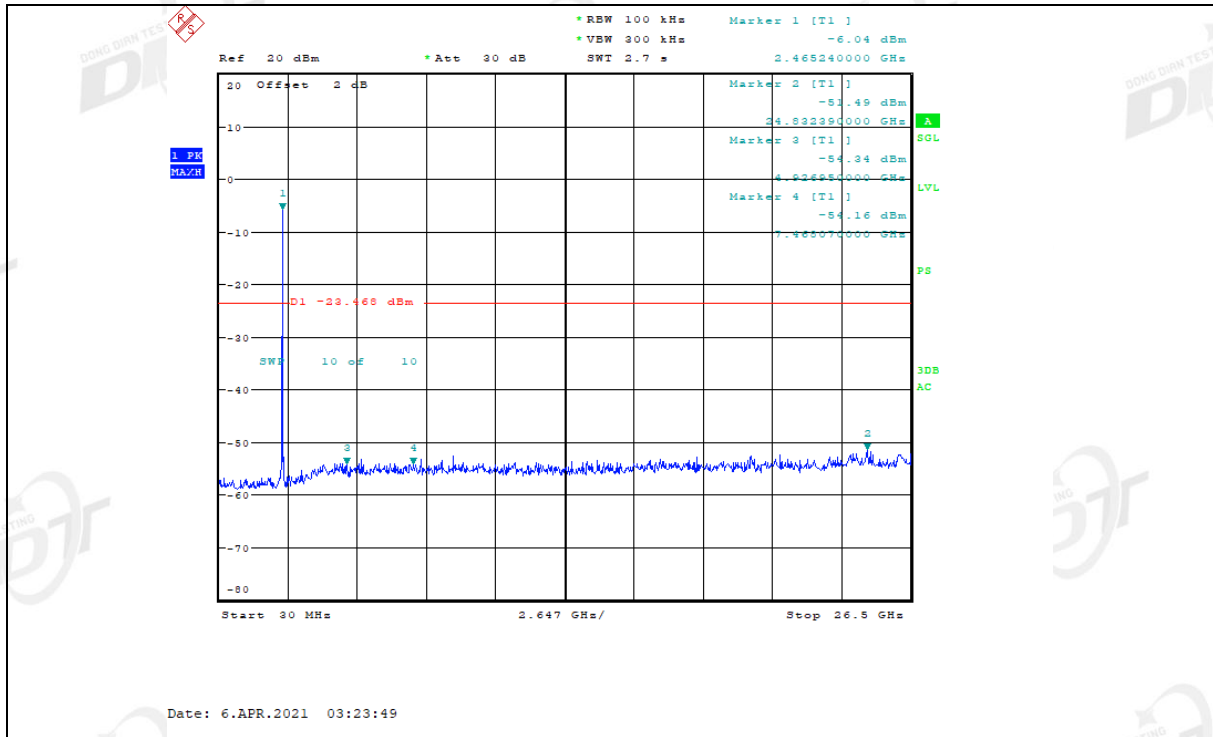

10. Emissions in Restricted Frequency Bands

10.1. Block diagram of test setup

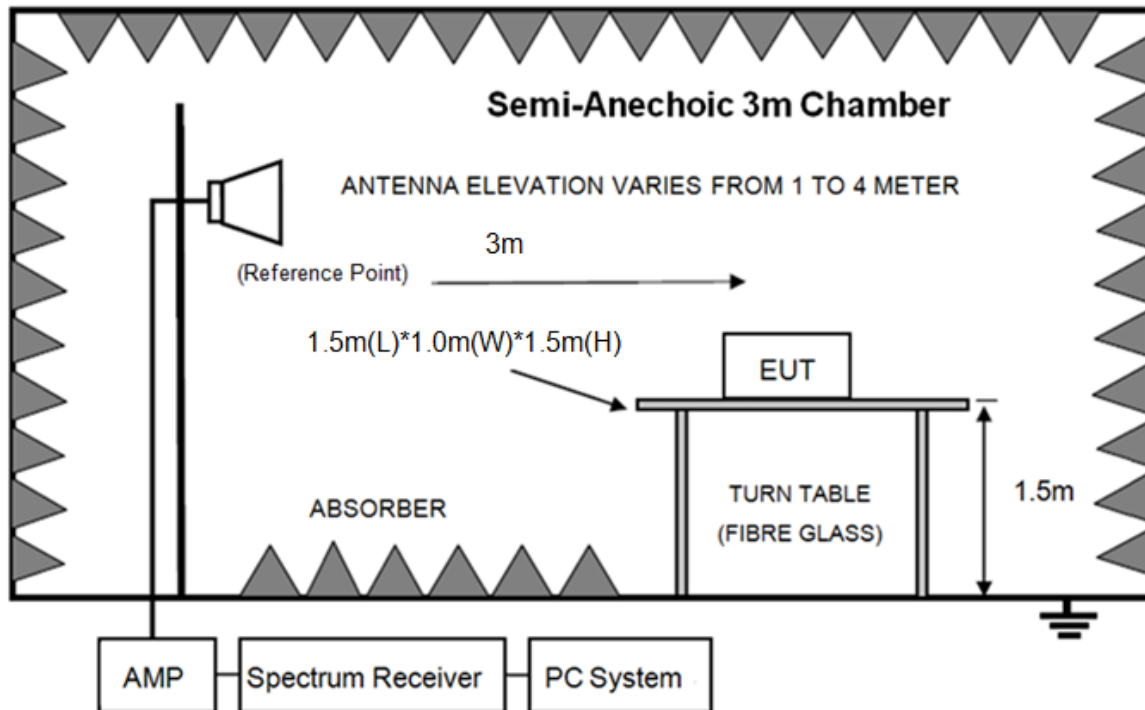

10.2. Limit

All restriction band should comply with 15.209, other emission should be at least 20 dB below the fundamental.

10.3. Test Procedure

Same with clause 8.3 except change investigated frequency range from 2310 MHz to 2410 MHz and 2475 MHz to 2500 MHz.

Remark: All restriction band have been tested, and only the worst case is shown in report.

10.4. Test result

Pass. (See below detailed test result)

TR-4-E-009 Radiated Emission Test Result

Test Site : DDT 3m Chamber 2#

Test Date : 04-09-2021

Tested By : Sunny

EUT : Smart Waterproof phone case

Model Number : H1+

Power Supply : Battery

Test Mode : Tx mode

Condition : Temp:24.5°C,Humi:55%,Press:100.1kPa

Distance : 3m/VERTICAL

Memo : BLE1M 2402MHz

Data: 1

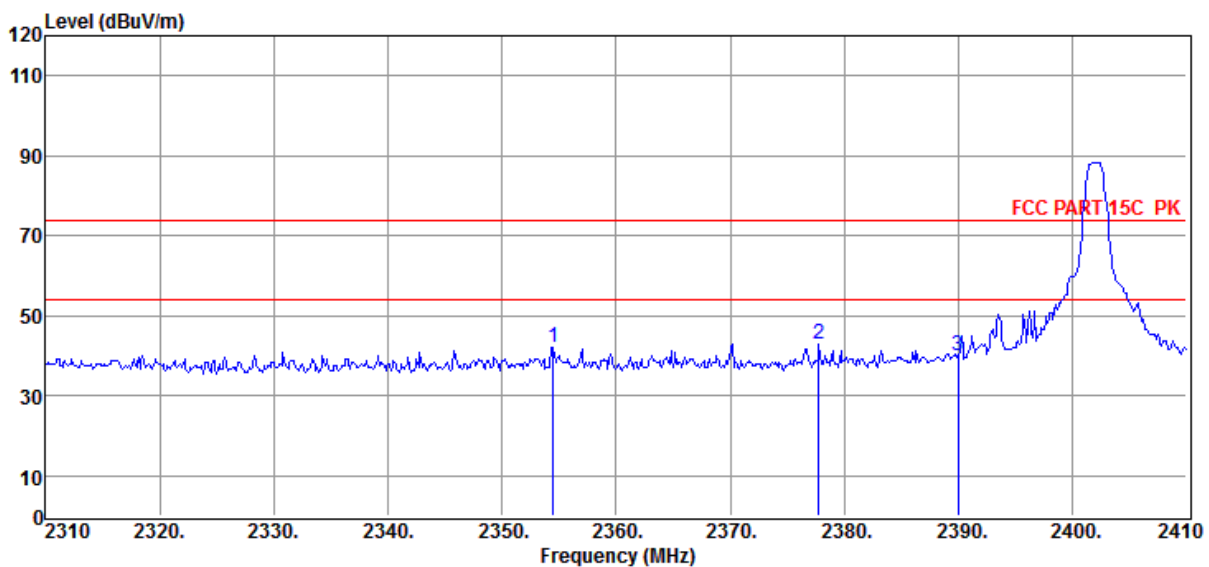

Item (Mark)	Freq. (MHz)	Read Level (dB μ V)	Antenna Factor (dB/m)	PRM Factor dB	Cable Loss dB	Result Level (dB μ V/m)	Limit Line (dB μ V/m)	Over Limit (dB)	Detector	Polarization
1	2354.50	48.10	28.10	0.00	-33.97	42.23	74.00	-31.77	Peak	VERTICAL
2	2377.80	48.82	28.07	0.00	-33.99	42.90	74.00	-31.10	Peak	VERTICAL
3	2390.00	45.99	28.05	0.00	-34.02	40.02	74.00	-33.98	Peak	VERTICAL

Note: 1. Result Level = Read Level + Antenna Factor + Cable loss - PRM Factor.

2. If Peak Result complies with AV limit, AV Result is deemed to comply with AV limit.

3. Test setup: RBW: 1 MHz, VBW: 3 MHz, Sweep time: auto.

TR-4-E-009 Radiated Emission Test Result

Test Site : DDT 3m Chamber 2#

Test Date : 04-09-2021

Tested By : Sunny

EUT : Smart Waterproof phone case

Model Number : H1+

Power Supply : Battety

Test Mode : Tx mode

Condition : Temp:24.5°C,Humi:55%,Press:100.1kPa

Distance : 3m/HORIZONTAL

Memo : BLE1M 2402MHz

Data: 2

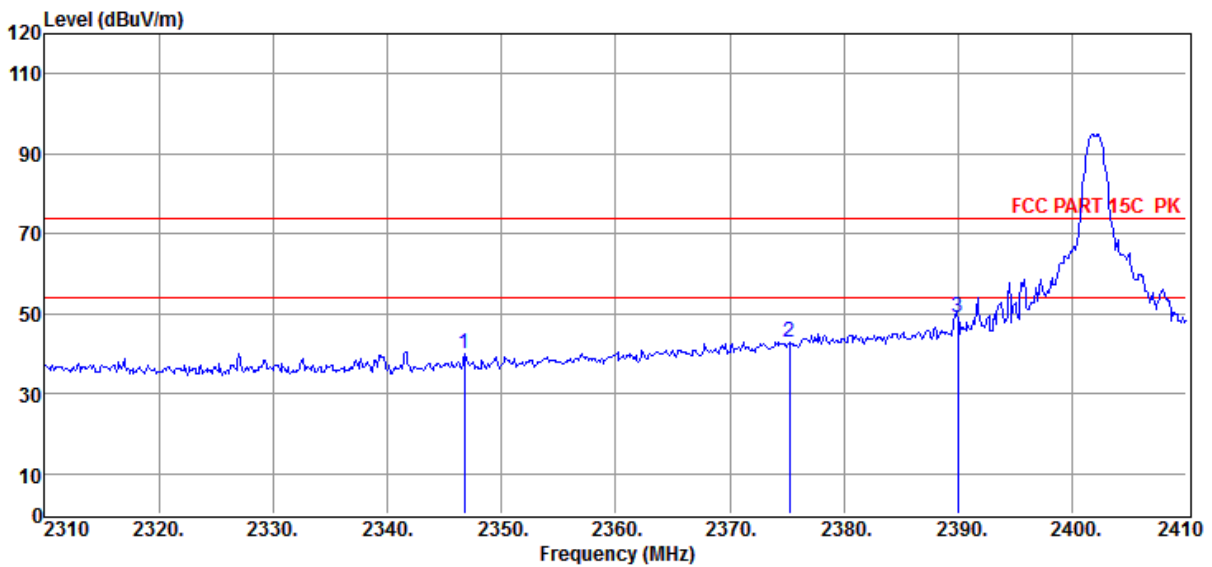

Item (Mark)	Freq. (MHz)	Read Level (dBuV)	Antenna Factor (dB/m)	PRM Factor dB	Cable Loss dB	Result Level (dBuV/m)	Limit Line (dBuV/m)	Over Limit (dB)	Detector	Polarization
1	2346.80	45.79	28.11	0.00	-33.96	39.94	74.00	-34.06	Peak	HORIZONTAL
2	2375.20	48.82	28.07	0.00	-33.99	42.90	74.00	-31.10	Peak	HORIZONTAL
3	2390.00	55.11	28.05	0.00	-34.02	49.14	74.00	-24.86	Peak	HORIZONTAL

Note: 1. Result Level = Read Level + Antenna Factor + Cable loss - PRM Factor.

2. If Peak Result complies with AV limit, AV Result is deemed to comply with AV limit.

3. Test setup: RBW: 1 MHz, VBW: 3 MHz, Sweep time: auto.

TR-4-E-009 Radiated Emission Test Result

Test Site : DDT 3m Chamber 2#

Test Date : 04-09-2021

Tested By : Sunny

EUT : Smart Waterproof phone case

Model Number : H1+

Power Supply : Battety

Test Mode : Tx mode

Condition : Temp:24.5°C,Humi:55%,Press:100.1kPa

Distance : 3m/HORIZONTAL

Memo : BLE1M 2480MHz

Data: 9

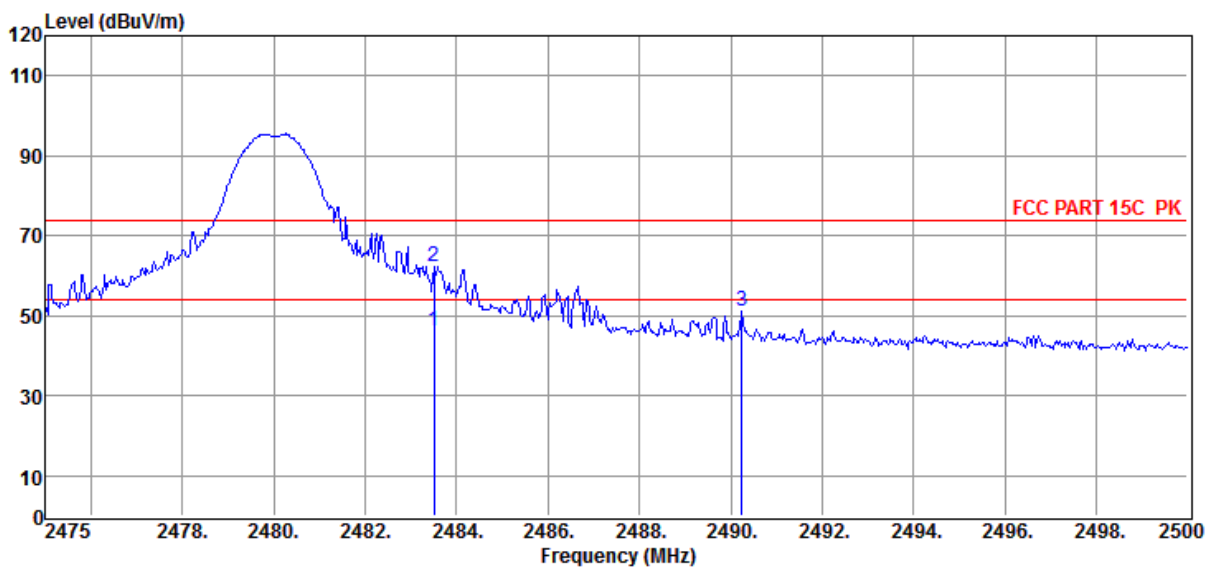

Item (Mark)	Freq. (MHz)	Read Level (dB μ V)	Antenna Factor (dB/m)	PRM Factor dB	Cable Loss dB	Result Level (dB μ V/m)	Limit Line (dB μ V/m)	Over Limit (dB)	Detector	Polarization
1	2483.50	52.02	27.92	0.00	-33.79	46.15	54.00	-7.85	Average	HORIZONTAL
2	2483.50	68.12	27.92	0.00	-33.79	62.25	74.00	-11.75	Peak	HORIZONTAL
3	2490.25	57.09	27.91	0.00	-33.69	51.31	74.00	-22.69	Peak	HORIZONTAL

Note: 1. Result Level = Read Level + Antenna Factor + Cable loss - PRM Factor.

2. If Peak Result complies with AV limit, AV Result is deemed to comply with AV limit.

3. Test setup: RBW: 1 MHz, VBW: 3 MHz, Sweep time: auto.

TR-4-E-009 Radiated Emission Test Result

Test Site : DDT 3m Chamber 2#

Test Date : 04-09-2021

Tested By : Sunny

EUT : Smart Waterproof phone case

Model Number : H1+

Power Supply : Battety

Test Mode : Tx mode

Condition : Temp:24.5°C,Humi:55%,Press:100.1kPa

Distance : 3m/VERTICAL

Memo : BLE1M 2480MHz

Data: 10

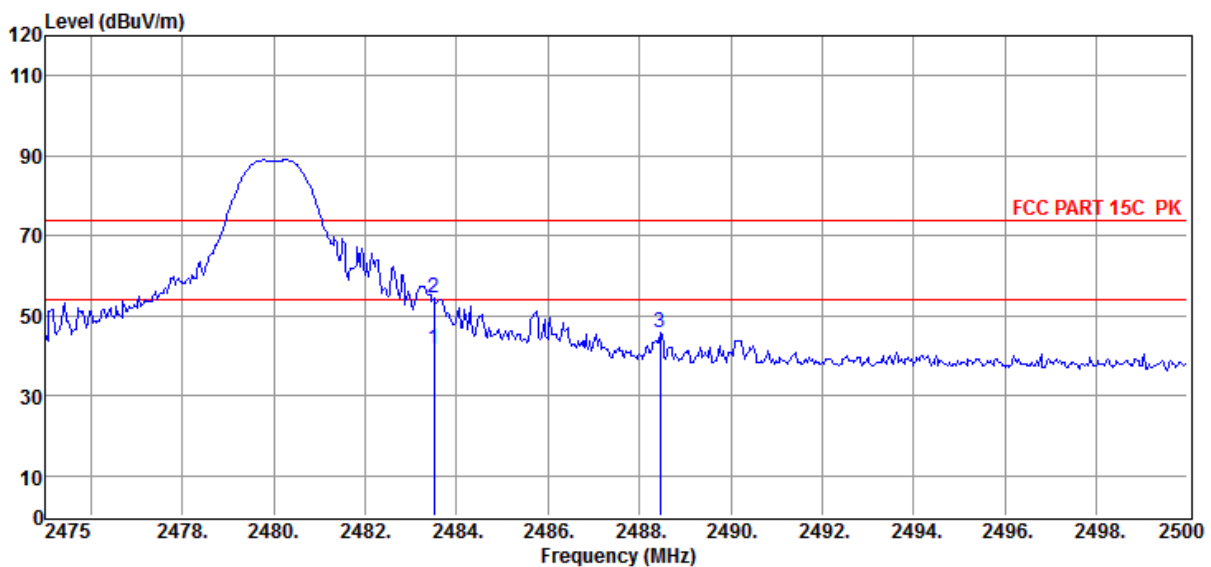

Item (Mark)	Freq. (MHz)	Read Level (dB μ V)	Antenna Factor (dB/m)	PRM Factor dB	Cable Loss dB	Result Level (dB μ V/m)	Limit Line (dB μ V/m)	Over Limit (dB)	Detector	Polarization
1	2483.50	47.36	27.92	0.00	-33.79	41.49	54.00	-12.51	Average	VERTICAL
2	2483.50	60.45	27.92	0.00	-33.79	54.58	74.00	-19.42	Peak	VERTICAL
3	2488.45	51.45	27.92	0.00	-33.71	45.66	74.00	-28.34	Peak	VERTICAL

Note: 1. Result Level = Read Level + Antenna Factor + Cable loss - PRM Factor.

2. If Peak Result complies with AV limit, AV Result is deemed to comply with AV limit.

3. Test setup: RBW: 1 MHz, VBW: 3 MHz, Sweep time: auto.

TR-4-E-009 Radiated Emission Test Result

Test Site : DDT 3m Chamber 2#

Test Date : 04-09-2021

Tested By : Sunny

EUT : Smart Waterproof phone case

Model Number : H1+

Power Supply : Battety

Test Mode : Tx mode

Condition : Temp:24.5°C,Humi:55%,Press:100.1kPa

Distance : 3m/HORIZONTAL

Memo : BLE2M 2402MHz

Data: 11

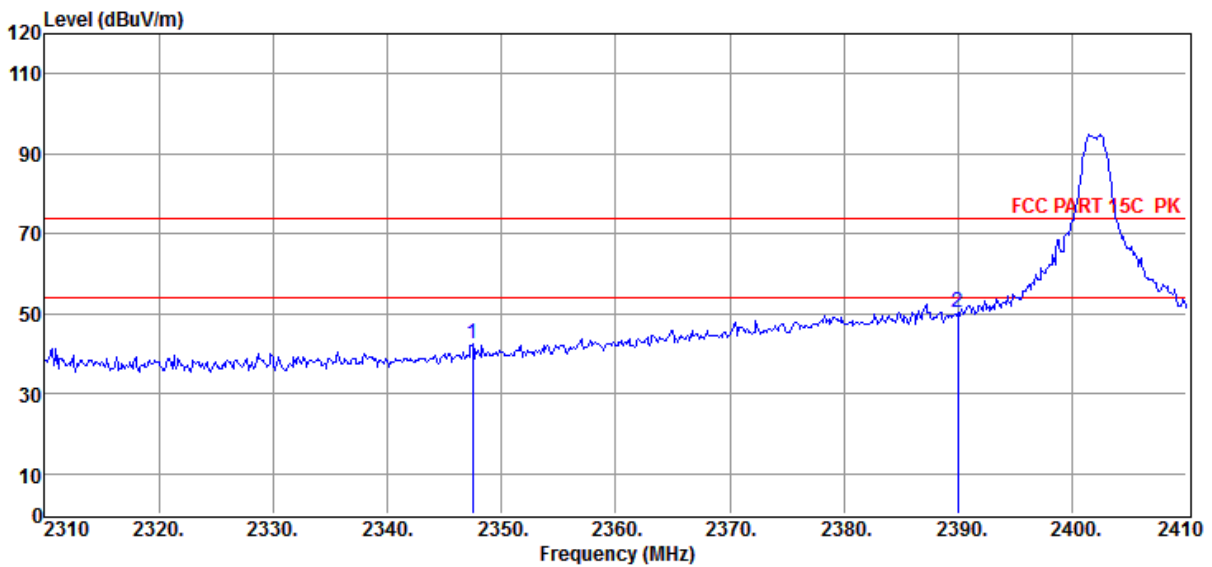

Item (Mark)	Freq. (MHz)	Read Level (dBuV)	Antenna Factor (dB/m)	PRM Factor (dB)	Cable Loss (dB)	Result Level (dBuV/m)	Limit Line (dBuV/m)	Over Limit (dB)	Detector	Polarization
1	2347.50	48.23	28.11	0.00	-33.96	42.38	74.00	-31.62	Peak	HORIZONTAL
2	2390.00	56.26	28.05	0.00	-34.02	50.29	74.00	-23.71	Peak	HORIZONTAL

Note: 1. Result Level = Read Level + Antenna Factor + Cable loss - PRM Factor.

2. If Peak Result complies with AV limit, AV Result is deemed to comply with AV limit.

3. Test setup: RBW: 1 MHz, VBW: 3 MHz, Sweep time: auto.

TR-4-E-009 Radiated Emission Test Result

Test Site : DDT 3m Chamber 2#

Test Date : 04-09-2021

Tested By : Sunny

EUT : Smart Waterproof phone case

Model Number : H1+

Power Supply : Battety

Test Mode : Tx mode

Condition : Temp:24.5°C,Humi:55%,Press:100.1kPa

Distance : 3m/VERTICAL

Memo : BLE2M 2402MHz

Data: 12

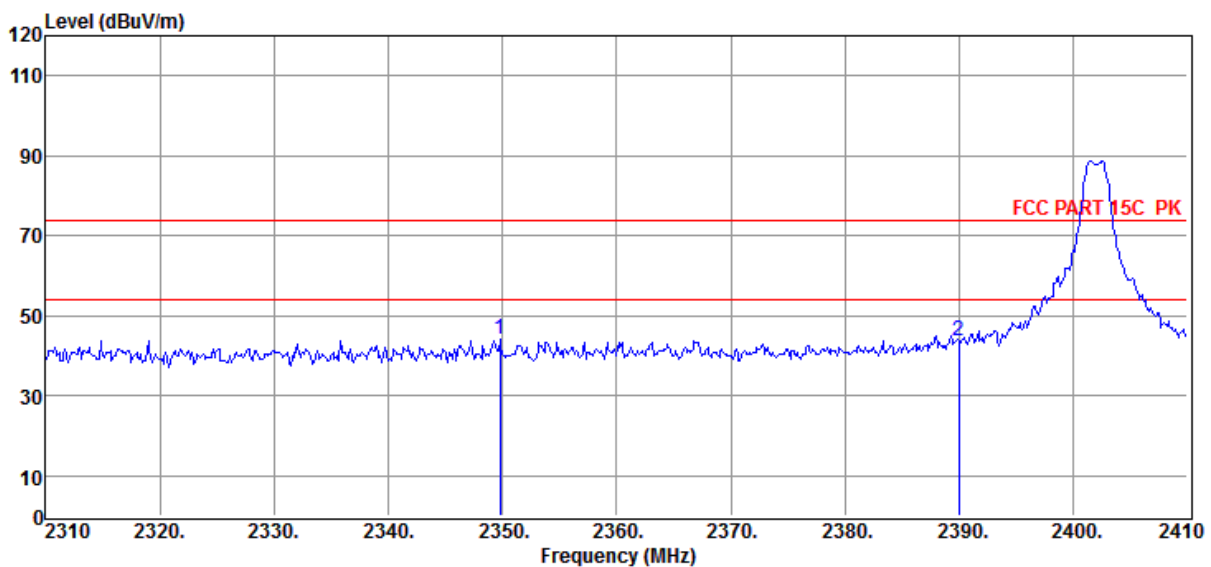

Item (Mark)	Freq. (MHz)	Read Level (dB μ V)	Antenna Factor (dB/m)	PRM Factor dB	Cable Loss dB	Result Level (dB μ V/m)	Limit Line (dB μ V/m)	Over Limit (dB)	Detector	Polarization
1	2349.80	50.13	28.11	0.00	-33.96	44.28	74.00	-29.72	Peak	VERTICAL
2	2390.00	49.76	28.05	0.00	-34.02	43.79	74.00	-30.21	Peak	VERTICAL

Note: 1. Result Level = Read Level + Antenna Factor + Cable loss - PRM Factor.

2. If Peak Result complies with AV limit, AV Result is deemed to comply with AV limit.

3. Test setup: RBW: 1 MHz, VBW: 3 MHz, Sweep time: auto.

TR-4-E-009 Radiated Emission Test Result

Test Site : DDT 3m Chamber 2#

Test Date : 04-09-2021

Tested By : Sunny

EUT : Smart Waterproof phone case

Model Number : H1+

Power Supply : Battety

Test Mode : Tx mode

Condition : Temp:24.5°C,Humi:55%,Press:100.1kPa

Distance : 3m/HORIZONTAL

Memo : BLE2M 2480MHz

Data: 19

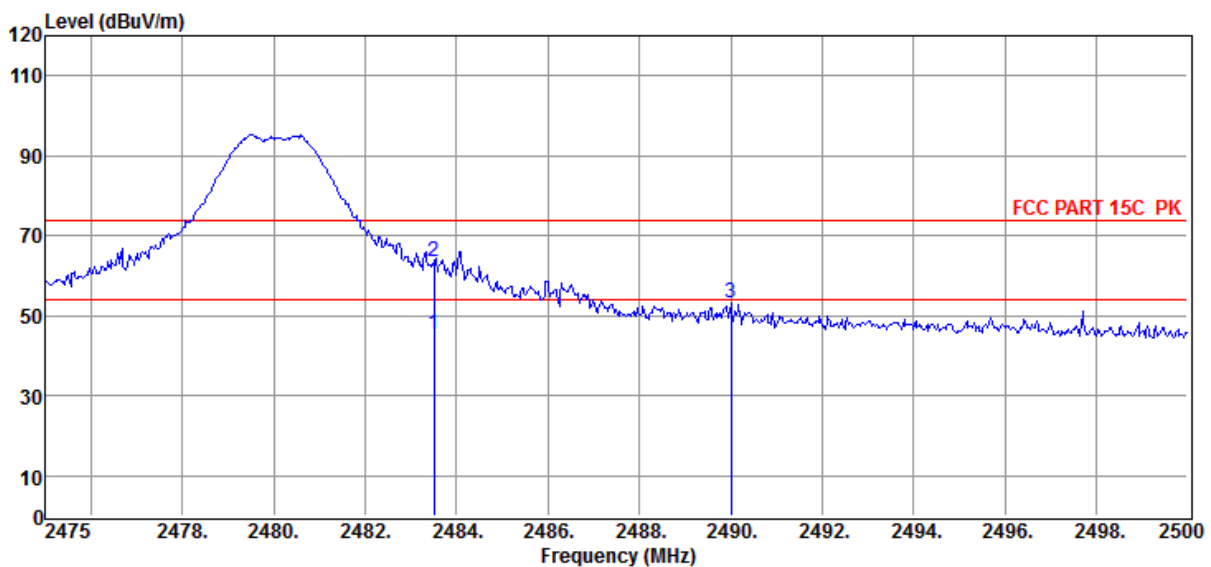

Item (Mark)	Freq. (MHz)	Read Level (dBμV)	Antenna Factor (dB/m)	PRM Factor dB	Cable Loss dB	Result Level (dBμV/m)	Limit Line (dBμV/m)	Over Limit (dB)	Detector	Polarization
1	2483.50	51.35	27.92	0.00	-33.79	45.48	54.00	-8.52	Average	HORIZONTAL
2	2483.50	69.43	27.92	0.00	-33.79	63.56	74.00	-10.44	Peak	HORIZONTAL
3	2490.00	58.77	27.91	0.00	-33.69	52.99	74.00	-21.01	Peak	HORIZONTAL

Note: 1. Result Level = Read Level + Antenna Factor + Cable loss - PRM Factor.

2. If Peak Result complies with AV limit, AV Result is deemed to comply with AV limit.

3. Test setup: RBW: 1 MHz, VBW: 3 MHz, Sweep time: auto.

TR-4-E-009 Radiated Emission Test Result

Test Site : DDT 3m Chamber 2#

Test Date : 04-09-2021

Tested By : Sunny

EUT : Smart Waterproof phone case

Model Number : H1+

Power Supply : Battety

Test Mode : Tx mode

Condition : Temp:24.5°C,Humi:55%,Press:100.1kPa

Distance : 3m/VERTICAL

Memo : BLE2M 2480MHz

Data: 20

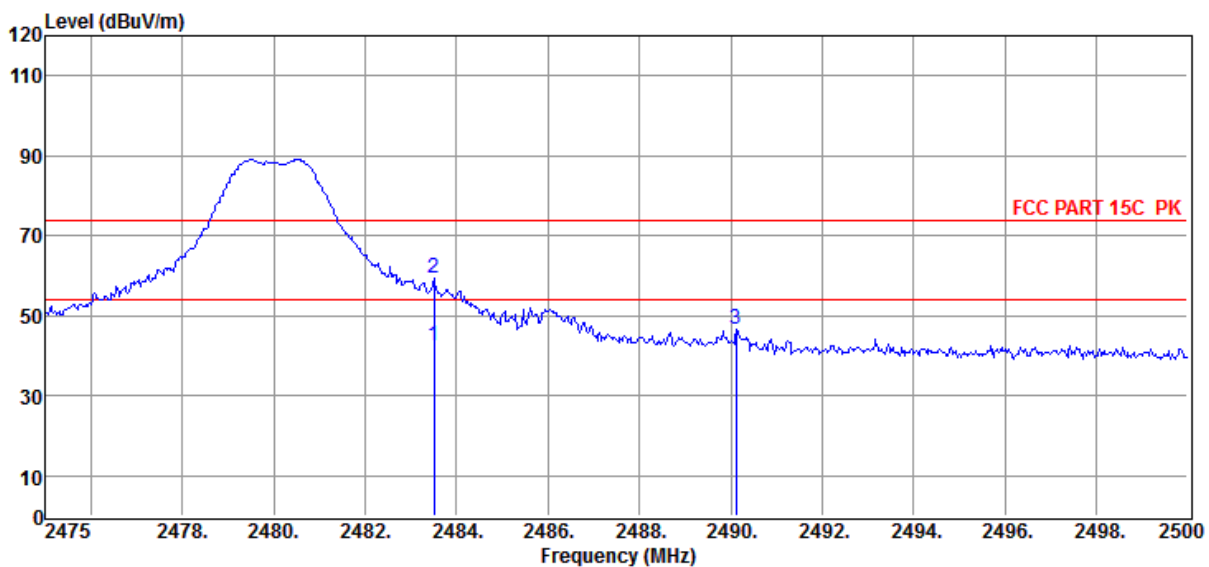

Item (Mark)	Freq. (MHz)	Read Level (dBμV)	Antenna Factor (dB/m)	PRM Factor dB	Cable Loss dB	Result Level (dBμV/m)	Limit Line (dBμV/m)	Over Limit (dB)	Detector	Polarization
1	2483.50	48.54	27.92	0.00	-33.79	42.67	54.00	-11.33	Average	VERTICAL
2	2483.50	65.05	27.92	0.00	-33.79	59.18	74.00	-14.82	Peak	VERTICAL
3	2490.13	52.20	27.91	0.00	-33.69	46.42	74.00	-27.58	Peak	VERTICAL

Note: 1. Result Level = Read Level + Antenna Factor + Cable loss - PRM Factor.

2. If Peak Result complies with AV limit, AV Result is deemed to comply with AV limit.

3. Test setup: RBW: 1 MHz, VBW: 3 MHz, Sweep time: auto.

11. Power Line Conducted Emission

11.1. Block diagram of test setup

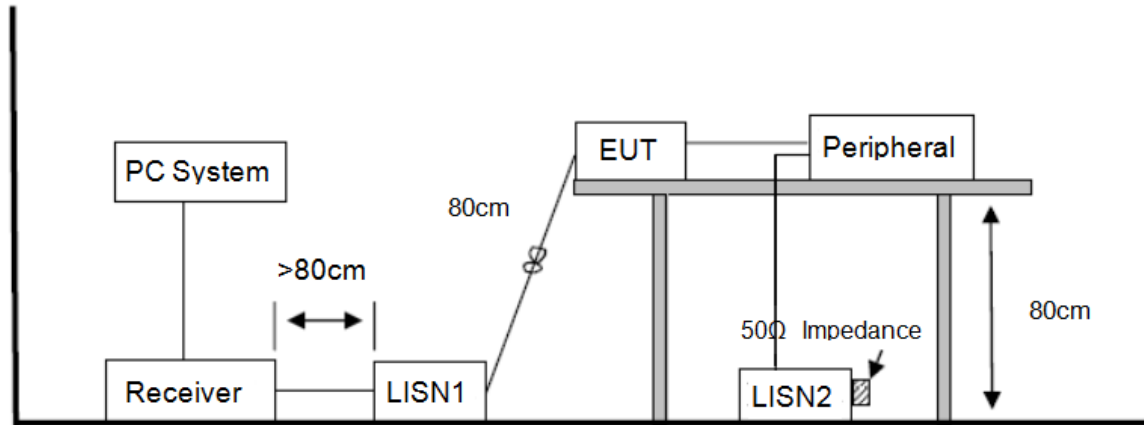

11.2. Power line conducted emission limits

Frequency	Quasi-Peak Level dB(μ V)	Average Level dB(μ V)
150 kHz ~ 500 kHz	66 ~ 56*	56 ~ 46*
500 kHz ~ 5 MHz	56	46
5 MHz ~ 30 MHz	60	50

Note 1: * Decreasing linearly with logarithm of frequency.

Note 2: The lower limit shall apply at the transition frequencies.

11.3. Test procedure

The EUT and Support equipment, if needed, were put placed on a non-metallic table, 80 cm above the ground plane.

Configuration EUT to simulate typical usage as described in clause 2.4 and test equipment as described in clause 10.2 of this report.

All I/O cables were positioned to simulate typical actual usage as per ANSI C63.10.

All support equipment power received from a second LISN.

Emissions were measured on each current carrying line of the EUT using an EMI Test Receiver connected to the LISN powering the EUT.

The Receiver scanned from 150 kHz to 30 MHz for emissions in each of the test modes.

During the above scans, the emissions were maximized by cable manipulation.

The test mode(s) described in clause 2.4 were scanned during the preliminary test.

After the preliminary scan, we found the test mode producing the highest emission level.

The EUT configuration and worse cable configuration of the above highest emission levels were recorded for reference of the final test.

EUT and support equipment were set up on the test bench as per the configuration with highest emission level in the preliminary test.

A scan was taken on both power lines, Neutral and Line, recording at least the six highest emissions.

Emission frequency and amplitude were recorded into a computer in which correction factors were used to calculate the emission level and compare reading to the applicable limit.

The test data of the worst-case condition(s) was recorded.

The bandwidth of test receiver is set at 9 kHz.

11.4. Test result

PASS. (See below detailed test result)

Note1: All emissions not reported below are too low against the prescribed limits.

Note2: “-----” means Peak detection; “-----” means Average detection.

Note3: Pre-test AC conducted emission at both voltage AC 120V/60Hz and AC 240V/50Hz, recorded worse case.

TR-4-E-010 Conducted Emission Test Result

Test Site : DDT 2# Shield Room
Test Date : 2021-04-10
EUT : Smart Waterproof phone case
Power Supply : AC 120V/60Hz
Condition : Temp:24.5°C,Humi:55%,Press:100.1kPa
Memo :
Tested By : Sunny
Model Number : H1+
Test Mode : Tx mode
LISN : EVN216_CE/LINE

Data: 48

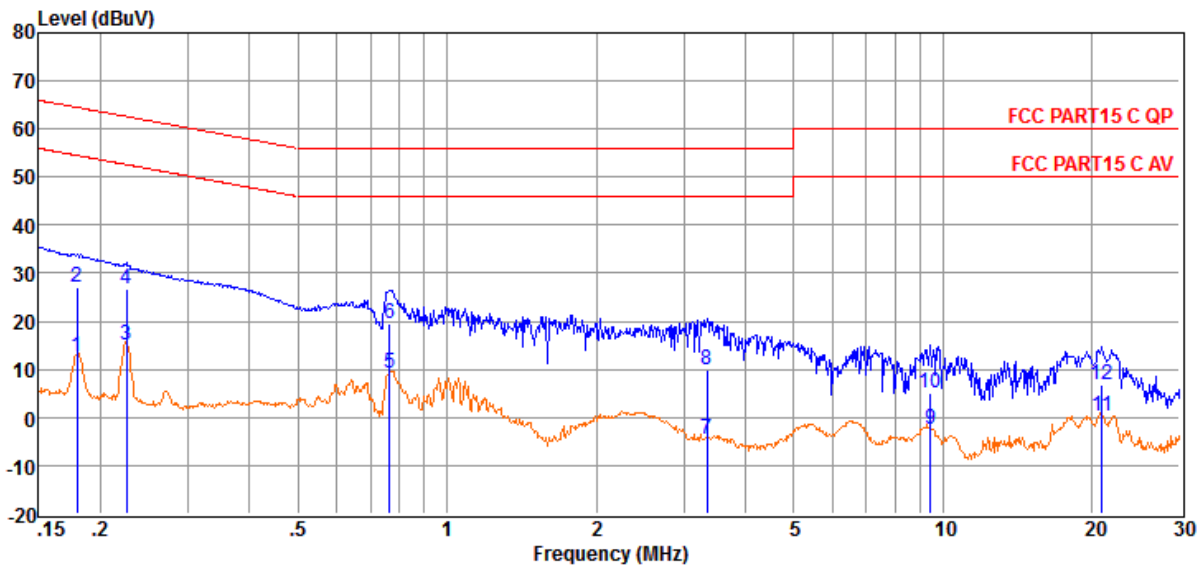

Item (Mark)	Freq. (MHz)	Read Level (dBμV)	Cable Loss (dB)	Result Level (dBμV)	Limit Line (dBμV)	Over Limit (dB)	Detector	Phase
1	0.18	2.28	0.03	12.64	54.50	-41.86	Average	LINE
2	0.18	16.74	0.03	27.10	64.50	-37.40	QP	LINE
3	0.23	4.89	0.05	15.13	52.61	-37.48	Average	LINE
4	0.23	16.49	0.05	26.73	62.61	-35.88	QP	LINE
5	0.77	-1.45	0.72	9.24	46.00	-36.76	Average	LINE
6	0.77	8.90	0.72	19.59	56.00	-36.41	QP	LINE
7	3.35	-14.75	0.14	-4.62	46.00	-50.62	Average	LINE
8	3.35	-0.39	0.14	9.74	56.00	-46.26	QP	LINE
9	9.45	-14.16	0.18	-2.49	50.00	-52.49	Average	LINE
10	9.45	-6.46	0.18	5.21	60.00	-54.79	QP	LINE
11	20.92	-12.85	0.27	0.42	50.00	-49.58	Average	LINE
12	20.92	-6.47	0.27	6.80	60.00	-53.20	QP	LINE

Note: 1. Result Level = Read Level + Cable loss.

2. If QP Result complies with AV limit, AV Result is deemed to comply with AV limit.

3. Test setup: RBW: 9 kHz, Step size: 0.2%, Scan time: 20ms.

TR-4-E-010 Conducted Emission Test Result

Test Site : DDT 2# Shield Room
Test Date : 2021-04-10
EUT : Smart Waterproof phone case
Power Supply : AC 120V/60Hz
Condition : Temp:24.5°C,Humi:55%,Press:100.1kPa
Memo :
Tested By : Sunny
Model Number : H1+
Test Mode : Tx mode
LISN : EVN216_CE/NEUTRAL

Data: 50

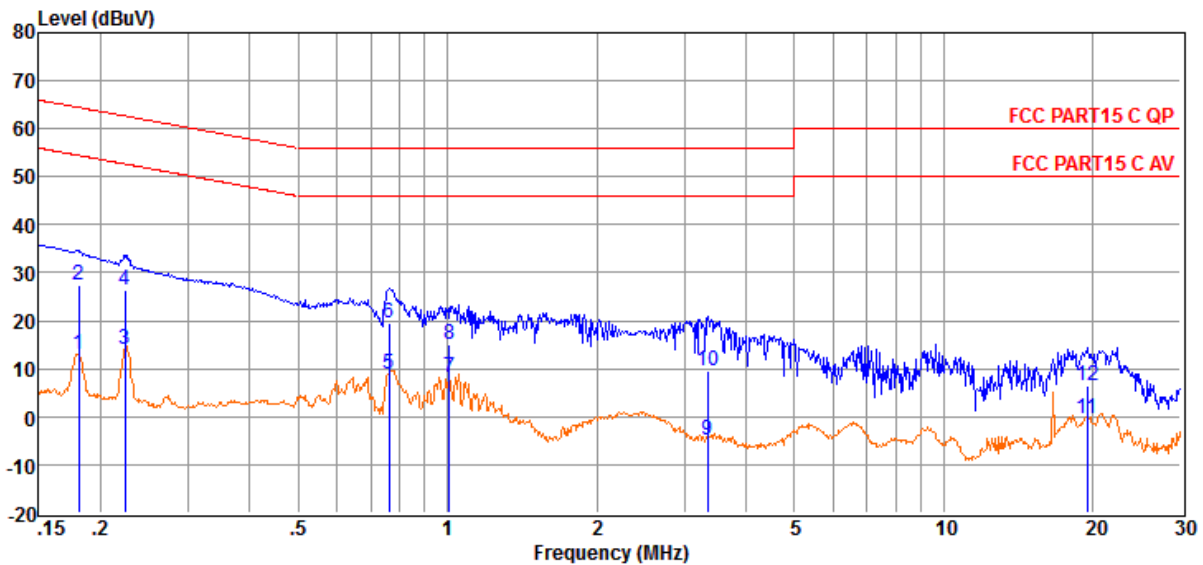

Item (Mark)	Freq. (MHz)	Read Level (dB μ V)	Cable Loss (dB)	Result Level (dB μ V)	Limit Line (dB μ V)	Over Limit (dB)	Detector	Phase
1	0.18	2.47	0.03	12.87	54.46	-41.59	Average	NEUTRAL
2	0.18	17.19	0.03	27.59	64.46	-36.87	QP	NEUTRAL
3	0.22	3.64	0.05	13.92	52.66	-38.74	Average	NEUTRAL
4	0.22	16.11	0.05	26.39	62.66	-36.27	QP	NEUTRAL
5	0.76	-1.83	0.72	8.90	46.00	-37.10	Average	NEUTRAL
6	0.76	8.84	0.72	19.57	56.00	-36.43	QP	NEUTRAL
7	1.01	-2.46	0.79	8.32	46.00	-37.68	Average	NEUTRAL
8	1.01	4.31	0.79	15.09	56.00	-40.91	QP	NEUTRAL
9	3.35	-14.96	0.14	-4.79	46.00	-50.79	Average	NEUTRAL
10	3.35	-0.70	0.14	9.47	56.00	-46.53	QP	NEUTRAL
11	19.43	-13.36	0.25	-0.30	50.00	-50.30	Average	NEUTRAL
12	19.43	-6.65	0.25	6.41	60.00	-53.59	QP	NEUTRAL

Note: 1. Result Level = Read Level + Cable loss.

2. If QP Result complies with AV limit, AV Result is deemed to comply with AV limit.

3. Test setup: RBW: 9 kHz, Step size: 0.2%, Scan time: 20ms.

12. Antenna Requirements

12.1. Limit

For intentional device, according to FCC 47 CFR Section 15.203, an intentional radiator shall be designed to ensure that no antenna other than that furnished by the responsible party shall be used with the device. And according to FCC 47 CFR Section 15.247 (b), if transmitting antennas of directional gain greater than 6 dBi are used, the power shall be reduced by the amount in dB that the directional gain of the antenna exceeds 6 dBi.

12.2. Result

The antenna used for this product is PCB antenna and that no antenna other than that furnished by the responsible party shall be used with the device, the maximum peak gain transmit antenna is -1.40 dBi.