

FCC Part 15C Test Report

FCC ID: 2ASE2GS600L02

| | |
|------------------|--|
| Product Name: | wireless on board diagnose and data collectors |
| Trademark: | Honeywell THE POWER OF CONNECTED |
| Model Name : | GS600L02 GS600L03, GS600A01, GS600D01, GS600D03, GS500H01, HON-DM03, GS600L01, GS500H02, GS500H03 |
| Prepared For : | Honeywell International Inc |
| Address : | Building 1, Lane 555, Huan Ke Road, Zhangjiang, Shanghai, 201203, China |
| Prepared By : | Shenzhen BCTC Testing Co., Ltd. |
| Address : | BCTC Building & 1-2F, East of B Building, Pengzhou Industrial, Fuyuan 1st Road, Qiaotou Community, Fuyong Street, Bao'an District, Shenzhen, China |
| Test Date: | Nov. 29, 2018 – Dec. 13, 2018 |
| Date of Report : | Dec. 13, 2018 |
| Report No.: | BCTC-FY181106627E |

VERIFICATION OF COMPLIANCE

Applicant's name Honeywell International Inc

Address..... Building 1, Lane 555, Huan Ke Road, Zhangjiang, Shanghai, 201203,
China

Manufacture's Name Shenzhen Chaoyue Technology Development Co., Ltd.

Address..... Floor 3, Plant A1, Puhua Tech Park, Ind. Road, Dalang Office, Longhua
New Dist., Shenzhen

Product description

Product name wireless on board diagnose and data collectors

Trademark:

Honeywell
THE POWER OF **CONNECTED**

Model Name:

GS600L02
GS600L03, GS600A01, GS600D01, GS600D03, GS500H01,
HON-DM03, GS600L01, GS500H02, GS500H03

Standards:

FCC Part15.249
ANSI C63.10-2013

This device described above has been tested by BCTC, and the test results show that the equipment under test (EUT) is in compliance with the FCC requirements. And it is applicable only to the tested sample identified in the report.

This report shall not be reproduced except in full, without the written approval of BCTC, this document may be altered or revised by BCTC, personal only, and shall be noted in the revision of the document.

Test Result: **Pass**

Prepared by(Engineer):

Amou Zhang



Reviewer(Supervisor):

Eric Yang



Approved(Manager):

Carson Zhang



| Table of Contents | Page |
|---|-------------|
| 1 . SUMMARY OF TEST RESULTS | 5 |
| 1.1 TEST FACILITY | 5 |
| 1.2 MEASUREMENT UNCERTAINTY | 5 |
| 2 . GENERAL INFORMATION | 6 |
| 2.1 GENERAL DESCRIPTION OF EUT | 6 |
| 2.2 DESCRIPTION OF TEST MODES | 7 |
| 2.3 TABLE OF PARAMETERS OF TEXT SOFTWARE SETTING | 7 |
| 2.4 BLOCK DIGRAM SHOWING THE CONFIGURATION OF SYSTEM TESTED | 8 |
| 2.5 DESCRIPTION OF SUPPORT UNITS(CONDUCTED MODE) | 8 |
| 2.6 EQUIPMENTS LIST FOR ALL TEST ITEMS | 9 |
| 3 . EMC EMISSION TEST | 10 |
| 3.1 CONDUCTED EMISSION MEASUREMENT | 10 |
| 3.1.1 POWER LINE CONDUCTED EMISSION LIMITS | 10 |
| 3.1.2 TEST PROCEDURE | 11 |
| 3.1.3 DEVIATION FROM TEST STANDARD | 11 |
| 3.1.4 TEST SETUP | 11 |
| 3.1.5 EUT OPERATING CONDITIONS | 11 |
| 3.2 RADIATED EMISSION MEASUREMENT | 12 |
| 3.2.1 RADIATED EMISSION LIMITS | 12 |
| 3.2.2 TEST PROCEDURE | 13 |
| 3.2.3 DEVIATION FROM TEST STANDARD | 13 |
| 3.2.4 TEST SETUP | 14 |
| 3.2.5 EUT OPERATING CONDITIONS | 15 |
| 3.2.6 TEST RESULTS | 16 |
| 4 . BANDWIDTH TEST | 21 |
| 4.1 APPLIED PROCEDURES / LIMIT | 21 |
| 4.1.1 TEST PROCEDURE | 21 |
| 4.1.2 DEVIATION FROM STANDARD | 21 |
| 4.1.3 TEST SETUP | 21 |
| 4.1.4 EUT OPERATION CONDITIONS | 21 |
| 4.1.5 TEST RESULTS | 22 |
| 5 . 100 KHZ BANDWIDTH OF FREQUENCY BAND EDGE | 24 |
| 5.1 DEVIATION FROM STANDARD | 24 |
| 5.2 TEST SETUP | 24 |
| 5.3 EUT OPERATION CONDITIONS | 24 |
| 5.4 TEST RESULTS | 25 |
| 6 . ANTENNA REQUIREMENT | 28 |



| Table of Contents | Page |
|---------------------------------|-------------|
| 6.1 STANDARD REQUIREMENT | 28 |
| 6.2 EUT ANTENNA | 28 |
| 7 . EUT TEST PHOTO | 29 |
| 8 . PHOTOS OF THE EUT | 30 |

1. SUMMARY OF TEST RESULTS

Test procedures according to the technical standards:

| FCC Part15 (15.249) , Subpart C | | | |
|---------------------------------|--|----------|--------|
| Standard Section | Test Item | Judgment | Remark |
| 15.207 | Conducted Emission | N/A | |
| 15.249 | Fundamental & Radiated Spurious Emission Measurement | PASS | |
| 15.249 | Bandwidth | PASS | |
| 15.205 | Band Edge Emission | PASS | |
| 15.203 | Antenna Requirement | PASS | |

NOTE:

(1) "N/A" denotes test is not applicable in this Test Report

1.1 TEST FACILITY

Shenzhen BCTC Testing Co., Ltd.

Add.: BCTC Building & 1-2F, East of B Building, Pengzhou Industrial, Fuyuan 1st Road, Qiaotou Community, Fuyong Street, Bao'an District, Shenzhen, China

Test Firm Registration Number: 712850

1.2 MEASUREMENT UNCERTAINTY

The reported uncertainty of measurement $y \pm U$, where expanded uncertainty U is based on a standard uncertainty multiplied by a coverage factor of $k=2$, providing a level of confidence of approximately **95 %**.

| No. | Item | Uncertainty |
|-----|--|-------------|
| 1 | 3m chamber Radiated spurious emission(30MHz-1GHz) | U=4.3dB |
| 2 | 3m chamber Radiated spurious emission(1GHz-18GHz) | U=4.5dB |
| 3 | 3m chamber Radiated spurious emission(18GHz-40GHz) | U=3.34dB |
| 4 | Conducted Adjacent channel power | U=1.38dB |
| 5 | Conducted output power uncertainty Above 1G | U=1.576dB |
| 6 | Conducted output power uncertainty below 1G | U=1.28dB |
| 7 | humidity uncertainty | U=5.3% |
| 8 | Temperature uncertainty | U=0.59℃ |
| 9 | Radiated disturbance(30MHz-1000MHz) | U=4.8dB |
| 10 | Radiated disturbance(1GHz-6GHz) | U=4.9dB |
| 11 | Radiated disturbance(1GHz-18GHz) | U=5.0dB |

2. GENERAL INFORMATION

2.1 GENERAL DESCRIPTION OF EUT

| | | |
|--|--|--------------------|
| Equipment | wireless on board diagnose and data collectors | |
| Trade Name |  THE POWER OF CONNECTED | |
| Model Name | GS600L02 | |
| Serial Model | GS600L03, GS600A01, GS600D01, GS600D03, GS500H01, HON-DM03, GS600L01, GS500H02, GS500H03 | |
| Model Difference | All the model are the same circuit and RF module, except model names. | |
| Product Description | Operation Frequency: | 2402~2480 MHz |
| | Modulation Type: | GFSK |
| | Bit Rate of Transmitter | 2M |
| | Number Of Channel | 40 CH |
| | Antenna Designation: | Please see Note 3. |
| Based on the application, features, or specification exhibited in User's Manual, the EUT is considered as an ITE/Computing Device. More details of EUT technical specification, please refer to the User's Manual. | | |
| Channel List | Please refer to the Note 2. | |
| Power supply | DC 12V | |
| Connecting I/O Port(s) | Please refer to the User's Manual | |

Note:

1. For a more detailed features description, please refer to the manufacturer's specifications or the User's Manual.

2

| Channel List | | | | | |
|--------------|-----------------|---------|-----------------|---------|-----------------|
| Channel | Frequency (MHz) | Channel | Frequency (MHz) | Channel | Frequency (MHz) |
| 01 | 2402 | 11 | 2422 | 21 | 2442 |
| 02 | 2404 | 12 | 2424 | 22 | 2444 |
| 03 | 2406 | 13 | 2426 | 23 | 2446 |
| ~ | ~ | ~ | ~ | ~ | ~ |
| 09 | 2418 | 19 | 2438 | 39 | 2478 |
| 10 | 2420 | 20 | 2440 | 40 | 2480 |

3. Table for Filed Antenna

| Ant. | Brand | Model Name | Antenna Type | Gain (dBi) | NOTE |
|------|-------|------------|--------------|------------|------|
| 1 | N/A | N/A | PCB Antenna | 0 | |

2.2 DESCRIPTION OF TEST MODES

To investigate the maximum EMI emission characteristics generates from EUT, the test system was pre-scanning tested base on the consideration of following EUT operation mode or test configuration mode which possible have effect on EMI emission level. Each of these EUT operation mode(s) or test configuration mode(s) mentioned above was evaluated respectively.

| For Conducted & Radiated Emission | |
|-----------------------------------|-------------|
| Final Test Mode | Description |
| Mode 1 | CH01 |
| Mode 2 | CH20 |
| Mode 3 | CH40 |
| Mode 4 | Link Mode |

Note:

- (1) The measurements are performed at the highest, middle, lowest available channels.
- (2) Fully-charged battery is used during the test

2.3 TABLE OF PARAMETERS OF TEXT SOFTWARE SETTING

During testing channel & power controlling software provided by the customer was used to control the operating channel as well as the output power level. The RF output power selection is for the setting of RF output power expected by the customer and is going to be fixed on the firmware of the final end product power parameters of FHSS

| | | | |
|-----------|----------|----------|----------|
| Frequency | 2402 MHz | 2440 MHz | 2480 MHz |
| Channel | Low | Middle | High |

2.4 BLOCK DIGRAM SHOWING THE CONFIGURATION OF SYSTEM TESTED

Radiated Spurious Emission Test

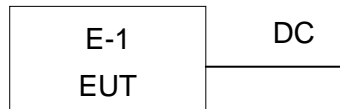

2.5 DESCRIPTION OF SUPPORT UNITS(CONDUCTED MODE)

The EUT has been tested as an independent unit together with other necessary accessories or support units. The following support units or accessories were used to form a representative test configuration during the tests.

| Item | Equipment | Mfr/Brand | Model/Type No. | Series No. | Note |
|------|--|--|----------------|------------|------|
| E-1 | wireless on board diagnose and data collectors | Honeywell THE POWER OF CONNECTED | GS600L02 | N/A | EUT |
| | | | | | |
| | | | | | |

| Item | Shielded Type | Ferrite Core | Length | Note |
|------|---------------|--------------|--------|------|
| | | | | |

Note:

- (1) The support equipment was authorized by Declaration of Confirmation.
- (2) For detachable type I/O cable should be specified the length in cm in 『Length』 column.
- (3) “YES” is means “shielded” “with core”; “NO” is means “unshielded” “without core”.

2.6 EQUIPMENTS LIST FOR ALL TEST ITEMS

Radiation Test equipment

| Item | Equipment | Manufacturer | Type No. | Serial No. | Last calibration | Calibrated until |
|------|----------------------------------|--------------|----------------|---------------|------------------|------------------|
| 1 | Spectrum Analyzer (9kHz-26.5GHz) | Agilent | E4407B | MY45109572 | 2018.06.20 | 2019.06.20 |
| 2 | Test Receiver (9kHz-7GHz) | R&S | ESRP | 101154 | 2018.06.20 | 2019.06.20 |
| 3 | Bilog Antenna (30MHz-3GHz) | SCHWARZBEC K | VULB9163 | VULB9163-942 | 2018.06.23 | 2019.06.23 |
| 4 | Horn Antenna (1GHz-18GHz) | SCHWARZBEC K | BBHA9120D | 1541 | 2018.06.23 | 2019.06.22 |
| 5 | Horn Antenna (18GHz-40GHz) | SCHWARZBEC K | BBHA9170 | 822 | 2018.08.06 | 2019.08.06 |
| 6 | Amplifier (9KHz-6GHz) | SCHWARZBEC K | BBV9744 | 9744-0037 | 2018.06.20 | 2019.06.20 |
| 7 | Amplifier (0.5GHz-18GHz) | SCHWARZBEC K | BBV9718 | 9718-309 | 2018.06.20 | 2019.06.20 |
| 8 | Amplifier (18GHz-40GHz) | MITEQ | TTA1840-35-H G | 2034381 | 2018.08.06 | 2019.08.06 |
| 9 | Loop Antenna (9KHz-30MHz) | SCHWARZBEC K | FMZB1519B | 014 | 2018.06.23 | 2019.06.23 |
| 10 | RF cables1 (9kHz-30MHz) | Huber+Suhnar | 9kHz-30MHz | B1702988-0008 | 2018.02.12 | 2019.02.12 |
| 11 | RF cables2 (30MHz-1GHz) | Huber+Suhnar | 30MHz-1GHz | 1486150 | 2018.03.27 | 2019.03.27 |
| 12 | RF cables3 (1GHz-40GHz) | Huber+Suhnar | 1GHz-40GHz | 1607106 | 2018.06.19 | 2019.06.19 |
| 13 | Power Metter | Keysight | E4419 | \ | 2018.04.15 | 2019.04.15 |
| 14 | Power Sensor (AV) | Keysight | E9300A | \ | 2018.04.15 | 2019.04.15 |
| 15 | Signal Analyzer 20kHz-26.5GHz | KEYSIGHT | N9020A | MY49100060 | 2018.07.11 | 2019.07.11 |
| 16 | Test Receiver 9kHz-40GHz | R&S | FSP40 | 100550 | 2018.06.13 | 2019.06.12 |
| 17 | D.C. Power Supply | LongWei | TPR-6405D | \ | \ | \ |
| 18 | Software | Frad | EZ-EMC | FA-03A2 RE | \ | \ |

Conduction Test equipment

| Item | Equipment | Manufacturer | Type No. | Serial No. | Last calibration | Calibrated until |
|------|---------------|--------------|------------|---------------|------------------|------------------|
| 1 | Test Receiver | R&S | ESR3 | 102075 | 2018.06.20 | 2019.06.20 |
| 2 | LISN | SCHWARZBECK | NSLK8127 | 8127739 | 2018.06.19 | 2019.06.19 |
| 3 | LISN | R&S | ENV216 | 101375 | 2018.06.20 | 2019.06.20 |
| 4 | RF cables | Huber+Suhnar | 9kHz-30MHz | B1702988-0008 | 2018.02.12 | 2019.02.12 |
| 5 | Software | Frad | EZ-EMC | EMC-CON 3A1 | \ | \ |

3. EMC EMISSION TEST

3.1 CONDUCTED EMISSION MEASUREMENT

3.1.1 POWER LINE CONDUCTED EMISSION Limits (Frequency Range 150KHz-30MHz)

| FREQUENCY (MHz) | Limit (dBuV) | | Standard |
|-----------------|--------------|-----------|----------|
| | Quas -peak | Average | |
| 0.15 -0.5 | 66 - 56 * | 56 - 46 * | FCC |
| 0.50 -5.0 | 56.00 | 46.00 | FCC |
| 5.0 -30.0 | 60.00 | 50.00 | FCC |

Note:

- (1) The tighter limit applies at the band edges.
- (2) The limit of " * " marked band means the limitation decreases linearly with the logarithm of the frequency in the range.

The following table is the setting of the receiver

| Receiver Parameters | Setting |
|---------------------|----------|
| Attenuation | 10 dB |
| Start Frequency | 0.15 MHz |
| Stop Frequency | 30 MHz |
| IF Bandwidth | 9 kHz |

3.1.2 TEST PROCEDURE

- a. The EUT was placed 0.8 meters from the horizontal ground plane with EUT being connected to the power mains through a line impedance stabilization network (LISN). All other support equipments powered from additional LISN(s). The LISN provide 50 Ohm/ 50uH of coupling impedance for the measuring instrument.
- b. Interconnecting cables that hang closer than 40 cm to the ground plane shall be folded back and forth in the center forming a bundle 30 to 40 cm long.
- c. I/O cables that are not connected to a peripheral shall be bundled in the center. The end of the cable may be terminated, if required, using the correct terminating impedance. The overall length shall not exceed 1 m.
- d. LISN at least 80 cm from nearest part of EUT chassis.
- e. For the actual test configuration, please refer to the related Item –EUT Test Photos.

3.1.3 DEVIATION FROM TEST STANDARD

No deviation

3.1.4 TEST SETUP

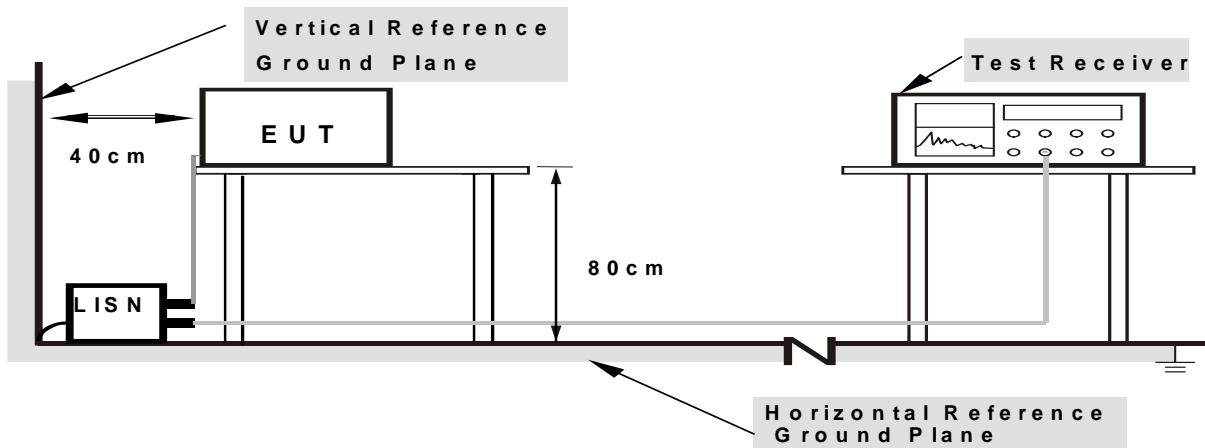

Note: 1.Support units were connected to second LISN.
2.Both of LISNs (AMN) are 80 cm from EUT and at least 80 from other units and other metal planes

3.1.5 EUT OPERATING CONDITIONS

The EUT was configured for testing in a typical fashion (as a customer would normally use it). The EUT has been programmed to continuously transmit during test. This operating condition was tested and used to collect the included data.

3.1.6 TEST RESULTS

NOTE: This EUT is powered by the DC only, this test item is not applicable.

3.2 RADIATED EMISSION MEASUREMENT

3.2.1 RADIATED EMISSION LIMITS (Frequency Range 9kHz-1000MHz)

20dBc in any 100 kHz bandwidth outside the operating frequency band. In case the emission fall within the restricted band specified on 15.205(a), then the 15.209(a) limit in the table below has to be followed.

| Frequencies (MHz) | Field Strength (micorvolts/meter) | Measurement Distance (meters) |
|-------------------|-----------------------------------|-------------------------------|
| 0.009~0.490 | 2400/F(KHz) | 300 |
| 0.490~1.705 | 24000/F(KHz) | 30 |
| 1.705~30.0 | 30 | 30 |
| 30~88 | 100 | 3 |
| 88~216 | 150 | 3 |
| 216~960 | 200 | 3 |
| Above 960 | 500 | 3 |

LIMITS OF RADIATED EMISSION MEASUREMENT (Above 1000MHz)

| FREQUENCY (MHz) | Limit (dBuV/m) (at 3M) | |
|-----------------|------------------------|---------|
| | PEAK | AVERAGE |
| Above 1000 | 74 | 54 |

Notes:

- (1) The limit for radiated test was performed according to FCC PART 15C.
- (2) The tighter limit applies at the band edges.
- (3) Emission level (dBuV/m)=20log Emission level (uV/m).

FREQUENCY RANGE OF RADIATED MEASUREMENT (For unintentional radiators)

| Highest frequency generated or Upper frequency of measurement used in the device or on which the device operates or tunes (MHz) | Range (MHz) |
|---|---|
| Below 1.705 | 30 |
| 1.705 – 108 | 1000 |
| 108 – 500 | 2000 |
| 500 – 1000 | 5000 |
| Above 1000 | 5 th harmonic of the highest frequency or 40 GHz, whichever is lower |

| Spectrum Parameter | Setting |
|---------------------------------------|--|
| Attenuation | Auto |
| Start Frequency | 1000 MHz |
| Stop Frequency | 10th carrier harmonic |
| RB / VB (emission in restricted band) | 1 MHz / 1 MHz for Peak, 1 MHz / 10Hz for Average |

| Receiver Parameter | Setting |
|------------------------|----------------------------------|
| Attenuation | Auto |
| Start ~ Stop Frequency | 9kHz~150kHz / RB 200Hz for QP |
| Start ~ Stop Frequency | 150kHz~30MHz / RB 9kHz for QP |
| Start ~ Stop Frequency | 30MHz~1000MHz / RB 120kHz for QP |

3.2.2 TEST PROCEDURE

- a. The measuring distance of at 3 m shall be used for measurements at frequency up to 25GHz. For frequencies above 1GHz, any suitable measuring distance may be used.
- b. The EUT was placed on the top of a rotating table 0.8 and 1.5 meters above the ground at a 3 meter semi-chamber test. The table was rotated 360 degrees to determine the position of the highest radiation.
- c. The height of the equipment or of the substitution antenna shall be 0.8 m; above 1GHz, the height was 1.5m, the height of the test antenna shall vary between 1 m to 4 m. Both horizontal and vertical polarizations of the antenna are set to make the measurement.
- d. The initial step in collecting conducted emission data is a spectrum analyzer peak detector mode pre-scanning the measurement frequency range. Significant peaks are then marked and then Quasi Peak detector mode re-measured.
- e. If the Peak Mode measured value compliance with and lower than Quasi Peak Mode Limit, the EUT shall be deemed to meet QP Limits and then no additional QP Mode measurement performed.
- f. For the actual test configuration, please refer to the related Item –EUT Test Photos.
- g. For the radiated emission test above 1GHz:

Place the measurement antenna away from each area of the EUT determined to be a source of emissions at the specified measurement distance, while keeping the measurement antenna aimed at the source of emissions at each frequency of significant emissions, with polarization oriented for maximum response.

The measurement antenna may have to be higher or lower than the EUT, depending on the radiation pattern of the emission and staying aimed at the emission source for receiving the maximum signal. The final measurement antenna elevation shall be that which maximizes the emissions. The measurement antenna elevation for maximum emissions shall be restricted to a range of heights of from 1 m to 4 m above the ground or reference ground plane.

Note:

Both horizontal and vertical antenna polarities were tested and performed pretest to three orthogonal axis. The worst case emissions were reported

3.2.3 DEVIATION FROM TEST STANDARD

No deviation

3.2.4 TEST SETUP

(A) Radiated Emission Test-Up Frequency Below 30MHz

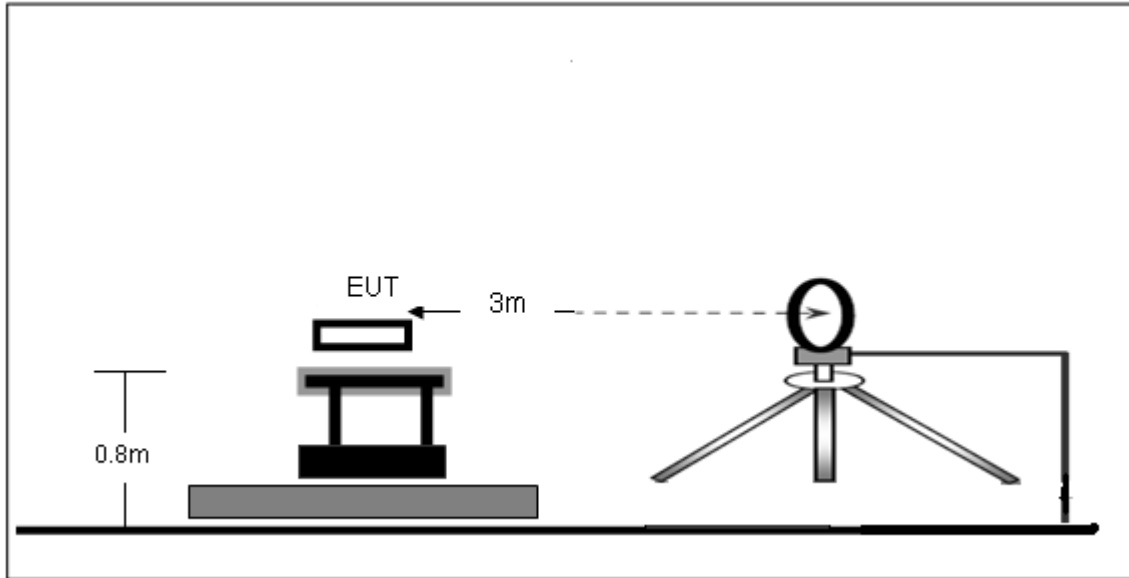

(B) Radiated Emission Test-Up Frequency 30MHz~1GHz

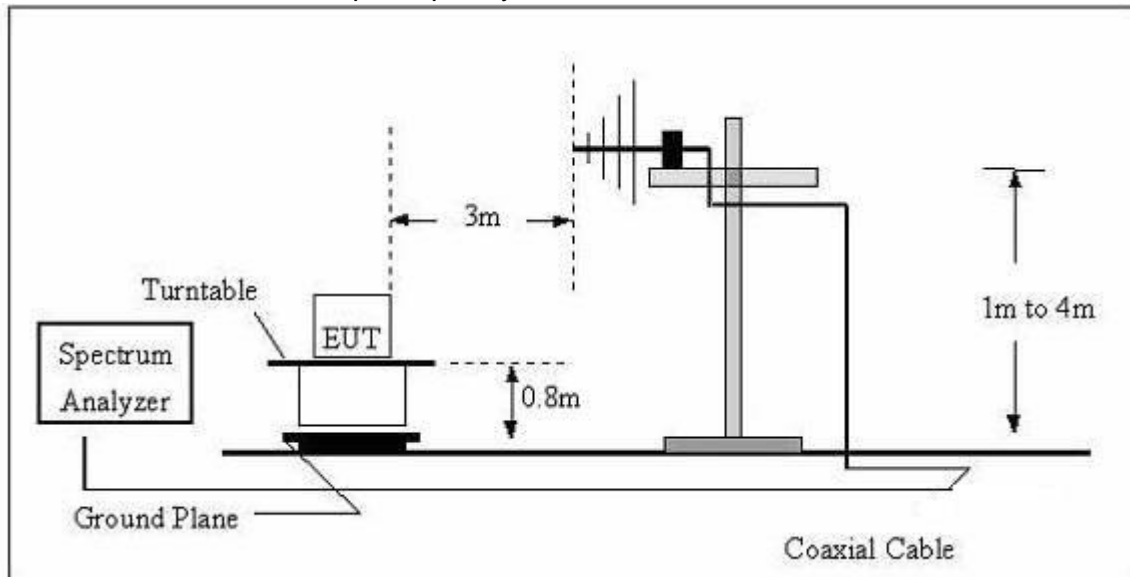

(C) Radiated Emission Test-Up Frequency Above 1GHz

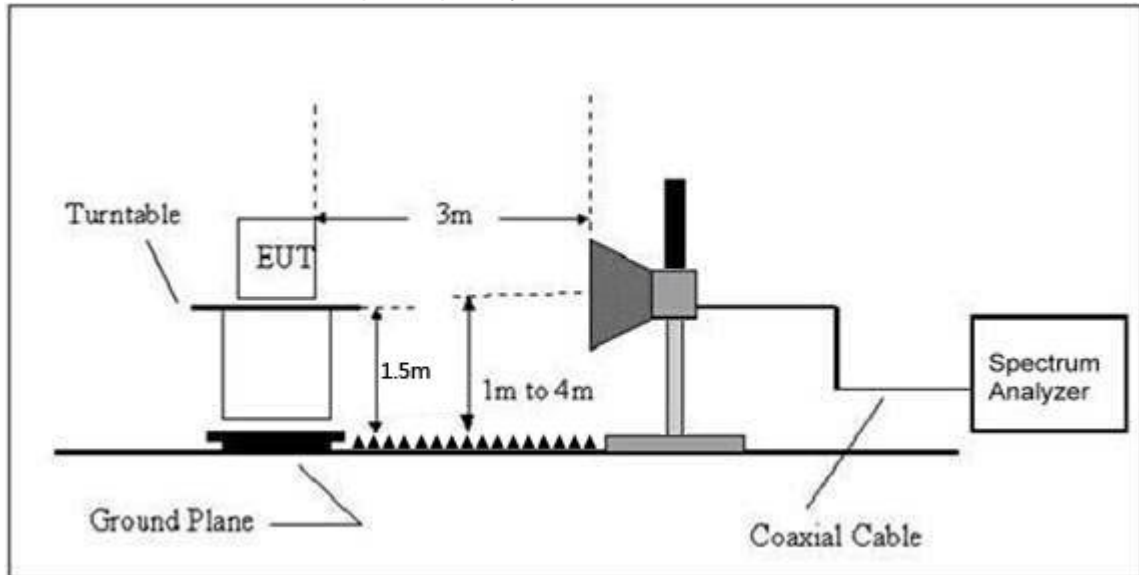

3.2.5 EUT OPERATING CONDITIONS

The EUT tested system was configured as the statements of 2.4 Unless otherwise a special operating condition is specified in the follows during the testing.

3.2.6 TEST RESULTS

Radiated Spurious Emission (Below 30MHz)

| | | | |
|----------------|-----------|---------------------|-----|
| Temperature : | 26 °C | Relative Humidity : | 54% |
| Pressure : | 101khPa | Polarization : | --- |
| Test Voltage : | DC 12V | | |
| Test Mode : | Link Mode | | |

| Freq. | Reading | Limit | Margin | State |
|-------|----------|----------|--------|-------|
| (MHz) | (dBuV/m) | (dBuV/m) | (dB) | P/F |
| -- | -- | -- | -- | PASS |
| -- | -- | -- | -- | PASS |

NOTE:

The amplitude of spurious emissions which are attenuated by more than 20dB below the permissible value has no need to be reported.

Distance extrapolation factor = $40 \log(\text{specific distance}/\text{test distance})$ (dB);

Limit line = specific limits(dBuv) + distance extrapolation factor.

Correct Factor=Antenna Factor + Cable Loss – Pre-amplifier.

Radiated Spurious Emission (Between 30MHz – 1GHz)

| | | | |
|------------------------|-----------|---------------------|------------|
| Temperature : | 26 °C | Relative Humidity : | 54% |
| Pressure : | 101kPa | Polarization : | Horizontal |
| Test Voltage : | DC 12V | | |
| Test Mode : (Worst) | Link Mode | | |

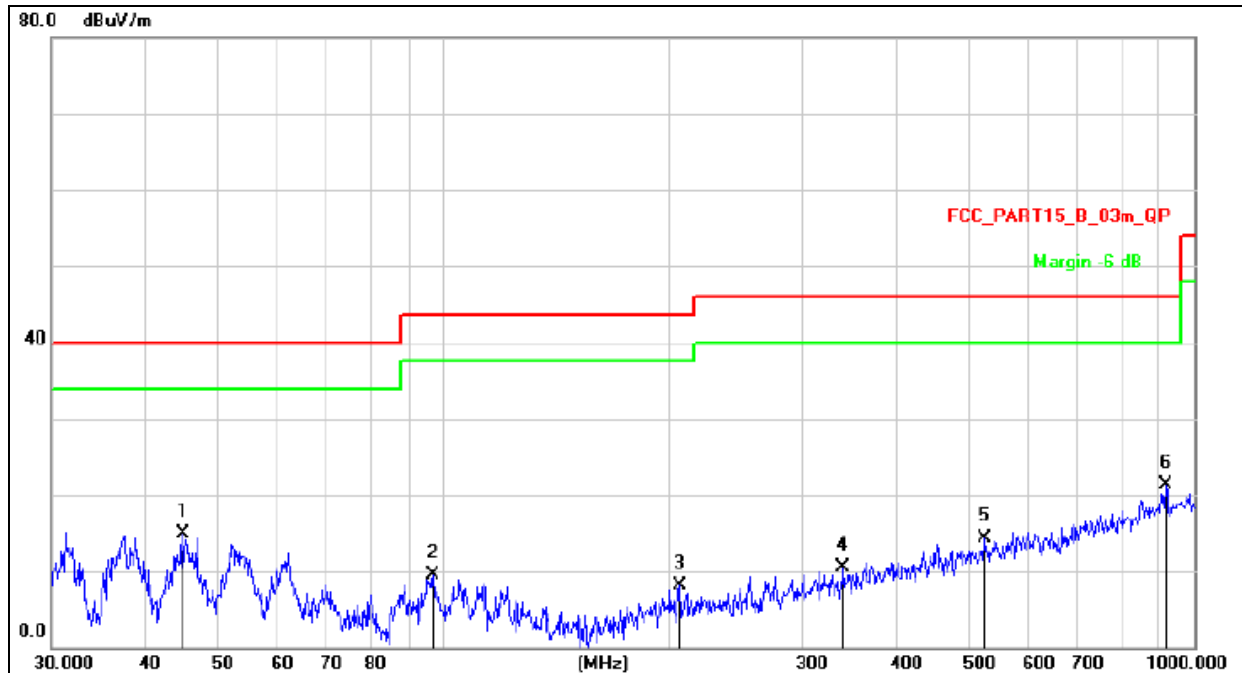

Remark:
Factor = Antenna Factor + Cable Loss – Pre-amplifier.

| No. | Mk. | Freq. MHz | Reading Level dBuV | Correct Factor dB | Measure- ment dBuV/m | Limit dB/m | Over dB | Detector |
|-----|-----|--------------|--------------------------|-------------------------|----------------------------|---------------|------------|----------|
| 1 | | 44.9006 | 29.95 | -15.14 | 14.81 | 40.00 | -25.19 | QP |
| 2 | | 96.7749 | 26.35 | -16.87 | 9.48 | 43.50 | -34.02 | QP |
| 3 | | 206.3976 | 24.27 | -16.15 | 8.12 | 43.50 | -35.38 | QP |
| 4 | | 340.7817 | 23.02 | -12.48 | 10.54 | 46.00 | -35.46 | QP |
| 5 | | 526.3967 | 22.51 | -8.27 | 14.24 | 46.00 | -31.76 | QP |
| 6 | * | 916.0687 | 22.61 | -1.37 | 21.24 | 46.00 | -24.76 | QP |

| | | | |
|------------------------|-----------|---------------------|----------|
| Temperature : | 26 °C | Relative Humidity : | 54% |
| Pressure : | 101kPa | Polarization : | Vertical |
| Test Voltage : | DC 12V | | |
| Test Mode : (Worst) | Link Mode | | |

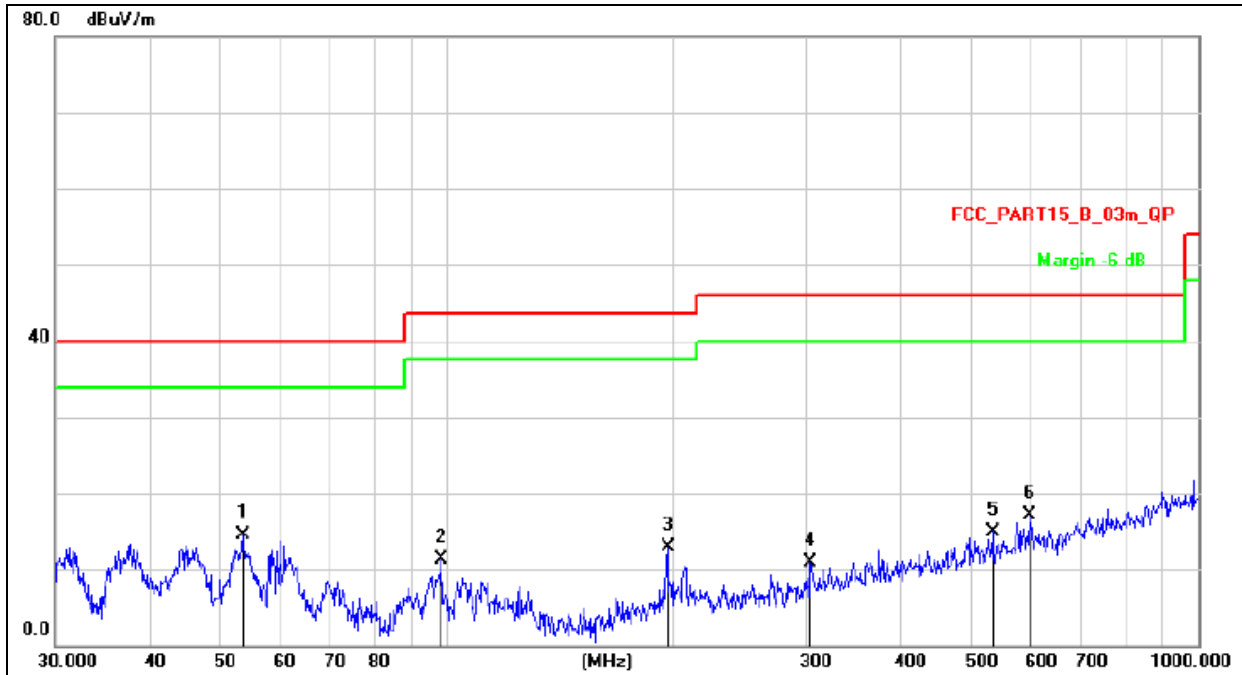

Remark:
Factor = Antenna Factor + Cable Loss – Pre-amplifier.

| No. | Mk. | Freq. MHz | Reading Level dBuV | Correct Factor dB | Measure- ment dBuV/m | Limit dB/m | Over dB | Detector |
|-----|-----|--------------|--------------------------|-------------------------|----------------------------|---------------|------------|----------|
| 1 | * | 53.3179 | 29.66 | -15.20 | 14.46 | 40.00 | -25.54 | QP |
| 2 | | 98.1419 | 28.01 | -16.62 | 11.39 | 43.50 | -32.11 | QP |
| 3 | | 196.5098 | 29.37 | -16.52 | 12.85 | 43.50 | -30.65 | QP |
| 4 | | 304.6099 | 24.34 | -13.47 | 10.87 | 46.00 | -35.13 | QP |
| 5 | | 531.9635 | 23.13 | -8.13 | 15.00 | 46.00 | -31.00 | QP |
| 6 | | 595.1329 | 23.75 | -6.63 | 17.12 | 46.00 | -28.88 | QP |

Radiated Spurious Emission (1GHz to 10th harmonics)

GFSK

| Polar (H/V) | Frequency (MHz) | Meter Reading (dBuV) | Pre-amplifier (dB) | Cable Loss (dB) | Antenna Factor (dB/m) | Emission Level (dBuV/m) | Limits (dBuV/m) | Margin (dB) | Detector Type |
|------------------------|-----------------|----------------------|--------------------|-----------------|-----------------------|-------------------------|-----------------|-------------|---------------|
| Low Channel 2402MHz | | | | | | | | | |
| V | 2402.00 | 104.83 | 38.06 | 7.42 | 20.15 | 94.34 | 114.00 | -19.66 | PK |
| V | 2402.00 | 88.88 | 38.06 | 7.42 | 20.15 | 78.39 | 94.00 | -15.61 | AV |
| V | 4804.00 | 55.17 | 38.53 | 7.78 | 23.25 | 47.67 | 74.00 | -26.33 | PK |
| V | 4804.00 | 41.69 | 38.53 | 7.78 | 23.25 | 34.19 | 54.00 | -19.81 | AV |
| V | 17850.00 | 40.36 | 38.75 | 10.36 | 26.57 | 38.54 | 74.00 | -35.46 | PK |
| H | 2402.00 | 105.95 | 38.06 | 7.42 | 20.15 | 95.46 | 114.00 | -18.54 | PK |
| H | 2402.00 | 89.50 | 38.06 | 7.42 | 20.15 | 79.01 | 94.00 | -14.99 | AV |
| H | 4804.00 | 52.29 | 38.53 | 7.78 | 23.25 | 44.79 | 74.00 | -29.21 | PK |
| H | 4804.00 | 44.21 | 38.53 | 7.78 | 23.25 | 36.71 | 54.00 | -17.29 | AV |
| H | 17850.00 | 40.58 | 38.75 | 10.36 | 26.57 | 38.76 | 74.00 | -35.24 | PK |
| Middle Channel 2440MHz | | | | | | | | | |
| V | 2440.00 | 107.23 | 38.11 | 7.44 | 20.36 | 96.92 | 114.00 | -17.08 | PK |
| V | 2440.00 | 89.34 | 38.11 | 7.44 | 20.36 | 79.03 | 94.00 | -14.97 | AV |
| V | 4880.00 | 53.77 | 38.65 | 7.80 | 23.61 | 46.53 | 74.00 | -27.47 | PK |
| V | 4880.00 | 42.33 | 38.65 | 7.80 | 23.61 | 35.09 | 54.00 | -18.91 | AV |
| V | 17850.00 | 42.37 | 38.75 | 10.36 | 26.57 | 40.55 | 74.00 | -33.45 | PK |
| H | 2440.00 | 105.99 | 38.11 | 7.44 | 20.36 | 95.68 | 114.00 | -18.32 | PK |
| H | 2440.00 | 89.10 | 38.11 | 7.44 | 20.36 | 78.79 | 94.00 | -15.21 | AV |
| H | 4880.00 | 53.88 | 38.65 | 7.80 | 23.61 | 46.64 | 74.00 | -27.36 | PK |
| H | 4880.00 | 43.05 | 38.65 | 7.80 | 23.61 | 35.81 | 54.00 | -18.19 | AV |
| H | 17850.00 | 41.09 | 38.75 | 10.36 | 26.57 | 39.27 | 74.00 | -34.73 | PK |
| High Channel 2480MHz | | | | | | | | | |
| V | 2480.00 | 105.84 | 38.17 | 7.47 | 20.51 | 95.65 | 114.00 | -18.35 | PK |
| V | 2480.00 | 89.19 | 38.17 | 7.47 | 20.51 | 79.00 | 94.00 | -15.00 | AV |
| V | 4960.00 | 54.07 | 38.69 | 7.83 | 23.83 | 47.04 | 74.00 | -26.96 | PK |
| V | 4960.00 | 42.83 | 38.69 | 7.83 | 23.83 | 35.80 | 54.00 | -18.20 | AV |
| V | 17850.00 | 41.10 | 38.75 | 10.36 | 26.57 | 39.28 | 74.00 | -34.72 | PK |
| H | 2480.00 | 106.84 | 38.17 | 7.47 | 20.51 | 96.65 | 114.00 | -17.35 | PK |
| H | 2480.00 | 90.49 | 38.17 | 7.47 | 20.51 | 80.30 | 94.00 | -13.70 | AV |
| H | 4960.00 | 53.31 | 38.69 | 7.83 | 23.83 | 46.28 | 74.00 | -27.72 | PK |
| H | 4960.00 | 42.99 | 38.69 | 7.83 | 23.83 | 35.96 | 54.00 | -18.04 | AV |
| H | 17850.00 | 41.70 | 38.75 | 10.36 | 26.57 | 39.88 | 74.00 | -34.12 | PK |

Remark:

- Emission Level = Meter Reading + Antenna Factor + Cable Loss – Pre-amplifier,
Margin= Emission Level - Limit
- If peak below the average limit, the average emission was no test.
- The amplitude of spurious emissions which are attenuated by more than 20dB below the permissible value has no need to be reported.



CONDUCTED EMISSION MEASUREMENT

GFSK

Low Channel 2402MHz

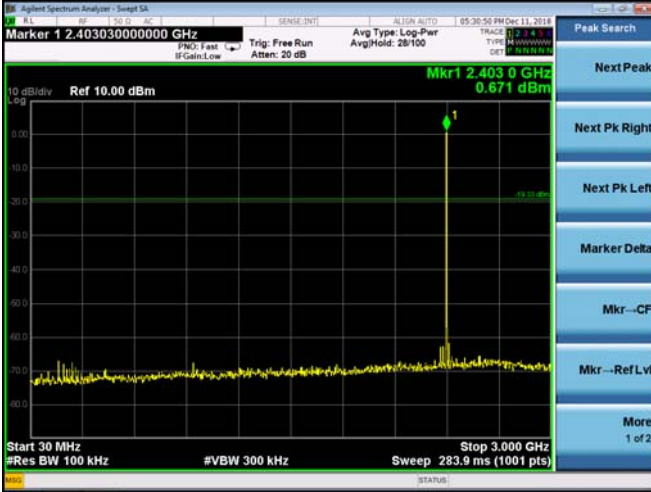

Middle Channel 2440MHz

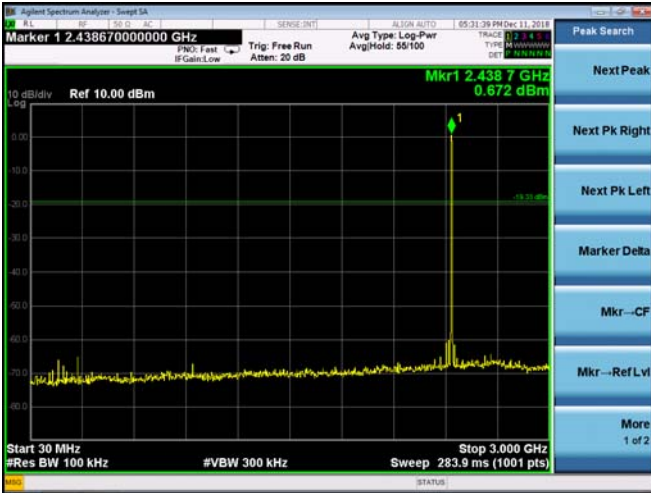

High Channel 2480MHz

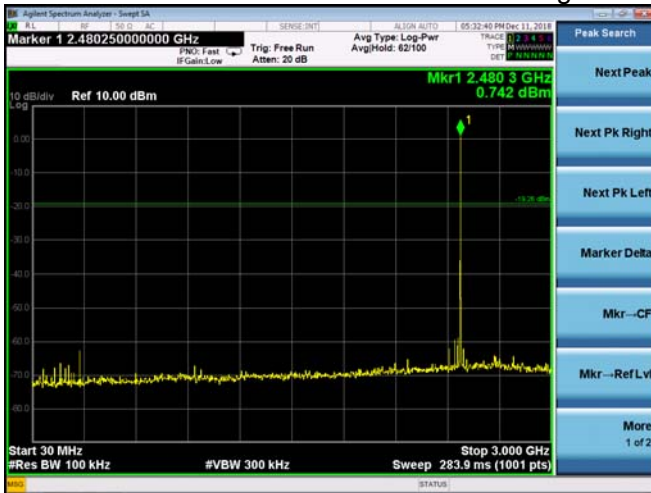

4. BANDWIDTH TEST

4.1 APPLIED PROCEDURES / LIMIT

| FCC Part15 (15.249) , Subpart C | | | | |
|---------------------------------|-----------|------------------|-----------------------|--------|
| Section | Test Item | Limit | Frequency Range (MHz) | Result |
| 15.249 | Bandwidth | (20dB bandwidth) | 2400-2483.5 | PASS |

| Spectrum Parameter | Setting |
|--------------------|---|
| Attenuation | Auto |
| Span Frequency | > Measurement Bandwidth or Channel Separation |
| RB | 100KHz |
| VB | \geq RBW |
| Detector | Peak |
| Trace | Max Hold |
| Sweep Time | Auto |

4.1.1 TEST PROCEDURE

- a. The EUT was directly connected to the spectrum analyzer and antenna output port as show in the block diagram below,
- b. Spectrum Setting : RBW= 100KHz, VBW \geq RBW, Sweep time = Auto.

4.1.2 DEVIATION FROM STANDARD

No deviation.

4.1.3 TEST SETUP

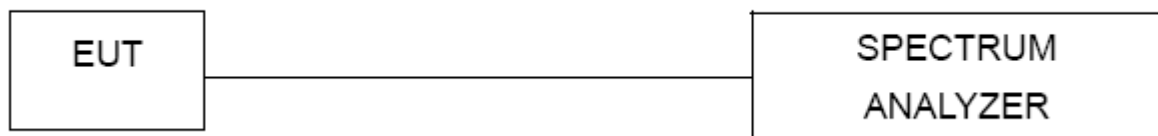

4.1.4 EUT OPERATION CONDITIONS

The EUT tested system was configured as the statements of 2.4 Unless otherwise a special operating condition is specified in the follows during the testing.

4.1.5 TEST RESULTS

| | | | |
|---------------|-------------------|---------------------|--------|
| Temperature : | 26 °C | Relative Humidity : | 54% |
| Pressure : | 101kPa | Test Voltage : | DC 12V |
| Test Mode : | CH01 / CH20 /CH40 | | |

| | Frequency | 20dB Bandwidth (KHz) | Result |
|------|-----------|----------------------|-------------|
| GFSK | 2402 MHz | 1233 | PASS |
| | 2440 MHz | 1237 | PASS |
| | 2480 MHz | 1235 | PASS |

GFSK

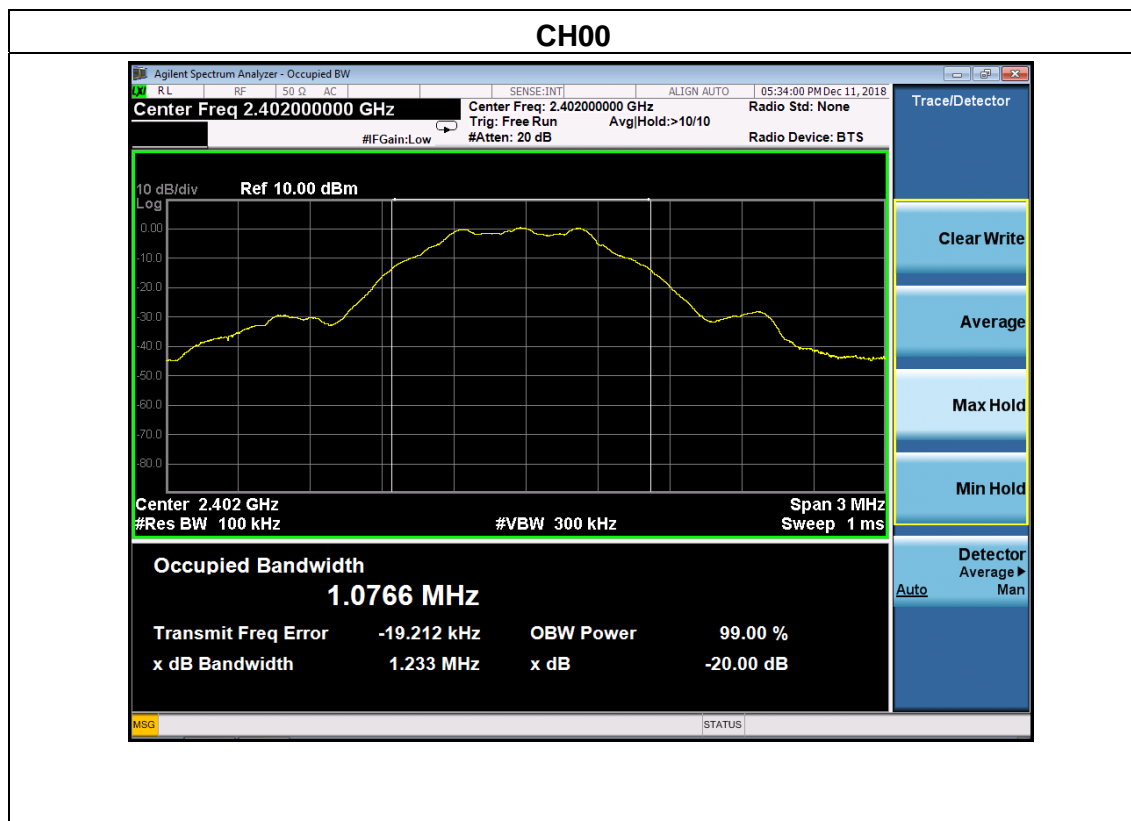



CH20

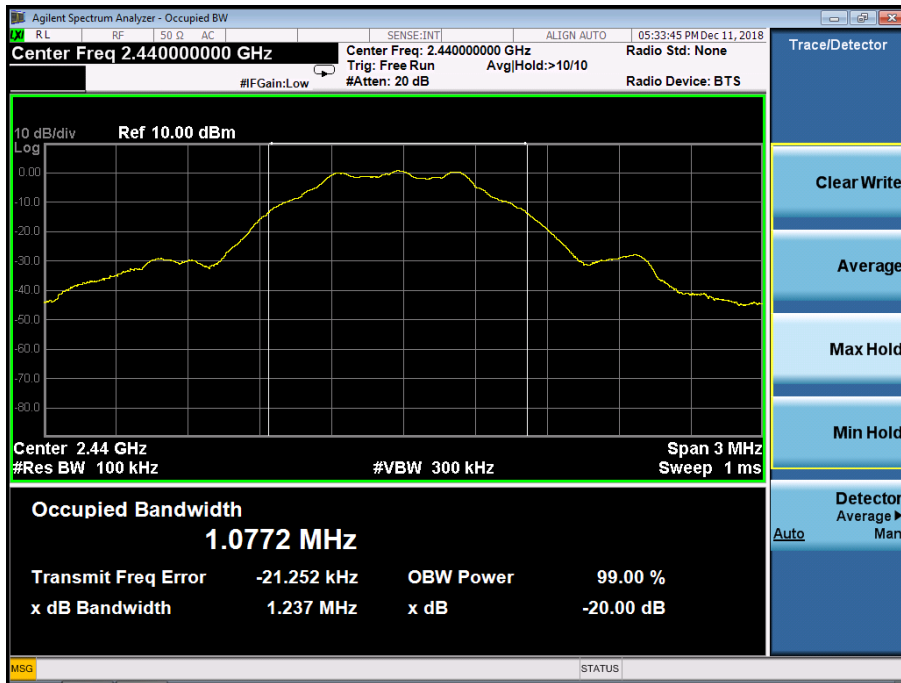

CH40

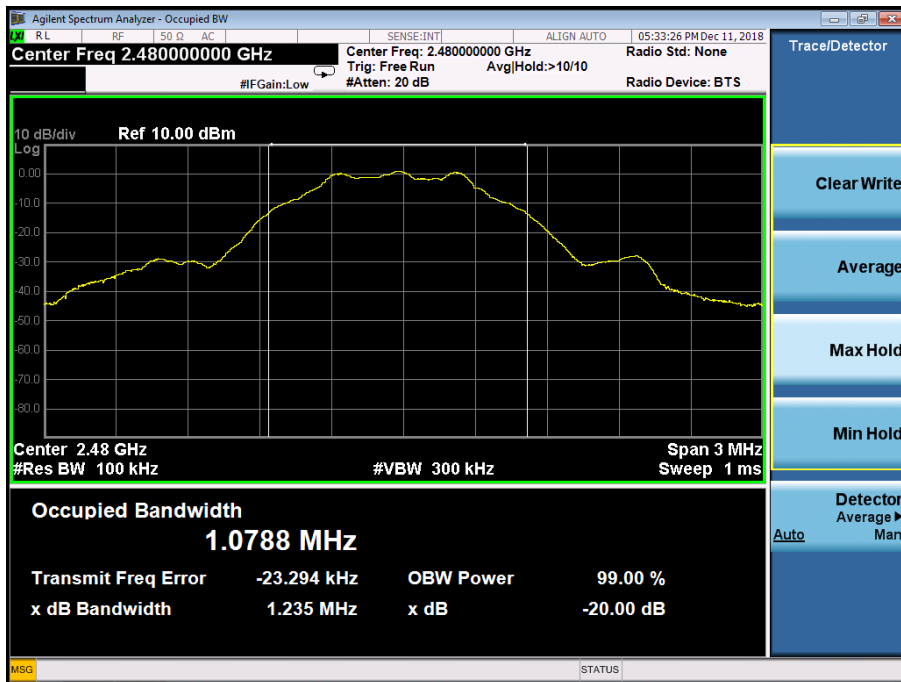

5. 100 KHZ BANDWIDTH OF FREQUENCY BAND EDGE APPLICABLE STANDARD

Emissions radiated outside of the specified frequency bands, except for harmonics, shall be attenuated by at least 50 dB below the level of the fundamental or to the general radiated emission limits in § 15.209, whichever is the lesser attenuation

TEST PROCEDURE

- a) Check the calibration of the measuring instrument using either an internal calibrator or a known signal from an external generator.
- b) Position the EUT without connection to measurement instrument. Turn on the EUT and connect its antenna terminal to measurement instrument via a low loss cable. Then set it to any one measured frequency within its operating range, and make sure the instrument is operated in its linear range.
- c) i) VBW for Peak, Quasi-peak, or Average Detector Function: $3 \times \text{RBW}$
- d) Repeat above procedures until all measured frequencies were complete.

Note:

Both horizontal and vertical antenna polarities were tested and performed pretest to three orthogonal axis. The worst case emissions were reported

5.1 DEVIATION FROM STANDARD

No deviation.

5.2 TEST SETUP

5.3 EUT OPERATION CONDITIONS

The EUT tested system was configured as the statements of 2.4 Unless otherwise a special operating condition is specified in the follows during the testing.

5.4 TEST RESULTS

| | | | |
|---------------|-----------|---------------------|--------|
| Temperature : | 26 °C | Relative Humidity : | 54% |
| Pressure : | 101kPa | Test Voltage : | DC 12V |
| Test Mode : | CH01/CH40 | | |

| | Polar (H/V) | Frequency (MHz) | Meter Reading (dBuV) | Pre-amplifier (dB) | Cable Loss (dB) | Antenna Factor (dB/m) | Emission level (dBuV/m) | Limits (dBuV/m) | | Result | |
|----------------------------|-----------------------------|-----------------|----------------------|--------------------|-----------------|-----------------------|-------------------------|-----------------|-------|--------|--|
| | | | | | | | PK | PK | AV | | |
| Low Channel 2402MHz | | | | | | | | | | | |
| GFSK | H | 2390.00 | 58.70 | 38.06 | 7.42 | 20.15 | 48.21 | 74.00 | 54.00 | PASS | |
| | H | 2400.00 | 57.51 | 38.06 | 7.42 | 20.15 | 47.02 | 74.00 | 54.00 | PASS | |
| | V | 2390.00 | 58.31 | 38.06 | 7.42 | 20.15 | 47.82 | 74.00 | 54.00 | PASS | |
| | V | 2400.00 | 56.42 | 38.06 | 7.42 | 20.15 | 45.93 | 74.00 | 54.00 | PASS | |
| | High Channel 2480MHz | | | | | | | | | | |
| | H | 2483.50 | 56.27 | 38.17 | 7.45 | 20.54 | 46.09 | 74.00 | 54.00 | PASS | |
| | H | 2483.50 | 58.10 | 38.17 | 7.45 | 20.54 | 47.92 | 74.00 | 54.00 | PASS | |
| | V | 2485.50 | 56.32 | 38.2 | 7.45 | 20.54 | 46.11 | 74.00 | 54.00 | PASS | |
| V | 2485.50 | 58.84 | 38.2 | 7.45 | 20.54 | 48.63 | 74.00 | 54.00 | PASS | | |

Remark:

- Emission Level = Meter Reading + Antenna Factor + Cable Loss – Pre-amplifier, Margin= Emission Level - Limit
- If the PK measured levels comply with average limit, then the average level were deemed to comply with average limit.



2402 Horizontal

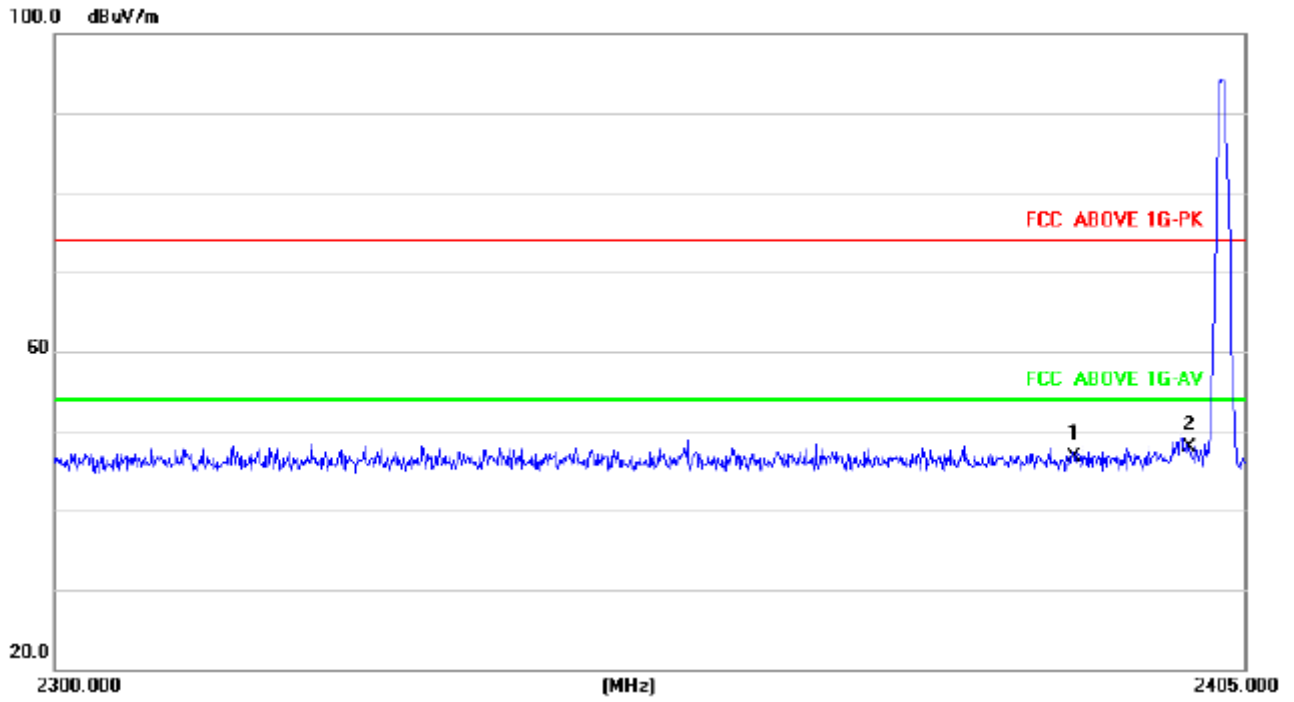

2402 Vertical

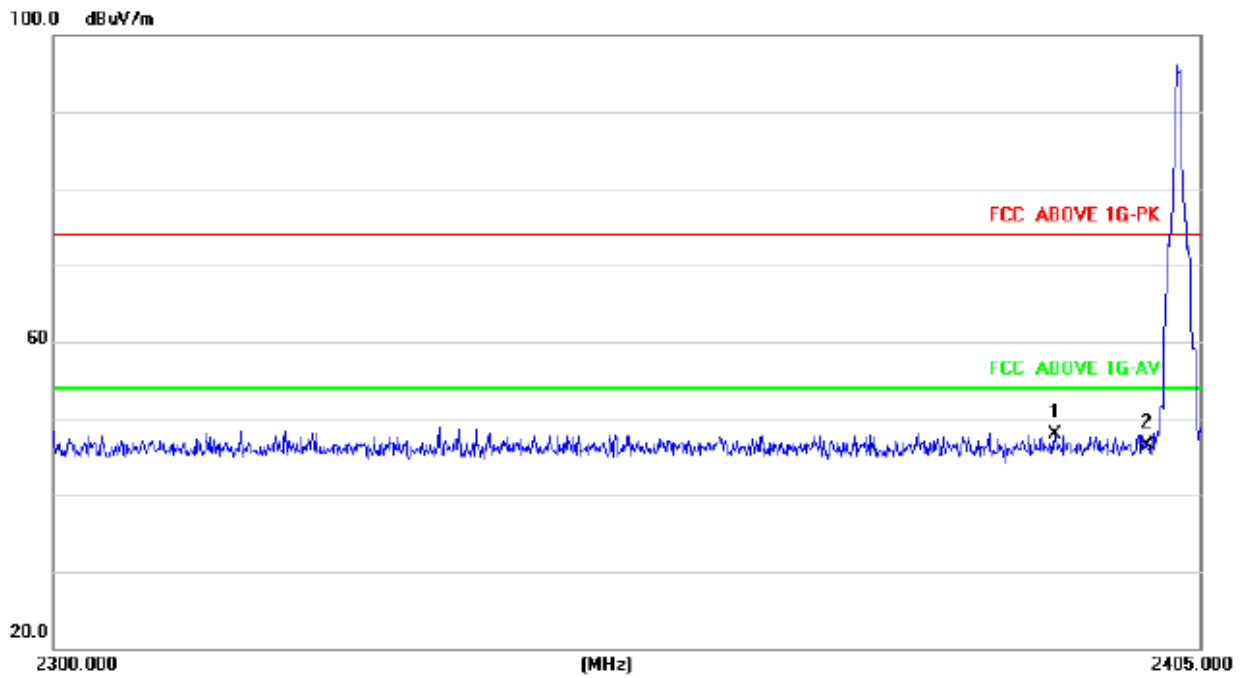



2480MHz Horizontal

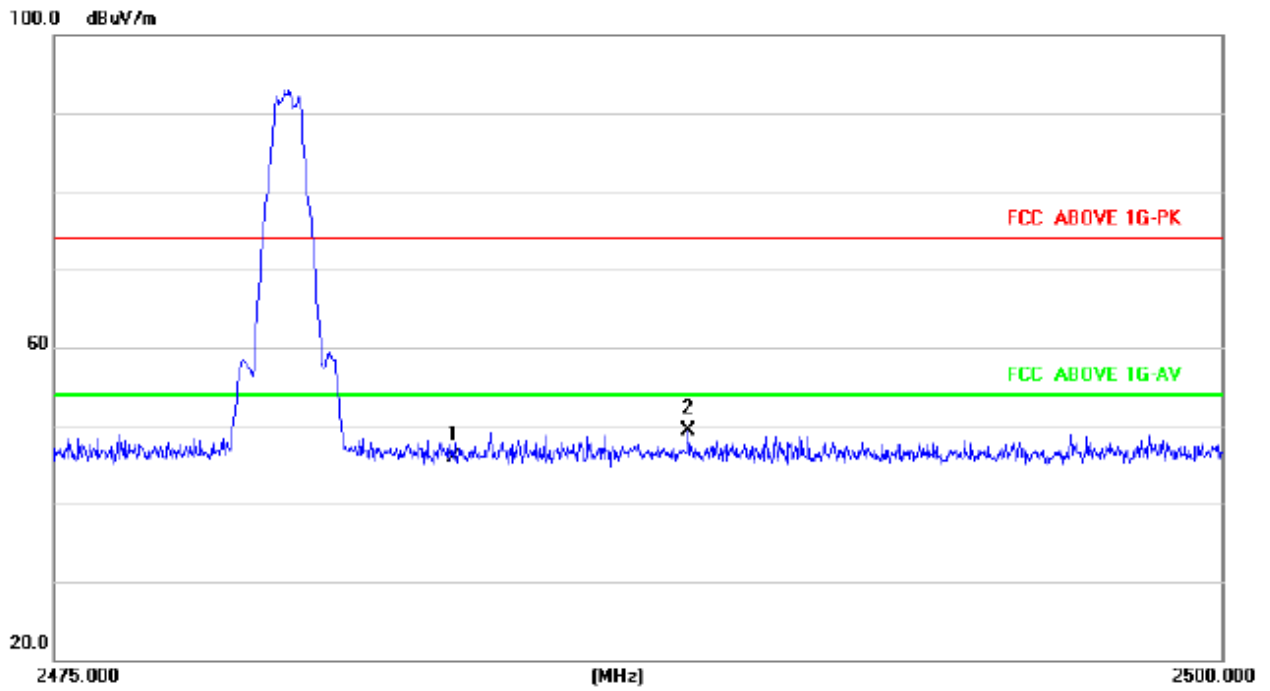

2480MHz Vertical

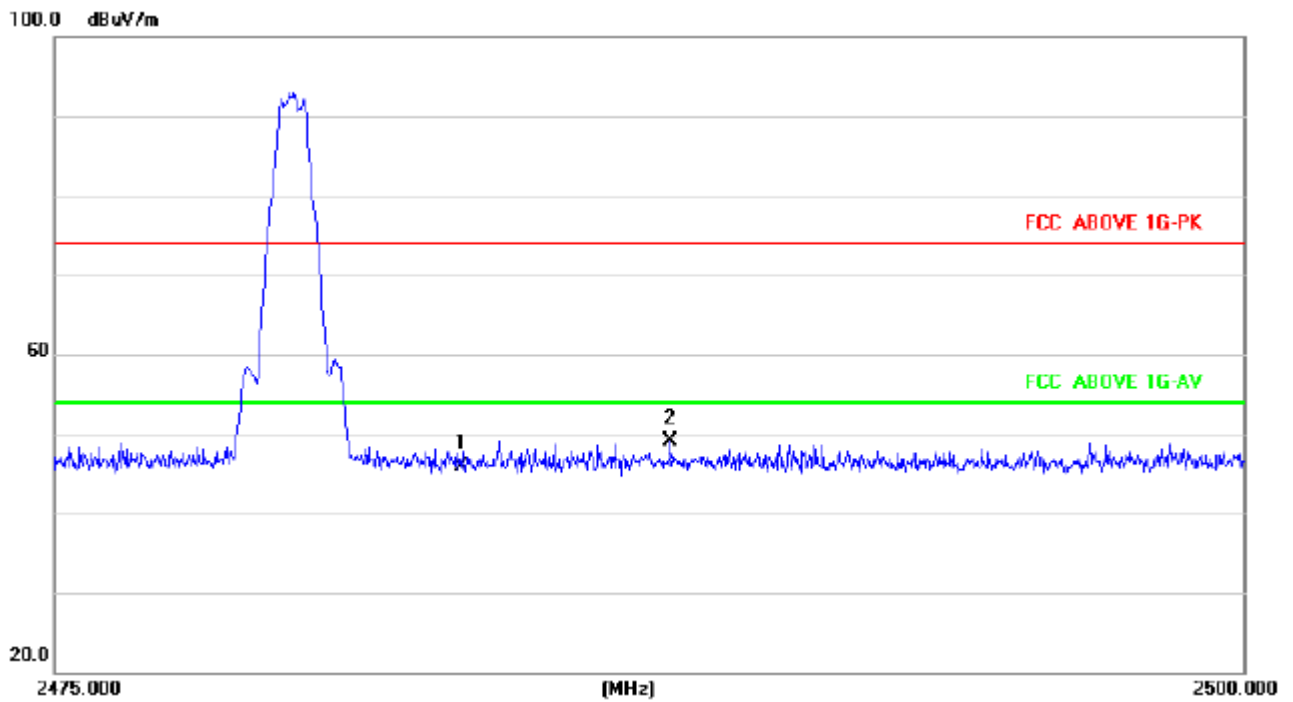



6. ANTENNA REQUIREMENT

6.1 STANDARD REQUIREMENT

15.203 requirement: For intentional device, according to 15.203: an intentional radiator shall be designed to ensure that no antenna other than that furnished by the responsible party shall be used with the device.

6.2 EUT ANTENNA

The EUT antenna is PCB Antenna. It complies with the standard requirement.

7. EUT TEST PHOTO

Radiated Measurement Photos

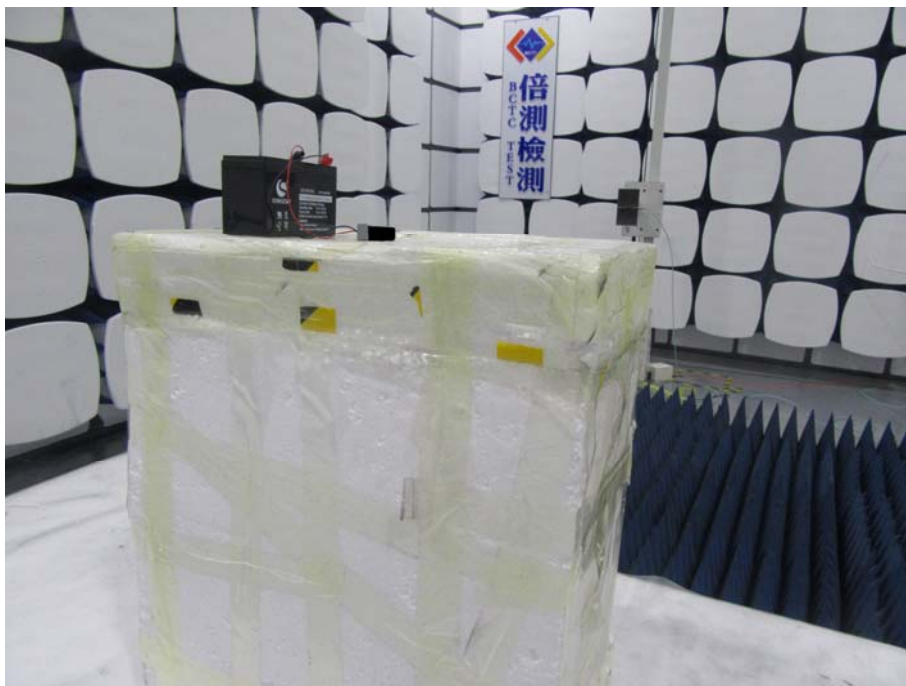
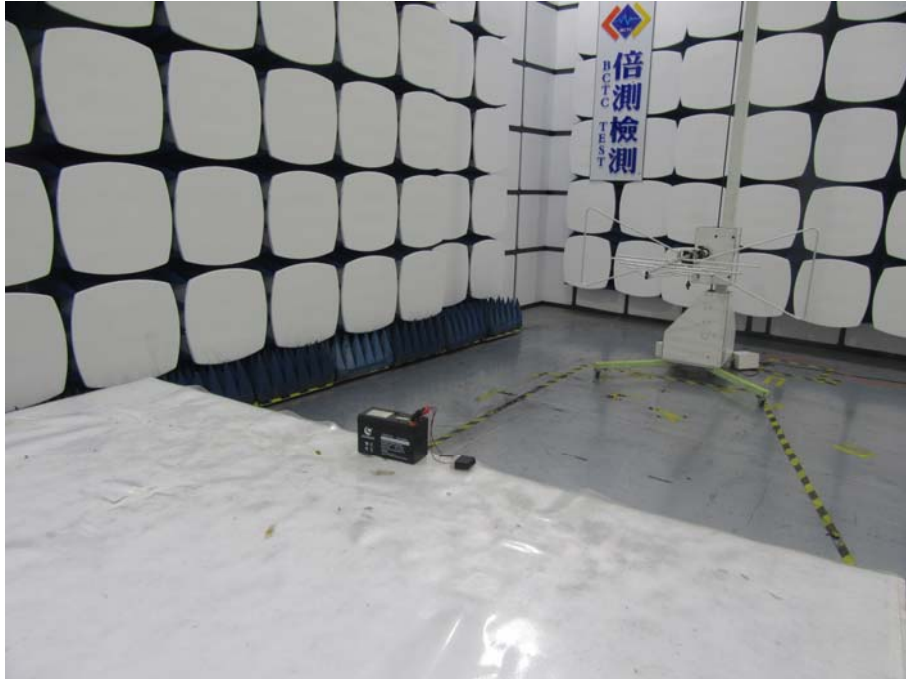



8. PHOTOS OF THE EUT





***** END OF REPORT *****