

FCC - TEST REPORT

Report Number : **68.910.20.0001.01** Date of Issue: March 13, 2020

Model : V4

Product Type : Wireless headphones

Applicant : Dongguan Beevo Industrial Co., Ltd

Address : No.1, Jinlong Road, Jinyuling Industrial Zone Sangyuan,
Dongcheng District, Dongguan

Manufacturer : Dongguan Beevo Industrial Co., Ltd

Address : No.1, Jinlong Road, Jinyuling Industrial Zone Sangyuan,
Dongcheng District, Dongguan

Test Result : **Positive** **Negative**

Total pages including Appendices : 41

TÜV SÜD CERTIFICATION AND TESTING (CHINA) CO., LTD. SHENZHEN BRANCH is a subcontractor to TÜV SÜD Product Service GmbH according to the principles outlined in ISO 17025. TÜV SÜD CERTIFICATION AND TESTING (CHINA) CO., LTD. SHENZHEN BRANCH reports apply only to the specific samples tested under stated test conditions. Construction of the actual test samples has been documented. It is the manufacturer's responsibility to assure that additional production units of this model are manufactured with identical electrical and mechanical components. The manufacturer/importer is responsible to the Competent Authorities in Europe for any modifications made to the production units which result in non-compliance to the relevant regulations TÜV SÜD CERTIFICATION AND TESTING (CHINA) CO., LTD. SHENZHEN BRANCH shall have no liability for any deductions, inferences or generalizations drawn by the client or others from TÜV SÜD CERTIFICATION AND TESTING (CHINA) CO., LTD. SHENZHEN BRANCH issued reports. This report is the confidential property of the client. As a mutual protection to our clients, the public and ourselves, extracts from the test report shall not be reproduced except in full without our written approval.



1 Table of Contents

1	Table of Contents.....	2
2	Details about the Test Laboratory.....	3
3	Description of the Equipment Under Test.....	4
4	Summary of Test Standards.....	5
5	Summary of Test Results.....	6
6	General Remarks.....	7
7	Test Setups.....	8
8	Technical Requirement.....	9
8.1	Conducted peak output power.....	9
8.2	20 dB bandwidth.....	13
8.3	Carrier Frequency Separation.....	17
8.4	Number of hopping frequencies.....	19
8.5	Dwell Time.....	21
8.6	Conducted Spurious Emission.....	25
8.7	Band edge testing.....	32
8.8	Spurious radiated emissions for transmitter.....	36
9	Test Equipment List.....	40
10	System Measurement Uncertainty.....	41



2 Details about the Test Laboratory

Details about the Test Laboratory

Company name: TÜV SÜD Certification and Testing (China) Co., Ltd. Shenzhen Branch
Building 12 & 13, Zhiheng Wisdomland Business Park, Nantou Checkpoint
Road 2, Nanshan District
Shenzhen 518052
P.R. China

Telephone: 86 755 8828 6998
Fax: 86 755 828 5299

FCC Registration No.: 514049

3 Description of the Equipment Under Test

Product name:	Wireless headphones
Model no.:	V4
FCC ID:	2ASDY-V4
Options and accessories:	NIL
Input:	5Vdc, 210mA by USB port, or 3.7V 250mAh by internal battery
RF Transmission Frequency:	2402MHz-2480MHz
No. of Operated Channel:	79
Modulation:	GFSK, $\pi/4$ -DQPSK
Antenna Type:	Integrated antenna
Antenna Gain:	-0.58dBi
Description of the EUT:	V4 is a wireless headphones with Bluetooth function.



4 Summary of Test Standards

Test Standards	
FCC Part 15 Subpart C 10-1-2019 Edition	PART 15 - RADIO FREQUENCY DEVICES Subpart C - Intentional Radiators

All the test methods were according to KDB558074 D01 15.247 Meas Guidance v05r02 and ANSI C63.10 (2013).

5 Summary of Test Results

Test Condition		Test Result
§15.207	Conducted emission AC power port	N/A
§15.247(b)(1)	Conducted peak output power	Pass
§15.247(e)	Power spectral density*	N/A
§15.247(a)(2)	6dB bandwidth	N/A
§15.247(a)(1)	20dB bandwidth	Pass
§15.247(a)(1)	Min. of Hopping Channel Carrier Frequency Separation	Pass
§15.247(a)(1)(iii)	Min number of hopping frequencies	Pass
§15.247(a)(1)(iii)	Dwell Time - Average Time of Occupancy	Pass
§15.247(d)	Spurious RF conducted emissions	Pass
§15.247(d)	Band edge	Pass
§15.247(d) & §15.209 &	Spurious radiated emissions for transmitter and receiver	Pass
§15.203	Antenna requirement	See Note 2

Note 1: N/A=Not Applicable.

Note 2: The EUT uses a Integrated antenna, which gain is -0.58dBi. In accordance to §15.203, it is considered sufficiently to comply with the provisions of this section.

6 General Remarks

Remarks

This submittal(s) (test report) is intended for FCC ID: 2ASDY-V4, complies with Section 15.209, 15.247 of the FCC Part 15, Subpart C rules.

This report is only for Bluetooth BR EDR. The TX and RX range is 2402MHz-2480MHz.

SUMMARY:

All tests according to the regulations cited on page 5 were

■ - Performed

□ - **Not** Performed

The Equipment Under Test

■ - **Fulfills** the general approval requirements.

□ - **Does not** fulfill the general approval requirements.

Sample Received Date: January 14, 2020

Testing Start Date: January 15, 2020

Testing End Date: March 16, 2020

Reviewed by:

Prepared by:

Tested by:



John Zhi
Section Manager



Moon Xiong
Project Engineer



Louise Liu
Test Engineer

7 Test Setups

7.1 Radiated test setups Below 1GHz

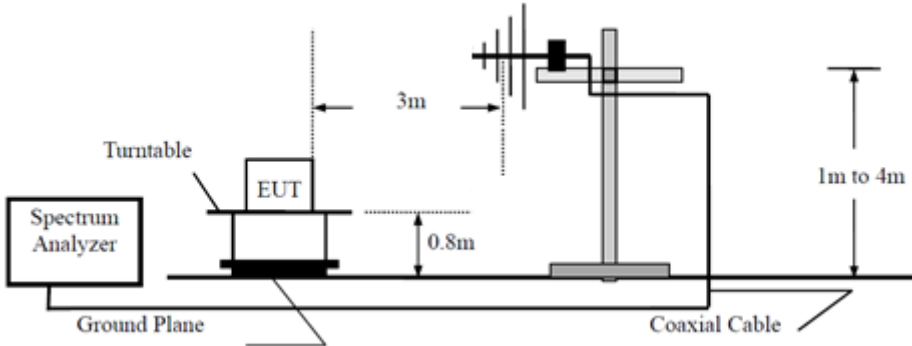

Above 1GHz

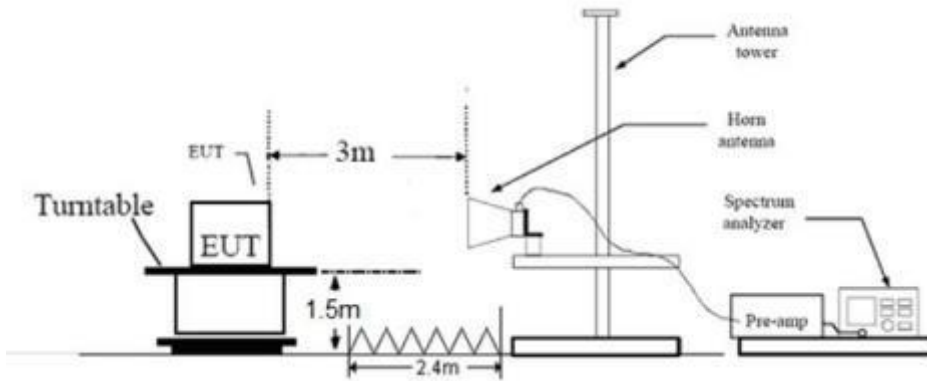

7.2 Conducted RF test setups

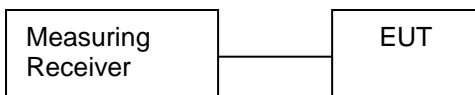



8 Technical Requirement

8.1 Conducted peak output power

Test Method

1. Use the following spectrum analyzer settings:
 Span = approximately 5 times the 20 dB bandwidth, centered on a hopping channel
 RBW > the 20 dB bandwidth of the emission being measured, VBW ≥ RBW,
 Sweep = auto, Detector function = peak, Trace = max hold
2. Add a correction factor to the display.
3. Allow the trace to stabilize. Use the marker-to-peak function to set the marker to the peak of the emission. The indicated level is the peak output power

Limits

Frequency Range MHz	Limit W	Limit dBm
2400-2483.5	≤1	≤30

Conducted peak output power

Bluetooth Mode GFSK modulation Test Result

Frequency MHz	Conducted Peak Output Power dBm	Result
Low channel 2402MHz	-9	Pass
Middle channel 2441MHz	-8.7	Pass
High channel 2480MHz	-8.58	Pass

Bluetooth Mode $\pi/4$ -DQPSK modulation Test Result

Frequency MHz	Conducted Peak Output Power dBm	Result
Low channel 2402MHz	-8.23	Pass
Middle channel 2441MHz	-7.91	Pass
High channel 2480MHz	-7.79	Pass

Test graphs

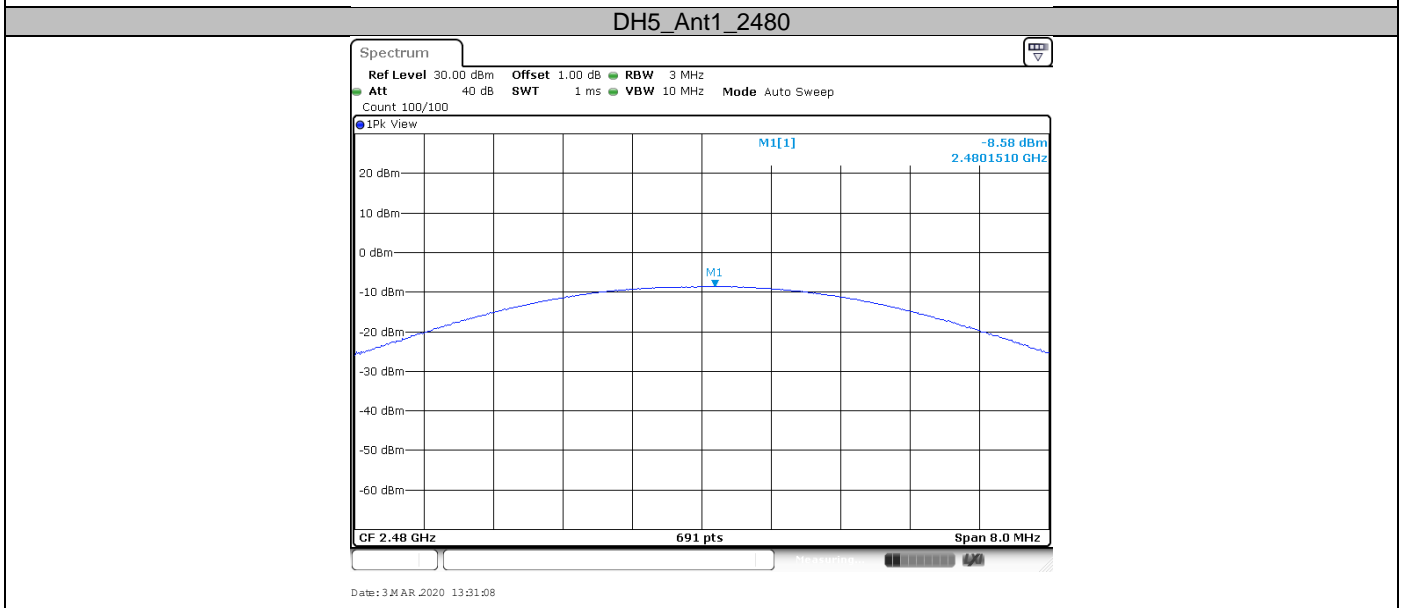
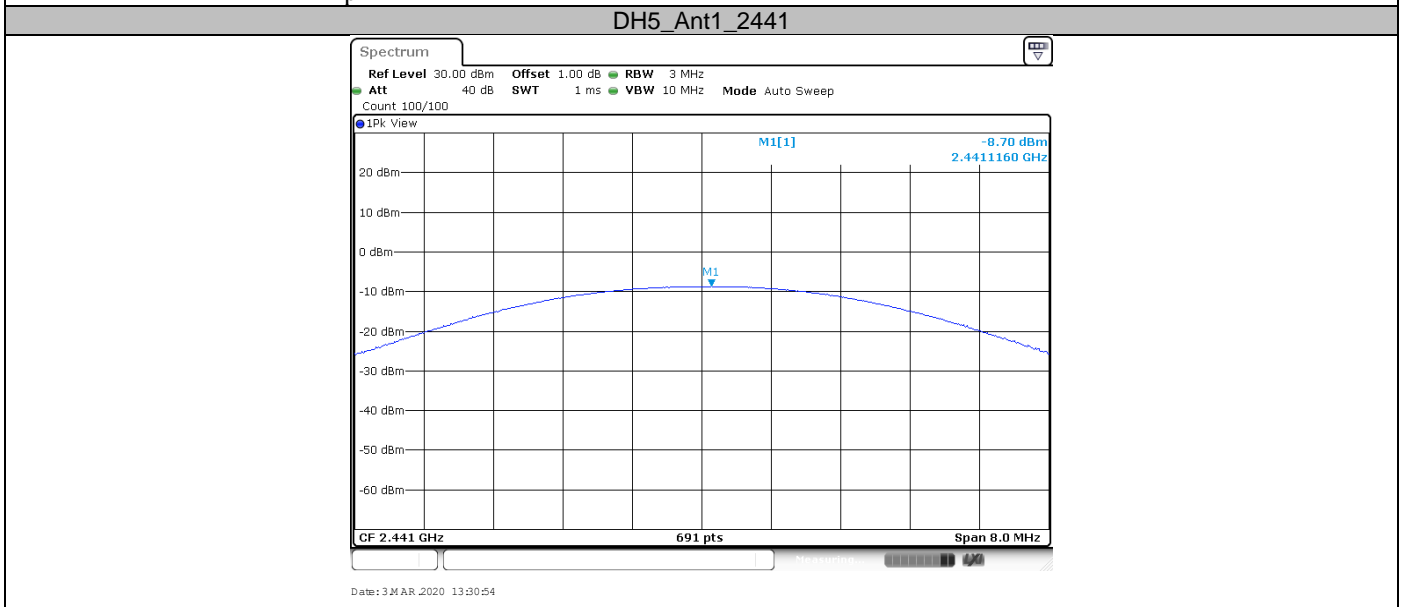
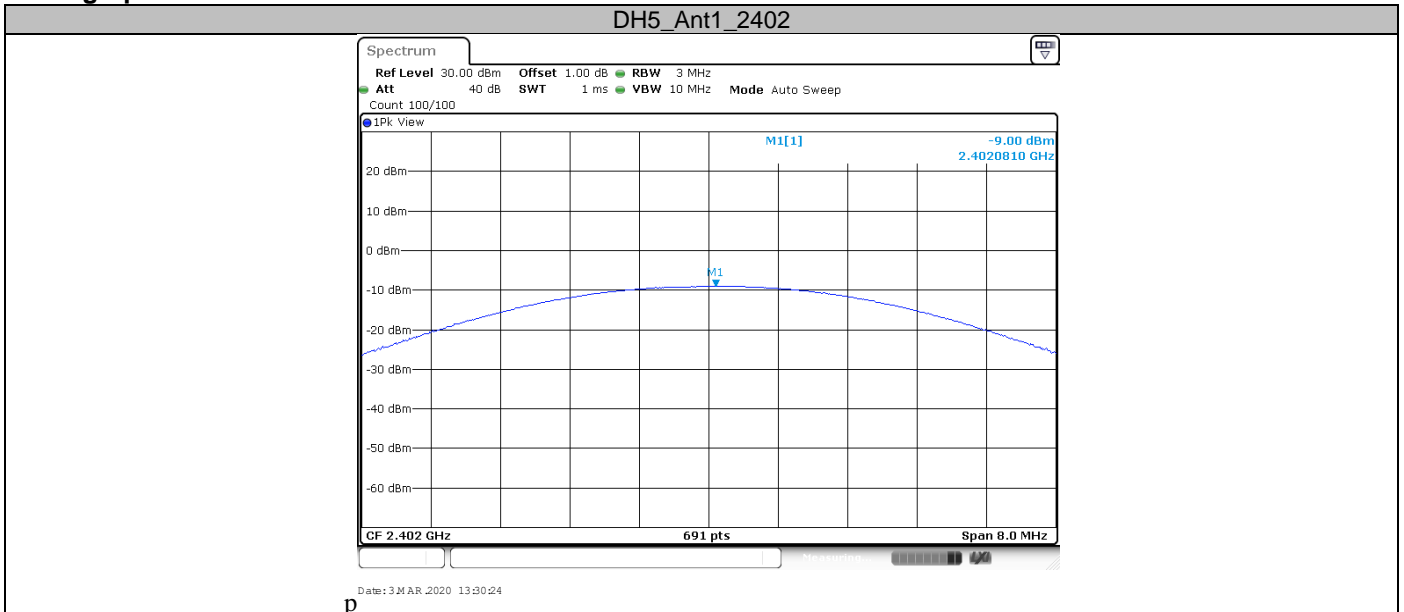

2DH5_Ant1_2402

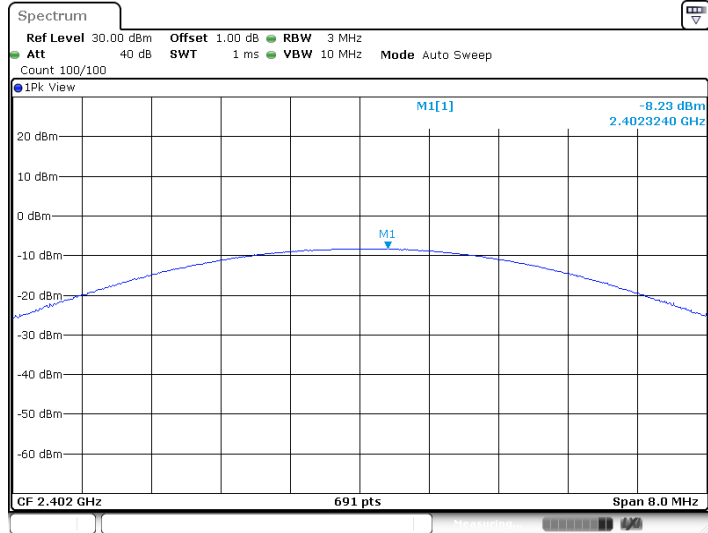

2DH5_Ant1_2441

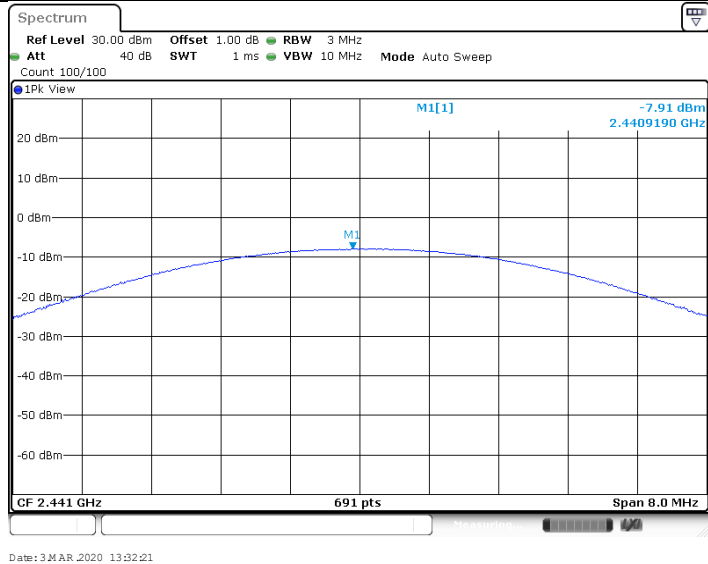

2DH5_Ant1_2480

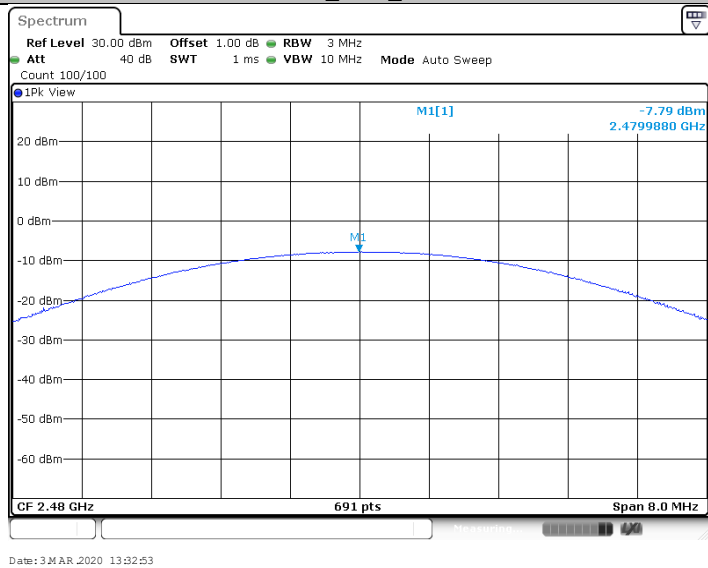

8.2 20 dB bandwidth

Test Method

1. Check the calibration of the measuring instrument using either an internal calibrator or a known signal from an external generator.
2. Position the EUT without connection to measurement instrument. Turn on the EUT and connect it to measurement instrument. Then set it to any one convenient frequency within its operating range. Set a reference level on the measuring instrument equal to the highest peak value.
3. Measure the frequency difference of two frequencies that were attenuated 20 dB from the reference level. Record the frequency difference as the emission bandwidth.
4. Repeat above procedures until all frequencies measured were complete.

Limit

Limit [kHz]

N/A

20 dB bandwidth

Bluetooth Mode GFSK Modulation test result

Frequency MHz	20 dB Bandwidth kHz	Limit kHz	Result
2402	1107	--	Pass
2441	1107	--	Pass
2480	1110	--	Pass

20 dB bandwidthBluetooth Mode $\pi/4$ -DQPSK Modulation test result

Frequency MHz	20 dB Bandwidth kHz	Limit kHz	Result
2402	1377	--	Pass
2441	1377	--	Pass
2480	1374	--	Pass

DH5_Ant1_2402

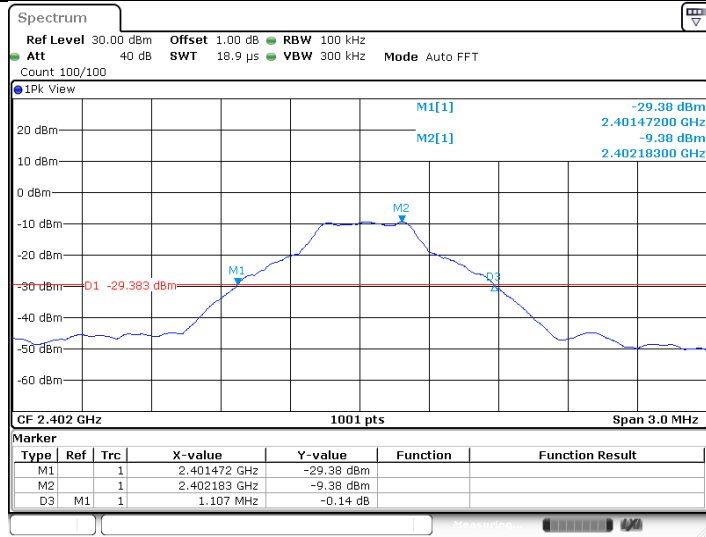

Date: 3 MAR 2020 12:56:54

DH5_Ant1_2441

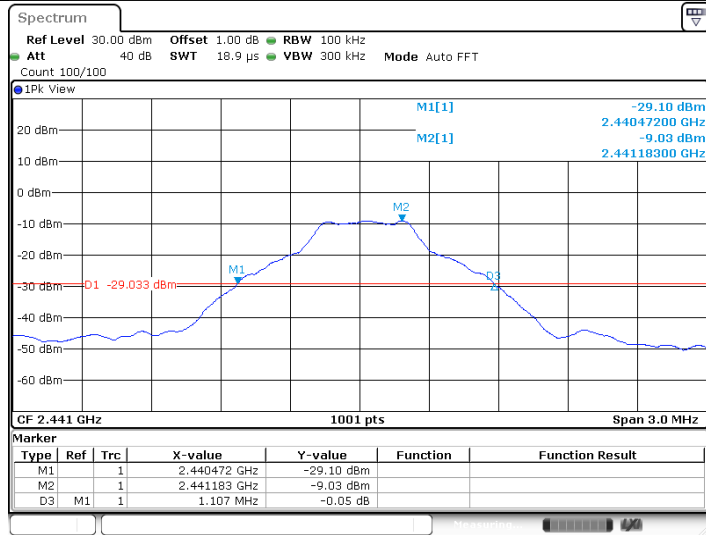

Date: 3 MAR 2020 13:02:19

DH5_Ant1_2480

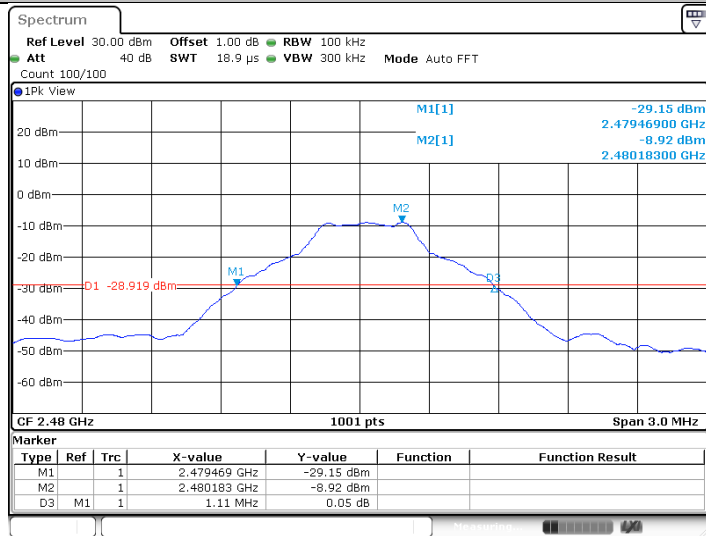

Date: 3 MAR 2020 13:00:27

2DH5_Ant1_2402

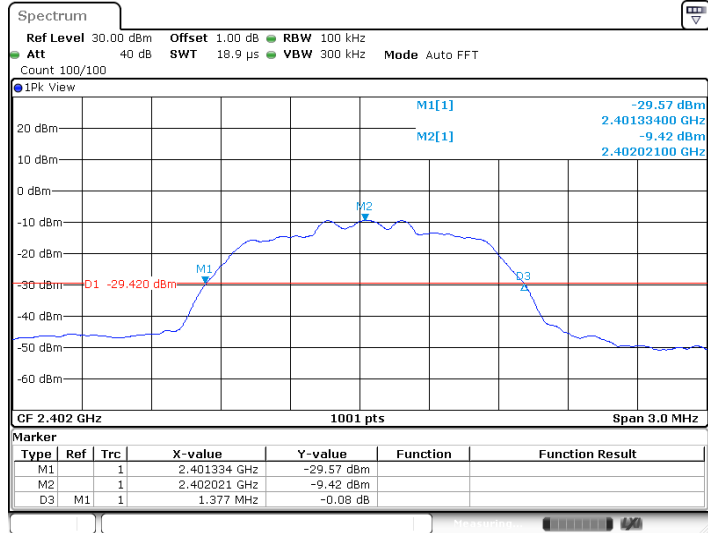

Date: 3 MAR 2020 13:12:22

2DH5_Ant1_2441

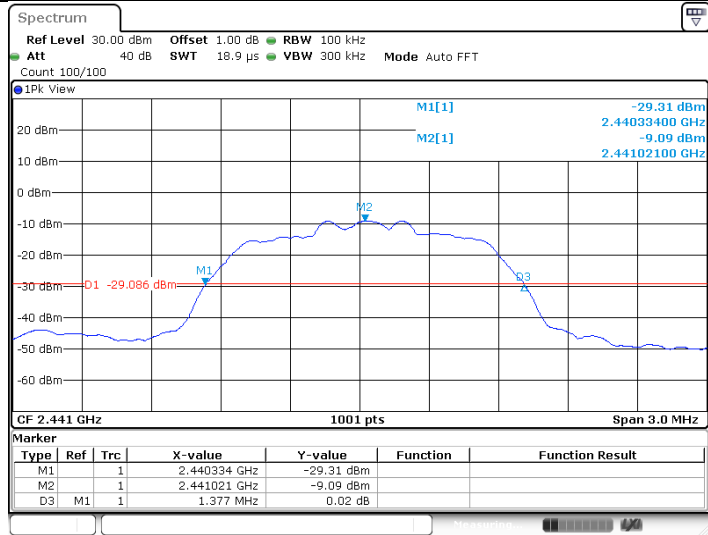

Date: 3 MAR 2020 13:14:30

2DH5_Ant1_2480

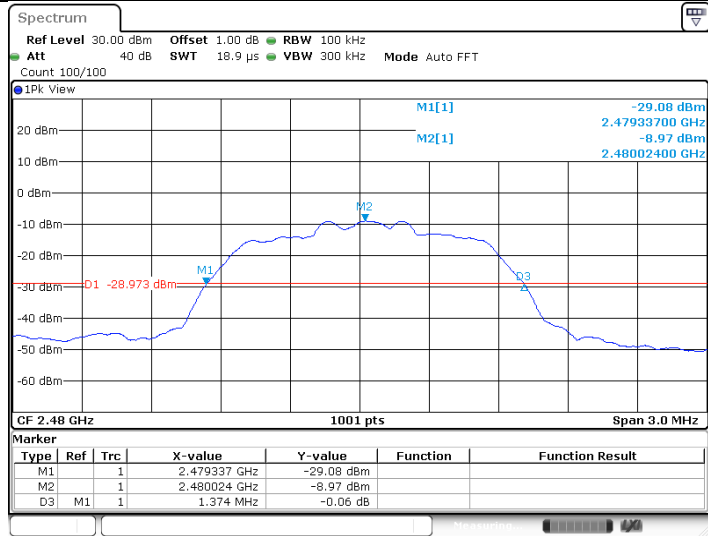

Date: 3 MAR 2020 13:18:15

8.3 Carrier Frequency Separation

Test Method

1. Use the following spectrum analyzer settings:
Span = wide enough to capture the peaks of two adjacent channels, $RBW \geq 1\%$ of the span, $VBW \geq RBW$, Sweep = auto, Detector function = peak
2. By using the Max-Hold function record the separation of two adjacent channels.
3. Measure the frequency difference of these two adjacent channels by spectrum analyzer marker function.
4. Repeat above procedures until all frequencies measured were complete.

Limit

Limit
kHz

$\geq 25\text{kHz}$ or $2/3$ of the 20 dB bandwidth which is greater

Carrier Frequency Separation

Test Mode	Antenna	Channel	Result(MHz)	Limit	Verdict
DH5	Ant1	Hop	0.841	>=0.750	PASS
2DH5	Ant1	Hop	1.003	>=0.946	PASS

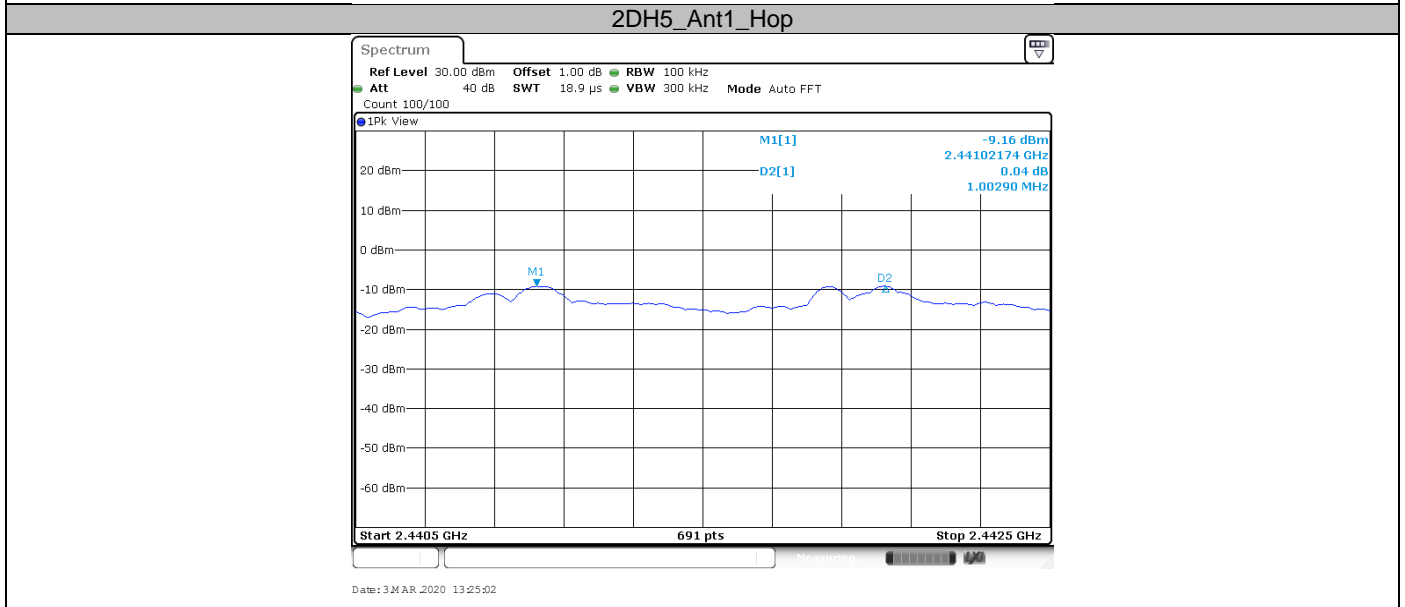
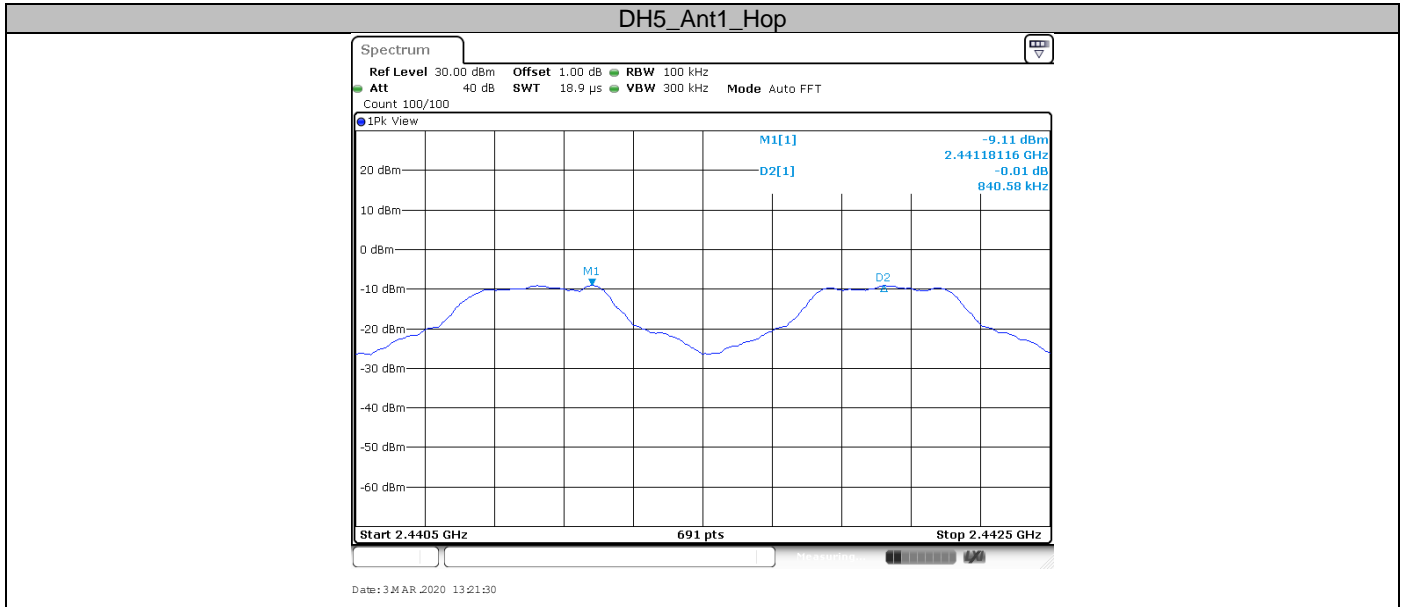

8.4 Number of hopping frequencies

Test Method

1. Use the following spectrum analyzer settings:
Span = wide enough to capture the peaks of two adjacent channels, $RBW \geq 1\%$ of the span, $VBW \geq RBW$, Sweep = auto, Detector function = peak
2. Set the spectrum analyzer on Max-Hold Mode, and then keep the EUT in hopping mode.
3. Record all the signals from each channel until each one has been recorded.
4. Repeat above procedures until all frequencies measured were complete.

Limit

**Limit
number**
—————
 ≥ 15

Number of hopping frequencies

Test result: The measurement was performed with the typical configuration (normal hopping status), and the total hopping channels is constant for the all modulation mode according with the Bluetooth Core Specification. Here GFSK modulation mode was used to show compliance.

Number of hopping frequencies	Result
79	Pass

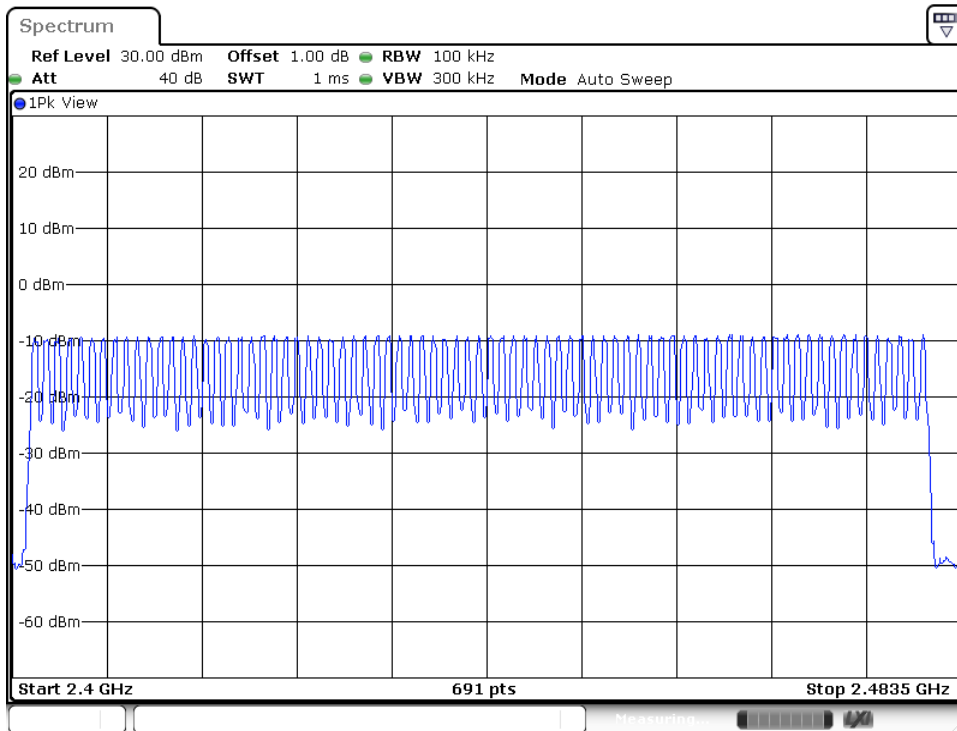

Date: 3 MAR 2020 13:21:51

8.5 Dwell Time

Test Method

1. Connect EUT antenna terminal to the spectrum analyzer with a low loss cable.
Equipment mode: Spectrum analyzer
2. RBW: 1MHz; VBW: 1MHz; SPAN: Zero Span
3. Adjust the center frequency of spectrum analyzer on any frequency be measured.
4. Measure the Dwell Time by spectrum analyzer Marker function.
5. Repeat above procedures until all frequencies measured were complete.

Limit

The average time of occupancy on any frequency shall not be greater than 0.4 seconds within a period of 0.4 seconds multiplied by the number of hopping channels employed.

Dwell Time

Dwell time

The maximum dwell time shall be 0.4 s.

The Dwell Time = Burst Width * Total Hops. The detailed calculations are showed as follows:

The duration for dwell time calculation: $0.4 \text{ [s]} * \text{hopping number} = 0.4 \text{ [s]} * 79 \text{ [ch]} = 31.6 \text{ [s*ch]}$;

Test Result

Test Mode	Antenna	Channel	Burst Width	Total Hops	Result	Limit	Verdict
DH5	Ant1	Hop	2.91	80	0.233	≤ 0.4	PASS
2DH5	Ant1	Hop	2.92	100	0.292	≤ 0.4	PASS

DH5_Ant1_Hop

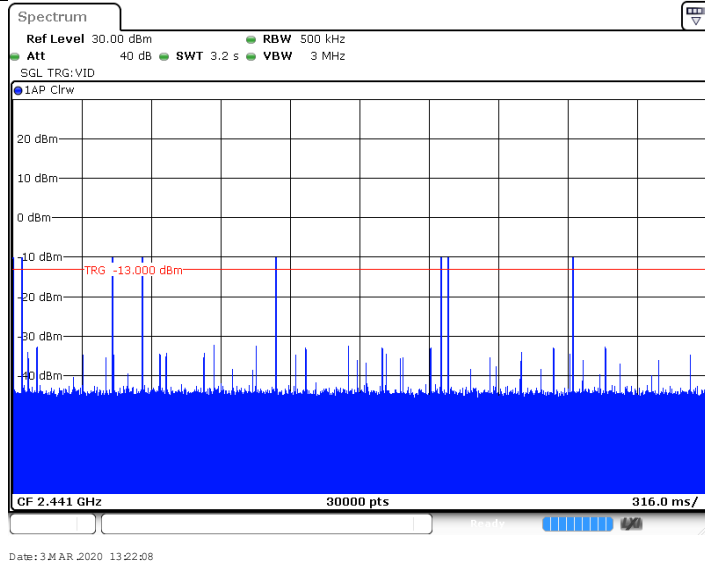
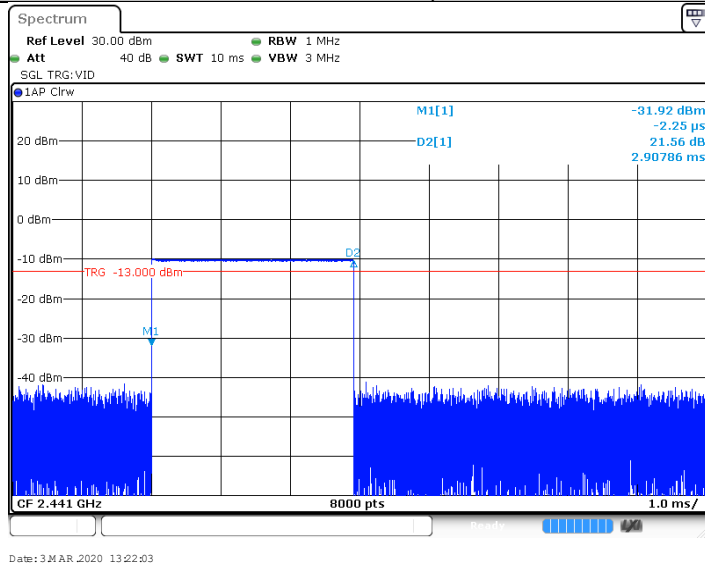

2DH5_Ant1_Hop

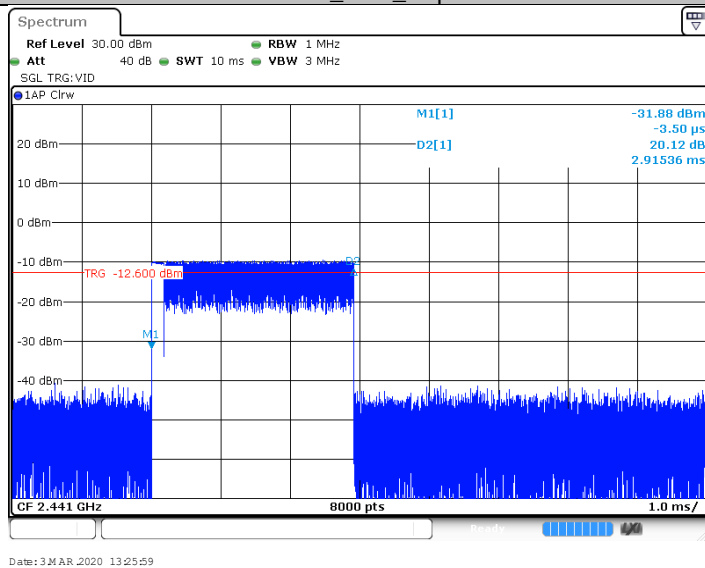

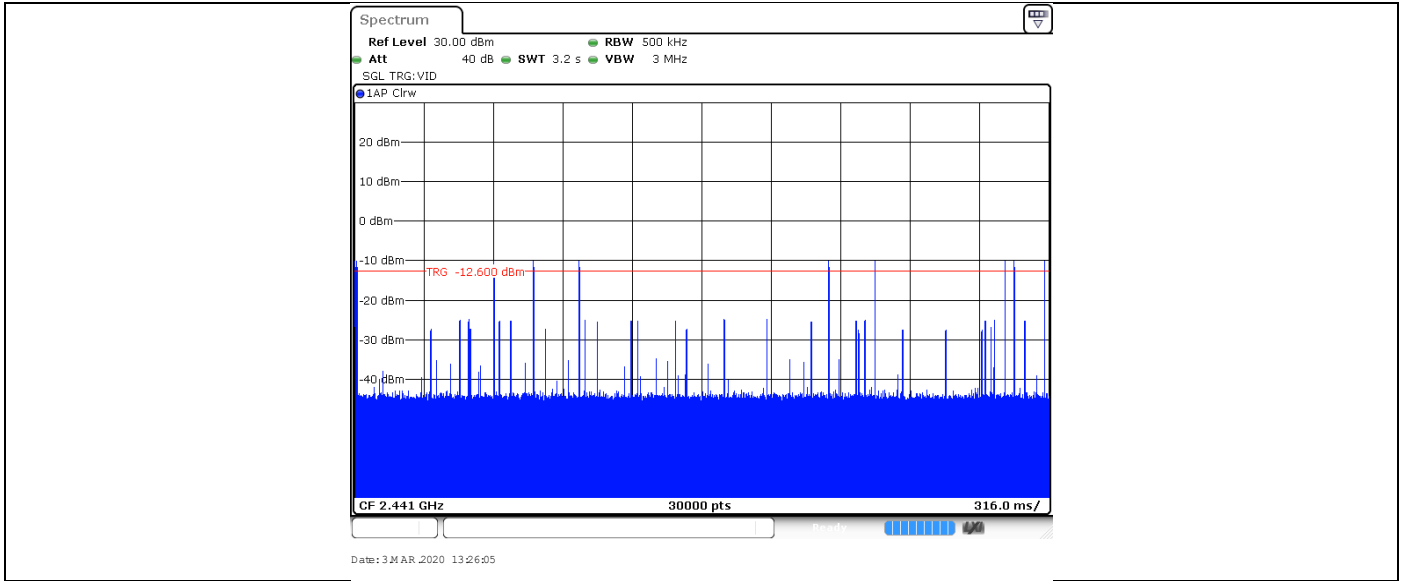



8.6 Conducted Spurious Emission

Test result:

TestMode	Channel	FreqRange(MHz)	RefLevel	Result(dBm)	Limit(dBm)	Verdict
DH5	2402	Reference	-9.37	-9.37	---	PASS
	2402	30~1000	30~1000	-59.87	<=-29.37	PASS
	2402	1000~26500	1000~26500	-52.01	<=-29.37	PASS
	2441	Reference	-9.10	-9.10	---	PASS
	2441	30~1000	30~1000	-60.75	<=-29.1	PASS
	2441	1000~26500	1000~26500	-52.39	<=-29.1	PASS
	2480	Reference	-8.85	-8.85	---	PASS
	2480	30~1000	30~1000	-62.61	<=-28.85	PASS
	2480	1000~26500	1000~26500	-52.57	<=-28.85	PASS
2DH5	2402	Reference	-9.41	-9.41	---	PASS
	2402	30~1000	30~1000	-62.66	<=-29.41	PASS
	2402	1000~26500	1000~26500	-52.05	<=-29.41	PASS
	2441	Reference	-9.18	-9.18	---	PASS
	2441	30~1000	30~1000	-64.76	<=-29.18	PASS
	2441	1000~26500	1000~26500	-52.62	<=-29.18	PASS
	2480	Reference	-8.93	-8.93	---	PASS
	2480	30~1000	30~1000	-64.26	<=-28.93	PASS
	2480	1000~26500	1000~26500	-52.66	<=-28.93	PASS

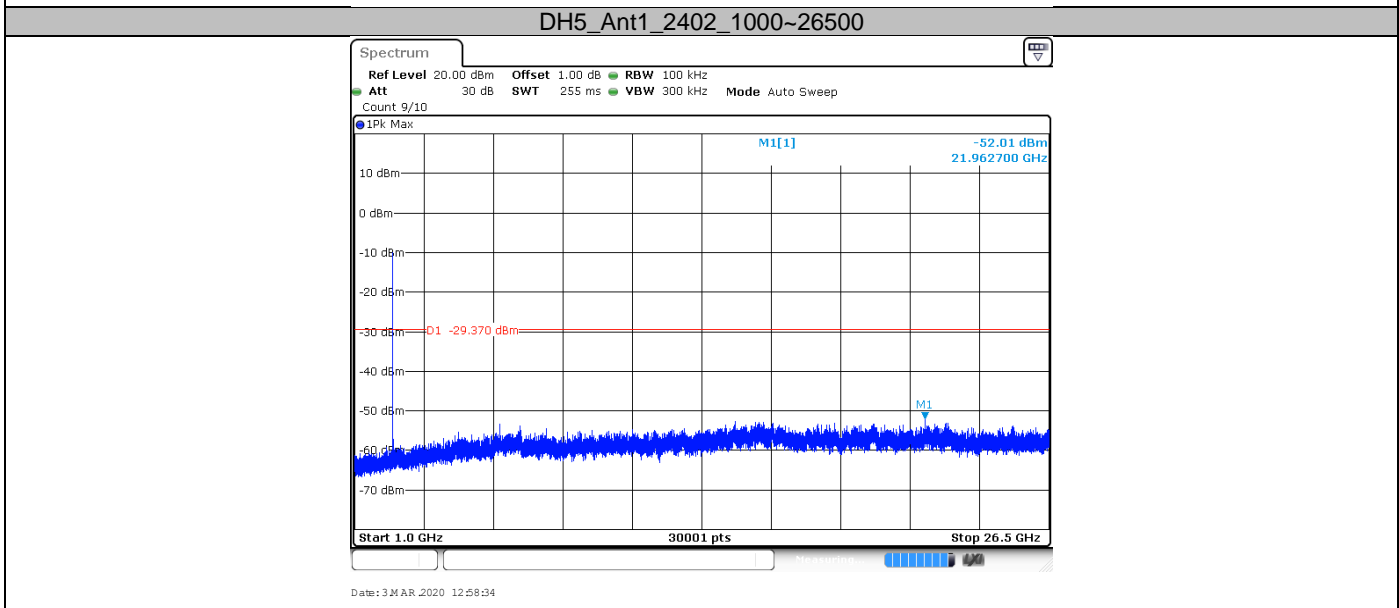
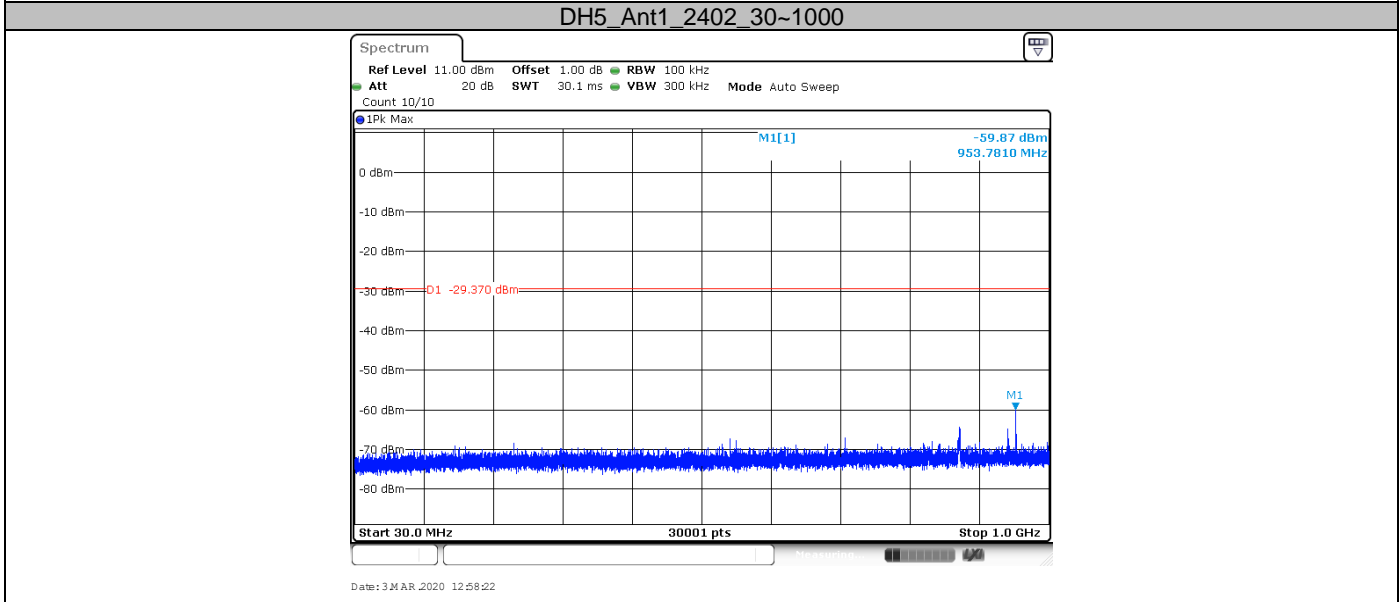
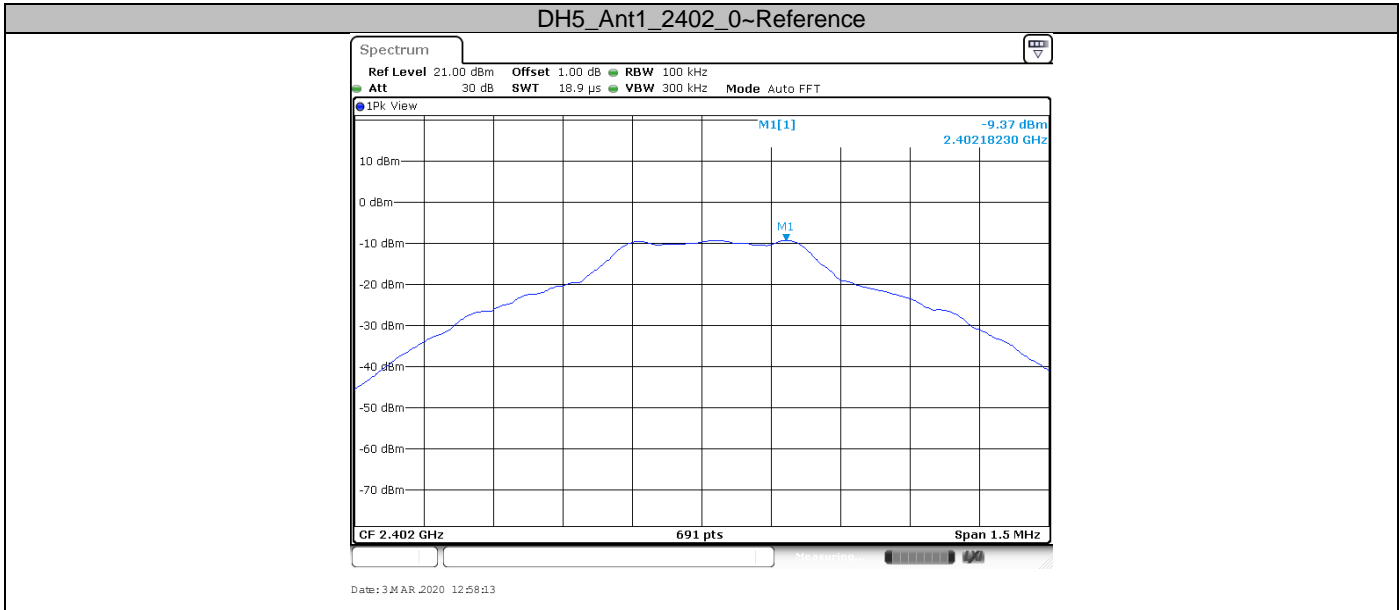

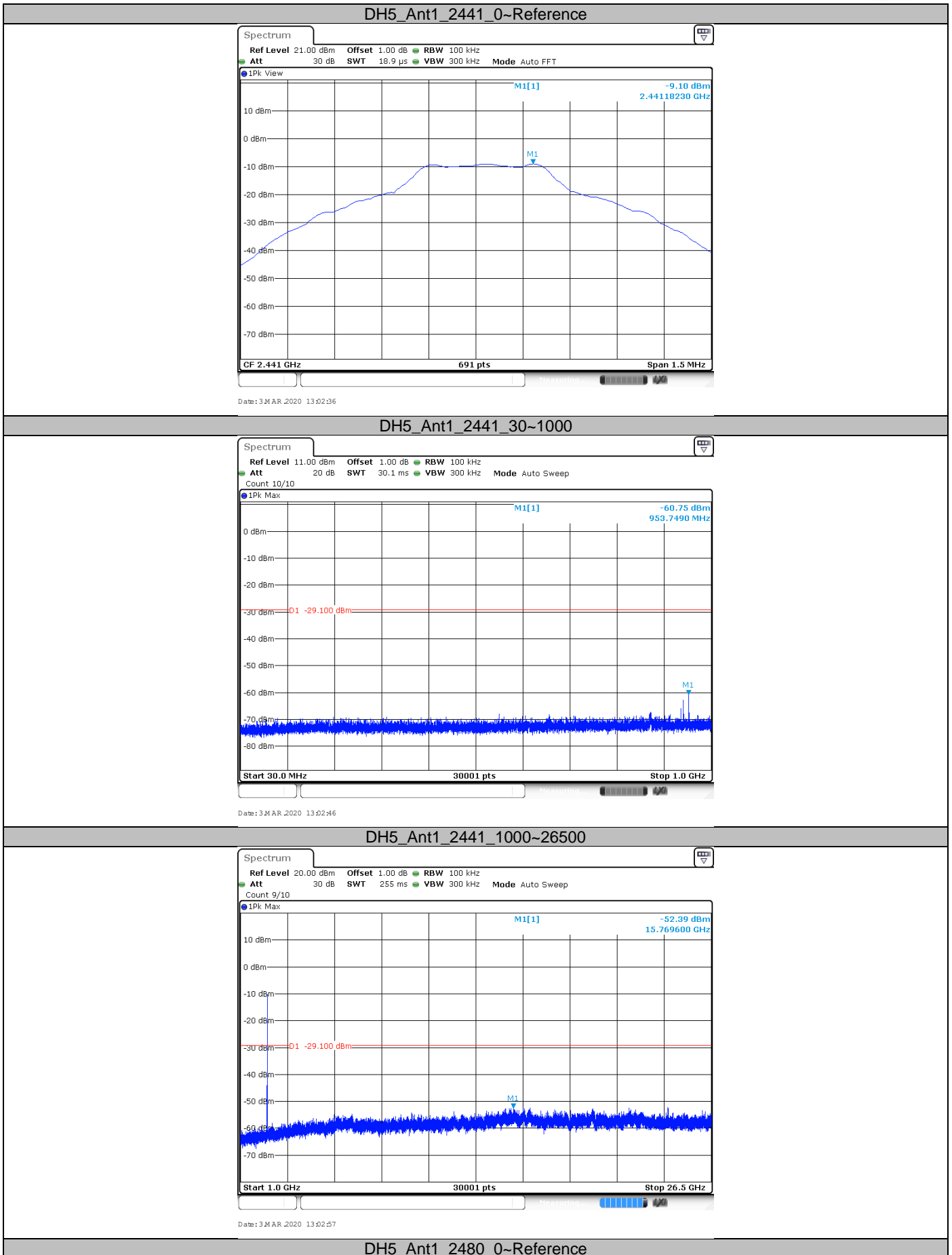

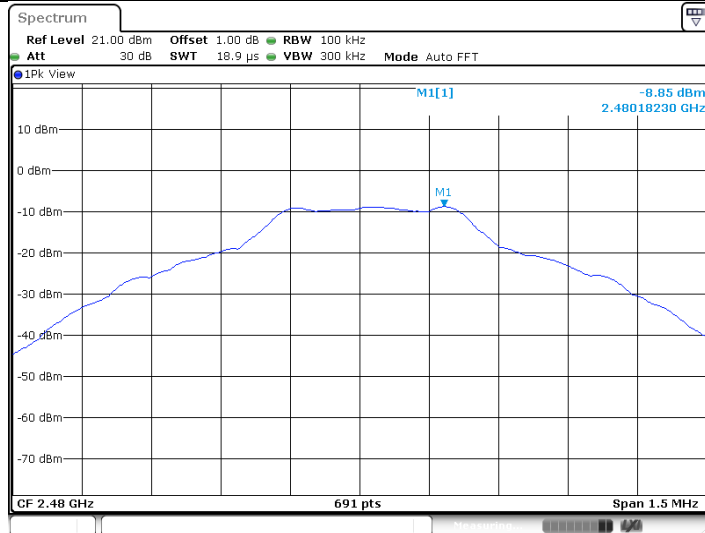

Date: 3 MAR 2020 13:10:53

DH5_Ant1_2480_30~1000

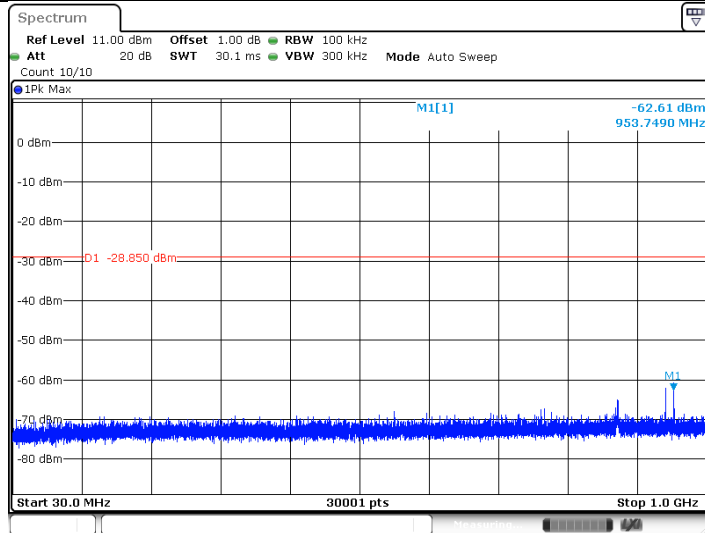

Date: 3 MAR 2020 13:11:03

DH5_Ant1_2480_1000~26500

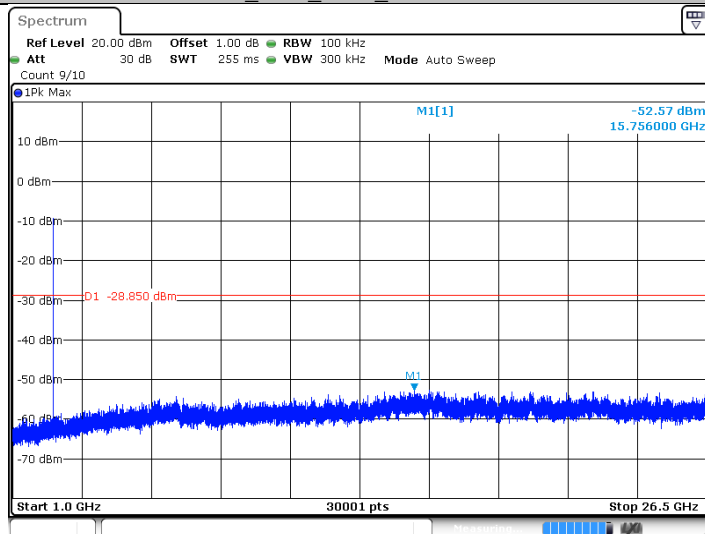

Date: 3 MAR 2020 13:11:14

2DH5_Ant1_2402_0~Reference

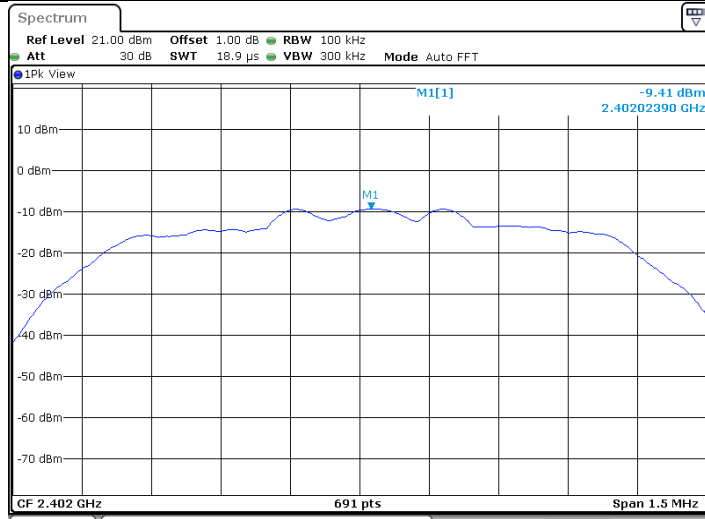

Date: 3 MAR 2020 13:12:48

2DH5_Ant1_2402_30~1000

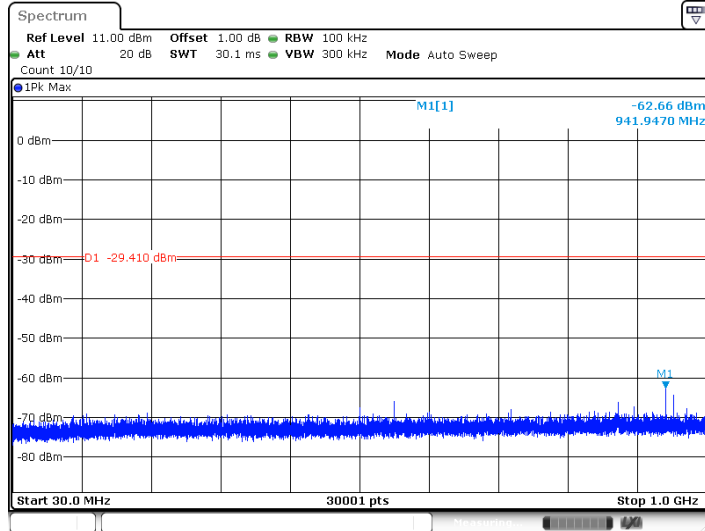

Date: 3 MAR 2020 13:12:58

2DH5_Ant1_2402_1000~26500

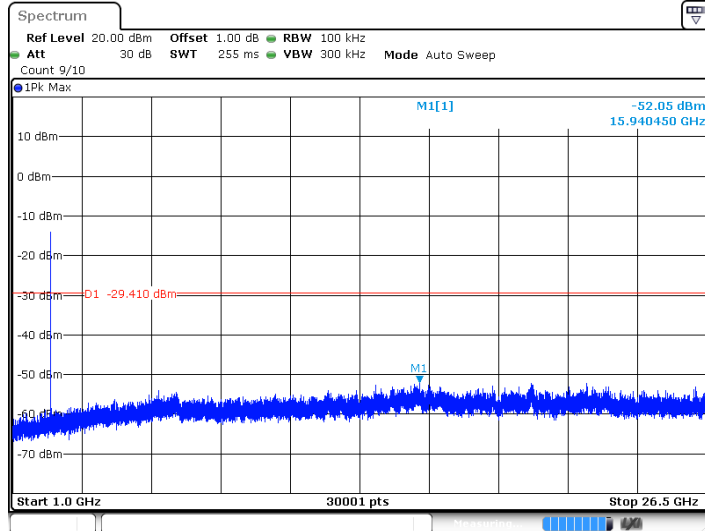

Date: 3 MAR 2020 13:13:09

2DH5_Ant1_2441_0~Reference

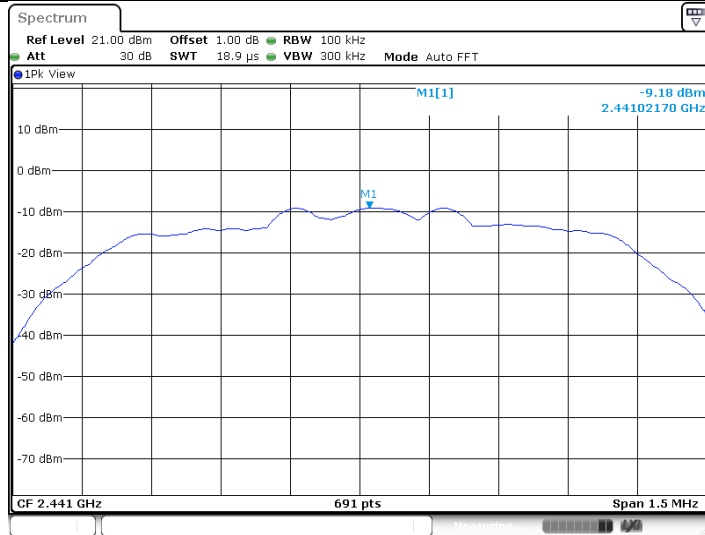

Date: 3 MAR 2020 13:14:47

2DH5_Ant1_2441_30~1000

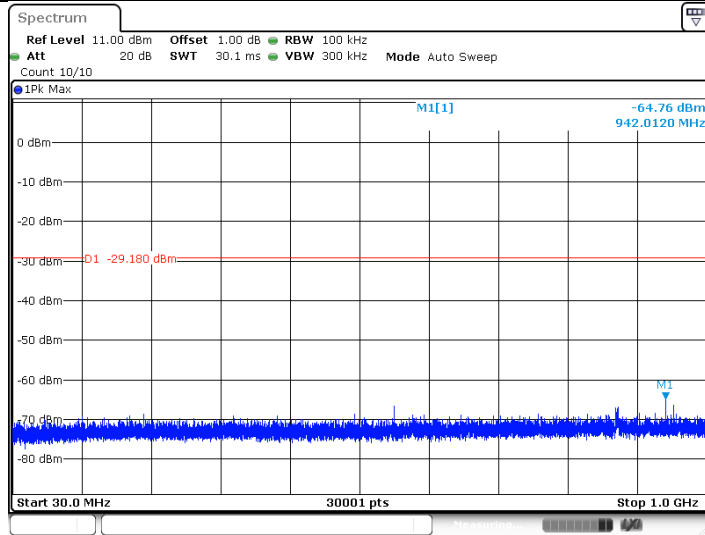

Date: 3 MAR 2020 13:14:57

2DH5_Ant1_2441_1000~26500

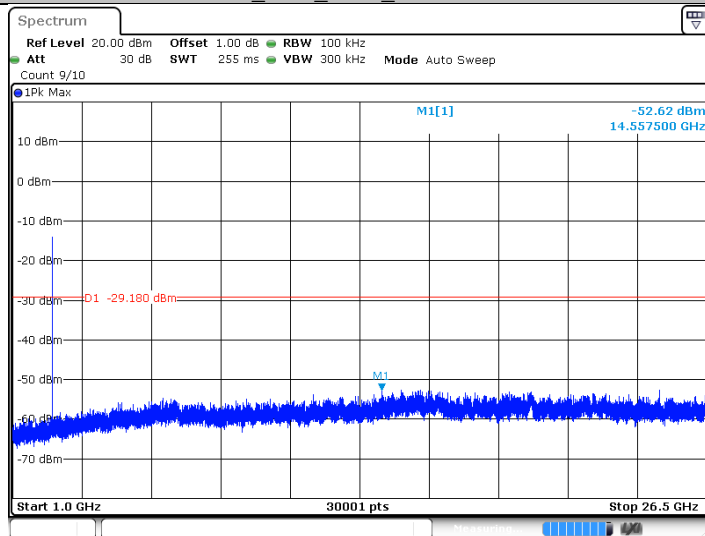

Date: 3 MAR 2020 13:15:08

2DH5_Ant1_2480_0~Reference

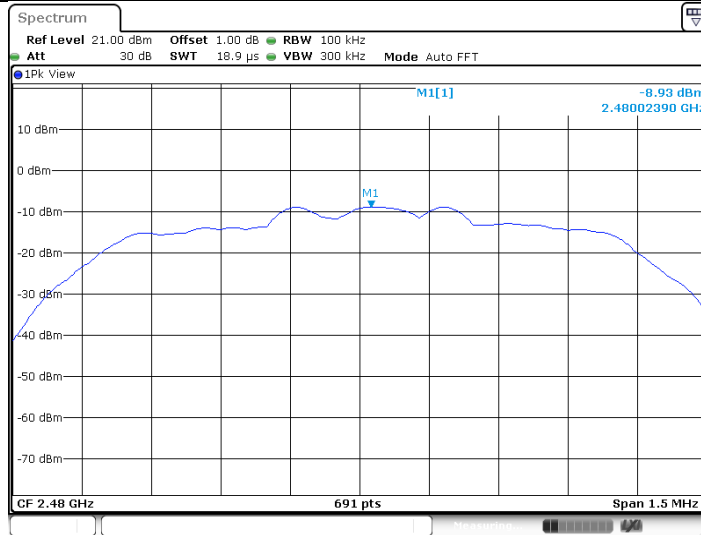

Date: 3 MAR 2020 13:18:42

2DH5 Ant1 2480 30~1000

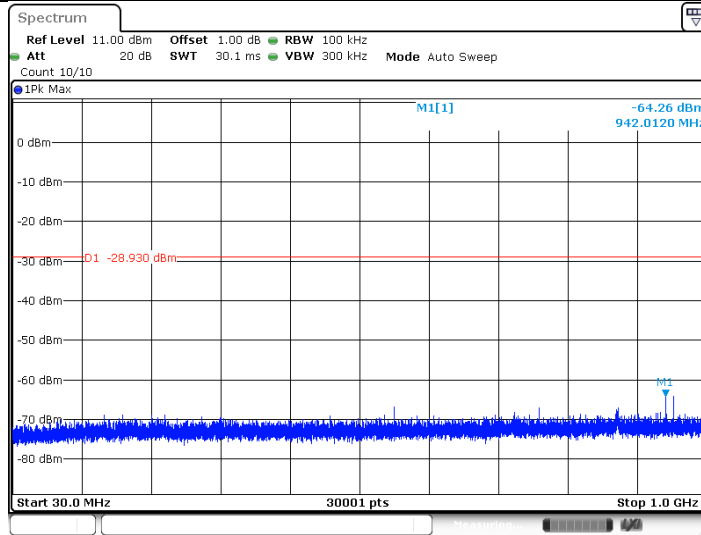

Date: 3 MAR 2020 13:18:52

2DH5 Ant1 2480 1000~26500

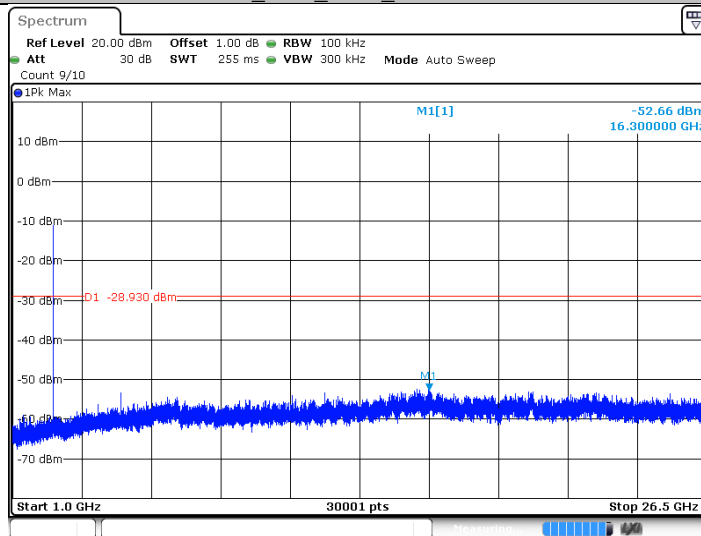

Date: 3 MAR 2020 13:19:03



8.7 Band edge testing

Test Method

- 1 Use the following spectrum analyzer settings:
Span = wide enough to capture the peak level of the in-band emission and all spurious
RBW = 100 kHz, VBW ≥ RBW, Sweep = auto, Detector function = peak, Trace = max hold
- 2 Allow the trace to stabilize, use the peak and delta measurement to record the result.
- 3 The level displayed must comply with the limit specified in this Section. .
- 4 Repeat the test at the hopping off and hopping on mode, submit all the plots.

Limit:

In any 100 kHz bandwidth outside the frequency band in which the spread spectrum or digitally modulated device is operating, the RF power that is produced shall be at least 20 dB below that in the 100 kHz bandwidth within the band that contains the highest level of the desired power, based on either an RF conducted or a radiated measurement, provided that the transmitter demonstrates compliance with the peak conducted power limits.

Test result:

TestMode	ChName	Channel	RefLevel	Result	Limit	Verdict
DH5	Low	2402	-9.37	-55.16	<=-29.37	PASS
	High	2480	-8.87	-54.74	<=-28.87	PASS
	Low	Hop_2402	-10.69	-58.38	-30.69	PASS
	High	Hop_2480	-8.93	-54.84	-28.93	PASS
2DH5	Low	2402	-9.36	-55.89	<=-29.36	PASS
	High	2480	-8.88	-56.5	<=-28.88	PASS
	Low	Hop_2402	-10.57	-58.27	-30.57	PASS
	High	Hop_2480	-8.89	-58.1	-28.89	PASS

DH5_Ant1_Low_2402

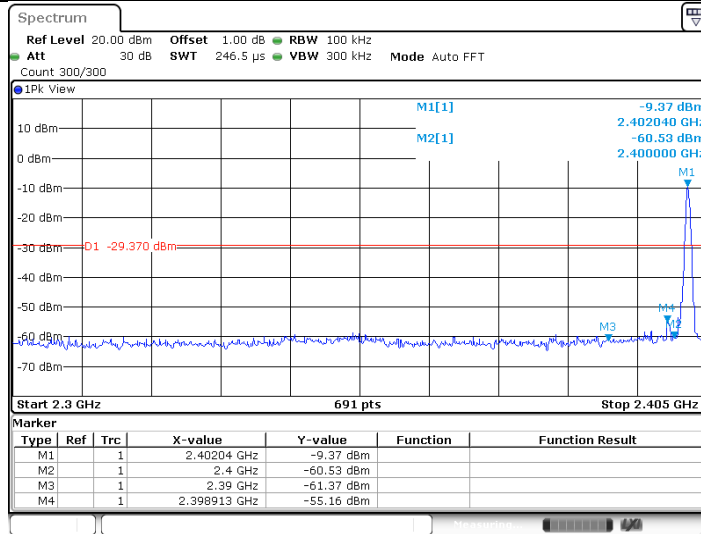

Date: 3 MAR 2020 12:57:15

DH5_Ant1_High_2480

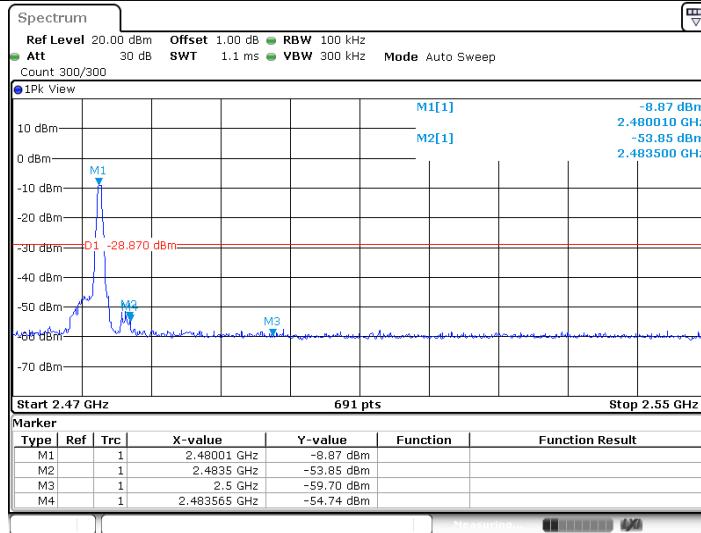

Date: 3 MAR 2020 13:04:47

DH5_Ant1_Low_Hop_2402

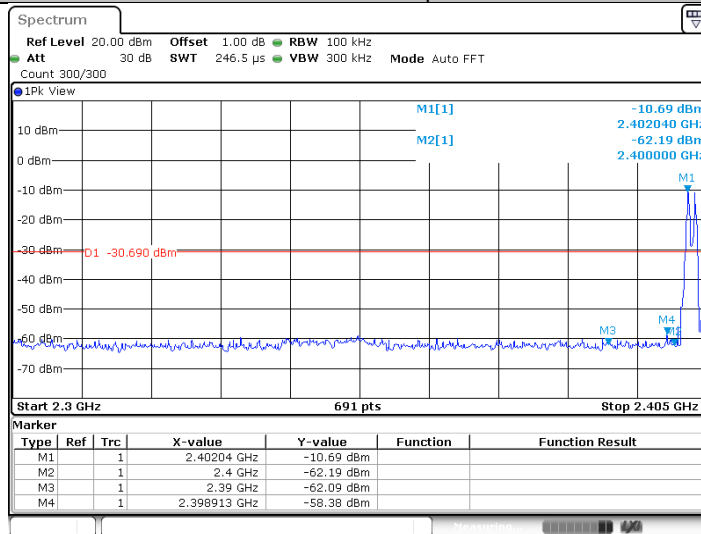

Date: 3 MAR 2020 13:21:09

DH5_Ant1_High_Hop_2480

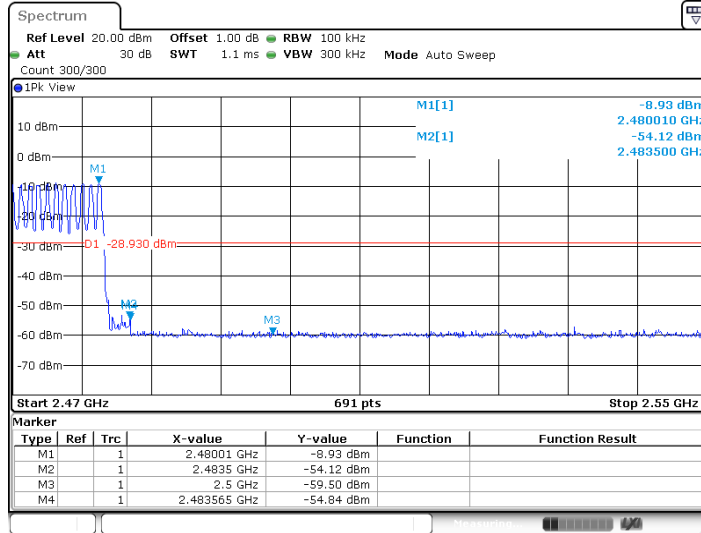

Date: 3 MAR 2020 13:24:18

2DH5_Ant1_Low_2402

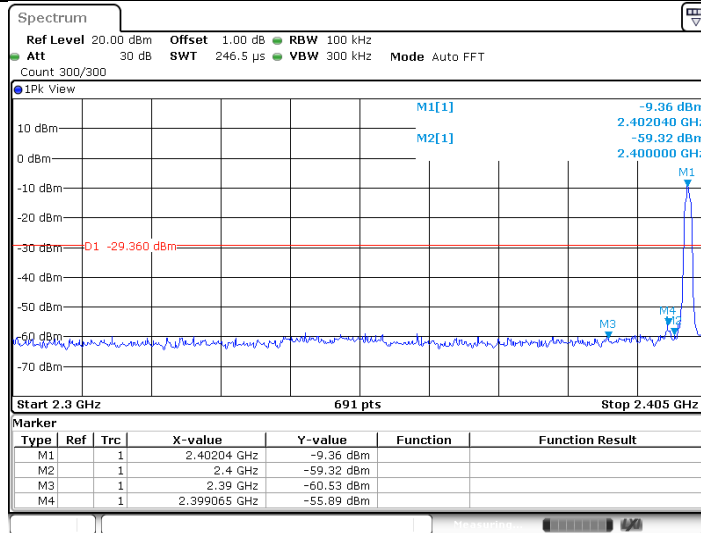

Date: 3 MAR 2020 13:24:42

2DH5_Ant1_High_2480

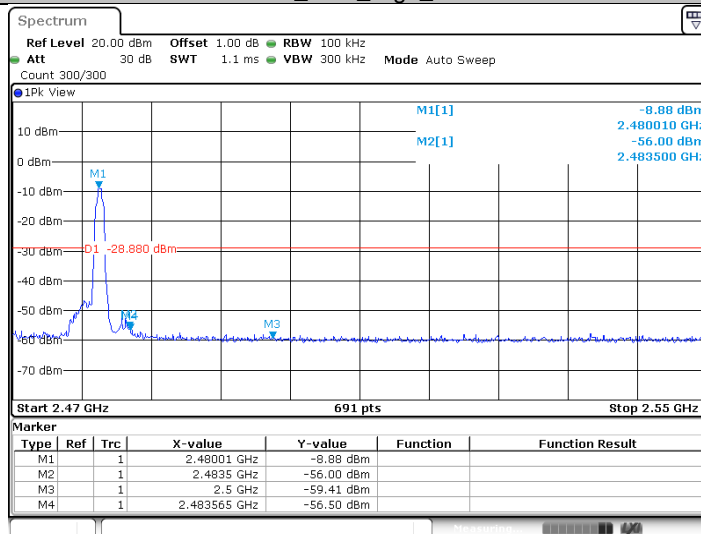

Date: 3 MAR 2020 13:28:36

2DH5_Ant1_Low_Hop_2402

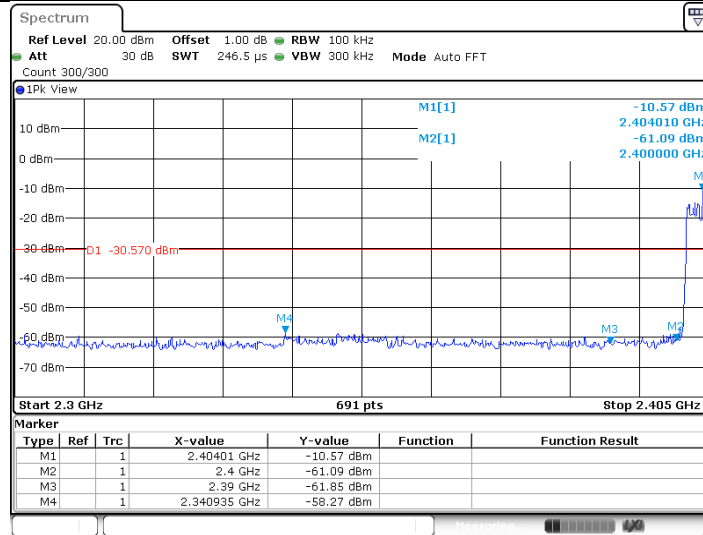

Date: 3 MAR 2020 13:24:38

2DH5_Ant1_High_Hop_2480

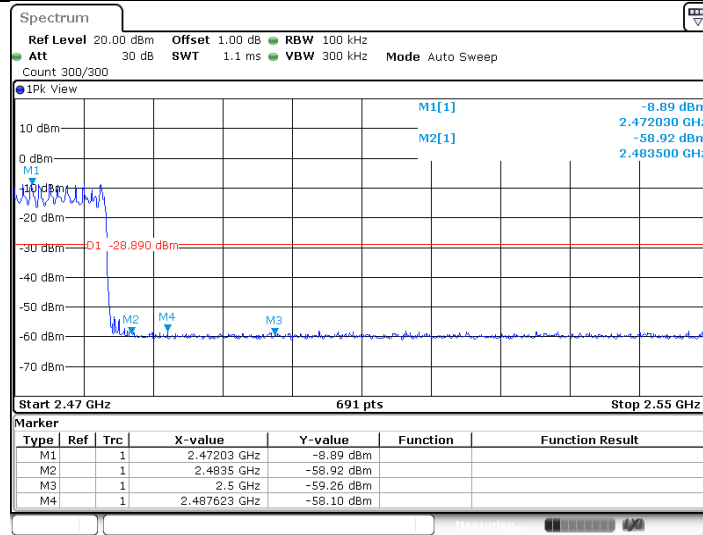

Date: 3 MAR 2020 13:29:55

8.8 Spurious radiated emissions for transmitter

Test Method

- 1: The EUT was placed on a turn table which is 1.5m above ground plane for above 1GHz and 0.8m above ground for below 1GHz at 3-meter chamber room for test. The table was rotated 360 degrees to determine the position of the highest radiation.
- 2: The EUT was set 3 meters away from the interference – receiving antenna, which was mounted on the top of a variable – height antenna tower.
- 3: The height of antenna is varied from one meter to four meters above the ground to determine the maximum value of the field strength. Both horizontal and vertical polarizations of the antenna are set to make the measurement.
- 4: For each suspected emission, the EUT was arranged to its worst case and then the antenna was tuned to heights from 1 meter to 4 meters and the rotatable table was turned from 0 degrees to 360 degrees to find the maximum reading.
- 5: Use the following spectrum analyzer settings According to C63.10:

For Above 1GHz

Span = wide enough to capture the peak level of the in-band emission and all spurious
RBW = 1MHz, VBW \geq RBW for peak measurement and VBW = 10Hz for average measurement, Sweep = auto, Detector function = peak, Trace = max hold.

For Below 1GHz

Use the following spectrum analyzer settings:

Span = wide enough to capture the peak level of the in-band emission and all spurious
RBW = 100 KHz, VBW \geq RBW for peak measurement, Sweep = auto, Detector function = peak, Trace = max hold.

Note:

- 1: The resolution bandwidth and video bandwidth of test receiver/spectrum analyzer is 120 KHz for Quasi-peak detection (QP) at frequency below 1GHz.
- 2: The resolution bandwidth of test receiver/spectrum analyzer is 1MHz and the video bandwidth is 3MHz for peak detection (PK) at frequency above 1GHz.
- 3: The resolution bandwidth of test receiver/spectrum analyzer is 1MHz and the video bandwidth is 3MHz for RMS Average ((duty cycle < 98%) for Average detection (AV) at frequency above 1GHz, then the measurement results was added to a correction factor ($20\log(1/\text{duty cycle})$).
- 4: The resolution bandwidth of test receiver/spectrum analyzer is 1MHz and the video bandwidth is 10Hz (duty cycle > 98%) for Average detection (AV) at frequency above 1GHz.

Limit

The radio emission outside the operating frequency band shall be at least 20 dB below that in the 100 kHz bandwidth within the band that contains the highest level of the desired power. Radiated emissions which fall in the restricted bands, as defined in section 15.205, must comply with the radiated emission limits specified in section 15.209.

Frequency MHz	Field Strength uV/m	Field Strength dB μ V/m	Detector
30-88	100	40	QP
88-216	150	43.5	QP
216-960	200	46	QP
960-1000	500	54	QP
Above 1000	500	54	AV
Above 1000	5000	74	PK

Spurious radiated emissions for transmitter

According to C63.10, if the peak (or quasi-peak) measured value complies with the average limit, it is unnecessary to perform an average measurement, so AV emission value did not show in below table if the peak value complies with average limit.

The only worse case (which is subject to the maximum EIRP, $\pi/4$ DQPSK mode) test result is listed in the report.

Transmitting spurious emission test result as below:

$\pi/4$ DQPSK Modulation 2402MHz Test Result

Frequency Band	Frequency	Emission level	Correct factor	Polarization	Limit	Detector	Margin	Result
	MHz	dBuV/m	dBuV/m		dB μ V/m		dBuV/m	
30-1000MHz	383.996111	35.46	-24.2	H	46	QP	12.60	Pass
	762.026667	32.45	-17.5	V	46	QP	13.55	Pass
1000-25000MHz	16816.000000	51.85	16.5	H	74	PK	22.15	Pass
	17745.000000	51.38	17.8	V	74	PK	22.62	Pass

$\pi/4$ DQPSK Modulation 2441MHz Test Result

Frequency Band	Frequency	Emission level	Correct factor	Polarization	Limit	Detector	Margin	Result
	MHz	dBuV/m	dBuV/m		dB μ V/m		dBuV/m	
30-1000MHz	383.996111	35.46	-24.2	H	46	QP	12.60	Pass
	762.026667	32.45	-17.5	V	46	QP	13.55	Pass
1000-25000MHz	6934.000000	51.59	16.5	H	74	PK	22.41	Pass
	17894.000000	51.37	17.7	V	74	PK	22.63	Pass

π/4DQPSK Modulation 2480MHz Test Result

Frequency Band	Frequency	Emission level	Correct factor	Polarization	Limit	Detector	Margin	Result
	MHz	dBuV/m	dBuV/m		dBuV/m		dBuV/m	
30-1000MHz	383.996111	35.46	-24.2	H	46	QP	12.60	Pass
	762.026667	32.45	-17.5	V	46	QP	13.55	Pass
1000-25000MHz	16919.500000	52.46	16.8	H	74	PK	21.54	Pass
	17758.000000	51.72	17.6	V	74	PK	22.28	Pass

Remark:

- (1) “**” means the emission(s) appear within the restrict bands shall follow the requirement of section 15.205.
- (2) Data of measurement within this frequency range shown “--” in the table above means the reading of emissions are the noise floor or attenuated more than 20dB below the permissible limits or the field strength is too small to be measured.
- (3) Corrected Amplitude= Read level + Corrector factor
 Above 1GHz: Corrector factor = Antenna Factor + Cable Loss- Pre-amplifier
 Below 1GHz: Corrector factor = Antenna Factor + Cable Loss
 (The Reading Level is recorded by software which is not shown in the sheet)

9 Test Equipment List

List of Test Instruments

Radiated Emission Test

DESCRIPTION	MANUFACTURER	MODEL NO.	EQUIPMENT ID	SERIAL NO.	CAL INTERVAL (YEAR)	CAL. DUE DATE
EMI Test Receiver	Rohde & Schwarz	ESR 26	68-4-74-14-002	101269	1	2020-6-28
Trilog Super Broadband Test Antenna	Schwarzbeck	VULB 9163	68-4-80-14-002	707	1	2020-8-20
Horn Antenna	Rohde & Schwarz	HF907	68-4-80-14-005	102294	1	2020-6-22
Loop Antenna	Rohde & Schwarz	HFH2-Z2	68-4-80-14-006	100398	1	2020-7-7
Pre-amplifier	Rohde & Schwarz	SCU 18	68-4-29-14-001	102230	1	2020-6-28
Signal Generator	Rohde & Schwarz	SMY01	68-4-48-16-001	839369/005	1	2020-6-28
Attenuator	Agilent	8491A	68-4-81-16-001	MY39264334	1	2020-6-28
3m Semi-anechoic chamber	TDK	9X6X6	68-4-90-14-001	----	3	2020-7-7
Test software	Rohde & Schwarz	EMC32	68-4-90-14-001-A10	Version 9.15.00	N/A	N/A

TS8997 Test System

DESCRIPTION	MANUFACTURER	MODEL NO.	SERIAL NO.	CAL INTERVAL (YEAR)	CAL. DUE DATE
Signal Analyzer	Rohde & Schwarz	FSV40	101030	1	2020-6-28
RF Switch Module	Rohde & Schwarz	OSP120/OSP-B157	101226/100851	1	2020-6-28
10dB Attenuator	Weinschel	4M-10	43152	1	2020-6-28
Test software	Rohde & Schwarz	EMC32	Version 10.38.00	N/A	N/A
Test software	Tonscend	System for BT/WIFI	Version 2.6	N/A	N/A

10 System Measurement Uncertainty

For a 95% confidence level, the measurement expanded uncertainties for defined systems, in accordance with the recommendations of ISO 17025 were:

System Measurement Uncertainty	
Test Items	Extended Uncertainty
Uncertainty for Radiated Spurious Emission 30MHz-1000MHz	Horizontal: 5.12dB; Vertical: 5.10dB;
Uncertainty for Radiated Spurious Emission 1000MHz-18000MHz	Horizontal: 5.01dB; Vertical: 5.00dB;
Uncertainty for Radiated Spurious Emission 18000MHz-40000MHz	Horizontal: 4.89dB; Vertical: 4.87dB;
Uncertainty for Conducted RF test with TS 8997	RF Power Conducted: 1.16dB Frequency test involved: 0.6×10 ⁻⁷ or 1%