



H.B. Compliance Solutions

Intentional Radiator Test Report

For the

Hiber Inc.

LPGAN Modem Model CN1

Tested under

The FCC Rules contained in Title 47 of the CFR, Part 25 for

Satellite Communications

February 7, 2019

Prepared for:

Hiber Inc.

8400 Baltimore Ave. Suite 320

College Park, MD 20704

Prepared By:

H.B. Compliance Solutions

5005 S. Ash Avenue, Suite # A-10

Tempe, Arizona 85282

Reviewed By:

Hoosamuddin Bandukwala



Cert # ATL-0062-E

Engineering Statement: The measurements shown in this report were made in accordance with the procedure indicated, and the emissions from this equipment were found to be within the limits applicable. I assume full responsibility for the accuracy and completeness of these measurements, and for the qualifications of all persons taking them. It is further stated that upon the basis of the measurement made, the equipment tested is capable of operation in accordance with the requirements of Part 25 of the FCC Rules under normal use and maintenance.



Report Status Sheet

Revision #	Report Date	Reason for Revision
∅	February 7, 2019	Initial Issue

Table of Contents

EXECUTIVE SUMMARY	4
1. Testing Summary.....	4
EQUIPMENT CONFIGURATION.....	5
1. Overview	5
2. Test Facility.....	6
3. Description of Test Sample	7
4. Equipment Configuration	7
5. Support Equipment	7
6. Ports and Cabling Information.....	7
7. Method of Monitoring EUT Operation.....	8
8. Mode of Operation.....	8
9. Modifications	8
10. Disposition of EUT	8
Criteria for Intentional Radiators	9
1. RF Power Output	9
2. Occupied Bandwidth	11
3. Unwanted Emissions at Antenna Terminals.....	13
4. Radiated Spurious Emissions	18
6. Frequency Stability vs Temperature	21
7. Frequency Stability vs Voltage.....	23
I. Test Equipment	25

EXECUTIVE SUMMARY

1. Testing Summary

These tests were conducted on a sample of the equipment for the purpose of demonstrating compliance with Part 25. All tests were conducted using measurement procedure from ANSI C63.26-2015 as appropriate.

Test Name	Test Method/Standard	Result	Comments
RF Output Power	2.1046; 25.204	Pass	
Occupied Bandwidth	2.1049	Pass	
Unwanted Emissions at Antenna Terminals	2.1051; 25.202(f)	Pass	
Radiated Spurious Emissions	2.1053; 25.202(f)	Pass	
Protection of Aeronautical Radio Navigation Satellite Service	25.216(c)(f)(g)(i)	N/A	Device does not operate at frequency stated in this section.
Frequency Stability over Temperature Variations	2.1055(a)(1); 25.202(d)	Pass	
Frequency Stability over Voltage Variations	2.1055(d); 25.202(d)	Pass	

EQUIPMENT CONFIGURATION

1. Overview

H.B Compliance Solutions was contracted by Hiber Inc. to perform testing on the LPGAN modem under the quotation number Q18101003.

This document describes the test setups, test methods, required test equipment, and the test limit criteria used to perform compliance testing of the Hiber Inc., LPGAN Modem.

The tests were based on FCC Part 25 Rules. The tests described in this document were formal tests as described with the objective of the testing was to evaluate compliance of the Equipment Under Test (EUT) to the requirements of the aforementioned specifications. Hiber Inc., should retain a copy of this document and it should be kept on file for at least five years after the manufacturing of the EUT has been permanently discontinued. The results obtained relate only to the item(s) tested.

Product Name:	LPGAN Modem
Model(s) Tested:	CN1
FCC ID:	2ASDVCN1
Supply Voltage Input:	Primary Power: 3.3 Vdc
Frequency Range:	399.9 to 400.05MHz Uplink 400.15 to 401MHz Downlink
No. of Channels:	One Channel
Necessary Bandwidth	N/A
Type(s) of Modulation:	QPSK (Uplink) and GFSK (Downlink)
Range of Operation Power:	1.05W
Voltage into final Transistor	N/A
Current into final Transistor	N/A
Emission Designator:	150K0G1D
Channel Spacing(s)	N/A
Test Item:	Pre-Production
Type of Equipment:	Mobile
Antenna:	External 0dBi Omnidirectional Black & Grizzly Antenna
Environmental Test Conditions:	Temperature: 15-35°C Humidity: 30-60% Barometric Pressure: 860-1060 mbar
Modification to the EUT:	None
Evaluated By:	Staff at H.B. Compliance Solutions
Test Date(s):	01/16/2019 till 02/06/2019

2. Test Facility

All testing was performed at H.B. Compliance Solutions. This facility is located at 5005 S. Ash Avenue, Suite # A-10, Tempe AZ-85282. All equipment used in making physical determination is accurate and bears recent traceability to the National Institute of Standards and Technology.

Radiated Emissions measurements from 30MHz to 1GHz were performed in a GTEM chamber (equivalent to an Open Area Test Site). Radiated Emissions Above 1GHz were performed on an Open Area Test Site (OATS). In accordance with §2.948(a)(3), a complete site description is contained at H.B. Compliance Solutions.

Test facility H.B. Compliance Solutions is an ANAB accredited test site. The ANAB certificate number is L2458. The scope of accreditation can be found on ANAB website www.anab.org



3. Description of Test Sample

The Hiber Inc., LPGAN modem is a highly integrated, low-power communications front-end designed for global delivery of sensor data through Hiber’s satellite-based HiberBand Low-Power Global Area Network (LPGAN). Designed as a compact, solderable SMT module, it is straightforward to integrate in IoT devices. The application host processor of the IoT device interacts with the Hiber LPGAN modem through a UART-based serial interface using a command-response.

4. Equipment Configuration

Ref. ID	Name / Description	Model Number	Serial Number
# 1	LPGAN Modem	CN1	N/A
# 2	Antenna	Grizzly	N/A
# 3	Antenna	Black	N/A

Table 1. Equipment Configuration

5. Support Equipment

All support equipment supplied is listed in the following Support Equipment List.

Ref ID	Name / Description	Manufacturer	Model #	Serial #
#2	DC Power Supply	Hewlett Packard	E3610A	KR83021468
#3	Laptop Computer	Toshiba	PSLB8U-04X02F	X08083283Q

Table 2. Support Equipment

6. Ports and Cabling Information

Ref ID	Port name on the EUT	Cable Description	Qty.	Length (m)	Shielded? (Y/N)	Termination Box ID & Port ID
#4	USB	2 wire	1	2	N	Laptop Computer

Table 3. Ports and Cabling Information

7. Method of Monitoring EUT Operation

A test receiver will be used to monitor the data transmission from the EUT.

8. Mode of Operation

The EUT will be configured to transmit at maximum power level. Test mode was provided using Arduino interface to set the frequency, power level and change the device from CW to Modulation mode. These settings were created for testing purpose only.

9. Modifications

9.1 Modifications to EUT

No modifications were made to the EUT

9.2 Modifications to Test Standard

No Modifications were made to the test standard.

10. Disposition of EUT

The test sample including all support equipment submitted to H.B Compliance Solutions for testing will be returned to Hiber In., upon completion of testing & certification

Criteria for Intentional Radiators

1. RF Power Output

Test Requirement(s):	§2.1046 and §25.204	Test Engineer(s):	Keith T.
Test Results:	Pass	Test Date(s):	01/16/2019

Test Procedures: As required by 47 CFR 2.1046, RF Power output measurements were made at the RF output terminals of the EUT.

Customer provided a test mode internal to the EUT to control the RF modulation, and frequency channel. The EUT was connected through an attenuator to a Spectrum Analyzer capable of making power measurements. Measurements were made at the low and high channels of the entire frequency band.

Frequency (MHz)	Channel	Conducted Power (dBm)	Transmit Antenna Gain (dBi)	Carrier Power Peak EIRP (dBm)	Specification Limit (dBW)
399.975	N/A	30.23	0	30.23	40

Table 4. RF Power Output, Test Results

Test Setup:



Figure 1 Output RF power Test Setup

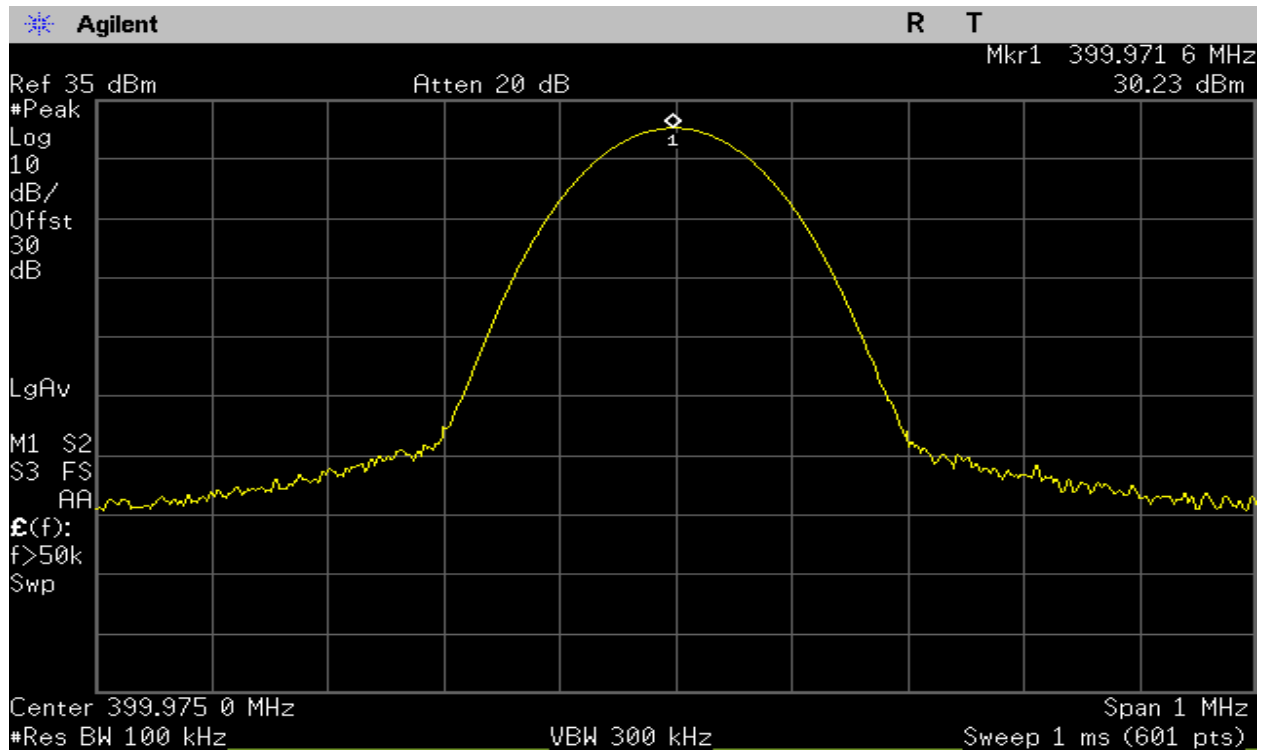

Plot 1 – Output Power – Low

2. Occupied Bandwidth

Test Requirement(s):	2.1049	Test Engineer(s):	Keith T.
Test Results:	Pass	Test Date(s):	02/06/2019

Test Procedure: As required by 47 CFR 2.1049, occupied bandwidth measurements were made at the output terminals of the EUT.

Customer provided a test mode internal to the EUT to control the RF modulation, and frequency channel. The EUT was connected through an attenuator to a Spectrum Analyzer. The measured highest peak power was set relative to zero dB reference. The RBW of the Spectrum Analyzer was set to at least 1% of the channel bandwidth and video bandwidth was set to 3 times the resolution bandwidth. Measurements were carried out at the low and high channels of the TX band.

The following pages show measurements of Occupied Bandwidth plots:

Test Setup:



Figure 3: Occupied Bandwidth Test Setup

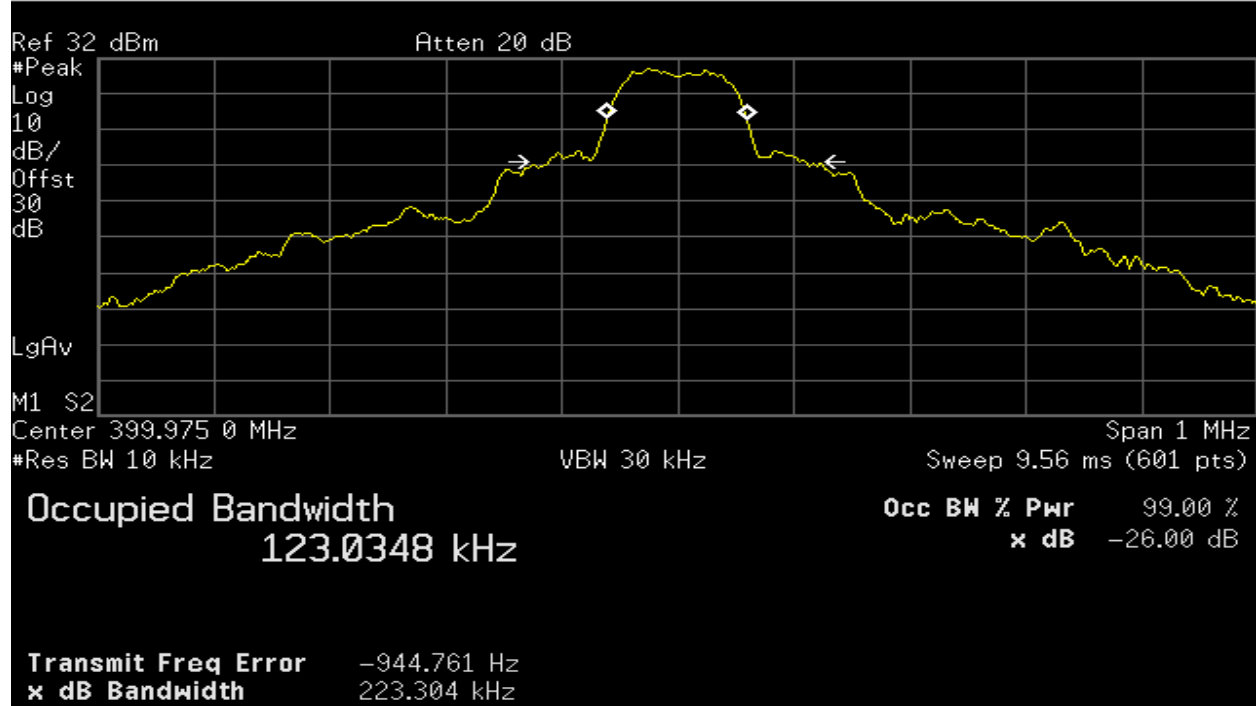

Plot 3 – Low Channel – 26dB Bandwidth

3. Unwanted Emissions at Antenna Terminals

Test Requirement(s):	§2.1051 and 25.202(f)	Test Engineer(s):	Keith T.
Test Results:	Pass	Test Date(s):	01/17/2019

Test Procedures:

As required by 47 CFR 25.202(f), unwanted emissions at antenna terminal measurements were made at the RF output antenna terminal of the EUT.

Customer provided a test mode internal to the EUT to control the RF modulation, and frequency channel. The EUT was connected through an attenuator to a Spectrum Analyzer to verify the DUT met the requirements as specified in §25.202(f). Measurements were made at the lowest and highest frequency of the transmit band.

Frequency removed from channel center by	Minimum signal reduction
0 to 50%	In Channel
50 to 100%	-25dBc
100 to 250%	-35dBc
More than 250%	-13dBm

Table 5 – Test Limit per section 25.202(f)

Test Setup:



Figure 4: Spurious Emission at Antenna Terminal Test setup

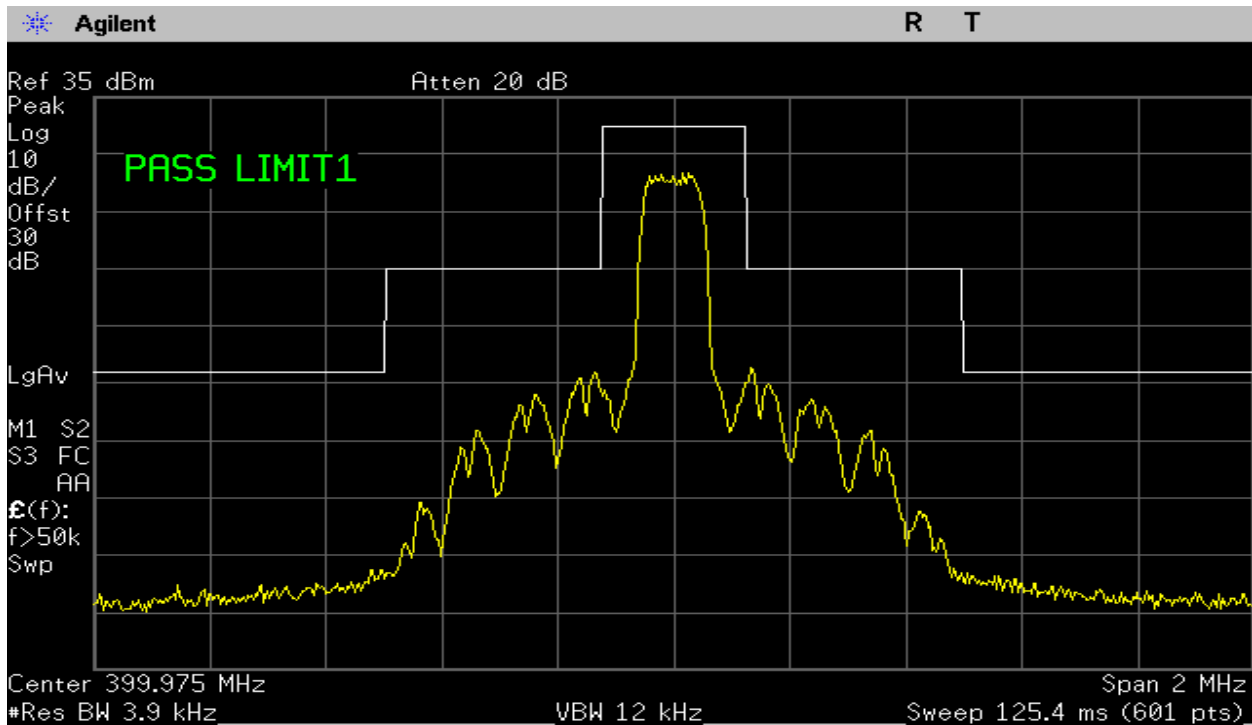

Plot 5 – Emission Mask

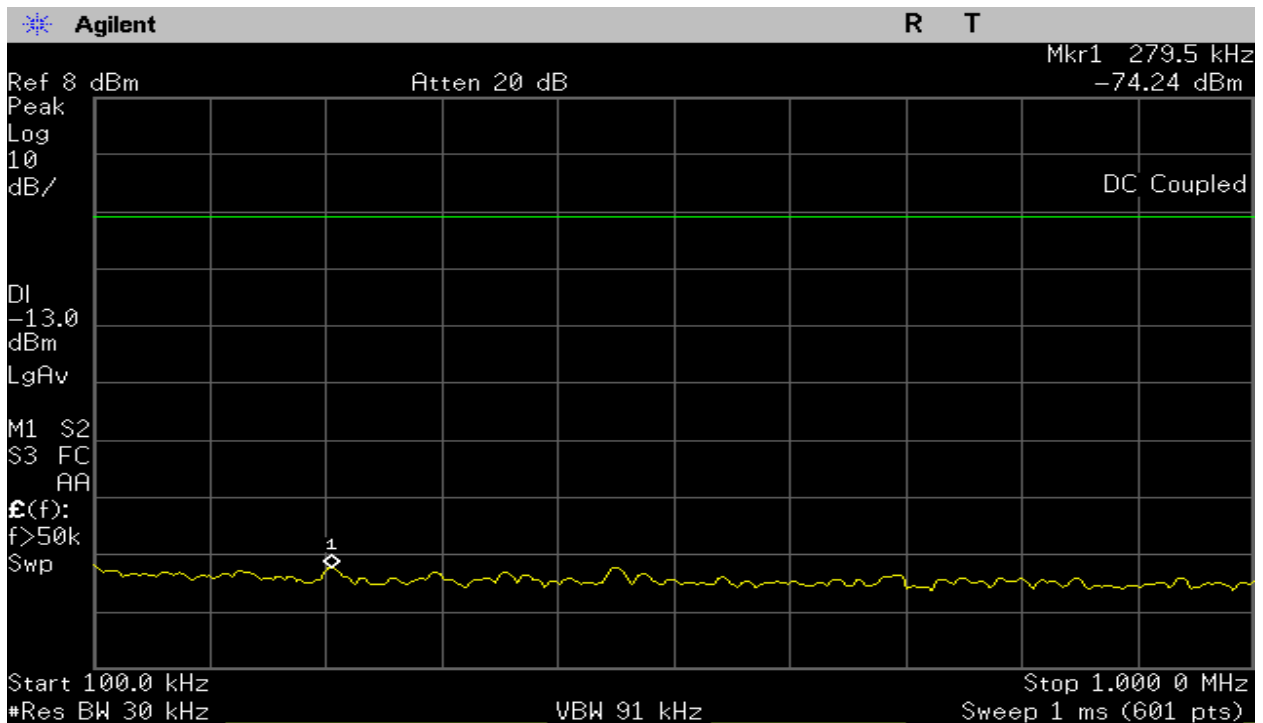

Plot 7 – 100kHz to 1MHz

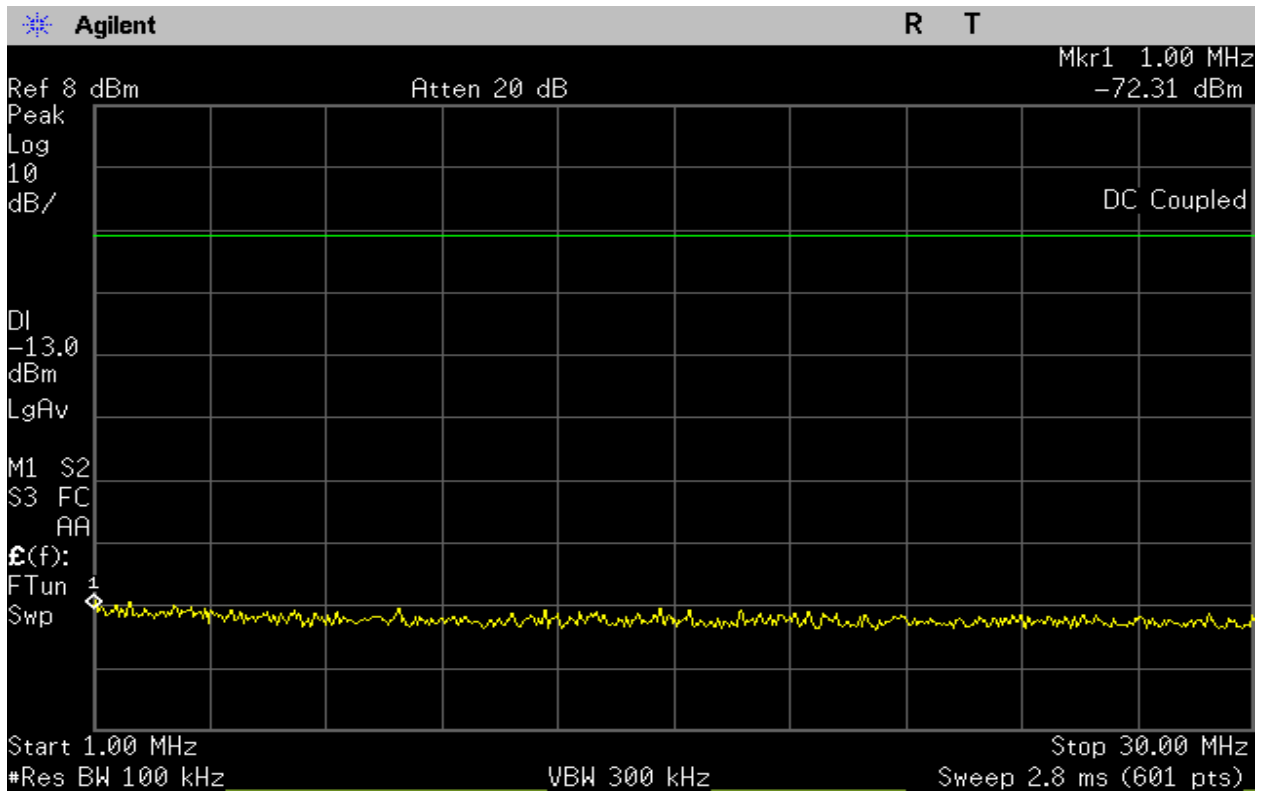

Plot 7 – 1MHz to 30MHz

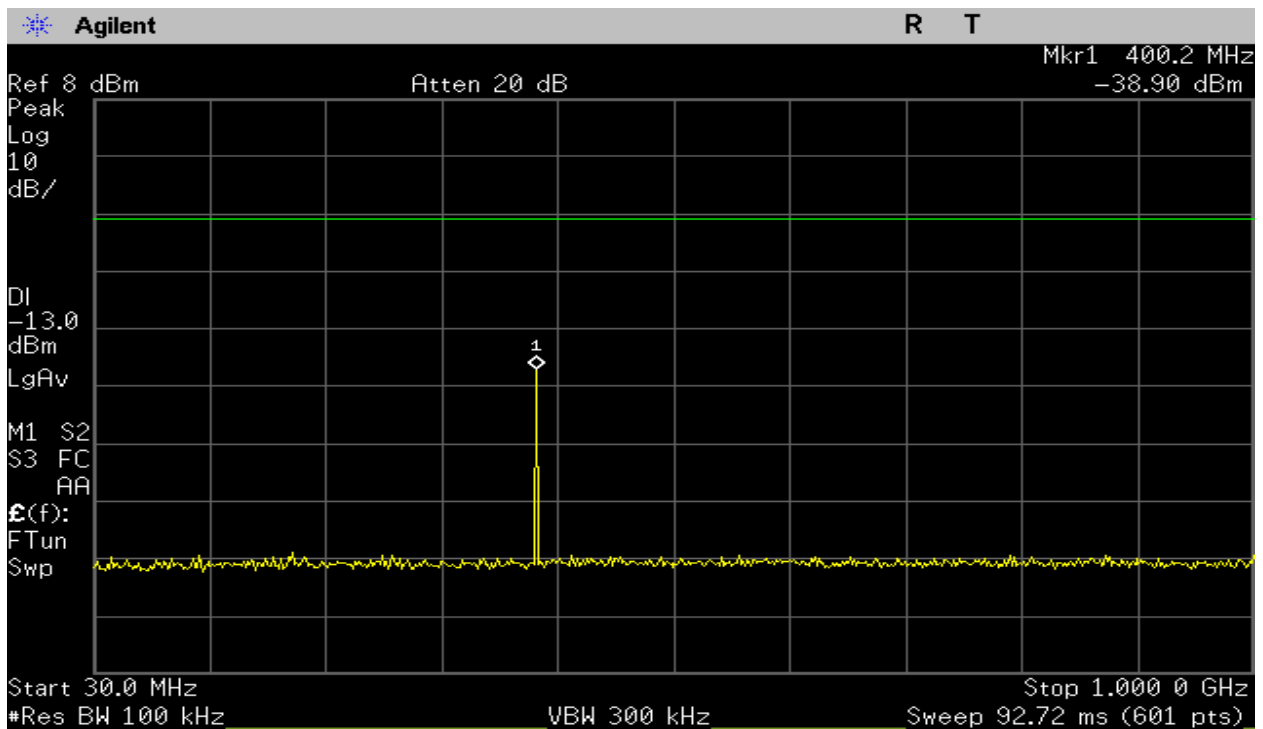

Plot 8 – 30MHz to 1GHz

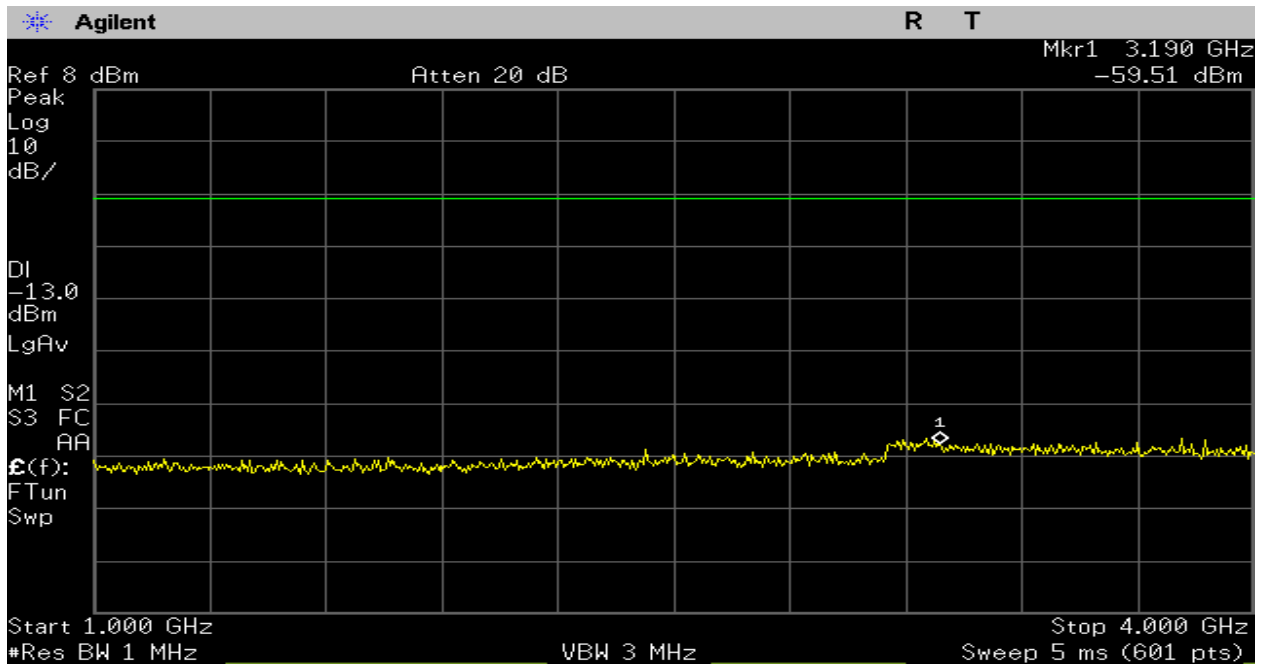

Plot 9 – 1GHz to 4GHz

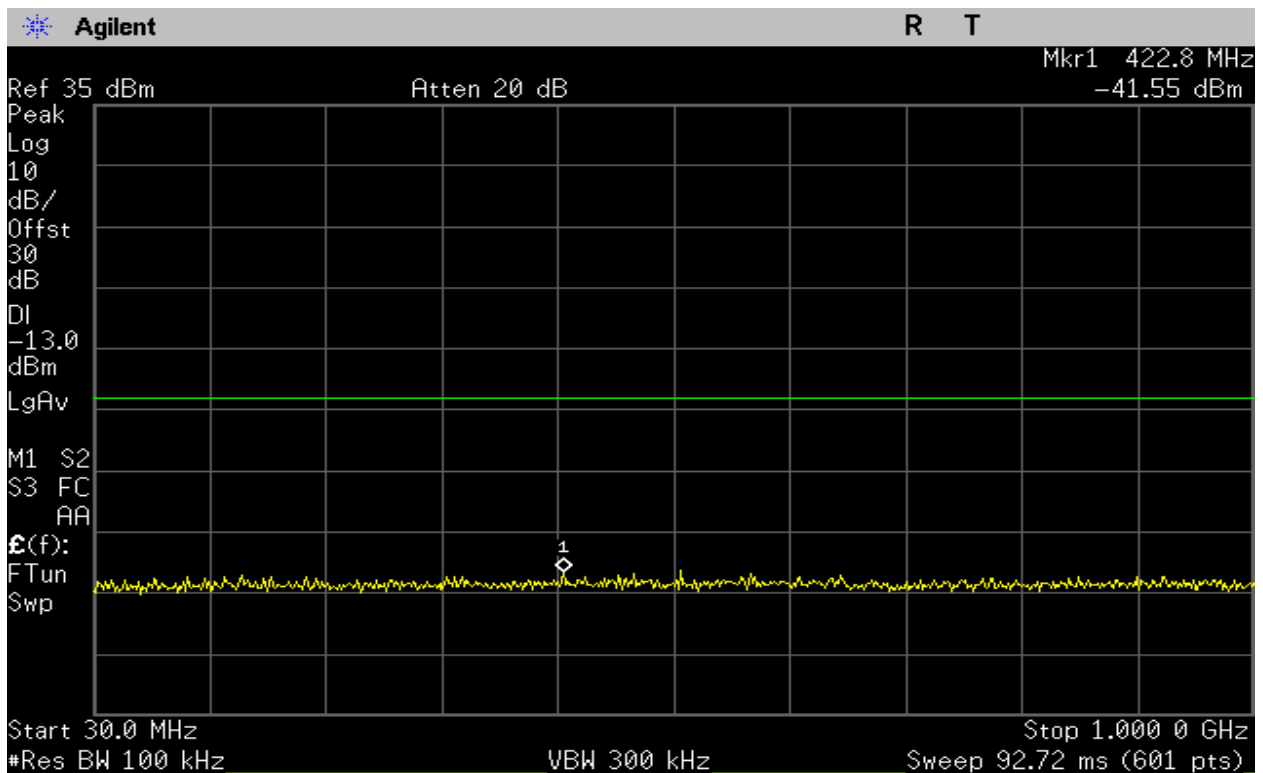

Plot 8 – Receiver Spurious Emissions – For Canada RSS Gen (30MHz to 1GHz)

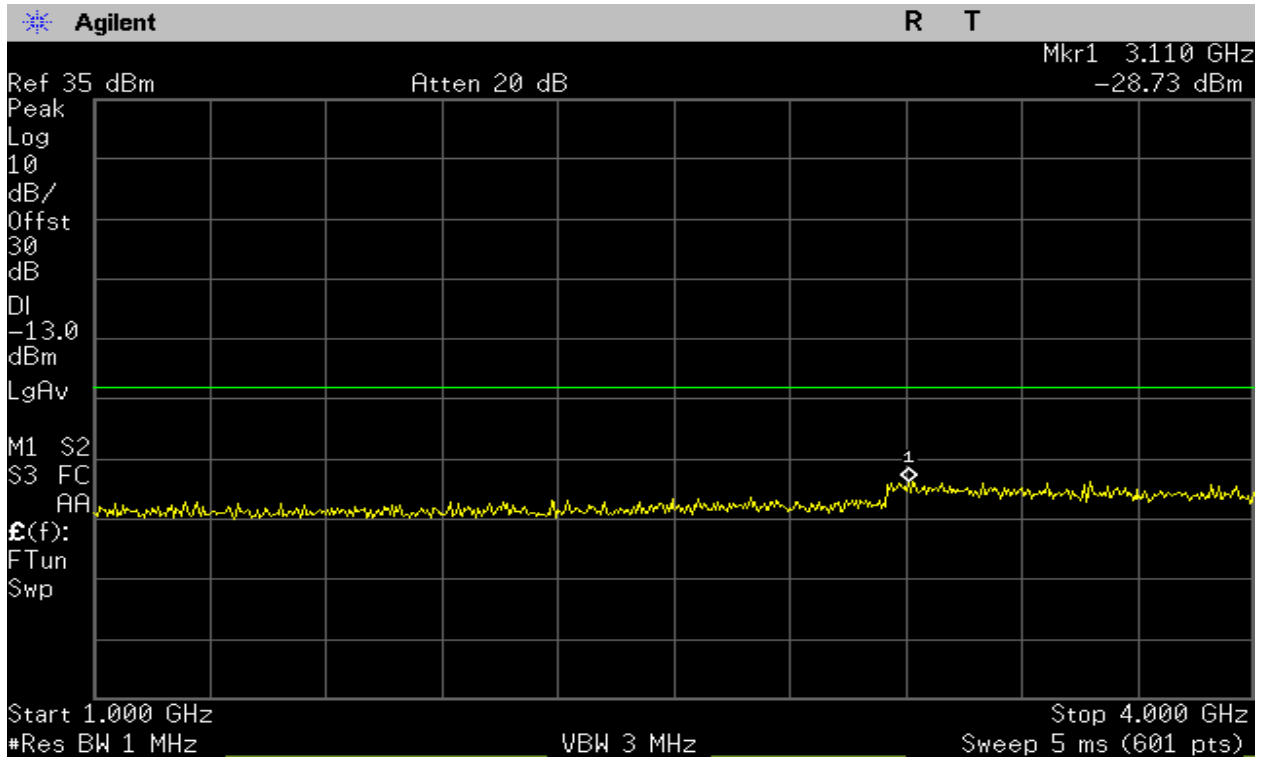

Plot 8 – Receiver Spurious Emissions – For Canada RSS Gen (1GHz to 4.0GHz)

4. Radiated Spurious Emissions

Test Requirement(s):	§2.1053 and 25.202(f)	Test Engineer(s):	Keith T.
Test Results:	Pass	Test Date(s):	01/22/2019

Test Procedures: As required by 47 CFR 2.1053, field strength of radiated spurious measurements were made in accordance with the procedures of the ANSI C63.26-2015.

The EUT was placed on a non-reflective table inside a 3 meter open area test site. The EUT was set on continuous transmit.

The measurement antenna was placed at a distance of 3 meters from the EUT. During the tests, the antenna height and polarization as well as EUT azimuth were varied in order to identify the maximum level of emissions from the EUT. The test was performed by placing the EUT on 3 orthogonal axes. The frequency range up to the 10th harmonic was investigated.

To get a maximum emission level from the EUT, the EUT was rotated throughout the X-axis, Y-axis and Z-axis. Worst case is X-axis

Test Setup:

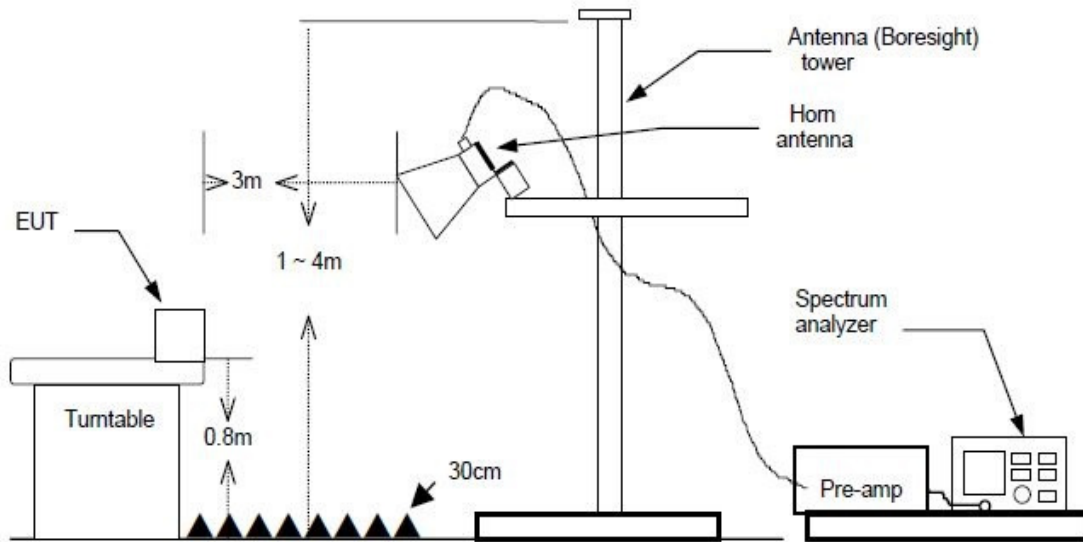

Figure 5 – Radiated Spurious Emissions

Frequency (MHz)	Measured Amplitude (dBm)	Equivalent Radiated Power (dBm)	Antenna Polarity (V/H)	Spurious Limit (dBm)	Margin	Comment
799.95	-48.0	-38.38	Horizontal	-13	-25.38	
1199.925	-50.0	-40.38	Horizontal	-13	-27.38	
1599.9	-49.0	-39.38	Horizontal	-13	-26.38	
1999.875	-53.5	-43.88	Horizontal	-13	-30.88	

Table 6 - Spurious Radiated Emission Data – Black Antenna

Frequency (MHz)	Measured Amplitude (dBm)	Equivalent Radiated Power (dBm)	Antenna Polarity (V/H)	Spurious Limit (dBm)	Margin (dB)	Comment
799.95	-46.3	-37.18	Horizontal	-13	-24.18	
1199.925	-51.8	-42.38	Horizontal	-13	-29.38	
1599.9	-49.8	-45.18	Horizontal	-13	-32.18	
1999.875	-48.8	-44.28	Horizontal	-13	-31.28	

Table 7– Spurious Radiated Emission Data – Grizzly Antenna

NOTE: There were no detectable emissions above the 4th harmonic. Measurement was made at the 10th harmonic.

6. Frequency Stability vs Temperature

Test Requirement(s):	§2.1055	Test Engineer(s):	Jerry M.
Test Results:	Pass	Test Date(s):	01/17/2019

Test Procedures: As required by 47 CFR 2.0155, Frequency Stability measurements were made at the RF antenna output terminals of the EUT.

The EUT was placed in an Environmental Chamber with all the support equipment outside the chamber. The EUT was set to transmit a modulated carrier. The reference frequency at 20°C was observed and noted down. The frequency drift was investigated for every 10°C increment until the unit was stabilized then recorded the reading in tabular format with the temperature range of -30°C to 50°C.

Test Setup:

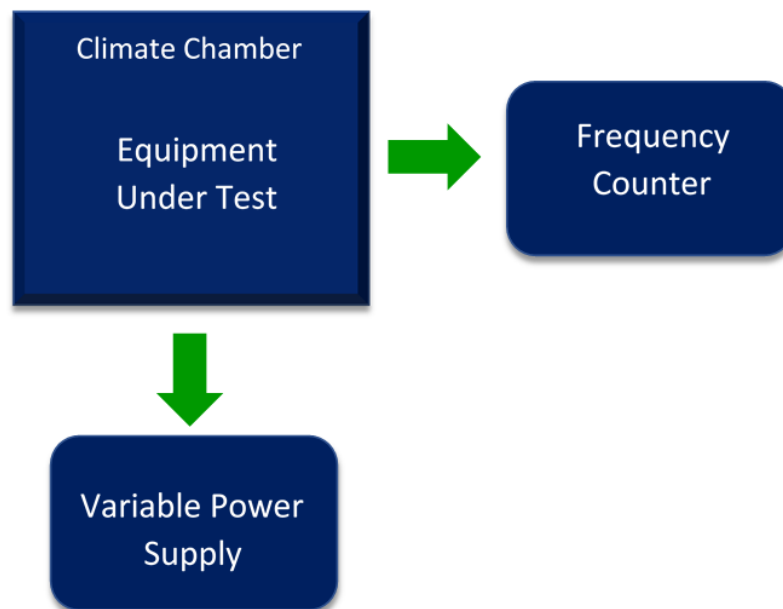
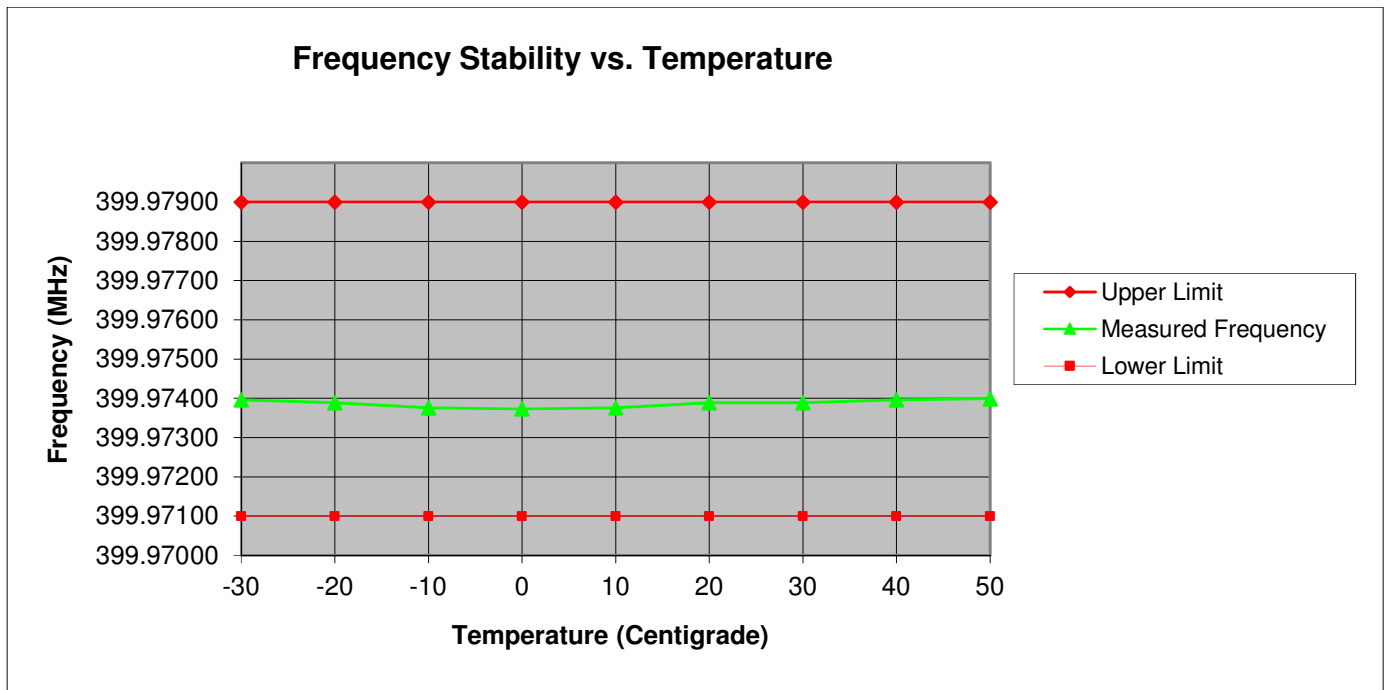

Figure 6 – Frequency Stability Test Setup

Temperature centigrade	Measured Frequency (MHz)	Upper Margin (MHz)	Lower Margin (MHz)
-30	399.97396	-0.00504	0.00296
-20	399.97389	-0.00511	0.00289
-10	399.97376	-0.00524	0.00276
0	399.97373	-0.00527	0.00273
10	399.97376	-0.00524	0.00276
20	399.97389	-0.00511	0.00289
30	399.97389	-0.00511	0.00289
40	399.97396	-0.00504	0.00296
50	399.97399	-0.00501	0.00299

Table 8 – Temperature vs Frequency Test Result



Plot 29 – Temperature vs Frequency

7. Frequency Stability vs Voltage

Test Requirement(s):	§2.1055	Test Engineer(s):	Keith T.
Test Results:	Pass	Test Date(s):	01/18/2019

Test Procedures: As required by 47 CFR 2.0155, Frequency Stability measurements were made at the RF antenna output terminals of the EUT.

The EUT was connected to a variable DC source. The frequency was measured at both the nominal 3.3 Vdc of the EUT and at the extreme $\pm 15\%$ of nominal which is 85% level or 2.80Vdc and at the 115% level or 3.8Vdc

With the voltage set to a measurement point, the transmitted signal was captured by the spectrum analyzer and the frequency value determined. The frequencies are compared to the tuned frequency. All data for these measurements are found in the table 6.

Reference Frequency: 399.975 at 3.3VdC at 25°C

Test Setup:

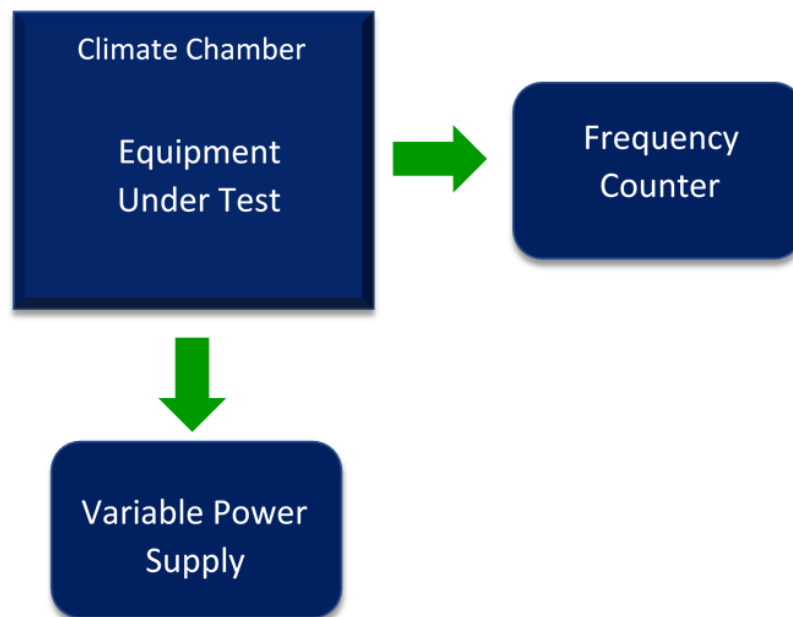
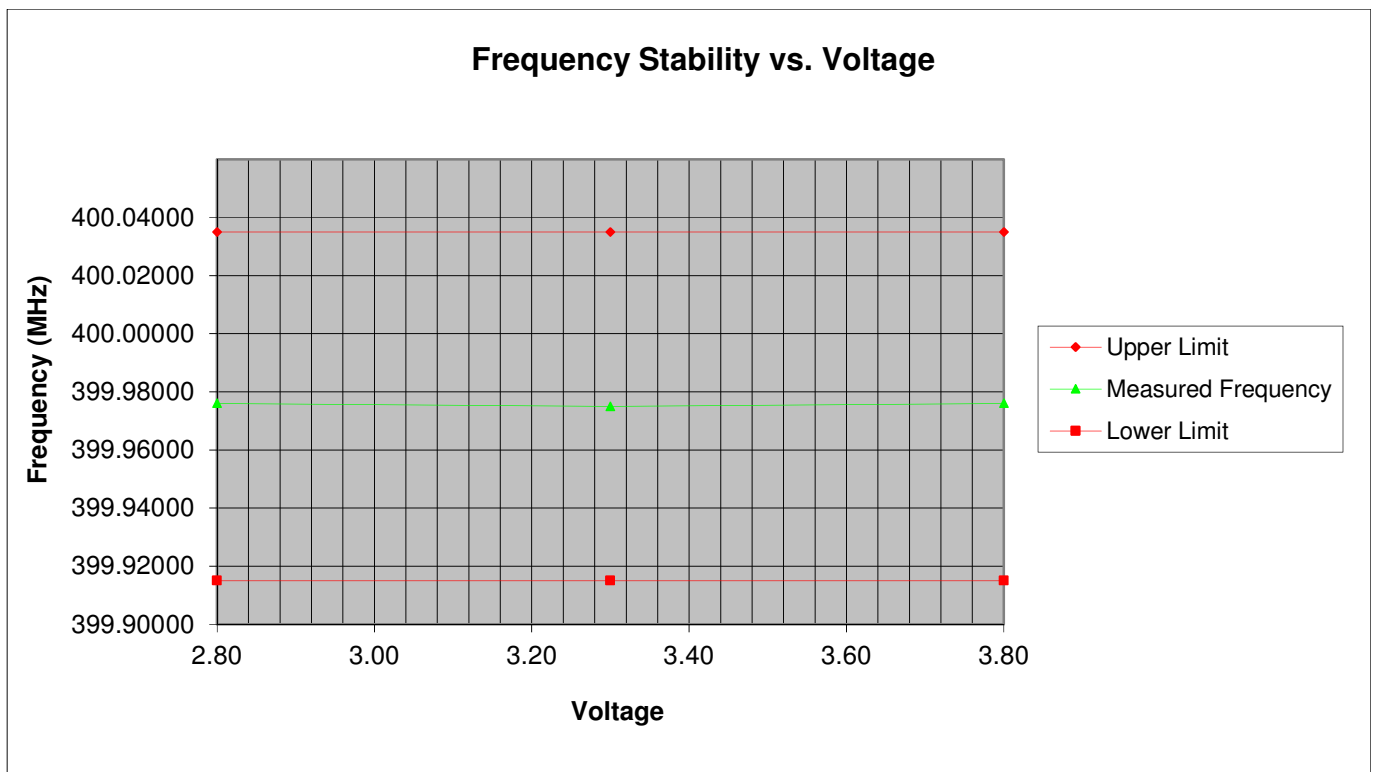

Figure 7 – Frequency Stability Test Setup

Input Voltage (Vdc)	Measured Frequency (MHz)	Upper Margin (MHz)	Lower Margin (MHz)
2.80	399.97600	-0.05900	0.06100
3.30	399.97500	-0.06000	0.06000
3.80	399.97600	-0.05900	0.06100

Table 9. Temperature vs. Voltage Test Result



Plot 30 – Temperature vs Voltage

I. Test Equipment

Equipment	Manufacturer	Model	Serial #	Last Cal Date	Cal Due Date
Spectrum Analyzer	Agilent	E4402B	US41192757	Mar/19/18	Mar/19/19
Spectrum Analyzer	Hewlett Packard	8563E	3821A09316	Jan/30/18	Jan/30/19
Directional Coupler	Andrew	C-10-CPUS-N	150503142544	NCR	None
Attenuator 20dB	Weinschel	41-20-12	86332	NCR	None
Variable Attenuator	JFW	50R-320-SMA	7054221439	NCR	None
Signal Generator	Agilent	E4432B	US40053021	NCR	None
Signal Generator	Agilent	E4432B	US38220446	NCR	
Horn Antenna	Com-Power	AHA-118	071150	Nov/12/18	Nov/12/20
Horn Antenna	Com-Power	AH-118	71350	NCR	None
Antenna	EMCO	GTEM 5417	1063	Verified	None
Attenuator 10dB	Huber+Suhner	6810.17.A	747300	NCR	None
Digital Multimeter	Fluke	77 III	72550270	Jan/30/18	
Power Supply	Hewlett Packard	6236B	2735A-19608	NCR	None
Temperature Chamber	Thermotron	SM-3.5S	12817	Oct/17/18	Oct/17/19

Table 10 – Test Equipment List

***Statement of Traceability:** Test equipment is maintained and calibrated on a regular basis. All calibrations have been performed by a 17025 accredited test facility, traceable to National Institute of Standards and Technology (NIST)

END OF TEST REPORT