

# 深圳市飞敏科技有限公司

ShenZhen FeiMin Technology CO.,LTD.

## 产品规格书

Product specification

客户

CUSTOMER: \_\_\_\_\_

产品名称

PRODUCTS: \_\_\_\_\_

D2 芯片天线 D2 Chip Ant.

客户料号

PART NO: \_\_\_\_\_

产品型号

Spec.: \_\_\_\_\_

E.6.014

日期

Data: \_\_\_\_\_

2023.08.16

供应商		
SUPPLIER		
拟制 PREPARED BY	审核 CHECKED BY	批准 APPROVED BY
马凡	夏兴喜	马冬冬

客户		
CUSTOMER		
承认 ACCEPTED BY	审核 CHECKED BY	批准 APPROVED BY

备注：承认盖章后请回复一份承认书（或复印件）给我司，其余由贵公司存档

REMARK: Please send us one(or copy)of this approval with stamp after accepting, other copies filed by the customer.

地址：深圳市宝安区西乡街道固戍社区恒南一路C栋厂房303室

ADD: Room 303, Building C, Hengnan one Road, Gushu community, Xixiang Street, Bao'an District, Shenzhen City

电话 Tel: 0755-23035723

传真 Fax: 0755-23036702

邮箱 E-mail: ant001@fmant.cn

网址 HTTP: [www.fmant.cn](http://www.fmant.cn)

## 1. 项目信息 Project Information

### 1.1. 外观尺寸 Appearance and Dimensions

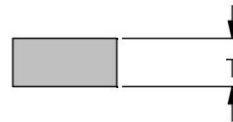
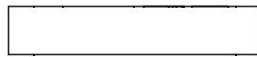
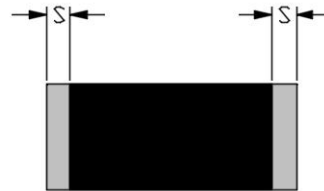
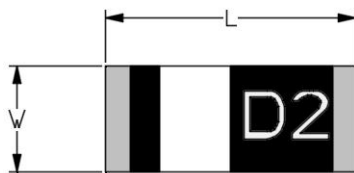

Symbol	Dimension (mm)
L (长度)	$5.2 \pm 0.20$
W (宽度)	$2.2 \pm 0.20$
T (厚度)	$1.0 \pm 0.20$
S (电极宽度)	$0.5 \pm 0.20$

## 1.2. 天线净空区面积 antenna Clearance area

在设计天线时，应远离金属部件和不相关的部件，如电池、振荡器、防护罩、摄像头等，为天线留出干净的空间。这个间隔简称为净空区。以下是我们建议预留的净空区面积大小。

When designing the antenna, it should be far away from metal components and irrelevant components such as batteries, oscillators, shields, cameras, etc. to leave a clean space for the antenna. This interval is called clearance area. The following is the size of clearance area we recommend to reserve.

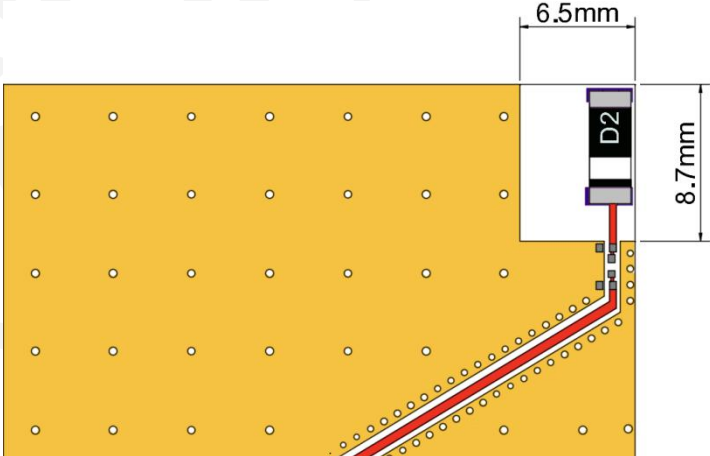
天线型号 (Model)	天线尺寸 (size)	净空区面积 Clearance area L*W(mm)	
A1 (2.4G 单极)	5.5*1.2*1.2	9.1*5.6	
X5 (2.4G 单极)	5.2*2.2*1.0	8.7*6.5	
X6 (2.4G pifa)	3.2*1.6*1.0	7.0*6.0	
D1 (2.4G 单极)	5.2*2.2*1.0	8.7*6.5	
<b>D2 (2.4G 单极)</b>	<b>5.2*2.2*1.0</b>	<b>8.7*6.5</b>	
D3 (2.4G 单极)	3.4*1.7*1.2	7.2*6.5	
F01 (2.4G pifa)	3.2*1.6*0.4	7.0*6.0	
S2 (2.4/5.8G 双频)	7.0*3.0*2.0	9.0*7.0	
U1 (UHF 单极)	15.0*3.0*1.0	19.0*8.0	
G2 (GPS 单极)	9.5*3.0*1.0	13.5*7.5	

**1.3. 天线 Demo 测试板 Demo Test Board with Antenna(Unit:mm)**

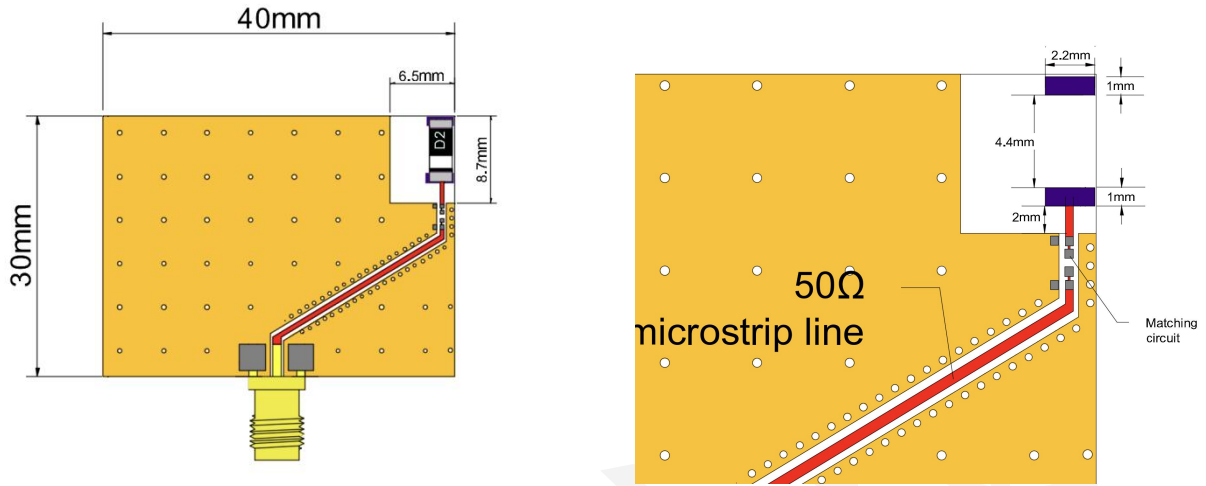

**1.4. 建议 PCB 板尺寸布局 Suggested PCB board size layout**

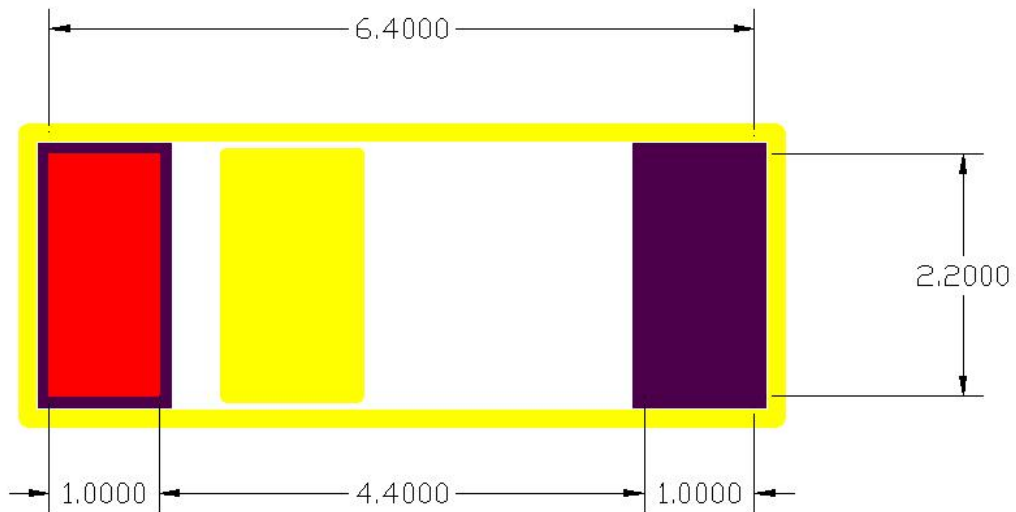

单位: mm

## 1.5. 匹配电路 Matching Circuit

使用以下推荐的匹配和调谐元件值，在我们的标准 30\*40 mm 评估板上，中心频率约为 2440mhz。然而，这些是典型的参考值，当电路板或零件供应商不同时，可能需要更改。

With the following recommended values of matching and tuning components,the center frequencies will be about 2440 MHz at our standard 30\*40 mm evaluation board.However,these are typical reference values which may need to be changed when circuit boards or part vendors are different.

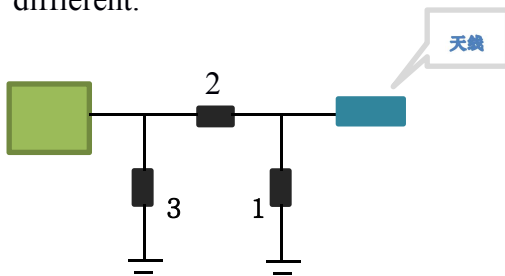

系统匹配电路元件(村田)		
System Matching Circuit Component (Murata)		
Location	Description	Tolerance
1	NC	/
2	1.6nH(0402)	± 0.2nH
3	0.75pF (0402)	± 0.1pF

## 2. 电特性 Electrical Characteristics(30\*40mm ground plane)

### 2.1.电子表格 Electrical Table

特征 Characteristics	规范 Specifications	单位 Unit
轮廓尺寸 Outline Dimensions	5.2*2.2*1.0	mm
工作频率 Working Frequency	2400-2500	MHz
电压驻波比 VSWR	<2	/
阻抗 Impedance	50	Ω
极化 Polarization	线极化 Line	/
增益 Gain	峰值 Peak	2.75
	效率 Efficiency	50
		%

## 2.2.电压驻波比与回波损耗 VSWR & return loss

VSWR

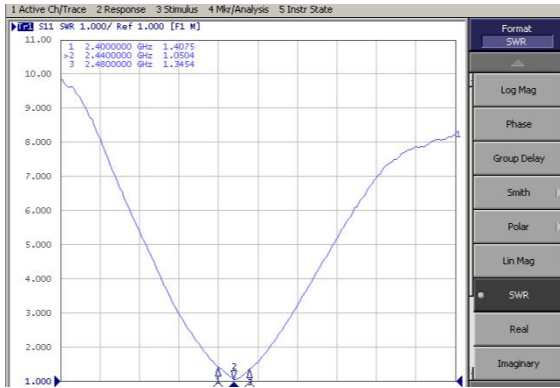

return loss

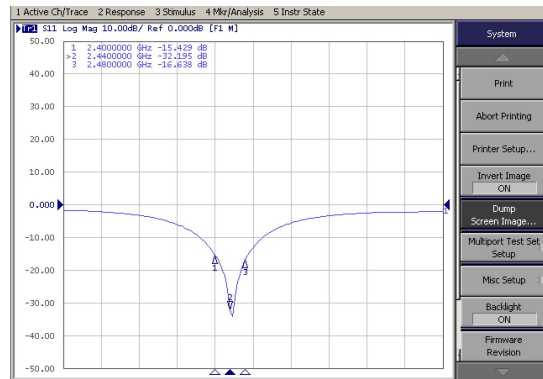

## 2.3.天线增益与效率 Gain and Efficiency

测试系统 Test system

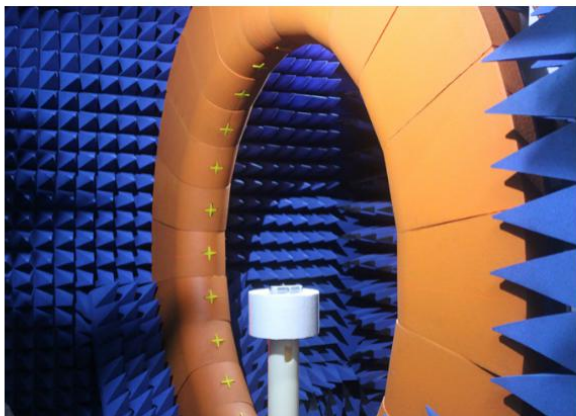

24 探头微波暗室

➤ 频率：0.4GHz至6GHz

### 主要测试指标

- ◆ 无源指标
- ◆ 增益
- ◆ 效率
- ◆ 3D方向图
  
- 有源指标
- TRP总辐射功率
- TIS总接收灵敏度

Frequency (MHz)	Gain (dBi)	Efficiency (%)
2400 MHz	1.34	45.88
2410 MHz	1.37	46.78
2420 MHz	1.09	47.67
2430 MHz	1.22	50.38
2440 MHz	1.45	50.78
2450 MHz	1.67	51.44
2460 MHz	1.87	51.34
2470 MHz	2.48	51.36
2480 MHz	2.75	51.24
2490 MHz	1.67	51.36
2500 MHz	1.89	52.24

#### 2.4. 天线辐射方向图 Antenna radiation pattern

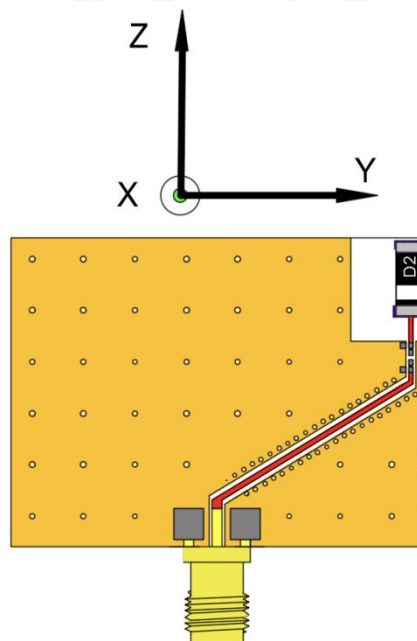

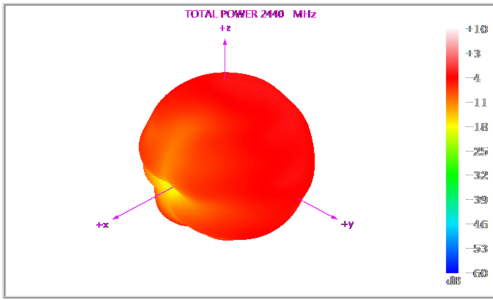

3D-plane@2.44GHz

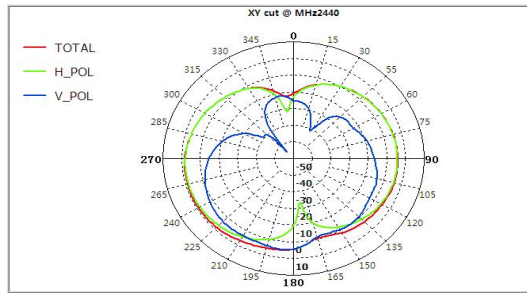

2D-plane XOY @2.44GHz

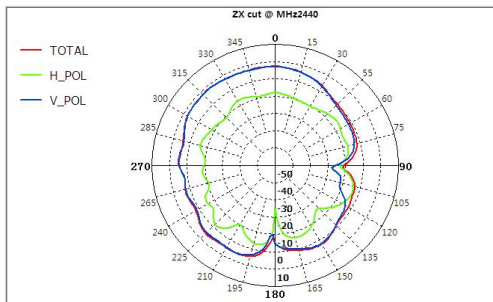

2D-plane XOZ@2.44GHz

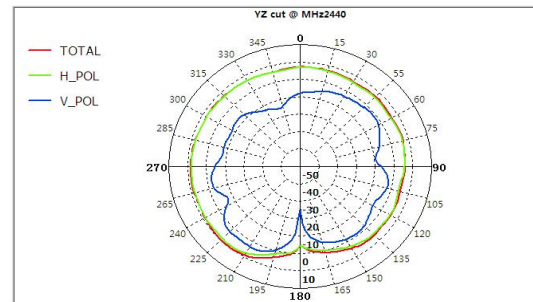

2D-plane YOZ @2.44GHz

### 3. 焊接和安装 Soldering and Mounting

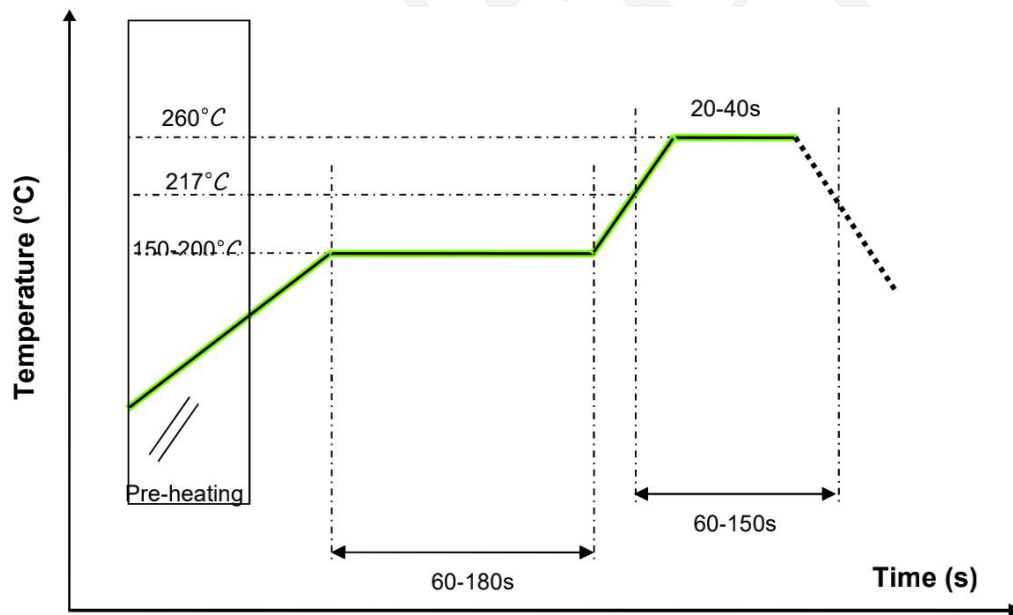



## 4.包装信息 Packaging Information

### 4.1. 胶带规范 Tape specification

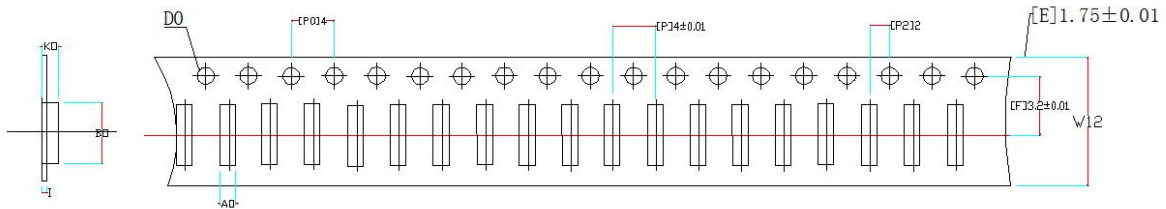

Index	A0	B0	K0	P0	P	P2	φ D0	W	E	F	T
Dimension(mm)	2.5 ± 0.1	5.5 ± 0.1	1.3 ± 0.1	4.0 ± 0.1	8.0 ± 0.1	2.0 ± 0.1	1.5 +0.1	12.0 ± 0.3	1.75 ± 0.1	5.5 ± 0.1	0.3 ± 0.05

1. 10 链轮孔距累积公差±0.20。 10 sprocket hole pitch cumulative tolerance ±0.20.
2. 在 250 毫米中，载体的拱度在 1 毫米以内。 Carrier camber is within 1 mm in 250 mm.
3. 所有尺寸符合 EIA-481-C 要求。 All dimensions meet EIA-481-C requirements.
4. 材料:透明 PS。 Material :Transparent PS.
5. 包装长度每 7"卷:12.5 米。 Packing length per 7" reel :12.5Meters.
6. 组件加载/ 7"卷:3000 个。 Component load per 7" reel : 3000 pcs.(前后共预留 120pcs)

### 4.2.卷规范 Reel specification

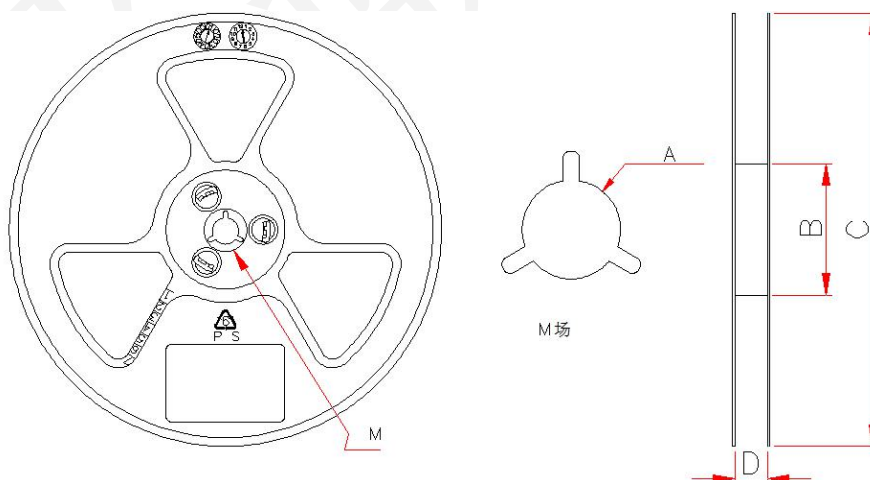

Index	A	B	C	D
Dimension(mm)	13.3 ± 0.3	100 ± 0.3	330 ± 0.3	24.5 ± 0.3

## 5.注意事项 Notes

- 1) 产品应小心处理，以避免汗水和皮肤油脂损坏或污染。  
Products should be handled with care to avoid damage or contamination from perspiration and skin oils.
- 2) 对于单个部件，强烈建议使用镊子或真空拾取。  
The use of tweezers or vacuum pick up is strongly recommended for individual components.

## 6.储存条件 Storage Conditions

- 1) 推荐产品从交货之日起 6 个月内使用。  
Recommended products should be used within 6 months form the time of delivery.
- 2) 存储环境条件  
Storage environment condition
  - 温湿度条件:-10~40℃, 30~70%RH。  
Temperature and humidity conditions:-10~40℃ and 30~70%RH.
  - 包装材料应保存在空气中不含氯或硫的地方。  
The packaging material should be kept where no chlorine or sulfur exists in the air.
  - 产品应储存在仓库内，无热震、振动、阳光直射等。  
Products should be storage in thewarehouse without heat shock,vibration,direct sunlight and so on.