



1. Project specification

NC	Content	Page Number
1	Project specification	1
2	Electrical performance test report	2
3	Product graph	2
4	Network analyzer graph	3
5	Efficiency and Gain test results	4
6	Radiation pattern	5



2. Electrical performance test report

Frequency	2.402GHz-2.48GHz
Impedance	50 Ω hm
VSWR	2.0 MAX
Return Loss	-40dB Max
Radiation	Omni-directional
Gain(peak)	3.3 dBi
Polarization	Linear. Vertical
Type of antenna	PCB Antenna

3. Product graph

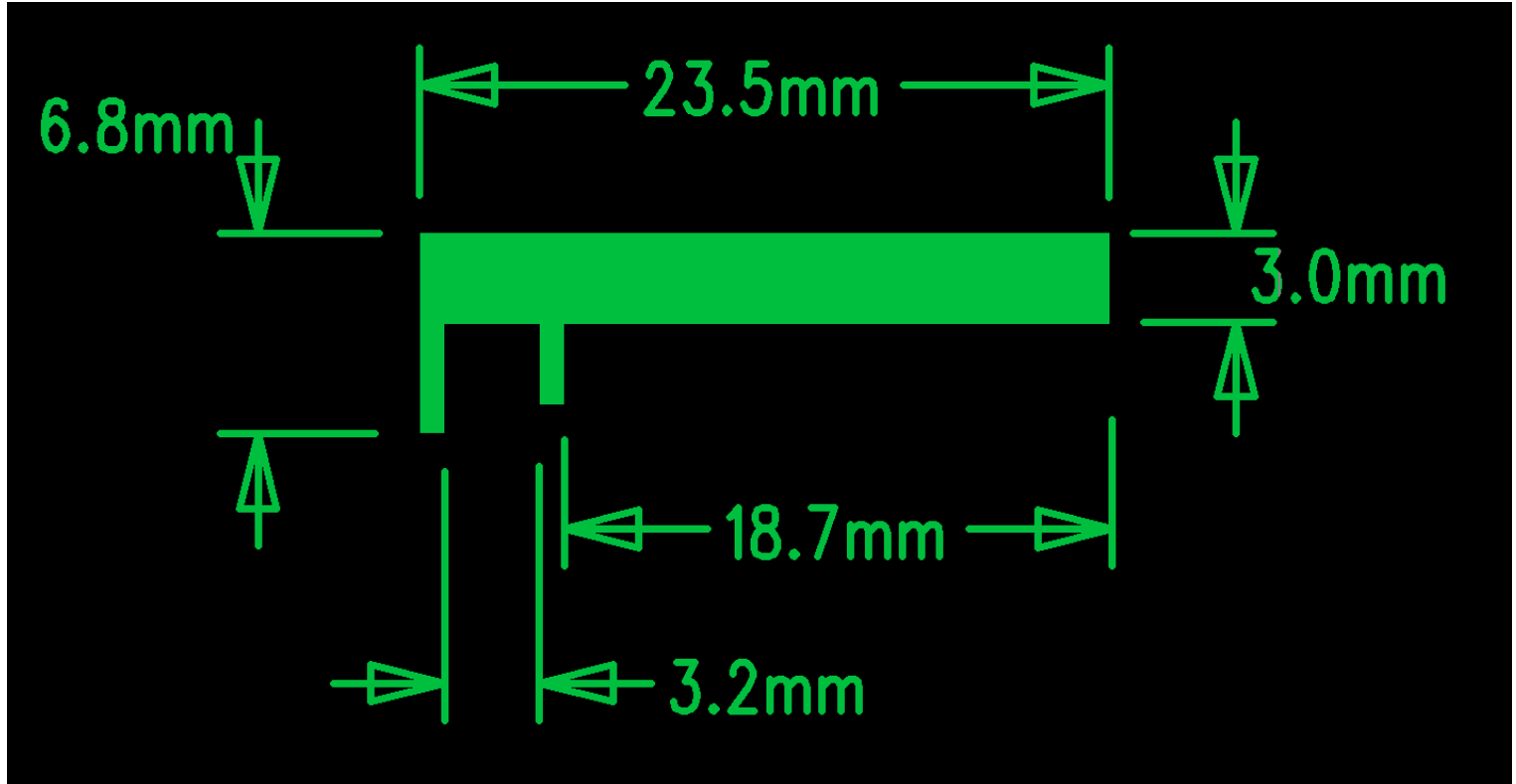



4. Network analyzer graph

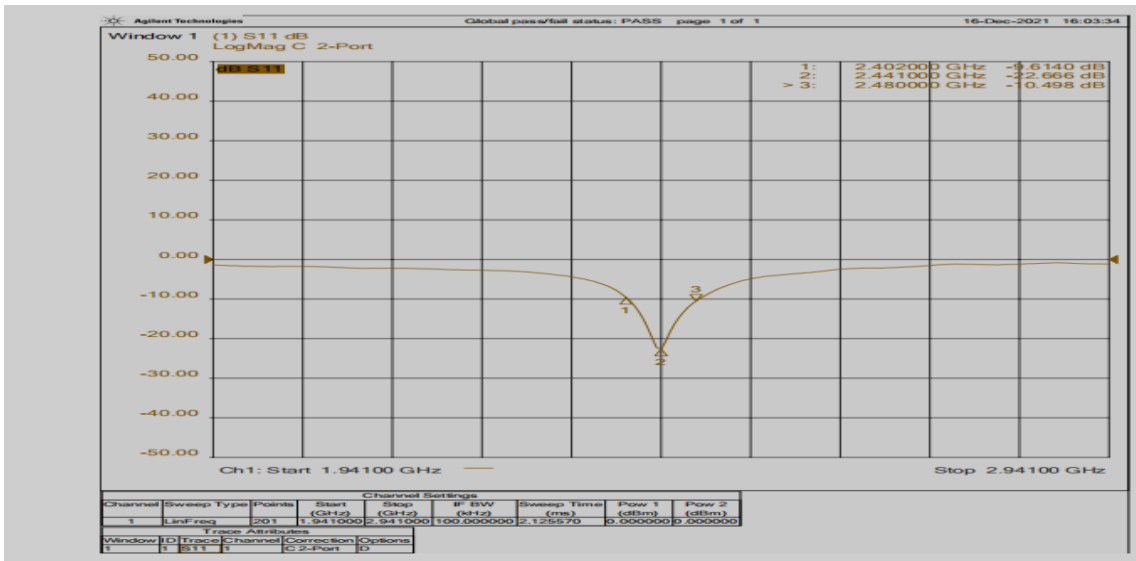
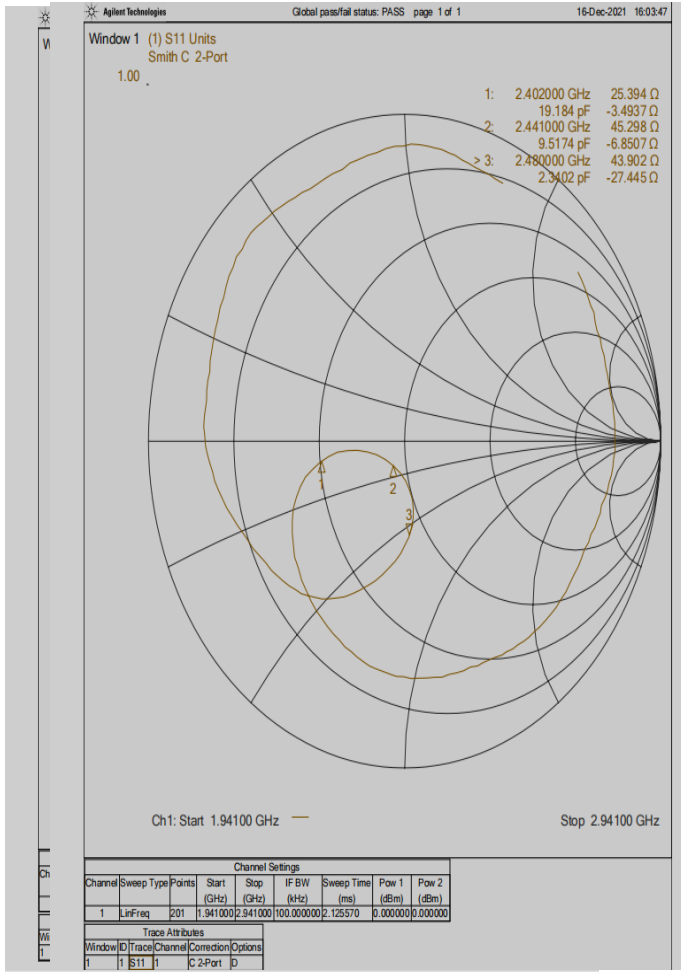



5. Efficiency and Gain test results

Passive Test For WIFI2.4								
Freq	Effi	Effi	Gain	Gain	Max	Min	Attenut	Attenut
(MHz)	(%)	(dB)	(dBi)	(dBd)	(dB)	(dB)	Hor	Ver
2400	67.14	-1.73	3.21	1.05	3.21	-11.48		
2410	67.58	-1.70	3.38	1.22	3.38	-11.19		
2420	68.52	-1.64	3.47	1.32	3.47	-10.74		
2430	66.50	-1.77	3.34	1.19	3.34	-10.52		
2440	64.32	-1.92	3.23	1.07	3.23	-10.34		
2450	65.65	-1.83	3.39	1.23	3.39	-9.98		
2460	64.05	-1.94	3.26	1.11	3.26	-9.89		
2470	67.82	-1.69	3.39	1.24	3.39	-9.82		
2480	70.96	-1.49	3.38	1.22	3.38	-9.51		
2490	67.57	-1.70	3.01	0.86	3.01	-9.71		
2500	66.31	-1.78	2.81	0.66	2.81	-9.98		

2400-2500MHZ Efficiency

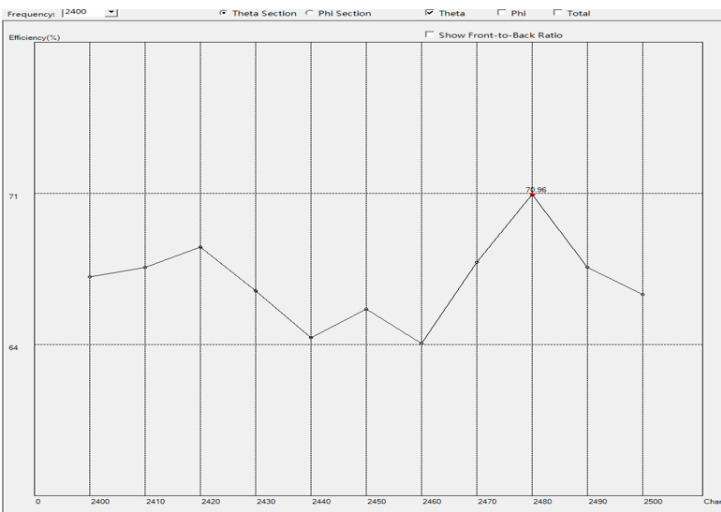

2400-2500MHZ Gain

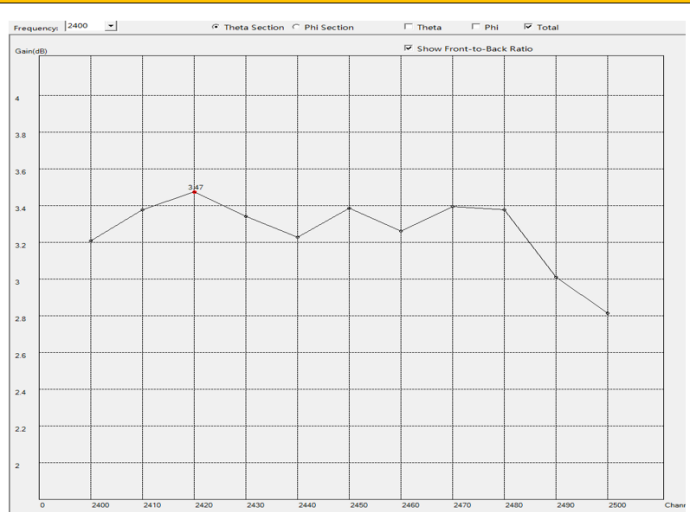

2400MHZ

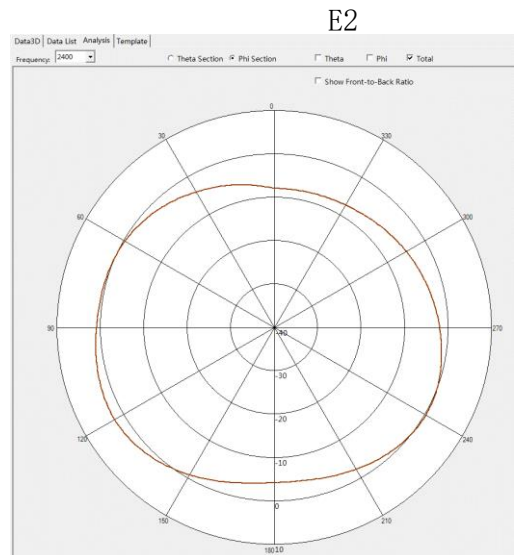
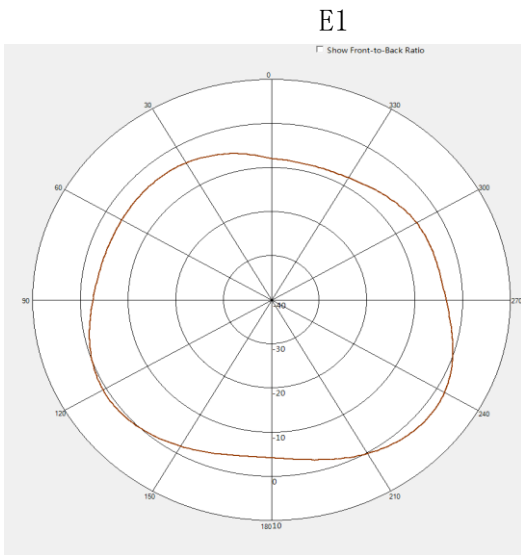
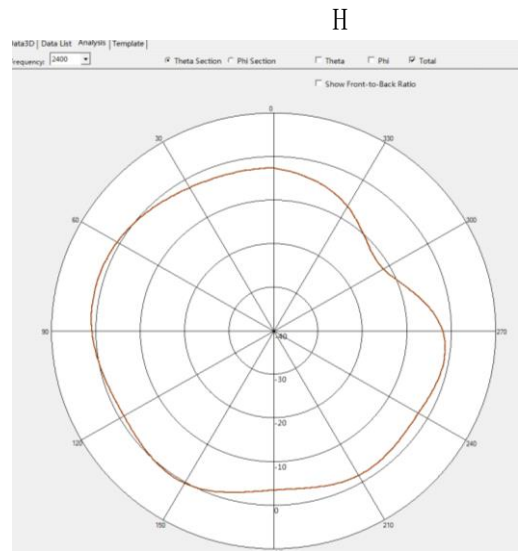
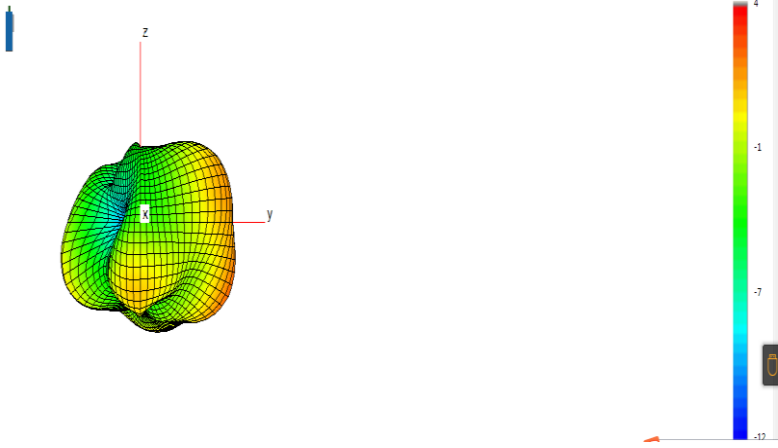

2410MHZ

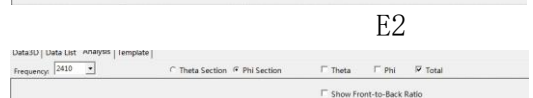
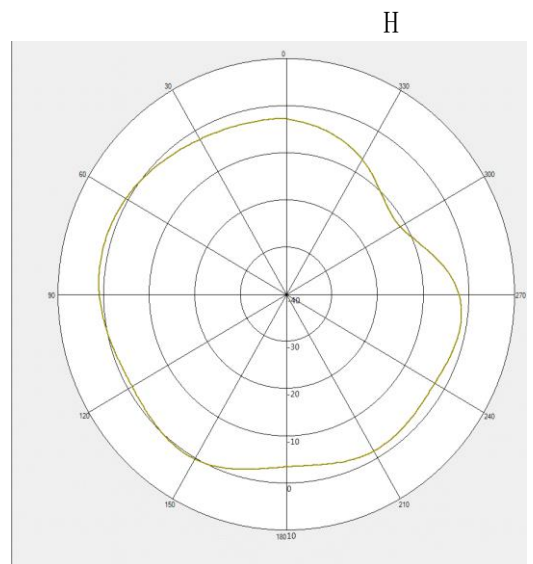
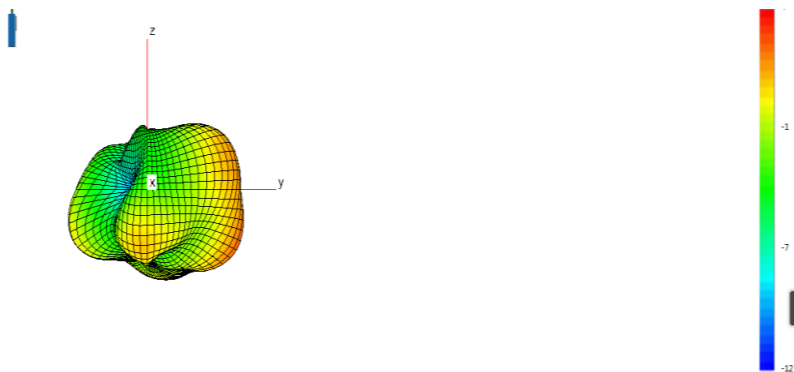

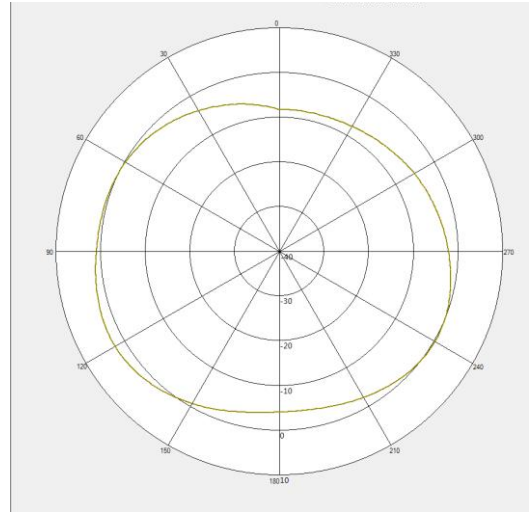
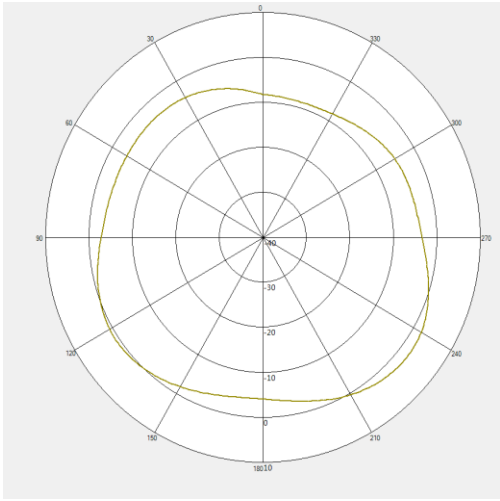

2420MHZ

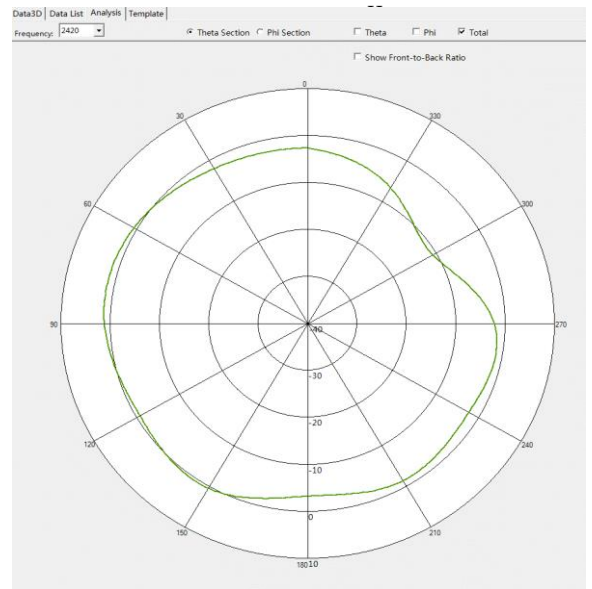
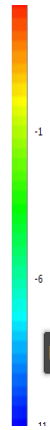
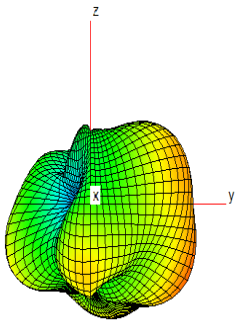

E1

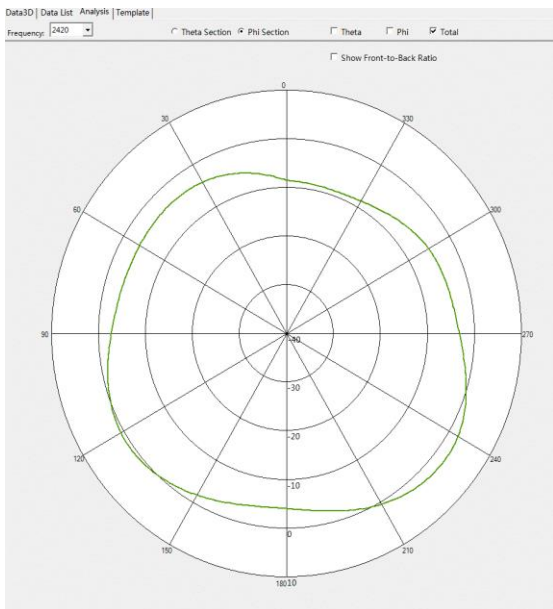

E2

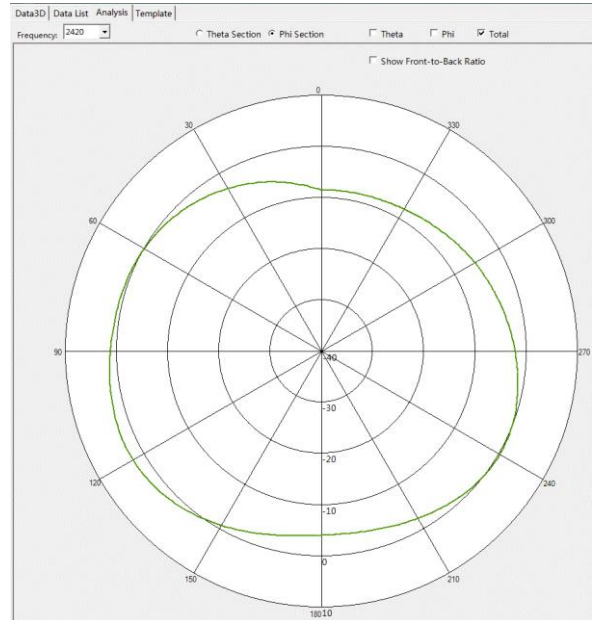

2430MHZ

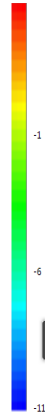
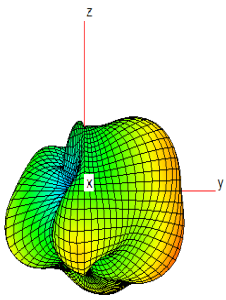

H

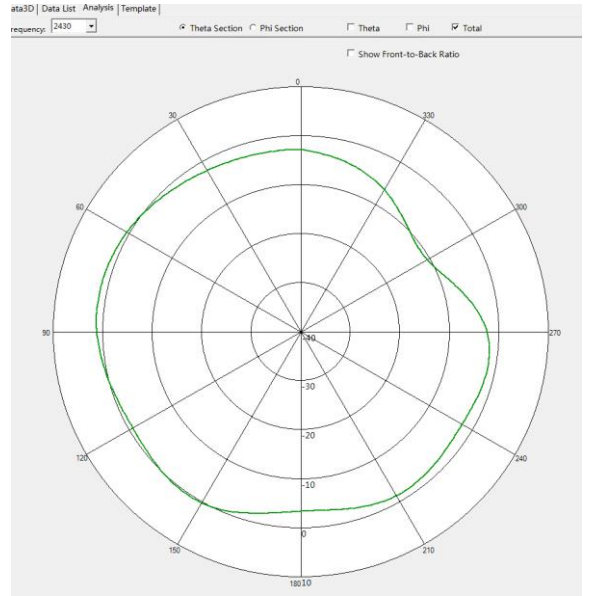

E1

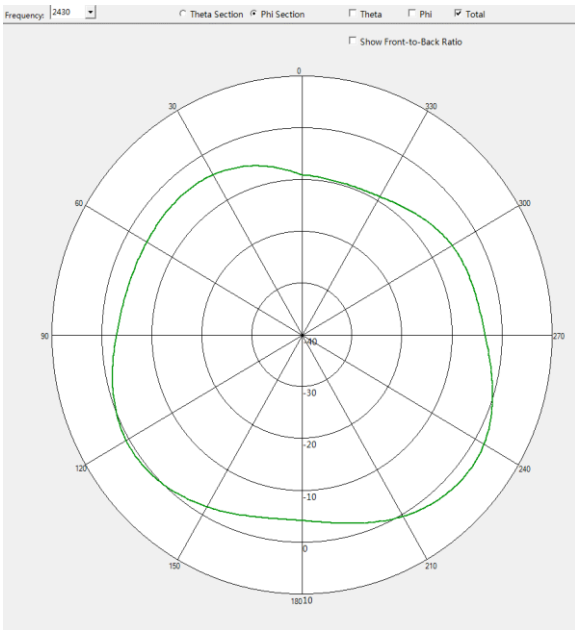

E2

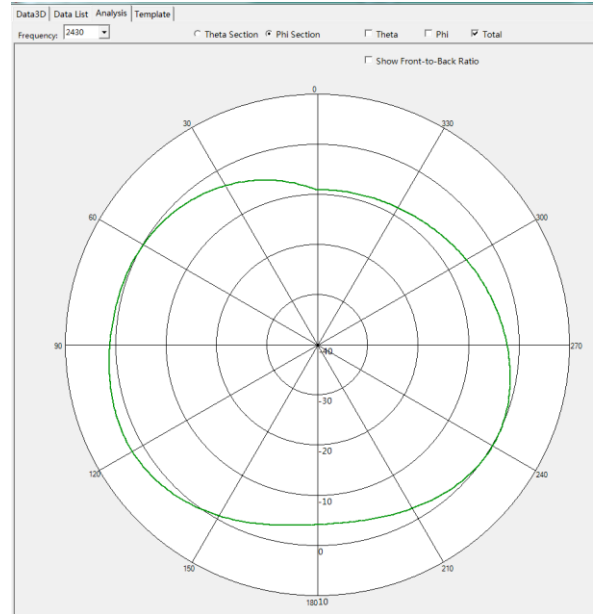

2440MHZ

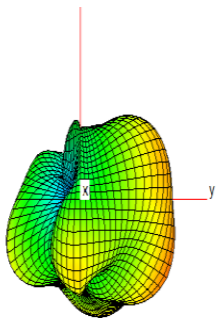

H

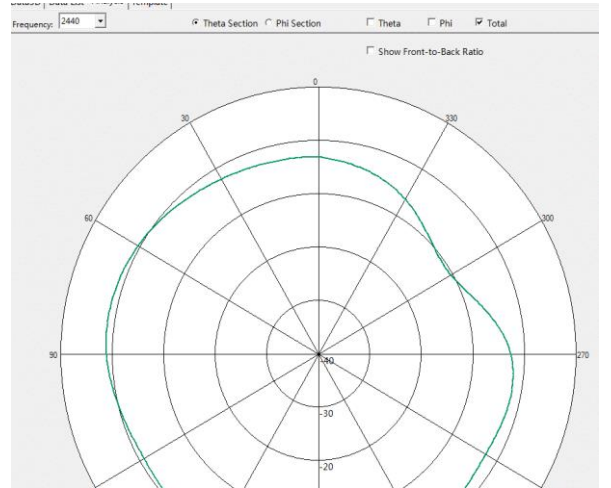

E1

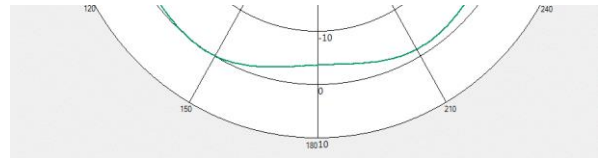
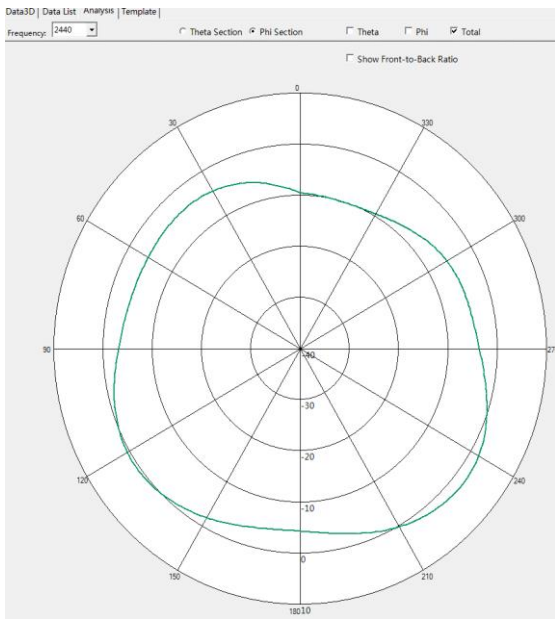

E2

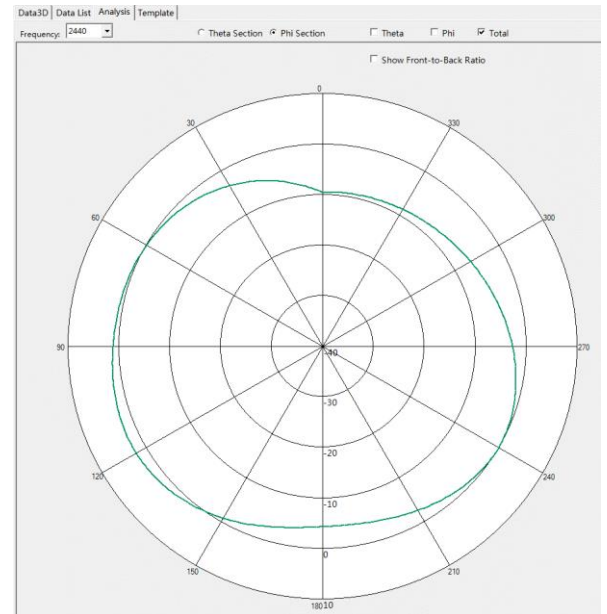

2450MHZ

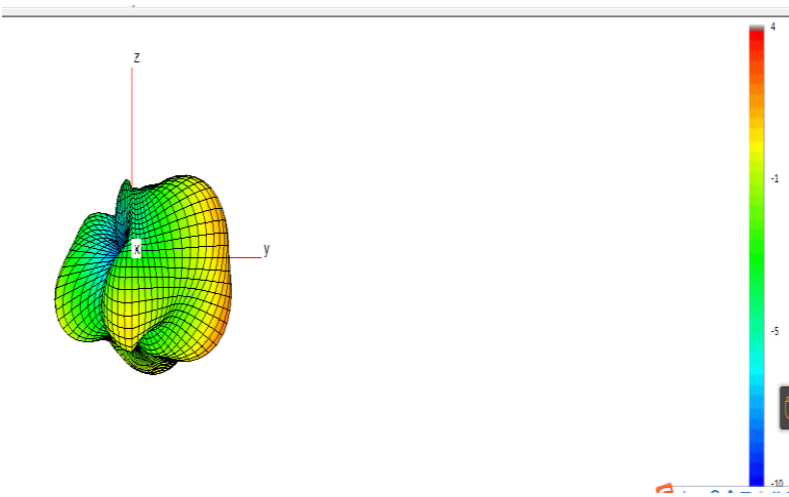

H

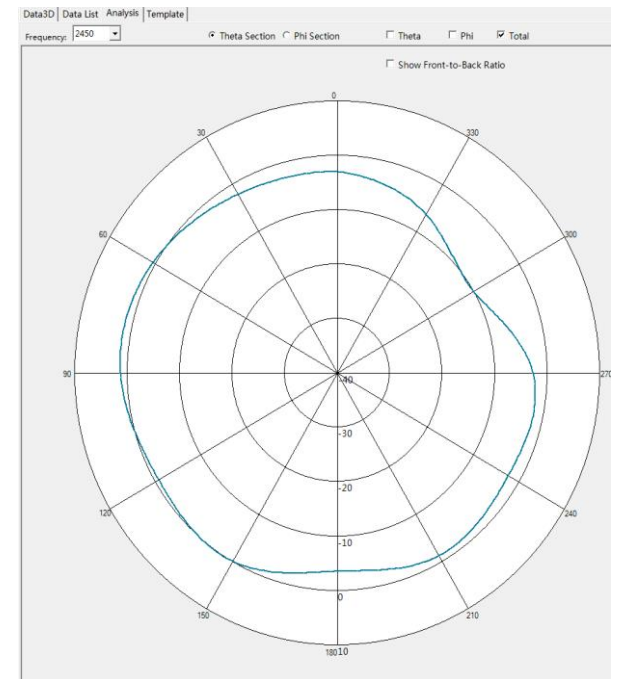

E1

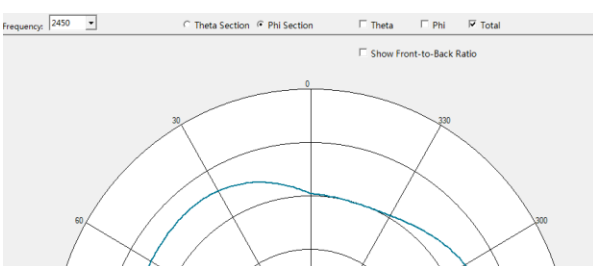

E2

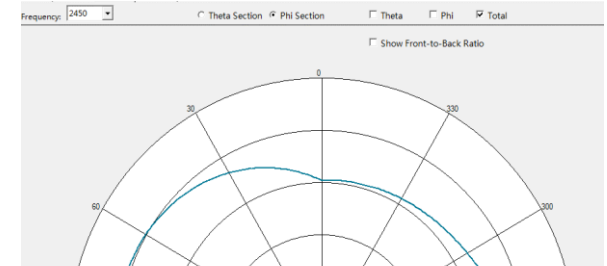

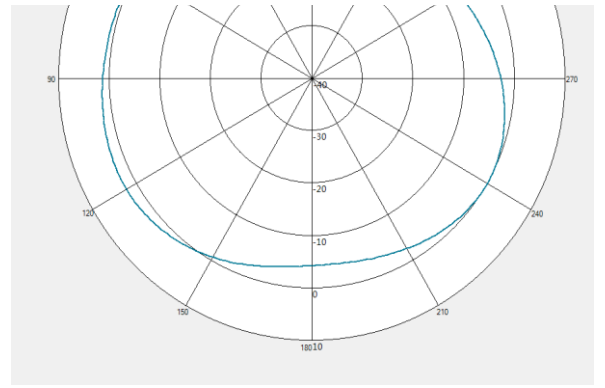
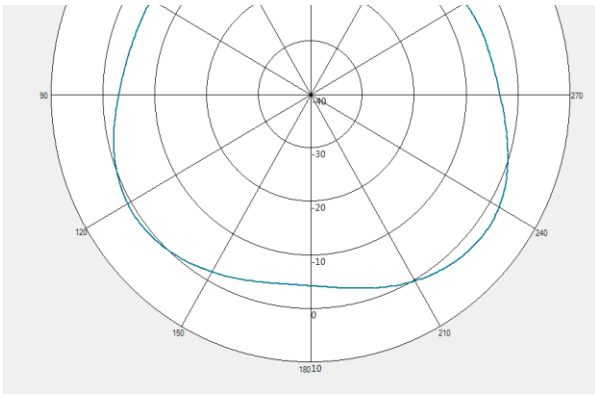

2460MHZ

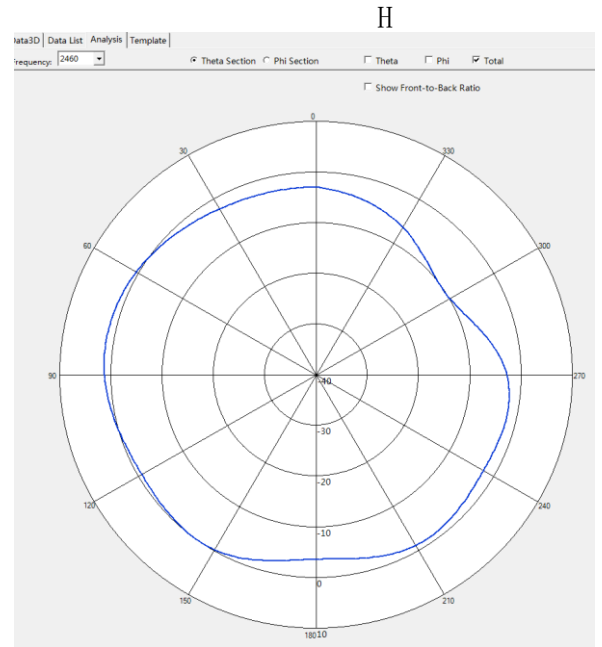
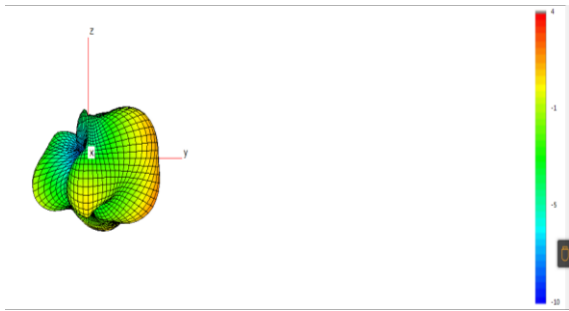

E1

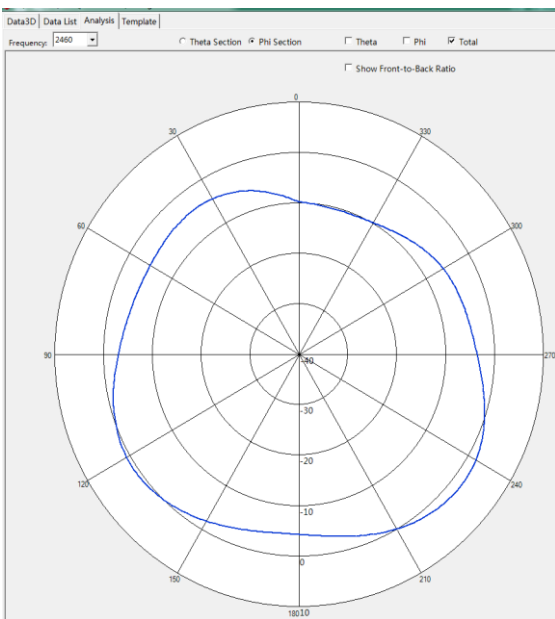

E2

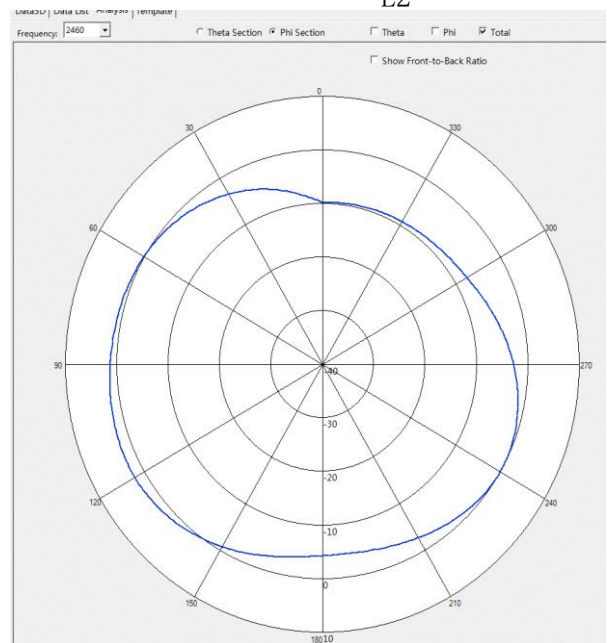

2470MHZ

Z

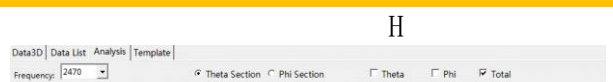

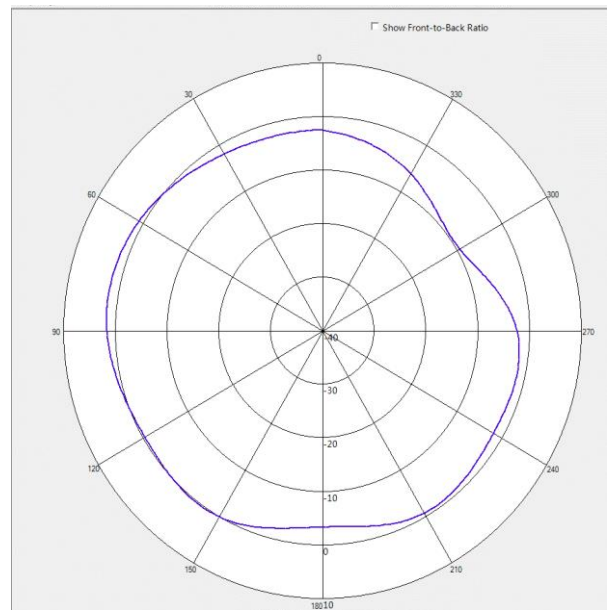
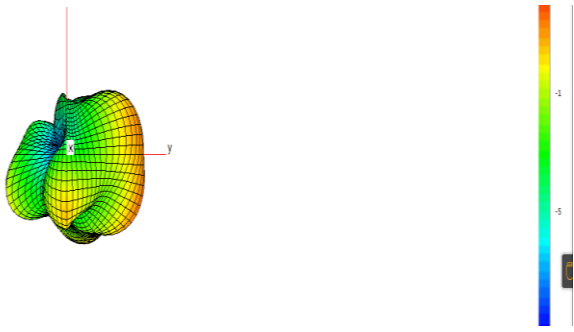

E1

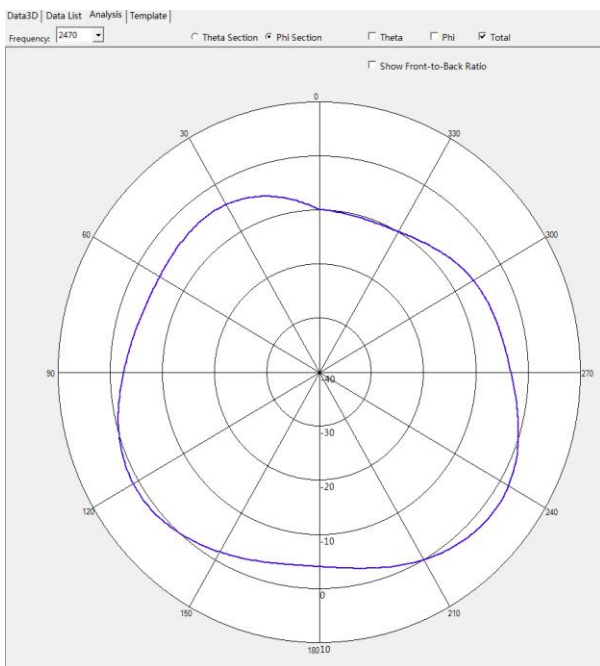

E2



2480MHZ

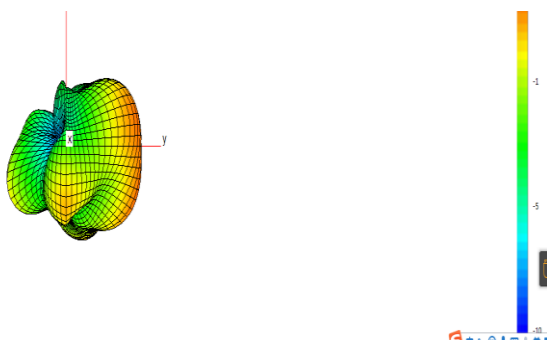

H

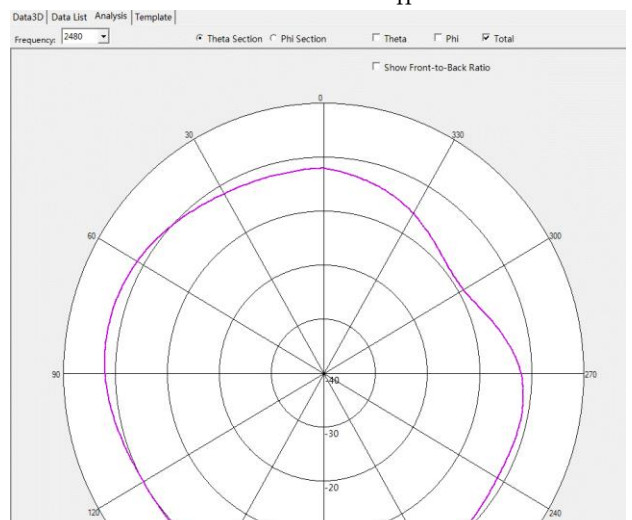

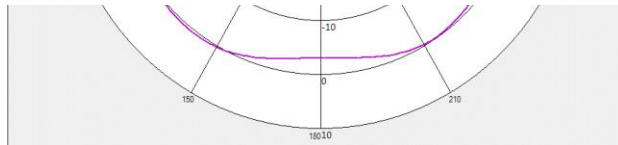

E1

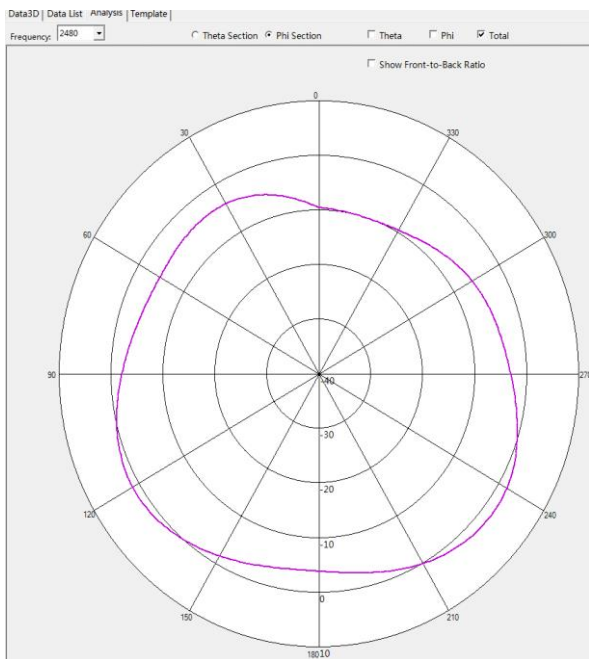

E2

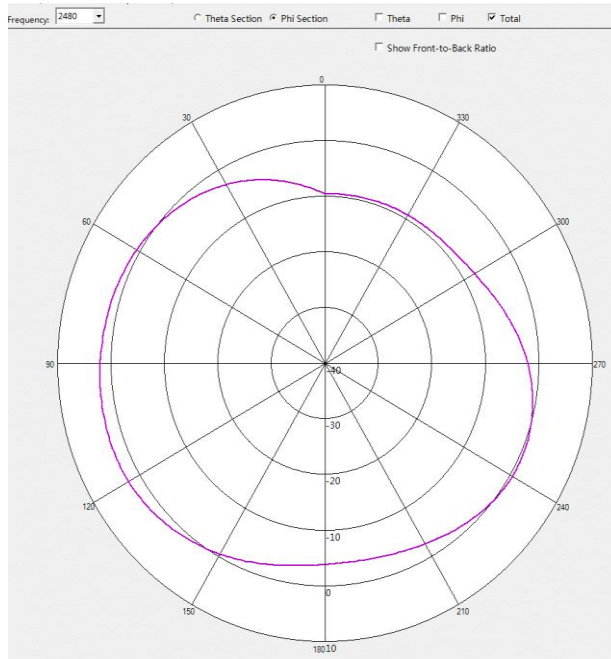

2490MHZ

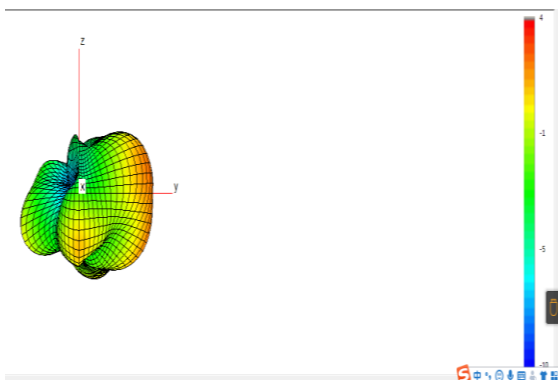

H

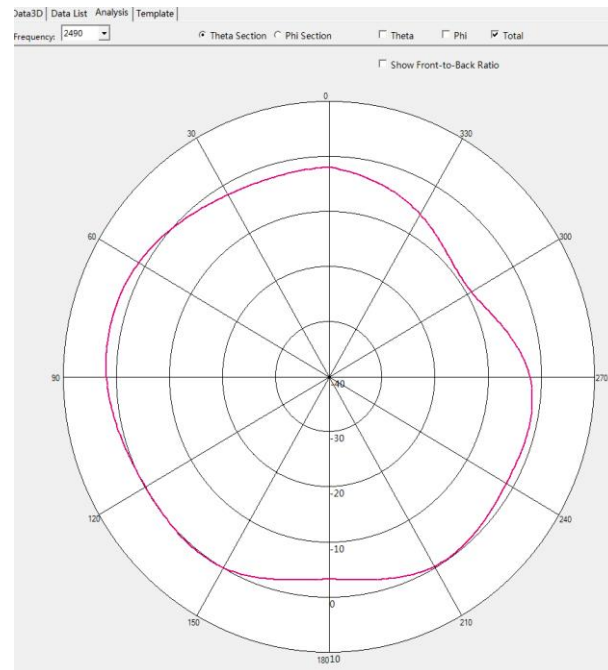

E1

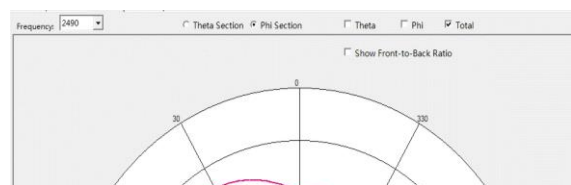

E2

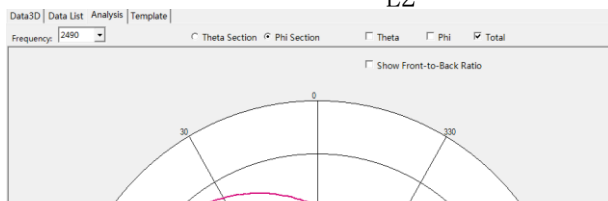

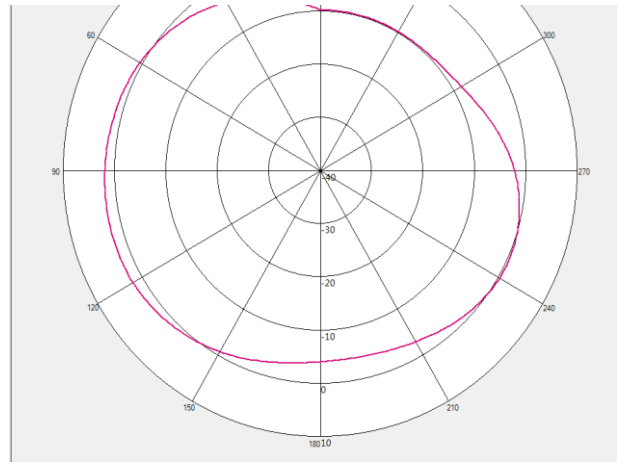
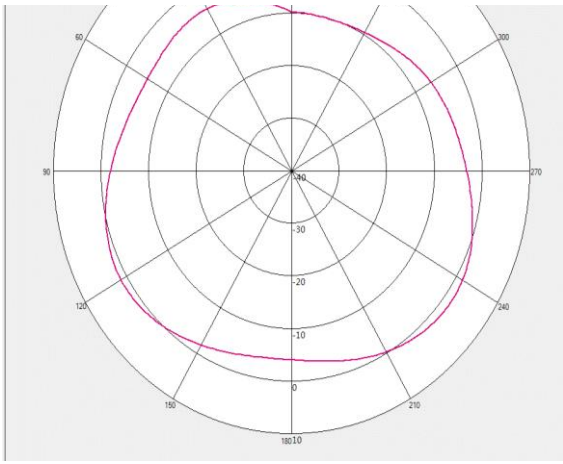

2500MHZ

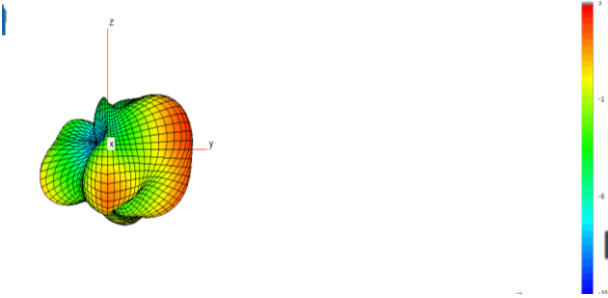

H

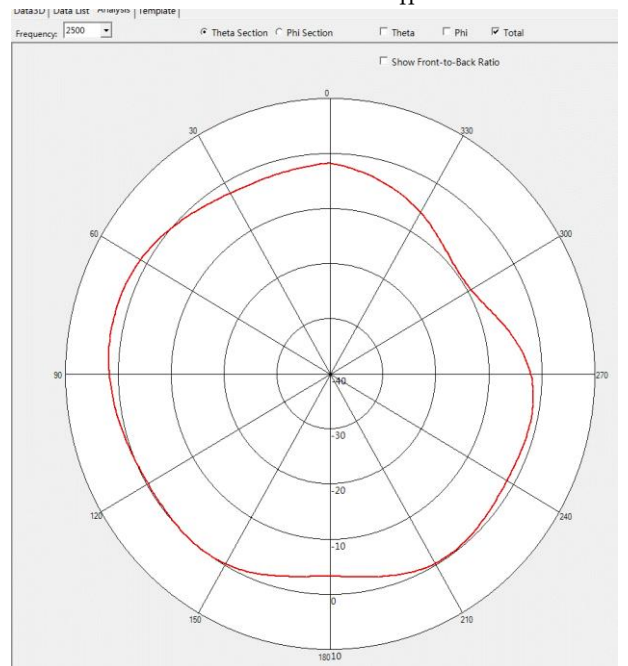

E1

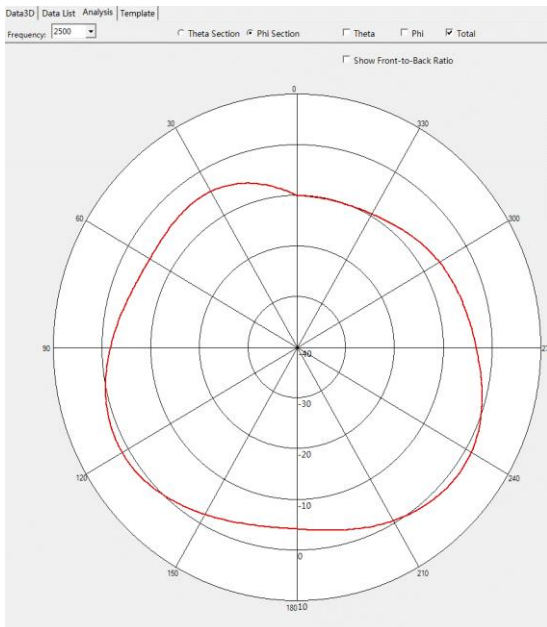

E2

