



# TEST REPORT

No.I19N00514-SAR

For

**RUGGEAR LIMITED**

**LTE SMARTPHONE**

**Model Name: RG655**

With

**Hardware Version: V1.0**

**Software Version: RG655\_US\_1.0.0.0.0\_5\_20190415**

**FCC ID: 2ASCH-RG655**

**Issued Date: 2019-04-23**

**Designation Number: CN1210**

**Note:**

The test results in this test report relate only to the devices specified in this report. This report shall not be reproduced except in full without the written approval of SAICT.

**Test Laboratory:**

Shenzhen Academy of Information and Communications Technology

Building G, Shenzhen International Innovation Center, No.1006 Shennan Road, Futian District, Shenzhen, Guangdong, P. R. China 518026.

Tel: +86(0)755-33322000, Fax: +86(0)755-33322001

Email: [yewu@caict.ac.cn](mailto:yewu@caict.ac.cn), website: [www.cszit.com](http://www.cszit.com)

## **REPORT HISTORY**

<b>Report Number</b>	<b>Revision</b>	<b>Issue Date</b>	<b>Description</b>
I19N00514-SAR	Rev.0	2019-04-23	Initial creation of test report

## TABLE OF CONTENT

<b>1 TEST LABORATORY .....</b>	<b>5</b>
1.1 TESTING LOCATION .....	5
1.2 TESTING ENVIRONMENT.....	5
1.3 PROJECT DATA .....	5
1.4 SIGNATURE.....	5
<b>2 STATEMENT OF COMPLIANCE .....</b>	<b>6</b>
<b>3 CLIENT INFORMATION .....</b>	<b>9</b>
3.1 APPLICANT INFORMATION .....	9
3.2 MANUFACTURER INFORMATION .....	9
<b>4 EQUIPMENT UNDER TEST (EUT) AND ANCILLARY EQUIPMENT (AE) .....</b>	<b>10</b>
4.1 ABOUT EUT.....	10
4.2 INTERNAL IDENTIFICATION OF EUT USED DURING THE TEST .....	10
4.3 INTERNAL IDENTIFICATION OF AE USED DURING THE TEST .....	11
<b>5 TEST METHODOLOGY .....</b>	<b>12</b>
5.1 APPLICABLE LIMIT REGULATIONS .....	12
5.2 APPLICABLE MEASUREMENT STANDARDS.....	12
<b>6 SPECIFIC ABSORPTION RATE (SAR).....</b>	<b>13</b>
6.1 INTRODUCTION.....	13
6.2 SAR DEFINITION.....	13
<b>7 TISSUE SIMULATING LIQUIDS .....</b>	<b>14</b>
7.1 TARGETS FOR TISSUE SIMULATING LIQUID .....	14
7.2 DIELECTRIC PERFORMANCE .....	15
<b>8 SYSTEM VERIFICATION .....</b>	<b>23</b>
8.1 SYSTEM SETUP.....	23
8.2 SYSTEM VERIFICATION.....	24
<b>9 MEASUREMENT PROCEDURES .....</b>	<b>25</b>
9.1 TESTS TO BE PERFORMED .....	25
9.2 GENERAL MEASUREMENT PROCEDURE.....	27
9.3 WCDMA MEASUREMENT PROCEDURES FOR SAR .....	28
9.4 BLUETOOTH & WI-FI MEASUREMENT PROCEDURES FOR SAR.....	29
9.5 SAR MEASUREMENT FOR LTE.....	29
9.6 LTE (TDD) CONSIDERATIONS.....	30
9.7 POWER DRIFT.....	30
<b>10 AREA SCAN BASED 1-G SAR.....</b>	<b>31</b>
10.1 REQUIREMENT OF KDB.....	31
10.2 FAST SAR ALGORITHMS .....	31
<b>11 CONDUCTED OUTPUT POWER.....</b>	<b>32</b>
11.1 GSM MEASUREMENT RESULT .....	32
11.2 WCDMA MEASUREMENT RESULT.....	34

11.3 LTE MEASUREMENT RESULT .....	35
11.4 WI-FI AND BT MEASUREMENT RESULT .....	53
<b>12 SIMULTANEOUS TX SAR CONSIDERATIONS.....</b>	<b>55</b>
12.1 INTRODUCTION.....	55
12.2 TRANSMIT ANTENNA SEPARATION DISTANCES .....	55
12.3 SAR MEASUREMENT POSITIONS .....	56
12.4 STANDALONE SAR TEST EXCLUSION CONSIDERATIONS .....	56
<b>13 EVALUATION OF SIMULTANEOUS.....</b>	<b>57</b>
<b>14 SAR TEST RESULT .....</b>	<b>58</b>
14.1 SAR RESULTS .....	59
14.2 WLAN EVALUATION FOR 2.4G .....	72
14.3 WLAN EVALUATION FOR 5G .....	74
<b>15 SAR MEASUREMENT VARIABILITY.....</b>	<b>76</b>
<b>16 MEASUREMENT UNCERTAINTY .....</b>	<b>77</b>
16.1 MEASUREMENT UNCERTAINTY FOR NORMAL SAR TESTS (300MHZ~3GHZ) .....	77
16.2 MEASUREMENT UNCERTAINTY FOR FAST SAR TESTS (300MHZ~3GHZ) .....	78
16.3 MEASUREMENT UNCERTAINTY FOR NORMAL SAR TESTS (3GHZ~6GHZ).....	79
16.4 MEASUREMENT UNCERTAINTY FOR FAST SAR TESTS (3GHZ~6GHZ) .....	80
<b>17 MAIN TEST INSTRUMENTS.....</b>	<b>82</b>
<b>ANNEX A GRAPH RESULTS.....</b>	<b>83</b>
<b>ANNEX B SYSTEMVERIFICATION RESULTS .....</b>	<b>113</b>
<b>ANNEX C SAR MEASUREMENT SETUP.....</b>	<b>132</b>
C.1 MEASUREMENT SET-UP .....	132
C.2 DASY5 E-FIELD PROBE SYSTEM.....	133
C.3 E-FIELD PROBE CALIBRATION .....	133
C.4 OTHER TEST EQUIPMENT.....	134
<b>ANNEX D POSITION OF THE WIRELESS DEVICE IN RELATION TO THE PHANTOM .....</b>	<b>138</b>
D.1 GENERAL CONSIDERATIONS .....	138
D.2 BODY-WORN DEVICE .....	139
D.3 DESKTOP DEVICE.....	139
D.4 DUT SETUP PHOTOS.....	140
<b>ANNEX E EQUIVALENT MEDIA RECIPES.....</b>	<b>141</b>
<b>ANNEX F SYSTEM VALIDATION.....</b>	<b>142</b>
<b>ANNEX G DAE CALIBRATION CERTIFICATE.....</b>	<b>143</b>
<b>ANNEX H PROBE CALIBRATION CERTIFICATE.....</b>	<b>146</b>
<b>ANNEX I DIPOLE CALIBRATION CERTIFICATE.....</b>	<b>157</b>
<b>ANNEX J EXTENDED CALIBRATION SAR DIPOLE.....</b>	<b>221</b>

## 1 Test Laboratory

### 1.1 Testing Location

Company Name:	Shenzhen Academy of Information and Communications Technology
Address:	Building G, Shenzhen International Innovation Center, No.1006 Shennan Road, Futian District, Shenzhen, Guangdong, P. R. China
Postal Code:	518026
Telephone:	+86-755-33322000
Fax:	+86-755-33322001

### 1.2 Testing Environment

Temperature:	18°C~25 °C
Relative humidity:	30%~ 70%
Ground system resistance:	<4Ω
Ambient noise & Reflection:	< 0.012 W/kg

### 1.3 Project Data

Testing Start Date:	March 15, 2019
Testing End Date:	April 12, 2019

### 1.4 Signature

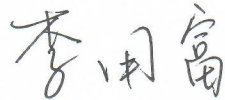

Li Yongfu

(Prepared this test report)



Zhang Yunzhan

(Reviewed this test report)

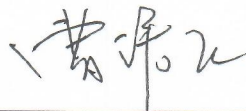

Cao Junfei

Deputy Director of the laboratory

(Approved this test report)

## 2 Statement of Compliance

The maximum results of Specific Absorption Rate (SAR) found during testing for RUGGEAR LIMITED LTE SMARTPHONE RG655 are as follows:

**Table 2.1: Highest Reported SAR for Head (1g)**

Exposure Configuration	Technology Band	Highest Reported SAR 1g(W/Kg)	Equipment Class
Head (Separation Distance 0mm)	GSM850	0.09	PCE
	PCS1900	0.04	
	UMTS FDD 5	0.07	
	UMTS FDD 2	0.07	
	UMTS FDD 4	0.10	
	LTE Band 2	0.07	
	LTE Band 4	0.08	
	LTE Band 5	0.09	
	LTE Band 7	0.22	
	LTE Band 12	0.03	
	LTE Band 17	0.03	
	LTE Band 38	0.13	
	LTE Band 66	0.08	
	WLAN 2.4GHz	<b>1.20</b>	
	WLAN 5GHz	0.70	U-NII-3

**Table 2.2: Highest Reported SAR for Body (1g)**

Exposure Configuration	Technology Band	Highest Reported SAR 1g(W/Kg)	Equipment Class
Body (Separation Distance 10 mm)	GSM850	0.13	PCE
	PCS1900	0.62	
	UMTS FDD 5	0.11	
	UMTS FDD 2	0.74	
	UMTS FDD 4	<b>1.20</b>	
	LTE Band 2	0.85	
	LTE Band 4	1.00	
	LTE Band 5	0.15	
	LTE Band 7	1.04	
	LTE Band 12	0.11	
	LTE Band 17	0.11	
	LTE Band 38	0.50	
	LTE Band 66	1.10	
	WLAN 2.4GHz	0.20	
	WLAN 5GHz	0.24	U-NII-3

The SAR values found for the Mobile Phone are below the maximum recommended levels of 1.6 W/Kg as averaged over any 1g tissue according to the ANSI C95.1-1992.

For body worn operation, this device has been tested and meets FCC RF exposure guidelines when used with any accessory that contains no metal and which provides a minimum separation distance of 10mm between this device and the body of the user. Use of other accessories may not ensure compliance with FCC RF exposure guidelines.

The EUT battery must be fully charged and checked periodically during the test to ascertain uniform power output.

The measurement together with the test system set-up is described in annex C of this test report. A detailed description of the equipment under test can be found in chapter 4 of this test report.

The highest reported SAR value is obtained at the case of **(Table 2.1 & 2.2)**, and the values are: **1.20 W/kg (1g)**.

**Table2.3: The sum of reported SAR values for main antenna and Wi-Fi**

/	Position	Main antenna	Wi-Fi	Sum
Highest reported SAR value for Head	Left Touch	0.22	1.20	1.42
Highest reported SAR value for Body	Rear	1.20	0.24	1.44

**Table2.4: The sum of reported SAR values for main antenna and BT**

/	Position	Main antenna	BT*	Sum
Highest reported SAR value for Head	Left Touch	0.22	0.37	0.59
Highest reported SAR value for Body	Rear	1.20	0.21	1.41

BT\*-Estimated SAR for Bluetooth (seethetable13.3)

According to the above tables, the highest sum of reported SAR values is **1.44 W/kg (1g)**. The detail for simultaneous transmission consideration is described in chapter 13.



### 3 Client Information

#### 3.1 Applicant Information

Company Name:	RUGGEAR LIMITED
Address /Post:	RM1301,13/F WING TUCK COMM CTR 177-183 WING LOK ST SHEUNG WAN HONG KONG
Contact:	alex.ma
Email:	alex.ma@ruggear.cn
Telephone:	+86-0755-86220211
Fax:	/

#### 3.2 Manufacturer Information

Company Name:	RUGGEAR LIMITED
Address /Post:	RM1301,13/F WING TUCK COMM CTR 177-183 WING LOK ST SHEUNG WAN HONG KONG
Contact:	alex.ma
Email:	alex.ma@ruggear.cn
Telephone:	+86-0755-86220211
Fax:	/

## 4 Equipment under Test (EUT) and Ancillary Equipment (AE)

### 4.1 About EUT

Description:	LTE SMARTPHONE
Model Name:	RG655
Condition of EUT as received	No obvious damage in appearance
Operating mode(s):	GSM 850/1900, WCDMA 850/1700/1900, LTE Band 2/4/5/7/12/17/38/66, BT, Wi-Fi 2.4G/5G.
Tested Tx Frequency:	825 – 848.8MHz (GSM 850)
	1850.2 – 1910MHz (GSM 1900)
	826.4 – 846.6MHz (WCDMA850 Band V)
	1712.4 – 1752.6MHz (WCDMA1700 Band IV)
	1852.4 – 1907.6MHz (WCDMA1900 Band II)
	1850.7 – 1909.3MHz (LTE_FDD Band 2)
	1710.7 – 1754.3MHz (LTE_FDD Band 4)
	824.7 – 848.3MHz (LTE_FDD Band 5)
	2502.5 – 2567.5MHz (LTE_FDD Band 7)
	699.7 – 715.3MHz (LTE_FDD Band 12)
	706.5 – 713.5MHz (LTE_FDD Band 17)
	2572.5 – 2617.5MHz (LTE_TDD Band 38)
	1710.7 – 1779.3MHz (LTE_FDD Band 66)
2412 – 2462MHz (Wi-Fi 2.4G)	
5150 – 5825MHz (Wi-Fi 5G)	
GPRS / EGPRS Multislot Class:	12
GPRS capability Class:	B
Test device Production information:	Production unit
Device type:	Portable device
Antenna type:	Integrated antenna
Hotspot mode:	Support

### 4.2 Internal Identification of EUT used during the test

EUT ID*	IMEI	HW Version	SW Version
EUT1	865181040000392	V1.0	RG655_US_1.0.0.0.0_5_20190415
EUT2	865181040000376	V1.0	RG655_US_1.0.0.0.0_5_20190415

\*EUT ID: is used to identify the test sample in the lab internally.

**Note:** It is performed to test SAR with the EUT 1, and conducted power with the EUT 2.

#### 4.3 Internal Identification of AE used during the test

AE ID*	Description	Type	Manufacturer
AE1	Battery	Li-Polymer Battery	SHENZHEN YJC TECHNOLOGY CO. LTD.
AE2	Headset	EJ0009	DONGGUAN ZHANGYUEDIANSHENG CO., LTD

\*AE ID: is used to identify the test sample in the lab internally.

## 5 Test Methodology

### 5.1 Applicable Limit Regulations

**ANSI C95.1–1992:** IEEE Standard for Safety Levels with Respect to Human Exposure to Radio Frequency Electromagnetic Fields, 3 kHz to 300 GHz.

It specifies the maximum exposure limit of **1.6 W/kg** as averaged over any 1 gram of tissue for portable devices being used within 20 cm of the user in the uncontrolled environment.

### 5.2 Applicable Measurement Standards

**IEEE 1528–2013:** Recommended Practice for Determining the Peak Spatial-Average Specific Absorption Rate (SAR) in the Human Head from Wireless Communications Devices: Experimental Techniques.

**KDB 447498 D01 General RF Exposure Guidance v06:** Mobile and Portable Devices RF Exposure Procedures and Equipment Authorization Policies.

**KDB 648474 D04 Handset SAR v01r03:** SAR Evaluation Considerations for Wireless Handsets.

**KDB 941225 D01 SAR test for 3G devices v03r01:** SAR Measurement Procedures for 3G Devices

**KDB 941225 D05 SAR for LTE Devices v02r05:** SAR Evaluation Considerations for LTE Devices

**KDB 941225 D06 Hot Spot SAR v02r01:** SAR Evaluation Procedures for Portable Devices with Wireless Router Capabilities

**KDB 248227 D01 802.11 Wi-Fi SAR v02r02:** SAR Guidance for IEEE 802.11 (Wi-Fi) Transmitters.

**KDB 865664 D01 SAR measurement 100 MHz to 6 GHz v01r04:** SAR Measurement Requirements for 100 MHz to 6 GHz.

**KDB 865664 D02 RF Exposure Reporting v01r02:** RF Exposure Compliance Reporting and Documentation Considerations

## 6 Specific Absorption Rate (SAR)

### 6.1 Introduction

SAR is related to the rate at which energy is absorbed per unit mass in an object exposed to a radio field. The SAR distribution in a biological body is complicated and is usually carried out by experimental techniques or numerical modeling. The standard recommends limits for two tiers of groups, occupational/controlled and general population/uncontrolled, based on a person's awareness and ability to exercise control over his or her exposure. In general, occupational/controlled exposure limits are higher than the limits for general population/uncontrolled.

### 6.2 SAR Definition

The SAR definition is the time derivative (rate) of the incremental energy ( $dW$ ) absorbed by (dissipated in) an incremental mass ( $dm$ ) contained in a volume element ( $dv$ ) of a given density ( $\rho$ ). The equation description is as below:

$$SAR = \frac{d}{dt} \left( \frac{dW}{dm} \right) = \frac{d}{dt} \left( \frac{dW}{\rho dv} \right)$$

SAR is expressed in units of Watts per kilogram (W/kg)

SAR measurement can be either related to the temperature elevation in tissue by

$$SAR = c \left( \frac{\delta T}{\delta t} \right)$$

Where:  $C$  is the specific heat capacity,  $\delta T$  is the temperature rise and  $\delta t$  is the exposure duration, or related to the electrical field in the tissue by

$$SAR = \frac{\sigma |E|^2}{\rho}$$

Where:  $\sigma$  is the conductivity of the tissue,  $\rho$  is the mass density of tissue and  $E$  is the RMS electrical field strength.

However for evaluating SAR of low power transmitter, electrical field measurement is typically applied.

## 7 Tissue Simulating Liquids

### 7.1 Targets for tissue simulating liquid

**Table 7.1: Targets for tissue simulating liquid**

Frequency (MHz)	Liquid Type	Conductivity ( $\sigma$ )	$\pm 5\%$ Range	Permittivity ( $\epsilon$ )	$\pm 5\%$ Range
750	Head	0.89	0.85~0.93	41.94	39.8~44.0
750	Body	0.96	0.91~1.01	55.50	52.7~58.3
835	Head	0.90	0.86~0.95	41.50	39.4~43.6
835	Body	0.97	0.92~1.02	55.20	52.4~58.0
1750	Head	1.37	1.30~1.44	40.08	38.1~42.1
1750	Body	1.49	1.42~1.56	53.40	50.7~56.1
1900	Head	1.40	1.33~1.47	40.00	38.0~42.0
1900	Body	1.52	1.44~1.60	53.30	50.6~56.0
2450	Head	1.80	1.71~1.89	39.20	37.2~41.2
2450	Body	1.95	1.85~2.05	52.70	50.1~55.3
2550	Head	1.91	1.81~2.01	39.07	37.1~41.0
2550	Body	2.09	1.99~2.19	52.60	50.0~55.2
5200	Head	4.66	4.43~4.89	35.99	34.2~37.7
5200	Body	5.30	5.04~5.56	49.00	46.6~51.4
5300	Head	4.76	4.52~5.00	35.87	34.1~37.6
5300	Body	5.42	5.15~5.69	48.90	46.5~51.3
5600	Head	5.07	4.82~5.32	35.53	33.8~37.3
5600	Body	5.77	5.48~6.06	48.50	46.1~50.9
5800	Head	5.27	5.01~5.53	35.30	33.5~37.1
5800	Body	6.00	5.70~6.30	48.20	45.8~50.6

## 7.2 Dielectric Performance

**Table 7.2: Dielectric Performance of Tissue Simulating Liquid**

Measurement Date (yyyy-mm-dd)	Type	Frequency	Conductivity $\sigma$ (S/m)	Drift (%)	Permittivity $\epsilon$	Drift (%)
2019-3-27	Head	750	0.921	3.48	40.96	-2.34
2019-3-27	Body	750	0.973	1.35	53.99	-2.72
2019-3-15	Head	835	0.925	2.78	40.52	-2.36
2019-3-15	Body	835	0.994	2.47	53.78	-2.57
2019-3-30	Head	1750	1.361	-0.66	40.83	1.87
2019-3-30	Body	1750	1.446	-2.95	53.39	-0.02
2019-3-28	Head	1900	1.379	-1.50	40.68	1.70
2019-3-28	Body	1900	1.566	3.03	52.95	-0.66
2019-4-11	Head	2450	1.836	2.00	38.46	-1.89
2019-4-11	Body	2450	1.922	-1.44	53.27	1.08
2019-3-25	Head	2550	1.954	2.30	38.36	-1.82
2019-3-25	Body	2550	2.068	-1.05	53.51	1.73
2019-4-12	Head	5300	4.686	-1.55	36.34	1.31
2019-4-12	Body	5300	5.345	-1.38	49.42	1.06
2019-4-12	Head	5600	5.148	1.54	34.57	-2.70
2019-4-12	Body	5600	5.654	-2.01	49.41	1.88
2019-4-12	Head	5800	5.339	1.31	34.73	-1.61
2019-4-12	Body	5800	5.873	-2.12	49.26	2.20

Note: The liquid temperature is 22.0°C.

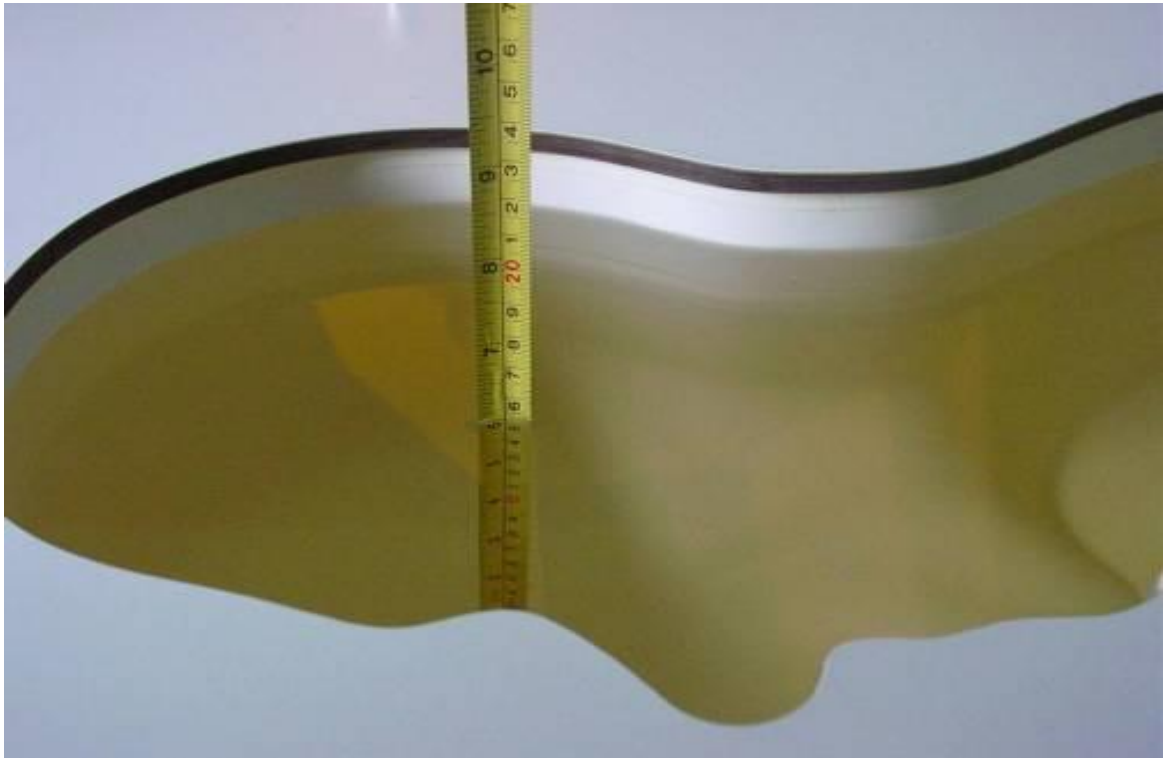

**Picture 7-1: Liquid depth in the Head Phantom (750 MHz)**

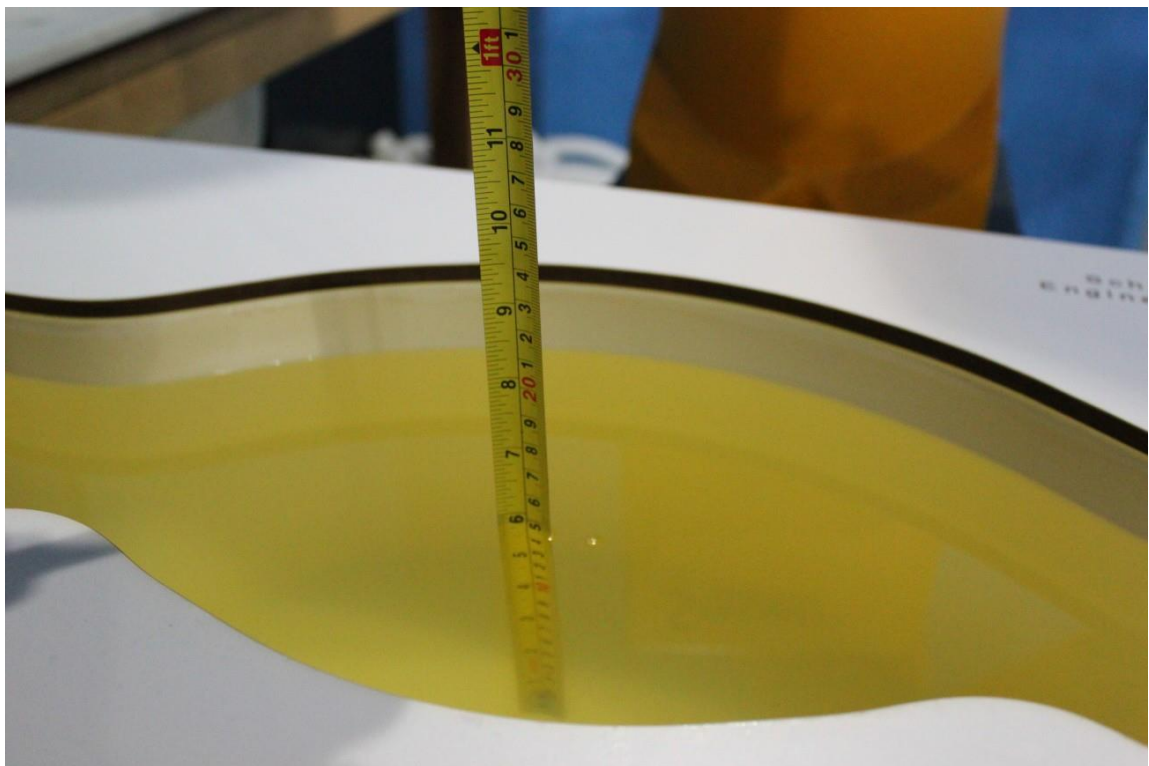

**Picture 7-2: Liquid depth in the Flat Phantom (750 MHz)**



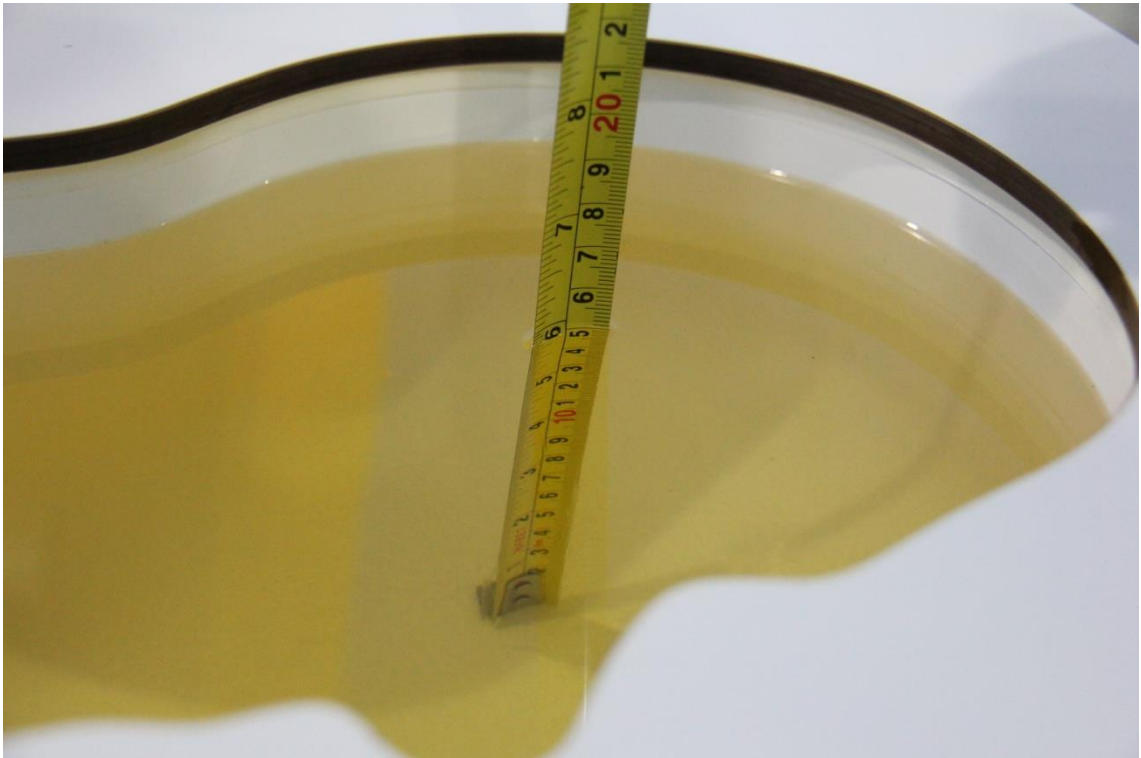

**Picture 7-3: Liquid depth in the Head Phantom (835 MHz)**

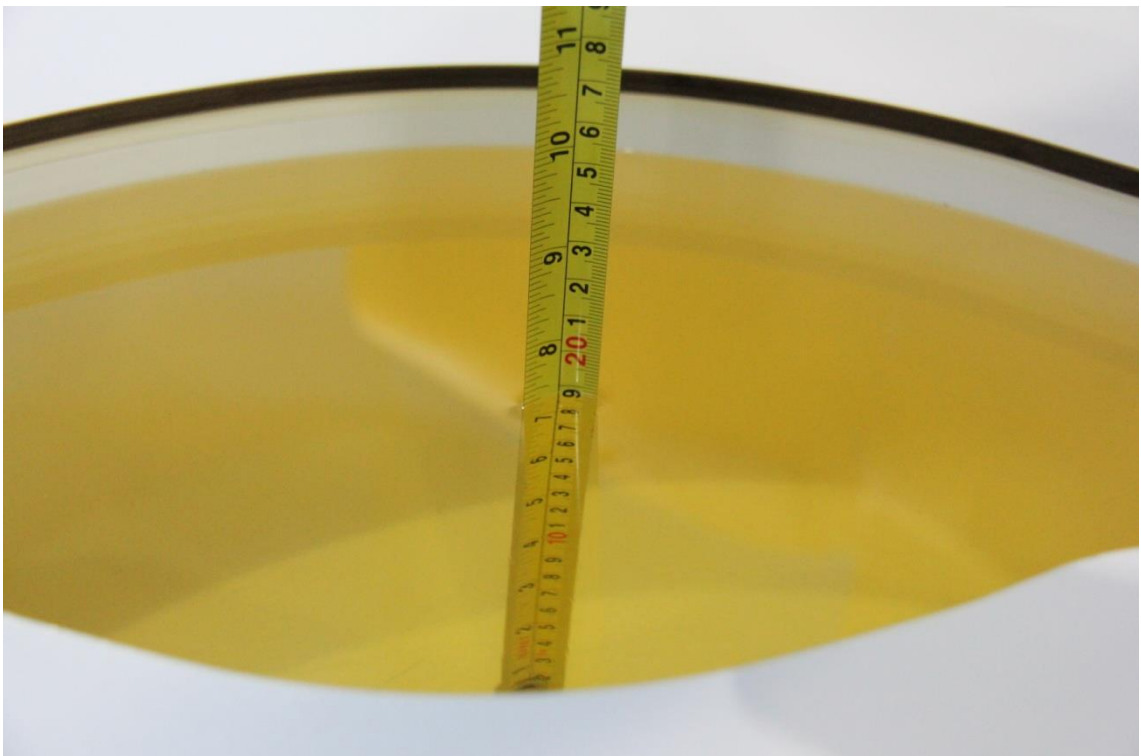

**Picture 7-4: Liquid depth in the Flat Phantom (835 MHz)**

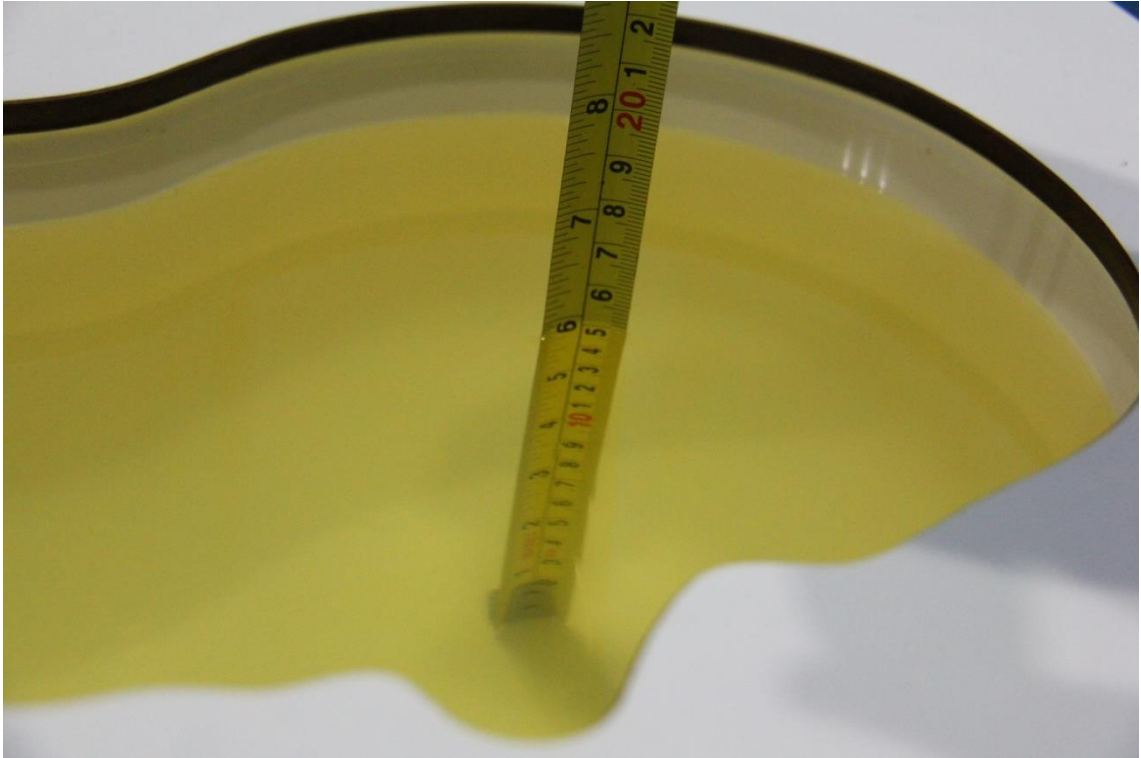

**Picture 7-5: Liquid depth in the Head Phantom (1750 MHz)**

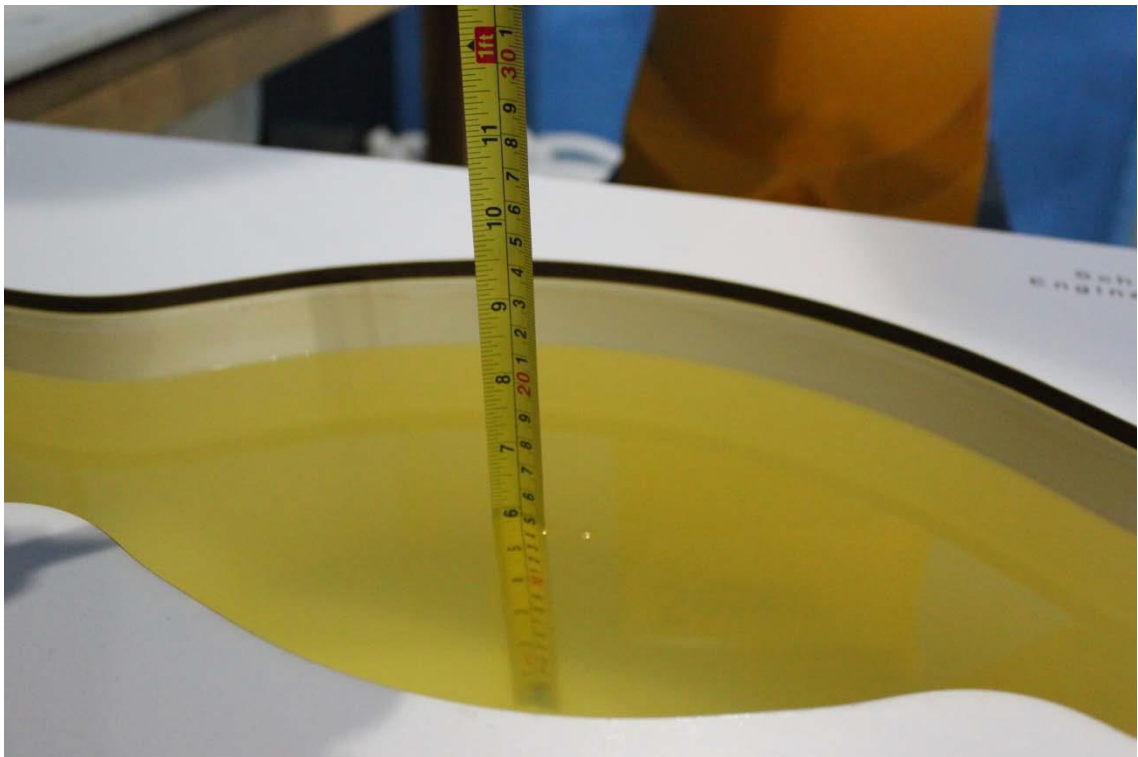

**Picture 7-6: Liquid depth in the Flat Phantom (1750MHz)**



**Picture 7-7: Liquid depth in the Head Phantom (1900 MHz)**

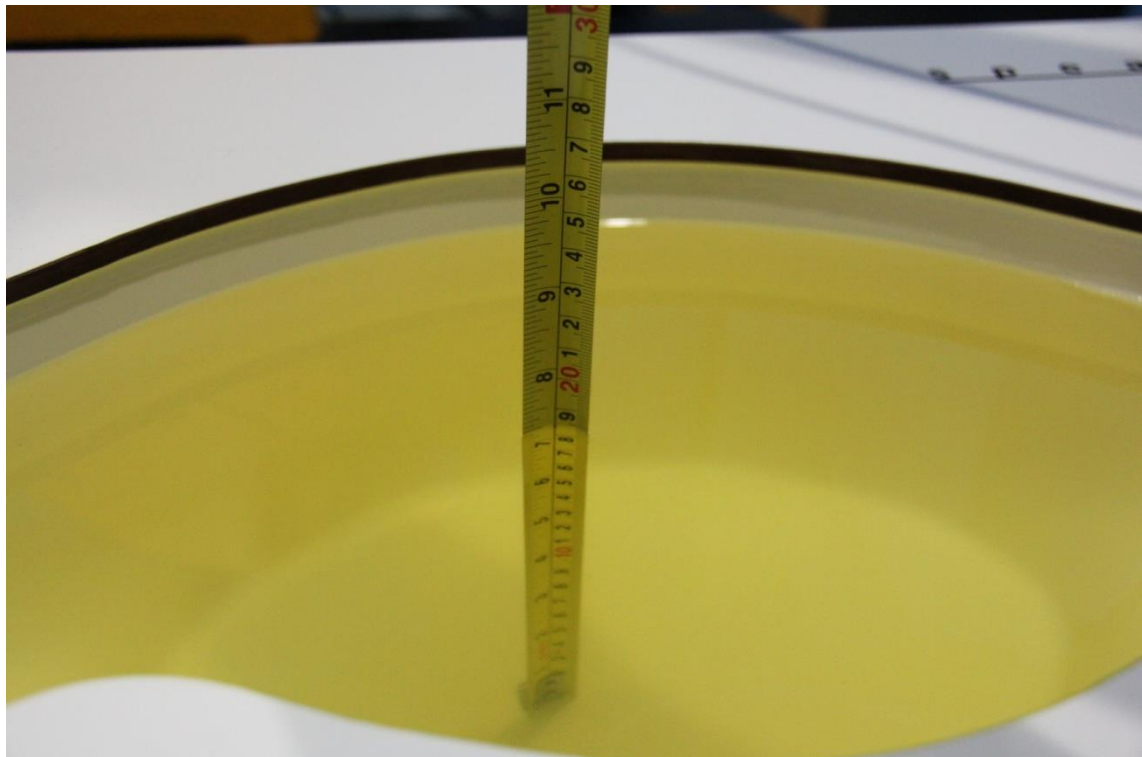

**Picture 7-8: Liquid depth in the Flat Phantom (1900MHz)**



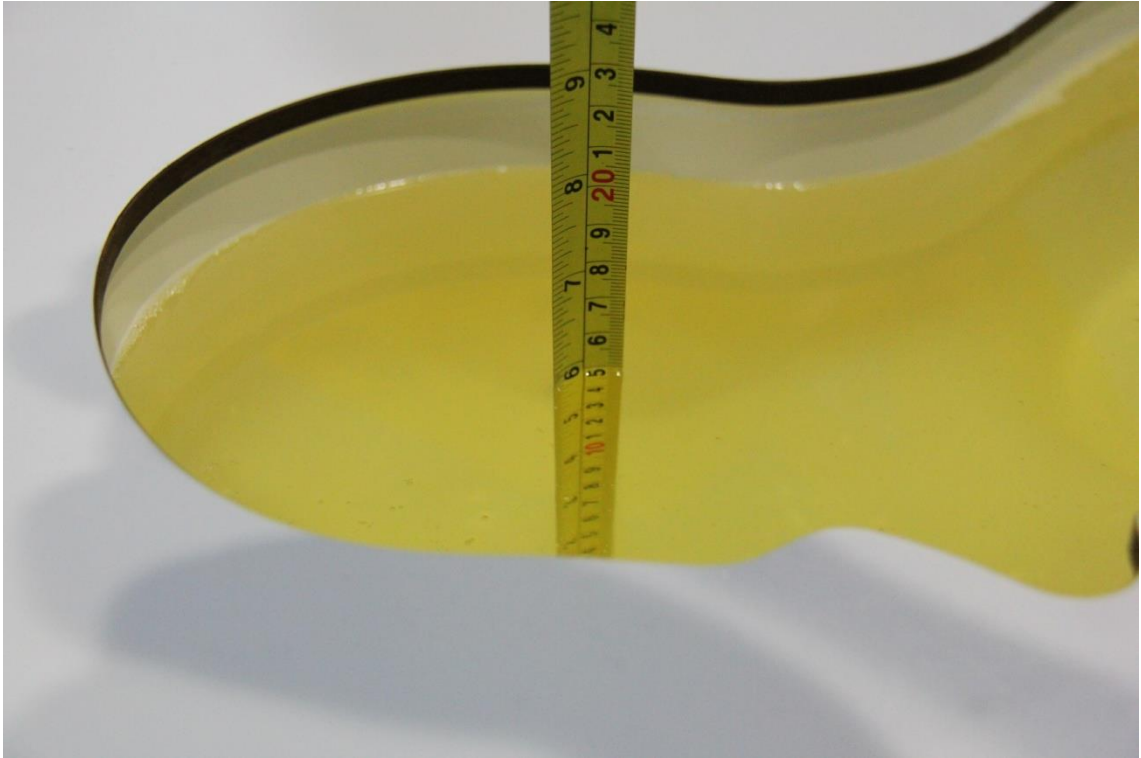

**Picture 7-9: Liquid depth in the Head Phantom(2450MHz)**



**Picture 7-10: Liquid depth in the Flat Phantom(2450MHz)**

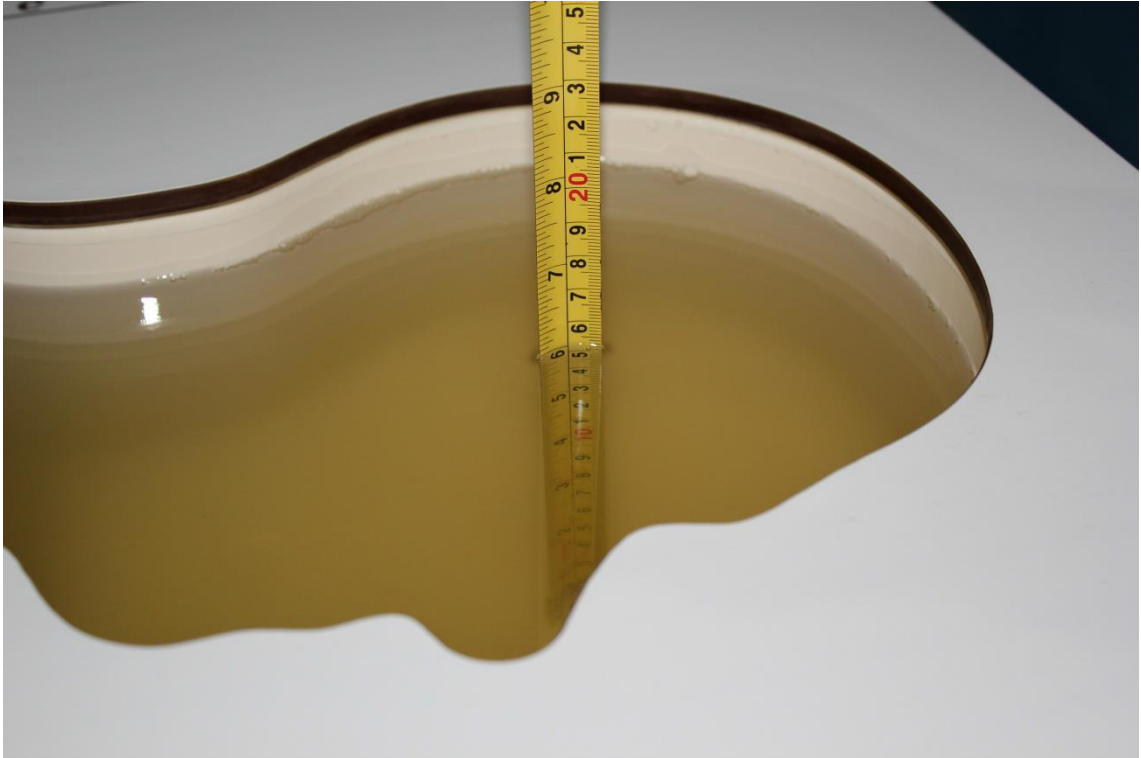

**Picture 7-11: Liquid depth in the Head Phantom(2550MHz)**



**Picture 7-12: Liquid depth in the Flat Phantom(2550MHz)**



**Picture 7-13: Liquid depth in the Head Phantom (5GHz)**



**Picture 7-14: Liquid depth in the Flat Phantom (5GHz)**

## 8 System verification

### 8.1 System Setup

In the simplified setup for system evaluation, the DUT is replaced by a calibrated dipole and the power source is replaced by a continuous wave that comes from a signal generator. The calibrated dipole must be placed beneath the flat phantom section of the SAM twin phantom with the correct distance holder. The distance holder should touch the phantom surface with a light pressure at the reference marking and be oriented parallel to the long side of the phantom. The equipment setup is shown below:

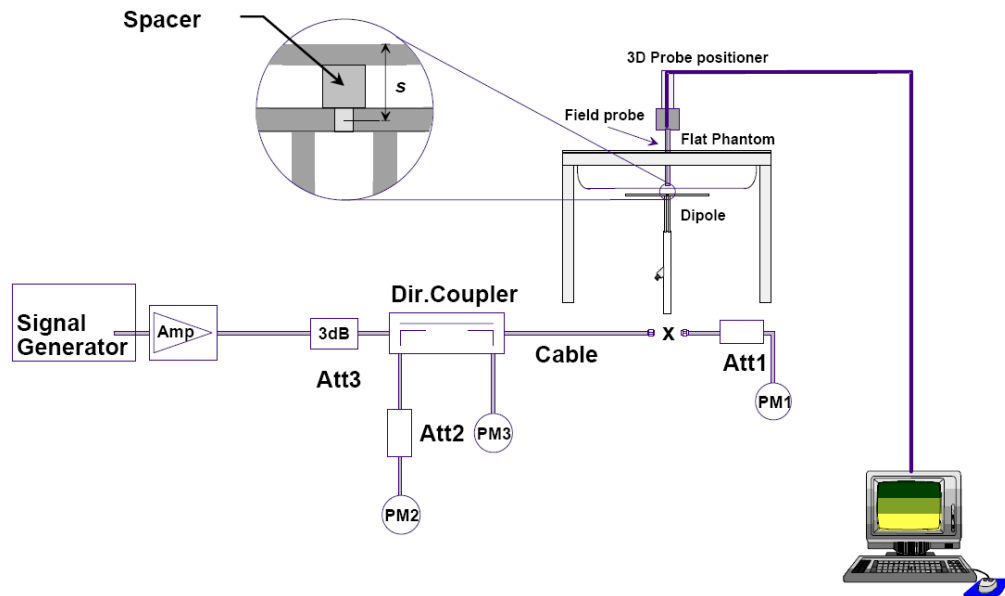

Picture 8.1 System Setup for System Evaluation



Picture 8.2 Photo of Dipole Setup

## 8.2 System Verification

SAR system verification is required to confirm measurement accuracy, according to the tissue dielectric media, probe calibration points and other system operating parameters required for measuring the SAR of a test device. The system verification must be performed for each frequency band and within the valid range of each probe calibration point required for testing the device. The system verification results are required that the area scan estimated 1-g SAR is within 3% of the zoom scan 1-g SAR. The details are presented in annex B.

**Table 8.1: System Verification of Head**

Measurement Date (yyyy-mm-dd)	Frequency	Target value (W/kg)		Measured value (W/kg)		Deviation (%)	
		10 g Average	1 g Average	10 g Average	1 g Average	10 g Average	1 g Average
2019-3-27	750 MHz	5.43	8.26	5.60	8.60	3.13	4.12
2019-3-15	835 MHz	6.29	9.62	6.44	9.96	2.38	3.53
2019-3-30	1750 MHz	19.4	36.6	19.08	35.36	-1.65	-3.39
2019-3-28	1900 MHz	21.0	40.5	20.56	38.76	-2.10	-4.30
2019-4-11	2450 MHz	24.1	52.0	24.72	53.60	2.57	3.08
2019-3-25	2550 MHz	26.5	57.8	27.16	60.40	2.49	4.50
2019-4-12	5300 MHz	23.7	83.0	23.30	80.50	-1.69	-3.01
2019-4-12	5600 MHz	23.6	82.9	23.90	84.70	1.27	2.17
2019-4-12	5800 MHz	22.3	78.8	22.60	81.10	1.35	2.92

**Table 8.2: System Verification of Body**

Measurement Date (yyyy-mm-dd)	Frequency	Target value (W/kg)		Measured value (W/kg)		Deviation (%)	
		10 g Average	1 g Average	10 g Average	1 g Average	10 g Average	1 g Average
2019-3-27	750 MHz	5.64	8.58	5.72	8.84	1.42	3.03
2019-3-15	835 MHz	6.56	9.90	6.64	10.16	1.22	2.63
2019-3-30	1750 MHz	19.5	36.2	18.96	35.00	-2.77	-3.31
2019-3-28	1900 MHz	21.4	40.6	21.84	42.00	2.06	3.45
2019-4-11	2450 MHz	23.5	50.5	23.08	48.80	-1.79	-3.37
2019-3-25	2550 MHz	24.7	54.0	24.32	52.40	-1.54	-2.96
2019-4-12	5300 MHz	21.5	76.5	21.10	73.80	-1.86	-3.53
2019-4-12	5600 MHz	22.1	79.1	21.50	75.90	-2.71	-4.05
2019-4-12	5800 MHz	21.1	76.2	20.80	73.60	-1.42	-3.41



## 9 Measurement Procedures

### 9.1 Tests to be performed

In order to determine the highest value of the peak spatial-average SAR of a handset, all device positions, configurations and operational modes shall be tested for each frequency band according to steps 1 to 3 below. A flowchart of the test process is shown in picture 9.1.

**Step 1:** The tests described in 9.2 shall be performed at the channel that is closest to the center of the transmit frequency band ( $f_c$ ) for:

- a) all device positions (cheek and tilt, for both left and right sides of the SAM phantom, as described in annex D),
- b) all configurations for each device position in a), e.g., antenna extended and retracted, and
- c) all operational modes, e.g., analogue and digital, for each device position in a) and configuration in b) in each frequency band.

If more than three frequencies need to be tested according to 11.1 (i.e.,  $N_c > 3$ ), then all frequencies, configurations and modes shall be tested for all of the above test conditions.

**Step 2:** For the condition providing highest peak spatial-average SAR determined in Step 1, perform all tests described in 9.2 at all other test frequencies, i.e., lowest and highest frequencies. In addition, for all other conditions (device position, configuration and operational mode) where the peak spatial-average SAR value determined in Step 1 is within 3 dB of the applicable SAR limit, it is recommended that all other test frequencies shall be tested as well.

**Step 3:** Examine all data to determine the highest value of the peak spatial-average SAR found in Steps 1 to 2.

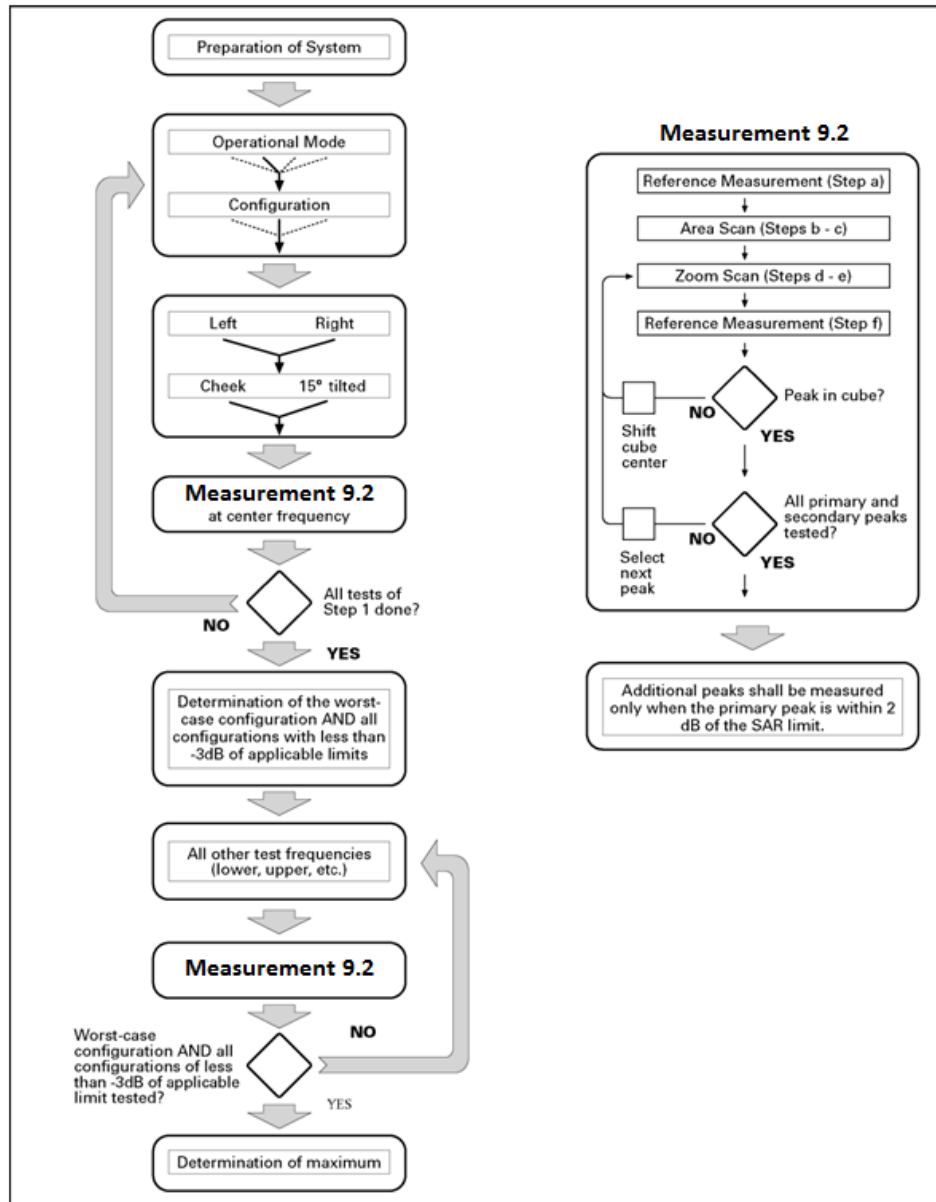

Picture 9.1 Block diagram of the tests to be performed

## 9.2 General Measurement Procedure

The area and zoom scan resolutions specified in the table below must be applied to the SAR measurements and fully documented in SAR reports to qualify for TCB approval. Probe boundary effect error compensation is required for measurements with the probe tip closer than half a probe tip diameter to the phantom surface. Both the probe tip diameter and sensor offset distance must satisfy measurement protocols; to ensure probe boundary effect errors are minimized and the higher fields closest to the phantom surface can be correctly measured and extrapolated to the phantom surface for computing 1-g SAR. Tolerances of the post-processing algorithms must be verified by the test laboratory for the scan resolutions used in the SAR measurements, according to the reference distribution functions specified in IEEE Std 1528-2013. The results should be documented as part of the system validation records and may be requested to support test results when all the measurement parameters in the following table are not satisfied.

		$\leq 3$ GHz	$> 3$ GHz	
Maximum distance from closest measurement point (geometric center of probe sensors) to phantom surface		$5 \pm 1$ mm	$\frac{1}{2} \cdot \delta \cdot \ln(2) \pm 0.5$ mm	
Maximum probe angle from probe axis to phantom surface normal at the measurement location		$30^\circ \pm 1^\circ$	$20^\circ \pm 1^\circ$	
Maximum area scan spatial resolution: $\Delta x_{Area}, \Delta y_{Area}$		$\leq 2$ GHz: $\leq 15$ mm 2 – 3 GHz: $\leq 12$ mm	3 – 4 GHz: $\leq 12$ mm 4 – 6 GHz: $\leq 10$ mm	
		When the x or y dimension of the test device, in the measurement plane orientation, is smaller than the above, the measurement resolution must be $\leq$ the corresponding x or y dimension of the test device with at least one measurement point on the test device.		
Maximum zoom scan spatial resolution: $\Delta x_{Zoom}, \Delta y_{Zoom}$		$\leq 2$ GHz: $\leq 8$ mm 2 – 3 GHz: $\leq 5$ mm*	3 – 4 GHz: $\leq 5$ mm* 4 – 6 GHz: $\leq 4$ mm*	
Maximum zoom scan spatial resolution, normal to phantom surface	uniform grid: $\Delta z_{Zoom}(n)$	$\leq 5$ mm	3 – 4 GHz: $\leq 4$ mm 4 – 5 GHz: $\leq 3$ mm 5 – 6 GHz: $\leq 2$ mm	
	graded grid	$\Delta z_{Zoom}(1)$ : between 1 <sup>st</sup> two points closest to phantom surface	$\leq 4$ mm	3 – 4 GHz: $\leq 3$ mm 4 – 5 GHz: $\leq 2.5$ mm 5 – 6 GHz: $\leq 2$ mm
		$\Delta z_{Zoom}(n>1)$ : between subsequent points	$\leq 1.5 \cdot \Delta z_{Zoom}(n-1)$	
Minimum zoom scan volume	x, y, z	$\geq 30$ mm	3 – 4 GHz: $\geq 28$ mm 4 – 5 GHz: $\geq 25$ mm 5 – 6 GHz: $\geq 22$ mm	
<p>Note: <math>\delta</math> is the penetration depth of a plane-wave at normal incidence to the tissue medium; see draft standard IEEE P1528-2011 for details.</p> <p>* When zoom scan is required and the reported SAR from the area scan based 1-g SAR estimation procedures of KDB 447498 is <math>\leq 1.4</math> W/kg, <math>\leq 8</math> mm, <math>\leq 7</math> mm and <math>\leq 5</math> mm zoom scan resolution may be applied, respectively, for 2 GHz to 3 GHz, 3 GHz to 4 GHz and 4 GHz to 6 GHz.</p>				

### 9.3 WCDMA Measurement Procedures for SAR

The following procedures are applicable to WCDMA handsets operating under 3GPP Release99, Release 5 and Release 6. The default test configuration is to measure SAR with an established radio link between the DUT and a communication test set using a 12.2kbps RMC (reference measurement channel) configured in Test Loop Mode 1. SAR is selectively confirmed for other physical channel configurations (DPCCH & DPDCH<sub>n</sub>), HSDPA and HSPA (HSUPA/HSDPA) modes according to output power, exposure conditions and device operating capabilities. Both uplink and downlink should be configured with the same RMC or AMR, when required. SAR for Release 5 HSDPA and Release 6 HSPA are measured using the applicable FRC (fixed reference channel) and E-DCH reference channel configurations. Maximum output power is verified according to applicable versions of 3GPP TS 34.121 and SAR must be measured according to these maximum output conditions. When Maximum Power Reduction (MPR) is not implemented according to Cubic Metric (CM) requirements for Release 6 HSPA, the following procedures do not apply.

#### For Release 5 HSDPA Data Devices:

Sub-test	$\beta_c$	$\beta_d$	$\beta_d$ (SF)	$\beta_c / \beta_d$	$\beta_{hs}$	CM/dB
1	2/15	15/15	64	2/15	4/15	0.0
2	12/15	15/15	64	12/15	24/25	1.0
3	15/15	8/15	64	15/8	30/15	1.5
4	15/15	4/15	64	15/4	30/15	1.5

#### For Release 6 HSPA Data Devices

Sub-test	$\beta_c$	$\beta_d$	$\beta_d$ (SF)	$\beta_c / \beta_d$	$\beta_{hs}$	$\beta_{ec}$	$\beta_{ed}$	$\beta_{ed}$ (SF)	$\beta_{ed}$ (codes)	CM (dB)	MPR (dB)	AG Index	E-TFCI
1	11/15	15/15	64	11/15	22/15	209/225	1039/225	4	1	1.0	0.0	20	75
2	6/15	15/15	64	6/15	12/15	12/15	12/15	4	1	3.0	2.0	12	67
3	15/15	9/15	64	15/9	30/15	30/15	$\beta_{ed1}:47/1$ 5 $\beta_{ed2}:47/15$	4	2	2.0	1.0	15	92
4	2/15	15/15	64	2/15	4/15	4/15	56/75	4	1	3.0	2.0	17	71
5	15/15	15/15	64	15/15	24/15	30/15	134/15	4	1	1.0	0.0	21	81

## 9.4 Bluetooth & WI-FI Measurement Procedures for SAR

Normal network operating configurations are not suitable for measuring the SAR of 802.11 transmitters in general. Unpredictable fluctuations in network traffic and antenna diversity conditions can introduce undesirable variations in SAR results. The SAR for these devices should be measured using chipset based test mode software to ensure that the results are consistent and reliable.

Chipset based test mode software is hardware dependent and generally varies among manufacturers. The device operating parameters established in a test mode for SAR measurements must be identical to those programmed in production units, including output power levels, amplifier gain settings and other RF performance tuning parameters. The test frequencies should correspond to actual channel frequencies defined for domestic use. SAR for devices with switched diversity should be measured with only one antenna transmitting at a time during each SAR measurement, according to a fixed modulation and data rate. The same data pattern should be used for all measurements.

## 9.5 SAR Measurement for LTE

SAR tests for LTE are performed with a base station simulator, Anristu MT8820C. Closed loop power control was used so the UE transmits with maximum output power during SAR testing. All powers were measured with the Anristu MT8820C. It is performed for conducted power and SAR based on the KDB941225 D05.

SAR is evaluated separately according to the following procedures for the different test positions in each exposure condition – head, body, body-worn accessories and other use conditions. The procedures in the following subsections are applied separately to test each LTE frequency band.

### 1) QPSK with 1 RB allocation

Start with the largest channel bandwidth and measure SAR for QPSK with 1 RB allocation, using the RB offset and required test channel combination with the highest maximum output power among RB offsets at the upper edge, middle and lower edge of each required test channel. When the reported SAR is  $\leq 0.8$  W/kg, testing of the remaining RB offset configurations and required test channels is not required for 1 RB allocation; otherwise, SAR is required for the remaining required test channels and only for the RB offset configuration with the highest output power for that channel. When the reported SAR of a required test channel is  $> 1.45$  W/kg, SAR is required for all three RB offset configurations for that required test channel.

### 2) QPSK with 50% RB allocation

The procedures required for 1 RB allocation in 1) are applied to measure the SAR for QPSK with 50% RB allocation.

### 3) QPSK with 100% RB allocation

For QPSK with 100% RB allocation, SAR is not required when the highest maximum output power for 100 % RB allocation is less than the highest maximum output power in 50% and 1 RB allocations and the highest reported SAR for 1 RB and 50% RB allocation in 1) and 2) are  $\leq 0.8$  W/kg. Otherwise, SAR is measured for the highest output power channel; and if the reported SAR is  $> 1.45$  W/kg, the remaining required test channels must also be tested.

### 9.6 LTE (TDD) Considerations

According to KDB 941225 D05 SAR for LTE Devices, for Time-Division Duplex (TDD) systems, SAR must be tested using a fixed periodic duty factor according to the highest transmission duty factor implemented for the device and supported by the defined 3GPP LTE TDD configurations.

SAR was tested with the highest transmission duty factor (63.33%) using Uplink-downlink configuration 0 and Special subframe configuration 7.

LTE TDD Band 38 support 3GPP TS 36.211 section 4.2 for Type 2 Frame Structure and Table 4.2-2 for uplink-downlink configurations and Table 4.2-1 for Special subframe configurations.

Special subframe configuration	Normal cyclic prefix in downlink			Extended cyclic prefix in downlink		
	DwPTS	UpPTS		DwPTS	UpPTS	
		Normal cyclic prefix in uplink	Extended cyclic prefix in uplink		Normal cyclic prefix in uplink	Extended cyclic prefix in uplink
0	$6592 \cdot T_s$	$2192 \cdot T_s$	$2560 \cdot T_s$	$7680 \cdot T_s$	$2192 \cdot T_s$	$2560 \cdot T_s$
1	$19760 \cdot T_s$			$20480 \cdot T_s$		
2	$21952 \cdot T_s$			$23040 \cdot T_s$		
3	$24144 \cdot T_s$			$25600 \cdot T_s$		
4	$26336 \cdot T_s$			$7680 \cdot T_s$		
5	$6592 \cdot T_s$	$4384 \cdot T_s$	$5120 \cdot T_s$	$20480 \cdot T_s$	$4384 \cdot T_s$	$5120 \cdot T_s$
6	$19760 \cdot T_s$			$23040 \cdot T_s$		
7	$21952 \cdot T_s$			$12800 \cdot T_s$		
8	$24144 \cdot T_s$			-		
9	$13168 \cdot T_s$			-		

Configuration of special subframe (lengths of DwPTS/GP/UpPTS)

Uplink-Downlink Configuration	Downlink-to-Uplink Switch-point Periodicity	Subframe Number										Calculated Duty Cycle (%)
		0	1	2	3	4	5	6	7	8	9	
0	5 ms	D	S	U	U	U	D	S	U	U	U	63.33
1	5 ms	D	S	U	U	D	D	S	U	U	D	43.33
2	5 ms	D	S	U	D	D	D	S	U	D	D	23.33
3	10 ms	D	S	U	U	U	D	D	D	D	D	31.67
4	10 ms	D	S	U	U	D	D	D	D	D	D	21.67
5	10 ms	D	S	U	D	D	D	D	D	D	D	11.67
6	5 ms	D	S	U	U	U	D	S	U	U	D	53.33

Calculated Duty Cycle

Calculated Duty Cycle = Extended cyclic prefix in uplink x (Ts) x # of S + # of U

Example for Calculated Duty Cycle for Uplink-Downlink Configuration 0:

Calculated Duty Cycle =  $5120 \times [1/(15000 \times 2048)] \times 2 + 6 \text{ ms} = 63.33\%$

Where

$T_s = 1/(15000 \times 2048)$  seconds

### 9.7 Power Drift

To control the output power stability during the SAR test, DASY5 system calculates the power drift by measuring the E-field at the same location at the beginning and at the end of the measurement for each test position. These drift values can be found in Section 14 labeled as: (Power Drift [dB]). This ensures that the power drift during one measurement is within 5%.

## 10 Area Scan Based 1-g SAR

### 10.1 Requirement of KDB

According to the KDB447498 D01, when the implementation is based the specific polynomial fit algorithm as presented at the 29th Bioelectromagnetics Society meeting (2007) and the estimated 1-gSAR is  $\leq 1.2$  W/kg, a zoom scan measurement is not required provided it is also not needed for any other purpose; for example, if the peak SAR location required for simultaneous transmission SAR test exclusion can be determined accurately by the SAR system or manually to discriminate between distinctive peaks and scattered noisy SAR distributions from area scans.

There must not be any warning or alert messages due to various measurement concerns identified by the SAR system; for example, noise in measurements, peaks too close to scan boundary, peaks are too sharp, spatial resolution and uncertainty issues etc. The SAR system verification must also demonstrate that the area scan estimated 1-g SAR is within 3% of the zoom scan 1-g SAR (See Annex B). When all the SAR results for each exposure condition in a frequency band and wireless mode are based on estimated 1-g SAR, the 1-g SAR for the highest SAR configuration must be determined by a zoom scan.

### 10.2 Fast SAR Algorithms

The approach is based on the area scan measurement applying a frequency dependent attenuation parameter. This attenuation parameter was empirically determined by analyzing a large number of phones. The MOTOROLA FAST SAR was developed and validated by the MOTOROLA Research Group in Ft. Lauderdale.

In the initial study, an approximation algorithm based on Linear fit was developed. The accuracy of the algorithm has been demonstrated across a broad frequency range (136-2450 MHz) and for both 1- and 10-g averaged SAR using a sample of 264 SAR measurements from 55 wireless handsets. For the sample size studied, the root-mean-squared errors of the algorithm are 1.2% and 5.8% for 1- and 10-g averaged SAR, respectively. The paper describing the algorithm in detail is expected to be published in August 2004 within the Special Issue of Transactions on MTT.

In the second step, the same research group optimized the fitting algorithm to an Polynomial fit whereby the frequency validity was extended to cover the range 30-6000MHz. Details of this study can be found in the BEMS 2007 Proceedings.

Both algorithms are implemented in DASY software.



## 11 Conducted Output Power

### 11.1 GSM Measurement result

During the process of testing, the EUT was controlled via Agilent Digital Radio Communication tester (E5515C) to ensure the maximum power transmission and proper modulation. This result contains conducted output power for the EUT. In all cases, the measured peak output power should be greater and within 5% than EMI measurement.

**Table 11.1: The conducted power measurement results for GSM**

GSM 850MHz	Tune up 34	Conducted Power (dBm)		
		Channel 251(848.8MHz)	Channel 190(836.6MHz)	Channel 128(824.2MHz)
		32.91	32.88	32.79
GSM 1900MHz	Tune up 31	Conducted Power(dBm)		
		Channel 810(1909.8MHz)	Channel 661(1880MHz)	Channel 512(1850.2MHz)
		30.15	30.12	29.87

**Table 11.2: The conducted power measurement results for GPRS and EGPRS**

GPRS 850	Tune up	Measured Power (dBm)			calculation	Average Power (dBm)		
		251	190	128		251	190	128
1Tx-slots	34	32.89	32.87	32.68	-9.03dB	23.86	23.84	23.65
2Tx-slots	33	<b>32.05</b>	<b>32.04</b>	<b>31.88</b>	-6.02dB	<b>26.03</b>	<b>26.02</b>	<b>25.86</b>
3Tx-slots	31	30.18	30.13	29.95	-4.26dB	25.92	25.87	25.69
4Tx-slots	30	28.93	28.93	28.77	-3.01dB	25.92	25.92	25.76
EGPRS 850 (8PSK)	Tune up	Measured Power (dBm)			calculation	Measured Power (dBm)		
		251	190	128		251	190	128
1Tx-slots	27	26.50	26.24	26.10	-9.03dB	17.47	17.21	17.07
2Tx-slots	26	25.45	25.22	25.12	-6.02dB	19.43	19.20	19.10
3Tx-slots	24	23.33	23.11	22.89	-4.26dB	19.07	18.85	18.63
4Tx-slots	23	22.06	21.82	21.83	-3.01dB	19.05	18.81	18.82



GPRS 1900	Tune up	Measured Power (dBm)			calculation	Average Power (dBm)		
		810	661	512		810	661	512
1Tx-slots	<b>31</b>	30.11	30.09	29.85	<b>-9.03dB</b>	21.08	21.06	20.82
2Tx-slots	<b>30</b>	29.35	29.34	29.10	<b>-6.02dB</b>	23.33	23.32	23.08
3Tx-slots	<b>28</b>	27.61	27.55	27.31	<b>-4.26dB</b>	23.35	23.29	23.05
4Tx-slots	<b>27</b>	<b>26.50</b>	<b>26.47</b>	<b>26.23</b>	<b>-3.01dB</b>	<b>23.49</b>	<b>23.46</b>	<b>23.22</b>
EGPRS 1900 (8PSK)	Tune up	Measured Power (dBm)			calculation	Measured Power (dBm)		
		810	661	512		810	661	512
1Tx-slots	<b>27</b>	26.17	26.44	26.38	<b>-9.03dB</b>	17.14	17.41	17.35
2Tx-slots	<b>26</b>	25.30	25.49	25.40	<b>-6.02dB</b>	19.28	19.47	19.38
3Tx-slots	<b>24</b>	23.27	23.38	23.28	<b>-4.26dB</b>	19.01	19.12	19.02
4Tx-slots	<b>23</b>	21.99	22.21	22.09	<b>-3.01dB</b>	18.98	19.2	19.08

NOTES:

1) Division Factors

To average the power, the division factor is as follows:

1TX-slot = 1 transmit time slot out of 8 time slots=> conducted power divided by (8/1) => -9.03dB

2TX-slots = 2 transmit time slots out of 8 time slots=> conducted power divided by (8/2) => -6.02dB

3TX-slots = 3 transmit time slots out of 8 time slots=> conducted power divided by (8/3) => -4.26dB

4TX-slots = 4 transmit time slots out of 8 time slots=> conducted power divided by (8/4) => -3.01dB

**According to the conducted power as above, the body measurements are performed with 2Txslots for 850MHz and 4Txslots for 1900MHz.**

## 11.2 WCDMA Measurement result

**Table 11.3: The conducted Power for WCDMA**

Item	band	FDD Band 5 result			
	ARFCN	Tune up	4233 (846.6MHz)	4182 (836.4MHz)	4132 (826.4MHz)
WCDMA	\	24	23.7	23.8	23.6
HSUPA	1	22	21.5	21.2	21.2
	2	21	20.7	20.7	20.6
	3	23	21.7	21.7	21.7
	4	21	20.2	20.2	20.2
	5	23	21.8	21.8	21.6
HSDPA	1	23	22.8	22.8	22.7
	2	23	22.7	22.7	22.7
	3	23	22.3	22.2	22.2
	4	23	22.3	22.2	22.2
Item	band	FDD Band 2 result			
	ARFCN	Tune up	9538 (1907.6MHz)	9400 (1880MHz)	9262 (1852.4MHz)
WCDMA	\	24	23.8	23.7	23.5
HSUPA	1	22	21.4	21.3	21.0
	2	21	20.8	20.8	20.5
	3	23	21.9	21.8	21.5
	4	21	20.4	20.3	20.1
	5	23	21.8	21.7	21.6
HSDPA	1	23	22.8	22.7	22.5
	2	23	22.8	22.7	22.5
	3	23	22.3	22.3	22.1
	4	23	22.3	22.2	22.1
Item	band	FDD Band 4 result			
	ARFCN	Tune up	1513 (1752.6MHz)	1413 (1732.6MHz)	1312 (1712.4MHz)
WCDMA	\	24	23.6	23.7	23.8
HSUPA	1	22	21.2	21.2	21.4
	2	21	20.7	20.7	20.8
	3	23	21.7	21.7	21.8
	4	21	20.2	20.2	20.4
	5	23	21.7	21.7	21.9
HSDPA	1	23	22.7	22.7	22.9
	2	23	22.7	22.7	22.8
	3	23	22.1	22.2	22.4
	4	23	22.2	22.2	22.3

**11.3 LTE Measurement result**

**Table 11.4: The conducted Power for LTE**

LTE-FDD Band 2				Actual output Power (dBm)			Tune up
Band-width	RB allocation	RB offset	Modulation	High	Middle	Low	
1.4 MHz				1909.3MHz	1880MHz	1850.7MHz	
	1RB	High	QPSK	23.56	22.98	22.91	<b>24</b>
			16QAM	22.14	22.18	22.17	<b>23</b>
		Middle	QPSK	23.67	23.11	23.07	<b>24</b>
			16QAM	22.24	22.27	22.27	<b>23</b>
		Low	QPSK	23.13	22.99	22.96	<b>24</b>
			16QAM	22.14	22.19	22.22	<b>23</b>
	3RB	High	QPSK	23.22	23.07	23.01	<b>24</b>
			16QAM	22.05	22.00	21.96	<b>23</b>
		Middle	QPSK	23.27	23.16	23.10	<b>24</b>
			16QAM	22.08	22.06	22.06	<b>23</b>
		Low	QPSK	23.21	23.09	23.04	<b>24</b>
			16QAM	22.04	22.01	22.00	<b>23</b>
	6RB	/	QPSK	22.25	22.12	22.05	<b>23</b>
16QAM			21.24	21.16	21.10	<b>22</b>	
3 MHz				1908.5MHz	1880MHz	1851.5MHz	/
	1RB	High	QPSK	23.58	23.04	22.97	<b>24</b>
			16QAM	22.19	22.21	22.22	<b>23</b>
		Middle	QPSK	23.76	23.23	23.11	<b>24</b>
			16QAM	22.39	22.37	22.35	<b>23</b>
		Low	QPSK	23.56	23.04	23.02	<b>24</b>
			16QAM	22.27	22.22	22.25	<b>23</b>
	8RB	High	QPSK	22.55	22.07	22.01	<b>23</b>
			16QAM	21.17	21.13	21.10	<b>22</b>
		Middle	QPSK	22.30	22.09	22.04	<b>23</b>
			16QAM	21.20	21.14	21.12	<b>22</b>
		Low	QPSK	22.20	22.06	22.01	<b>23</b>
			16QAM	21.22	21.11	21.09	<b>22</b>
	15RB	/	QPSK	22.22	22.11	22.04	<b>23</b>
16QAM			21.17	21.09	21.04	<b>22</b>	

LTE-FDD Band 2				Actual output Power (dBm)			Tune up
Band-width	RB allocation	RB offset	Modulation	High	Middle	Low	
5 MHz				1907.5MHz	1880MHz	1852.5MHz	
	1RB	High	QPSK	23.47	22.91	22.96	<b>24</b>
			16QAM	22.08	22.18	22.04	<b>23</b>
		Middle	QPSK	23.80	23.17	23.25	<b>24</b>
			16QAM	22.39	22.43	22.36	<b>23</b>
		Low	QPSK	23.50	22.93	22.93	<b>24</b>
			16QAM	22.19	22.16	22.15	<b>23</b>
	12RB	High	QPSK	22.66	22.06	21.99	<b>23</b>
			16QAM	21.07	21.04	20.98	<b>22</b>
		Middle	QPSK	22.76	22.13	22.12	<b>23</b>
			16QAM	21.20	21.11	21.07	<b>22</b>
		Low	QPSK	22.71	22.08	22.23	<b>23</b>
			16QAM	21.16	21.04	21.20	<b>22</b>
	25RB	/	QPSK	22.69	22.11	22.12	<b>23</b>
16QAM			21.17	21.08	21.15	<b>22</b>	
10 MHz				1905MHz	1880MHz	1855MHz	/
	1RB	High	QPSK	23.62	23.49	23.36	<b>24</b>
			16QAM	22.19	22.31	22.23	<b>23</b>
		Middle	QPSK	23.71	23.62	23.46	<b>24</b>
			16QAM	22.44	22.35	22.41	<b>23</b>
		Low	QPSK	23.63	23.50	23.31	<b>24</b>
			16QAM	22.29	22.22	22.30	<b>23</b>
	25RB	High	QPSK	22.75	22.67	22.41	<b>23</b>
			16QAM	21.20	21.23	21.12	<b>22</b>
		Middle	QPSK	22.80	22.68	22.54	<b>23</b>
			16QAM	21.22	21.30	21.15	<b>22</b>
		Low	QPSK	22.88	22.71	22.48	<b>23</b>
			16QAM	21.39	21.34	21.23	<b>22</b>
	50RB	/	QPSK	22.79	22.70	22.46	<b>23</b>
16QAM			21.27	21.22	21.23	<b>22</b>	

LTE-FDD Band 2				Actual output Power (dBm)			Tune up
Band-width	RB allocation	RB offset	Modulation	High	Middle	Low	
15 MHz				1902.5MHz	1880MHz	1857.5MHz	
	1RB	High	QPSK	23.48	23.35	23.29	<b>24</b>
			16QAM	22.59	22.62	22.50	<b>23</b>
		Middle	QPSK	23.65	23.56	23.49	<b>24</b>
			16QAM	22.73	22.72	22.71	<b>23</b>
		Low	QPSK	23.51	23.39	23.44	<b>24</b>
			16QAM	22.71	22.54	22.70	<b>23</b>
	36RB	High	QPSK	22.72	22.64	22.56	<b>23</b>
			16QAM	21.62	21.59	21.48	<b>22</b>
		Middle	QPSK	22.80	22.68	22.59	<b>23</b>
			16QAM	21.71	21.63	21.54	<b>22</b>
		Low	QPSK	22.76	22.68	22.59	<b>23</b>
			16QAM	21.66	21.60	21.53	<b>22</b>
	75RB	/	QPSK	22.77	22.68	22.56	<b>23</b>
16QAM			21.67	21.59	21.52	<b>22</b>	
20 MHz				1900MHz	1880MHz	1860MHz	/
	1RB	High	QPSK	23.25	23.24	23.20	<b>24</b>
			16QAM	22.41	22.46	22.32	<b>23</b>
		Middle	QPSK	<b>23.71</b>	<b>23.74</b>	<b>23.64</b>	<b>24</b>
			16QAM	22.86	22.90	22.86	<b>23</b>
		Low	QPSK	23.35	23.30	23.32	<b>24</b>
			16QAM	22.59	22.45	22.58	<b>23</b>
	50RB	High	QPSK	22.64	22.69	22.64	<b>23</b>
			16QAM	21.55	21.65	21.60	<b>22</b>
		Middle	QPSK	<b>22.81</b>	<b>22.79</b>	<b>22.72</b>	<b>23</b>
			16QAM	21.72	21.73	21.65	<b>22</b>
		Low	QPSK	22.77	22.79	22.61	<b>23</b>
			16QAM	21.72	21.71	21.55	<b>22</b>
	100RB	/	QPSK	22.72	22.75	22.63	<b>23</b>
16QAM			21.63	21.67	21.58	<b>22</b>	

LTE-FDD Band 4				Actual output Power (dBm)			Tune up
Band-width	RB allocation	RB offset	Modulation	High	Middle	Low	
1.4 MHz				1754.3MHz	1732.5MHz	1710.7MHz	
	1RB	High	QPSK	22.94	22.95	22.88	<b>23.5</b>
			16QAM	22.11	22.26	22.06	<b>22.5</b>
		Middle	QPSK	23.06	23.10	23.00	<b>23.5</b>
			16QAM	22.22	22.37	22.18	<b>22.5</b>
		Low	QPSK	22.94	22.96	22.87	<b>23.5</b>
			16QAM	22.06	22.27	22.06	<b>22.5</b>
	3RB	High	QPSK	23.05	23.05	22.98	<b>23.5</b>
			16QAM	21.95	22.03	21.90	<b>22.5</b>
		Middle	QPSK	23.12	23.09	23.03	<b>23.5</b>
			16QAM	22.01	22.10	22.01	<b>22.5</b>
		Low	QPSK	23.06	23.05	23.00	<b>23.5</b>
			16QAM	21.96	22.05	21.90	<b>22.5</b>
	6RB	/	QPSK	22.06	22.08	22.00	<b>22.5</b>
16QAM			21.12	21.15	21.06	<b>21.5</b>	
3 MHz				1753.5MHz	1732.5MHz	1711.5MHz	/
	1RB	High	QPSK	22.98	23.00	22.94	<b>23.5</b>
			16QAM	22.14	22.27	22.15	<b>22.5</b>
		Middle	QPSK	23.16	23.16	23.04	<b>23.5</b>
			16QAM	22.31	22.44	22.26	<b>22.5</b>
		Low	QPSK	22.98	23.01	22.95	<b>23.5</b>
			16QAM	22.14	22.30	22.13	<b>22.5</b>
	8RB	High	QPSK	22.02	22.03	21.97	<b>22.5</b>
			16QAM	21.04	21.13	20.98	<b>21.5</b>
		Middle	QPSK	22.05	22.06	21.98	<b>22.5</b>
			16QAM	21.08	21.16	21.04	<b>21.5</b>
		Low	QPSK	22.03	22.04	21.97	<b>22.5</b>
			16QAM	21.05	21.15	21.01	<b>21.5</b>
	15RB	/	QPSK	22.05	22.03	21.97	<b>22.5</b>
16QAM			21.03	21.06	20.96	<b>21.5</b>	

LTE-FDD Band 4				Actual output Power (dBm)			Tune up
Band-width	RB allocation	RB offset	Modulation	High	Middle	Low	
5 MHz				1752.5MHz	1732.5MHz	1712.5MHz	
	1RB	High	QPSK	22.87	22.88	22.85	<b>23.5</b>
			16QAM	22.03	22.17	22.08	<b>22.5</b>
		Middle	QPSK	23.17	23.15	23.13	<b>23.5</b>
			16QAM	22.33	22.51	22.39	<b>22.5</b>
		Low	QPSK	22.88	22.92	22.83	<b>23.5</b>
			16QAM	22.04	22.18	22.03	<b>22.5</b>
	12RB	High	QPSK	22.04	22.01	21.99	<b>22.5</b>
			16QAM	21.00	21.05	20.94	<b>21.5</b>
		Middle	QPSK	22.08	22.09	22.02	<b>22.5</b>
			16QAM	21.04	21.09	21.00	<b>21.5</b>
		Low	QPSK	21.99	22.05	21.97	<b>22.5</b>
			16QAM	20.96	21.09	20.97	<b>21.5</b>
	25RB	/	QPSK	22.04	22.03	22.01	<b>22.5</b>
16QAM			21.03	21.08	20.98	<b>21.5</b>	
10 MHz				1750MHz	1732.5MHz	1715MHz	/
	1RB	High	QPSK	22.98	22.97	22.97	<b>23.5</b>
			16QAM	22.11	22.26	22.28	<b>22.5</b>
		Middle	QPSK	23.06	23.09	23.04	<b>23.5</b>
			16QAM	22.25	22.42	22.30	<b>22.5</b>
		Low	QPSK	22.99	23.06	22.96	<b>23.5</b>
			16QAM	22.25	22.37	22.20	<b>22.5</b>
	25RB	High	QPSK	22.12	22.07	22.03	<b>22.5</b>
			16QAM	21.09	21.10	21.03	<b>21.5</b>
		Middle	QPSK	22.07	22.09	22.06	<b>22.5</b>
			16QAM	21.04	21.09	21.07	<b>21.5</b>
		Low	QPSK	22.06	22.14	22.08	<b>22.5</b>
			16QAM	21.02	21.14	21.05	<b>21.5</b>
	50RB	/	QPSK	22.08	22.11	22.07	<b>22.5</b>
16QAM			21.06	21.13	21.09	<b>21.5</b>	

LTE-FDD Band 4				Actual output Power (dBm)			Tune up
Band-width	RB allocation	RB offset	Modulation	High	Middle	Low	
15 MHz				1747.5MHz	1732.5MHz	1717.5MHz	
	1RB	High	QPSK	22.88	22.88	22.91	<b>23.5</b>
			16QAM	22.05	22.12	22.22	<b>22.5</b>
		Middle	QPSK	22.98	23.03	23.01	<b>23.5</b>
			16QAM	22.20	22.34	22.23	<b>22.5</b>
		Low	QPSK	22.96	22.99	22.92	<b>23.5</b>
			16QAM	22.23	22.28	22.14	<b>22.5</b>
	36RB	High	QPSK	22.06	22.07	22.05	<b>22.5</b>
			16QAM	20.99	21.05	21.03	<b>21.5</b>
		Middle	QPSK	22.07	22.10	22.09	<b>22.5</b>
			16QAM	21.04	21.09	21.07	<b>21.5</b>
		Low	QPSK	22.06	22.12	22.10	<b>22.5</b>
			16QAM	21.02	21.12	21.06	<b>21.5</b>
	75RB	/	QPSK	22.05	22.09	22.07	<b>22.5</b>
16QAM			21.01	21.09	21.05	<b>21.5</b>	
20 MHz				1745MHz	1732.5MHz	1720MHz	/
	1RB	High	QPSK	22.61	22.66	22.79	<b>23.5</b>
			16QAM	21.78	21.97	22.06	<b>22.5</b>
		Middle	QPSK	<b>23.07</b>	<b>23.16</b>	<b>23.23</b>	<b>23.5</b>
			16QAM	22.24	22.44	22.52	<b>22.5</b>
		Low	QPSK	22.82	22.89	22.86	<b>23.5</b>
			16QAM	22.12	22.22	22.02	<b>22.5</b>
	50RB	High	QPSK	22.04	22.06	22.06	<b>22.5</b>
			16QAM	21.02	21.08	21.11	<b>21.5</b>
		Middle	QPSK	<b>22.09</b>	22.15	<b>22.24</b>	<b>22.5</b>
			16QAM	21.05	21.17	21.24	<b>21.5</b>
		Low	QPSK	22.05	<b>22.22</b>	22.23	<b>22.5</b>
			16QAM	21.04	21.22	21.22	<b>21.5</b>
	100RB	/	QPSK	22.02	<b>22.15</b>	22.14	<b>22.5</b>
16QAM			21.02	21.14	21.14	<b>21.5</b>	



LTE-FDD Band 5				Actual output Power (dBm)			Tune up
Band-width	RB allocation	RB offset	Modulation	High	Middle	Low	
1.4 MHz				848.3MHz	836.5MHz	824.7MHz	
	1RB	High	QPSK	22.98	22.99	22.97	<b>23.5</b>
			16QAM	22.24	22.26	22.23	<b>22.5</b>
		Middle	QPSK	23.09	23.12	23.07	<b>23.5</b>
			16QAM	22.36	22.42	22.32	<b>22.5</b>
		Low	QPSK	22.94	22.99	22.92	<b>23.5</b>
			16QAM	22.21	22.30	22.23	<b>22.5</b>
	3RB	High	QPSK	23.06	23.09	23.05	<b>23.5</b>
			16QAM	22.03	22.05	22.02	<b>22.5</b>
		Middle	QPSK	23.09	23.13	23.09	<b>23.5</b>
			16QAM	22.09	22.14	22.08	<b>22.5</b>
		Low	QPSK	23.05	23.08	23.03	<b>23.5</b>
			16QAM	22.04	22.10	21.97	<b>22.5</b>
	6RB	/	QPSK	22.06	22.08	22.03	<b>22.5</b>
16QAM			21.13	21.19	21.21	<b>21.5</b>	
3 MHz				847.5MHz	836.5MHz	825.5MHz	/
	1RB	High	QPSK	23.00	23.03	23.03	<b>23.5</b>
			16QAM	22.29	22.35	22.30	<b>22.5</b>
		Middle	QPSK	23.15	23.16	23.14	<b>23.5</b>
			16QAM	22.41	22.42	22.43	<b>22.5</b>
		Low	QPSK	23.02	23.04	22.98	<b>23.5</b>
			16QAM	22.31	22.37	22.26	<b>22.5</b>
	8RB	High	QPSK	22.03	22.04	22.01	<b>22.5</b>
			16QAM	21.08	21.11	21.14	<b>21.5</b>
		Middle	QPSK	22.05	22.06	22.04	<b>22.5</b>
			16QAM	21.13	21.15	21.18	<b>21.5</b>
		Low	QPSK	22.01	22.02	21.98	<b>22.5</b>
			16QAM	21.07	21.14	21.15	<b>21.5</b>
	15RB	/	QPSK	22.01	22.04	21.98	<b>22.5</b>
16QAM			21.06	21.08	21.07	<b>21.5</b>	

LTE-FDD Band 5				Actual output Power (dBm)			Tune up
Band-width	RB allocation	RB offset	Modulation	High	Middle	Low	
5 MHz				846.5MHz	836.5MHz	826.5MHz	
	1RB	High	QPSK	22.92	22.95	22.97	<b>23.5</b>
			16QAM	22.23	22.29	22.29	<b>22.5</b>
		Middle	QPSK	23.15	23.12	23.21	<b>23.5</b>
			16QAM	22.39	22.47	22.42	<b>22.5</b>
		Low	QPSK	22.94	22.99	22.90	<b>23.5</b>
			16QAM	22.28	22.30	22.23	<b>22.5</b>
	12RB	High	QPSK	22.03	22.06	22.10	<b>22.5</b>
			16QAM	21.03	21.06	21.15	<b>21.5</b>
		Middle	QPSK	22.07	22.08	22.10	<b>22.5</b>
			16QAM	21.05	21.08	21.17	<b>21.5</b>
		Low	QPSK	22.06	22.05	21.99	<b>22.5</b>
			16QAM	21.05	21.03	21.03	<b>21.5</b>
	25RB	/	QPSK	22.05	22.10	22.06	<b>22.5</b>
16QAM			21.00	21.10	21.13	<b>21.5</b>	
10 MHz				844MHz	836.5MHz	829MHz	/
	1RB	High	QPSK	23.02	23.02	23.02	<b>23.5</b>
			16QAM	22.28	22.32	22.37	<b>22.5</b>
		Middle	QPSK	<b>23.16</b>	<b>23.20</b>	<b>23.17</b>	<b>23.5</b>
			16QAM	22.42	22.47	22.45	<b>22.5</b>
		Low	QPSK	23.06	23.06	23.00	<b>23.5</b>
			16QAM	22.32	22.37	22.26	<b>22.5</b>
	25RB	High	QPSK	22.12	<b>22.16</b>	22.14	<b>22.5</b>
			16QAM	21.15	21.16	21.21	<b>21.5</b>
		Middle	QPSK	<b>22.13</b>	22.12	22.15	<b>22.5</b>
			16QAM	21.13	21.12	21.20	<b>21.5</b>
		Low	QPSK	22.12	22.13	<b>22.16</b>	<b>22.5</b>
			16QAM	21.14	21.20	21.22	<b>21.5</b>
	50RB	/	QPSK	22.13	22.12	22.13	<b>22.5</b>
16QAM			21.12	21.14	21.19	<b>21.5</b>	

LTE-FDD Band 7				Actual output Power (dBm)			Tune up
Band-width	RB allocation	RB offset	Modulation	High	Middle	Low	
5 MHz				2567.4MHz	2535MHz	2502.5MHz	
	1RB	High	QPSK	22.58	22.44	22.66	23.5
			16QAM	21.82	21.67	21.83	22.5
		Middle	QPSK	22.92	22.75	22.93	23.5
			16QAM	22.11	21.93	22.12	22.5
		Low	QPSK	22.58	22.43	22.68	23.5
			16QAM	21.75	21.65	21.89	22.5
	12RB	High	QPSK	21.77	21.62	21.85	22.5
			16QAM	20.78	20.64	20.86	21.5
		Middle	QPSK	21.81	21.66	21.90	22.5
			16QAM	20.82	20.68	20.92	21.5
		Low	QPSK	21.74	21.61	21.82	22.5
			16QAM	20.76	20.62	20.85	21.5
	25RB	/	QPSK	21.79	21.63	21.84	22.5
16QAM			20.79	20.66	20.89	21.5	
10 MHz				2565MHz	2535MHz	2505MHz	/
	1RB	High	QPSK	22.69	22.52	22.71	23.5
			16QAM	21.86	21.73	21.87	22.5
		Middle	QPSK	22.76	22.61	22.86	23.5
			16QAM	21.93	21.87	22.05	22.5
		Low	QPSK	22.58	22.52	22.74	23.5
			16QAM	21.72	21.70	21.90	22.5
	25RB	High	QPSK	21.81	21.68	21.88	22.5
			16QAM	20.81	20.71	20.91	21.5
		Middle	QPSK	21.77	21.65	21.84	22.5
			16QAM	20.79	20.68	20.88	21.5
		Low	QPSK	21.73	21.63	21.83	22.5
			16QAM	20.74	20.65	20.85	21.5
	50RB	/	QPSK	21.77	21.65	21.85	22.5
16QAM			20.79	20.69	20.88	21.5	

LTE-FDD Band 7				Actual output Power (dBm)			Tune up
Band-width	RB allocation	RB offset	Modulation	High	Middle	Low	
15 MHz				2562.5MHz	2535MHz	2507.5MHz	
	1RB	High	QPSK	22.60	22.43	22.58	<b>23.5</b>
			16QAM	21.81	21.65	21.77	<b>22.5</b>
		Middle	QPSK	22.66	22.55	22.74	<b>23.5</b>
			16QAM	21.85	21.74	21.89	<b>22.5</b>
		Low	QPSK	22.43	22.43	22.65	<b>23.5</b>
			16QAM	21.61	21.65	21.86	<b>22.5</b>
	36RB	High	QPSK	21.79	21.64	21.81	<b>22.5</b>
			16QAM	20.78	20.65	20.82	<b>21.5</b>
		Middle	QPSK	21.74	21.65	21.83	<b>22.5</b>
			16QAM	20.72	20.66	20.84	<b>21.5</b>
		Low	QPSK	21.66	21.61	21.79	<b>22.5</b>
			16QAM	20.66	20.61	20.79	<b>21.5</b>
	75RB	/	QPSK	21.74	21.63	21.83	<b>22.5</b>
16QAM			20.74	20.65	20.82	<b>21.5</b>	
20 MHz				2560MHz	2535MHz	2510MHz	/
	1RB	High	QPSK	22.52	22.49	22.49	<b>23.5</b>
			16QAM	21.76	21.65	21.76	<b>22.5</b>
		Middle	QPSK	<b>22.84</b>	<b>22.79</b>	<b>22.87</b>	<b>23.5</b>
			16QAM	21.98	22.03	22.00	<b>22.5</b>
		Low	QPSK	22.40	22.40	22.45	<b>23.5</b>
			16QAM	21.58	21.66	21.64	<b>22.5</b>
	50RB	High	QPSK	21.89	21.84	<b>21.91</b>	<b>22.5</b>
			16QAM	20.92	20.87	20.93	<b>21.5</b>
		Middle	QPSK	<b>21.90</b>	<b>21.85</b>	21.90	<b>22.5</b>
			16QAM	20.90	20.89	20.91	<b>21.5</b>
		Low	QPSK	21.80	21.76	21.79	<b>22.5</b>
			16QAM	20.81	20.78	20.80	<b>21.5</b>
	100RB	/	QPSK	21.84	21.78	21.83	<b>22.5</b>
16QAM			20.85	20.79	20.84	<b>21.5</b>	

LTE-FDD Band 12				Actual output Power (dBm)			Tune up
Band-width	RB allocation	RB offset	Modulation	High	Middle	Low	
1.4 MHz				715.3MHz	707.5MHz	699.7MHz	
	1RB	High	QPSK	22.62	22.65	22.69	23.5
			16QAM	21.87	22.02	22.06	22.5
		Middle	QPSK	22.73	22.75	22.80	23.5
			16QAM	21.95	22.14	22.16	22.5
		Low	QPSK	22.62	22.62	22.64	23.5
			16QAM	21.89	22.01	21.99	22.5
	3RB	High	QPSK	22.76	22.73	22.79	23.5
			16QAM	21.69	21.78	21.84	22.5
		Middle	QPSK	22.79	22.77	22.82	23.5
			16QAM	21.73	21.85	21.86	22.5
		Low	QPSK	22.73	22.72	22.75	23.5
			16QAM	21.70	21.78	21.80	22.5
	6RB	/	QPSK	21.83	21.80	21.84	22.5
16QAM			20.88	20.91	20.93	21.5	
3 MHz				714.5MHz	707.5MHz	700.5MHz	/
	1RB	High	QPSK	22.70	22.73	22.74	23.5
			16QAM	21.89	22.07	22.09	22.5
		Middle	QPSK	22.89	22.87	22.94	23.5
			16QAM	22.08	22.29	22.27	22.5
		Low	QPSK	22.71	22.72	22.74	23.5
			16QAM	22.08	22.01	22.10	22.5
	8RB	High	QPSK	21.83	21.78	21.85	22.5
			16QAM	20.87	20.89	20.95	21.5
		Middle	QPSK	21.85	21.85	21.86	22.5
			16QAM	20.92	20.93	20.97	21.5
		Low	QPSK	21.82	21.83	21.82	22.5
			16QAM	20.88	20.93	20.92	21.5
	15RB	/	QPSK	21.85	21.79	21.84	22.5
16QAM			20.82	20.85	20.88	21.5	

LTE-FDD Band 12				Actual output Power (dBm)			Tune up
Band-width	RB allocation	RB offset	Modulation	High	Middle	Low	
5 MHz				713.5MHz	707.5MHz	701.5MHz	
	1RB	High	QPSK	22.62	22.67	22.64	<b>23.5</b>
			16QAM	21.82	22.03	22.03	<b>22.5</b>
		Middle	QPSK	22.87	22.91	22.92	<b>23.5</b>
			16QAM	22.19	22.30	22.21	<b>22.5</b>
		Low	QPSK	22.62	22.60	22.62	<b>23.5</b>
			16QAM	21.97	21.95	22.00	<b>22.5</b>
	12RB	High	QPSK	21.87	21.76	21.94	<b>22.5</b>
			16QAM	20.85	20.81	20.96	<b>21.5</b>
		Middle	QPSK	21.87	21.87	21.88	<b>22.5</b>
			16QAM	20.88	20.91	20.93	<b>21.5</b>
		Low	QPSK	21.80	21.88	21.75	<b>22.5</b>
			16QAM	20.80	20.89	20.78	<b>21.5</b>
	25RB	/	QPSK	21.86	21.81	21.87	<b>22.5</b>
16QAM			20.88	20.84	20.88	<b>21.5</b>	
10 MHz				711MHz	707.5MHz	704MHz	/
	1RB	High	QPSK	22.77	22.81	22.74	<b>23.5</b>
			16QAM	21.99	22.22	22.13	<b>22.5</b>
		Middle	QPSK	<b>22.86</b>	<b>22.83</b>	<b>22.82</b>	<b>23.5</b>
			16QAM	22.23	22.17	22.19	<b>22.5</b>
		Low	QPSK	22.68	22.68	22.69	<b>23.5</b>
			16QAM	22.08	22.01	22.05	<b>22.5</b>
	25RB	High	QPSK	22.00	21.78	21.79	<b>22.5</b>
			16QAM	20.98	20.82	20.81	<b>21.5</b>
		Middle	QPSK	21.90	21.88	<b>21.86</b>	<b>22.5</b>
			16QAM	20.91	20.88	20.87	<b>21.5</b>
		Low	QPSK	<b>22.03</b>	<b>21.89</b>	21.66	<b>22.5</b>
			16QAM	21.05	20.92	20.69	<b>21.5</b>
	50RB	/	QPSK	22.03	21.88	21.74	<b>22.5</b>
16QAM			21.03	20.88	20.78	<b>21.5</b>	

LTE-FDD Band 17				Actual output Power (dBm)			Tune up
Band-width	RB allocation	RB offset	Modulation	High	Middle	Low	
5 MHz				713.5MHz	710MHz	706.5MHz	
	1RB	High	QPSK	22.41	22.46	22.50	<b>23.5</b>
			16QAM	21.69	21.82	21.88	<b>22.5</b>
		Middle	QPSK	22.74	22.77	22.72	<b>23.5</b>
			16QAM	22.07	22.09	22.14	<b>22.5</b>
		Low	QPSK	22.43	22.45	22.46	<b>23.5</b>
			16QAM	21.83	21.86	21.79	<b>22.5</b>
	12RB	High	QPSK	21.68	21.68	21.57	<b>22.5</b>
			16QAM	20.67	20.69	20.59	<b>21.5</b>
		Middle	QPSK	21.71	21.71	21.68	<b>22.5</b>
			16QAM	20.73	20.75	20.71	<b>21.5</b>
		Low	QPSK	21.59	21.75	21.64	<b>22.5</b>
			16QAM	20.61	20.78	20.69	<b>21.5</b>
	25RB	/	QPSK	21.67	21.73	21.62	<b>22.5</b>
16QAM			20.68	20.78	20.64	<b>21.5</b>	
10 MHz				711MHz	710MHz	709MHz	/
	1RB	High	QPSK	22.52	22.53	22.58	<b>23.5</b>
			16QAM	21.78	21.85	21.90	<b>22.5</b>
		Middle	QPSK	<b>22.71</b>	<b>22.68</b>	<b>22.67</b>	<b>23.5</b>
			16QAM	22.10	22.07	22.09	<b>22.5</b>
		Low	QPSK	22.52	22.47	22.53	<b>23.5</b>
			16QAM	21.85	21.82	21.84	<b>22.5</b>
	25RB	High	QPSK	21.82	21.75	21.74	<b>22.5</b>
			16QAM	20.82	20.80	20.77	<b>21.5</b>
		Middle	QPSK	21.71	21.68	21.72	<b>22.5</b>
			16QAM	20.76	20.73	20.75	<b>21.5</b>
		Low	QPSK	<b>21.84</b>	<b>21.80</b>	<b>21.76</b>	<b>22.5</b>
			16QAM	20.86	20.84	20.78	<b>21.5</b>
	50RB	/	QPSK	21.87	21.82	21.80	<b>22.5</b>
16QAM			20.86	20.84	20.81	<b>21.5</b>	

LTE-FDD Band 38				Actual output Power (dBm)			Tune up
Band-width	RB allocation	RB offset	Modulation	High	Middle	Low	
5 MHz				2617.5MHz	2595MHz	2572.5MHz	
	1RB	High	QPSK	22.93	23.01	23.07	<b>23.5</b>
			16QAM	21.96	22.04	22.13	<b>22.5</b>
		Middle	QPSK	23.07	23.16	23.31	<b>23.5</b>
			16QAM	22.12	22.22	22.40	<b>22.5</b>
		Low	QPSK	22.96	23.01	23.07	<b>23.5</b>
			16QAM	21.99	22.06	22.12	<b>22.5</b>
	12RB	High	QPSK	22.11	22.16	22.27	<b>22.5</b>
			16QAM	21.07	21.13	21.23	<b>21.5</b>
		Middle	QPSK	22.19	22.26	22.31	<b>22.5</b>
			16QAM	21.12	21.18	21.22	<b>21.5</b>
		Low	QPSK	22.14	22.18	22.24	<b>22.5</b>
			16QAM	21.07	21.14	21.20	<b>21.5</b>
	25RB	/	QPSK	22.05	22.13	22.22	<b>22.5</b>
16QAM			21.10	21.20	21.24	<b>21.5</b>	
10 MHz				2615MHz	2595MHz	2575MHz	/
	1RB	High	QPSK	23.04	23.08	23.12	<b>23.5</b>
			16QAM	22.03	22.14	22.18	<b>22.5</b>
		Middle	QPSK	23.16	23.24	23.21	<b>23.5</b>
			16QAM	22.18	22.26	22.29	<b>22.5</b>
		Low	QPSK	23.02	23.13	23.18	<b>23.5</b>
			16QAM	22.03	22.14	22.20	<b>22.5</b>
	25RB	High	QPSK	22.03	22.12	22.23	<b>22.5</b>
			16QAM	21.06	21.17	21.27	<b>21.5</b>
		Middle	QPSK	22.06	22.15	22.27	<b>22.5</b>
			16QAM	21.15	21.22	21.27	<b>21.5</b>
		Low	QPSK	22.09	22.17	22.25	<b>22.5</b>
			16QAM	21.09	21.18	21.24	<b>21.5</b>
	50RB	/	QPSK	22.02	22.10	22.15	<b>22.5</b>
16QAM			21.04	21.15	21.24	<b>21.5</b>	



LTE-FDD Band 38				Actual output Power (dBm)			Tune up
Band-width	RB allocation	RB offset	Modulation	High	Middle	Low	
15 MHz				2612.5MHz	2595MHz	2577.5MHz	
	1RB	High	QPSK	22.86	22.94	22.99	<b>23.5</b>
			16QAM	21.89	22.01	22.07	<b>22.5</b>
		Middle	QPSK	23.02	23.13	23.23	<b>23.5</b>
			16QAM	22.05	22.15	22.26	<b>22.5</b>
		Low	QPSK	22.92	22.97	23.03	<b>23.5</b>
			16QAM	21.92	22.03	22.07	<b>22.5</b>
	36RB	High	QPSK	22.09	22.20	22.20	<b>22.5</b>
			16QAM	21.06	21.13	21.17	<b>21.5</b>
		Middle	QPSK	22.10	22.19	22.20	<b>22.5</b>
			16QAM	21.06	21.15	21.22	<b>21.5</b>
		Low	QPSK	22.13	22.18	22.22	<b>22.5</b>
			16QAM	21.03	21.11	21.11	<b>21.5</b>
	75RB	/	QPSK	21.95	22.05	22.03	<b>22.5</b>
16QAM			20.97	21.06	21.14	<b>21.5</b>	
20 MHz				2610MHz	2595MHz	2580MHz	/
	1RB	High	QPSK	<b>22.46</b>	<b>22.59</b>	22.75	<b>23.5</b>
			16QAM	21.49	21.67	21.83	<b>22.5</b>
		Middle	QPSK	22.37	22.55	<b>22.76</b>	<b>23.5</b>
			16QAM	21.76	22.13	22.28	<b>22.5</b>
		Low	QPSK	22.03	22.26	22.42	<b>23.5</b>
			16QAM	21.52	21.82	21.98	<b>22.5</b>
	50RB	High	QPSK	21.24	21.46	21.73	<b>22.5</b>
			16QAM	20.72	20.93	21.19	<b>21.5</b>
		Middle	QPSK	<b>21.32</b>	<b>21.56</b>	21.77	<b>22.5</b>
			16QAM	20.81	21.06	21.15	<b>21.5</b>
		Low	QPSK	21.31	21.52	<b>21.85</b>	<b>22.5</b>
			16QAM	20.80	20.96	21.14	<b>21.5</b>
	100RB	/	QPSK	21.31	21.64	21.93	<b>22.5</b>
16QAM			20.77	21.02	21.23	<b>21.5</b>	

LTE-FDD Band 66				Actual output Power (dBm)			Tune up
Band-width	RB allocation	RB offset	Modulation	High	Middle	Low	
1.4 MHz				1779.3MHz	1745MHz	1710.7MHz	
	1RB	High	QPSK	23.29	23.22	23.38	<b>24</b>
			16QAM	22.28	22.12	22.40	<b>23</b>
		Middle	QPSK	23.74	23.68	23.71	<b>24</b>
			16QAM	22.75	22.68	22.74	<b>23</b>
		Low	QPSK	23.37	23.40	23.29	<b>24</b>
			16QAM	22.39	22.37	22.38	<b>23</b>
	3RB	High	QPSK	23.35	23.31	23.41	<b>24</b>
			16QAM	22.35	22.35	22.38	<b>23</b>
		Middle	QPSK	23.75	23.77	23.69	<b>24</b>
			16QAM	22.77	22.75	22.65	<b>23</b>
		Low	QPSK	23.39	23.50	23.31	<b>24</b>
			16QAM	22.35	22.48	22.35	<b>23</b>
	6RB	/	QPSK	22.65	22.57	22.51	<b>23</b>
16QAM			21.69	21.52	21.52	<b>22</b>	
3 MHz				1778.5MHz	1745MHz	1711.5MHz	/
	1RB	High	QPSK	23.25	23.19	23.31	<b>24</b>
			16QAM	22.47	22.18	22.30	<b>23</b>
		Middle	QPSK	23.85	23.77	23.61	<b>24</b>
			16QAM	22.72	22.71	22.68	<b>23</b>
		Low	QPSK	23.36	23.39	23.22	<b>24</b>
			16QAM	22.60	22.40	22.26	<b>23</b>
	8RB	High	QPSK	22.69	22.54	22.62	<b>23</b>
			16QAM	21.54	21.68	21.74	<b>22</b>
		Middle	QPSK	22.67	22.61	22.51	<b>23</b>
			16QAM	21.67	21.80	21.64	<b>22</b>
		Low	QPSK	22.76	22.65	22.61	<b>23</b>
			16QAM	21.77	21.59	21.44	<b>22</b>
	15RB	/	QPSK	22.62	22.65	22.63	<b>23</b>
16QAM			21.83	21.60	21.61	<b>22</b>	

LTE-FDD Band 66				Actual output Power (dBm)			Tune up
Band-width	RB allocation	RB offset	Modulation	High	Middle	Low	
5 MHz				1777.5MHz	1745MHz	1712.5MHz	
	1RB	High	QPSK	23.41	23.33	23.24	24
			16QAM	22.36	22.26	22.39	23
		Middle	QPSK	23.83	23.63	23.60	24
			16QAM	22.81	22.80	22.70	23
		Low	QPSK	23.38	23.26	23.34	24
			16QAM	22.65	22.39	22.31	23
	12RB	High	QPSK	22.64	22.73	22.51	23
			16QAM	21.62	21.62	21.62	22
		Middle	QPSK	22.66	22.66	22.63	23
			16QAM	21.83	21.80	21.75	22
		Low	QPSK	22.84	22.54	22.64	23
			16QAM	21.78	21.67	21.51	22
	25RB	/	QPSK	22.73	22.66	22.59	23
16QAM			21.83	21.67	21.51	22	
10 MHz				1775MHz	1745MHz	1715MHz	/
	1RB	High	QPSK	23.34	23.28	23.23	24
			16QAM	22.43	22.18	22.28	23
		Middle	QPSK	23.72	23.60	23.75	24
			16QAM	22.85	22.75	22.58	23
		Low	QPSK	23.49	23.38	23.37	24
			16QAM	22.58	22.39	22.25	23
	25RB	High	QPSK	22.70	22.54	22.55	23
			16QAM	21.58	21.62	21.70	22
		Middle	QPSK	22.70	22.79	22.57	23
			16QAM	21.70	21.83	21.70	22
		Low	QPSK	22.87	22.73	22.60	23
			16QAM	21.75	21.69	21.61	22
	50RB	/	QPSK	22.68	22.52	22.57	23
16QAM			21.73	21.70	21.46	22	

LTE-FDD Band 66				Actual output Power (dBm)			Tune up
Band-width	RB allocation	RB offset	Modulation	High	Middle	Low	
15 MHz				1772.5MHz	1745MHz	1717.5MHz	
	1RB	High	QPSK	23.28	23.25	23.19	<b>24</b>
			16QAM	22.19	22.27	22.18	<b>23</b>
		Middle	QPSK	23.71	23.65	23.64	<b>24</b>
			16QAM	22.65	22.71	22.57	<b>23</b>
		Low	QPSK	23.38	23.35	23.29	<b>24</b>
			16QAM	22.39	22.47	22.35	<b>23</b>
	36RB	High	QPSK	22.61	22.62	22.57	<b>23</b>
			16QAM	21.55	21.75	21.54	<b>22</b>
		Middle	QPSK	22.63	22.65	22.55	<b>23</b>
			16QAM	21.64	21.61	21.59	<b>22</b>
		Low	QPSK	22.74	22.61	22.63	<b>23</b>
			16QAM	21.75	21.66	21.62	<b>22</b>
	75RB	/	QPSK	22.72	22.59	22.51	<b>23</b>
16QAM			21.75	21.58	21.54	<b>22</b>	
20 MHz				1770MHz	1745MHz	1720MHz	/
	1RB	High	QPSK	23.31	23.26	23.29	<b>24</b>
			16QAM	22.43	22.25	22.35	<b>23</b>
		Middle	QPSK	<b>23.75</b>	<b>23.69</b>	<b>23.67</b>	<b>24</b>
			16QAM	22.75	22.74	22.62	<b>23</b>
		Low	QPSK	23.41	23.34	23.30	<b>24</b>
			16QAM	22.55	22.35	22.31	<b>23</b>
	50RB	High	QPSK	22.65	22.63	22.54	<b>23</b>
			16QAM	21.63	21.58	21.65	<b>22</b>
		Middle	QPSK	22.65	<b>22.70</b>	<b>22.57</b>	<b>23</b>
			16QAM	21.75	21.76	21.71	<b>22</b>
		Low	QPSK	<b>22.80</b>	22.63	22.64	<b>23</b>
			16QAM	21.84	21.62	21.53	<b>22</b>
	100RB	/	QPSK	<b>22.71</b>	22.61	22.55	<b>23</b>
16QAM			21.75	21.61	21.54	<b>22</b>	

### 11.4 Wi-Fi and BT Measurement result

**Table 11.5: The conducted Power measurement results for BT**

BT	Tune up	Averaged Power (dBm)		
Mode		Ch.0 (2402 MHz)	Ch39 (2441 MHz)	Ch78 (2480 MHz)
GFSK	<b>9.5</b>	8.96	6.90	9.13
EDR2M-4_DQPSK	<b>9.5</b>	8.30	6.10	8.39
EDR3M-8DPSK	<b>9.5</b>	8.29	6.26	8.39
BLE	<b>Tune up</b>	Ch0 (2402MHz)	Ch19 (2440MHz)	Ch39 (2480MHz)
	<b>-1</b>	-2.89	-2.82	-2.67

**Table 11.6: The conducted Power measurement results for 2.4G WIFI**

WiFi 2.4GHz	Tune up	Averaged Power (dBm) Duty Cycle: <b>100%</b>		
Mode		Ch.1(2412 MHz)	Ch.6(2437Mhz)	Ch.11(2462MHz)
802.11b	<b>14</b>	13.38	<b>13.49</b>	13.45
802.11g	<b>14</b>	13.16	13.40	13.33
802.11n(20MHz)	<b>14</b>	13.28	13.42	13.30
/	<b>/</b>	Ch.3(2422 MHz)	Ch.6(2437Mhz)	Ch.9(2452MHz)
802.11n(40MHz)	<b>14</b>	13.36	13.42	13.39

**Table 11.7: The conducted Power for 5G WIFI**

Averaged Power (dBm) Duty Cycle: 100%								
Mode	802.11a	802.11n -20MHz	802.11ac -20MHz	Mode	802.11n -40MHz	802.11ac -40MHz	Mode	802.11ac -80MHz
Channel	6Mbps	MCS0	MCS0	Channel	MCS0	MCS0	Channel	MCS0
<b>&lt;U-NII-1&gt;</b>								
<b>Tune up</b>	<b>14</b>	<b>14</b>	<b>14</b>	/	<b>14</b>	<b>14</b>	/	<b>14</b>
36(5180MHz)	13.57	12.91	13.17	38(5190MHz)	12.40	12.57	42(5210MHz)	12.53
40(5200MHz)	13.68	12.84	12.83	46(5230MHz)	12.27	12.46	/	/
48(5240MHz)	13.51	12.72	12.73	/	/	/	/	/
<b>&lt;U-NII-2A&gt;</b>								
<b>Tune up</b>	<b>14</b>	<b>14</b>	<b>14</b>	/	<b>14</b>	<b>14</b>	/	<b>14</b>
52(5260MHz)	13.15	12.61	12.73	54(5270MHz)	12.20	12.39	58(5290MHz)	12.43
56(5280MHz)	<b>13.23</b>	12.58	12.65	62(5310MHz)	12.15	12.33	/	/
64(5320MHz)	12.93	12.45	12.54	/	/	/	/	/
<b>&lt;U-NII-2C&gt;</b>								
<b>Tune up</b>	<b>13</b>	<b>13</b>	<b>13</b>	/	<b>13</b>	<b>13</b>	/	<b>13</b>
100(5500MHz)	<b>12.46</b>	12.05	12.09	102(5510MHz)	11.99	11.91	106(5530MHz)	11.67
120(5600MHz)	11.82	11.70	11.68	118(5590MHz)	11.80	11.72	122(5610MHz)	11.48
140(5700MHz)	11.75	11.53	11.54	134(5670MHz)	11.56	11.56	/	/
<b>&lt;U-NII-3&gt;</b>								
<b>Tune up</b>	<b>13</b>	<b>13</b>	<b>13</b>	/	<b>13</b>	<b>13</b>	/	<b>13</b>
149(5745MHz)	11.71	11.54	11.57	151(5755 MHz)	11.24	11.32	155(5775MHz)	11.45
157(5785MHz)	<b>11.75</b>	11.66	11.61	159(5795 MHz)	11.27	11.36	/	/
165(5825MHz)	11.69	11.55	11.58	/	/	/	/	/

## 12 Simultaneous TX SAR Considerations

### 12.1 Introduction

The following procedures adopted from “FCC SAR Considerations for Cell Phones with Multiple Transmitters” are applicable to handsets with built-in unlicensed transmitters such as 802.11 a/b/g and Bluetooth devices which may simultaneously transmit with the licensed transmitter. For this device, the BT and Wi-Fi can transmit simultaneous with other transmitters.

### 12.2 Transmit Antenna Separation Distances

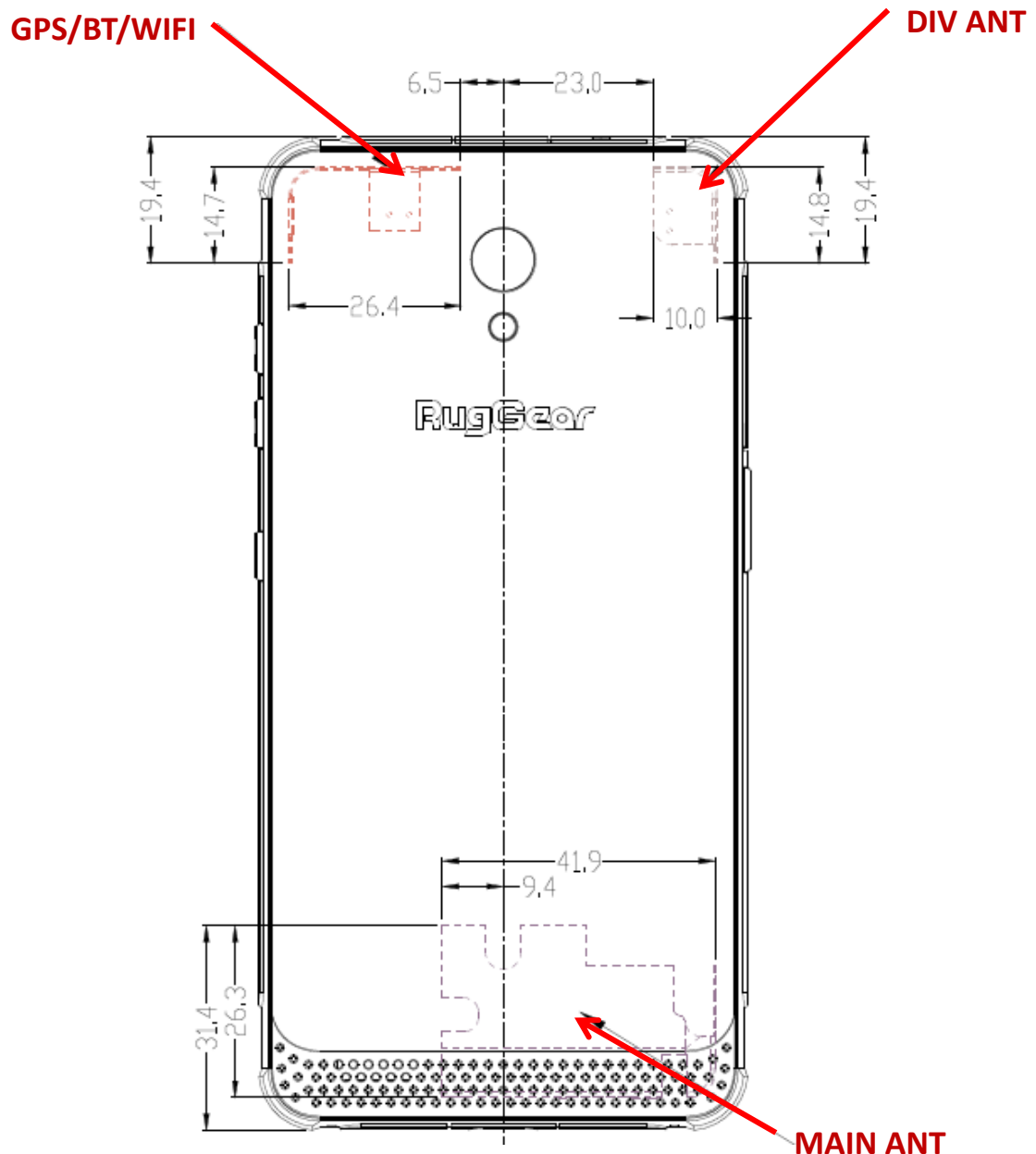

Picture 12.1 Antenna Locations (Back View)

### 12.3 SAR Measurement Positions

According to the KDB941225 D06 Hot Spot SAR, the edges with less than 2.5 cm distance to the antennas need to be tested for SAR.

SAR measurement positions						
Mode	Front	Rear	Left edge	Right edge	Top edge	Bottom edge
Main antenna	Yes	Yes	Yes	Yes	No	Yes
WIFI antenna	Yes	Yes	No	Yes	Yes	No

### 12.4 Standalone SAR Test Exclusion Considerations

Standalone 1-g head or body SAR evaluation by measurement or numerical simulation is not required when the corresponding SAR Exclusion Threshold condition, listed below, is satisfied.

The 1-g SAR test exclusion threshold for 100 MHz to 6 GHz at test separation distances  $\leq 50$  mm are determined by:

$[(\text{max. power of channel, including tune-up tolerance, mW}) / (\text{min. test separation distance, mm})] \cdot [\sqrt{f(\text{GHz})}] \leq 3.0$  for 1-g SAR, where

- $f(\text{GHz})$  is the RF channel transmit frequency in GHz
- Power and distance are rounded to the nearest mW and mm before calculation
- The result is rounded to one decimal place for comparison

**Table 12.1: Standalone SAR test exclusion considerations**

Band/Mode	f(GHz)	Position	SAR test exclusion threshold (mW)	RF output power		SAR test exclusion
				dBm	mW	
Bluetooth	2.441	Head	9.60	9.5	8.91	Yes
		Body	19.20	9.5	8.91	Yes
2.4GHz WLAN	2.45	Head	9.58	14	25.12	No
		Body	19.17	14	25.12	No
5GHz WLAN	5.2	Head	6.58	14	25.12	No
	5.2	Body	13.16	14	25.12	No
	5.3	Head	6.52	14	25.12	No
	5.3	Body	13.03	14	25.12	No
	5.6	Head	6.34	13	19.95	No
	5.6	Body	12.68	13	19.95	No
	5.8	Head	6.23	13	19.95	No
	5.8	Body	12.46	13	19.95	No



### 13 Evaluation of Simultaneous

**Table 13.1: The sum of reported SAR values for main antenna and Wi-Fi**

/	Position	Main antenna	Wi-Fi	Sum
Highest reported SAR value for Head	Left Touch	0.22	1.20	1.42
Highest reported SAR value for Body	Rear	1.20	0.24	1.44

**Table 13.2: The sum of reported SAR values for main antenna and Bluetooth**

/	Position	Main antenna	BT*	Sum
Highest reported SAR value for Head	Left Touch	0.22	0.37	0.59
Highest reported SAR value for Body	Rear	1.20	0.21	1.41

BT\* - Estimated SAR for Bluetooth (see the table 13.3)

**Table 13.3: Estimated SAR for Bluetooth**

Position	f (GHz)	Distance (mm)	Upper limit of power *		Estimated <sub>1g</sub> (W/kg)
			dBm	mW	
Head	2.441	5	9.5	8.91	0.37
Body	2.441	10	9.5	8.91	0.21

\* - Maximum possible output power declared by manufacturer

When standalone SAR test exclusion applies to an antenna that transmits simultaneously with other antennas, the standalone SAR must be estimated according to following to determine simultaneous transmission SAR test exclusion:

(max. power of channel, including tune-up tolerance, mW) / (min. test separation distance, mm)]·[√f(GHz)/x] W/kg for test separation distances ≤ 50 mm;

Where x = 7.5 for 1-g SAR.

When the minimum test separation distance is < 5 mm, a distance of 5 mm is applied to determine SAR test exclusion

#### **Conclusion:**

According to the above tables, the sum of reported SAR values is < 1.6W/kg. So the simultaneous transmission SAR with volume scans is not required.

## 14 SAR Test Result

It is determined by user manual for the distance between the EUT and the phantom bottom.

The distance is 10mm and just applied to the condition of body worn accessory.

It is performed for all SAR measurements with area scan based 1-g SAR estimation (Fast SAR). A zoom scan measurement is added when the estimated 1-g SAR is the highest measured SAR in each exposure configuration, wireless mode and frequency band combination or >1.2W/kg.

The calculated SAR is obtained by the following formula:

$$\text{Reported SAR} = \text{Measured SAR} \times 10^{(P_{\text{Target}} - P_{\text{Measured}})/10}$$

Where  $P_{\text{Target}}$  is the power of manufacturing upper limit;

$P_{\text{Measured}}$  is the measured power in chapter 11.

### Duty Cycle

Mode	Duty Cycle
Speech for GSM850/1900	1:8.3
GPRS for GSM850	1:4
GPRS for GSM1900	1:2
WCDMA850/1700/1900	1:1
FDD_LTE Band 2/4/5/7/12/17/66	1:1
TDD_LTE Band 38	1:1.58

### 14.1 SAR results

**Table 14.1: SAR Values (GSM 850 - Head)**

Frequency		Test Mode	Test Position	Figure No.	Ambient Temperature: 22.5°C		Liquid Temperature: 22.0°C		Power Drift(dB)
MHz	Ch.				Conducted Power (dBm)	Max. tune-up Power (dBm)	Measured SAR(1g) (W/kg)	Reported SAR(1g) (W/kg)	
836.6	190	Speech	Left Touch	/	32.88	34	0.062	0.08	0.06
836.6	190	Speech	Left Tilt	/	32.88	34	0.042	0.05	0.03
836.6	190	Speech	Right Touch	<b>Fig.1</b>	32.88	34	<b>0.066</b>	<b>0.09</b>	0.09
836.6	190	Speech	Right Tilt	/	32.88	34	0.036	0.05	0.05

**Table 14.2: SAR Values (GSM 850 -Body)**

Frequency		Test Mode	Test Position	Figure No.	Ambient Temperature: 22.5°C		Liquid Temperature: 22.0°C		Power Drift(dB)
MHz	Ch.				Conducted Power (dBm)	Max. tune-up Power (dBm)	Measured SAR(1g) (W/kg)	Reported SAR(1g) (W/kg)	
<b>Hotspot / Body Worn Test Data (10mm)</b>									
836.6	190	GPRS	Front	/	32.04	33	0.057	0.07	0.08
836.6	190	GPRS	Rear	<b>Fig.2</b>	32.04	33	<b>0.102</b>	<b>0.13</b>	0.02
836.6	190	GPRS	Left	/	32.04	33	0.054	0.07	0.07
836.6	190	GPRS	Right	/	32.04	33	0.014	0.02	0.02
836.6	190	GPRS	Bottom	/	32.04	33	0.029	0.04	0.07

**Table 14.3: SAR Values (GSM 1900 - Head)**

Frequency		Test Mode	Test Position	Figure No.	Conducted Power (dBm)	Max. tune-up Power (dBm)	Measured SAR(1g) (W/kg)	Reported SAR(1g) (W/kg)	Power Drift(dB)
MHz	Ch.								
Ambient Temperature: 22.7°C      Liquid Temperature: 22.2°C									
1880	661	Speech	Left Touch	<b>Fig.3</b>	30.12	31	<b>0.030</b>	<b>0.04</b>	0.06
1880	661	Speech	Left Tilt	/	30.12	31	0.015	0.02	0.04
1880	661	Speech	Right Touch	/	30.12	31	0.019	0.02	-0.08
1880	661	Speech	Right Tilt	/	30.12	31	0.014	0.02	-0.05

**Table 14.4: SAR Values (GSM 1900 - Body)**

Frequency		Test Mode	Test Position	Figure No.	Conducted Power (dBm)	Max. tune-up Power (dBm)	Measured SAR(1g) (W/kg)	Reported SAR(1g) (W/kg)	Power Drift(dB)
MHz	Ch.								
Ambient Temperature: 22.4°C      Liquid Temperature: 22.0°C									
<b>Hotspot / Body Worn Test Data (10mm)</b>									
1880	661	GPRS	Front	/	26.47	27	0.087	0.10	0.07
1880	661	GPRS	Rear	<b>Fig.4</b>	26.47	27	<b>0.546</b>	<b>0.62</b>	0.00
1880	661	GPRS	Left	/	26.47	27	0.030	0.03	-0.03
1880	661	GPRS	Right	/	26.47	27	0.012	0.01	-0.09
1880	661	GPRS	Bottom	/	26.47	27	0.215	0.24	-0.02

**Table 14.5: SAR Values (WCDMA 850 - Head)**

Frequency		Test Mode	Test Position	Figure No.	Conducted Power (dBm)	Max. tune-up Power (dBm)	Measured SAR(1g) (W/kg)	Reported SAR(1g) (W/kg)	Power Drift(dB)
MHz	Ch.								
Ambient Temperature: 22.5°C      Liquid Temperature: 22.0°C									
836.4	4182	RMC	Left Touch	/	23.80	24	0.070	0.07	0.14
836.4	4182	RMC	Left Tilt	/	23.80	24	0.046	0.05	0.04
836.4	4182	RMC	Right Touch	<b>Fig.5</b>	23.80	24	<b>0.071</b>	<b>0.07</b>	0.06
836.4	4182	RMC	Right Tilt	/	23.80	24	0.035	0.04	0.01

**Table 14.6: SAR Values (WCDMA 850 -Body)**

Frequency		Test Mode	Test Position	Figure No.	Conducted Power (dBm)	Max. tune-up Power (dBm)	Measured SAR(1g) (W/kg)	Reported SAR(1g) (W/kg)	Power Drift(dB)
MHz	Ch.								
Ambient Temperature: 22.8°C      Liquid Temperature: 22.2°C									
<b>Hotspot / Body Worn Test Data (10mm)</b>									
836.4	4182	RMC	Front	/	23.80	24	0.031	0.03	0.13
836.4	4182	RMC	Rear	<b>Fig.6</b>	23.80	24	<b>0.101</b>	<b>0.11</b>	0.01
836.4	4182	RMC	Left	/	23.80	24	0.021	0.02	0.08
836.4	4182	RMC	Right	/	23.80	24	0.020	0.02	0.06
836.4	4182	RMC	Bottom	/	23.80	24	0.027	0.03	-0.06

**Table 14.7: SAR Values (WCDMA1900 - Head)**

Frequency		Test Mode	Test Position	Figure No.	Conducted Power (dBm)	Max. tune-up Power (dBm)	Measured SAR(1g) (W/kg)	Reported SAR(1g) (W/kg)	Power Drift(dB)
MHz	Ch.								
Ambient Temperature: 22.7°C      Liquid Temperature: 22.2°C									
1880	9400	RMC	Left Touch	<b>Fig.7</b>	23.70	24	<b>0.064</b>	<b>0.07</b>	-0.07
1880	9400	RMC	Left Tilt	/	23.70	24	0.030	0.03	0.05
1880	9400	RMC	Right Touch	/	23.70	24	0.040	0.04	0.00
1880	9400	RMC	Right Tilt	/	23.70	24	0.038	0.04	0.07

**Table 14.8: SAR Values (WCDMA1900 - Body)**

Frequency		Test Mode	Test Position	Figure No.	Conducted Power (dBm)	Max. tune-up Power (dBm)	Measured SAR(1g) (W/kg)	Reported SAR(1g) (W/kg)	Power Drift(dB)
MHz	Ch.								
Ambient Temperature: 22.4°C      Liquid Temperature: 22.0°C									
<b>Hotspot / Body Worn Test Data (10mm)</b>									
1880	9400	RMC	Front	/	23.70	24	0.126	0.14	0.08
1880	9400	RMC	Rear	<b>Fig.8</b>	23.70	24	<b>0.692</b>	<b>0.74</b>	0.02
1880	9400	RMC	Left	/	23.70	24	0.038	0.04	0.05
1880	9400	RMC	Right	/	23.70	24	0.011	0.01	0.09
1880	9400	RMC	Bottom	/	23.70	24	0.316	0.34	-0.10