

# User Manual

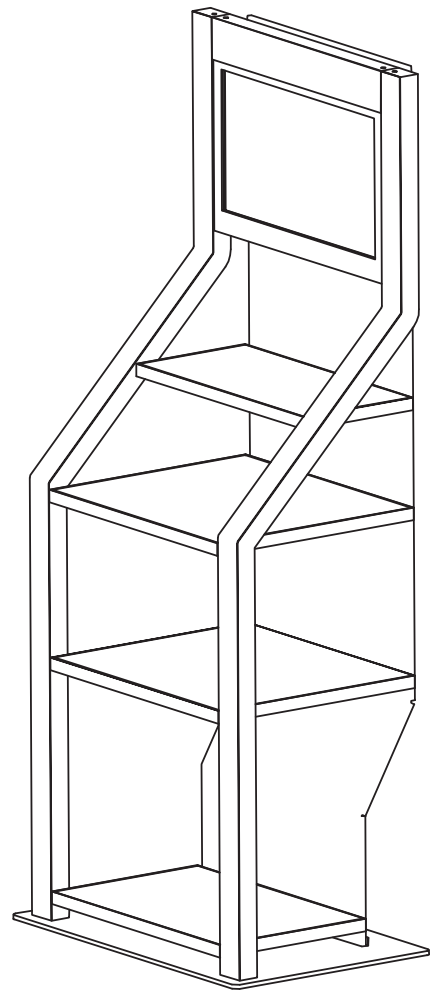

**Model:** SMMGRDS

**Description:**

Mobile Garment Rack with Digital Screen

FCC ID  
This device complies with Part 15 of the FCC Rules. Operation is subject to the following two conditions:  
(1) this device may not cause harmful interference, and  
(2) this device must accept any interference received, including interference that may cause undesired operation.  
Any changes/modifications to this equipment not approved by George Patton Associates could void the user's authority to operate the equipment.

**Scan QR code to visit the product page:**



## Operating Instructions for Digital Signage

Note: Before using the product, please read the instructions carefully!

Do not attempt to disassemble this product. If the product does not work properly, please call our Customer Service Department at 1-844-221-3393.

# Contents

<b>Features .....</b>	<b>3</b>
<b>Safety Warnings and Precautions .....</b>	<b>3</b>
<b>Assembly .....</b>	<b>5</b>
Packing List.....	5
Description for parts .....	6
Assembly .....	7
<b>Remote Control .....</b>	<b>8</b>
<b>Description of Basic Operation .....</b>	<b>9</b>
Power on/Standby .....	9
About Launch Desktop.....	9
Description of Wallpaper Switch.....	10
File Manager .....	10
Local Settings .....	11
Status of Menu bar .....	12
<b>Slide Show APP Introduction.....</b>	<b>12</b>
How to Upload Media Files .....	12
How to Delete Media Files.....	17
Factory Reset.....	19
Screen Rotate.....	19
Choose System Language.....	20
<b>Technical Specifications.....</b>	<b>21</b>
<b>Troubleshooting.....</b>	<b>23</b>
<b>Cleaning and Maintenance.....</b>	<b>25</b>
<b>Names and Contents of Toxic and Hazardous Substances or Elements in the Product.....</b>	<b>26</b>





## Features

1. Embedded with Android 7.1 smart operating system and unique UI design, bringing you a more convenient operation and better visual experience.
2. Support USB mouse and keyboard, realizing easy manipulation like a computer. Using a mouse for set up is recommended.
3. Built-in Wi-Fi module, high capacity memory and high capacity cache, making it smoother to watch 1080P HD movies and play big games.
4. High-quality LCD screen as the display, no flicker, low radiation, greatly reducing eye fatigue, eye protection, high brightness, high contrast, and wide viewing angle; ultra-fast response time greatly reduces ghosting of fast moving images.
5. Progressive image processing and industry-leading motion compensation technology improve the flickering and blurring in the edges of motion picture.
6. Dynamic contrast technology can significantly improve the clarity and contrast of various screens.
7. Multi-channel USB interfaces, supporting HD media streaming.
8. Ultra-thin narrow bezel design.

## Safety Warnings and Precautions

Thank you for purchasing the high-performance multi-functional LED backlight Digital Signage from Displays2go. We have considered the factors to ensure personal safety in product design and have tested rigorously at the factory. However, improper installation and use may result in electric shock and fire. In order to safely use, maximize performance of the unit and extend the life of the product, please read and follow all instructions carefully before using the product. Keep the instructions for future reference.

### Symbol Legends:

-  **Warning: May cause personal injury or death**
-  **The operation is prohibited**
-  **Caution: May cause damage or property loss**
-  **The operation must be executed**

### If any of the following occurs:

- Power outage or instable voltage.
- Abnormal sound or smell from the unit.
- AC power cord is damaged.
- Digital Interactive Table is damaged due to drop, knock or impact.
- Any liquid or foreign matters fall into the enclosure.



**Turn off the Digital Interactive Table immediately, pull out the plug from the power outlet, and ask the authorized personnel for maintenance timely.**

 **If coal gas or other flammable gas leaks, do not pull out the plug of the LCD Digital Signage or other electrical appliances; instead, turn off the gas valve immediately, and open the doors and windows quickly.**

 **WARNING**

- ⊘ ● Do not use power supply other than AC 110V, 50Hz.
- Cut off the power supply before connecting or disconnecting any cables.
- Do not place the Digital Signage on any instable positions, or else it may be damaged or cause fire.
- Do not place the Digital Signage in the positions such as:
  - 1.The environment subject to direct strong sunlight, moisture, extreme temperature or too much dust;
  - 2.The environment with flammable or explosive materials;
  - 3.The environment with flammable or corrosive gases;
- Do not use damaged or inappropriate power outlets, and ensure that the plugs and outlets contact properly.
- Do not let dust or metal deposits adhere to the plugs and outlets.
- Do not damage the power cords:
  - 1.Do not modify the power cords;
  - 2.Do not place heavy objects on the power cords;
  - 3.Keep the power cords away from heat source;
  - 4.Do not pull the cord to remove the plug.
- Do not connect too many plugs to one outlet in parallel, or else it may cause fire due to excessive power consumption.
- Do not approach the Digital Signage with open flame (e.g. a lighted candle), or else it may cause electric shock or fire.
- Do not put water filled container on the Digital Signage to avoid electric shock and fire due to water drops or splashing.
- Do not put any sharp objects, metal or liquid into the vents or let them touch the signal terminals to avoid short circuit, product damage, and electric shock.
- The openings in the enclosure are designed for ventilation and cooling, to ensure long time reliable running of components inside the enclosure and prevent overheating. Do not block the openings when place the unit.

⊘ Do not touch the plugs with wet fingers, or else it will cause electric shock.

Do not use the Digital Signage in stormy weather, especially when there is lightning; instead, please disconnect the power and antenna plugs to avoid lightning strike.

⊘ Do not disassemble the Digital Signage without permission, or else it may cause electric shock or fire. Please ask qualified technician for repair.

 **CAUTION**

- Do not let children climb onto the Digital Signage.
- Keep the small parts away from children to prevent them from swallowing.
- If the Digital Signage won't be used for a long time, please turn it off and pull out the power plug.
- To adjust the position or angle of the Digital Signage, please disconnect all power cords and move slowly to avoid falling.
- Do not scratch or knock the LCD with hard object, or twist and squeeze the LCD.
- Do not turn on the unit immediately when it is moved from a place with low temperature to high temperature, or else it will cause condensation and malfunction.
- Before cleaning the Digital Signage, please pull out the power plug; wipe with soft cloth; do not use industrial chemicals; prevent foreign matters from entering the machine. Improper cleaning (such as cleaning solution, water) may damage the product, erase the printed information, and even cause damage of the components if fluid flows in, resulting in machine failure.
- If the unit displays the same screen for a long time or the moving picture has fixed text or icon, it will leave ghosting on the screen and won't disappear when the unit is turned off; it is normal and isn't covered by the warranty.
- The power of the Digital Signage can be cut off by pulling out the plug.
- If the LCD screen ruptures and the liquid splashes on the skin, please rinse for 15 minutes with clean water immediately, and consult your doctor.
- To carry the Digital Signage with hands, please grab the corners and hold the bottom; do not apply pressure on the panel.
- Use the Digital Signage properly: Use in proper lighting conditions; insufficient lighting or long time watching will impair your eyesight.
- When the plug or coupler is used as disconnection device, it should be easy to operate the device.
- Insert the plug into the outlet properly, or else it may cause sparks and fire.
- The technical specifications printed herein and on the packaging are subject to change without prior notice. The Manual may be slightly different from actual operation, and the latter is applicable.

## Assembly

### Packing List

Name	
1 Digital Signage	●
1 Remote Control	●
1 Operation Manual	●

Name	
2 Keys	●
4 Glass Shelves	●

**Note:**

Contact local dealer if you have questions about the operation, debugging and connection of the unit; if the unit doesn't work normally, please cut off the power immediately and consult the dealer. The unit is class-A product, which may cause radio interference in living environment. In this case, please take feasible measures, and use power plug as the disconnection device.

Description for parts

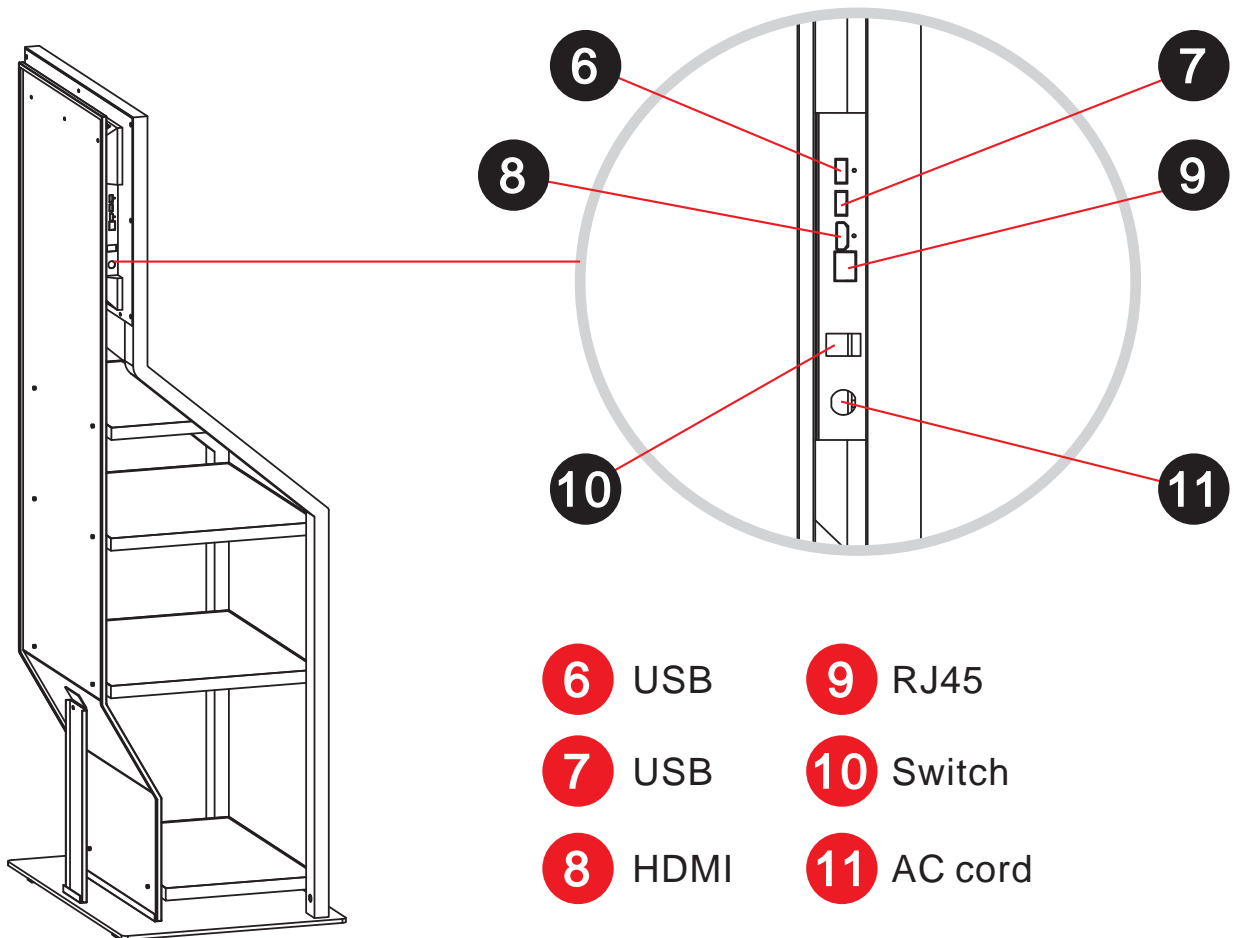
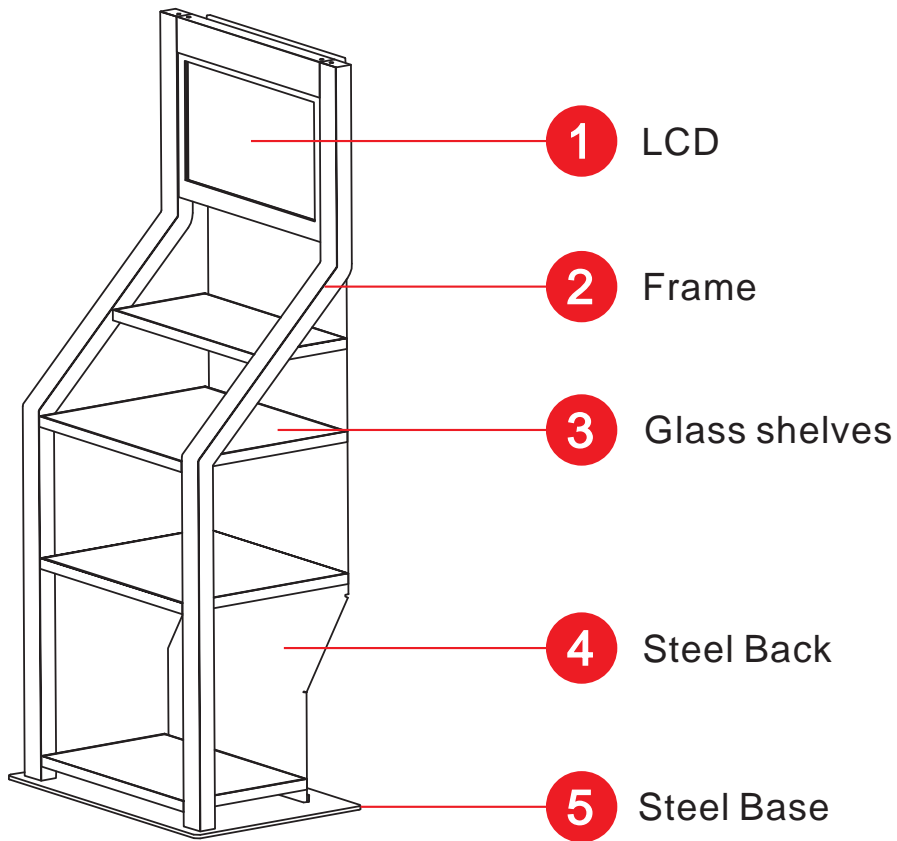

# Assembly

## Step 1

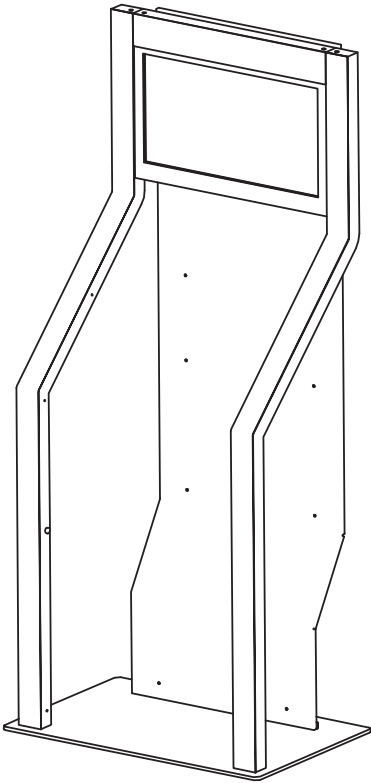

Standing the frame on a flat surface.

## Step 2



- 1 - 1A → 1A → 1B → 1B
- 2 - 2A → 2A → 2B → 2B
- 3 - 3A → 3A → 3B → 3B
- 4 - 4A → 4A → 4B → 4B

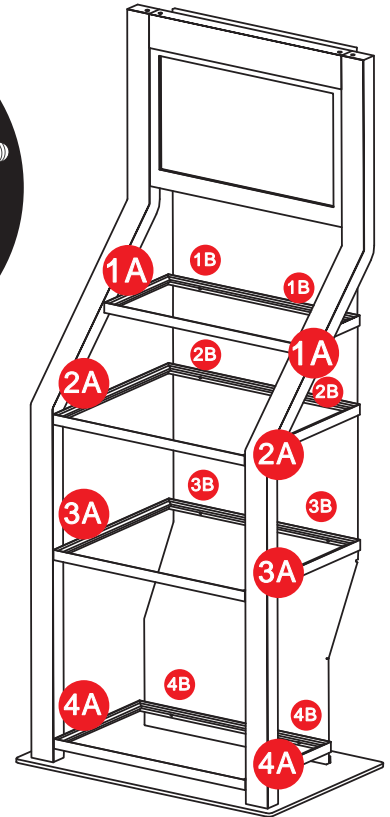

Fix the alu. Shelf frames with the knob screws provided, and please follow the above sequence.

## Step 3

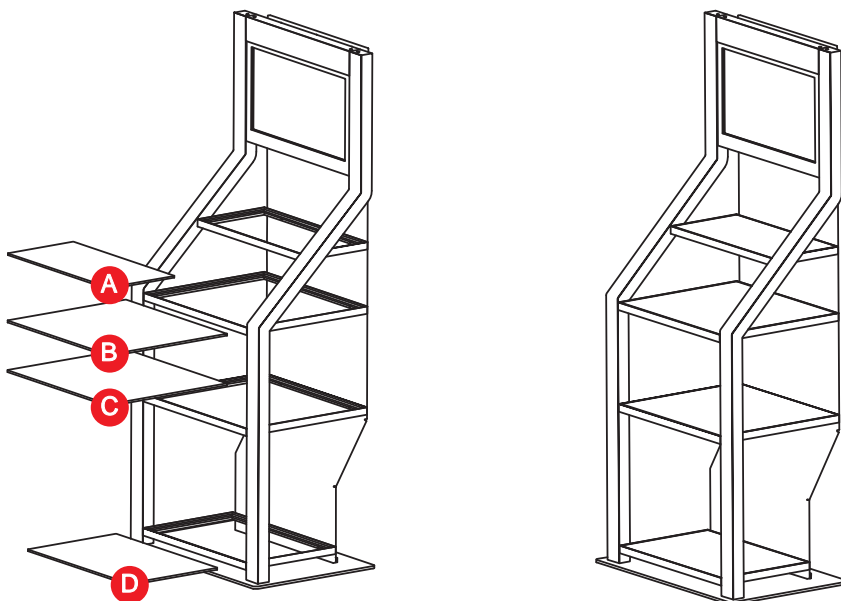

After fixing all shelf frames, place the counters onto the frames, and finishing the assembly.

## Remote Control

















### Installing batteries for the remote control:

Remove the battery cover and insert two AAA batteries (1.5V). Ensure that the battery polarity matches the "+" / "-" marks in the battery compartment of the remote control.

### Precautions for using the remote control:

- Aim the remote control at the receiver window. Do not place any object between the remote control and the receiver window to avoid interference with the normal operation.
- Keep the remote control away from violent vibration. In addition, do not set or place the remote control in direct sunlight, or else the remote control may be deformed by heat.
- The remote control may be invalid when the receiver window of the unit is in direct sunlight or strong lighting; in this case, please adjust the angle of the lighting or the unit or approach the receiver window to use it.
- The distance of remote control will be shortened if the battery voltage is insufficient; in this case, please replace with new batteries; if the remote control won't be used for a long time or the batteries are run out, please take out the batteries to avoid corrosion due to battery leakage, which will damage the remote control.
- Do not use batteries of different types or mix new batteries with old ones. Always replace the batteries in pairs.
- Do not put the batteries in fire, or charge or disassemble them, or charge, short circuit, disassemble, heat or burn used batteries. Please dispose of waste batteries in accordance with local environmental regulations. Do not expose the batteries in overheated environments such as sunlight and fire.

### Description of remote control buttons:

 Power switch	 Play programs; confirm selection
 To show the Source menu	 Display indication
 Mute	 Home page
 Turn down the volume	 Back
 Turn up the volume	 To show the main menu
 To move the cursor up	 To set up OSD menu
 To move the cursor left	 Input numbers
 To move the cursor right	
 To move the cursor down	

\*Other buttons are not defined temporarily

#### Note:

To call up the OSD menu, press the SETUP button in the system only. After press STOP button shows play mode, when enter play mode again will restart according to the schedule.





## Description of Basic Operation







### Power on/Standby

Insert the power plug into the outlet. If the Digital Signage has the switch button “I”, turn it on; if you press the switch button “O”, the Digital Signage enters standby state.

In power on state, enter “System Assistant” and press the “⏻” button on the remote control, and the Digital Signage enters standby state.

### About Launch Desktop

#### Description of Desktop Icons

Icon	Function
	Main applications
	Back
	Home page
	Background applications
	Sound -
	Sound +



## Description of Wallpaper Switch

As shown on the right, tap and hold in the blank space to enter wallpaper switch interface, and select the wallpaper from different sources.

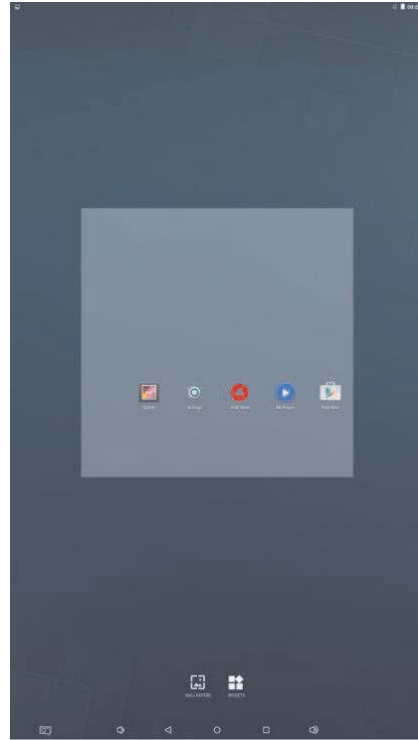

## File Manager

1. Click the Main Apps button “

Fig. 1

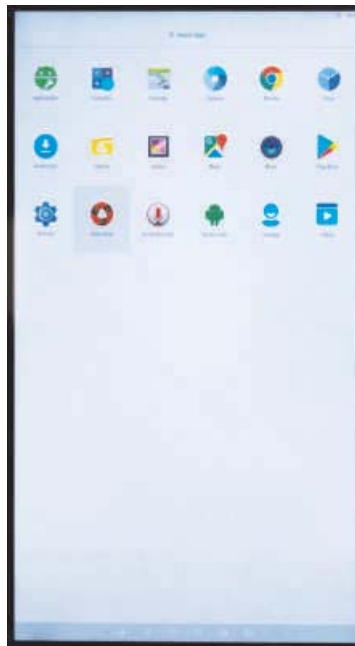

Fig. 2



Fig. 3

## Local Settings

1. Click the Main Apps button “
- 2. Click the “Settings” icon in the “APPS” menu interface (Fig. 2) and enter “Wi-Fi” menu (Fig. 3);
- 3. Click options in the “Wi-Fi” menu and set up different options.

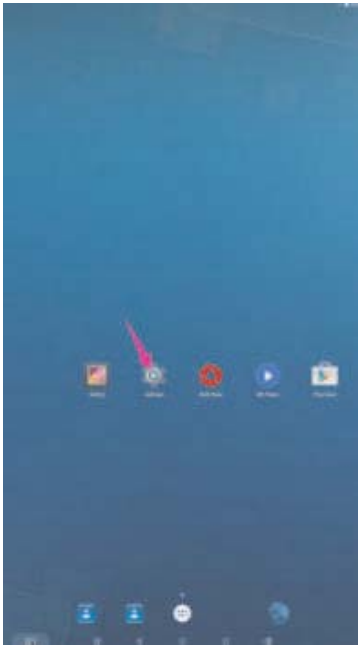

Fig. 1

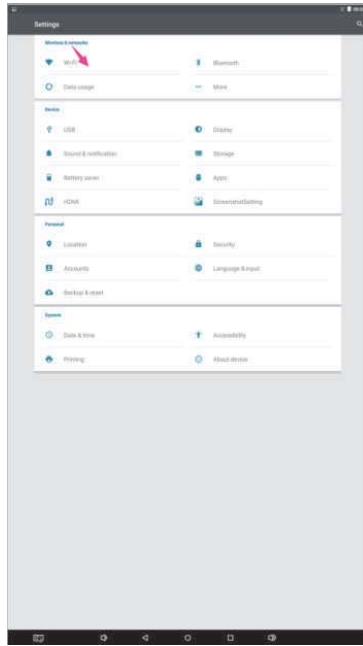





















Fig. 2



Fig. 3

### Description of Settings Interface (shown on the right)

Icon	Function
	WIFI switch
	Data usage
	Bluetooth
	USB
	Sound & notification
	Battery saver
	HDMI
	Display
	Storage
	Apps
	Screenshot Setting
	Location
	Accounts
	Backup & reset
	Security
	Language & input
	Date & time
	Printing
	Accessibility
	About device

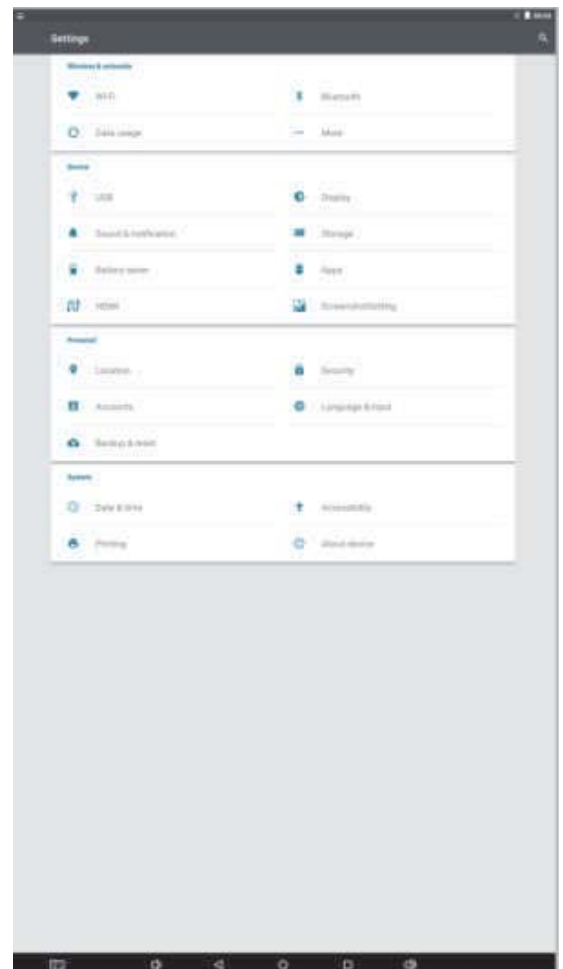



Step 2: Go to the USB storage menu click the USB storage button



Step 3: At the USB storage menu select Multi and then highlight the media files which you want to copy to the media folder. Click the Editor button, the pop menu will show then click the Copy

